



## DCR600-20

## DC Output Module

6,000W  
0-600 Vdc / 0-20A dc

Three Phase AC Input  
Requires AMX AC Power Source



### Standard Features:

- Wide Useable Range  
*Up to 600Vdc Voltage and 20A dc Current Output*
- Three Phase AC Input  
*Requires Programmable AC Power Source with Square Wave Capability*
- Adds DC capability to AC Power Source  
*DC Output Voltage Derived from Provided AC RMS Input Voltage*
- Program DC Transients Using UPC Controller Functions  
*Run Dynamic Voltage Tests on DC Powered Equipment*
- Dual Banana Jacks Provided on Front and Rear Panel  
*Easy Connection of DMM or Scope to Monitor DC Output Voltage*
- Circuit Breaker on Front Panel  
*Quick AC Input Power Disconnect Removes DCR Unit from AC Source Output*
- 19" Rack Mount Enclosure with Removable Rack Ears  
*Fits easily on Lab Bench, on Top of the AC Power Source Used or in Instrument Cabinet*

### Available Options:

- UPC Studio Software Suite (available at no cost)
- UPC Test Manager

### UPC Manager Software Suite *Master the Power of the Wave!*

UPC Manager Software gives you the tools necessary to quickly and easily operate your DC output unit through the AC Power Source. This Windows software supports controls over all areas of your Power control all areas of your Power Source testing with simple presets, user prompts, test sequences, test plans and custom reports

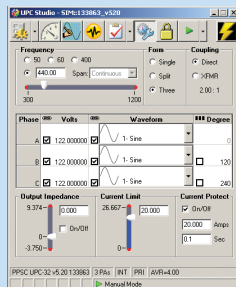

### DCR600-20 DC Output Module

The DCR600-20 is a unique approach to generating programmable DC voltages to test DC powered equipment using a Pacific Power Source AMX Series AC Power Source. The DCR600-20 connects between the AC Power Source outputs terminals and the UUT and rectifies the programmed AC output voltage into a stable DC voltage.

Pacific Power's AMX and ASX-Series high performance Linear AC Power Sources offer low output voltage noise and distortion, ease of installation, and high AC waveform fidelity that is used to produce the required DC output voltage.

### DC Test Capability From an AC Power Source

Leverage your existing investment in your AC Power Source by using it not only for AC product development and test but for DC power products as well. The same programmable features and function available on the AC Power Source can be applied to an AC derived DC output. DC voltage is twice that of the AC Line to Neutral voltage so scaling from AC to DC is easy.

### Simple Connection, Quiet Operation

The DCR unit is placed between the AC Power Source output and the DC load under test. For best results, a three phase AC Power Source is recommended. No other equipment is needed to provide DC power. A set of banana jacks is provided on the DCR unit to connect a DMM which can be used to monitor the DC output voltage. No DC bias supply is needed to operate the DCR unit and only convection cooling is needed to cool the unit so no fan noise is present.

### DC Test Sequence Programming

By programming the required AC voltage output sequence on the AC Power Source, sophisticated test sequences can easily be applied to a DC unit under test.

### The Leader in AC Power Technology now offers DC

An early pioneer in the development solid-state power conversion equipment, Pacific Power Source continues to develop, manufacture, and market both linear and high-performance PWM AC Power Sources. Pacific's reputation as a market and technology leader is best demonstrated by its continuing investments in both research and development and world-wide customer support. With corporate owned offices in the United States, Germany, the United Kingdom, and China, local personalized support is always available.

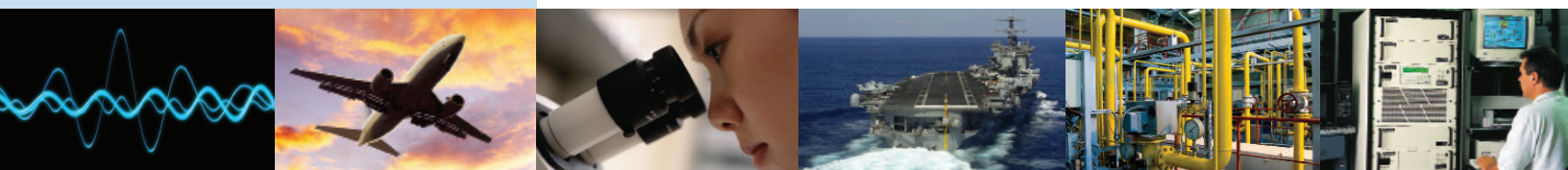

**Specifications: DC Output**

**DC Output**

	Parameter	Specification	Unit	Conditions
Voltage	DC	600	Vdc	Maximum allowable DC Output Voltage
	Accuracy	±0.5	% Range	See Note 1
	Rise Time	< 2.0	msec	0-100% voltage change @ 10-90% amplitude at 300V/20A load
		< 4.0	msec	0-100% voltage change @ 10-90% amplitude at 600V/ 10A load
	Fall Time	< 15.0	msec	100-0% voltage change @ 90-10% amplitude at 300V/20A load
		< 40.0	msec	100-0% voltage change @ 90-10% amplitude at 600/10A load
	DC Ripple RMS	< 750	mV RMS	See Note 2
DC Ripple pk-pk	< 4.0	V peak-peak	See Note 2	
Load Regulation	< 0.5	% of full range	With CSC on and UPC32 and external sense at DCR input. AMX in Direct coupled mode on 135Vac range	
	< 1.0	% of full range	With CSC on and UPC32 and external sense at DCR input. AMX in Transformer coupled mode on 270Vac range	
Current	Max.	20	Adc	Maximum supported DC Output Current
	Current Limit	-		Determined by AC Power Source Programmable Current limit setting.
Power	Max.	6000	Watts	See voltage and current rating chart below
Other	Output Capacitance	470	µF	
Controls	DC Output	None		NOTE: No DC Output disconnect is provided. A contactor or disconnect switch may be added between DC terminal block and UUT if desired

NOTES:

1. Applies under nominal load with transfer function  $V_{ac} = (V_{dc} + 1.4) / 2.02$  where  $V_{dc}$  is the desired DC output voltage and  $V_{ac}$  is the programmed AC voltage.
2. Specifications shown apply when using AMX AC Power Source model in three phase output mode (FORM3) and standard square wave output waveform at 400Hz fundamental.

**Input Power Requirements**

**AC Input**

	Parameter	Specification	Unit	Conditions
Voltage	VAC RMS (L-N)	0-300	Vac RMS	Maximum allowable AC RMS Input Voltage.
	VAC Peak (L-N)	300	Vpeak	Maximum allowable AC Peak Input Voltage
	FORM	3	3 Phase + Neutral	See Note 3
	Waveform	Square Wave		Recommended AC Source Output Setting
	Frequency	400	Hz	Recommended AC Source Output Setting
Current	Max.	30	A/phase	Input Circuit Breaker Protection
Power	Max.	6000	Watts	See voltage and current rating chart below
Controls	AC Input Breaker	3 Pole, 30 Arms		Front Panel mounted
Terminals	AC Input	Rear Panel	Terminal Block	3 Wires + Ground.
	Input Safety Cover	Included		Protects against accidental touching of AC input

NOTES:

3. DCR600 Unit is operable with single phase AC input but AC to DC Scaling will be lower and Ripple higher. For best performance, three phase AC input is recommended. All data shown is for three phase AC input.

## DC Output Power Rating Curve

### Rated Continuous Load Current as a Function of Output Voltage

Chart shown assumes AC Power Source model used is capable of supplying the required AC current as demanded by the DC load on DCR output at the programmed voltage. Check relevant Pacific Power Source AC Model data sheet for AC voltage and current rating charts.

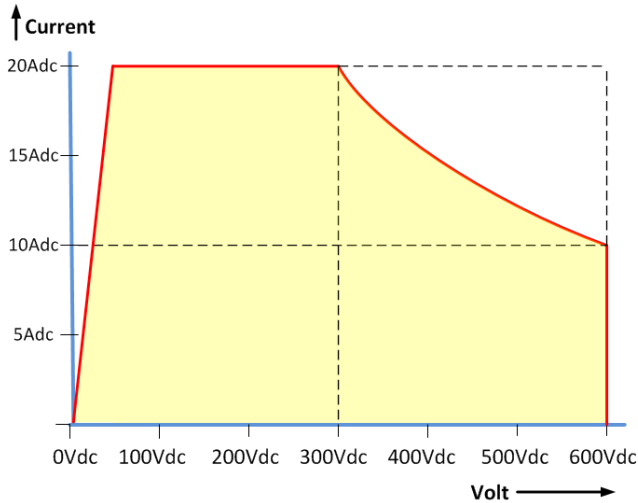

MODEL	VA	Vrange Coupling	Vmax LN	Vset (AC)	Available Arms /Phs @ Vset	Vdc	DC Curr. (A)	Power
305AMXT	500	Direct	135	125	1.50	250	2.2	551
		1.5:1	202	187	1.00	375	1.5	550
		2.0:1	270	250	0.75	502	1.1	551
		2.5:1	338	299	0.60	600	0.9	527
308AMXT	750	Direct	135	125	2.00	250	2.9	735
		1.5:1	202	187	1.30	375	1.9	715
		2.0:1	270	250	1.00	502	1.5	735
		2.5:1	338	299	0.80	600	1.2	703
320AMXT	2000	Direct	135	125	6.00	250	8.8	2205
		1.5:1	202	187	4.00	375	5.9	2200
		2.0:1	270	250	3.00	502	4.4	2205
		2.5:1	338	299	2.40	600	3.5	2110
345AMXT	4500	Direct	135	125	12.00	250	17.6	4410
		1.5:1	202	187	8.00	375	11.7	4399
		2.0:1	270	250	6.00	502	8.8	4410
		2.5:1	338	299	4.8	600	7.0	4219
360AMXT	6000	Direct	135	125	13.6	250	20.0	4998
		1.5:1	202	187	10.70	375	15.7	5884
		2.0:1	270	250	8.00	502	11.7	5880
		2.5:1	338	299	6.40	600	9.4	5626

All Data shown for 3 Phase Mode (FORM3)

## Avionics DC Test Software Options

Owners of the DCR option may use the growing library of Avionics Compliance Test Sequence Software to perform DC Power Group testing at either 28Vdc, 135Vdc or 270Vdc. The DC Test Sequence are included in the Avionics Test Options available from Pacific Power Source for use with its UPC Studio Test Manager Windows Software. The table below shows currently supported test standards. Contact Pacific Power Source to check on availability of DC test sequences.

Manufacturer / Organization	Test Standard	Airframe	Revision	PPS Part Number
Airbus Industries, Europe	ABD0100.1.8	A380	E	149102
Airbus Industries, Europe	ABD0100.1.8.1	A350	C	149125
Boeing, USA	787B3	787 Dreamliner	C	149126
Radio Technical Commission for Aeronautics (RTCA)	DO160, Section 16	Commercial Aviation	G	149124
US Department of Defense (DoD)	MIL-STD-704	Military Aviation	F	149101

### Principle of Operation

The DCR600-20 uses a three phase diode bridge to rectify the AC input voltage to a single DC rail. By using the square wave capability of the AMX Series AC Power Sources, low voltage ripple can be accomplished with only minimal bulk DC storage capacitance at the output. This results in faster DC slew rates compared to a typical 6KW DC Power Supply. No modifications are needed to the AC Power Source to use the DCR unit as it is fully self-contained. If the DCR unit is placed away from the AC Power Source used to drive its input, it is recommended to use the external voltage sense capability of the AC Power Source to minimize line losses<sup>1</sup>.

A block diagram of the DCR unit is shown in the figure below for reference.

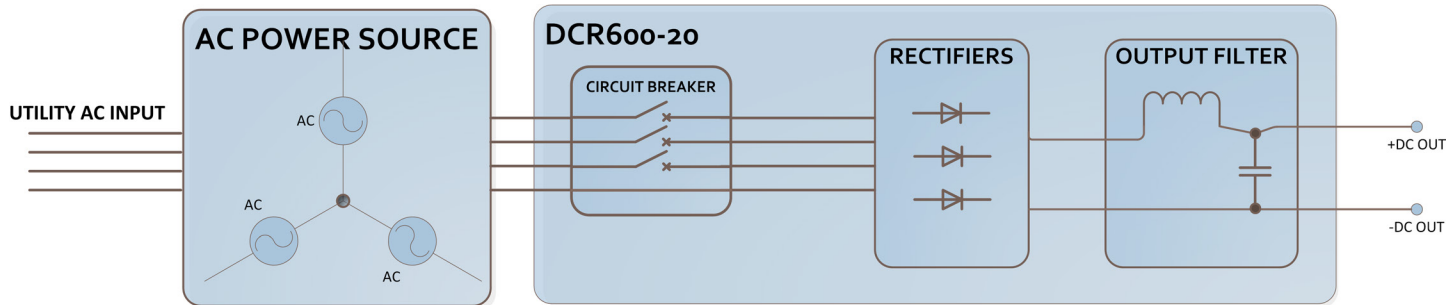

### Applications

The DCR is most practical for higher Voltage DC applications (100Vdc to 600Vdc) as these ranges are a better fit for the 135V or 270VAC voltage ranges of the AC power source. Lower voltage settings will generally provide only little DC output power as the AC Power Source does not deliver higher current at lower voltages. Check the Voltage and Current rating chart of the AC Power Source model you plan to use to drive the AC input side of the DCR unit.

Applications for DC testing are numerous and only a handful of typical examples are listed here.

- LED Lighting
- Power Conversion, Power Factor Correction
- DC Motors and Actuators
- DC Power Distribution in Avionics

### DC Output Samples

The waveform capture screens shown below represent typical DC output voltages resulting from using the DCR600-20 with a 345AMX AC Power Source. All data is taken using the recommended AC output parameters of 400Hz, Square wave and FORM3 AC output mode.

### AC Input and DC Output Waveforms

This scope screen image shows three phase square wave from and the resulting DC Voltage and Current waveforms into the load.

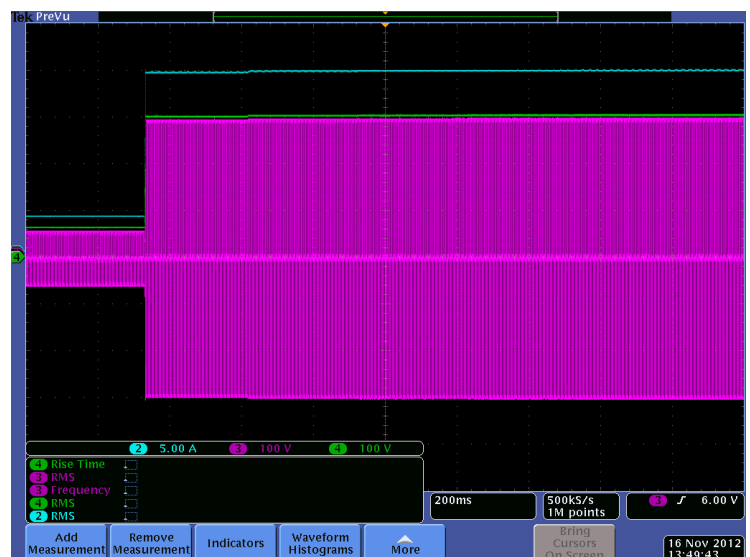

<sup>1</sup>Note: No External DC Voltage Sense capability is provided so the distance between the DC load and the DCR unit should be kept to a minimum with sufficiently sized load wire gauge.

### Programmed DC Voltage Ramp

This scope screen image shows the DV voltage ramping from 0Vdc to 270Vdc using a slew rate of 54Vdc/sec over a 5 second period.

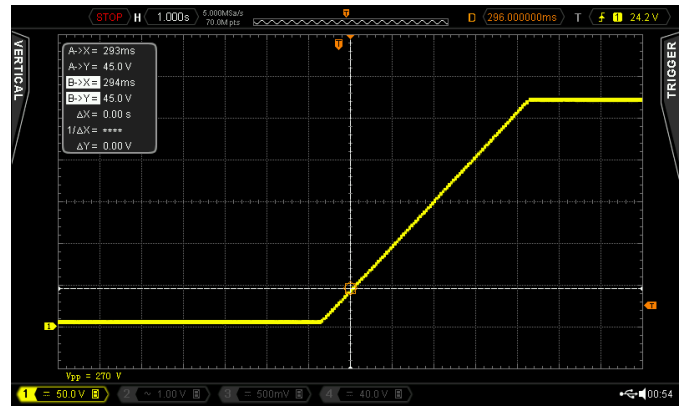

### Programmed DC Voltage Dip

This scope screen image shows the result of a programmed DC voltage drop to 0Vdc for 100 msec under light load conditions. The downward slope is caused by the RC constant of the DCR600 output capacitance.

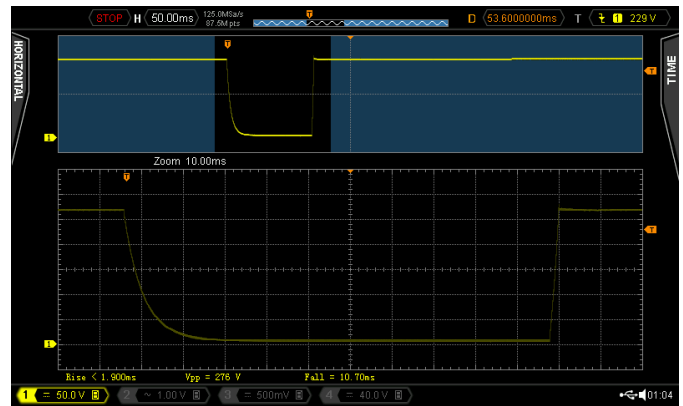

### Typical Peak to Peak Voltage Ripple

This scope screen image shows a magnified vertical view of the DC output voltage which illustrates the relatively low Vdc peak to peak ripple present on the output.

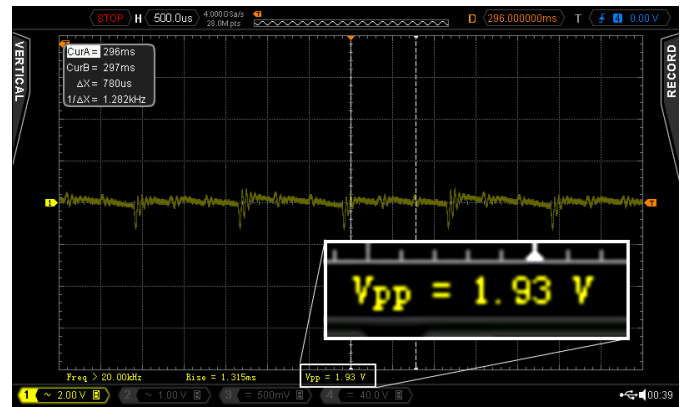

### Indirect Control of DC Power- Simple, Intuitive Operation

The UPC Controller part of the AMX Series of Programmable AC Power Sources. When used with the DCR unit, AC voltage amplitudes are scaled to a DC voltage output. The scaling factor depends on the number of AC output phases (1 or 3) and the shape of the AC waveform selected.

For best results, a three phase output and Square waveform is recommended.

Using the front panel keyboard and display, all controller models provide for selection of power source output mode, coupling, voltage, and frequency.

Both the UPC-1 and UPC-32 Controllers are available with either RS-232 or GPIB remote interface. Commands are structured in accordance with SCPI (Standard Commands for Programmable Instruments).

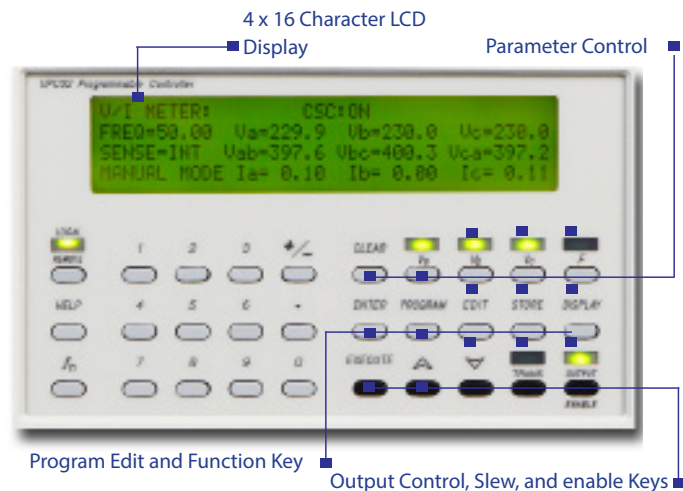

4 x 16 Character LCD

Display

Parameter Control

Program Edit and Function Key

Output Control, Slew, and enable Keys



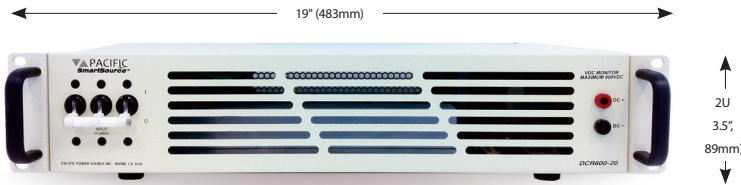

DCR600-20 DC Output Module

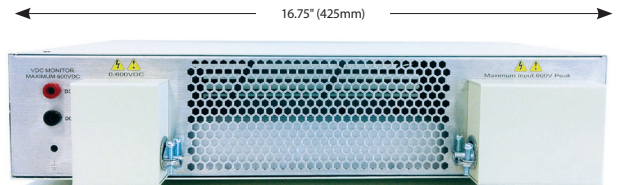

### General/Environmental

Ambient Temperature	Operating: 0° - 50° C Storage: -20° - 80° C
---------------------	--

### Protection and Safety

On / Off Circuit Breaker	Use AC Breaker to Disconnect DC Rectifier from AC Source Output.	
Isolation	Output to chassis	1200 Vdc / 1600 Vac
	Input to chassis	1350 Vac
Output Bleeder	Bleed Resistor	Internal, 50KOhm Across DC Output, Heat Sink Mounted.

### Regulatory Compliance

Safety	IEC61010
EMC	IEC61326
Marking	CE Approval Pending

### Options

Hardware	RMS	Rack Mount Slide Kit.
	Software	UPC Manager
Software	UPC Test Manager	Comprehensive Test Planner and Test Sequence Management Software. Requires UPC Manager program.
	DC Test Options	Mil-Std704, RTCA/DO160 ,Airbus, Boeing

### Mechanical Specifications

Chassis	Type	19" Rack Width	2U Rack Mount
Dimension (W x H x D)	16.75" x 3.5" x 9.6" 425 x 89 x 245 mm		
	Width includes Rack Ears: 19" / 483 mm Depth includes Safety Covers: 11.5" / 292 mm		
Cabinet Mount	Removable Rack Ears. Requires L Brackets or Slides. Rack Slide Mounting Holes on Side of Chassis. Contact Customer Service for Rack Slide option.		
Terminals	Input	5 Pole Terminal Compression Block	Phase A, B, C, Neutral Chassis Ground
	Output	3 Pole Terminal Block	Rated to 600Vdc, 85Adc. DC Pos, DC Neg.
	Ground Connection	AC Input Terminal Block & Ground stud on Rear Panel	Ground Stud near DC output terminal to allow ground EUT as needed
Cooling	Convection		
Front Panel Controls / Indicators	On/Off switch	Circuit Breaker	Use AC breaker to disconnect DC Rectifier output from AC Source Output.
	Banana Jacks	Dual Safety type, 4mm, Sheathed Female 19 mm Spacing Red for +DC Black for -DC	
Rear Panel Connections / Indicators	Terminal Blocks	AC Input Connections, 4 Wire + Ground DC Output Connections	
	Safety Covers Provided	AC Input Terminal Block DC Output Terminal Block	
	Banana Jacks	Dual Safety type, 4mm, Sheathed Female. 19 mm Spacing. Red for +DC Black for -DC	

### Ordering Information

Model	Controller	Requirements
<input type="checkbox"/> DRC600-20	<input type="checkbox"/> N/A	<input type="checkbox"/> Requires AMX Series Programmable AC Power Source

### Available Models

DCR600-20

### Order Example

- DRC600-20
- DC Rectifier Chassis

### Typical Delivery Items

- Ship Kit:
- User Manual on CD ROM
  - Input and Output Safety Covers