

AVI3000 - calibration and test setups

A revolution in the field of indirect lightning tests

- ✓ Pin Injection (PIN):
[WF 3 \(1 MHz\)](#), [WF 4](#), [WF 5A](#)
- ✓ Cable Induction (CI):
[WF 1](#), [WF 2](#), [WF 3 \(1 MHz\)](#), [WF 3 \(10 MHz\)](#), [WF 4](#), [WF 5A](#), [WF 6](#)
- ✓ Ground Injection (GI):
[WF 4](#), [WF 5A](#)

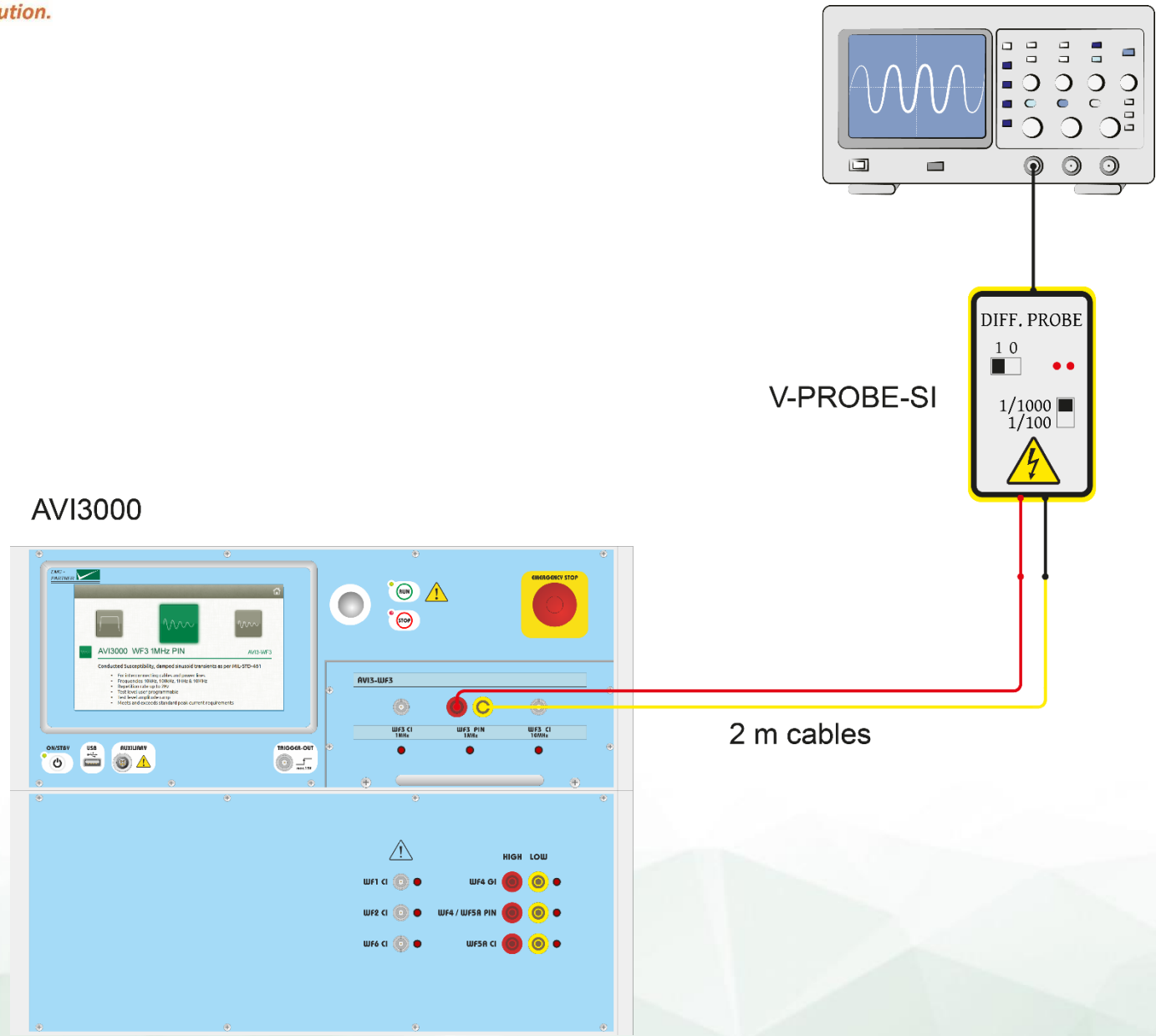

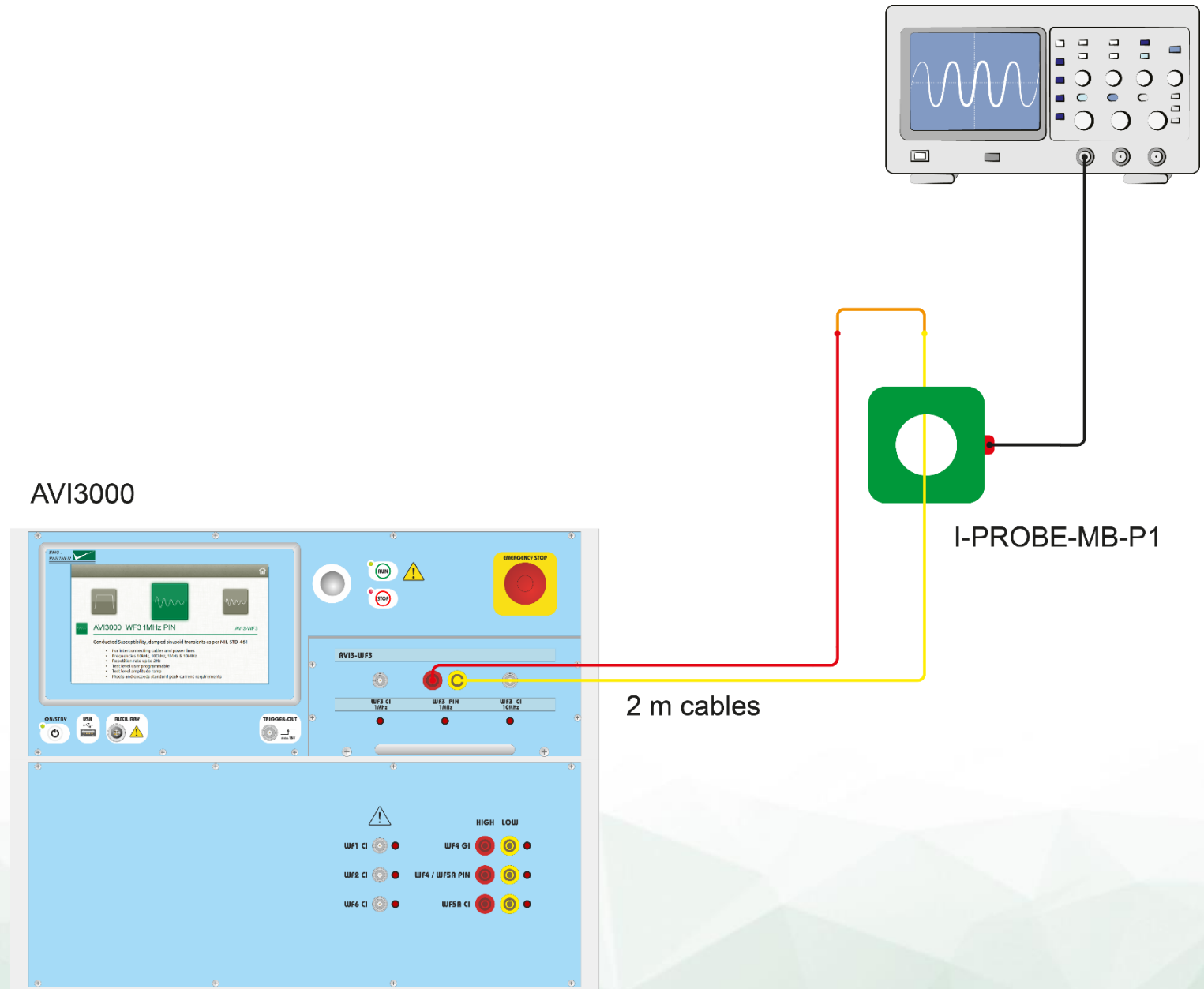

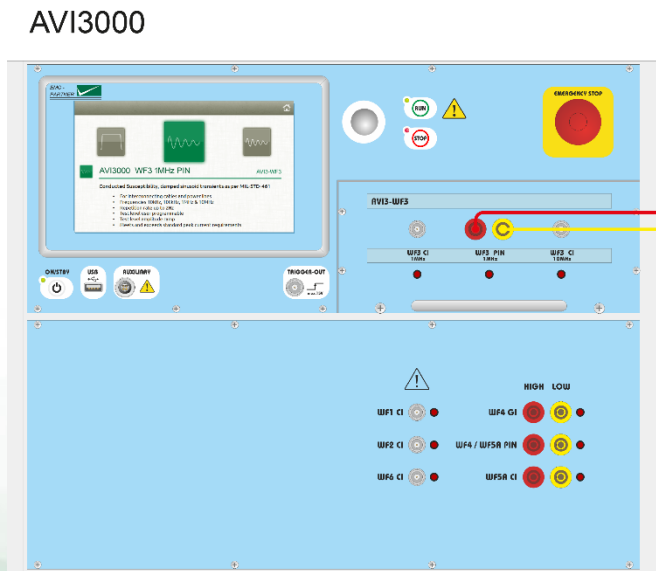

2 m cables

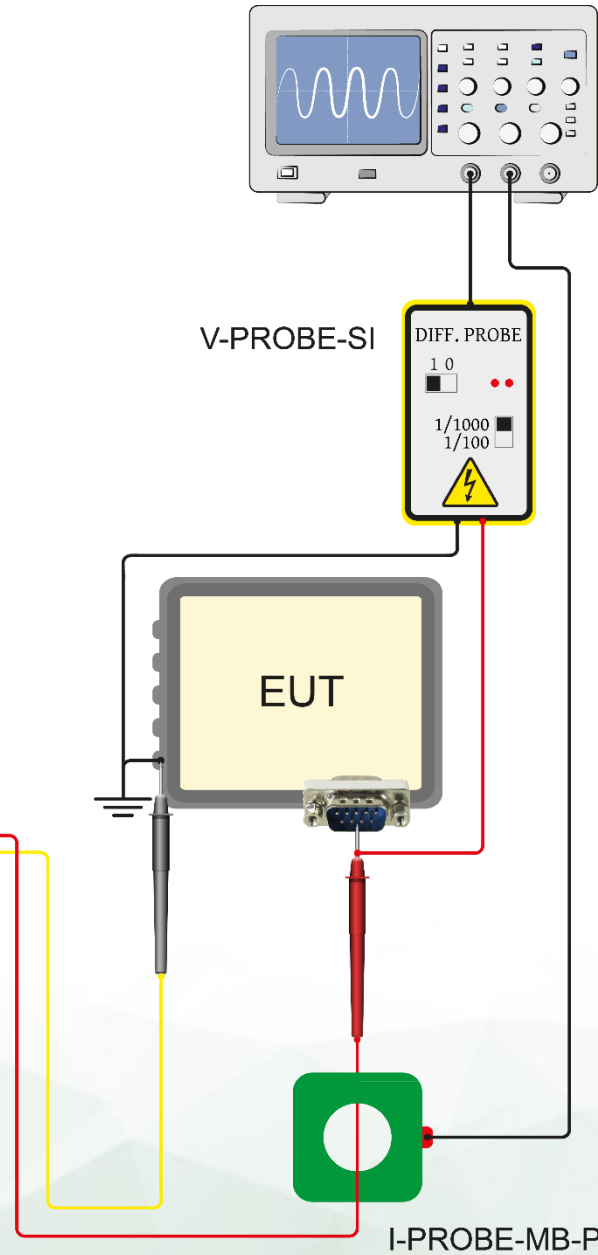

AVI3000

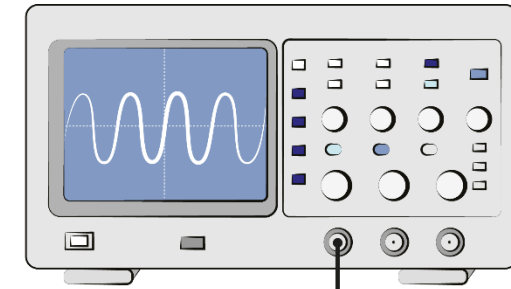
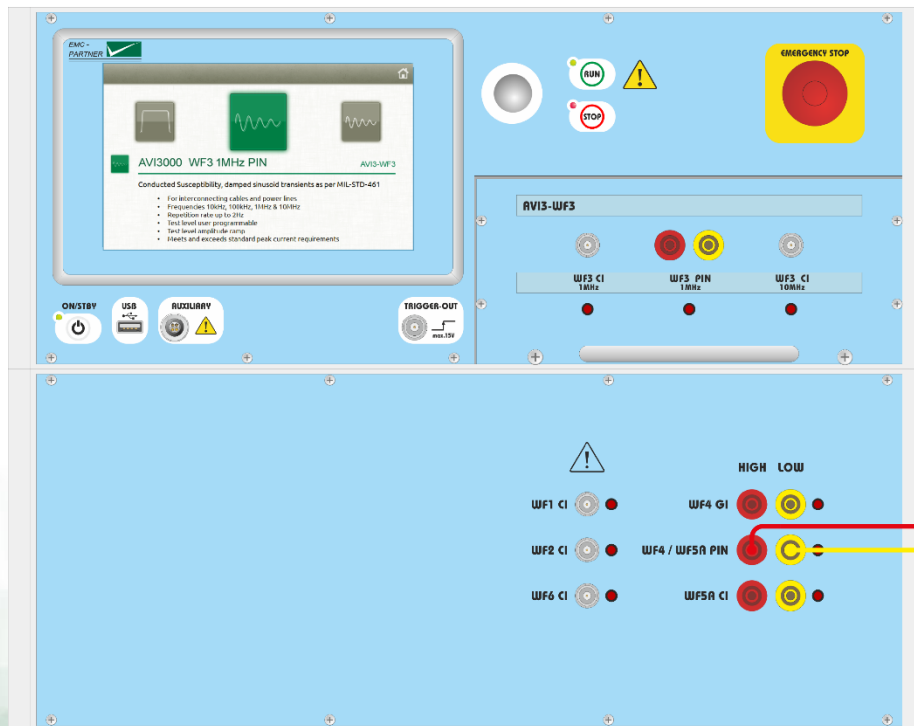

V-PROBE-SI

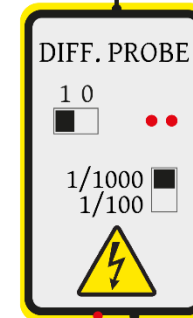

2 m cables

Attenuator 20 dB between probe and DSO

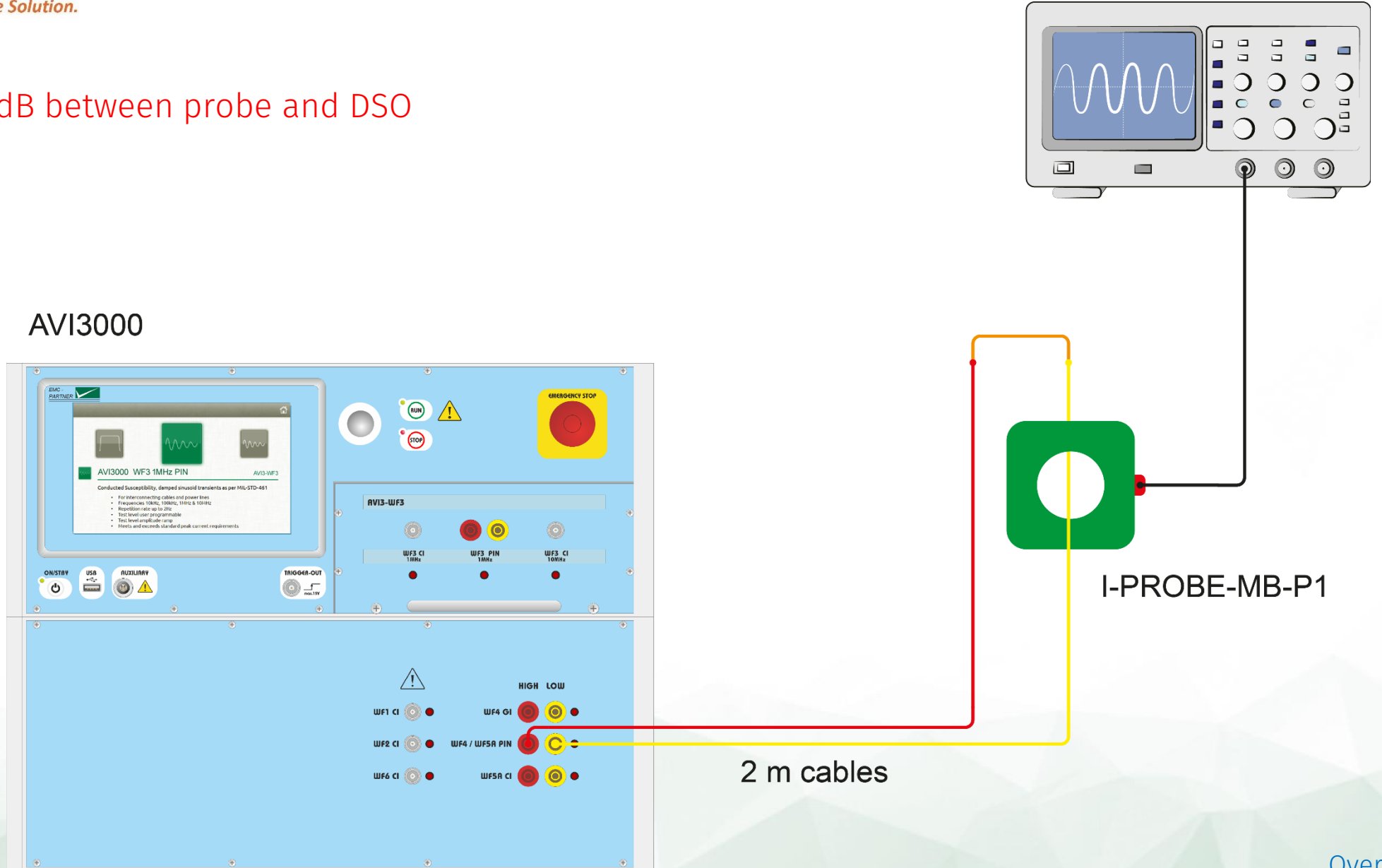

AVI3000

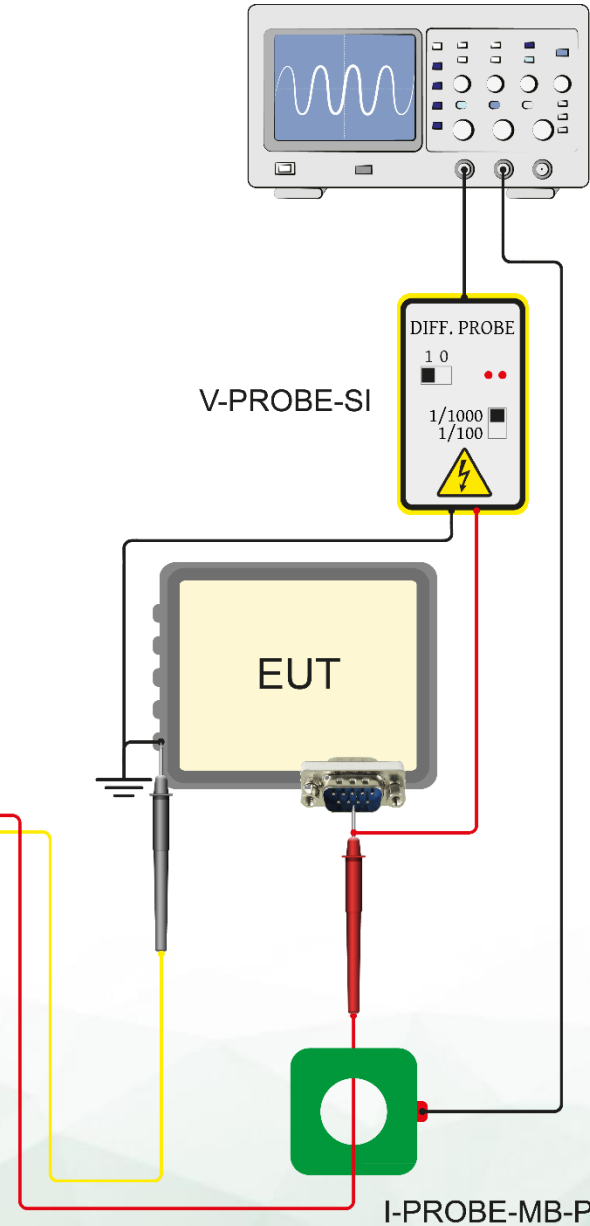
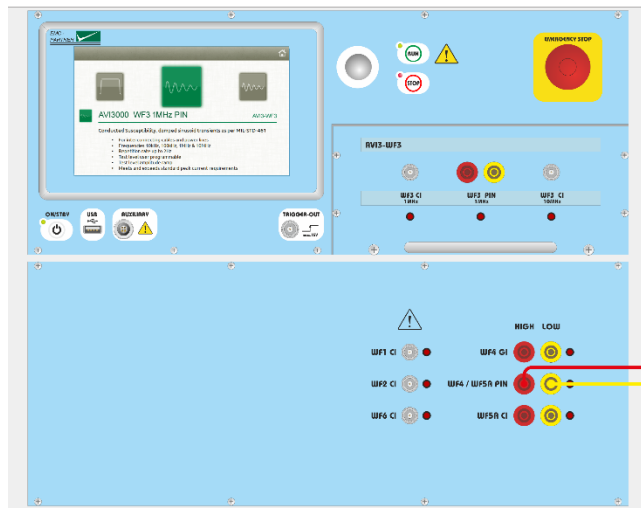

2 m cables

I-PROBE-MB-P1

AVI3000

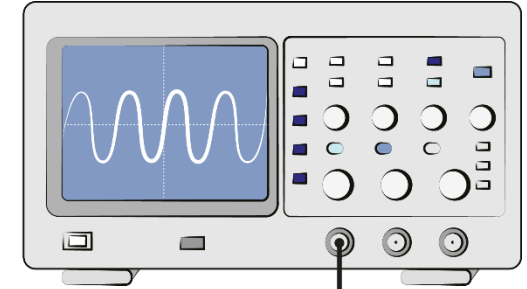
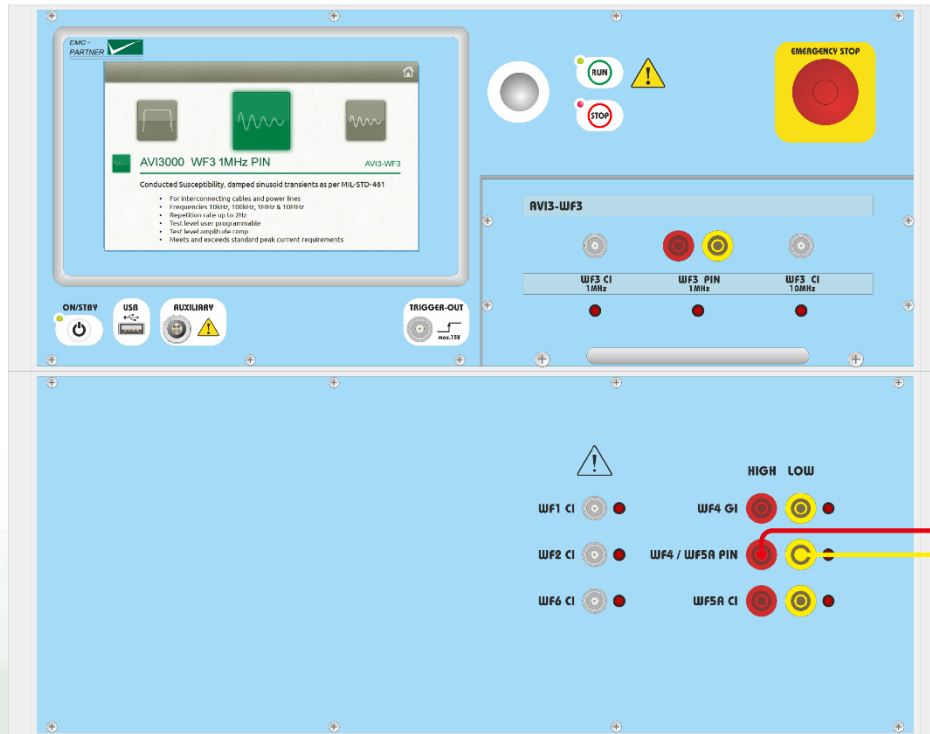

V-PROBE-SI

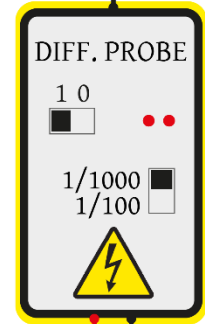

2 m cables

AVI3000

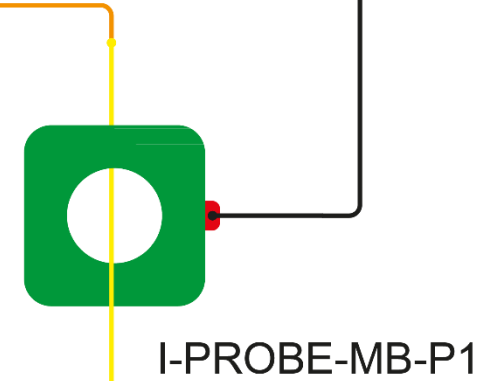
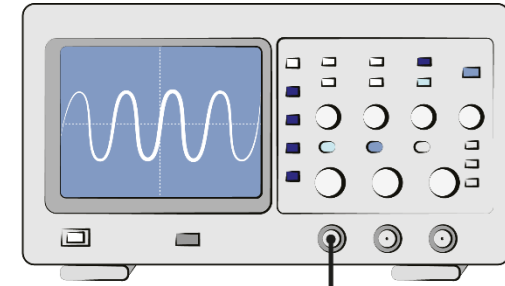
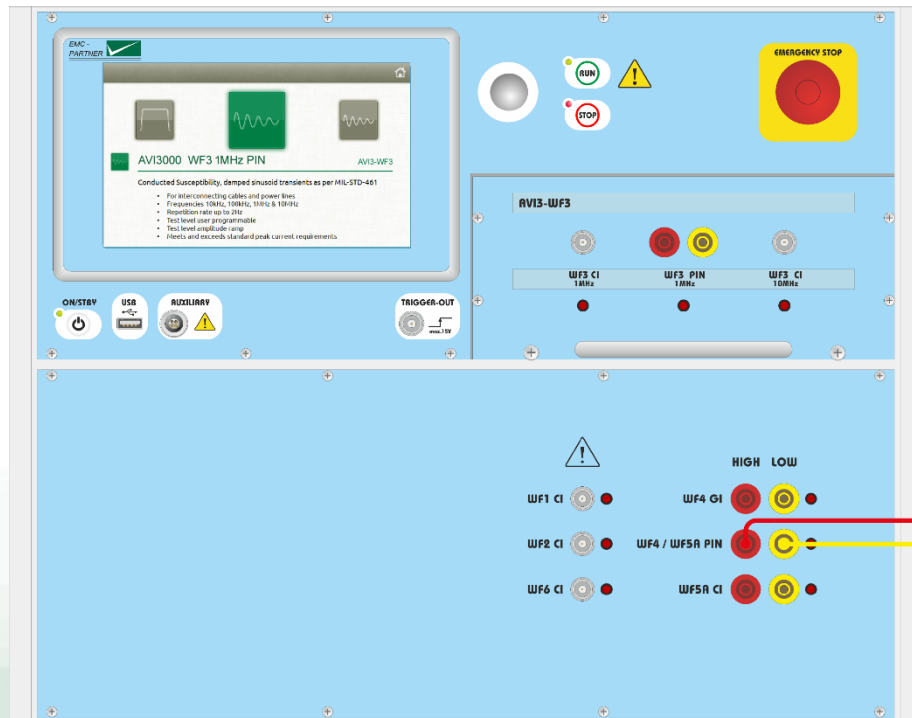

2 m cables

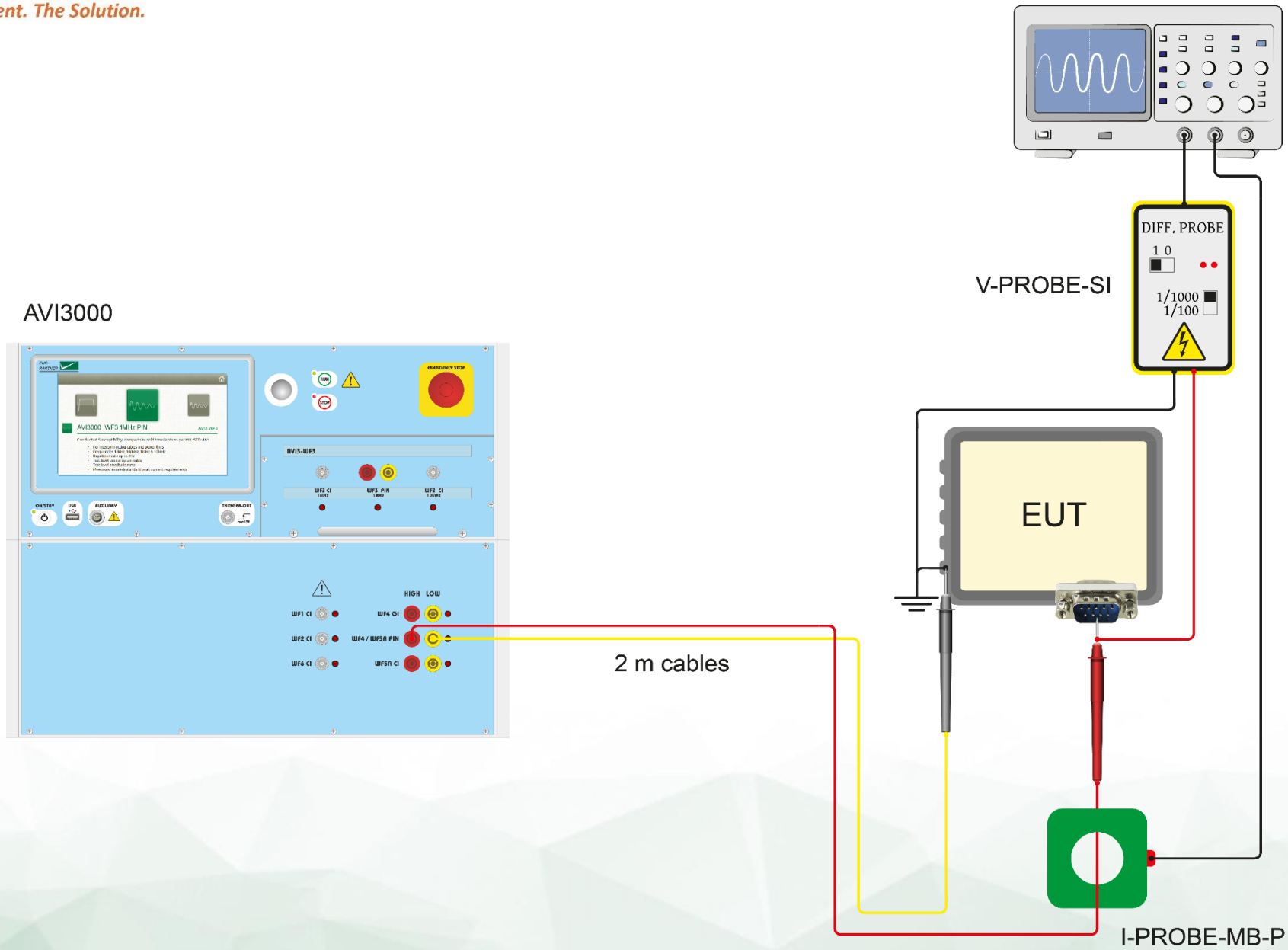

AVI3000

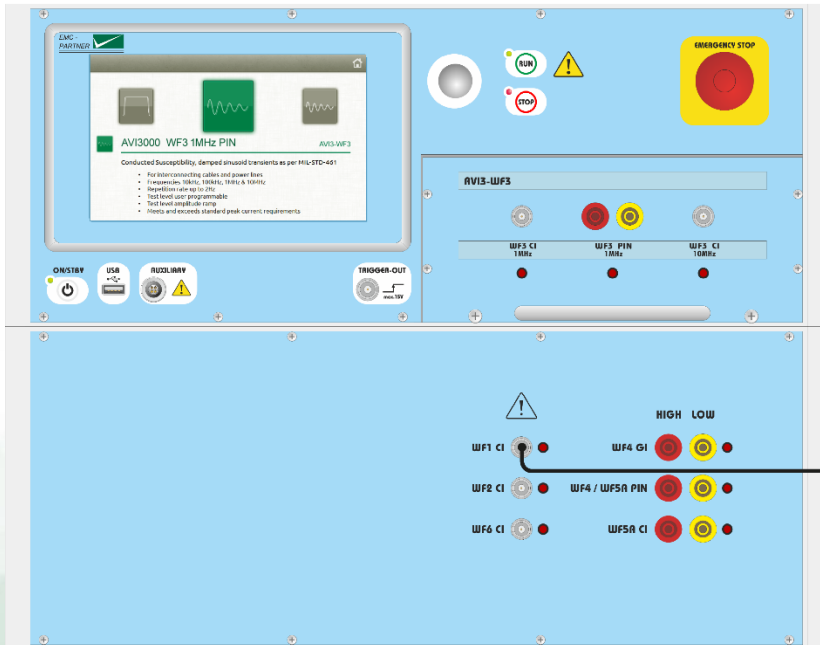

CN-BT7

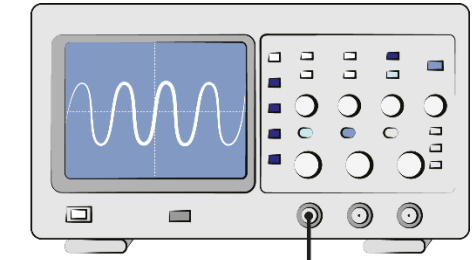
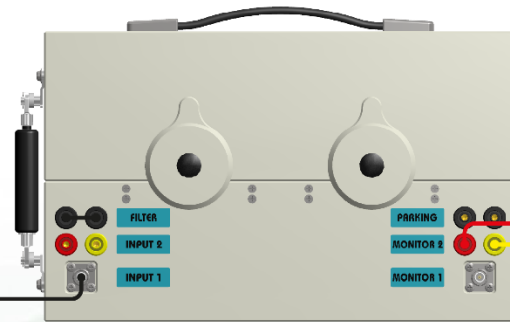

I-PROBE-MB-P1

AVI3000

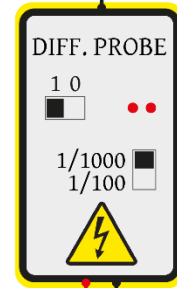
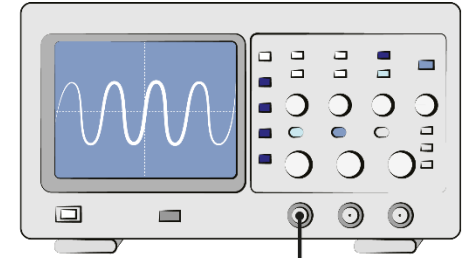
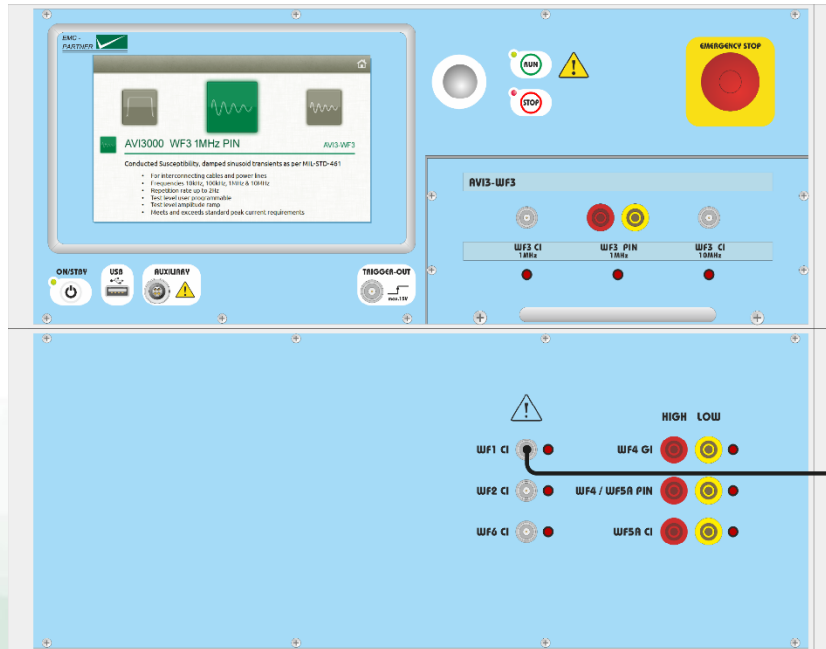

V-PROBE-SI

CN-BT7

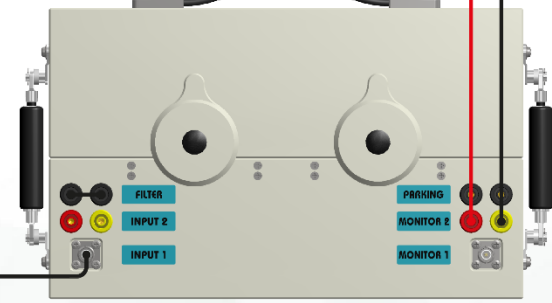

AVI3000

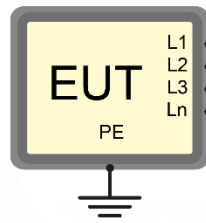
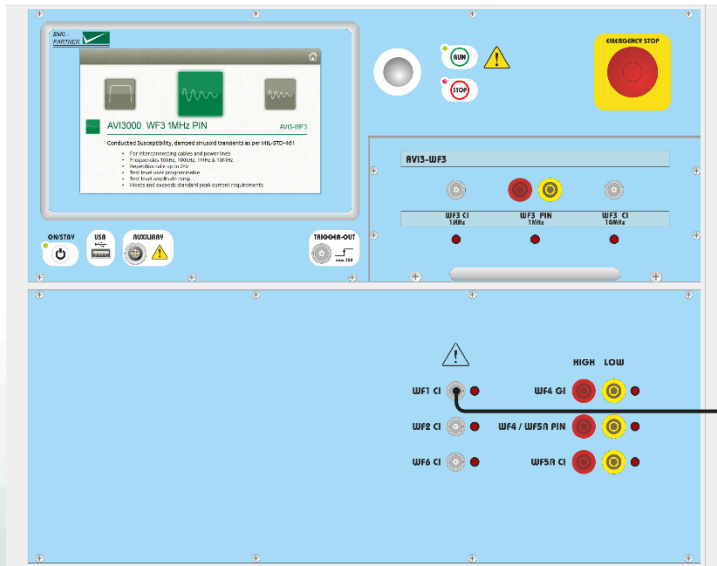

I-PROBE-MB-P1



CN-BT7

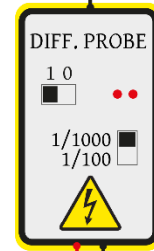
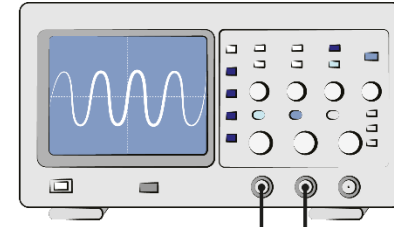
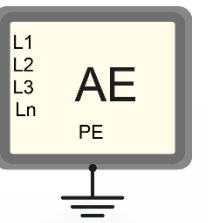
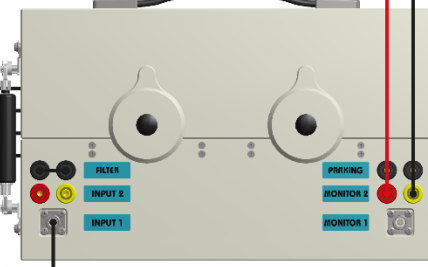

V-PROBE-SI

AVI3000

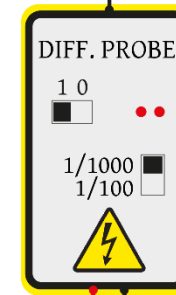
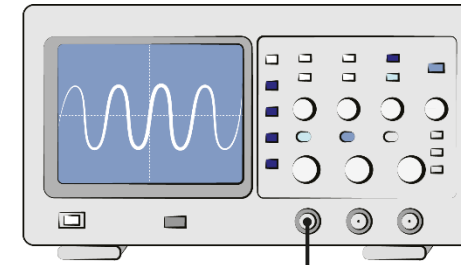
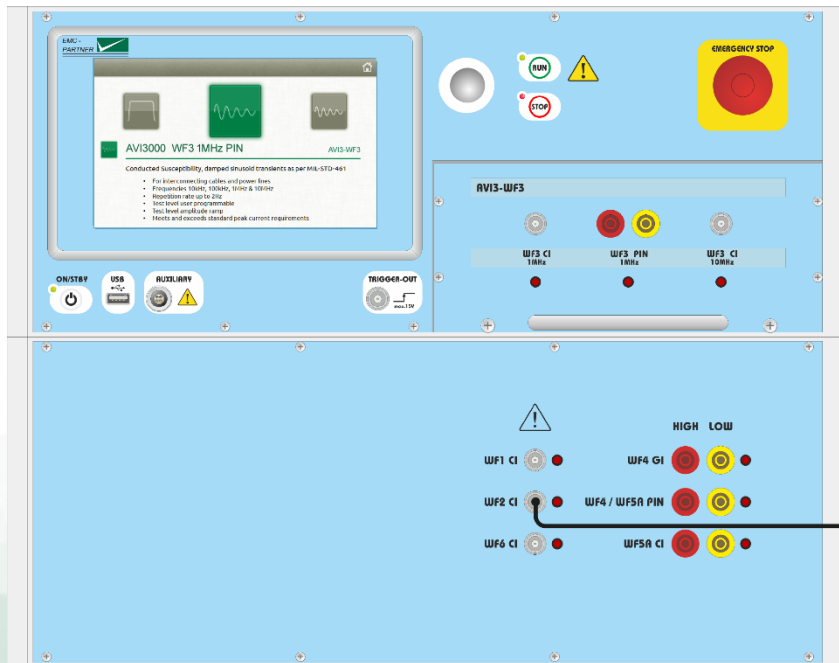

V-PROBE-SI

CN-BT7

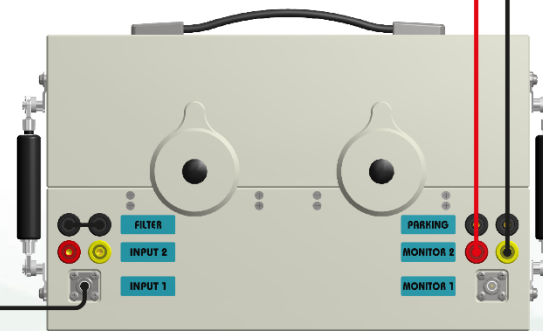

AVI3000

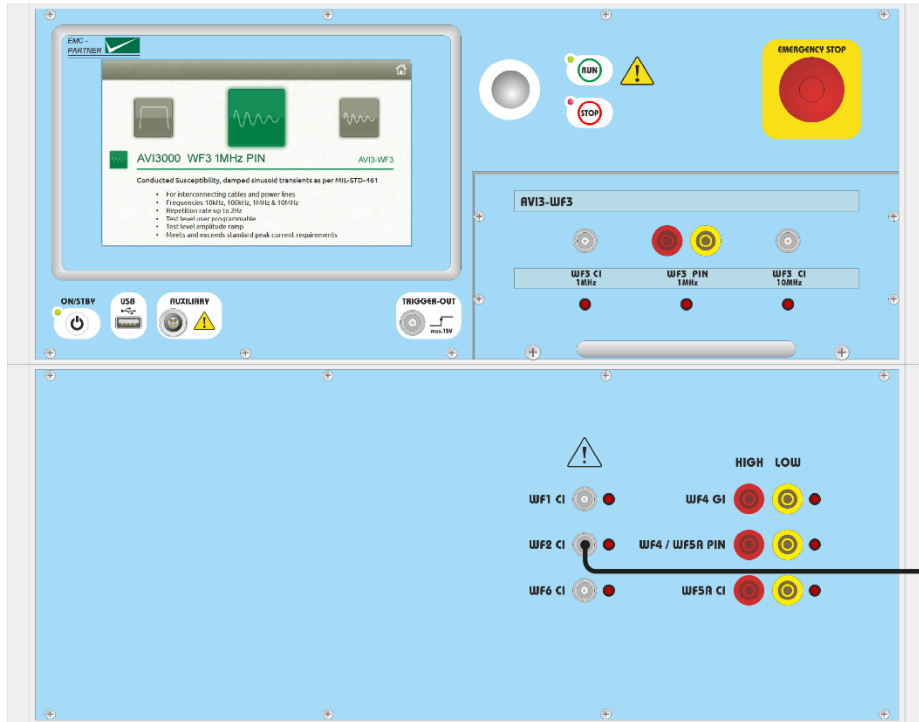

CN-BT7

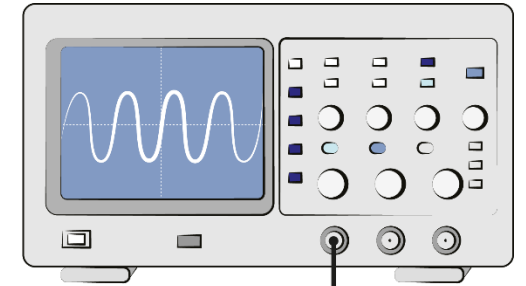
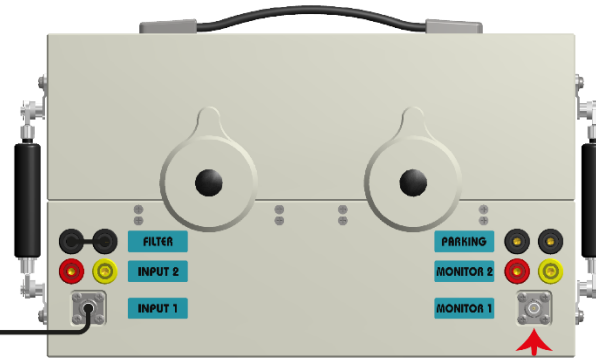

SHUNT0E1



AVI3000

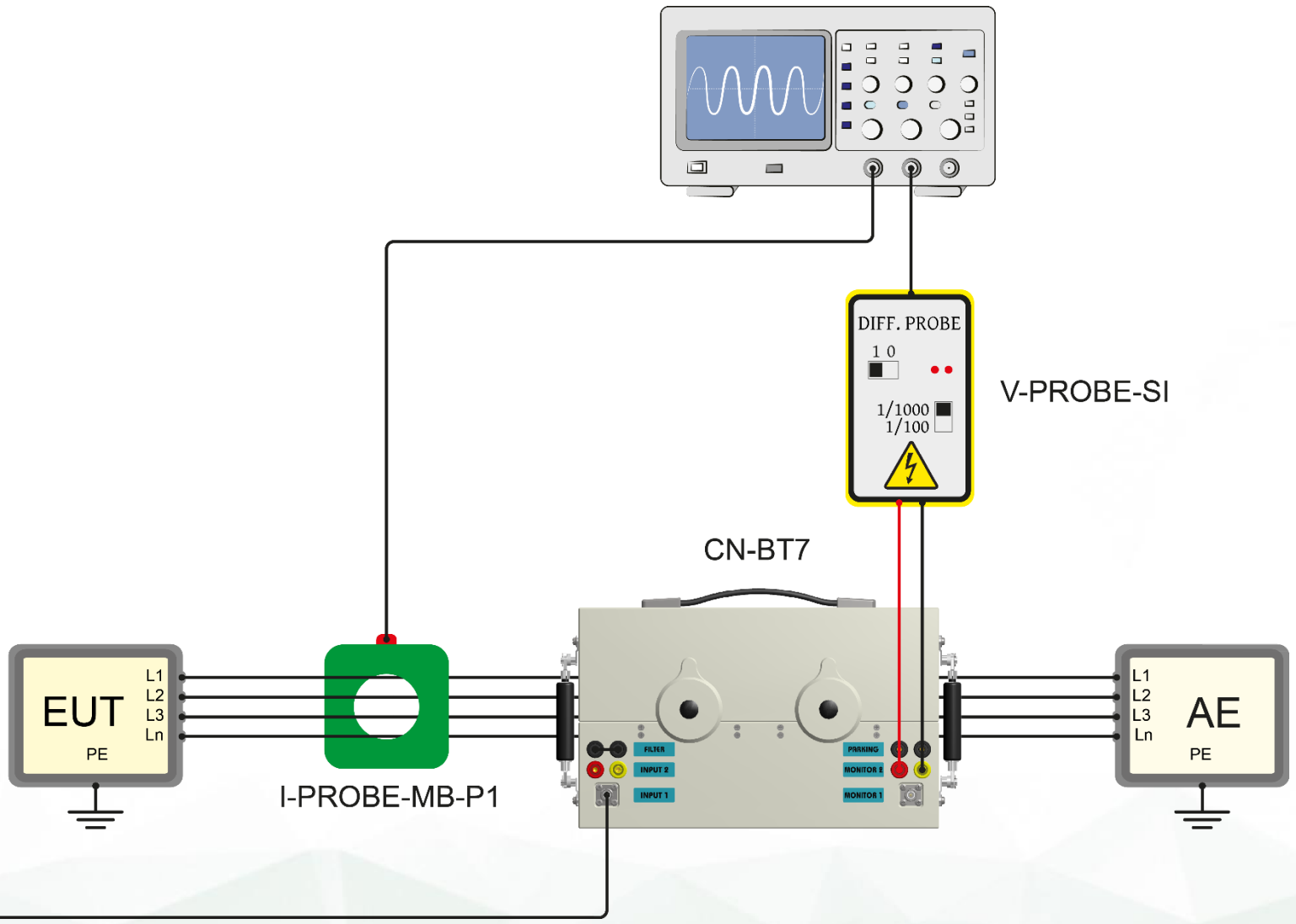
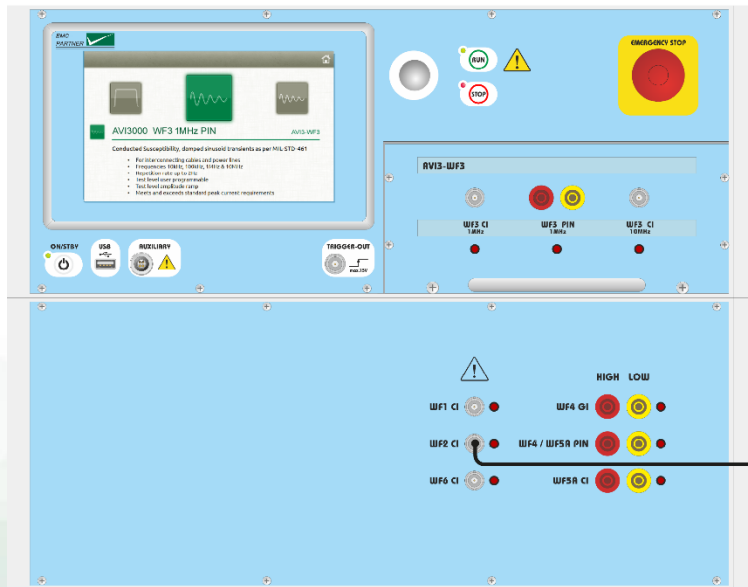

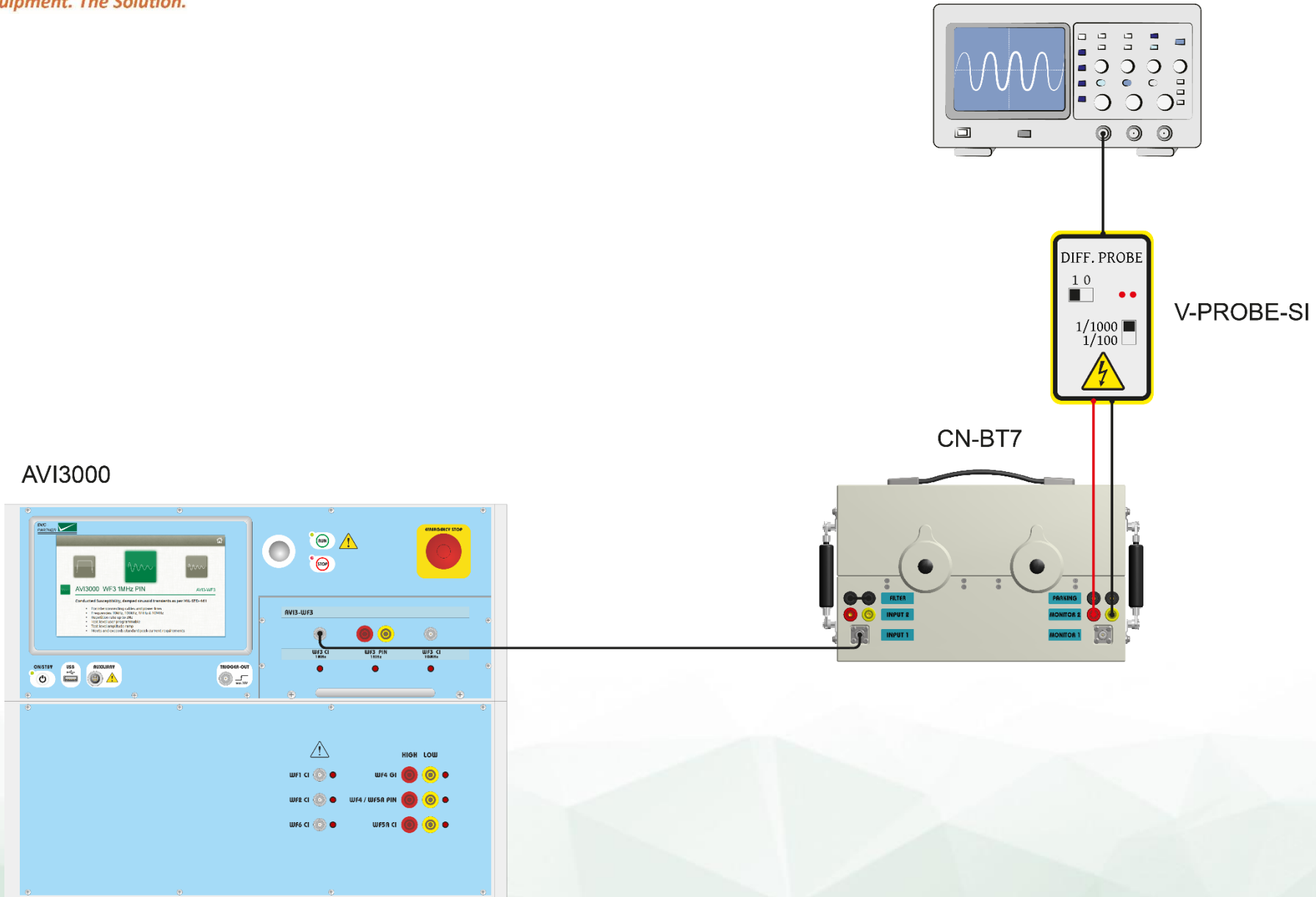

AVI3000

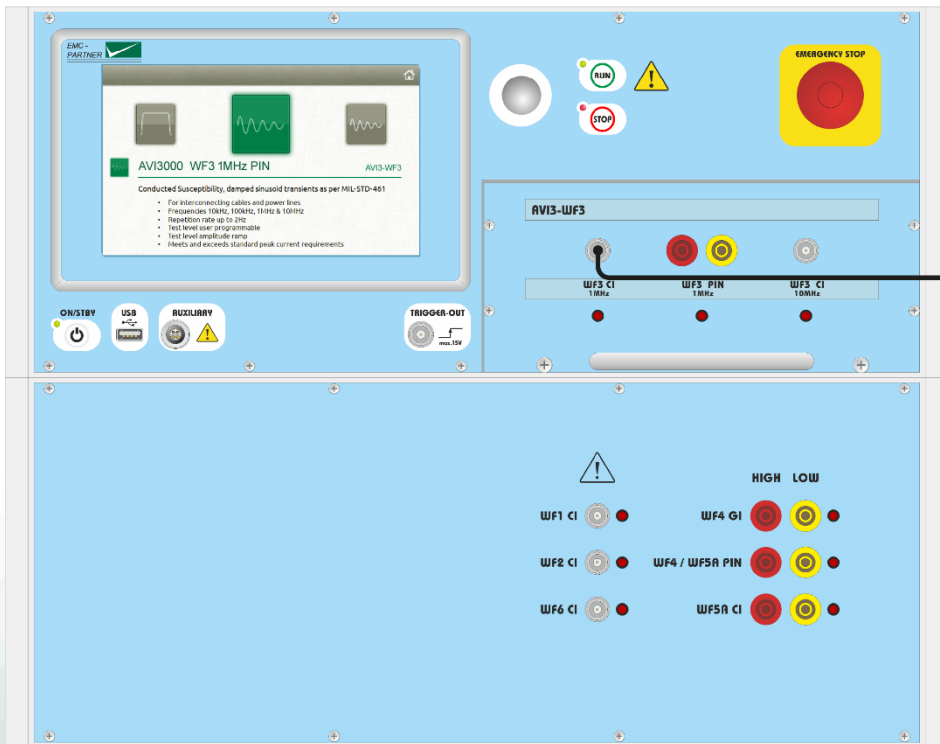

CN-BT7

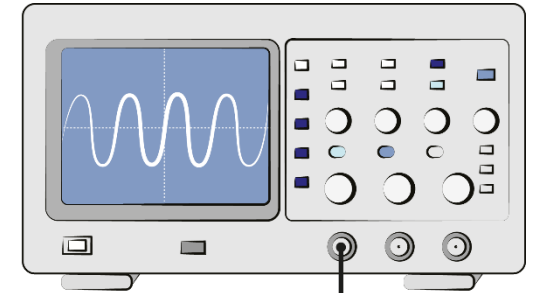
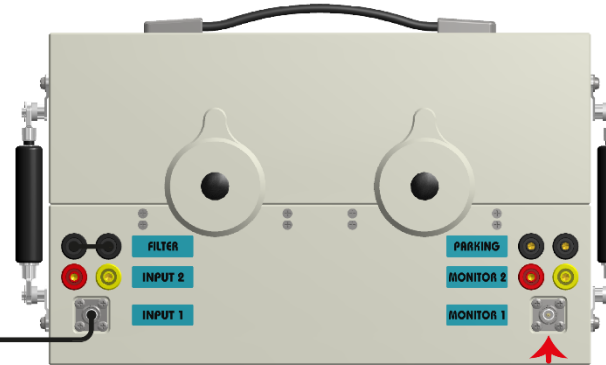

SHUNT0E1

AVI3000

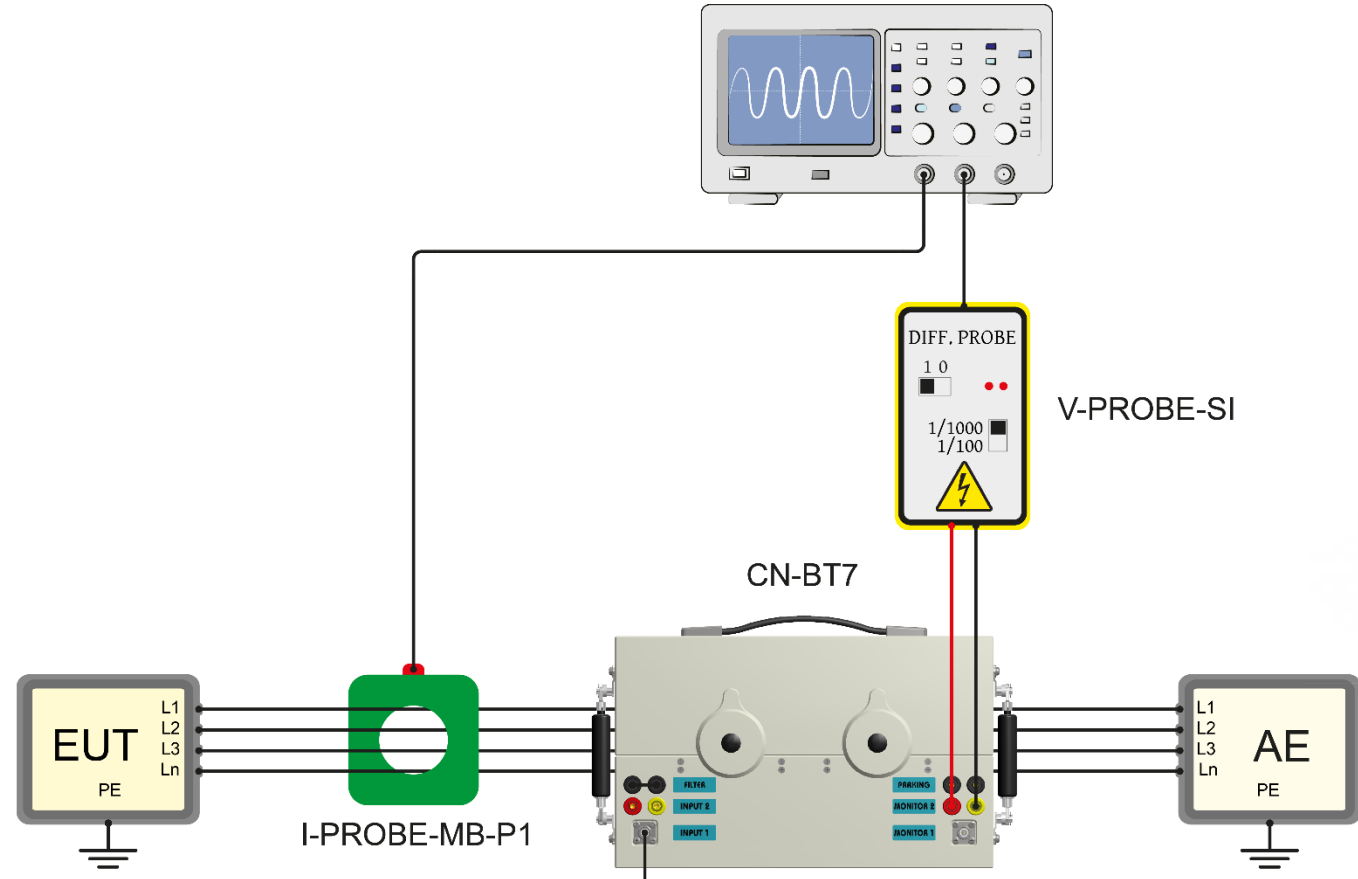
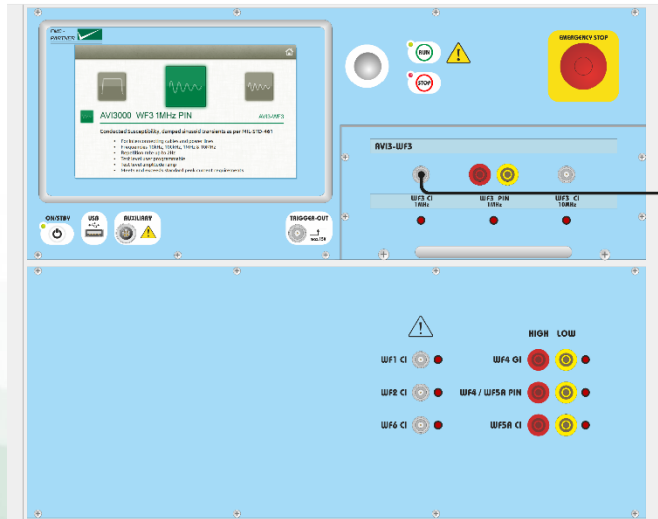

➔ Remove bridge from position FILTER
 and insert it in position PARKING (only for WF 3 10 MHz)

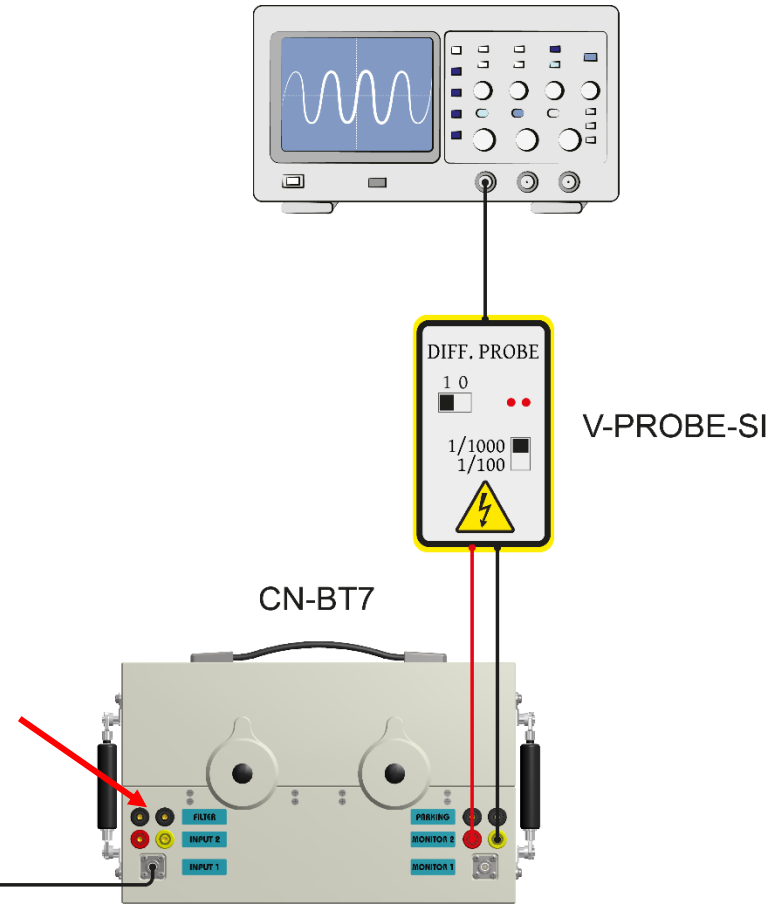
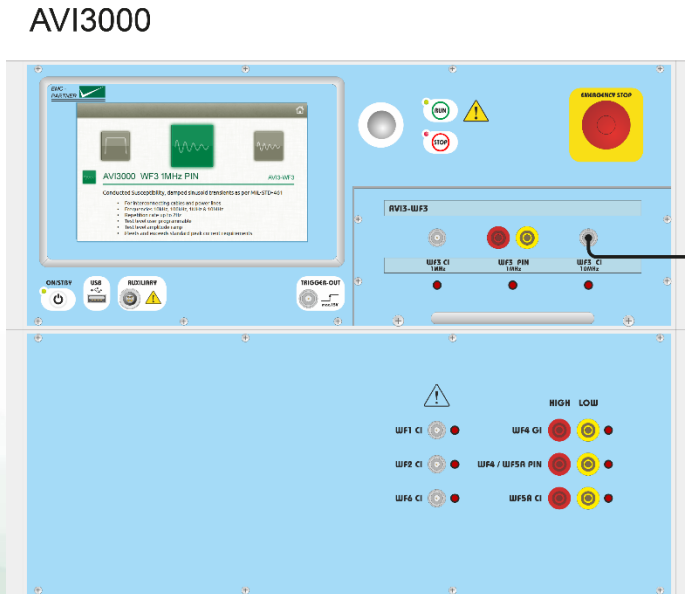

AVI3000

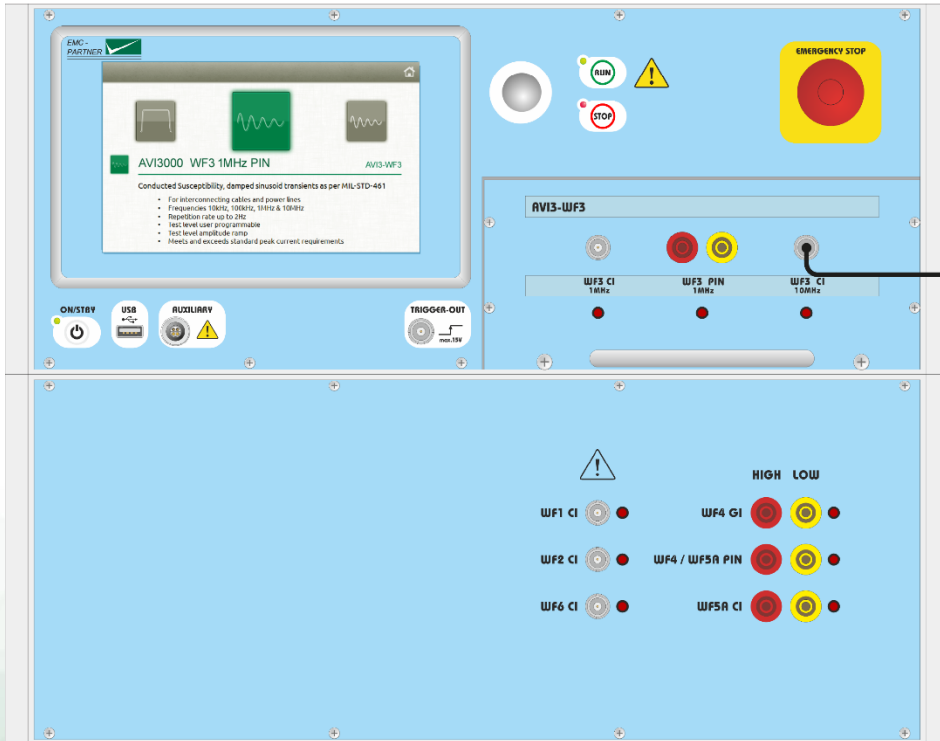

CN-BT7

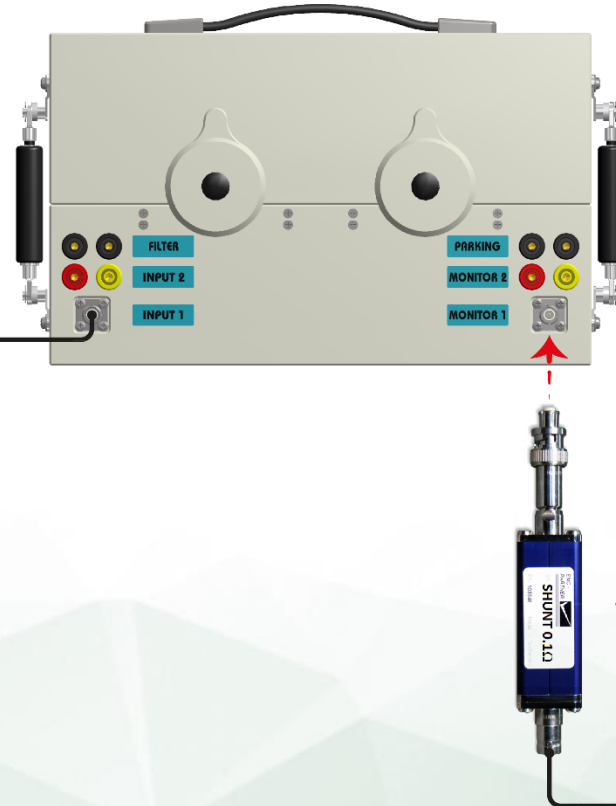

SHUNT0E1

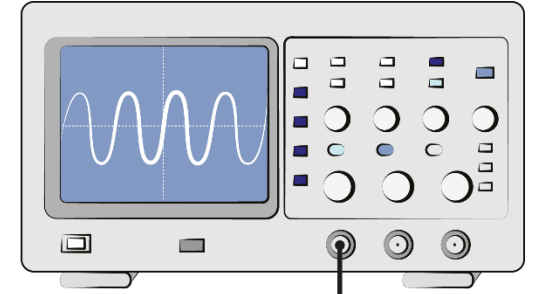

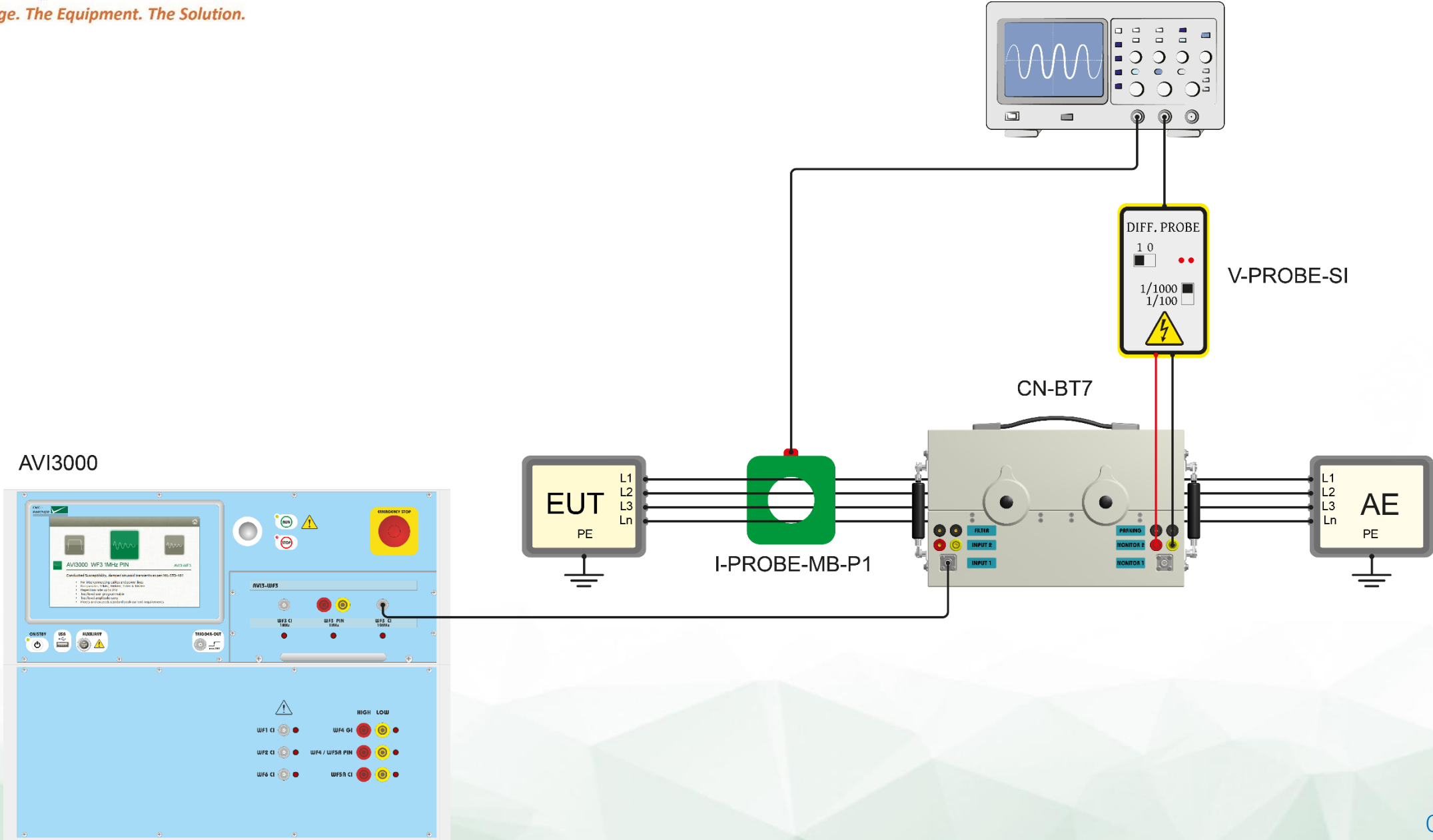

AVI3000

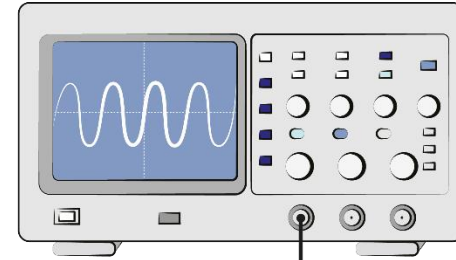
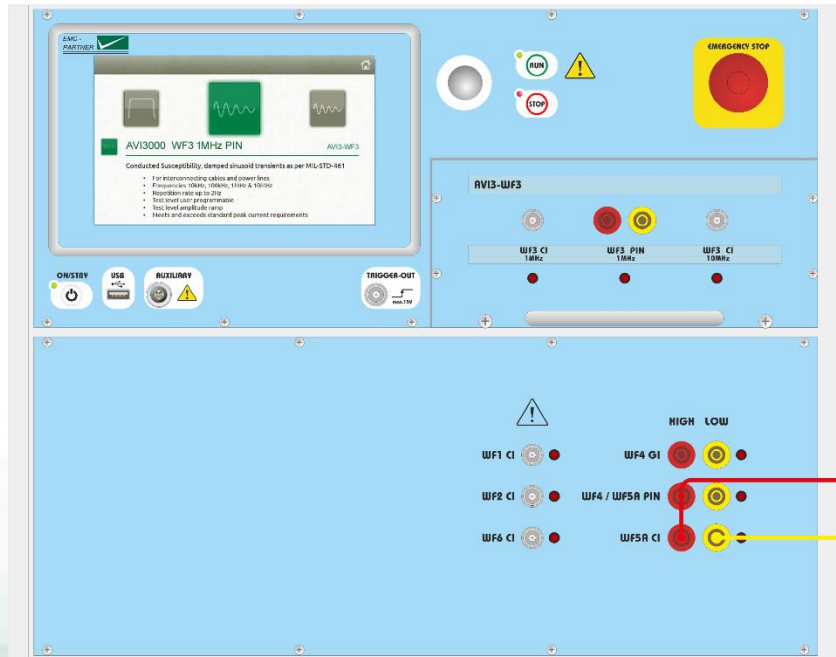

V-PROBE-SI

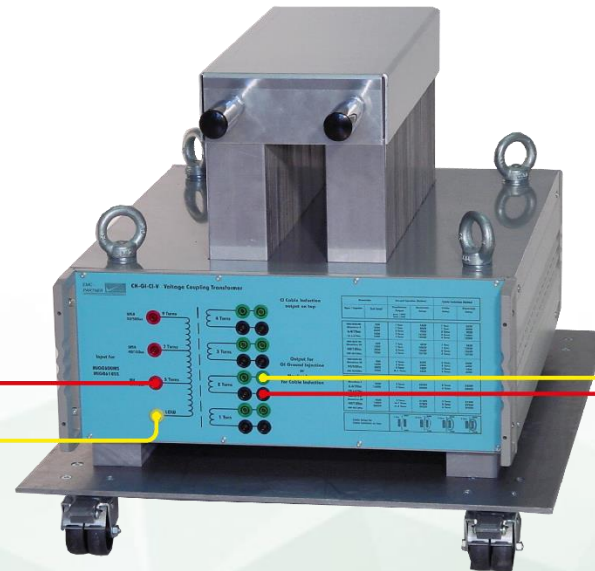
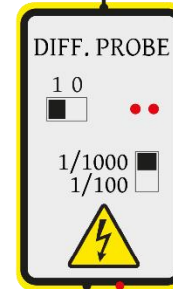

CN-GI-CI-V

AVI3000

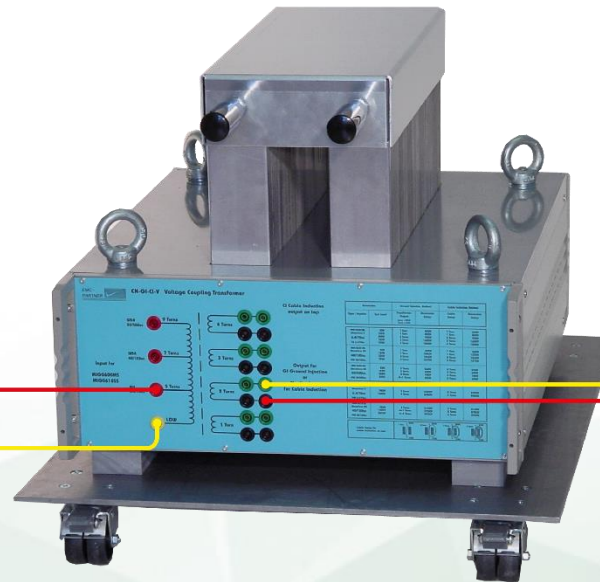
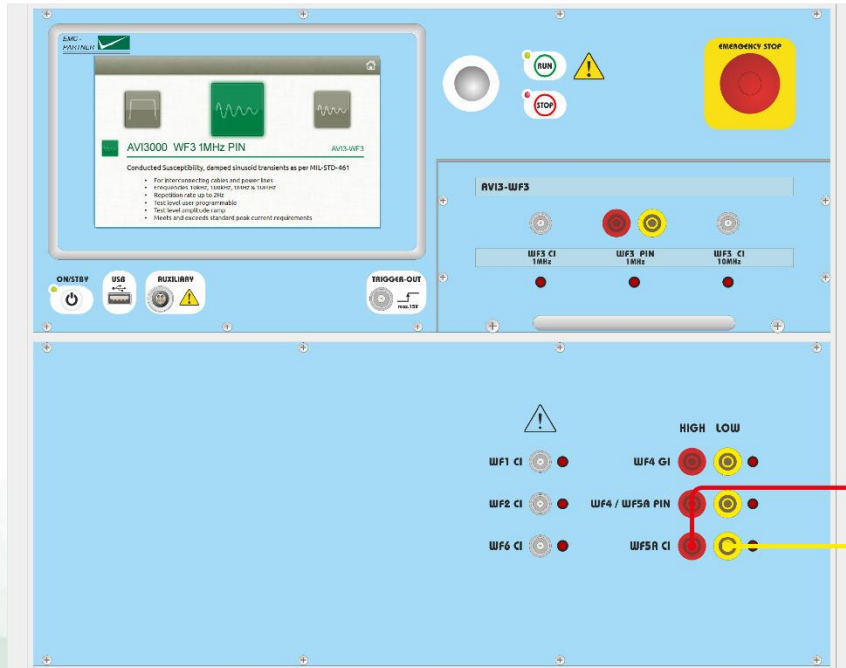

CN-GI-CI-V

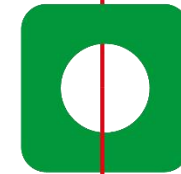
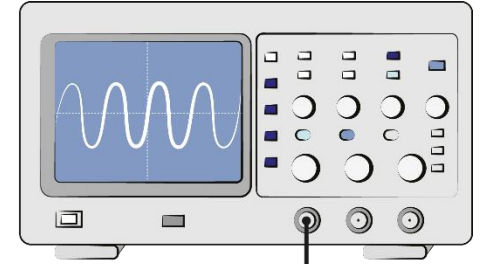

I-PROBE-MB-P1

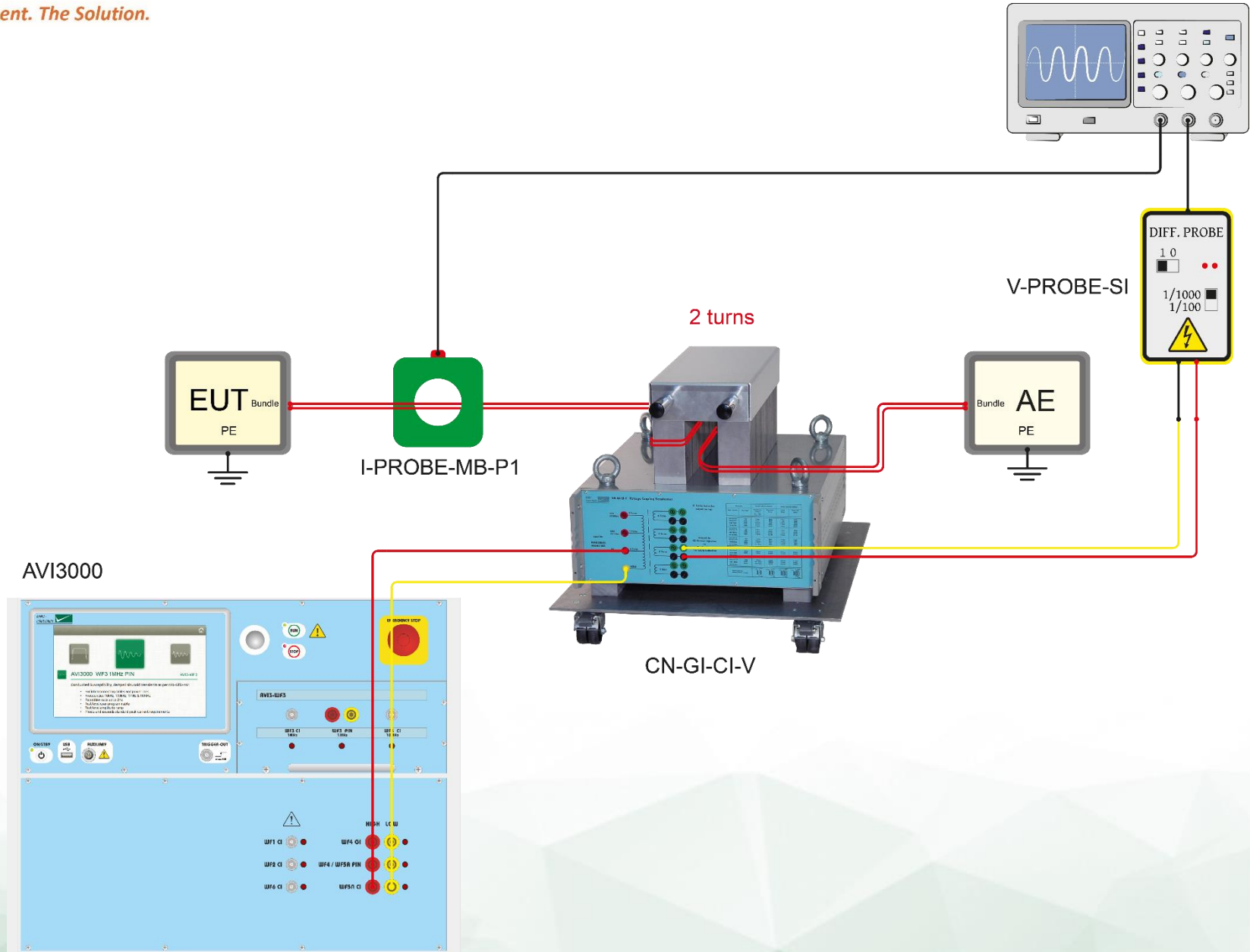

AVI3000

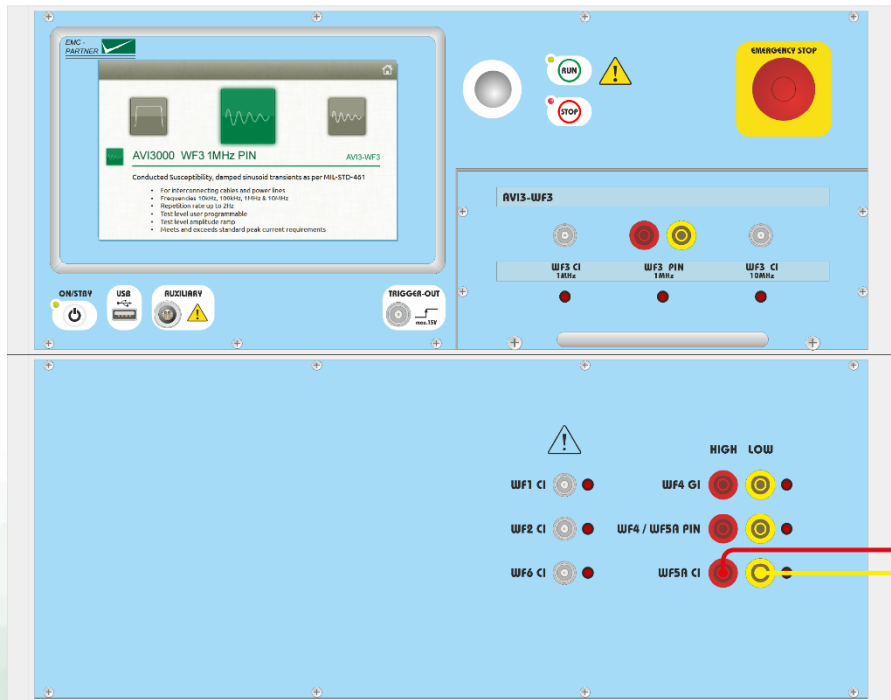

CN-BT7

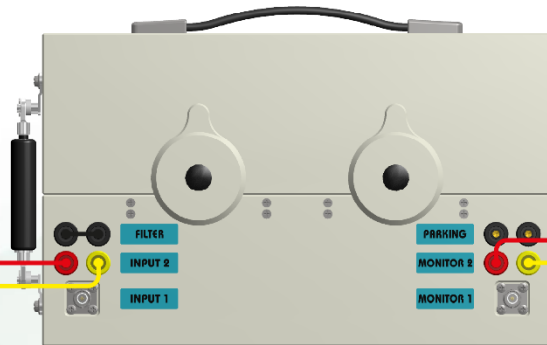

I-PROBE-MB-P1

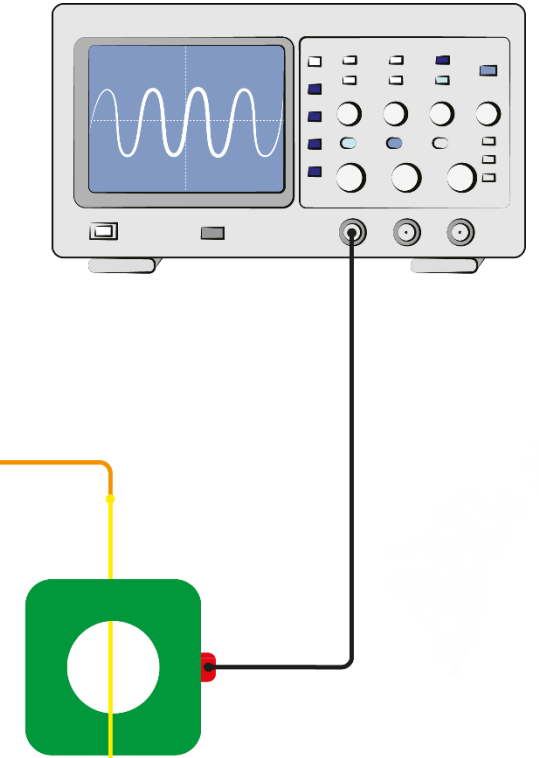

AVI3000

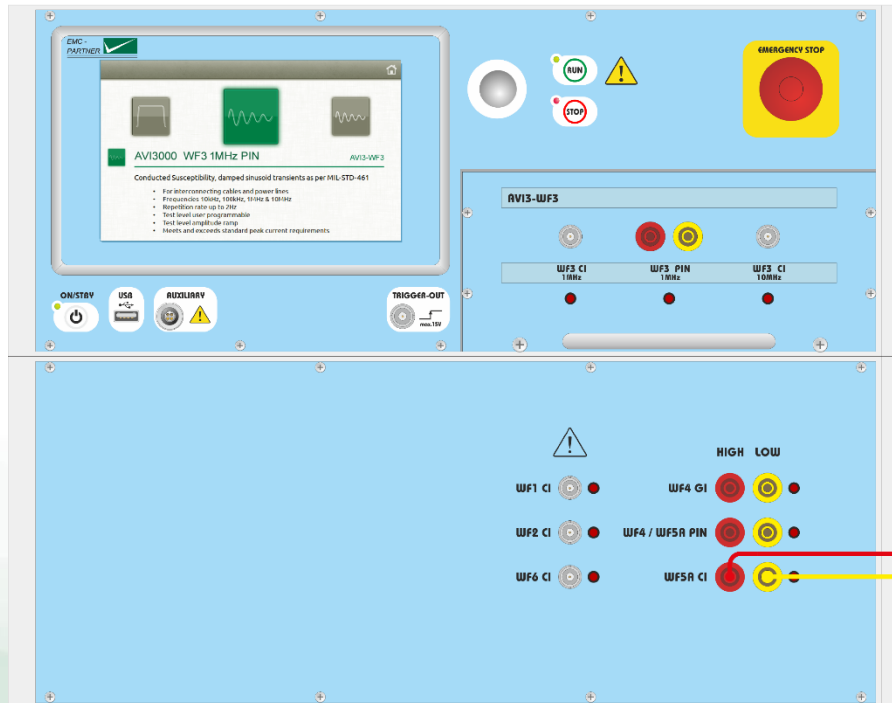

V-PROBE-SI

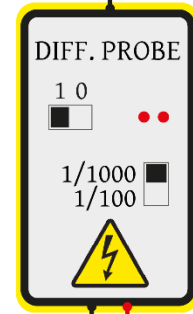

CN-BT7

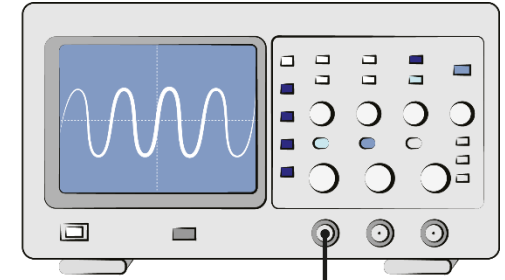
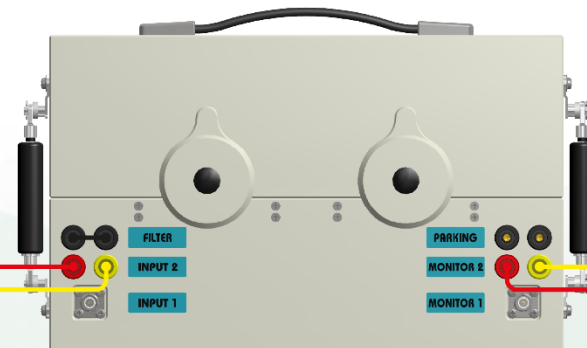

AVI3000

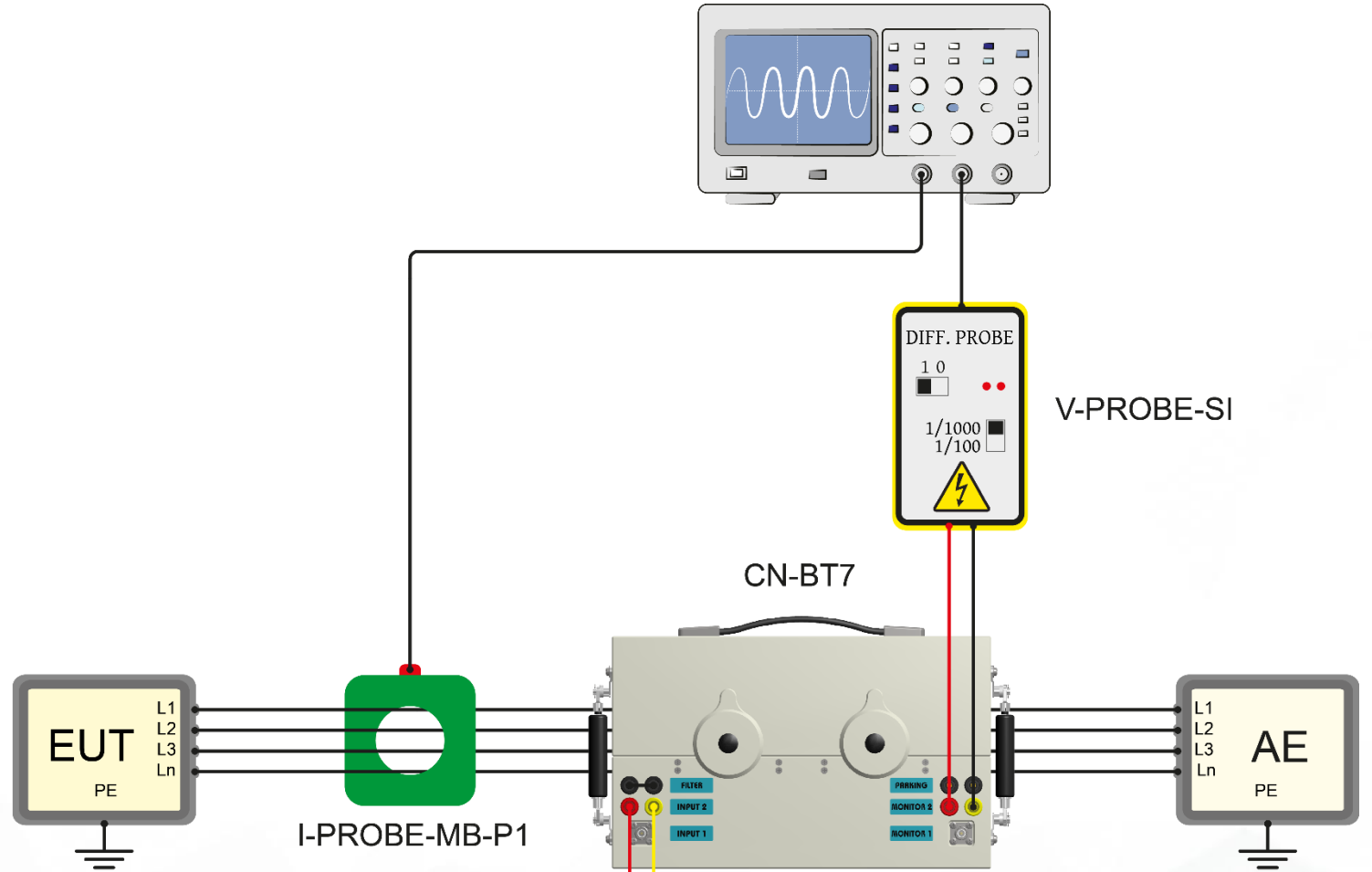
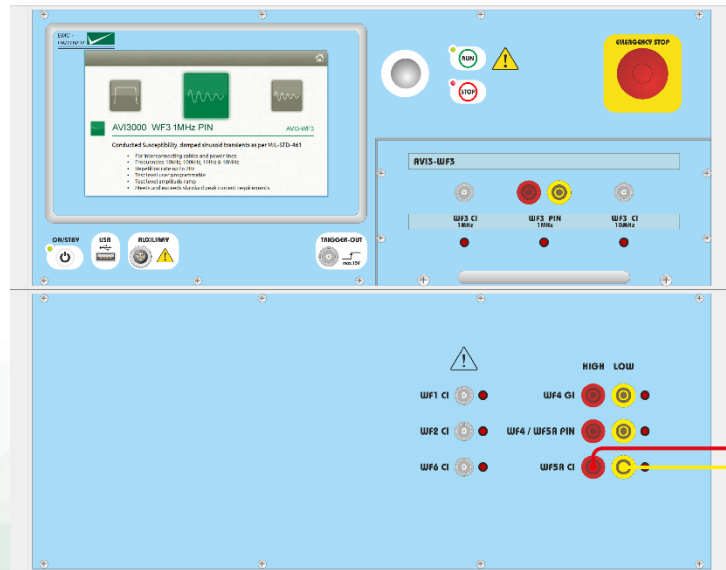

AVI3000

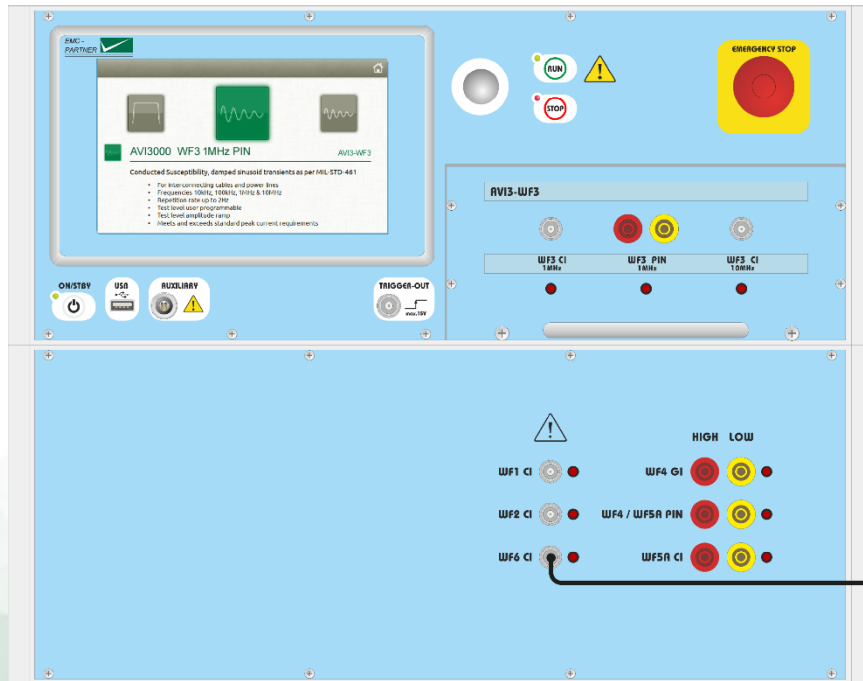

CN-BT7

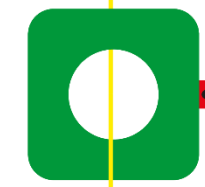
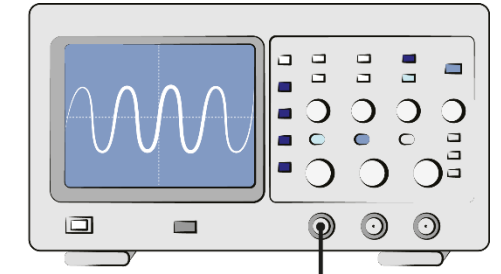
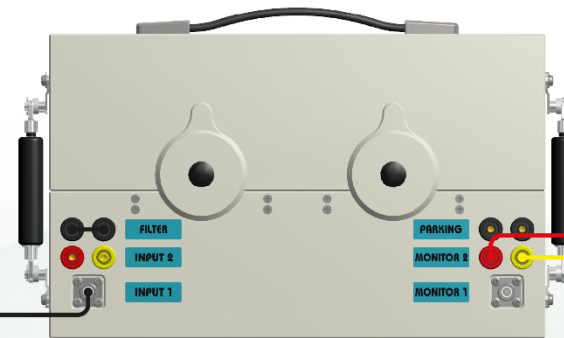

I-PROBE-MB-P1

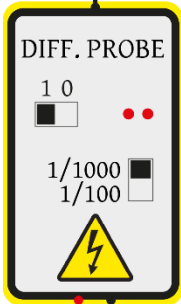
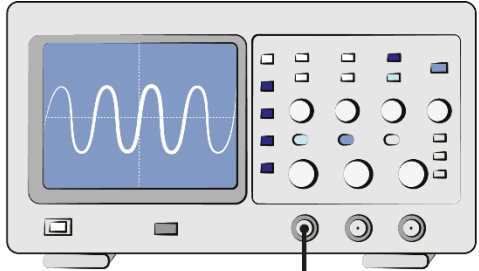

V-PROBE-SI

CN-BT7

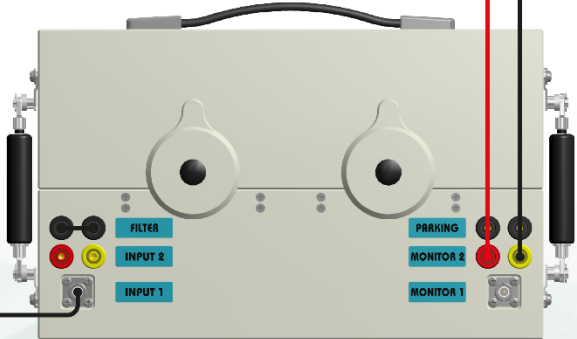

AVI3000

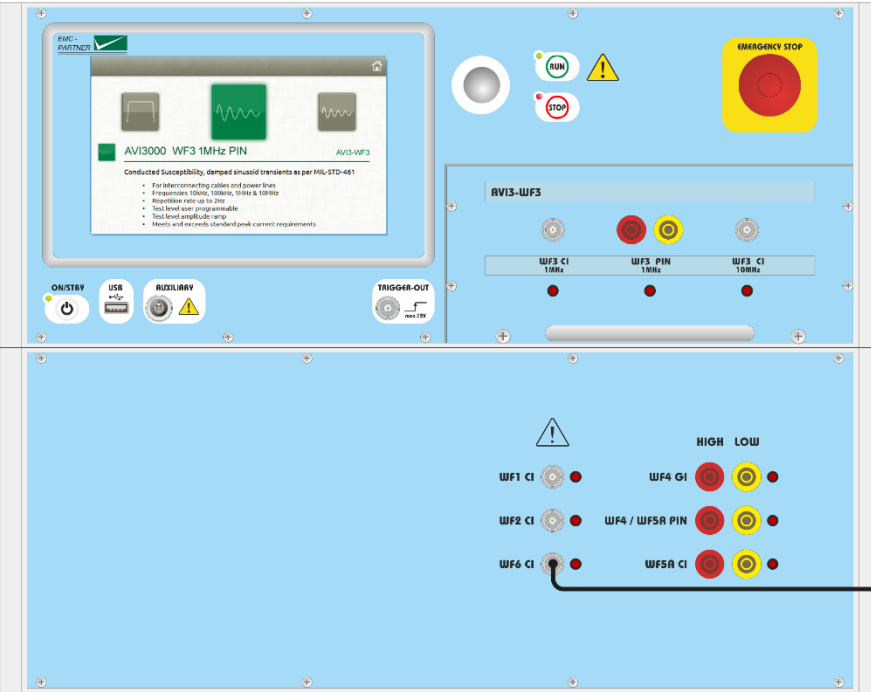

AVI3000

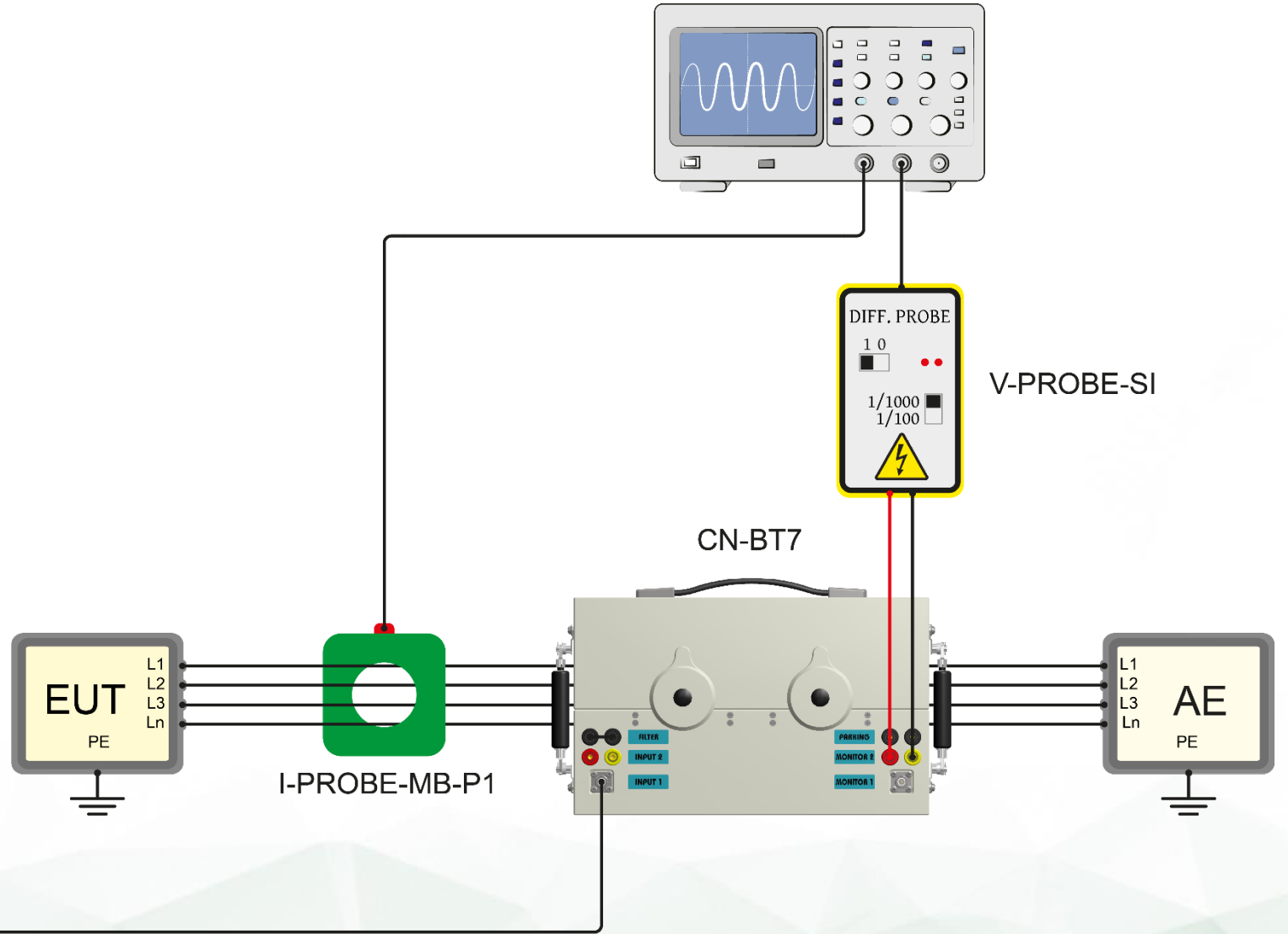
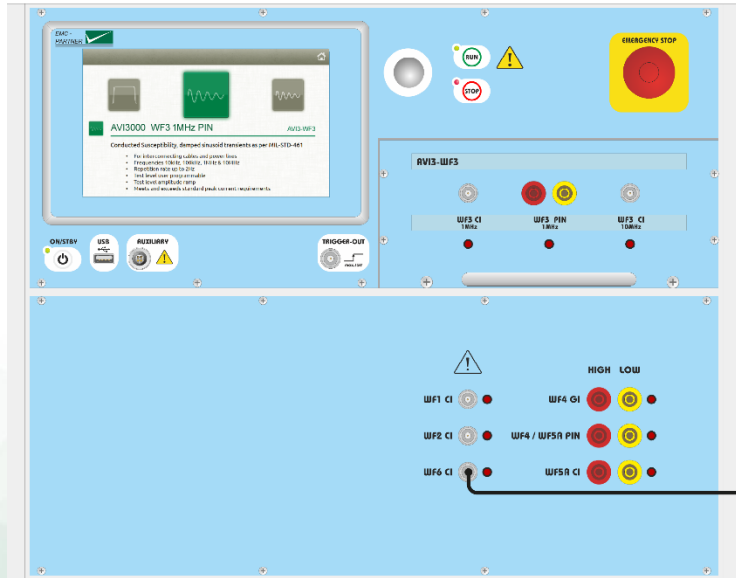

AVI3000

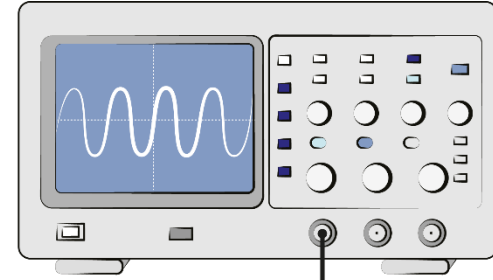
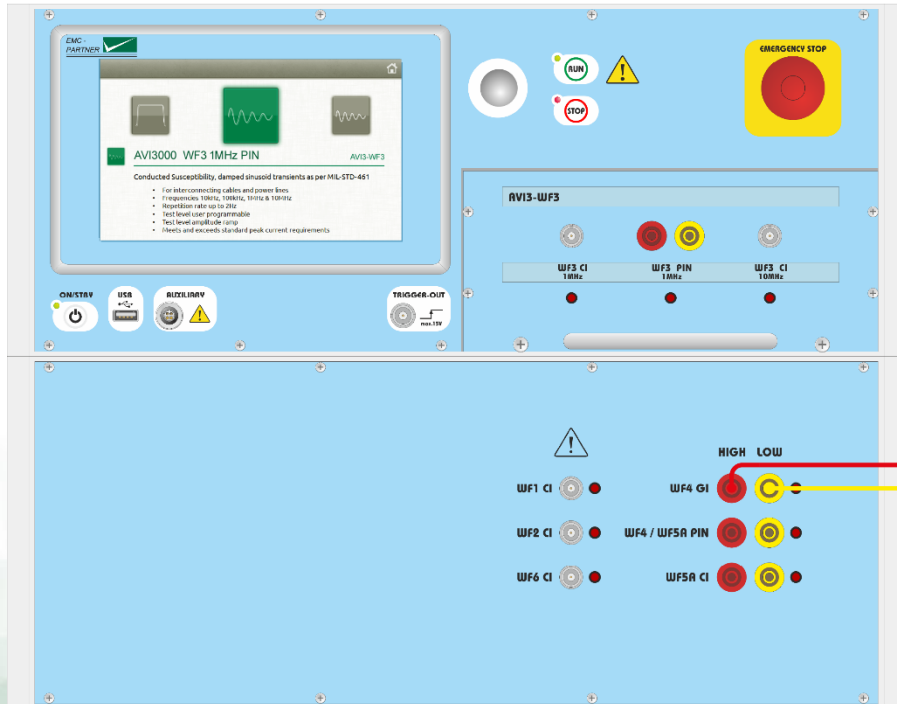

V-PROBE-SI

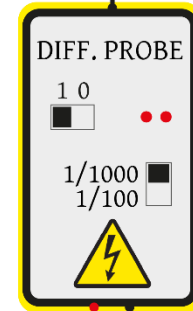

2 m cables

AVI3000

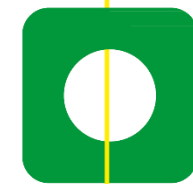
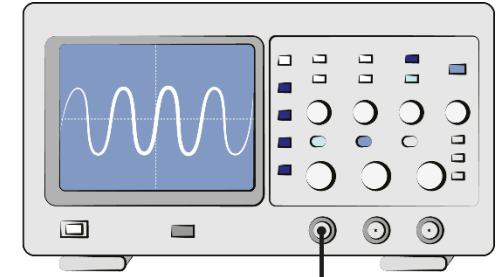
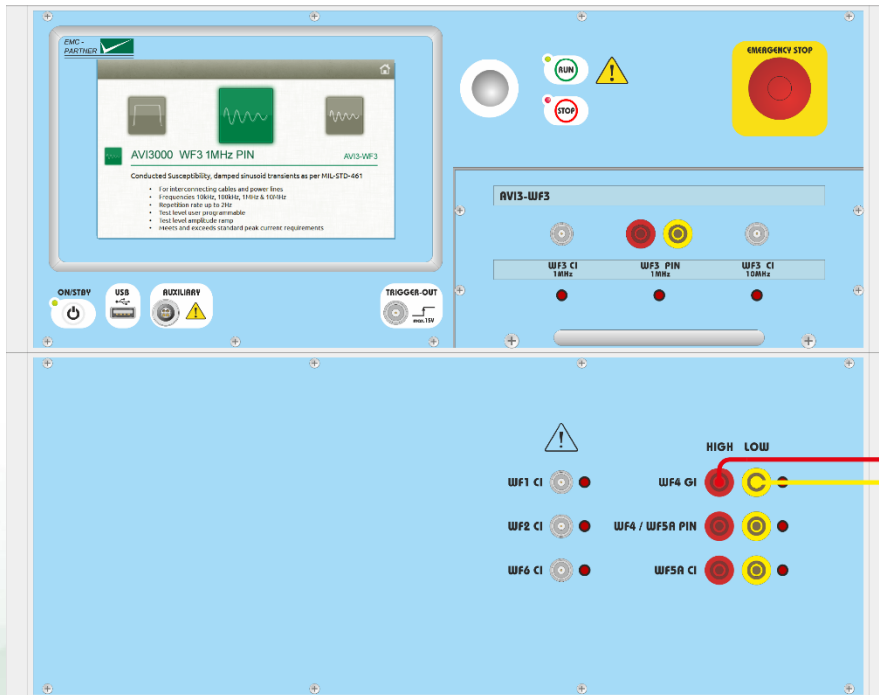

I-PROBE-MB-P1

2 m cables

AVI3000

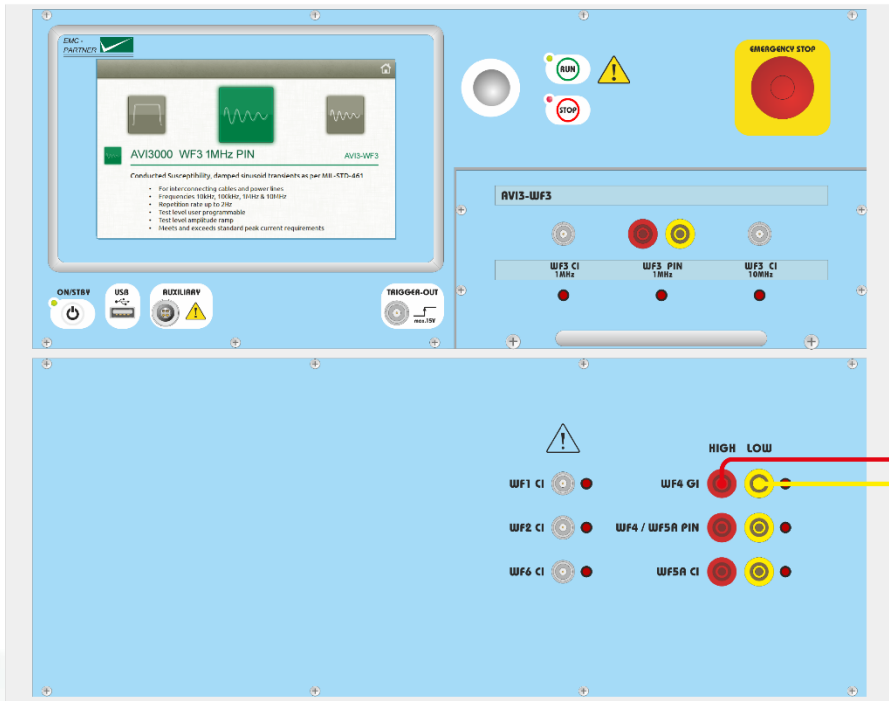

2 m cables

I-PROBE-MB-P1

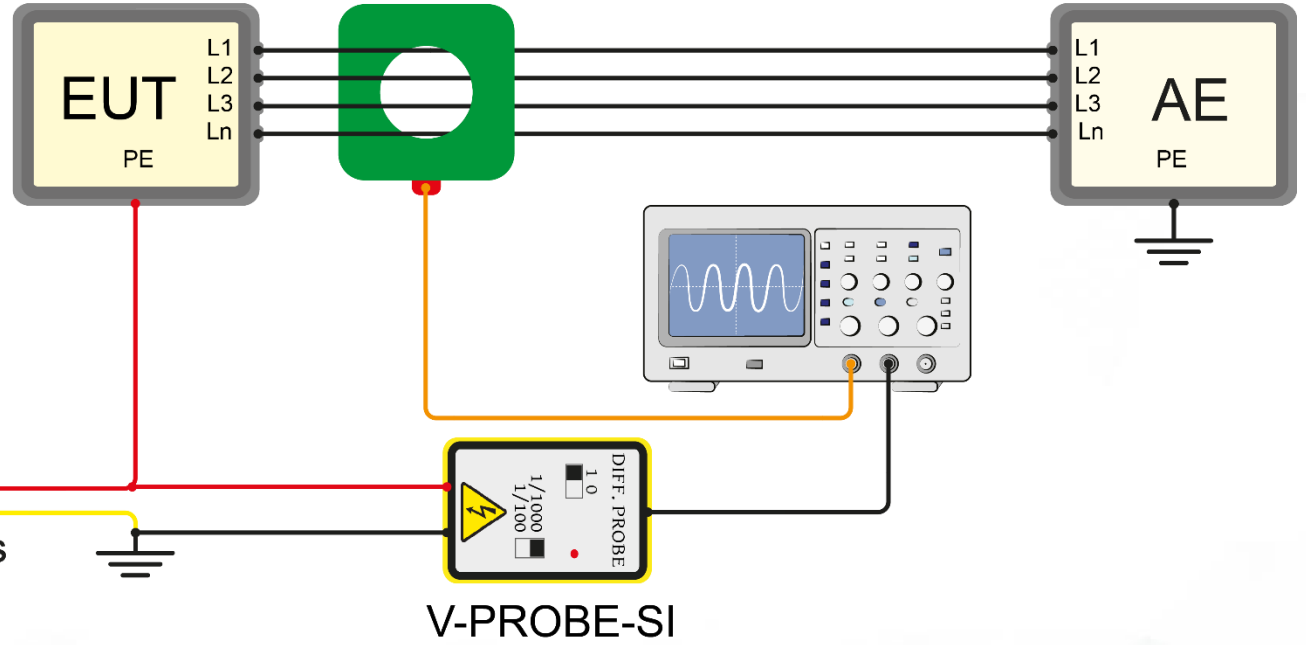

AVI3000

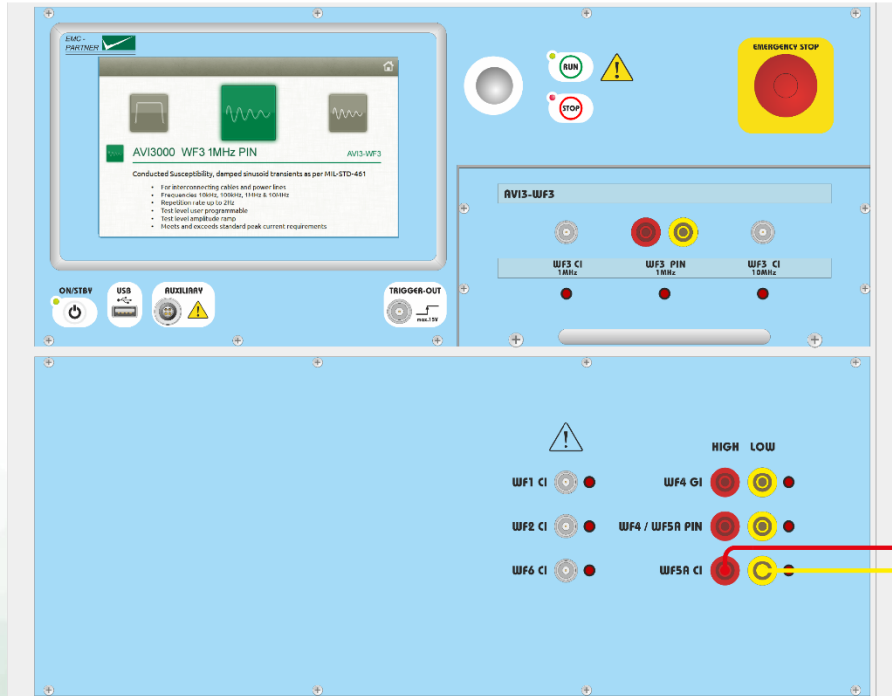

CN-BT7

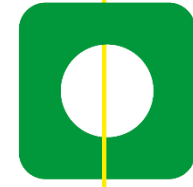
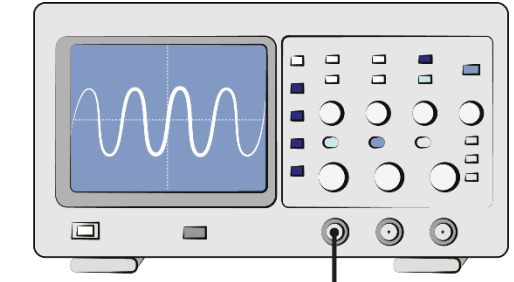
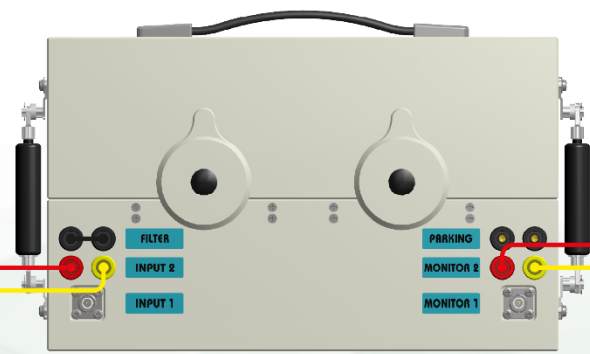

I-PROBE-MB-P1

AVI3000

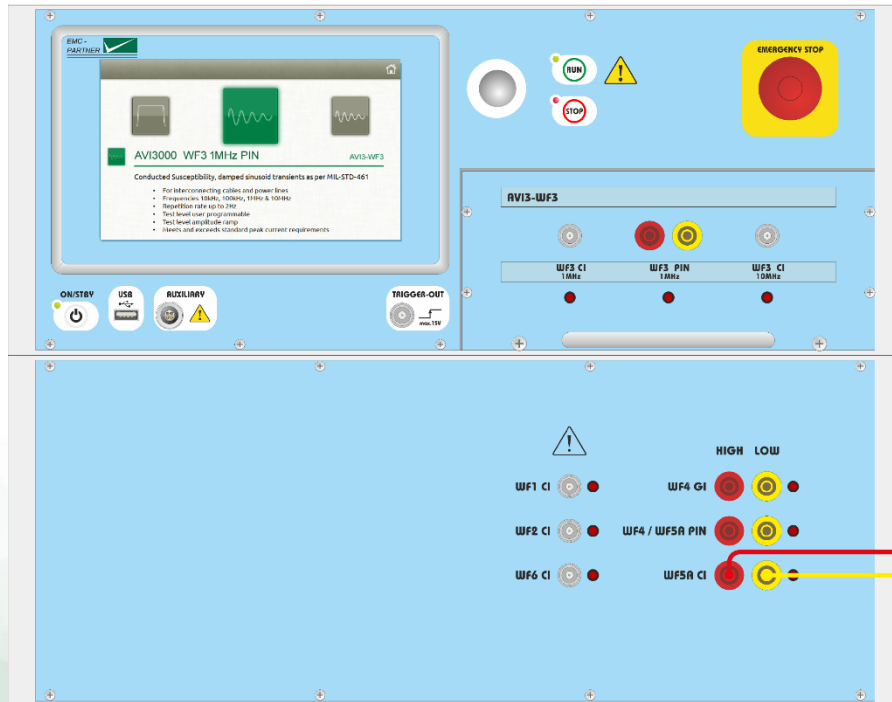

V-PROBE-SI

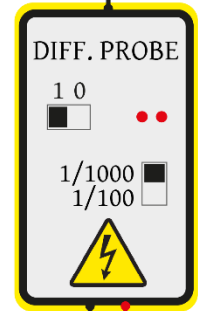

CN-BT7

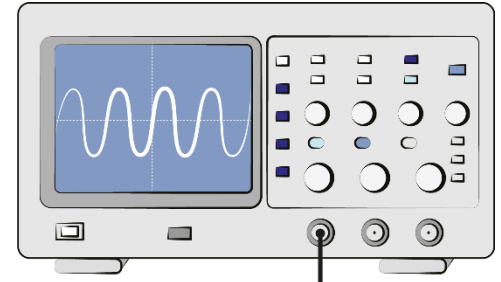
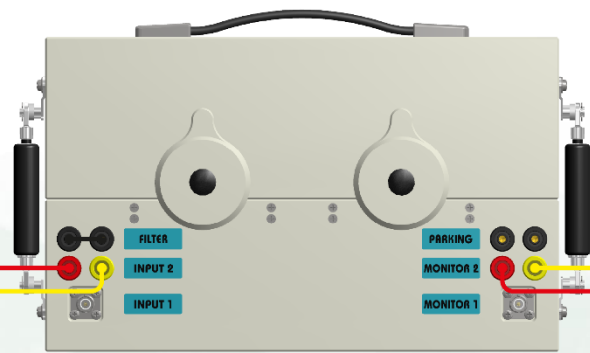

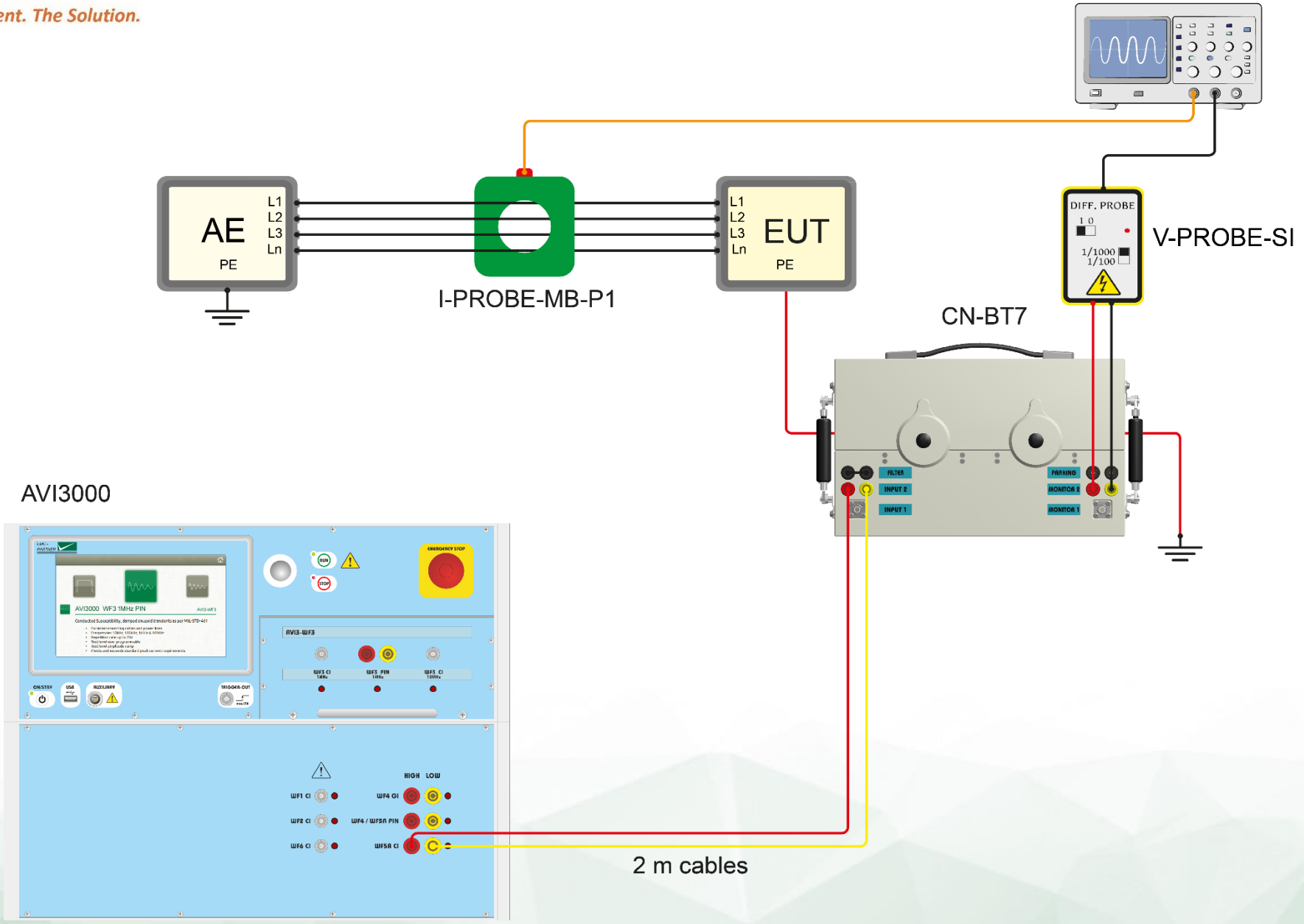

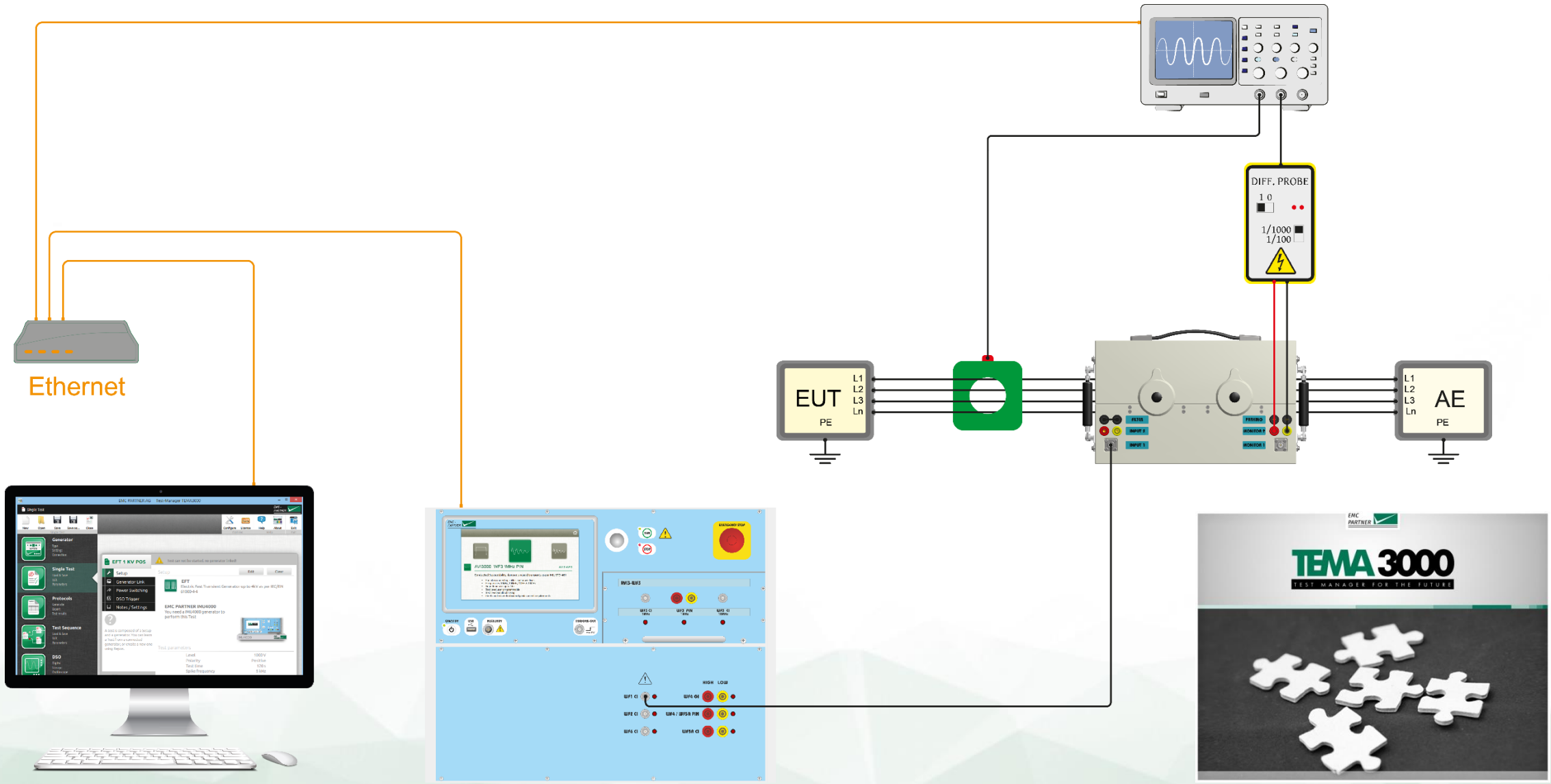



 **Advanced Test
Equipment Rentals**
The Knowledge. The Equipment. The Solution.

www.atecorp.com

www.emc-partner.com