



AMS Trex™ Device Communicator

User Guide
, Rev 3
August 2017

User Guide



Copyright and trademark information

©2017 Emerson. All rights reserved.

FOUNDATION™, HART® and *Wireless*HART® are marks of the FieldComm Group of Austin, Texas, USA.

The Emerson logo is a trademark and service mark of Emerson Electric Co.

All other marks are the property of their respective owners.

Notice

Important

Read this manual before working with the Trex unit. For personal and system safety, and for optimum product performance, thoroughly understand the contents before using or servicing this product.
For equipment service needs, contact the nearest product representative.

Important

This device complies with Part 15 of the FCC Rules. Operation is subject to the following two conditions: (1) this device may not cause harmful interference, and (2) this device must accept any interference received, including interference that may cause undesired operation.

WARNING!

If the Trex unit is used in a manner not specified by Emerson, the protection provided by the equipment may be impaired.

WARNING!

Do not directly connect the ports or terminals on the Trex unit to any main line voltage.

WARNING!

WARNING - POTENTIAL ELECTROSTATIC CHARGING HAZARD - SEE INSTRUCTIONS.

AVERTISSEMENT - DANGER POTENTIEL DE CHARGES ÉLECTROSTATIQUES - VOIR INSTRUCTIONS

Contents

Chapter 1	AMS Trex Device Communicator User Guide	1
1.1	User Guide overview	1
1.2	Documentation conventions	1
1.3	Technical support	2
1.3.1	Information to provide to technical support	2
Chapter 2	AMS Trex Device Communicator overview	3
2.1	Precautions for the Trex unit	4
2.1.1	Hazardous areas	4
2.2	Front view of the Trex unit	5
2.2.1	Keypad	5
2.3	Touchscreen	6
2.3.1	Supported gestures	7
2.3.2	Enter text, numbers, or special characters	8
2.3.3	Clean the touchscreen	8
2.4	Back view of the Trex unit	9
2.4.1	Serial numbers	9
2.5	Communication modules	10
2.5.1	Ammeter on the Device Communicator Plus communication module	12
2.5.2	Install a communication module	13
2.5.3	Remove a communication module	14
2.6	Power module	14
2.6.1	Precautions for the power module and AC adapter	15
2.6.2	AC adapter	15
2.6.3	LEDs on the power module	16
2.6.4	View the remaining power module charge	17
2.6.5	Charge the power module	18
2.6.6	Install the power module into the Trex unit	18
2.6.7	Remove the power module from the Trex unit	19
2.6.8	Maintain the power module	19
2.7	Accessories	20
2.7.1	Cables and lead sets	20
2.7.2	Carrying case for the Trex unit	21
2.8	Power on or off	22
2.8.1	Reboot	22
2.8.2	Hard shut down	23
2.9	Home screen	23
2.9.1	Return to the Home screen	25
2.9.2	Status bar	25
2.9.3	Shortcut bar	26
2.10	Settings	26
2.10.1	View all open applications	27
2.10.2	Close an application	27
2.10.3	Change the screen brightness	27
2.10.4	Wireless communication	27
2.10.5	View information about the Trex hardware and operating system	30
2.10.6	Enter a name for the Trex unit	31

2.10.7	View the application version number	31
2.10.8	Set the time and date	31
2.10.9	Calibrate the touchscreen	32
2.10.10	Set the language on Trex	32
2.10.11	View the amount of available memory	32
2.10.12	Power management	33
2.10.13	Enable or disable automatically connecting to HART devices	35
2.10.14	Enable Diagnostic Logging	35
2.11	Applications on the Trex unit	36
2.11.1	Activation	36
2.11.2	Close an application	36
2.12	USB communication	37
2.13	Synchronizing AMS Trex data with AMS Device Manager	37
2.13.1	Synchronize AMS Trex data to AMS Device Manager using USB	38
2.13.2	Pair an AMS Trex unit with an AMS Device Manager station	38
2.13.3	Unpair an AMS Trex unit	39
2.14	Upgrade Studio	40
2.14.1	Connect the Trex unit to Upgrade Studio using USB	41
2.14.2	Create a Trex online user account	41
2.14.3	Activate the Trex unit	42
2.14.4	Activate the Trex unit without using an internet connection	42
2.15	Transferring log files to a PC	43
2.16	Maintenance and repair	44
2.16.1	Replace the stand	44
2.16.2	Calibration	44
Chapter 3	Field Communicator application	45
3.1	Open or close the Field Communicator application	46
3.2	Device interoperability	46
3.3	Forward Compatibility rules for saving and sending configurations to AMS Trex	47
3.4	Automatically detect a device	47
3.4.1	Automatically connect to a HART device	48
3.5	Connect - Select screen	48
3.6	Device connection wizard	50
3.7	Status when detecting a device	51
3.8	Online menu or Device Dashboard	53
3.8.1	Device screen layout	55
3.8.2	Application bar	57
3.8.3	Menu screen	58
3.9	Icons on the device menus	61
3.10	Connections to HART devices	62
3.10.1	HART communication terminals	62
3.10.2	Wiring diagrams for HART devices and the Field Communicator application	64
3.10.3	Wiring diagrams for the Smart Wireless THUM™ Adapter and the Field Communicator application	69
3.10.4	HART Device List	73
3.11	Internal resistors	74
3.11.1	Enable or disable the internal resistors	76
3.12	Power and connect to a HART device	78
3.12.1	Power and connect to a Smart Wireless THUM adapter	80
3.13	Connect to an externally-powered HART device	81
3.14	Online HART devices	82

3.14.1	HART icons	82
3.14.2	Device Setup options	83
3.14.3	Changing device parameters	84
3.14.4	Change a HART device parameter	85
3.14.5	Edit a HART configuration	86
3.14.6	Display the HART short tag or long tag	86
3.14.7	View device alerts	88
3.14.8	Send a configuration to a connected HART device	89
3.14.9	Save a configuration from a HART device	89
3.15	Offline HART configurations	89
3.15.1	Create a HART configuration	90
3.15.2	Edit a HART configuration	90
3.15.3	Copy a HART configuration	91
3.15.4	Rename a HART configuration	91
3.15.5	Delete a HART configuration	91
3.16	Favorites	91
3.16.1	Open a menu item from the favorites list	92
3.16.2	Add a menu item to the favorites list	92
3.16.3	Remove a menu item from the favorites list	93
3.17	Polling options for HART devices	94
3.17.1	Set the polling options for HART devices	94
3.18	Connections to FOUNDATION fieldbus devices	95
3.18.1	Precautions for using the Trex unit with FOUNDATION fieldbus devices	96
3.18.2	FOUNDATION fieldbus communication terminals	96
3.18.3	Wiring diagrams for FOUNDATION fieldbus devices and the Field Communicator application	98
3.18.4	Link Active Scheduler (LAS)	100
3.18.5	Fieldbus Device List	100
3.19	Power and connect to a FOUNDATION fieldbus device	101
3.20	Connect to an externally-powered FOUNDATION fieldbus device	103
3.21	Online FOUNDATION fieldbus devices	104
3.21.1	Limitations for commissioned devices	104
3.21.2	Device blocks	104
3.21.3	Run a method	108
3.21.4	View the device information	109
3.21.5	Change a FOUNDATION fieldbus device parameter	109
3.21.6	Change the tag for a FOUNDATION fieldbus device	110
3.21.7	Guidelines for changing the device address	111
3.21.8	Change the device address for a FOUNDATION fieldbus device	111
3.21.9	Polling for FOUNDATION fieldbus devices	112
3.21.10	Set a FOUNDATION fieldbus device to be a link master or basic device	112
3.22	Simulate a live device	113
3.23	View the device descriptions on the Trex unit	113
3.24	View the device description information	114
3.25	View Help for a device parameter	115
3.26	Graphics	115
3.26.1	Images	115
3.26.2	Charts	116
3.26.3	Strip/sweep/scope chart	116
3.26.4	Horizontal bar charts	117
3.26.5	Vertical bar charts	118

	3.26.6 Gauge charts	119
	3.26.7 Graphs	120
	3.27 Disconnect a device	121
Chapter 4	Loop Diagnostics application	123
4.1	Open or close the Loop Diagnostics application	124
4.2	Loop Diagnostics screen	124
4.2.1	View the connection diagram as a full-screen image	127
4.3	Powering transmitters or positioners from Loop Diagnostics	127
4.4	Voltage and current measurements in Loop Diagnostics	129
4.5	Wiring diagrams for the Loop Diagnostics application	130
4.6	Power a 2-wire transmitter	136
4.7	Power a 2-wire transmitter and measure analog output	137
4.8	Power a positioner	139
4.9	Stroke a valve	140
4.10	Settings for controlling current	141
4.10.1	Change the values for the quick buttons	141
4.10.2	Change the scale for the up and down arrow keys	142
4.10.3	Set the duration to change the current	143
4.11	Loop checks	143
4.11.1	Measure voltage on an externally-powered loop	145
4.11.2	Measure the control system output	145
4.11.3	Simulate a transmitter on an externally-powered loop for a loop check	146
4.11.4	Simulate a transmitter on an unpowered loop for a loop check	147
Chapter 5	Fieldbus Diagnostics application	149
5.1	Open or close the Fieldbus Diagnostics application	150
5.2	Fieldbus Diagnostics Overview screen	150
5.3	GOOD, BAD, and CHECK measurements in Fieldbus Diagnostics	153
5.4	Wiring diagrams for the Fieldbus Diagnostics application	155
5.5	Power a FOUNDATION fieldbus device	157
5.6	Connect to an externally-powered fieldbus segment	158
5.7	Measure the DC voltage, noise, and the fieldbus signal	159
5.8	Details screen	160
5.9	View the live measurement values in Fieldbus Diagnostics	161
5.10	View help for a measurement	161
5.11	Noise spectrum	162
5.11.1	View a spectrum of the noise measurement	165
5.12	Settings	166
5.12.1	View or hide the minimum, maximum, and average values for a measurement	167
5.12.2	View or hide the device tags when online	167
5.12.3	Set the number of measurements to average	167
5.12.4	Set the range of values for the GOOD and BAD status	168
5.12.5	Reset the Fieldbus Diagnostics settings to the default values	168
5.13	Saving measurements to a log file	168
5.13.1	Log file overview	169
5.13.2	Enable or disable logging	171
5.13.3	Save measurements to an existing log file	172
5.13.4	Transfer a Fieldbus Diagnostics log file from the Trex unit to a PC	173
5.14	Troubleshooting Fieldbus Diagnostics	174

Appendices and reference

Appendix A Troubleshooting	179
A.1 Troubleshoot HART communication	179
A.1.1 HART loops	181
A.2 Troubleshoot fieldbus communication	182
Appendix B Technical specifications	183
B.1 Physical specifications	183
B.2 Communication module specifications	184
B.3 Processor, memory, operating system specifications	186
B.4 Environmental specifications	186
B.5 Intrinsically Safe electrical parameters	187
B.6 Power module specifications	188
B.7 AC adapter specifications	188
Appendix C Product certifications	191
Appendix D Wireless/Spectrum approvals	193
Glossary	195
Index	199

1 AMS Trex Device Communicator User Guide

Topics covered in this chapter:

- [User Guide overview](#)
- [Documentation conventions](#)
- [Technical support](#)

1.1 User Guide overview

The *AMS Trex Device Communicator User Guide* is written for instrument technicians who work with field devices, including HART® and FOUNDATION™ fieldbus devices. The user guide describes the hardware, connections to devices, the supported applications, and the diagnostics you can run on devices, 4-20 mA current loops, or FOUNDATION fieldbus segments.

Note

The Trex unit has two communication module options. This user guide describes both modules. Any differences in the procedures based on these modules are noted.

1.2 Documentation conventions

The following conventions are used throughout:

Note

A note paragraph contains special comments or instructions.

⚠ CAUTION!

A caution paragraph alerts you to actions that can have a major impact on the equipment or stored data.

⚠ WARNING!

A warning paragraph alerts you to actions that can have extremely serious consequences for equipment and/or personnel.

1.3 Technical support

Contact your local representative or go to the AMS Trex Device Communicator website for technical support contact information.

1.3.1 Information to provide to technical support

Before you call technical support personnel, have a detailed description of the issue, including the information below (if applicable). Ensure you have the user manual for the devices or digital control system available.

Information about the Trex unit

- Operating system version on the Trex unit. (Tap Settings > About.)
- The serial number of the Trex unit. You can view the serial number from the Settings. (Tap Settings > About > CPU Board Serial Number.) The serial number is located on the label on the bottom of the Trex unit, near the power module LEDs.
- Version number for the application. (Tap Settings > Installed Applications.)

Troubleshooting device communication issues

- Does the control system support HART® or FOUNDATION™ fieldbus communications?
- What is the manufacturer and model of the control system?
- What is the device manufacturer name (or ID) and model revision of the device (exact spelling if possible)?
- What task is being performed when the communication problem occurs?
- Can AMS Device Manager or another Trex unit communicate with the device?
- Are you having communication problems with multiple devices?
- Are there any error messages displayed when attempting to communicate with a device?
- Does communication work when certain devices or processes are not running?
- What is the total cable length run from the termination panel to the device?

When you are working with HART devices, answer the following questions:

- What is the loop impedance (resistance value) in the HART loop?
- If a HART multiplexer is being used, what is the manufacturer and model?
- Is the device in burst mode?
- Is the device address set to "0"?
- Is more than one device on the loop?
- Is another master (primary or secondary) on the loop? (For example, a control system or multiplexer.)
- Is the device powered by the Trex unit or an external power supply?

2 AMS Trex Device Communicator overview

Topics covered in this chapter:

- *Precautions for the Trex unit*
- *Front view of the Trex unit*
- *Touchscreen*
- *Back view of the Trex unit*
- *Communication modules*
- *Power module*
- *Accessories*
- *Power on or off*
- *Home screen*
- *Settings*
- *Applications on the Trex unit*
- *USB communication*
- *Synchronizing AMS Trex data with AMS Device Manager*
- *Upgrade Studio*
- *Transferring log files to a PC*
- *Maintenance and repair*

The Trex unit supports HART® and FOUNDATION™ fieldbus devices, so you can configure or troubleshoot in the field or on the work bench. Electronic Device Description Language (EDDL) technology enables the Trex unit to communicate with a variety of devices independent of device manufacturer.

Depending on the attached communication module, the Trex unit lets you:

- Configure HART and FOUNDATION fieldbus devices.
- Power one HART or FOUNDATION fieldbus device.
- Measure current and voltage.
- Perform diagnostics on a 4-20 mA current loop or FOUNDATION fieldbus segment.

The Trex unit includes a color LCD touchscreen, a Lithium-Ion power module (battery pack), a processor, memory components, and optional communication modules.

⚠ CAUTION!

When the Trex unit communicates with devices, follow all standards and procedures applicable to the location. Failure to comply may result in equipment damage and/or personal injury. Understand and comply with the sections in this manual.

2.1 Precautions for the Trex unit

Before operating the Trex unit, ensure:

- The Trex unit is not damaged.
- The power module is securely attached.
- All screws are sufficiently tightened.
- The communication terminal recess is free of dirt and debris.
- The communication module is securely attached.

⚠ CAUTION!

Do not use a screen protector on an IS-approved Trex unit. Static discharge is possible.

2.1.1 Hazardous areas

A Trex unit that meets the Intrinsic Safety requirements (IS-approved) can be used in Zone 1, or Zone 2, for Group IIC, and Class I, Division 1 and Division 2, Groups A, B, C, and D locations.

An IS-approved Trex unit may be connected to loops or segments that are attached to equipment located in Zone 0, Zone 1, Zone 2, for Group IIC; Zone 20, Zone 21, Zone 22, and Class I, Division 1 and Division 2, Groups A, B, C, and D locations.

An IS-approved Trex unit can be ordered by selecting the KL option. The Trex unit has a label that lists the approvals.

⚠ CAUTION!

Do not use a screen protector on an IS-approved Trex unit. Static discharge is possible.

⚠ WARNING!

Do not install, remove, or charge the Lithium Ion (Li-Ion) power module in a hazardous area environment.

⚠ WARNING!

Explosions can result in serious injury or death.

Use in an explosive environment must be in accordance with the appropriate local, national, and international standards, codes, and practices. Please review the Technical specifications and Product certifications sections of the *AMS Trex Device Communicator User Guide* for any restrictions associated with safe use.

Electrical shock can result in serious injury or death.

2.2 Front view of the Trex unit

Figure 2-1: Front view



- A. Micro USB port (top)
- B. Power button (side)
- C. Strap connectors (side)
- D. Touchscreen
- E. Keypad
- F. Charger port for the AC adapter (side)

Related information

[LEDs on the power module](#)
[Touchscreen](#)

2.2.1 Keypad

The Trex unit has a keypad that lets you navigate and select menu options. Use the four arrow buttons to move across all selectable options on the screen, and use the checkmark button to select an option.

The keypad also lets you enter text or numbers, based on the selected option or menu. An onscreen keyboard is displayed. The four arrows let you navigate to a letter, number, or symbol on the keyboard. Press the checkmark button or X button to select the option.

Figure 2-2: Keypad

- A. *Cancel any unsaved changes or close a menu. Similar to a Back button.*
- B. *Move through the menus and icons in the applications. Press the up, down, right, and left arrow keys to highlight a menu option on a screen. The right and left arrow keys also select items in a grid or on a graph, but they do not let you navigate to the next level in a menu.*
- C. *Open a menu item or accept any updates. Similar to an Enter button.*

2.3 Touchscreen

The Trex unit has a resistive touchscreen that lets you select menu items and enter text. Firmly press the screen to select an item. You need to apply more pressure than you would for smart phones and tablets. If the touchscreen seems inaccurate, you can re-calibrate it. All instructions in this manual are written for the touchscreen.

The touchscreen supports basic gestures, such as scroll up and scroll down. Multi-touch gestures, such as pinch, are not supported.

⚠ CAUTION!

The touchscreen display on the Trex unit could be damaged if directly impacted. To avoid damaging the touchscreen:

- Use the Trex carrying case with the faceplate closed to protect the touchscreen and prevent any damage when transporting or carrying the Trex unit.
- Do not let the touchscreen come in contact with other objects.
- Contact the touchscreen with blunt items only. Sharp instruments, such as screwdrivers, can damage the touchscreen.

Repairing the touchscreen requires replacement of the entire display assembly, which is possible only at an authorized service center.

⚠ CAUTION!

Do not use a screen protector on an IS-approved Trex unit. Static discharge is possible.

2.3.1 Supported gestures

The Trex unit uses a single-tap to select an item on the screen. You do not need to double-tap an option on the screen.

Note

Multi-touch gestures, such as pinch, are not supported. Only single-touch gestures are supported.

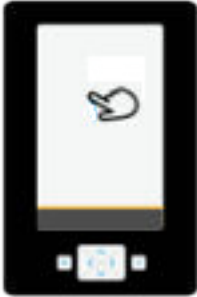
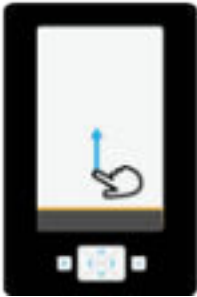
Gesture	Description
	<p>Tap.</p> <p>Tapping a menu item opens another menu. For example, you can tap a device description in the Field Communicator application and a menu is displayed.</p> <p>Press and hold.</p> <p>Some menu items have a context menu associated with them. Pressing and holding a menu item will activate the context menu. For example, pressing and holding on a menu in the Field Communicator application brings up a context menu that allows access to help, or adding the item as a favorite.</p>
	<p>Scroll down.</p>

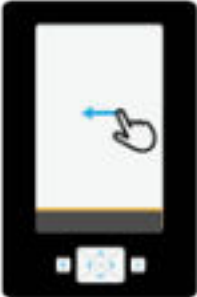
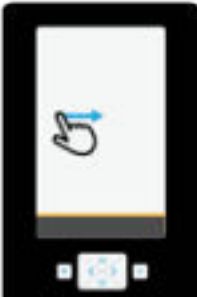
Gesture	Description
	<p>Scroll up.</p>
	<p>Scroll right. Used to move right on graph or grid, or to view additional columns/data on a screen.</p>
	<p>Scroll left. Used to move left on graph or grid.</p>

2.3.2 Enter text, numbers, or special characters

If an option requires you to enter text, the application displays a keyboard with the permitted characters. You can enter letters, numbers, punctuation, and special characters. Tap the screen or use the four arrows keys on the keypad to enter the desired characters. Tapping the Shift Key twice on the keyboard enables Shift Lock.

For screens that require passwords, text is hidden by default but can be revealed before confirming by tapping the reveal icon. 

2.3.3 Clean the touchscreen

Clean the touchscreen with a soft cloth with pH-neutral detergent or alcohol. When the touchscreen is contaminated by chemicals, immediately wipe them off with caution to avoid injury to the human body.

2.4 Back view of the Trex unit

You can access the communication module, the stand, and the power module.

Figure 2-3: Back view



- A. *Communication module*
- B. *Stand*
- C. *Power module*

Related information

[Communication modules](#)
[Replace the stand](#)
[Power module](#)

2.4.1 Serial numbers

The Trex unit has a serial number for each part, including the main unit, power module, and communication module. The label on each part lists the serial number. You may need to provide a serial number if you work with technical support.

You can view the serial number from the Settings. (Tap Settings > About > CPU Board Serial Number.) The serial number is located on the label on the bottom of the Trex unit, near the power module LEDs.

2.5 Communication modules

The Trex unit has two communication modules.

Device Communicator communication module

The Device Communicator communication module can connect to and communicate with HART and FOUNDATION fieldbus devices on an externally-powered HART loop or fieldbus segment. The Device Communicator communication module has unique terminals for both HART and FOUNDATION fieldbus devices.

Figure 2-4: Device Communicator communication module

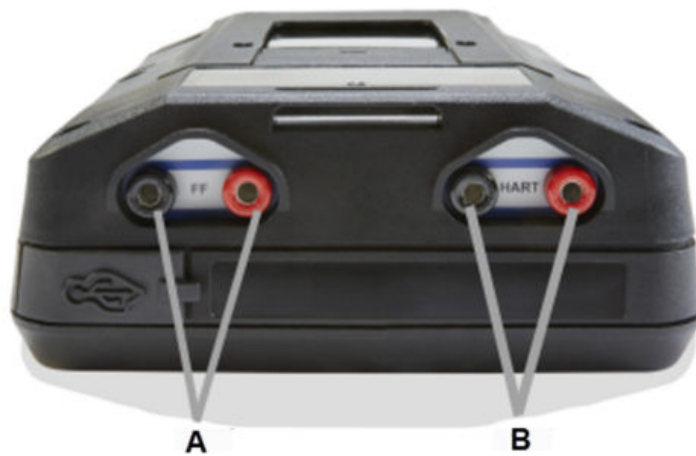

- A. Connect to externally-powered FOUNDATION fieldbus devices.
- B. Connect to externally-powered HART devices.

Device Communicator Plus communication module

The Device Communicator Plus communication module can connect to HART and FOUNDATION fieldbus devices, measure current and voltage, and power a device.

Figure 2-5: Device Communicator Plus communication module

- A. *Power a FOUNDATION fieldbus device. You need to connect the FOUNDATION fieldbus Power Plug to the FF pwr and the positive FF terminals.*
- B. *Connect to a FOUNDATION fieldbus device that is externally-powered or powered by the Trex unit.*
- C. *Measure current on a 4-20 mA current loop.*
- D. *Power and connect to a HART device. The HART+pwr terminals can measure the current output of a connected transmitter or control the current input to a connected positioner. The terminals also have a loop resistor for device communication.*
- E. *Connect to an externally-powered HART device. The HART terminals also have an optional loop resistor for enabling HART communications on 4-20 current loop and optional current control for moving a positioner.*

⚠ CAUTION!

- **Before you insert or remove a communication module, ensure the Trex unit is powered off.**
- **Ensure sufficient grounding. Ensure the personnel, working surfaces, and packaging are sufficiently grounded when handling electrostatically sensitive parts.**
- **Avoid touching the pins on the connectors or components. Discharged energy can affect the modules.**
- **When you insert/attach the communication module to the Trex unit, do not over tighten the screws. Use 0.5Nm maximum torque load.**
- **Remove the USB cable from the Trex unit before connecting to a device.**

⚠ WARNING!

- The Trex unit cannot power a 4-wire device. Do not connect Trex unit to the power terminals of a 4-wire device. This can blow a fuse inside the Trex unit. The repair/replacement will need to be completed at an authorized service center.
- Do not connect lead sets to the HART and HART + pwr terminals at the same time. If the lead sets are connected to devices, this increases the chance of wiring mistakes and could create a short in the HART loop.
- Do not add any external power to the device when the Trex unit is powering the device. This can blow a fuse inside the Trex unit. The repair/replacement will need to be completed at an authorized service center. Ensure the device is disconnected from the loop/segment and no other wires are connected to the device before providing power from the Trex unit.
- Do not use the Trex unit to power a *WirelessHART* device. Providing power to a *WirelessHART* device may damage the device.
- Do not connect the mA terminals (ammeter) in parallel with a powered 4-20 mA current loop. Ammeters have low resistance. This can disrupt the loop and cause devices to report incorrect values or positioners to move unexpectedly.
- Do not connect the mA terminals on the Trex unit to a power supply that is not current limited to 250 mA. This can blow a fuse inside the Trex unit. The repair/replacement will need to be completed at an authorized service center.

2.5.1 Ammeter on the Device Communicator Plus communication module

The Device Communicator Plus communication module has several ammeters for reading current:

1. Ammeter in the mA terminals. This ammeter is intended for quick measurements and is for reference only.
2. Ammeter in the HART + pwr terminals. This ammeter is used when the Trex unit is powering a transmitter. This ammeter is intended for tasks including digital-to-analog trims where a higher accuracy ammeter is required.
3. Ammeter in the HART + pwr and HART terminals. This ammeter is used when the Trex unit is controlling current or is powering a positioner. The ammeter is intended to give feedback on the output current from the Trex unit and is for reference only.

⚠ WARNING!

- Do not use the HART + pwr and mA terminals in series when the Trex unit powers a device.
- Do not connect the mA terminals (ammeter) in parallel with a powered 4-20 mA current loop. Ammeters have low resistance. This can disrupt the loop and cause devices to report incorrect values or positioners to move unexpectedly.
- Do not connect the mA terminals on the Trex unit to a power supply that is not current limited to 250 mA. This can blow a fuse inside the Trex unit. The repair/replacement will need to be completed at an authorized service center.

For best results when using the mA terminals, do the following:

- Avoid using the ammeter in cold or very hot temperatures. Extreme temperatures can affect the accuracy of the measurements.
- Connect the mA terminals on the Trex unit to the "low-side" of the device. See the example below.

Figure 2-6: "Low-side" ammeter connection

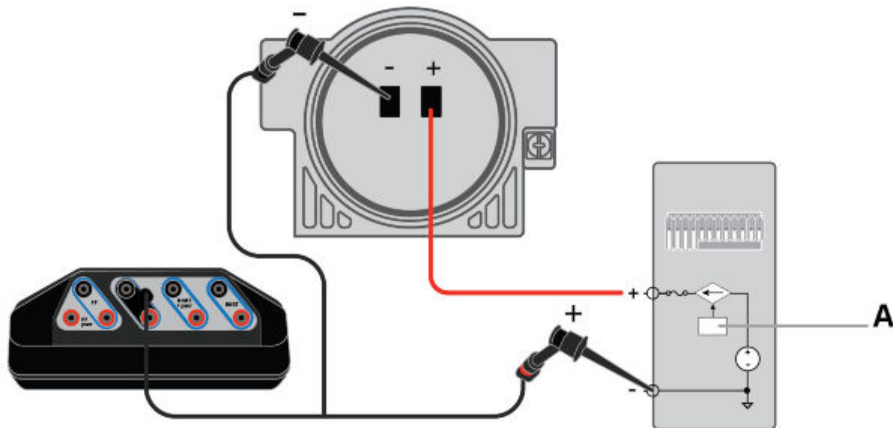

A. Analog output

2.5.2 Install a communication module

⚠ CAUTION!

- Ensure sufficient grounding. Ensure the personnel, working surfaces, and packaging are sufficiently grounded when handling electrostatically sensitive parts.
- Avoid touching the pins on the connectors or components. Discharged energy can affect the modules.
- Handle the module with care. It is possible to bend the pins on the module's connector.

Procedure

1. Turn off the Trex unit.
2. Place the Trex unit face down on a level, secure surface.
3. Place the communication module into the top of the Trex unit, and carefully align the communication module with the connector on the Trex unit.
4. Gently press the communication module until it is seated properly with the Trex unit.
5. Tighten the four screws using a screwdriver. Do not over tighten the screws. Use 0.5Nm maximum torque load.

2.5.3 Remove a communication module

⚠ CAUTION!

- **Ensure sufficient grounding.** Ensure the personnel, working surfaces, and packaging are sufficiently grounded when handling electrostatically sensitive parts.
- **Avoid touching the pins on the connectors or components.** Discharged energy can affect the modules.
- **Handle the module with care.** It is possible to bend the pins on the module's connector.

Procedure

1. Turn off the Trex unit.
2. Place the Trex unit face down on a level, secure surface.
3. Remove any connected lead sets.
4. Loosen the four screws on the module using a screwdriver.
5. Gently lift the communication module straight away from the Trex unit. Do not slide the communication module.

Figure 2-7: Trex unit with the communication module removed



2.6 Power module

A rechargeable Lithium-Ion power module powers the Trex unit. A typical charge should last for more than 8 hours of continuous use. The Trex unit displays a low-battery warning when the remaining charge reaches a set level. Ensure you save any unsent data for a device before the power module reaches a low level.

You do not need to discharge or calibrate the power module. Contact technical support if you experience any problems with the power module.

⚠ WARNING!

Do not install, remove, or charge the Lithium Ion (Li-Ion) power module in a hazardous area environment.

2.6.1 Precautions for the power module and AC adapter

Understand and follow the precautions below before using the power module or AC adapter.

- When transporting a Lithium-Ion power module, follow all applicable regulations.
- Ensure sufficient grounding. Ensure the personnel, working surfaces, and packaging are sufficiently grounded when handling electrostatically sensitive parts.
- Avoid touching the pins on the connectors or components. Discharged energy can affect the power modules.
- Protect the power module and AC adapter from moisture, and respect operating and storage temperature limits listed in the *AMS Trex Device Communicator User Guide*. The AC adapter is for indoor use only.
- Do not cover the power module or AC adapter while charging. Do not subject them to prolonged periods of direct sunlight, or place them on or next to heat-sensitive materials.
- Charge the power module with only the provided AC adapter. The AC adapter should not be used with other products. Failure to comply may permanently damage the Trex unit and void the IS approval and warranty.
- Do not open or modify the power module or AC adapter. There are no user-serviceable components or safety elements inside. Opening or modifying them will void the warranty and could cause personal harm.
- Clean the AC adapter by clearing the terminal of dirt and debris, if required.
- If the AC adapter is used in a manner not specified by Emerson, the protection provided by the equipment may be impaired.
- The AC adapter comes complete with interchangeable plug heads for countries UK, USA, EU and AU.
- The maximum operating altitude for the AC adapter is 2000 meters.

2.6.2 AC adapter

The Trex unit includes an AC adapter for recharging the power module. The Trex unit is fully operational while the AC adapter charges the power module.

⚠ WARNING!

Do not install, remove, or charge the Lithium Ion (Li-Ion) power module in a hazardous area environment.

Figure 2-8: AC adapter



Related information

[Precautions for the power module and AC adapter](#)

2.6.3 LEDs on the power module

The power module has six LEDs to indicate the charging status. Press the button next to the LEDs to illuminate the LEDs and view the current charge level.

Figure 2-9: LEDs showing approximately 100 percent charge

- A. AC adapter LED. Lights up when the AC adapter is attached to the power module. A green light indicates the power module is fully charged. An orange light indicates the power module is charging. No LED indicates the power module is not being charged.
- B. Power module LEDs. Each solid green LED indicates approximately 20 percent charge. A blinking LED indicates the power module is charging within that 20 percent range.
- C. Power module button. Press to illuminate the power module LEDs.

2.6.4 View the remaining power module charge

You can check the remaining power module charge from several places.

Procedure

1. Check the charge from the power module.
 - a. Press the power module button to illuminate the 5 LEDs.
 - b. View the LEDs. Each solid green LED indicates approximately 20 percent charge.
2. Check the charge from the Trex Home screen.
 - a. Tap Settings or the status bar at the top of the screen.
 - b. Tap More > Power Management.

The charge level is displayed.

Related information

[LEDs on the power module](#)

Status bar

2.6.5 Charge the power module

Fully charge the power module before using it in the field. The Trex unit is fully operable when the power module is charging. An overcharge condition will not occur if the AC adapter is connected after charging completes. You can charge the power module when it is attached to or detached from the Trex unit.

To maintain performance, charge the power module frequently, preferably after each use. Limit full discharges, if possible.

If you experience communication issues when working with a device, remove the AC adapter from the Trex unit.

⚠ WARNING!

Do not install, remove, or charge the Lithium Ion (Li-Ion) power module in a hazardous area environment.

Procedure

1. Plug the AC adapter into a power outlet.
2. Attach the AC adapter cable to the charger port on the lower left side of the Trex unit.

A full charge takes approximately three to four hours.

2.6.6 Install the power module into the Trex unit

⚠ CAUTION!

- **Ensure sufficient grounding. Ensure the personnel, working surfaces, and packaging are sufficiently grounded when handling electrostatically sensitive parts.**
- **Avoid touching the pins on the connectors or components. Discharged energy can affect the modules.**

⚠ WARNING!

Do not install, remove, or charge the Lithium Ion (Li-Ion) power module in a hazardous area environment.

Procedure

1. Place the Trex unit face down on a level, secure surface.
2. Align the power module with both sides of the Trex unit, and carefully place the power module onto the Trex unit.
3. Insert and tighten the four screws with a Torx® screwdriver to secure the power module. Do not over tighten the screws. Use 0.5Nm maximum torque load.

2.6.7 Remove the power module from the Trex unit

⚠ CAUTION!

- Ensure sufficient grounding. Ensure the personnel, working surfaces, and packaging are sufficiently grounded when handling electrostatically sensitive parts.
- Avoid touching the pins on the connectors or components. Discharged energy can affect the modules.

⚠ WARNING!

Do not install, remove, or charge the Lithium Ion (Li-Ion) power module in a hazardous area environment.

Procedure

1. Turn off the Trex unit.
2. Place the Trex unit face down on a level, secure surface.
3. Use a Torx® screwdriver to loosen the four screws on the power module. The screws do not need to be fully removed.
4. Gently lift the power module straight away from the Trex unit. Do not slide the power module.

Figure 2-10: Trex unit with the power module removed



2.6.8 Maintain the power module

To help maintain the performance and life of the power module, understand and follow the guidelines below:

- Recharge the power module frequently, preferably after each use or at night. Limit the number of full discharges, if possible.
- Avoid frequent use at high temperatures because this can reduce performance.

- Use a dry location at or near room temperature when storing the power module for an extended time. Prolonged storage at higher temperatures can reduce performance.
- Ensure the remaining charge level is at or near mid-capacity when storing for an extended time. The remaining charge will slowly drain during storage. Periodically charge the power module to ensure the remaining charge does not drain to low levels.

2.7 Accessories

The Trex unit includes the following accessories:

- Lead set.
- A FOUNDATION fieldbus Power Plug to enable the Trex unit to power a FOUNDATION fieldbus device.
- A USB cable to connect the Trex unit to PC applications.
- AC adapter.
- A handstrap that can be connected to either side of the Trex unit.

2.7.1 Cables and lead sets

The Trex unit comes with a lead set so it can connect to a device. The lead set attaches to one set of terminals on the top of the Trex unit. The positive lead is marked with a red band near the banana jacks.

Note

When you remove the lead set from the Trex unit, do not pull on the cable. Grab the plug/connectors and remove the lead set from the terminals.

The Trex unit may also include the FOUNDATION fieldbus Power Plug, which is used to power one FOUNDATION fieldbus device. Use the FOUNDATION fieldbus Power Plug with the Device Communicator Plus communication module. The plug attaches to the FF pwr terminal and the positive FF terminal on top of the lead set.

Figure 2-11: FOUNDATION fieldbus Power Plug



Figure 2-12: FOUNDATION fieldbus Power Plug attached to the Trex unit

2.7.2 Carrying case for the Trex unit

A carrying case is available for the Trex unit to hold it and store lead sets, the AC adapter, and other accessories. The case has several compartments and a shoulder strap.

When transporting or carrying the Trex unit in the case, ensure the face plate on the case is closed. This protects the touchscreen from unexpected contact with other objects.

Note

Ensure the carrying case is clean. Otherwise, this can affect the strength of the connection on the strap or faceplate. When carrying the Trex unit in high places, use the hand strap.

The bottom compartment on the carrying case opens so you can store the AC adapter with the Trex unit.

Figure 2-13: The carrying case



2.8 Power on or off

1. To power on, press and hold the power button on the upper left side of the Trex unit for one second.
2. To power off, do one of the following:
 - Quickly press the power button, and then tap Turn Off.
 - Tap Settings or the status bar at the top of the screen, and tap More > Power Management > Turn off.

2.8.1 Reboot

1. Tap Settings or the status bar at the top of the screen.
2. Tap More > Power Management > Reboot.

2.8.2 Hard shut down

If the Trex unit is unresponsive, do a hard shut down and then restart the Trex unit. Do not use this as your normal shut down method. Contact technical support if you need to repeatedly use the hard shut down.

Procedure

Press and hold the power button for 12 seconds.

The Trex unit shuts down.

2.9 Home screen

The Home screen appears after you power on the Trex unit. The Home screen displays the installed applications and the status bar at the top of the screen. The Home screen may display one or more of the applications listed below.

Figure 2-14: Home screen

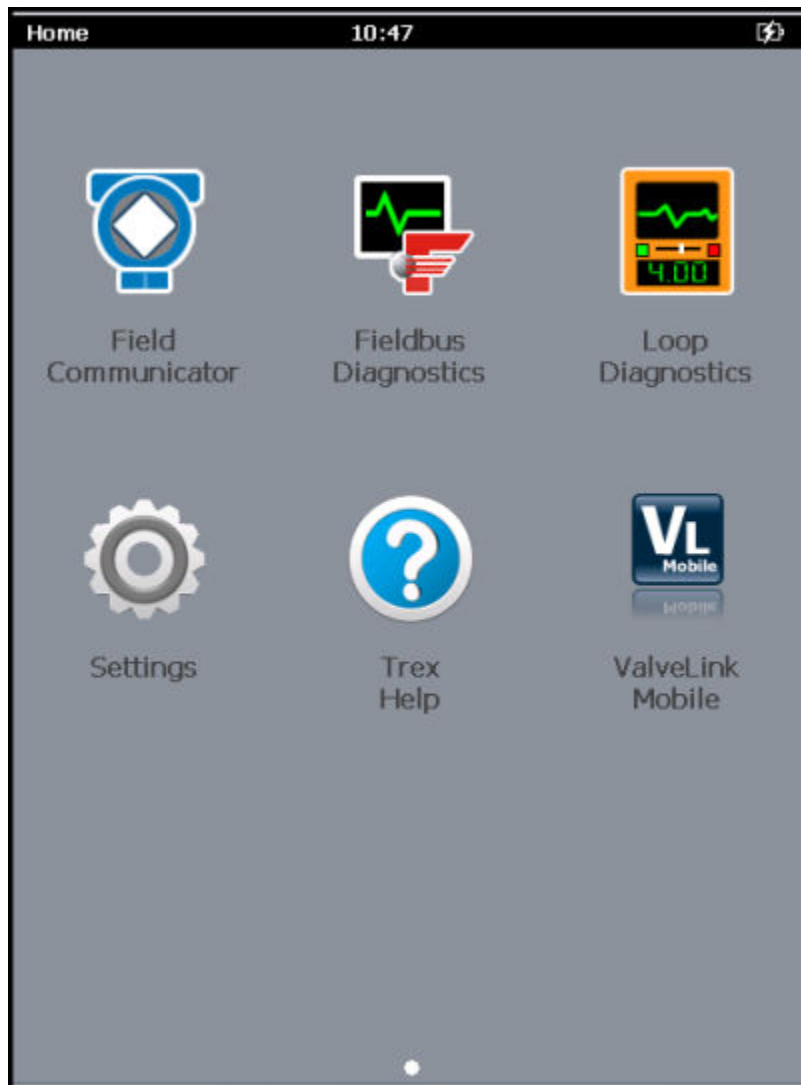

Application	Description
Field Communicator	Connect to and configure HART or FOUNDATION fieldbus devices. The Trex unit can also power one HART or FOUNDATION fieldbus device.
Fieldbus Diagnostics	Measure the DC voltage, the noise, and the signal on a FOUNDATION fieldbus segment. The Trex unit can also power one FOUNDATION fieldbus device.
Loop Diagnostics	Measure loop current and voltage, control current, and power a HART device.
Settings	View and adjust settings for the Trex unit.
Trex Help	View help topics that describe the hardware and applications on the Trex unit.

Application	Description
ValveLink Mobile	Run valve diagnostics for HART and FOUNDATION fieldbus Fisher FIELDVUE digital valve controllers. You can not power a valve using ValveLink Mobile, but you can transfer the ValveLink Mobile diagnostic files to a PC using the Trex File Transfer Utility included with the Upgrade Studio install.

Related information

Status bar

2.9.1 Return to the Home screen

If an application is open, you can return to the Home screen without exiting the application.

Procedure

1. Tap the status bar at the top of the screen.
2. Tap Home.

2.9.2 Status bar

The status bar lets you access settings and view information about the Trex unit. The status bar is displayed on the Home screen and in applications.

The status bar displays the following:

- Title of the screen (Home)
- Time
- Paired icon
- Wireless icon
- Power module icon

Figure 2-15: Status bar

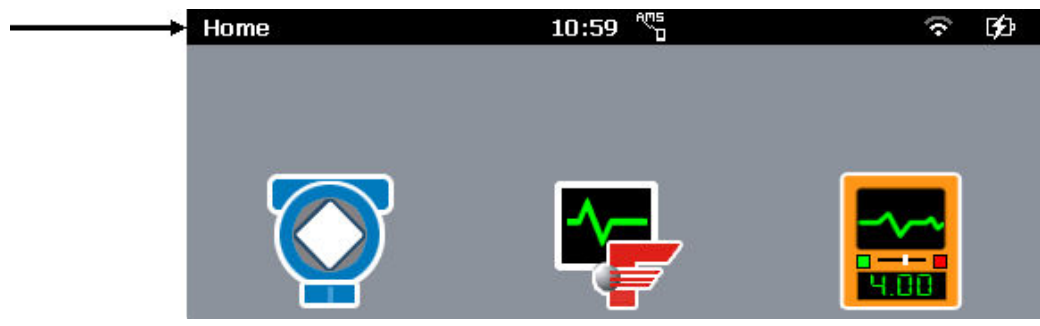

Related information*Shortcut bar*

2.9.3 Shortcut bar

The shortcut bar lets you access additional settings for the Trex unit and the Field Communicator application.

To view the shortcut bar, tap Settings on the Home screen or tap the status bar.

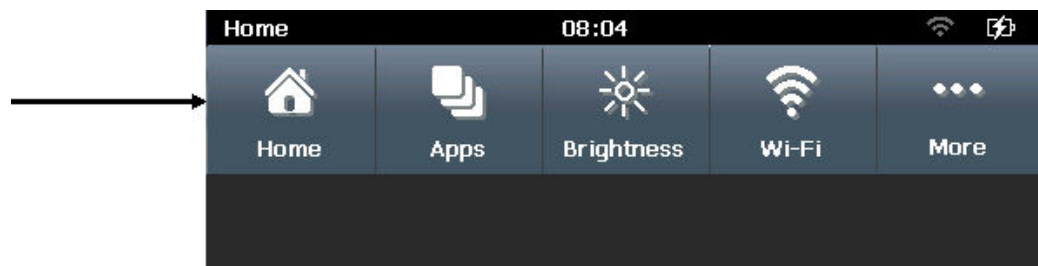
Figure 2-16: Shortcut bar

Option	Description
Home	Close the shortcut bar and return to the Home screen.
Apps	View the open applications or close an application.
Brightness	Adjust the screen brightness.
Wi-Fi	Configure wireless settings.
More	Access additional menu options and settings, including power management, date and time, and touchscreen calibration. You can also modify settings for the Field Communicator application.

2.10 Settings

The Settings option lets you view information about the Trex unit hardware and modify settings for the Trex unit and applications. To view and modify settings, tap Settings on the Home screen or the status bar at the top of the screen to view the shortcuts menu. You can set the following:

- Screen brightness
- Wi-Fi connection
- A name for the Trex unit
- Date and time
- Screen calibration
- Language

- Power management options
- AMS Device Manager Sync
- Field Communicator application settings
- Platform Communications

2.10.1 View all open applications

You can have multiple applications open at one time. However, some applications may not be able to run simultaneously because they use the same Trex hardware. (An error message is displayed when this occurs.)

Procedure

1. Tap Settings or the status bar at the top of the screen.
2. Tap Apps.

All open applications are displayed.

2.10.2 Close an application

You can close an application by tapping Exit in the application, or you can use the Settings to close it.

Procedure

1. Tap Settings or the status bar at the top of the screen.
2. Tap Apps.

All open applications are displayed.

3. Select the X next to the application name.

2.10.3 Change the screen brightness

1. Tap Settings or the status bar at the top of the screen.
2. Tap Brightness.
3. Use the slider to change the brightness.





2.10.4 Wireless communication

The Trex unit can connect to wireless networks to synchronize data on AMS Trex with AMS Device Manager. You can enable or disable wireless communication at any time.

When the wireless radio is turned on, the wireless icon displays in the status bar. The Wi-Fi option in Settings displays a list of wireless networks in range, as well as the ability to specify an IP address, if your network does not contain a DHCP server to automatically assign an IP address to the Trex unit. You can specify an IP address and a subnet mask, if required. Contact your network administrator for details.

Note

The Trex unit cannot connect to a wireless network that requires you to enter log in information on a website.

Icon	Meaning
	(status bar only) Wireless is turned on, but the Trex unit is not connected to a network.
	Wireless is enabled and the Trex unit is connected to a network with a strong signal. The icon changes based on the signal strength.
	Wireless network requires authentication to connect.
	The currently connected network

Individual wireless networks in-range, or previously connected, will appear on the Wireless Networks screen. You can view the network SSID, security, profile (whether network configuration has been saved for future use), signal strength, and current connection status.

You can disconnect from a wireless network by sliding Wireless Networks to off, connecting to another network, or choosing Forget on a connected Wireless network.

Related information

[Enable or disable wireless communication](#)

[Connect the Trex unit to a broadcasting wireless network](#)

[Connect the Trex unit to a non-broadcasting wireless network](#)

[Enter a network address for an AMS Trex unit](#)

[Forget a wireless network](#)

Enable or disable wireless communication

1. Tap Settings or the status bar at the top of the screen.
2. Tap Wi-Fi.
3. Tap the Wireless Networks option to enable or disable wireless.

Connect the Trex unit to a broadcasting wireless network**Note**

The Trex unit cannot connect to a wireless network that requires you to enter log in information on a website.

Procedure

1. Tap Settings or the status bar at the top of the screen.
2. Tap Wi-Fi.

3. Ensure the Wireless Networks option is set to ON.
The wireless communication is enabled.
4. Tap the network you want to connect to. You can tap to the right or left of the network name.
5. Tap Connect, and enter credentials if prompted.
Once connected, a checkmark is displayed next to the name of the network to show it is connected to the network. The wireless icon in the status bar changes to .

Connect the Trex unit to a non-broadcasting wireless network

You can connect to a wireless network that is non-broadcasting by manually entering required options when in range.

Procedure

1. Tap Settings or the status bar at the top of the screen.
2. Tap Wi-Fi.
3. Ensure the Wireless Networks option is set to ON.
This enables the wireless radio in the Trex unit.
4. Tap Add Wi-Fi Network...
5. Edit the following options as needed. You may need assistance from your network administrator.

Option	Description
Network SSID	The name of the wireless network.
Security	The type of security used for the wireless network.

6. Tap Connect.
Depending on the network security, you may need to enter credential information when the network is in range.

Enter a network address for an AMS Trex unit

You can specify how an AMS Trex unit connects to your network. Enter DHCP to allow a network address to be assigned, or Static to specify an IP address and/or Subnet Mask.

Contact your network administrator before changing settings. Ensure the port you are sending to is configured to receive AMS Trex data.

Procedure

1. Tap Settings.
2. Tap Wi-Fi, and turn on Wireless Networks.
3. Tap IP Address, and tap the IP Address Assignment line to change from DHCP to Static.
4. Enter an IP Address, and/or Subnet Mask.
5. Tap OK.

Forget a wireless network

Forgetting a wireless network prevents the Trex unit from automatically reconnecting to it. You can forget a network to which you are currently connected, or one where you have entered credentials.

Procedure

1. Tap Settings or the status bar at the top of the screen.
2. Tap Wi-Fi, then tap the network.
3. Tap Forget.

The network disconnects. If there is data that has not been synchronized with AMS Device Manager, you are prompted to confirm before disconnecting.

Change the default connection port

AMS Trex communicates with wireless networks at port 8081. If your network uses this port or restricts access to it, AMS Trex may not be able to communicate with the network. Contact your network administrator for details.

Procedure

1. Tap Settings > Platform Communications.
2. Tap to change the default, and enter a port number.

Postrequisites

If you change the default port for one AMS Trex unit, Emerson recommends setting all AMS Trex units to exchange data on that port. All AMS Device Manager stations that synchronize with AMS Trex units must also have the same port number. See AMS Device Manager Release Notes for details on changing port settings on the PC.

2.10.5 View information about the Trex hardware and operating system

You can view the information about the Trex unit, including the name, serial number, operating system, open-source licenses, and the MAC address.

Procedure

1. Tap Settings or the status bar at the top of the screen.
2. Tap More > About.
3. Tap OK.

2.10.6 Enter a name for the Trex unit

You can enter a name to uniquely identify the Trex unit. This is helpful if you have multiple Trex units at your site. By default, the Trex unit is named "TrexXXXXXXXXXXXX" where the Xs are the serial number. This name is displayed in applications like Upgrade Studio.

Procedure

1. Tap Settings or the status bar at the top of the screen.
2. Tap More > About.
3. Tap Name.
4. Enter a new name up to 20 characters.
5. Tap OK.

2.10.7 View the application version number

You can view the version numbers for all the installed applications.

Procedure

1. Tap Settings or the status bar at the top of the screen.
2. Tap More > Installed Applications.

The version numbers for all installed applications are displayed.

3. Tap Back to close the screen.

2.10.8 Set the time and date

Note

When you connect the Trex unit to a PC or a wireless network, the Trex unit updates to use the same time as the PC or wireless network.

Procedure

1. Tap Settings or the status bar at the top of the screen.
2. Tap More > Date & Time.
3. Edit the following options as needed.

Option	Description
Auto adjust daylight savings	Enable or disable the Trex unit from automatically adjusting the time for daylight saving time.
Date	Enter the date.
Date Format	Select the format for the date. You can select DD/MM/YYYY or YYYY/MM/DD.
Time	Enter the time.
Time Format	Select the 12 hour or 24 hour format.
Time Zone	Select the time zone.

4. Tap OK.

2.10.9 Calibrate the touchscreen

If the touchscreen seems inaccurate, you can recalibrate it.

Procedure

1. **Note**
If your Trex unit is unresponsive to the touch screen, you can navigate to this menu with the arrow keys, then initiate the calibration.
- Tap Settings or the status bar at the top of the screen.
2. Tap More > Display > Calibrate touch screen.
 3. Tap the screen as indicated.

2.10.10 Set the language on Trex

Changing the display language requires the AMS Trex unit to be rebooted. Make sure you have no outstanding changes before changing the display language.

Procedure

1. Tap the toolbar at the top of the screen.
2. Tap More > Language.
3. Select a language, and tap OK.

The AMS Trex unit reboots and the new language is displayed. Not all applications support all available languages. The Trex unit does not support entering characters in non-Latin languages.

2.10.11 View the amount of available memory

1. Tap Settings or the status bar at the top of the screen.

2. Tap More > Memory Management.

2.10.12 Power management

You can configure options to conserve power usage.

Power management option	Description
Dim Display (Backlight) timer	Dim the backlight after a period of inactivity.
Suspend timer	Turn off the backlight after a period of inactivity. Device communication and power are not interrupted.
Shut down timer	Shut down the Trex unit after a period of inactivity.

When the AC adapter is connected to the power module, all the timers are disabled.

Note

The timers are cumulative. For example, if you set the Dim Display (Backlight) timer to 5 minutes, the Suspend timer to 5 minutes, and the Shut Down timer to 5 minutes, the Trex unit enters suspend after 10 minutes and shuts down after 15 minutes of inactivity.

Enter or exit suspend mode

Suspend mode is similar to standby mode on a phone. The screen is turned off, but all connectivity is maintained. If the Trex unit is powering a device before entering suspend, it continues to power and communicate with the device. If a Trex unit is connected to a network, it remains connected in suspend mode. You can put the Trex unit in suspend mode, or wait for the suspend timer to expire.

When in suspend mode, the Trex unit shuts down if there is no activity (key presses) after a specified amount of time. Use the Turn off after option on the Power Management screen to specify this time.

Procedure

1. To enter suspend, do one of the following:
 - Quickly press the power button, and then tap Suspend.
 - Tap Settings or the status bar at the top of the screen, and tap More > Power Management > Suspend.
 - Wait until the suspend timer expires.

Note

The timers are cumulative. For example, if you set the Dim Display (Backlight) timer to 5 minutes, the Suspend timer to 5 minutes, and the Shut Down timer to 5 minutes, the Trex unit enters suspend after 10 minutes and shuts down after 15 minutes of inactivity.

2. To leave suspend, quickly press the power button or tap the touchscreen.

Related information

[Set the suspend timer](#)

Set the backlight timer

To conserve power, set the backlight timer to automatically dim the backlight after a specified period of inactivity.

The timer is enabled only when the AC adapter is not connected to the Trex unit.

Procedure

1. Tap Settings or the status bar at the top of the screen.
2. Tap More > Power Management > Dim display after.
3. Select the number of minutes.
The default is one minute.
4. Tap OK.

Set the suspend timer

To conserve power, set the suspend timer to automatically enter suspend mode after a period of inactivity, such as no key presses. Suspend is similar to the standby mode on a phone. The Trex unit shuts down if there is no activity (key presses) after a specified amount of time. Use the shut down timer to specify this time.

The timer is enabled only when the AC adapter is not connected to the Trex unit.

Note

The timers are cumulative. For example, if you set the Dim Display (Backlight) timer to 5 minutes and the Suspend timer to 5 minutes, the Trex unit enters suspend after 10 minutes.

Procedure

1. Tap Settings or the status bar at the top of the screen.
2. Tap More > Power Management > Suspend after.
3. Select the number of minutes.
The default is 5 minutes.
4. Tap OK.

Set the shut down timer

To conserve power, set the shut down timer to automatically shut down the Trex unit after a period of inactivity, such as no key presses or taps on the screen.

The timer is enabled only when the AC adapter is not connected to the Trex unit.

Note

The timers are cumulative. For example, if you set the Dim Display (Backlight) timer to 5 minutes, the Suspend timer to 5 minutes, and the Shut Down timer to 5 minutes, the Trex unit enters suspend after 10 minutes and shuts down after 15 minutes of inactivity.

Procedure

1. Tap Settings or the status bar at the top of the screen.
2. Tap More > Power Management > Turn off after.
3. Select the number of minutes.
The default value is set to Never.
4. Tap OK.

2.10.13 Enable or disable automatically connecting to HART devices

If this option is enabled, the Field Communicator application searches for and automatically connects to an externally-powered HART device at address zero and displays its device menu. This makes the connection process faster. If this option is disabled, the Field Communicator application polls addresses zero and 63 and displays the Device List, so you can select a device from the list or change polling options from the My Device Not Found button.

You may want to disable this option in the following situations:

- The Trex unit is connected to a multi-drop HART loop, and you want to configure a device at another address.
- The Trex unit is connected to a transmitter at address zero with a THUM adapter. Otherwise, the Trex unit may automatically connect to the transmitter at address zero, and would not allow you to connect to the THUM adapter.
- You want to configure multiple THUM adapters and do not want to adjust the polling option.

Procedure

1. Tap Settings or the status bar at the top of the screen.
2. Tap More > Field Communicator App Settings.
3. Tap Auto-Connect to enable or disable the option.
4. Tap OK.

2.10.14 Enable Diagnostic Logging

Note

You should only enable Diagnostic Logging when directed by Emerson service personnel.

From Settings > Field Communicator App Settings tap Diagnostic Logging to ON.

2.11 Applications on the Trex unit

The Home screen displays all the applications installed on the Trex unit. Open applications by tapping the icon on the Home screen.

Field Communicator, Settings, and Trex Help applications do not require activation to work. Other applications on the Trex unit may be disabled until you activate the Trex unit. You can use Upgrade Studio to activate the Trex unit. Other applications may be disabled because you did not purchase a license for the functionality, or the Trex unit does not have the required communication module.

You can run some applications simultaneously on the Trex unit, while other applications may require the same hardware and cannot run at the same time. An error message is displayed on the screen when that occurs. Applications, such as the Field Communicator application and Settings, can run simultaneously. To switch between applications that can run simultaneously, tap the status bar at the top of the screen and tap Apps. You can then select the open application you want to view and use.

You can purchase new applications or get updates to applications from Upgrade Studio. See the Upgrade Studio Help for more information.

Related information

[Home screen](#)

[View the application version number](#)

2.11.1 Activation

After you receive the Trex unit, it is recommended that you activate it using Upgrade Studio. Activation allows you to receive and install updated content on the Trex unit, as well as give you access to additional applications. Some applications may require you to purchase a license.

A reminder message is displayed each time you power on the Trex unit until activation is completed.

2.11.2 Close an application

You can close an application by tapping Exit in the application, or you can use the Settings to close it.

Procedure

1. Tap Settings or the status bar at the top of the screen.
2. Tap Apps.

All open applications are displayed.

3. Select the X next to the application name.

2.12 USB communication

The Trex unit supports USB communication with PCs. The Trex unit has a micro USB port on the top left corner of the unit. The required USB driver is automatically installed with Upgrade Studio and AMS Device Manager. You can:

- transfer files to the Trex unit, using Upgrade Studio
- pair the Trex unit with an AMS Device Manager system to synchronize data

To help ensure proper communication between the Trex unit and the PC, do not use a USB 2.0 cable that is longer than 2 meters. Do not connect more than one Trex unit to an AMS Device Manager station at one time.

⚠ CAUTION!

Remove the USB cable from the Trex unit before connecting to a device. Do not use USB communication in a hazardous area.

2.13 Synchronizing AMS Trex data with AMS Device Manager

AMS Trex provides the ability to connect to AMS Device Manager and update the AMS Device Manager database with device data. The initial operation that enables this is a pairing of an AMS Trex unit with a single AMS Device Manager station.

By default, synchronization happens automatically when AMS Trex is connected to a paired AMS Device Manager station using USB, or when it is connected to a Wi-Fi network that can communicate with an AMS Device Manager Server Plus. Synchronization occurs when the devices match in both systems (by manufacturer, device type, device revision, and protocol version).

Note

AMS Trex cannot communicate wirelessly with an AMS Device Manager system whose ServerPlus name is not a valid hostname (for example, named with an IP address).

In the AMS Device Manager Sync screen in Settings, AMS Trex shows:

- The name of the AMS Device Manager station to which the unit is paired, along with an option to unpair. A Trex unit can only be paired with one AMS Device Manager system at a time.
- An indication of whether data is pending to be synchronized to AMS Device Manager
- The time of the last synchronization

After a Trex unit has been paired to an AMS Device Manager system, synchronization happens automatically when:

- A Trex unit is connected to the AMS Device Manager station by USB OR
- A Trex unit wireless radio is on, and is connected to a wireless access point

Note

AMS Device Manager will synchronize with as many paired AMS Trex units as are connected to wireless, and in-range. An Audit Trail entry indicates each pairing, unpairing, and synchronization with a specific Trex unit.

Related information

[Synchronize AMS Trex data to AMS Device Manager using USB](#)

2.13.1 Synchronize AMS Trex data to AMS Device Manager using USB

Prerequisites**⚠ CAUTION!**

Remove the USB cable from the Trex unit before connecting to a device. Do not use USB communication in a hazardous area.

AMS Device Manager is licensed to communicate with AMS Trex.

AMS Device Manager is paired with the AMS Trex Device Communicator being synchronized.

Procedure

1. Connect the micro-USB end of the cable to the AMS Trex unit.
2. Connect the USB to the AMS Device Manager station.

AMS Trex begins downloading Audit Trail events to the AMS Device Manager Audit Trail.

Note

If the AMS Trex unit Wireless is turned on and connected to a network containing the paired AMS Device Manager station, you do not need to sync using USB. Any data that is new since the last synchronization will automatically connect and download to the AMS Device Manager database.

2.13.2 Pair an AMS Trex unit with an AMS Device Manager station

⚠ CAUTION!

Remove the USB cable from the Trex unit before connecting to a device.

⚠ CAUTION!

Do not use USB communication in a hazardous area.

Prerequisites

The user pairing the AMS Trex unit to AMS Device Manager must have the Manage Connections permission in User Manager.

AMS Device Manager is running, and the Device Explorer or Device Connection View is displayed. Pairing can only be done from the AMS Device Manager station, not from the Trex unit. Only one concurrent USB connection to an AMS Device Manager station is supported.

Procedure

1. Connect the microUSB cable to the AMS Trex unit, and then connect the USB to an AMS Device Manager station.
2. In AMS Device Manager, expand the AMS Trex Units node to display a list of AMS Trex units.
3. Right-click the unpaired icon, and select Pair Trex Unit.

The icon changes to indicate the unit is paired, and an Audit Trail event is created to indicate the pairing.

Related information

[Unpair an AMS Trex unit](#)

2.13.3 Unpair an AMS Trex unit

You can unpair a Trex unit from the AMS Device Manager software or from the Trex unit. To assure device data is not lost, you should unpair from the AMS Device Manager UI.

Unpair from an AMS Device Manager station

From AMS Device Manager, connect the microUSB to the Trex unit, and then connect the USB to an AMS Device Manager system where it is currently paired. Right-click the unit and choose Unpair Trex Unit.

Pairing an AMS Trex unit to another AMS Device Manager station will also unpair it from the current station.

Unpair from an AMS Trex unit

If you are unable to unpair from the AMS Device Manager station, you can also unpair from the Trex unit itself:

Procedure

1. Connect the microUSB to the Trex unit, and then connect the USB to an AMS Device Manager system where it is currently paired.
2. On the AMS Trex unit, tap Settings or the status bar at the top of the screen.

3. Tap More > AMS Device Manager Sync.
4. Tap X.

You will be prompted to confirm unpairing. If any data is in the process of synchronizing, it will be lost. If the AMS Trex unit is not connected to AMS Device Manager when unpairing, any data on the unit will be lost when re-connected.

Note

Pairing a Trex unit is only done from an AMS Device Manager station.

Related information

[Pair an AMS Trex unit with an AMS Device Manager station](#)

2.14 Upgrade Studio

Upgrade Studio is a PC application that lets you update the Trex units at your site with new/updated device descriptions, applications, firmware, and operating systems. You can download the updates to Upgrade Studio, or you can import the updates into Upgrade Studio from a DVD or other physical media, network, or local drive. (You can use Upgrade Studio with or without an internet connection.)

After the updates are downloaded or imported into Upgrade Studio, you can transfer and install the updates onto the connected Trex unit.

Upgrade Studio also provides a link to a website where you can purchase new applications, accessories, or Trex units or identify the sales channel for your area.

Upgrade Studio lets you:

- Create and use your Trex online user account to activate the Trex unit, download updates, view support contract information, or access the online store, if it is available in your area.
- Activate the Trex unit. (Activation is required to install updates and access additional features.)
- Download new or updated device descriptions, applications, firmware, and operating systems for the Trex unit.
- Import new or updated device descriptions, applications, firmware, and operating systems for the Trex unit into Upgrade Studio. Use the Import option if the PC does not have an internet connection and cannot download updates. (You can also import Trex synchronization files or updates to Upgrade Studio.)
- Transfer and install the updates onto the Trex unit.
- Download and install a newer version of Upgrade Studio.
- View the files that are installed on the Trex unit and additional information about the Trex unit.

If you do not have access to a DVD drive to install Upgrade Studio, visit the support page to download the software. (<http://www2.emersonprocess.com/en-US/brands/Field-Communicator/Pages/support.aspx>)

2.14.1 Connect the Trex unit to Upgrade Studio using USB

Prerequisites

⚠ CAUTION!

Remove the USB cable from the Trex unit before connecting to a device. Do not use USB communication in a hazardous area.

Upgrade Studio cannot connect to multiple Trex units at one time. Only one connection via USB is supported.

To help ensure proper communication between the Trex unit and the PC, do not use a USB 2.0 cable that is longer than 2 meters.

Procedure

1. Ensure the Trex unit is powered on.
2. Connect the microUSB cable to the top of the Trex unit, and then to the PC where Upgrade Studio is installed.

Note

The USB driver is installed when you install Upgrade Studio.

3. In Upgrade Studio, click Activate Units or Install Updates.
4. If you do not see the Trex unit, select Show All Trex units from the drop-down bar.

Upgrade Studio connects to the Trex unit and the  icon appears on the screen.

2.14.2 Create a Trex online user account

Upgrade Studio provides a link to a website to create a user account. You need a user account to:

- Activate the Trex unit. (A user account is needed for activation when Upgrade Studio has an internet connection.)
- Download updates for the Trex unit or Upgrade Studio.
- View the support contract information for the Trex unit.
- Access the Trex online store, if it is available in your area.

Procedure

1. In Upgrade Studio, click Login > Create an Account.
A web browser opens.
2. Enter your information.
3. Click Submit.
4. Wait for notification via email that the user account is available.
5. Follow any additional steps described in the notification email.

2.14.3 Activate the Trex unit

The Trex unit displays an activation reminder message each time you power on the Trex unit until it is activated. Activation enables the full functionality on the Trex unit and associates the Trex unit with your user account/company.

Upgrade Studio can activate the Trex unit with or without an internet connection. The procedure below is for PCs with an internet connection.

Prerequisites

Create a user account in Upgrade Studio.

Procedure

1. Connect the Trex unit to the PC where Upgrade Studio is installed.
2. In Upgrade Studio, click Activate Units.
3. Click Login.
4. Enter your username and password, if prompted, and click Login.

Logging in enables Upgrade Studio to retrieve the correct activation code for the Trex unit. If you do not log in, you need to click the "Don't have an activation code?" link to request an activation code. When you receive the activation code, enter or copy/paste the code onto the Activate Units screen.
5. Click the Trex unit displayed on the left side of the screen.
6. Click Activate.

A message confirming the activation was successful is displayed.

2.14.4 Activate the Trex unit without using an internet connection

Prerequisites

To activate the Trex unit without using an internet connection, request an activation code by emailing Emerson at WWCS.CustServ@emerson.com or calling 888-367-3774 option 2 (U.S. and Canada) or +63.2.702.1111 (worldwide) and providing the serial number. The

serial number is located on the bottom of the Trex unit, but you can also access the serial number by connecting the Trex unit to Upgrade Studio and then hovering the cursor over the Trex unit icon.

Procedure

1. Connect the Trex unit to the PC where Upgrade Studio is installed.
2. In Upgrade Studio, click Activate Units.
3. Click the connected Trex unit that is displayed on the left side of the screen.
4. Enter or copy/paste the activation code you received.
5. Click Activate.
A message confirms the activation was successful.
6. Click More > Export.
7. Under Trex Synchronization Files, click Show Details.
8. Select one or more Trex synchronization files to export.
9. Click Export.
10. Select a location to save the Trex synchronization file, and click OK.
11. If you are not using the air-gap deployment, email the exported Trex synchronization file to Emerson at WWCS.CustServ@emerson.com.
12. If you are using the air-gap deployment, do the following:
 - a. Open Upgrade Studio on the PC that has an internet connection.
 - b. Transfer the Trex synchronization file to that PC.
 - c. Click More > Import Package.
 - d. Browse to the location that has the Trex synchronization file, and click OK.
 - e. Click Import.
 - f. Click OK.
 - g. Log in with your username and password. Upgrade Studio uploads the Trex synchronization file.

2.15 Transferring log files to a PC

When you install Upgrade Studio, the Trex File Transfer Utility is also installed. This application lets you transfer log files from the Fieldbus Diagnostics application or ValveLink Mobile to a PC. Use the USB cable to connect the Trex unit to the PC where the application installed. See the Help included with Upgrade Studio for more information.

2.16 Maintenance and repair

Any maintenance, repair, or replacement of components not listed below must be performed by specially trained personnel at an authorized service center. You can perform common maintenance procedures listed below:

- Clean the exterior. Use only a dry, lint-free towel or dampen the towel with an alcohol or mild soap and water solution.
- Clean the touchscreen.
- Install, remove, or charge the power module.
- Remove and replace the stand.
- Ensure that all exterior screws are sufficiently tightened.
- Ensure the communication terminal recess is free of dirt and debris.
- Install and remove the communication module.

2.16.1 Replace the stand

1. Place the Trex unit face down on a level, secure surface.
2. Lift up the stand.
3. Use a Torx® screwdriver to loosen and remove the two screws under the stand.
4. Remove the stand.
5. Place the new stand on the Trex unit.
6. Insert and tighten the two screws. Do not over tighten the screws. Use 0.5Nm maximum torque load.

2.16.2 Calibration

Calibration is not supported on the AMS Trex Device Communicator. Voltage, current, signal, and noise measurements made by the Trex unit are intended for troubleshooting purposes. NIST standards are not applicable to the AMS Trex Device Communicator.

3 Field Communicator application

Topics covered in this chapter:

- *Open or close the Field Communicator application*
- *Device interoperability*
- *Forward Compatibility rules for saving and sending configurations to AMS Trex*
- *Automatically detect a device*
- *Connect - Select screen*
- *Device connection wizard*
- *Status when detecting a device*
- *Online menu or Device Dashboard*
- *Icons on the device menus*
- *Connections to HART devices*
- *Internal resistors*
- *Power and connect to a HART device*
- *Connect to an externally-powered HART device*
- *Online HART devices*
- *Offline HART configurations*
- *Favorites*
- *Polling options for HART devices*
- *Connections to FOUNDATION fieldbus devices*
- *Power and connect to a FOUNDATION fieldbus device*
- *Connect to an externally-powered FOUNDATION fieldbus device*
- *Online FOUNDATION fieldbus devices*
- *Simulate a live device*
- *View the device descriptions on the Trex unit*
- *View the device description information*
- *View Help for a device parameter*
- *Graphics*
- *Disconnect a device*

The Field Communicator application lets you configure HART and FOUNDATION fieldbus devices. (The fieldbus functionality requires a license.) You can do the following:

- Power and connect to a HART transmitter, if the Trex unit has the Device Communicator Plus communication module. The Trex unit has an internal resistor, so you do not need to add a loop resistor.

- Power and connect to a HART positioner, if the Trex unit has the Device Communicator Plus communication module.
- Power and connect to the Smart Wireless THUM™ Adapter, if the Trex unit has the Device Communicator Plus communication module.
- Power and connect to a FOUNDATION fieldbus device, if the Trex unit has the Device Communicator Plus communication module. The Trex unit provides power, power conditioning, and two terminators.
- Connect to an externally-powered HART or FOUNDATION fieldbus device.
- Use the internal resistors in the Trex unit when connecting to an externally-powered HART transmitter. The internal resistors in the Trex unit temporarily convert an externally-powered 4-20 mA current loop into a HART loop.
- Save menu items from HART devices to a list of favorites for quick access.
- Simulate a HART or FOUNDATION fieldbus device.

Note

The Field Communicator application can be used with the Device Communicator communication module or Device Communicator Plus communication module. However, the Trex unit cannot power a HART or FOUNDATION fieldbus device with the Device Communicator communication module.

3.1 Open or close the Field Communicator application

1. To open the application, tap the Field Communicator icon on the Trex Home screen.

The Auto-Detect screen is displayed while the Field Communicator application tries to detect a connected device. If you tap Cancel on the Auto-Detect screen, the Field Communicator application stops checking for devices and displays the Connect - Select screen.
2. To close the application, tap Exit if the Connect - Select screen is displayed. Otherwise, tap Back until that screen is displayed.

3.2 Device interoperability

The Trex unit communicates with many HART and FOUNDATION fieldbus devices independent of device manufacturer by using Electronic Device Description Language (EDDL) technology.

Basic testing is performed on all device descriptions. New device descriptions are available from the Upgrade Studio application or the resource DVD.

3.3 Forward Compatibility rules for saving and sending configurations to AMS Trex

Note

Do not edit configurations on the AMS Trex unit while connected to Configuration Management.

You can edit offline configurations on the Trex unit according to forward compatibility rules:

- To edit a configuration with Trex, you must have the proper device description installed on Trex. The installed device description must match the device type and device revision of the configuration. If the configuration does not exactly match the device description on the Trex unit, you cannot save the configuration.
- To send a configuration to a device, you must have the proper device description installed on Trex. The installed device description must be for the same device type, and equal to or greater than the device rev of the configuration.
- You cannot save or send configurations when using the generic device description.

3.4 Automatically detect a device

The Field Communicator application can automatically detect a device, without requiring any input from you. When you open the Field Communicator application or when the Connect - Select screen is displayed, the Trex unit checks for the most common connection scenarios and, if possible, detects the connected device and displays the Device List. You can then select a device and display its device menu. The auto-detect feature lets you skip the device connection wizard in the Field Communicator application, which allows for faster connections to devices.

The Field Communicator application can automatically detect:

- A HART device that is on an externally-powered compliant HART loop, and the device is communicating at address zero.
- A 4-wire HART device that is communicating at address zero. (This may require a resistor across the HART terminals. Check the device documentation for the proper connection.)
- A *Wireless*HART device that is powered by its battery, and the device is communicating at address zero.
- A powered FOUNDATION fieldbus segment that is actively communicating. The fieldbus segment must have a host system or a FOUNDATION fieldbus device that is the Link Active Scheduler (LAS).

While the Trex unit is connecting to the device, the Auto-Detect screen is displayed to show the status. If you tap Cancel, the Connect - Select screen is displayed and the Trex unit stops the connection process.

Note

For HART devices, the Field Communicator application can automatically detect and connect to the device if the Auto-Connect option in the Trex Settings is enabled. If this option is enabled, the device menu is displayed rather than the Device List.

3.4.1 Automatically connect to a HART device

The Field Communicator application can automatically detect and connect to a HART device, without requiring any input from you. When you open the Field Communicator application or when the Connect - Select screen is displayed, the Trex unit checks for the most common connection scenarios and, if possible, connects to the device and displays the device menu.

To use the auto-connect feature, ensure the Auto-Connect option is enabled (Settings > Field Communicator App Settings > Auto-Connect), and the Trex unit is connected to one of the following:

- A HART device that is on an externally-powered compliant HART loop, and the device is communicating at address zero.
- A 4-wire HART device that is communicating at address zero. (This may require a resistor across the HART terminals. Check the device documentation for the proper connection.)
- A *WirelessHART* device that is powered by its battery, and the device is communicating at address zero.

If the Trex unit cannot automatically connect to the device, tap HART on the Connect - Select screen and follow the prompts from the device connection wizard to connect to the device.

Note

You can disable the Field Communicator application from automatically connecting to a device at address zero. If you disable this option, the Trex unit still detects the device at address zero, but you need to select the device on the Device List to connect and view the device screens. You may also want to disable this option if the Trex unit is connected to a transmitter at address zero with a THUM adapter.

3.5 Connect - Select screen

If the Trex unit cannot automatically detect or connect to the device when you open the Field Communicator application, the Connect - Select screen is displayed. The Connect - Select screen is the home screen for the Field Communicator application.

You can do the following on the Connect - Select screen:

- Connect the lead set to the Trex unit and to the device to try to automatically detect/connect to the device. If the device meets the criteria for automatically connecting, the Trex unit tries to connect to the device.
- Tap HART or Fieldbus to start the device connection wizard and connect to the device.

- Tap HART Offline or Fieldbus Offline to simulate a device.

Figure 3-1: Connect - Select screen

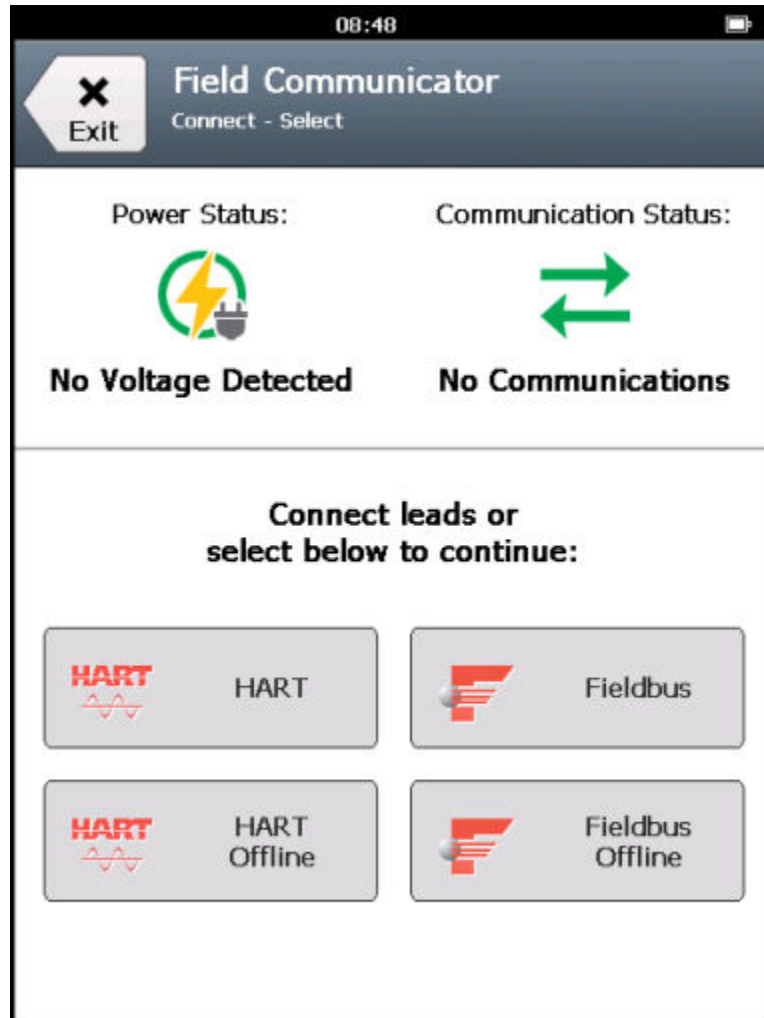

Note

To switch between HART communication and FOUNDATION fieldbus communication, you must exit and restart the Field Communicator application. After the HART or Fieldbus Device Lists are displayed, the HART or Fieldbus buttons disappear until you restart the application.

Option	Description
Power Status	Detect voltage on the lead set.
Communication Status	Detect if a connected device is communicating with the Trex unit.

Option	Description
HART	Connect to a live HART device. Tap this option if the Trex unit could not automatically detect or connect to the device. The device connection wizard is displayed.
HART Offline	Simulate a connected HART device to become familiar with the menus before configuring the device in a critical environment. This option does not require communication with a device.
Fieldbus	Connect to a live FOUNDATION fieldbus device. Tapping Fieldbus starts the Trex unit's communications if external power is detected, and the Trex unit assumes the role of network master (LAS), if no other master exists. The device connection wizard is displayed. (The Fieldbus option is displayed only if Trex unit is licensed for FOUNDATION fieldbus.)
Fieldbus Offline	Simulate a connected FOUNDATION fieldbus device to become familiar with the menus before configuring the device in a critical environment. This option does not require communication with a device. (The Fieldbus Offline option is displayed only if Trex unit is licensed for FOUNDATION fieldbus.)

To return to the Connect - Select screen from a device screen, press Menu > Disconnect.

Related information

Status when detecting a device

3.6 Device connection wizard

If the Trex unit cannot automatically detect or connect to the device, tap HART or Fieldbus on the Connect - Select screen to start the device connection wizard. The wizard displays a set of questions to help you connect to the device. You may see one or more of the questions below depending on the setup of your device. The questions may appear in a different order than listed below.

- Do you intend to provide power from the Trex unit? (This is available only if the Device Communicator Plus communication module is attached to the Trex unit.)
- Is the Trex unit connected to a transmitter or a positioner?
- Do you want to change the polling options?
- Do you want to increase loop resistance? (This enables the internal resistors.)
- Do you want to increase loop current? (This is available for only positioners.)

In the Field Communicator application, the device connection wizard is the only way to enable the Trex unit to power a device, change the polling options for HART and fieldbus, enable the internal resistors within the Trex unit, or increase current to positioners.

If the device connection wizard completes its process and cannot connect to the device, a message is displayed. Tap Cancel to return to the Connect - Select screen to retry the connection process.

Note

The selections are not saved in the device connection wizard. You need to select the desired options each time you connect to a device.

Note

If you tap Back during the device connection wizard, the change you made on that screen is canceled and the previous screen is displayed. For example, if you enabled the Trex unit to provide power and changed the polling address from 0 to 63 and then tapped the Back button, the polling address is set to the default value of 0, but the Trex unit still powers the device. You can also tap Back to return to a previous question and provide a different answer/selection.

Problems the device connection wizard can detect

The device connection wizard can also identify common wiring problems, including if the wrong terminals on the Trex unit are used or if a lead set is not connected to the device or the Trex unit. If a problem is detected, a message describes the problem or a graphic shows the correct wiring.

The Trex unit continuously monitors the voltage and current at the terminals where the lead set is connected. the Field Communicator application displays a message if an error is detected, including if the lead set is removed from the device or Trex unit. For example, if you try to enable the Trex unit to power a device that already has power, the Field Communicator application displays a message that voltage was detected and the Trex power supply is turned off to protect the device and Trex unit.

In some cases, you may be able to override the warning from the device connection wizard. For example, some devices may hold voltage for several minutes after being disconnected from the power supply. If you enable the Trex unit to power a device that is still holding a low voltage (less than 8 volts), a message is displayed that the Field Communicator application detects low voltage and asks if the Trex unit is connected to a digital control system's control loop. You can override this warning and apply power if you are sure the device is not connected to an external power supply.

If the device connection wizard detects a problem, you can fix the issue while the connection wizard is displayed. The change is updated in the Power Status and Communication Status sections.

3.7 Status when detecting a device

When the Trex unit tries to detect and connect to a device, the Power Status option and the Communication Status option on the Connect - Select screen show one of the following status messages.

Power Status Message	Description
Voltage Detected on HART	Typical status for connecting across HART device's communication terminals when the device is on an externally-powered loop. The detected voltage is greater than or equal to 8 volts.
Voltage Detected on HART+ pwr	The detected voltage is greater than or equal to 8 volts.
Low Voltage Detected on HART	<p>Typical status for connecting:</p> <ul style="list-style-type: none"> • To a 4-wire HART device • To a <i>WirelessHART</i> device • Across a resistor • Across HART control system modules <p>The detected voltage is between 0.5 and 8 volts.</p> <hr/> <p>Note You may see this status when the AC adapter is attached to the Trex unit. If low voltage is detected, disconnect the AC adapter.</p> <hr/> <p>Note This message can also appear if the Trex unit connects to a device that was recently powered. Some devices may hold voltage for several minutes after being disconnected from its power supply. The Trex unit provides a warning message that it detects voltage.</p> <hr/> <p>If you try to power a device when this occurs, the Trex unit asks if you want to ignore the voltage warning and proceed with sourcing power. If you select Yes, the Trex unit powers the device.</p>
Low Voltage Detected on HART + pwr	The detected voltage is between 0.5 and 8 volts.
No Voltage Detected	<p>Typical status for connecting:</p> <ul style="list-style-type: none"> • An unpowered device. • To some types of 4-wire HART devices. • To some types of <i>WirelessHART</i> devices. <p>This status is also displayed when the lead set is not connected to a device, or when the Trex unit is connecting to a device.</p>
Voltage Detected on FF	Typical status for connecting to an externally-powered fieldbus segment. The detected voltage is greater than or equal to 8 volts.
Low Voltage Detected on FF	The measured voltage is less than 8 volts.
Voltage Provided from FF pwr	The typical status when the Trex unit is powering the FOUNDATION fieldbus device. The detected voltage is greater than or equal to 8 volts.
Voltage Provided from HART+ pwr	The typical status when the Trex unit is powering the HART device. The detected voltage is greater than or equal to 8 volts.

Power Status Message	Description
Voltage on Multiple	<p>The Trex unit has detected voltage on more than one terminal. This may be due to the following:</p> <ul style="list-style-type: none"> • The AC adapter is attached to the Trex unit and is charging the power module. Disconnect the AC adapter from the Trex unit. • Noise is detected on the network. • Two lead sets are connected to two different fieldbus segments or loops. This is not recommended.

Communication Status	Description
No Communication	The Trex unit has not detected any HART or fieldbus communication.
Fieldbus Detected	The Trex unit has detected FOUNDATION fieldbus communication.
HART Detected	<p>Typical status when the Trex unit detects:</p> <ul style="list-style-type: none"> • A HART device in burst mode. • Active HART communication from the digital control system. • A response to a polling message sent to the device. <p>This status may be sporadic and may alternate between HART Detected and No Communication.</p> <p>If unexpected communications are detected, remove the AC adapter to isolate the Trex unit from noise.</p>

3.8 Online menu or Device Dashboard

Depending on the device description (DD) for a device, the first online screen is an Online menu or a device dashboard menu. All devices show a Menu tab at the bottom of the screen.

Online menu

An Online menu may display the following options, depending on the device type:

- Device setup
- Primary variable (PV)
- Analog output (AO)
- PV lower range value (LRV)
- PV upper range value (URV)

Figure 3-2: Online menu example

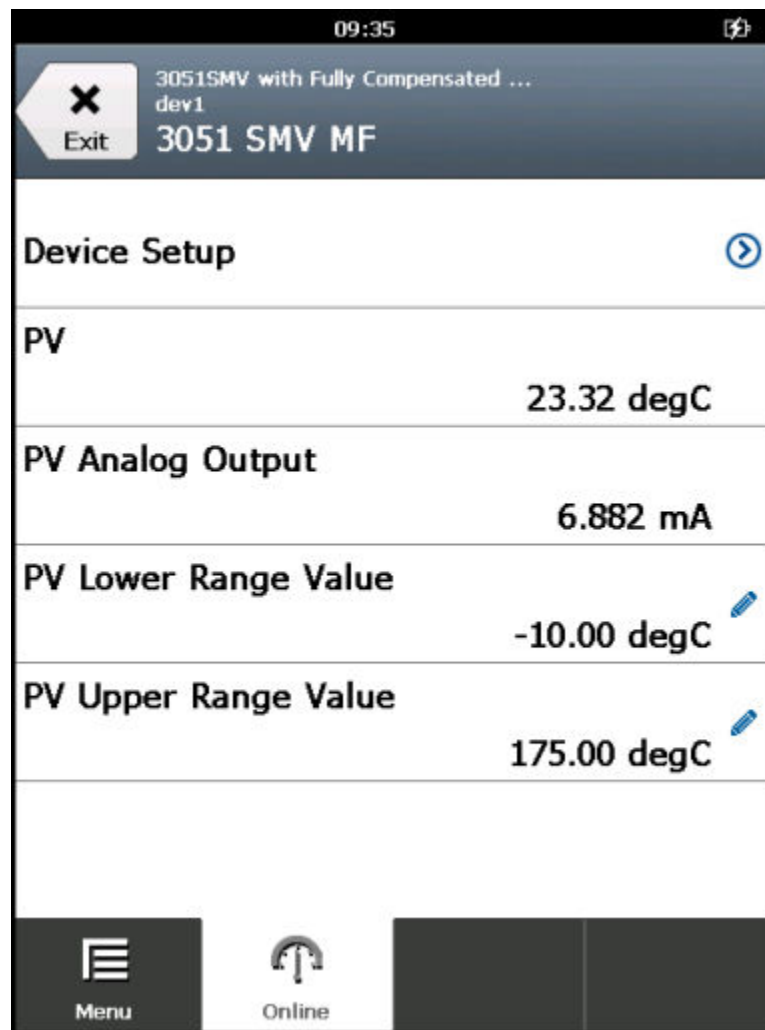

Dashboard menu

A device dashboard menu displays the same parameters as the Online menu, but they are organized by tab, including:

- Overview - View a graphical representation of the process variable. Tap the More arrow on the bottom right side of the screen to access additional menu items. Depending on the device description, the images under "Device" and "Communications" may be selectable links.
- Service Tools - View and modify options for alerts, variables, and maintenance. For FOUNDATION fieldbus devices, the Service Tools option lets you edit the device tag and address, and set the IO block schedule and the link master device. You can also access the blocks directly from the Block List option on the Service Tools screen.
- Configure - Configure the device parameters.

The options below vary based on the device description for the device.

Figure 3-3: Dashboard menu example



3.8.1 Device screen layout

In the Field Communicator application, the device screens have four main parts:

Figure 3-4: Sections of a device screen

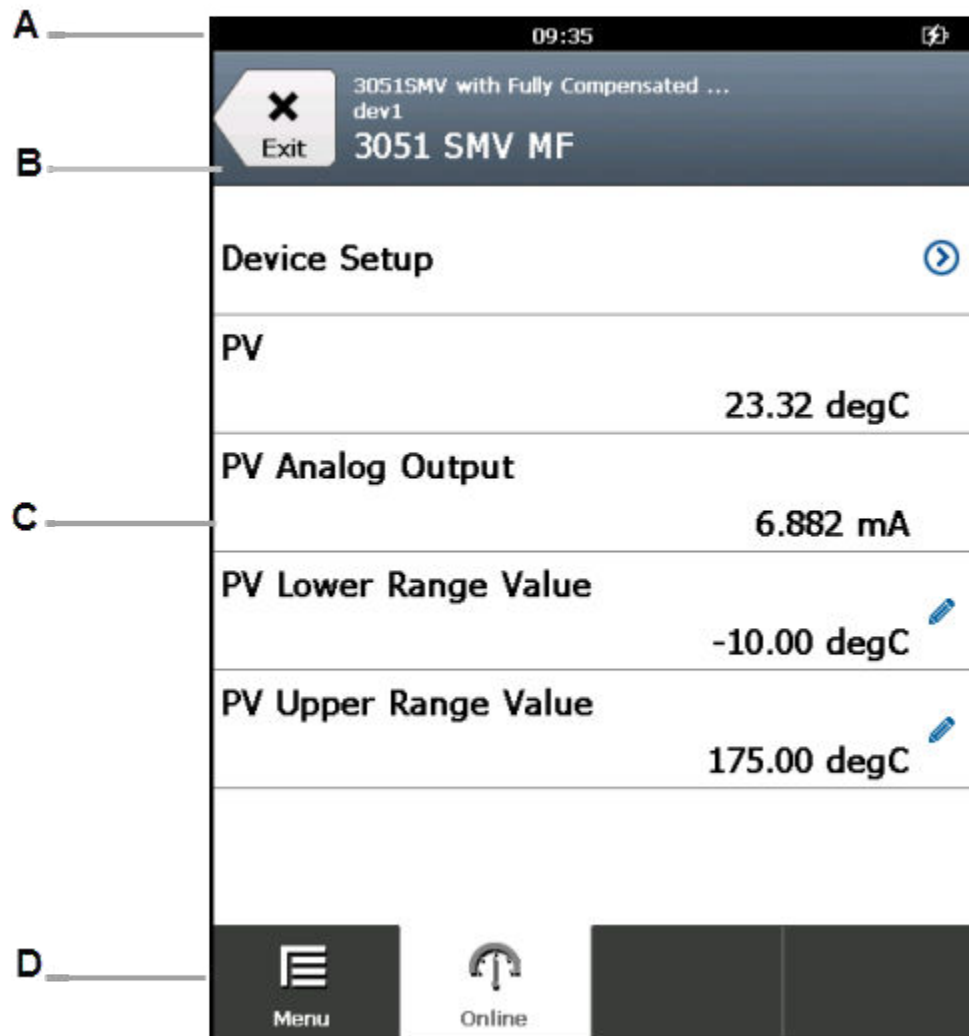

- A. Status bar
- B. Application title bar
- C. Device menu
- D. Application bar

Status bar

Lets you access the settings for the Trex unit and switch to other applications.

Application title bar

Displays the type of device the Trex unit is connected to, the device tag (short tag or long tag), and the menu title (Online). If you tap the application title bar, a menu is displayed. Depending on the type of device, the menu lets you view the HART short/long tag or more information about the device description, including the manufacturer, device type, device revision, and device description revision. A Back or Exit button is also displayed.

Device menu

The menu options for a specific device type and revision. The options displayed will vary based on the device description. You can press and hold a menu item to display an additional menu that lets you view Help or add the item to the list of favorites (HART only).

Application bar

Displays the main groups of options for a device. Most devices have an Online option. Devices that display a device dashboard display Overview, Configure, and Service Tools.

3.8.2 Application bar

The application bar lists the main options for the connected device. Depending on the device description, you may see a different application bar than the one described below. See the device documentation for more detailed descriptions of these options.

Figure 3-5: Example of an application bar at the bottom of the screen



Option	Description
Menu	View the list of favorites for HART devices, simulate a device, or connect/disconnect a device.
Online	View the process variable and configure device parameters.
Overview	(Device dashboard screen only) View a graphical representation of the process variable. The More option lets you access the device parameters.
Service Tools	View and modify options for alerts, variables, and maintenance. For FOUNDATION fieldbus devices, commonly used parameters are also accessible, including the device tag, device address, IO block schedule, link master configuration, and device information.
Configure	(Device dashboard screen only) Configure the device parameters.

3.8.3 Menu screen

The Menu screen lets you connect/disconnect a device, edit and save a configuration, send a configuration (only for a connected device), set a favorite, or simulate a device.

To access the Menu screen without connecting to a device, tap HART Offline or Fieldbus Offline on the Connect - Select screen. The Menu screen is also displayed when the Trex unit is connected to a HART or FOUNDATION fieldbus device. Both the Online screen and the device dashboard screen display the Menu screen.

Figure 3-6: Menu screen for a connected HART device



Option	Description
Connect or Disconnect	Tap Connect to return to the Connect - Select screen and connect to a device. Tap Disconnect to stop communicating with a device. The Trex unit also stops powering the device when you tap Disconnect.
Favorites	Save frequently used menu items to a list for quick access. The Favorites option is available for only HART devices.
Simulate	Simulate a connection to a live HART or FOUNDATION fieldbus device, depending on if you selected HART Offline or Fieldbus Offline. This option is displayed only if a device is not connected to the Trex unit.
Save Config	Save a configuration for this device to the AMS Trex unit.
Send Config	Send a configuration to a connected HART device. This option is displayed only if a device is connected to the Trex unit.

Option	Description
Offline Config	Create or edit a configuration on the AMS Trex unit.

You can also connect a device, simulate a device, or edit a configuration from the Menu screen.

Figure 3-7: Menu screen for no connected HART device







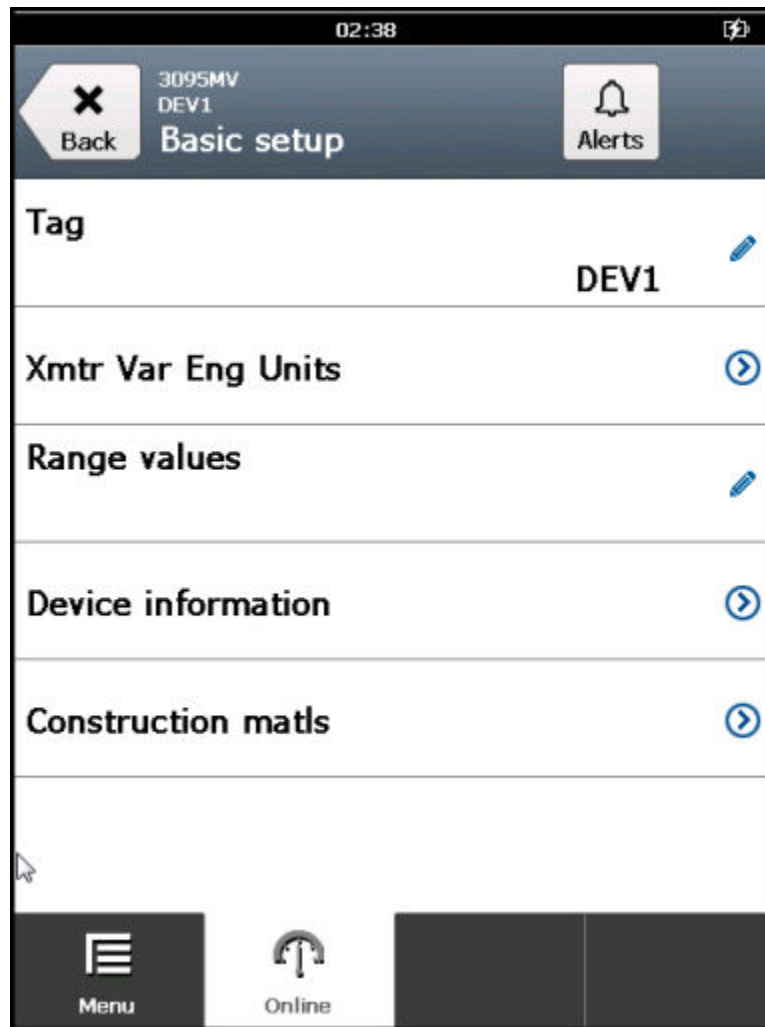

3.9 Icons on the device menus

When the Trex unit is connected to a device, the device menus may have one or more icons.

Figure 3-8: Device menu with icons



Icon	Description
	The option is a parameter you can edit, such as the device tag.
	The option is a device method, such as a loop test.
	The option has a submenu with additional options.

Icon	Description
	The option is a graph or chart. Charts display a graphic view of variables as they occur over time.
	The option is a gauge chart. A gauge chart formats device data into a view similar to an analog car speedometer and plots device data varying with time.
	The option is a grid.
	The option is an image.
No icon	The option is a process variable. The process variable value may or may not be displayed, depending on the device description for the device.

3.10 Connections to HART devices

The Trex unit can communicate with a device from the control room, on the bench, or any wiring termination point in the loop. Review the HART wiring diagrams to ensure the Trex unit is correctly connected to the device.

Note

The Trex unit acts as a secondary HART master on a HART loop.

Related information

[Internal resistors](#)

3.10.1 HART communication terminals

The Trex unit has communication terminals that enable it to communicate with a HART device. Insert the lead set into the red and black terminals and connect to a HART device.

Note

The lead set must be used to communicate with a wired or wireless device.

Figure 3-9: HART communication terminals on the Device Communicator communication module



- A. Communicate with an externally-powered HART device

Figure 3-10: HART communication terminals on the Device Communicator Plus communication module

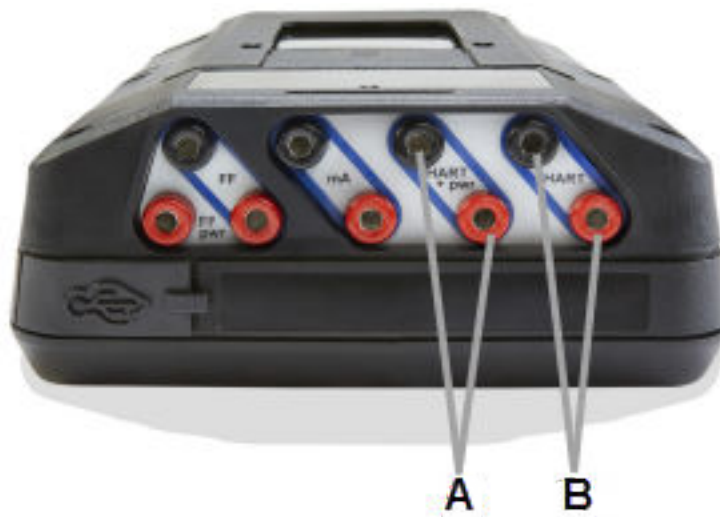

- A. Power and communicate with a HART device.
B. Communicate with an externally-powered HART device.

Related information

[Wiring diagrams for HART devices and the Field Communicator application](#)
[Power and connect to a HART device](#)

3.10.2 Wiring diagrams for HART devices and the Field Communicator application

The Trex unit can communicate with a device from the control room, on the bench, or any wiring termination point in the loop. Connect the lead set to the Trex unit and to the communication terminals on the device or across the resistor.

Below each diagram, a table lists the expected prompts from the device connection wizard and the answers to complete the connection. The prompts appear only if the Field Communicator application could not automatically detect or connect to the device.

Note

The Trex unit acts as a secondary HART master on a HART loop.

⚠ CAUTION!

Remove the USB cable from the Trex unit before connecting to a device.

Figure 3-11: Power and connect to a 2-wire HART transmitter

Note

When the Trex unit powers the HART transmitter, an external resistor is not needed. The Trex unit uses an internal resistor that is automatically used when you enable the Trex unit to power the transmitter.

Note

Do not insert a resistor in parallel with either the HART+pwr or HART terminals on the Trex unit, or in parallel with the device's communication terminals. This may prevent communications.

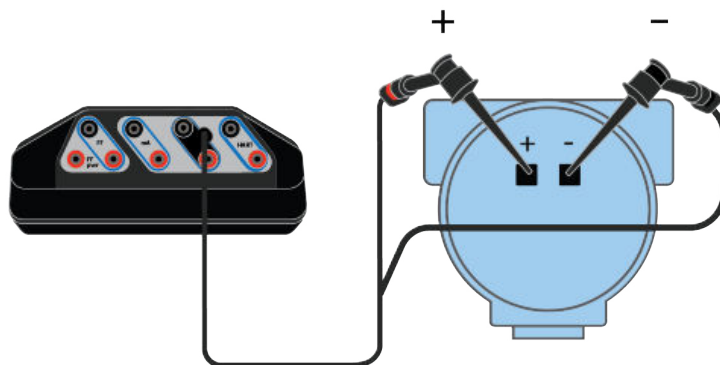

Device connection wizard prompts	Answer
Do you intend to provide power from the Trex unit?	Yes
Are you providing power to a transmitter or positioner?	Transmitter
Change Polling Option?	Tap Yes if the device is not at address zero.

Figure 3-12: Connect to a powered WirelessHART device (with its battery attached)

⚠ CAUTION!

Do not use the Trex unit to power a WirelessHART device. Providing power to a WirelessHART device may damage the device.

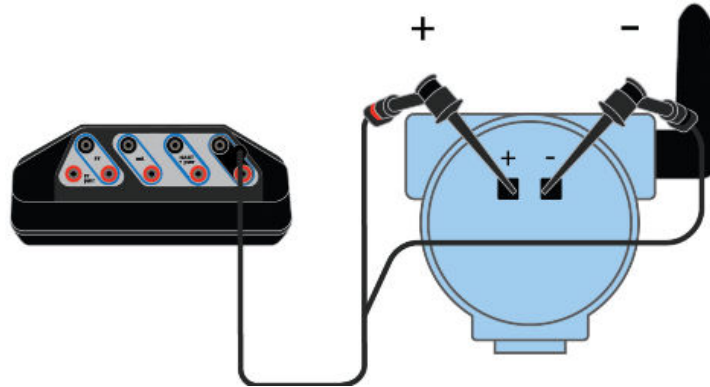

Device connection wizard prompts	Answer
Do you intend to provide power from the Trex unit?	No
Leads are attached to:	Transmitter
Change Polling Option?	Tap Yes if the device is not at address zero.

Figure 3-13: Connect to an externally-powered 2-wire HART transmitter

If the transmitter is at address zero, the Trex unit may automatically detect and connect to the device without any prompts from the device connection wizard.

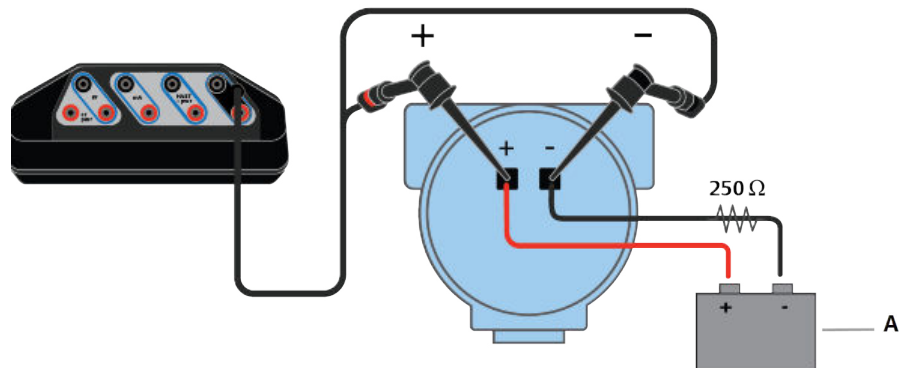

A. Voltage source

Device connection wizard prompts	Answer
Do you intend to provide power from the Trex unit?	No
Leads are attached to:	Transmitter
Change Polling Option?	Tap Yes if the device is not at address zero.

Figure 3-14: Connect to an externally-powered 2-wire HART transmitter and use the Trex internal resistor

Note

The Trex unit must be connected in series with the transmitter to use the internal resistor.

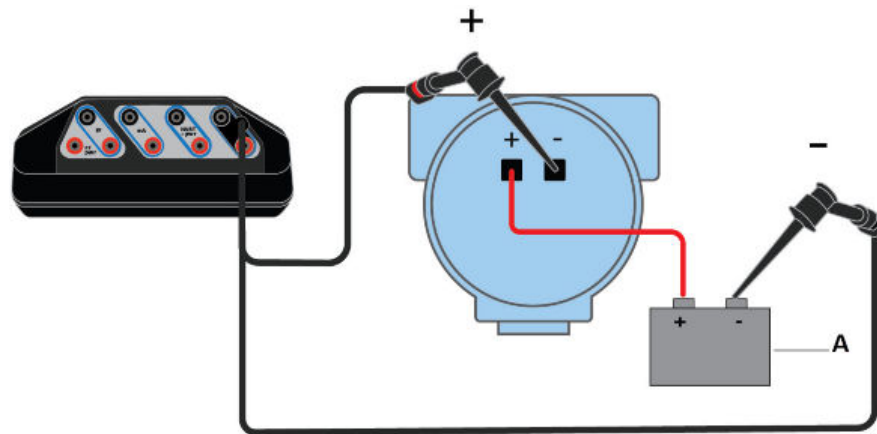

A. Voltage source

Device connection wizard prompts	Answer
Do you intend to provide power from the Trex unit?	No
Leads are attached to:	Transmitter
Change Polling Option?	Tap Yes if the device is not at address zero.
Increase loop resistance?	Tap Yes to enable the internal resistor.

Figure 3-15: Connect to a 4-wire HART transmitter

If you have a 250 Ohm resistor, you can insert it in between the device terminals and connect the lead set across the resistor. Otherwise, you can enable the internal resistor in the device connection wizard.

Note

Ensure you review the device documentation for connecting/setting up HART communication. Devices may have different terminals or requirements.

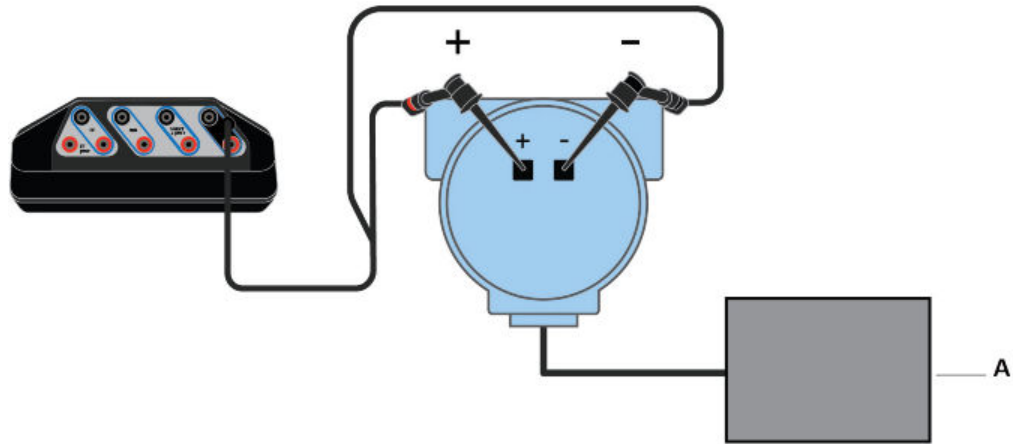

A. Voltage source

Device connection wizard prompts	Answer
Do you intend to provide power from the Trex unit?	No
Leads are attached to:	Transmitter
Change Polling Option?	Tap Yes if the device is not at address zero.
Increase loop resistance?	Tap Yes if there is no external resistor between the device terminals.

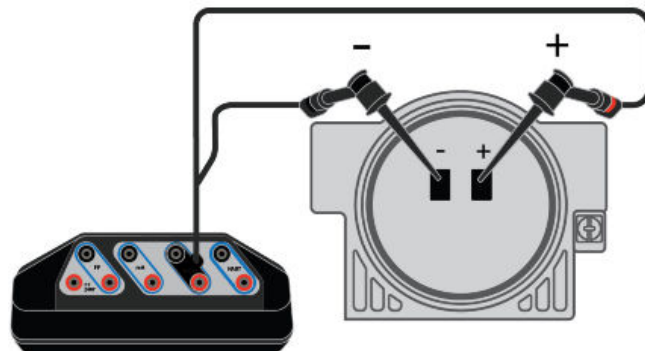
Figure 3-16: Power and connect to a HART positioner

Device connection wizard prompts	Answer
Do you intend to provide power from the Trex unit?	Yes
Are you providing power to a transmitter or positioner?	Positioner
Change Polling Option?	Tap Yes if the device is not at address zero.
Increase loop current?	Tap Yes to increase the current from 4 mA to another value, if the device did not initially communicate.

Figure 3-17: Connect to an externally-powered HART positioner

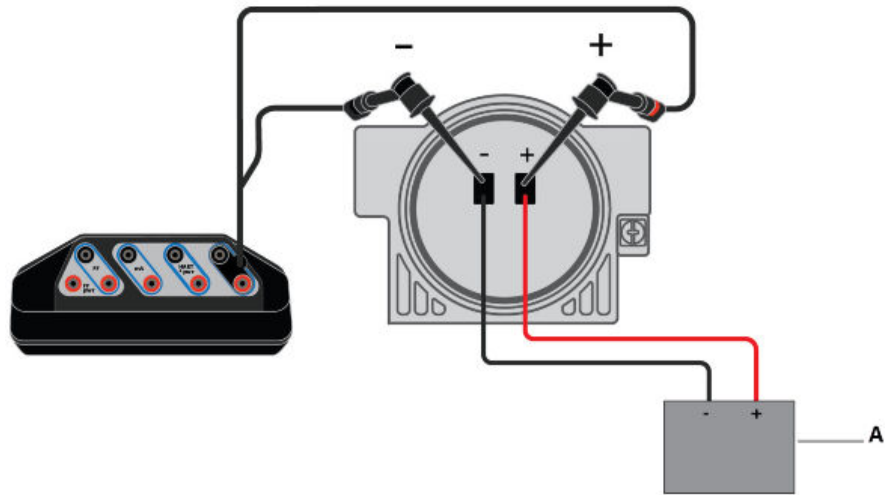

A. Current source

Device connection wizard prompts	Answer
Do you intend to provide power from the Trex unit?	No
Leads are attached to:	Positioner
Change Polling Option?	Tap Yes if the device is not at address zero.
Increase loop current?	Tap Yes to increase the current from 4 mA to another value, if the device did not initially communicate.

Related information

- [HART communication terminals](#)
- [Connect to an externally-powered HART device](#)
- [Power and connect to a HART device](#)
- [Internal resistors](#)

3.10.3 Wiring diagrams for the Smart Wireless THUM™ Adapter and the Field Communicator application

Below each diagram, a table lists the expected prompts from the device connection wizard and the answers to select to complete the connection.

If you are using a *WirelessHART* adapter that is not the Smart Wireless THUM adapter, review its documentation before connecting the Trex unit.

Note

- Ensure you review the documentation included with the THUM adapter for additional information.
- The Trex unit acts as a secondary HART master on a HART loop.

⚠ CAUTION!

Remove the USB cable from the Trex unit before connecting to a device.

Figure 3-18: Power the THUM adapter without a device attached and use 250 Ohm resistor

Connect the lead set to the red and black wires.

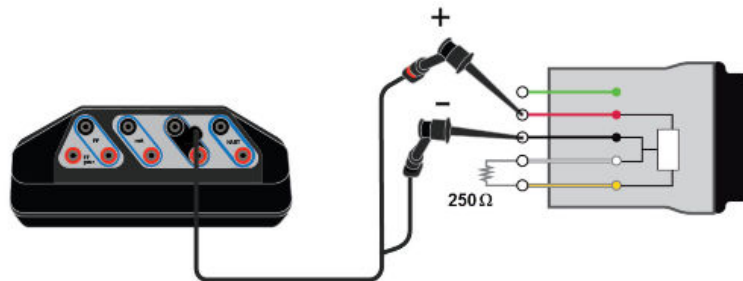

Device connection wizard prompts	Answer
Do you intend to provide power from the Trex unit?	Yes
Are you providing power to a transmitter or positioner?	Positioner Select Positioner because the Trex unit needs to control/limit current due to the lower value of the resistor.
Change Polling Option?	Tap Yes and select the address for the THUM adapter.

Figure 3-19: Power and communicate with the THUM adapter attached to a HART transmitter

Note

If you want to communicate with the THUM adapter rather than the device, ensure the Auto-Connect option for the Field Communicator Settings is disabled. This allows the Field Communicator application to detect both the THUM adapter and the transmitter, and let you select which one to communicate with.

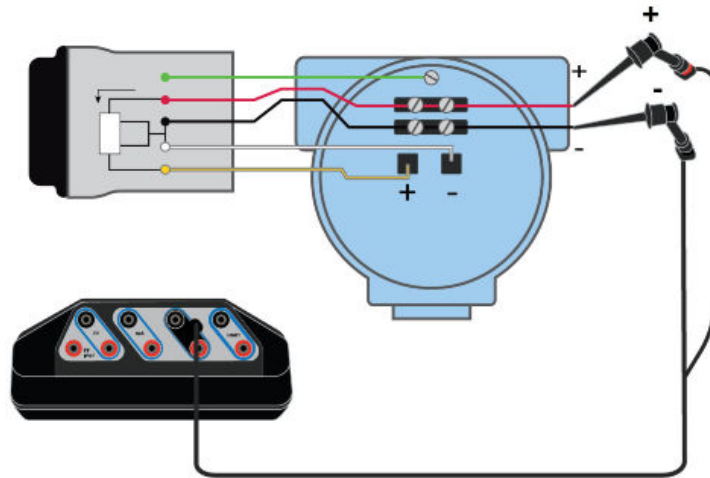

Device connection wizard prompts	Answer
Do you intend to provide power from the Trex unit?	Yes
Are you providing power to a transmitter or positioner?	Transmitter
Change Polling Option?	Tap Yes and select the address for the THUM adapter, the device, or "0,63" for both.

Figure 3-20: Communicate with the THUM adapter attached to a powered HART transmitter

Connect the lead set to the yellow and white wires.

Note

If you want to communicate with the THUM adapter, ensure the Auto-Connect option for the Field Communicator Settings is disabled. This allows the Field Communicator application to detect both the THUM adapter and the transmitter, and let you select which one to communicate with.

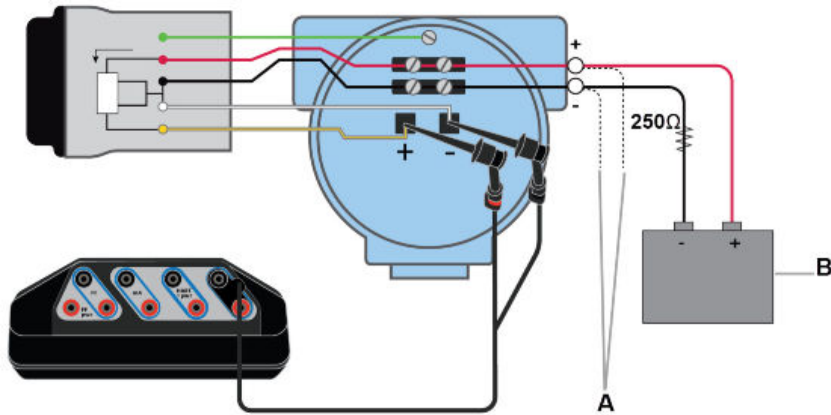

- A. Optional connection if the yellow and white wires are inaccessible.
 B. Voltage source.

Device connection wizard prompts	Answer
Do you intend to provide power from the Trex unit?	No
Leads are attached to:	Transmitter
Change Polling Option?	Tap Yes and select the address for the THUM adapter, the device, or "0,63" for both.

Figure 3-21: Communicate with the THUM adapter powered by a voltage source

Connect the lead set to the yellow and white/black wires.

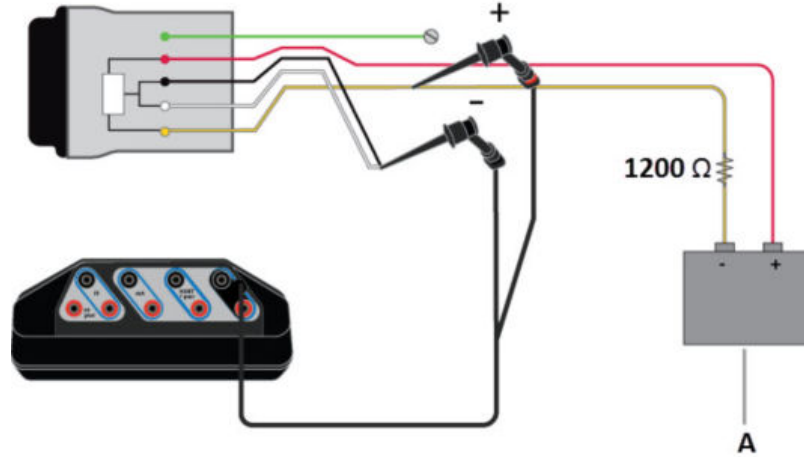

A. Voltage source.

Device connection wizard prompts	Answer
Do you intend to provide power from the Trex unit?	No
Leads are attached to:	Transmitter
Change Polling Option?	Tap Yes and select 63.

Figure 3-22: Communicate with the THUM adapter powered by a current source

Connect the lead set to the yellow and white/black wires. The 250 Ohm resistor is not required, but it may be used to verify current.

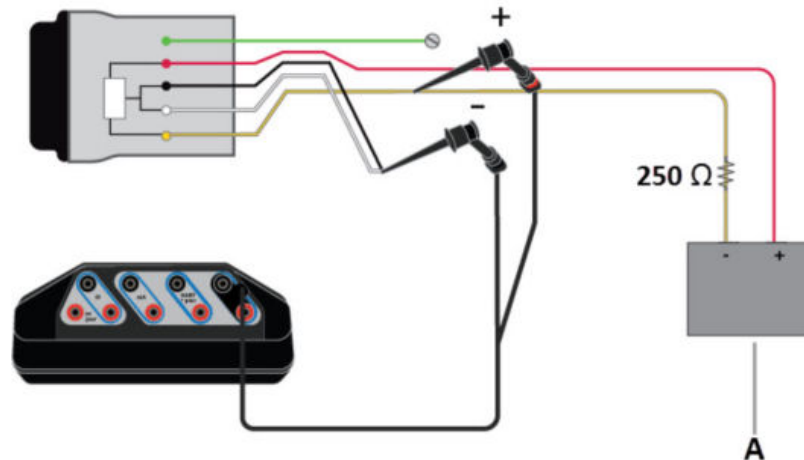

A. Current source.

Device connection wizard prompts	Answer
Do you intend to provide power from the Trex unit?	No
Leads are attached to:	Positioner
Change Polling Option?	Tap Yes and select 63.

3.10.4 HART Device List

The Device List displays the devices that the Trex unit has detected. Each device is listed by its tag and address. The Device List will not display when the Auto-Connect option for the Field Communicator application is enabled and a device was found at address zero.

Tap a device displayed on the Device List to connect to it.

If a device is not listed, tap My Device Not Found to change the HART polling options.

Figure 3-23: HART Device List

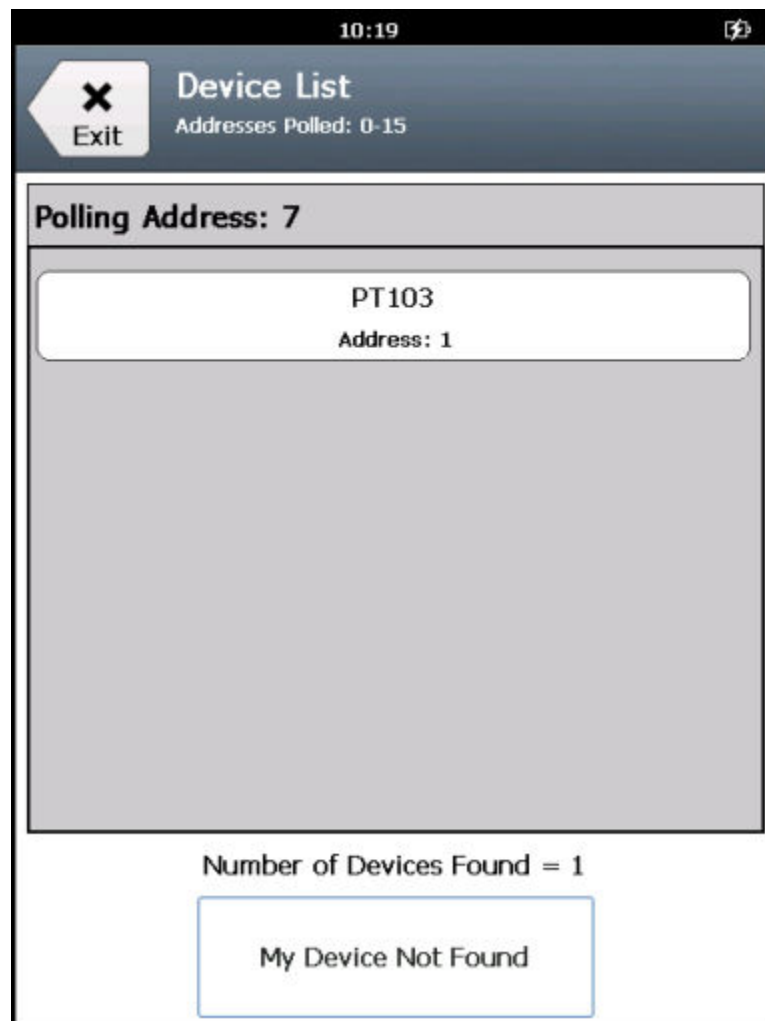

3.11 Internal resistors

The Trex unit has internal resistors that can be used when the Trex unit powers a HART transmitter, or when the HART transmitter is on a 4-20 mA current loop without a resistor. The resistors are enabled through the device connection wizard in the Field Communicator application.

Note

For positioners, the internal resistors in the Trex unit are disabled.

Available resistors

Resistor	Use
167 Ohm	Used when the Trex unit powers a HART transmitter. This is the only resistor that is available when the Trex unit powers a transmitter. The 167 Ohm resistor is available due to Intrinsic Safety limitations when the Trex unit powers a device. If the current is high (for example 22.5 mA), the voltage drops to a level that may not be enough to power the device. The use of the lower valued resistor can reduce the amount of the voltage drop. The HART signal is lower, but the shout/deaf mode helps increase the HART signal amplitude for devices that do not meet the HART specifications.
250 Ohm	Used when you select to increase loop resistance in the device connection wizard when connecting to a device on an externally-powered 4-20 mA current loop.
500 Ohm	Used when the Trex unit detects the current is too high for the 250 Ohm resistor on an externally-powered 4-20 mA current loop. If the current continues to be too high after adding this resistor, the Trex unit displays an error message indicating the detected current exceeds the capacity of the resistor. The 500 Ohm resistor is used for externally-powered current loops.

Connection to a transmitter powered by the Trex unit

To enable the 167 Ohm resistor, the Trex unit must be connected to the device using the HART + pwr terminals.

Figure 3-24: Connection for using the Trex internal resistor when the Trex unit powers the transmitter

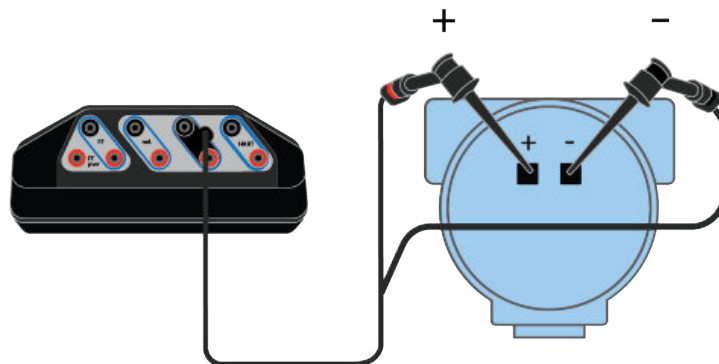

Connections to externally-powered transmitters

To enable the internal resistors, the Trex unit must be connected to the device/loop in a specific way.

For externally-powered 2-wire HART devices, the Trex unit must be connected in series. In the diagram below, the Trex internal resistor is enabled in the HART terminals.

Figure 3-25: Connection for using the Trex internal resistor for an externally-powered 2-wire transmitter

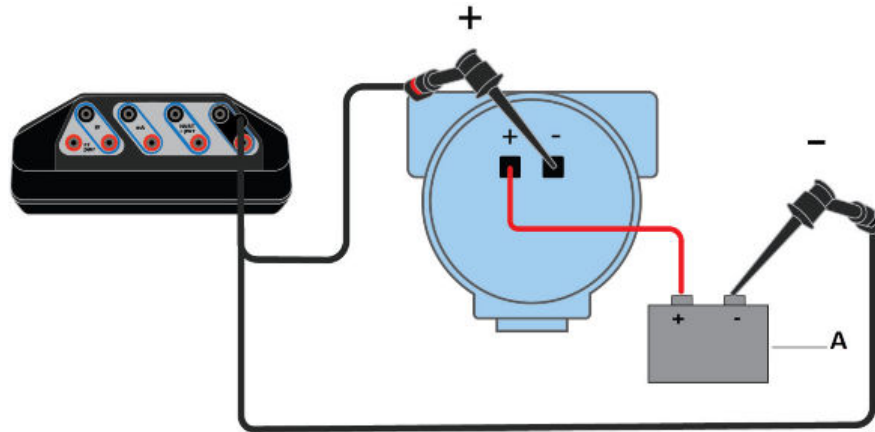

A. Voltage source

For 4-wire transmitters, the Trex unit must be connected in parallel. In the diagram below, the Trex internal resistor is enabled in the HART terminals.

Figure 3-26: Connection for using the internal resistor for a 4-wire transmitter

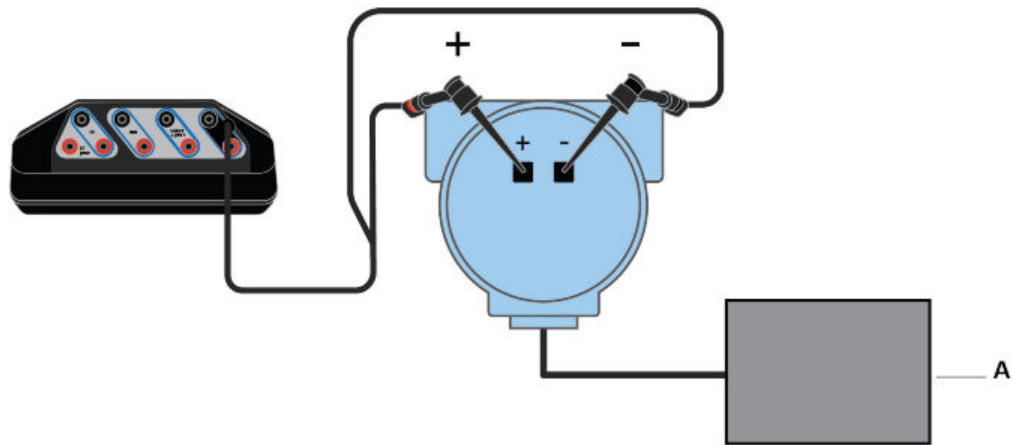

A. Voltage source

3.11.1 Enable or disable the internal resistors

If the Trex unit powers the transmitter, there is no prompt/option to enable or disable the internal 167 Ohm resistor. The Trex unit automatically applies the resistor when you enable power to a transmitter from the device connection wizard.

If the Trex unit is connected to an externally-powered HART transmitter, the device connection wizard prompts you if you want to increase loop resistance. The Trex unit then selects the 250 Ohm or 500 Ohm resistor; you cannot select a specific value. The selected resistor value is not displayed on the screen.

Procedure

1. If you want the Trex unit to power a 2-wire HART transmitter, do the following:
 - a. Connect the lead set to the HART + pwr terminals on the Trex unit and to the communication terminals on the device.

Figure 3-27: Connection for providing power to a 2-wire HART transmitter

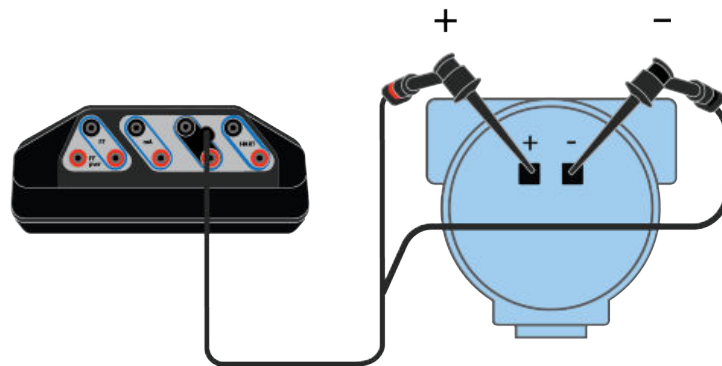

- b. In the Field Communicator application, tap HART.
 - c. Tap Yes when asked if you intend to provide power.
 - d. Tap Transmitter. The Trex unit applies the internal resistor.
 - e. Follow any additional prompts to connect to the device.
 2. If the Trex unit is connected to an externally-powered 2-wire HART transmitter, do the following:
 - a. Connect the lead set to the HART terminals on the Trex unit and to the communication terminals on the device in-series. (If you are connecting to a 4-wire transmitter, connect the Trex unit in parallel.)

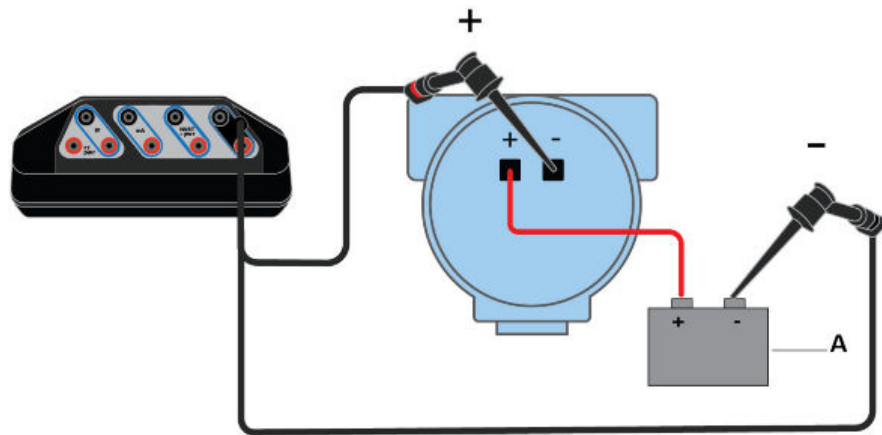
Figure 3-28: Connection for an externally-powered 2-wire transmitter

A. Voltage source

- b. Tap HART.
 - c. Tap No when asked if you intend to provide power.
 - d. Tap Transmitter.
 - e. Tap No when asked if you want to change polling. (This assumes the device is at address zero.)
 - f. Tap Yes when asked if you want to increase loop resistance.
 - g. Tap Next.
- A message is displayed to indicate the internal resistor is being enabled.
3. To disable the internal resistor, disconnect the device from the Trex unit, or close the Field Communicator application.

3.12 Power and connect to a HART device

The Trex unit can provide up to 16 volts (at 22.5 mA) to power a HART device. The Trex unit must have the Device Communicator Plus communication module to power a HART device (transmitter or positioner).

You do not need to add an external resistor. The Trex unit has a 167 Ohm internal resistor in the HART + pwr terminals that is used when the Trex unit powers the transmitter.

If you try to apply power from the Trex unit when the device is externally-powered, the Field Communicator application prevents the Trex unit from supplying power. This protects the Trex unit from damage.

⚠ CAUTION!

- The Trex unit cannot power a 4-wire device. Do not connect Trex unit to the power terminals of a 4-wire device. This can blow a fuse inside the Trex unit. The repair/ replacement will need to be completed at an authorized service center.
- Remove the USB cable from the Trex unit before connecting to a device.
- Do not use the Trex unit to power a *WirelessHART* device. Providing power to a *WirelessHART* device may damage the device.

⚠ WARNING!

Do not add any external power to the device when the Trex unit is powering the device. This can blow a fuse inside the Trex unit. The repair/replacement will need to be completed at an authorized service center. Ensure the device is disconnected from the loop/segment and no other wires are connected to the device before providing power from the Trex unit.

Procedure

1. Connect the lead set to the HART + pwr terminals on the Trex unit and to the communication terminals on the device.

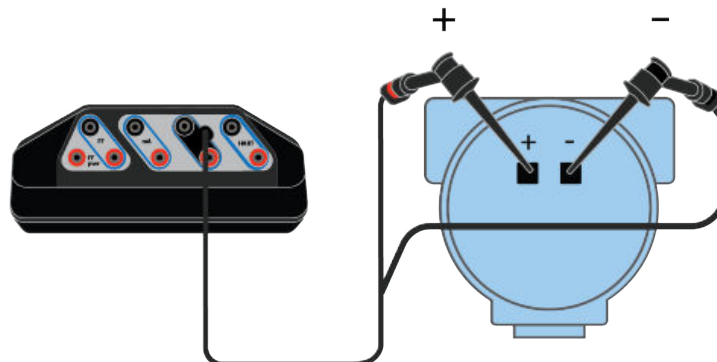
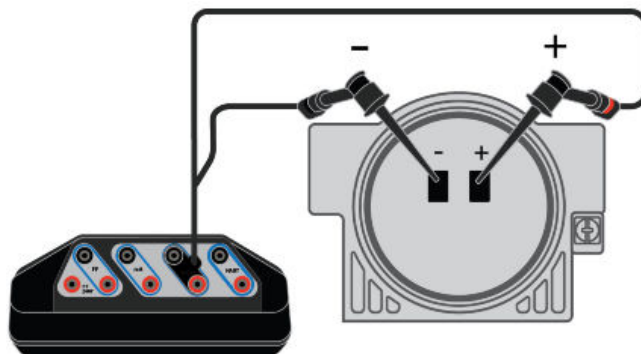
Figure 3-29: Power a HART transmitter**Figure 3-30: Power a HART positioner**

2. In the Field Communicator application, tap HART.
3. Tap Yes when prompted if you want the Trex unit to power the device.
4. Tap Transmitter or Positioner.

If you selected Positioner, the Trex unit provides power and 4 mA.

5. Follow any additional prompts.

You may see additional prompts if the Trex unit cannot connect to the device. For example, you may be prompted to review the polling address. For a positioner, you may be asked to increase current (mA) to increase the value from the original 4 mA. The Online menu or the device dashboard displays, depending on the device type.

Related information

[Wiring diagrams for HART devices and the Field Communicator application](#)
[Wiring diagrams for the Smart Wireless THUM™ Adapter and the Field Communicator application](#)
[Disconnect a device](#)
[HART communication terminals](#)
[Internal resistors](#)

3.12.1 Power and connect to a Smart Wireless THUM adapter

The Trex unit must have the Device Communicator Plus communication module to power a THUM adapter.

When performing a bench configuration, the THUM adapter should be attached to a device. However, the Trex unit can power a THUM adapter when it is not connected to a HART device.

To connect to a device that has a THUM adapter attached, see [Section 3.13](#) or [Section 3.12](#).

CAUTION!

Remove the USB cable from the Trex unit before connecting to a device.

Procedure

1. Connect the lead set to the HART + pwr terminals on the Trex unit and the red/black wires on the THUM adapter.

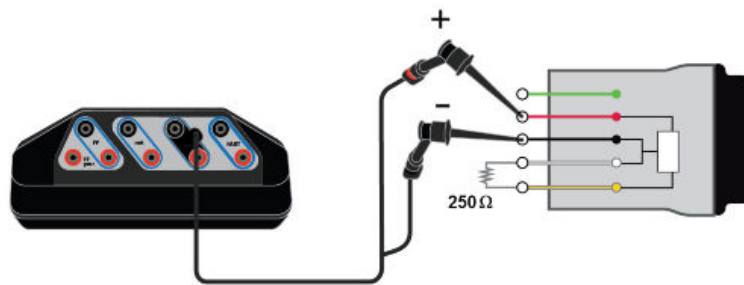
Figure 3-31: THUM adapter wiring with 250 Ohm resistor

2. In the Field Communicator application, tap HART.
3. Tap Yes when prompted if you want the Trex unit to power the device.
4. Tap Positioner.
5. When prompted, change the polling address to 63.
6. Follow any additional prompts to connect to the THUM adapter.

The device menu is displayed.

Related information

[HART communication terminals](#)

[Wiring diagrams for the Smart Wireless THUM™ Adapter and the Field Communicator application](#)

[Disconnect a device](#)

3.13 Connect to an externally-powered HART device

By default, the Trex unit tries to automatically connect to the device at address zero. See [Section 3.4.1](#) for more information.

⚠ CAUTION!

Remove the USB cable from the Trex unit before connecting to a device.

Note

The Trex unit acts as a secondary HART master on a HART loop.

Procedure

1. Connect the lead set to the HART terminals on the Trex unit and to the communication terminals on the device. See the HART wiring diagrams topic for the connection details.

If you want to use the Trex internal resistor, connect the Trex unit in series with the device.

2. Open the Field Communicator application.
The Trex unit may automatically detect or connect to the device.
3. If the Trex unit does not automatically connect to the device, tap HART and do the following:
 - a. Tap No when asked if you want to provide power from the Trex unit.
 - b. Select Transmitter or Positioner.
 - c. Follow any additional prompts.

You may see additional prompts if the Trex unit cannot connect to the device. For example, you may be prompted to review the polling address if the device is not at address zero, or to increase loop resistance. The Online menu or the device dashboard displays, depending on the device type.
 - d. Tap the device displayed on the Device List.
4. To disconnect a device, tap Menu > Disconnect, or remove the lead set.





Related information

[Wiring diagrams for HART devices and the Field Communicator application](#)
[Wiring diagrams for the Smart Wireless THUM™ Adapter and the Field Communicator application](#)
[Disconnect a device](#)
[HART communication terminals](#)
[Internal resistors](#)

3.14 Online HART devices

3.14.1 HART icons

When the Trex unit communicates with a HART device, one of the following icons appears in the status bar at the top of the screen. The icon shows the status of the communication.

Icon	Description
	The Trex unit is communicating with a live, online HART device.
	The Trex unit is communicating with a HART loop with a device in burst mode. Burst mode is a communication mode in a HART transmitter to send data at regular intervals.
	The Trex unit is running in shout/deaf mode, which helps it communicate with a device when it is on a noisy HART loop.
	The Trex unit is running in shout/deaf mode and communicating to a HART loop with a device in burst mode.

Related information

Status bar

3.14.2 Device Setup options

The Device Setup menu accesses every configurable parameter for the connected device. Some devices may not display a Device Setup menu or it may display different options. The list below is a general overview of the options. See the device documentation for more information.

Tap Device Setup to view the process variables, diagnostics and service, basic setup, detailed setup, and review menus.

Process Variables

The Process Variables menu lists all process variables and their values. Process variables are continuously updated.

Diagnostics and Service

Option	Description
Diagnostics and Service	Run device and loop tests as well as calibration options. The diagnostics and service operations that are available vary widely from device to device and are defined in the device description.
Test device	View the status as well as self and master test of the device. Test device initiates a diagnostic routine at the device and can report an electronics failure, as well as other failures that can affect performance.
Loop test	Set the output of the device at a specified analog value, and test the integrity of the loop and the operation of indicators, recorders, or similar devices in the loop.
Calibration	Perform such operations a sensor trim, D/A trim, and scaled D/A trim.

Basic Setup

The options in the Basic setup menu are the most fundamental tasks that can be performed with a device. These tasks are a subset of the options available under the Detailed setup menu.

Option	Description
Tag	Modify the tag for the device.
Unit	Select the engineering units that are displayed.
Damping	Change the response time of the transmitter. It is often used to smooth the output when there are rapid input variations.
Range values	Modify the analog output scaling.

Detailed Setup

The Detailed setup menu provides access to every editable device parameter and all device functions. The Detailed setup menu varies from one HART device to another. Functions in this menu can include tasks such as characterization, configuration, and sensor and output trims.

Review

The Review menu lists all the static parameters read from the connected device, including information about the device and sensor setup and limitations. It may also include information about the connected device such as tag, materials of construction, and device software revision.

3.14.3 Changing device parameters

When you change a parameter for a device, the Field Communicator application highlights the changed parameter yellow until you send the change to the device. You can send one or more changes to a device.

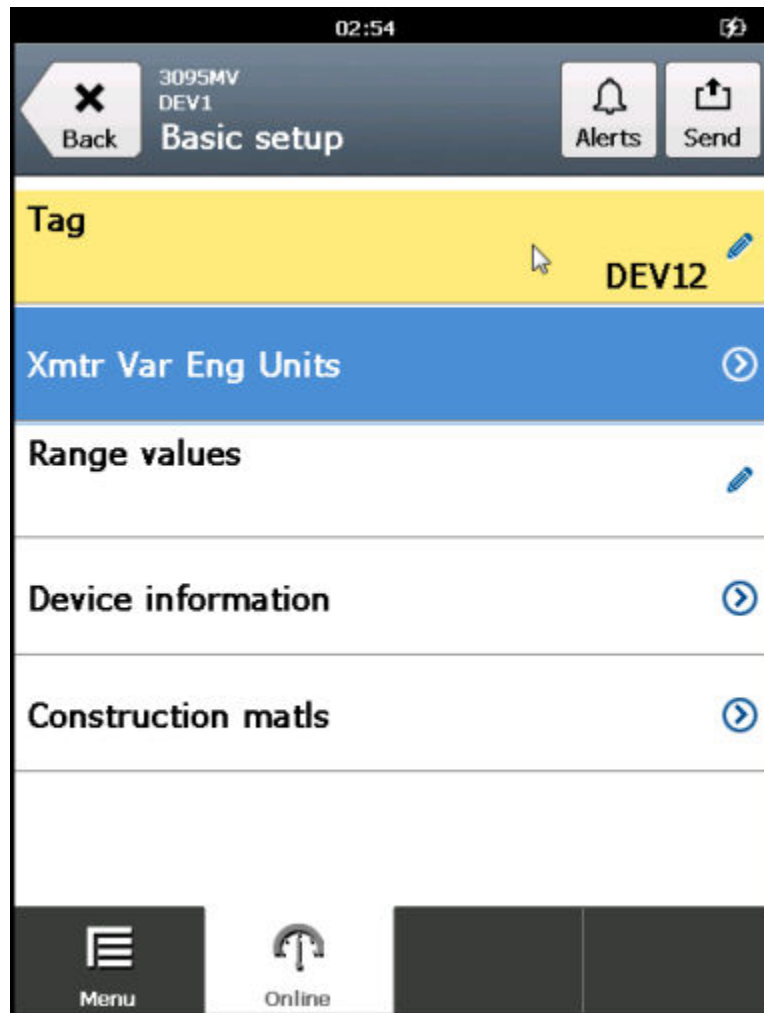
Figure 3-32: Changed parameter is highlighted yellow

3.14.4 Change a HART device parameter

You can modify one or more parameters and then send the changes to the device.

Procedure

1. Connect to the HART device.
2. Go to the parameter you want to change.
See the device documentation for more information. Each device has different menus.
3. Make the desired change.
The changed parameter is highlighted yellow.
4. Tap OK.

5. Tap the Send icon in the upper right corner.
A list of all the changes you made is displayed.
6. Review the change.
Tap Discard to undo the change and close the screen. Tap Cancel to keep the change and send it to the device at a later time.
7. Tap Send.
The change is sent to the device. The yellow highlight is removed from the changed parameters.

3.14.5 Edit a HART configuration

Prerequisites

Note

Do not edit a configuration on the Trex unit while you are connected to the Configuration Management PC application.

Procedure

1. In the Field Communicator application, tap HART Offline.
2. Tap Offline Config > Edit Existing.
3. Tap the column heading to sort configurations by File Name or Tag. Select the configuration you want to edit, and tap OK.
4. Select and edit the parameters.
5. Tap the checkbox to mark the parameter for writing.

Note

Unmarked parameters are saved but not sent when you transfer the configuration to a connected device.

6. Tap Save when you finish editing the parameters.
7. If necessary, enter a new configuration name.
8. Tap OK.

3.14.6 Display the HART short tag or long tag

You can select the HART short or long tag to display for HART revision 6 or higher devices. By default, HART revision 7 devices display the long tag. The option will not display for earlier devices.

Note

The selected tag is not retained the next time you connect to the device. You need to select the desired tag each time you connect the device.

If you want to change the value of the HART tag, see the device documentation for more information. The location of these tag parameters varies because it is determined by the device manufacturer.

Procedure

1. Connect to the HART device.
2. Tap the tag that is displayed on the top of the screen.

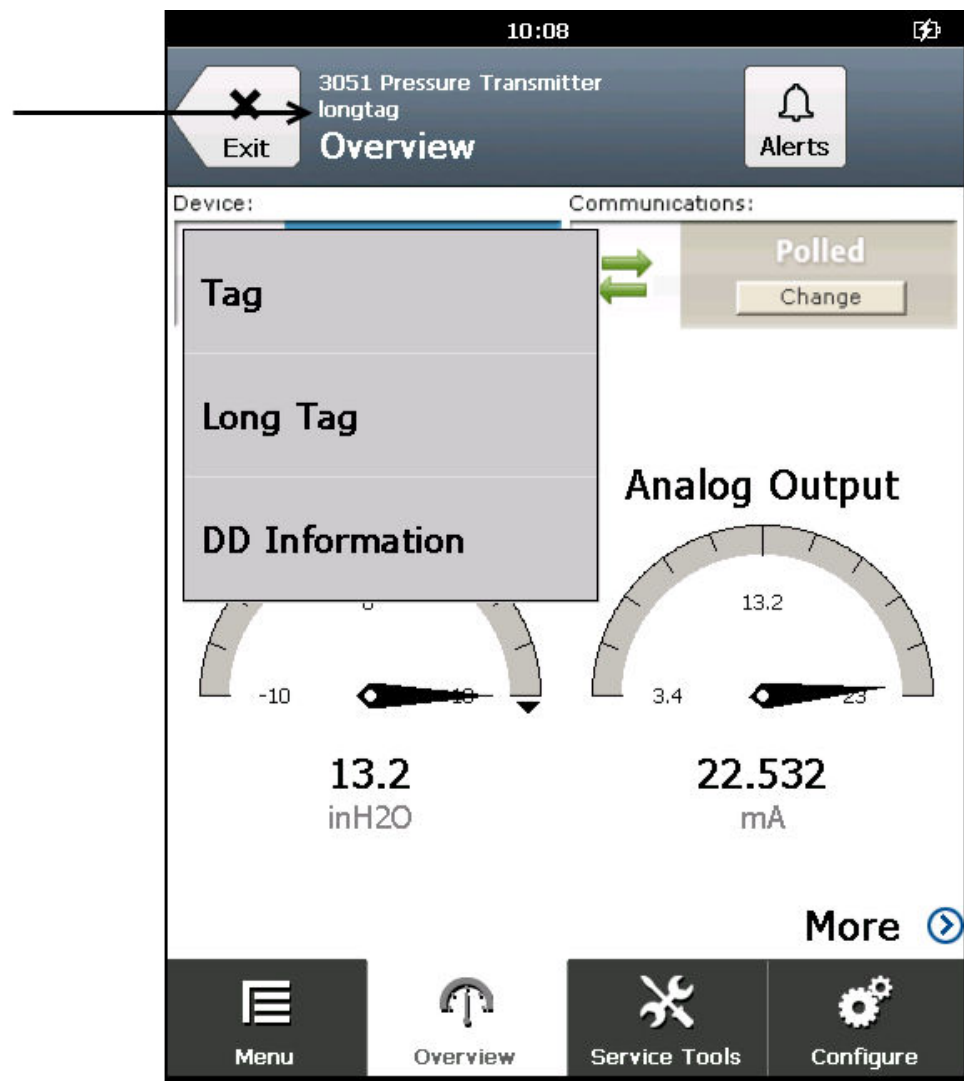
Figure 3-33: Tap the device tag

3. Select Tag or Long Tag.

The displayed tag changes.

3.14.7 View device alerts

1. Connect to a HART device.
2. If the device has alerts, tap Alerts at the top of the screen.

The list of alerts is displayed.

Figure 3-34: Alerts button

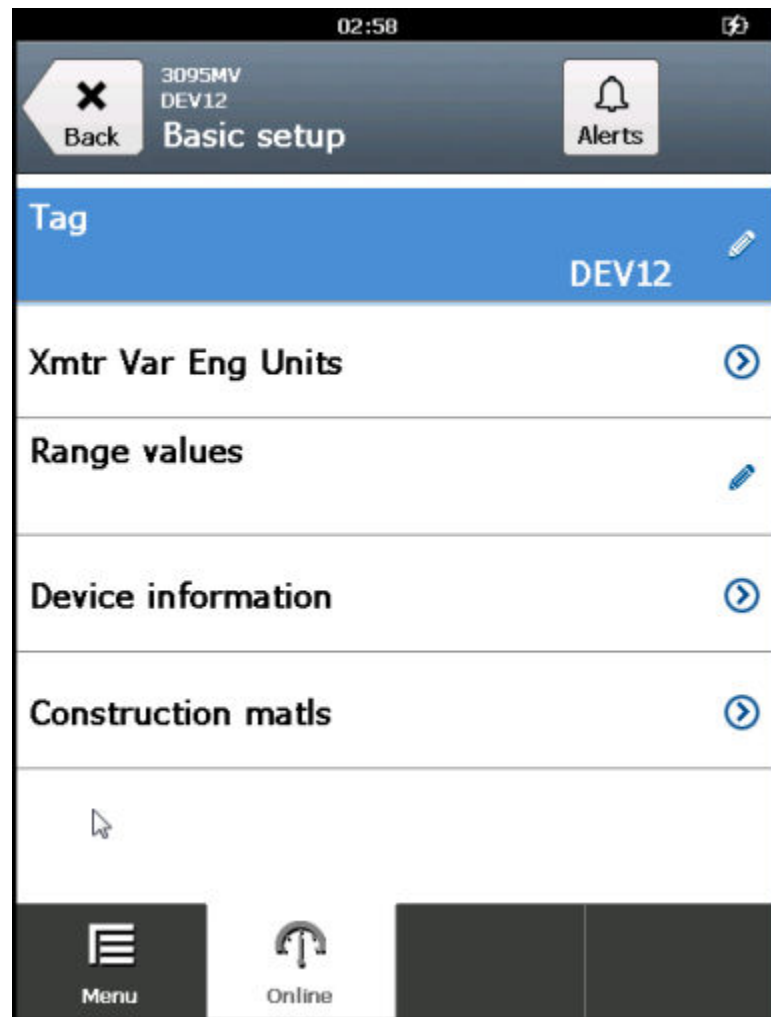

3. Tap OK.

3.14.8 Send a configuration to a connected HART device

Prerequisites

You must have at least one configuration saved in the Trex unit for the connected device type.

Procedure

1. Connect to the HART device.
2. Tap the Menu tab in the application bar.
3. Tap Send Config.
4. Select a saved configuration, and tap OK.
5. Review the parameters, and tap Send.

3.14.9 Save a configuration from a HART device

You can save a copy of the configuration from the connected device. The configuration has only non-dynamic parameters.

Procedure

1. Connect to the HART device.
2. Tap the Menu tab.
3. Tap Save Config.
4. Enter a filename for the configuration, and tap OK.

The configuration is saved in the Trex unit.

3.15 Offline HART configurations

The Trex unit lets you work with HART configurations. You can create, edit, copy, delete, and rename configurations.

If you are not connected to a HART device, an Offline Config button displays on the main Field Communicator menu. You can edit and store a configuration on the Trex unit.

If you are connected to a HART device, you can either Save Config to the Trex unit, or Send Config to the connected device.

You can also back up the configurations to a PC by using the Configuration Management application. For more information, see the Help included with the Configuration Management application.

Note

Do not edit a configuration on the Trex unit while you are connected to the Configuration Management PC application.

3.15.1 Create a HART configuration

Create a new configuration for a specific device type and revision. You can then apply this configuration to multiple devices.

Procedure

1. In the Field Communicator application, tap HART Offline.
2. Tap Offline Config > New.
3. Tap a manufacturer.
4. Tap a device type.
5. Tap a device revision.
6. Tap OK.
7. Select and edit the necessary parameters.
8. Tap OK to mark the parameter for writing.

Note

Unmarked parameters are saved but not sent when you transfer the configuration to a connected device.

9. Tap Save when you finish editing the parameters.
10. Enter a name for the configuration, and tap OK.

The configuration file is saved.

3.15.2 Edit a HART configuration

Prerequisites

Note

Do not edit a configuration on the Trex unit while you are connected to the Configuration Management PC application.

Procedure

1. In the Field Communicator application, tap HART Offline.
2. Tap Offline Config > Edit Existing.
3. Tap the column heading to sort configurations by File Name or Tag. Select the configuration you want to edit, and tap OK.
4. Select and edit the parameters.
5. Tap the checkbox to mark the parameter for writing.

Note

Unmarked parameters are saved but not sent when you transfer the configuration to a connected device.

6. Tap Save when you finish editing the parameters.
7. If necessary, enter a new configuration name.
8. Tap OK.

3.15.3 Copy a HART configuration

You can create a copy of a saved configuration.

Procedure

1. In the Field Communicator application, tap HART Offline.
2. Tap Offline Config > Copy.
3. Select the configuration you want to copy, and tap OK.
4. Enter a name for the new copy of the configuration, and tap OK.
5. Tap OK when asked if you want to copy the file.

The configuration is copied and saved to the Trex unit.

3.15.4 Rename a HART configuration

1. In the Field Communicator application, tap HART Offline.
2. Tap Offline Config > Rename.
3. Select the file to rename, and tap OK.
4. Enter a new name for the configuration, and tap OK.
5. Tap OK when asked if you want to rename the configuration.

The configuration is renamed.

3.15.5 Delete a HART configuration

1. In the Field Communicator application, tap HART Offline.
2. Tap Offline Config > Delete.
3. Select the file to delete, and tap OK.
4. Tap OK when asked if you want to delete the file.

The file is deleted.

3.16 Favorites

You can add the most commonly used HART menu items to a list of favorites for quick access. (This feature is similar to the favorites/bookmark feature in a web browser.) You can add menus (with submenus), methods, or variables to the favorites. The list of favorites is specific to a device revision. It does not include items added from multiple types of devices.

If the device description for the device has predefined favorites, they are available from the Favorites screen. Also, some devices may include additional menu items in the favorites list.

3.16.1 Open a menu item from the favorites list

The Favorites option is supported for only HART devices.

Procedure

1. Connect to a HART device.
2. Tap Menu > Favorites.

The Trex unit displays the list of favorites for the device.

3. Tap a saved favorite to open that menu item.

3.16.2 Add a menu item to the favorites list

Add a menu item for a HART device to the favorites for quick access.

Procedure

1. Connect to a HART device.
2. Go to the menu item you want to add to the favorites.
3. Press the menu item for 2 seconds.

A menu appears.

Figure 3-35: Favorites menu

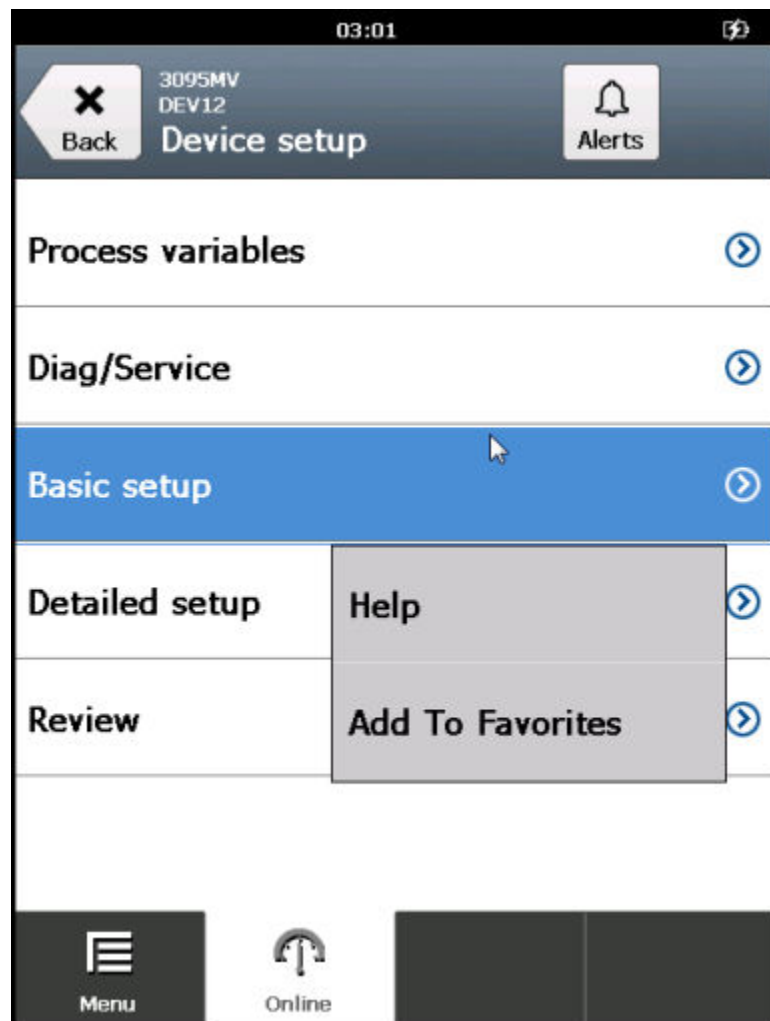

4. Tap Add To Favorites.
The menu item is added to the favorites.
5. To verify the option was added, go to Menu > Favorites.

3.16.3 Remove a menu item from the favorites list

Note

Some devices have default options, such as tag or range values, already in the favorites list. You cannot remove these default options. You can only remove options you added to the favorites list.

Procedure

1. Connect to a HART device.

2. Tap Menu > Favorites.
3. Press and hold a menu item displayed in the Favorites list.
4. Tap Remove From Favorites.

3.17 Polling options for HART devices

The Field Communicator application uses the HART polling options to search for connected devices. By default, the Trex unit searches for a device at address zero and automatically connects to the device, if it is detected. Most HART device installations contain one device per HART loop and the device address is zero. Multidrop mode is enabled by changing the address from zero to any address between 1 and 63. See the device documentation for more information about changing a device address.

If the Trex unit cannot find the device at address zero, the device connection wizard displays a message asking if you want to change the polling option.

The Trex unit can poll by:

- Address - Select an address (0-63).
- Tag - Enter the tag of the device.
- Long Tag - Enter the long tag of the device.

Note

If the Trex unit polls addresses greater than 15 on a loop with HART Universal Revision 5 devices, those devices may appear at multiple addresses.

Note

If you have two devices on a HART loop and one device is at address zero, disable the Auto-Connect option in the Trex Settings. Otherwise, the Trex unit automatically connects to the device at address zero and does not detect the second device.

3.17.1 Set the polling options for HART devices

When you connect to a device, the Trex unit by default automatically polls address zero and connects to the device at that address. If the Trex unit does not find a device at address zero, you are prompted to change the polling address in the device connection wizard.

If you change the polling option, the selected option is not saved. You need to select the desired option each time you connect to a device.

Note

If you have two devices on a HART loop and one device is at address zero, disable the Auto-Connect option in the Trex Settings. Otherwise, the Trex unit automatically connects to the device at address zero and does not detect the second device.

Procedure

1. Connect the lead set to the Trex unit and to the device.
2. Open the Field Communicator application.
3. If the Trex unit does not automatically connect to the device, tap HART.
4. Follow the prompts to connect to the device.
5. Tap Yes when prompted if you want to change the polling option.
6. Select a polling option at the top of the screen.

Option	Description
Address	<p>Poll for devices at the specified addresses.</p> <ul style="list-style-type: none"> • Address 0 : Poll non multi-dropped loops. This is the default option. • Address Range 0 to 15 : Poll HART Universal Revision 5 or earlier devices on multi-dropped loops. • Address Range 0 to 63 : Poll HART Universal Revision 6 or newer devices on multi-dropped loops. • Address 63 (wireless adapter) : Poll the default address for <i>WirelessHART</i> adapters. • Address 0 and 63 (wireless adapter) : Poll address 0 and the default address for <i>WirelessHART</i> adapters. • Custom : Poll a unique or non-consecutive group of addresses (example: "0, 5-7, 12"). Use a hyphen to specify consecutive addresses and/or a comma to separate numbers or groups of numbers.
Tag	Poll by the tag of the device.
Long Tag	Poll by the long tag of the device. (Only supported in HART Universal Revision 6 or higher devices.)

3.18 Connections to FOUNDATION fieldbus devices

Connect the Trex unit to the device by using the lead set and the appropriate terminals. An error message appears if the lead set is connected incorrectly. Digital communication is susceptible to electrical noise; follow proper wiring instructions.

Note

Dynamic variables shown while online represent the digital data being sent from the device.

3.18.1 Precautions for using the Trex unit with FOUNDATION fieldbus devices

⚠ WARNING!

If a fieldbus segment is connected to a host system, the changes made with the Trex unit may not be recorded in the host system's permanent database. Verify the changes in the database. Otherwise, this could cause unpredictable results and, depending upon your application, process disruption leading to property damage, serious injury, or death. Ensure all safety precautions and work procedures have been followed.

⚠ WARNING!

Changing device parameters could adversely affect the control of your process. Put the control loop in Manual/Out of Service before applying changes. Verify the output before returning the control loop to Auto. Failure to do so could result in property damage, serious injury, or death. Ensure all safety precautions and work procedures have been followed.

⚠ CAUTION!

The Trex unit draws approximately 12 mA from the fieldbus segment when it is online. (The Trex unit draws 0 mA when it is offline.) Ensure the power supply or barrier on the fieldbus segment has the capacity to provide this additional current when the Trex unit is online. If a heavily loaded fieldbus segment is drawing near the capacity of the segment's power supply, connecting the Trex unit may result in loss of communication.

3.18.2 FOUNDATION fieldbus communication terminals

The Trex unit has terminals that enable communication with FOUNDATION fieldbus devices. Insert the lead set into the FF terminals and connect to a FOUNDATION fieldbus device or to a connection point on the fieldbus segment.

On the Device Communicator Plus communication module, the red FF pwr terminal enables the Trex unit to power one FOUNDATION fieldbus device. To use this terminal, you need the FOUNDATION fieldbus Power Plug that connects to the FF pwr terminal and the positive (red) FF terminal. This lets the Trex unit communicate with and power one FOUNDATION fieldbus device.

Figure 3-36: FOUNDATION fieldbus Power Plug attached to the Trex unit

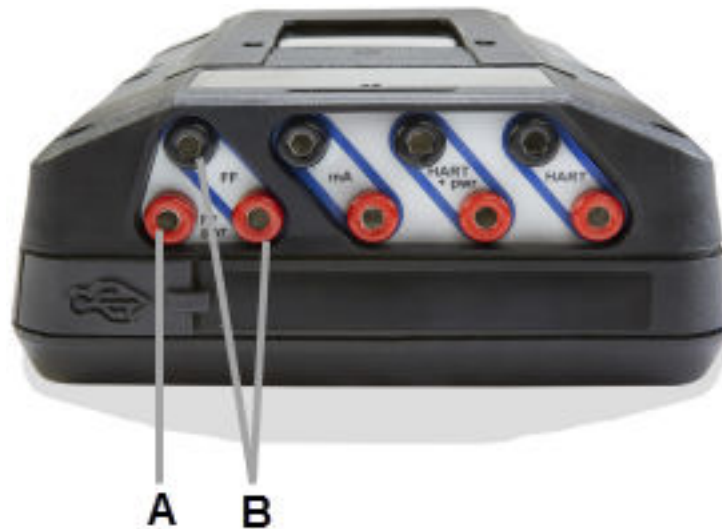

Figure 3-37: FOUNDATION fieldbus terminals on the Device Communicator communication module



A. FF terminals to communicate with a FOUNDATION fieldbus device

Figure 3-38: FOUNDATION fieldbus terminals on the Device Communicator Plus communication module



- A. *FF pwr terminal provides power, power conditioning, and two terminators to one FOUNDATION fieldbus device. Use the FOUNDATION fieldbus Power Plug to connect this terminal to the red FF terminal.*
- B. *FF terminals to communicate with a FOUNDATION fieldbus device*

Related information

[Wiring diagrams for FOUNDATION fieldbus devices and the Field Communicator application](#)

3.18.3 Wiring diagrams for FOUNDATION fieldbus devices and the Field Communicator application

⚠ CAUTION!

Remove the USB cable from the Trex unit before connecting to a device.

⚠ CAUTION!

The Trex unit draws approximately 12 mA from the fieldbus segment when it is online. (The Trex unit draws 0 mA when it is offline.) Ensure the power supply or barrier on the fieldbus segment has the capacity to provide this additional current when the Trex unit is online. If a heavily loaded fieldbus segment is drawing near the capacity of the segment's power supply, connecting the Trex unit may result in loss of communication.

Figure 3-39: Power and connect to a FOUNDATION fieldbus device

To power a FOUNDATION fieldbus device, the Trex unit needs the FOUNDATION fieldbus Power Plug. When the Trex unit powers a device, it also provides two terminators and a power conditioner.

⚠ WARNING!

The Trex unit can power only one FOUNDATION fieldbus device.

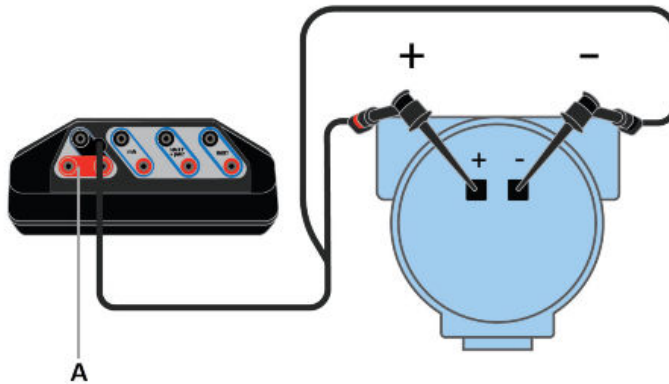

A. FOUNDATION fieldbus Power Plug

Figure 3-40: Connect to an externally-powered FOUNDATION fieldbus device

For small fieldbus segments, the power conditioner and terminators can be contained in a single wiring block.

Note

You can connect the Trex unit at any convenient place along the fieldbus segment (bus). In the field, this is typically done at the device or at the fieldbus junction box. The drawing below is one example.

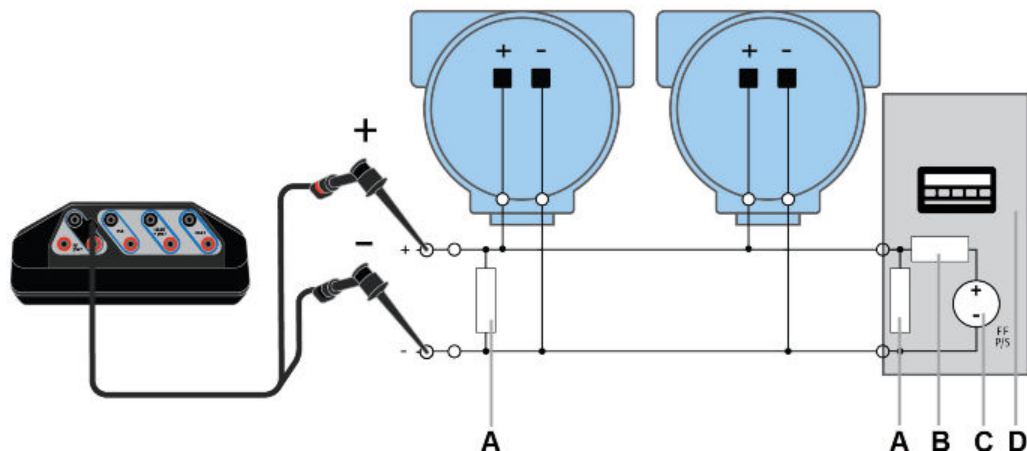

- A. Terminators
- B. Power conditioner
- C. Fieldbus power supply
- D. Host system

Related information

[FOUNDATION fieldbus communication terminals](#)
[Power and connect to a FOUNDATION fieldbus device](#)
[Connect to an externally-powered FOUNDATION fieldbus device](#)

3.18.4 Link Active Scheduler (LAS)

All fieldbus segments have only one Link Active Scheduler (LAS). The LAS operates as the bus arbiter for the segment. The Trex unit is the last node to become the LAS on a fieldbus segment.

The devices that can be the LAS are called link master devices. All other devices are called basic devices. Use the Trex unit to set a device to be a link master or basic device.

When a fieldbus segment first starts up, or upon failure of the existing LAS, the link master devices on the segment bid to become the LAS. The link master with the lowest address begins operating as the LAS immediately after completing the bidding process. Link masters that do not become the LAS can act as LAS backups by monitoring the fieldbus segment for failure of the LAS and then bidding to become the LAS when a LAS failure is detected.

Only one device can communicate at a time. Permission to communicate on the bus is controlled by a centralized token passed between devices by the LAS. Only the device with the token can communicate. The LAS maintains a list of all devices that need access to the bus. This list is called the Device List.

Although the Trex unit can be the LAS, it does not maintain the communication schedule and should not be thought of as a backup LAS. When the Trex unit is connected to a live fieldbus segment, it joins the fieldbus segment, but not as the LAS. The Trex unit can view and edit device parameters, but the LAS controls the segment.

The device acting as the LAS is labeled on the Device List screen.

3.18.5 Fieldbus Device List

The Device List displays all devices that the Trex unit has detected. Each device is listed by its tag and address. The last four numbers of the Trex serial number are displayed to identify the Trex unit. The Device List also identifies the host on the fieldbus segment and which device is the LAS.

Tap a device listed on the screen to connect to it. If a device is not listed, tap the My Device Not Found button. This option expands the following settings:

- Polling addresses - By default, the Trex unit polls addresses 0-48 and 232-255. This range is then expanded to include all valid fieldbus addresses.
- Slot time - The slot time is increased to enable the Trex unit to find older FOUNDATION fieldbus devices on the fieldbus segment.

Figure 3-41: Fieldbus Device List



3.19 Power and connect to a FOUNDATION fieldbus device

The Trex unit can power one FOUNDATION fieldbus device. The Trex unit can provide approximately 10 volts at 25 mA to power a FOUNDATION fieldbus device. (The Trex unit will draw approximately 12 mA when it is online).

If you try to apply power from the Trex unit when the device is externally-powered, the Field Communicator application prevents the Trex unit from supplying power. This protects the Trex unit from damage.

Note

When the Trex unit powers a FOUNDATION fieldbus device, two internal terminators and a power conditioner are applied. Ensure the device is not connected to a fieldbus segment, even if the segment is unpowered.

⚠ CAUTION!

Remove the USB cable from the Trex unit before connecting to a device.

⚠ WARNING!

Do not add any external power to the device when the Trex unit is powering the device. This can blow a fuse inside the Trex unit. The repair/replacement will need to be completed at an authorized service center. Ensure the device is disconnected from the loop/segment and no other wires are connected to the device before providing power from the Trex unit.

Procedure

1. Connect the lead set to the FF terminals on the Trex unit and directly to the communication terminals on the unpowered device. Ensure no other wires are connected to the device and there is no power to the device. Do not attach to a junction box.
2. Connect the FOUNDATION fieldbus Power Plug to the FF pwr terminal and the positive (red) terminal on the lead set.

Figure 3-42: Connection for powering a FOUNDATION fieldbus device

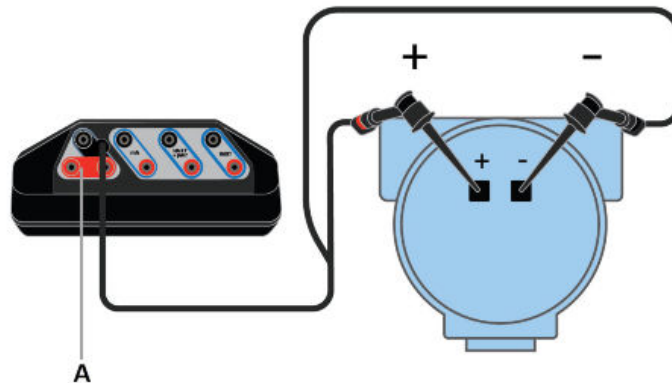

A. FOUNDATION fieldbus Power Plug

3. Open the Field Communicator application.
4. Tap Fieldbus.
5. Tap Yes when prompted if you want to provide power to the device from the Trex unit.

The Trex unit provides power and searches for connected devices to display on the Device List.

6. From the Device List, tap the desired device.
The device menu displays.
7. To stop powering the FOUNDATION fieldbus device, close the Field Communicator application or remove the lead set.

Related information

[Wiring diagrams for FOUNDATION fieldbus devices and the Field Communicator application](#)
[Disconnect a device](#)

3.20 Connect to an externally-powered FOUNDATION fieldbus device

The Trex unit may automatically display the device on the Device List if the device is on a fieldbus segment that has a host system or a FOUNDATION fieldbus device that is the LAS.

The Trex unit will become the LAS if it is connected to an externally-powered FOUNDATION fieldbus device on a fieldbus segment with no communications.

⚠ CAUTION!

Remove the USB cable from the Trex unit before connecting to a device.

Procedure

1. Connect the lead set to the FF terminals on the Trex unit and the device.

Figure 3-43: Example of connection to the fieldbus segment

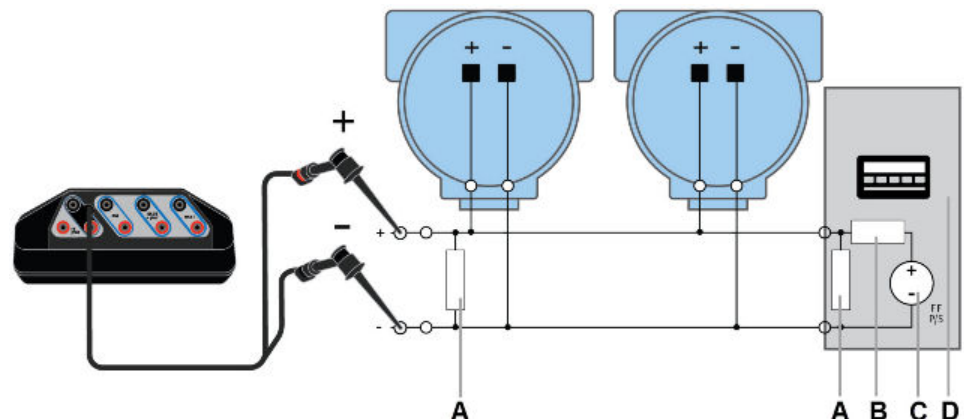

- A. Terminators
- B. Power conditioner
- C. Fieldbus power supply
- D. Host system

2. Open the Field Communicator application.
3. If the Trex unit does not automatically find the device, tap **Fieldbus** on the **Connect - Select** screen.
4. From the **Device List**, tap the desired device.
The device menu is displayed.
5. To disconnect a device, tap **Menu > Disconnect**, or remove the lead set.

Related information

[Wiring diagrams for FOUNDATION fieldbus devices and the Field Communicator application](#)
[Disconnect a device](#)

3.21 Online FOUNDATION fieldbus devices

3.21.1 Limitations for commissioned devices

The Trex unit prevents you from completing some tasks on commissioned devices that could adversely affect the control system. You cannot do the following on a commissioned device:

- Schedule blocks
- Change the link master configuration
- Change the block tag
- Change the device tag
- Change the device address

3.21.2 Device blocks

Many FOUNDATION fieldbus devices organize the device parameters into separate blocks. The **Online** menu displays block information for the connected FOUNDATION fieldbus device. Devices may have a resource and transducer block, and other device-specific blocks. (Other devices may display their parameters using a device dashboard.)

Note

If you previously instantiated a block in a device, the Trex unit may not display that block. The Trex unit does not support block instantiation.

Fieldbus block modes

The resource, transducer, and all function blocks in the device have modes of operation. These modes control the operation of the block. Every block supports both automatic (Auto) and out of service (OOS) modes. Other types of modes that may also be supported are Cas, RCas, ROut, IMan and LO.

You can change the mode by tapping the mode button that is displayed at the top of the screen. The mode button displays the fieldbus logo and lists the current mode for the block.

Mode	Description
Auto	The functions performed by the block will execute. If the block has any outputs, these will continue to update. This is typically the normal operating mode.
Out of Service (OOS)	The functions performed by the block will not execute. If the block has any outputs, these will typically not update and the status of any values passed to other blocks is "BAD". Before you change the configuration of the block, change the mode of the block to OOS. When the changes are complete, change the mode back to Auto.

Mode parameters

Mode parameters change the block mode from one state to another. For example, you may want to change from Auto mode to Out of Service.

In the resource and transducer blocks, the mode parameters are often in the Process menu. In all other function blocks, the parameters are in the Common Config menu.

Mode	Description
Target	The mode that is assigned to a block and is used to change a block to a desired mode.
Actual	The current mode of the block.
Permitted	The modes that are allowed for a block. Setting the Permitted modes prevents unauthorized changes to the operating mode of a block. To do this, configure the Block:Mode Permitted parameter to allow only the desired operating modes. It is recommended to always select OOS as one of the Permitted modes.
Normal	The mode that the block should be set to during normal operation conditions.

Change the block mode for a FOUNDATION fieldbus device

Whenever you need to change the parameters or properties of a block, change the mode.

You can change the mode for a block from the Block List, or you can open a specific block and change the mode.

Procedure

1. Connect to a FOUNDATION fieldbus device.
2. To change the modes for one or more blocks on the Block List:
 - a. Tap the mode button on the Block List.
A list of all blocks and the selected modes is displayed.
 - b. For each block in the list you want to modify, select the block and select the desired mode.
 - c. Tap OK.
 - d. Tap Send.
 - e. Review the changes.
 - f. Tap Send.
3. To change the mode from within a block:
 - a. Go to a block menu in the device.

Figure 3-44: Example Mode button in a block

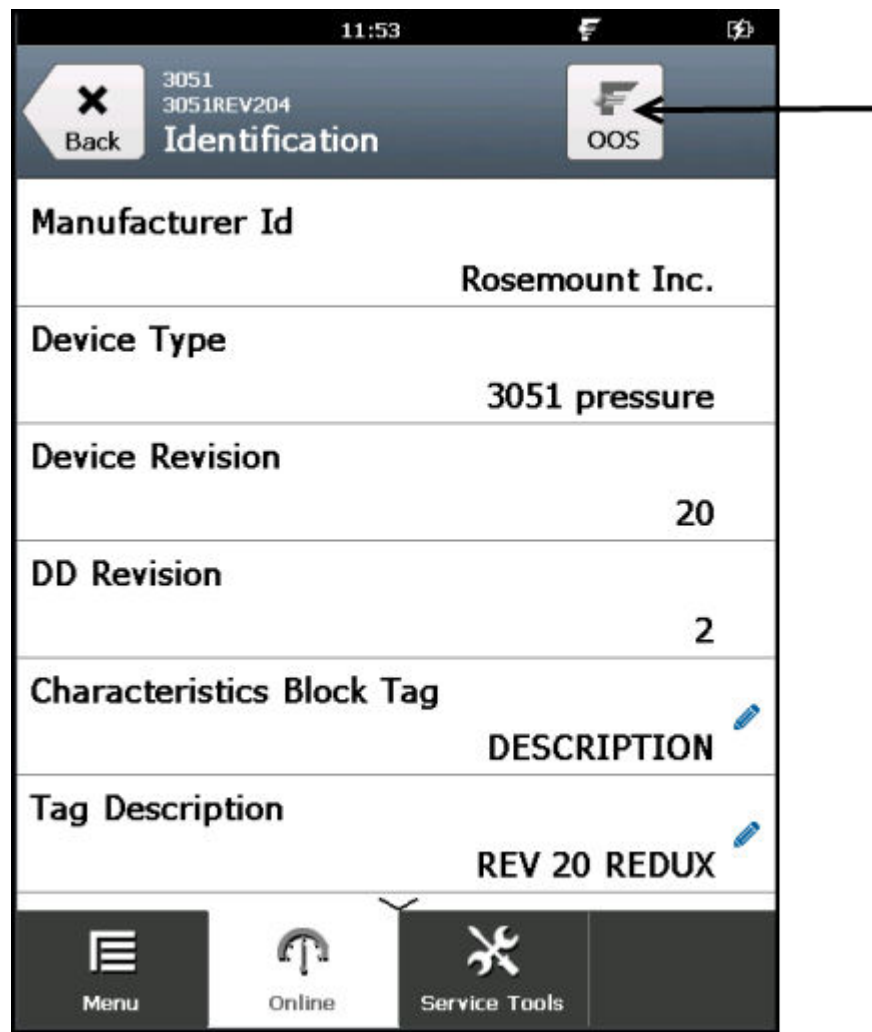

- b. Tap the mode button at the top of the screen.
- c. Select the desired mode for the block.
- d. Tap OK. The change is highlighted yellow.
- e. Tap Send.
- f. Review the change.
- g. Tap Send.

Change the IO block schedule for FOUNDATION fieldbus devices

Change the IO block schedule on the bench (not connected to a control system) to execute an IO block to verify that the outputs of the block are computed correctly.

Note

You cannot schedule IO blocks when the device is commissioned or a host/linking device is detected on the fieldbus segment. To schedule IO blocks, use the host system or remove the device from the fieldbus segment and connect it directly to the Trex unit.

Procedure

1. Connect to the FOUNDATION fieldbus device.
2. Tap the Service Tools tab.
3. Tap Write IO Block Schedule.
4. Tap OK.
5. Tap Yes or No when asked if the device is commissioned.

You cannot schedule blocks if the device is commissioned.

6. Select the appropriate macrocycle duration.
7. Select the appropriate IO blocks.
8. Tap OK.

This schedules the blocks and sets the block mode to Auto.

View the status of a block

Different devices have different options associated with them, and the selections on these menus vary accordingly. See the device documentation for more information on supported menu items.

Procedure

1. Connect to the FOUNDATION fieldbus device.
2. Tap the desired block.
3. Tap Status.

Status parameters are displayed.

3.21.3 Run a method

Different devices have different methods associated with them, and the selections on these menus vary accordingly. See the device documentation for more information on supported menu items.

Procedure

1. Connect to the FOUNDATION fieldbus device.
2. Tap the desired block. (Typically, methods are run in the transducer block.)
3. Tap a menu containing methods. The menu options will vary for each device.
4. Tap the type of method you want to run, such as calibration or diagnostic. Follow the prompts on the screen to run the method.

3.21.4 View the device information

You can view the physical device tag, device address, device ID, and device revision.

You can also view this information by tapping the device tag at the top of the screen and selecting DD Information.

Note

The physical device tag and address of a device are read-only when the device is commissioned or a host/linking device is detected on the fieldbus segment. To change the device tag or address, use the host system or remove the device from the fieldbus segment and connect it directly to the Trex unit.

Procedure

1. Connect to the FOUNDATION fieldbus device.
2. Tap Service Tools.
3. Tap one of the following options.

Option	Description
Physical Device Tag	The identifier for a device in the system.
Device Node Address	The data link layer node address of the device. The host control system can assign an address to a device when it is connected to a fieldbus segment.
Device ID	The unique identifier for a device.
Device Revision	The revision of the device.

3.21.5 Change a FOUNDATION fieldbus device parameter

You can change device parameters and then send the changes to the device.

When you select a parameter to change, you may be prompted if the device is commissioned. Some changes are prohibited for commissioned devices. You may also be prompted that the device will be disconnected from the application after you change the parameter.

⚠ WARNING!

Changing device parameters could adversely affect the control of your process. Put the control loop in Manual/Out of Service before applying changes. Verify the output before returning the control loop to Auto. Failure to do so could result in property damage, serious injury, or death. Ensure all safety precautions and work procedures have been followed.

Procedure

1. Connect to the FOUNDATION fieldbus device.

2. Go to the parameter you want to change.
See the device documentation for more information. Each device uses different menus.
3. If prompted, select if the device is commissioned.
4. Change the parameter.

Note

The Trex unit may disconnect from the device after you make the change. If this occurs, the change is automatically sent to the device without any additional input from you.

5. Tap Send.
6. Review the change.
Tap Discard to undo the change and close the screen. Tap Cancel to keep the change and send it to the device at a later time.
7. Tap Send.
8. Tap OK.

3.21.6 Change the tag for a FOUNDATION fieldbus device

Note

You cannot change the tag when the device is commissioned or a host/linking device is detected on the fieldbus segment. To change the tag, use the host system or remove the device from the fieldbus segment and connect it directly to the Trex unit.

Procedure

1. Connect to the FOUNDATION fieldbus device.
2. Tap Service Tools.
3. Tap Physical Device Tag.
4. Tap OK when prompted that the device will be restarted after the parameter is changed.
5. Tap Yes or No when asked if the device is commissioned.
You cannot make changes if the device is commissioned.
6. Enter a new tag, and tap OK.
The Trex unit disconnects from the device.
7. Tap OK on the message that indicates the device has been disconnected from the Trex unit.
The Device List appears and displays the device with the new tag.

8. Tap the device to reconnect to it.

3.21.7 Guidelines for changing the device address

Note

The physical address of a FOUNDATION fieldbus device is read-only when the device is commissioned or a host/linking device is detected on the fieldbus segment. To change the device address, use the host system or remove the device from the fieldbus segment and connect it directly to the Trex unit.

The host control system can assign an address to a device that is connected to a fieldbus segment. When you assign device addresses, follow the guidelines below:

- Addresses below 16 are not available.
- Addresses between 16 and 19 are usually reserved for host systems. A device should not be assigned in this address range.
- Valid device addresses are between 20 and 247.
- Addresses between 248 and 251 are temporary addresses. Devices without a tag or address appear on the fieldbus segment at these addresses.
- Addresses between 252 and 255 are reserved for visitors, such as the Trex unit.

3.21.8 Change the device address for a FOUNDATION fieldbus device

Note

The physical address of a FOUNDATION fieldbus device is read-only when the device is commissioned or a host/linking device is detected on the fieldbus segment. To change the device address, use the host system or remove the device from the fieldbus segment and connect it directly to the Trex unit.

Procedure

1. Connect to the FOUNDATION fieldbus device.
2. Tap Service Tools.
3. Tap Device Node Address.
4. Tap OK when prompted that the device will be restarted after the parameter is changed.
5. Tap Yes or No when asked if the device is commissioned.
You cannot make changes if the device is commissioned.
6. Enter the new address, and tap OK.
The Trex unit disconnects from the device.

7. Tap OK on the message that indicates the device has been disconnected from the Trex unit.

The Device List appears and displays the device at the new address.

8. Tap the device to connect to it.

3.21.9 Polling for FOUNDATION fieldbus devices

When you connect the Trex unit to a FOUNDATION fieldbus device, the Field Communicator application polls the most common addresses for a fieldbus segment. You cannot set a specific range or a specific address. If the device is not detected, tap the My Device Not Found option to have the Field Communicator application automatically expand the polling range, if the Trex unit is the LAS. This option expands the following settings:

- Polling addresses - By default, the Trex unit polls addresses 0-48 and 232-255. This range is then expanded to include all valid fieldbus addresses.
- Slot time - The slot time is increased to enable the Trex unit to find older FOUNDATION fieldbus devices on the fieldbus segment.

3.21.10 Set a FOUNDATION fieldbus device to be a link master or basic device

If a device can be a Link Active Scheduler (LAS), the Link Master Configuration menu option displays in the Service Tools menu. Select Master if you want the device to attempt to be the LAS, or select Basic to prevent the device from becoming the LAS. After you set the option, the Trex unit disconnects from the device.

Setting the device as a link master does not set the device as the LAS. The link master device must follow the process to become the LAS if other link master devices are on the fieldbus segment.

Note

You cannot change the device to be a link master or basic device when a host/linking device is detected on the fieldbus segment. To change the device to be a link master or basic device, use the host system or remove the device from the fieldbus segment and connect it directly to the Trex unit.

Procedure

1. Connect to the FOUNDATION fieldbus device.
2. Tap Service Tools.
3. Tap Link Master Configuration.
4. Tap OK when prompted that the device will be restarted after the parameter is changed.
5. Tap Yes or No when asked if the device is commissioned.

You cannot make changes if the device is commissioned.

6. Select Basic or Master, and tap OK.
7. Tap OK to restart the device and apply the changes.

The Trex unit displays the Device List.

3.22 Simulate a live device

You can simulate an online connection to a device without connecting to a device. Simulation mode is a training tool that helps you become familiar with devices before configuring them in a critical environment.

Note

Not all device descriptions have been optimized to run in simulation mode.

Procedure

1. In the Field Communicator application, tap HART Offline or Fieldbus Offline on the Connect - Select screen.
2. Tap Simulate.
3. Tap a device manufacturer.
4. Tap the device type.
5. Tap the device revision.
6. Tap OK when the device information is displayed.

The device menu is displayed. You can view the device menus and configure parameters.

7. To end simulation, tap Menu > Disconnect or close the Field Communication application.

3.23 View the device descriptions on the Trex unit

You can view all the device descriptions that are installed on the Trex unit. The device descriptions are organized by the HART or FOUNDATION fieldbus protocol.

Procedure

1. In the Field Communicator application, tap HART Offline or Fieldbus Offline on the Connect - Select screen, depending on the type of device descriptions you want to view.
2. Tap Simulate.
3. Select a device manufacturer.
4. Select a device type.

The device revision and device description revision are displayed.

5. Tap Cancel to return to the offline menu.

3.24 View the device description information

You can view information about the connected device, including the manufacturer, device type, device revision, and device description revision.

The Tag and Long Tag options displayed below appear for only HART revision 7 devices.

Procedure

1. Connect to the HART or FOUNDATION fieldbus device.
2. Tap the tag that is displayed on the top of the screen.

Figure 3-45: Tap the device tag

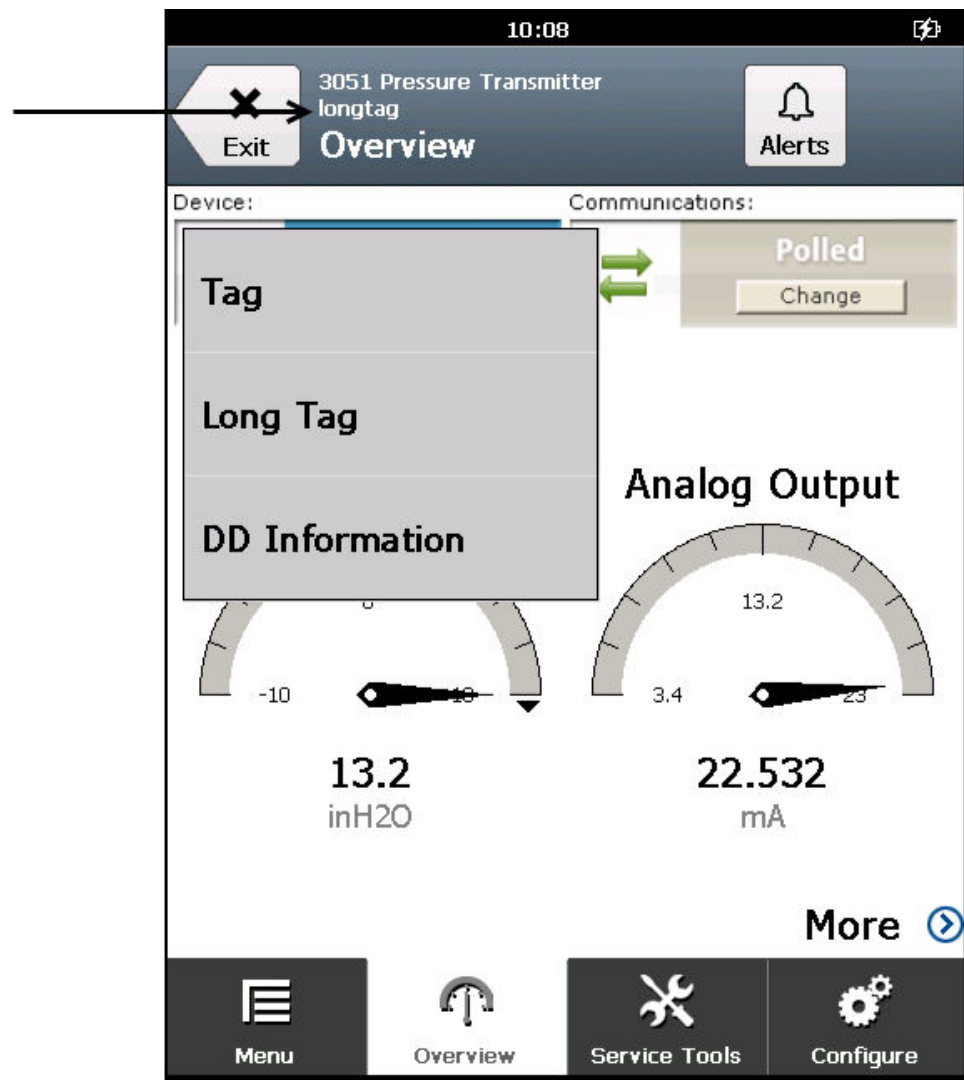

3. Tap DD Information.
The device description information is displayed.
4. Tap OK.

3.25 View Help for a device parameter

1. Go to the desired parameter in the connected device.
2. Press and hold the parameter.
A menu appears.
3. Tap Help.
The help text is displayed.
4. Tap OK to close the Help screen.

3.26 Graphics

The Electronic Device Description Language (EDDL) capabilities let the Trex unit display graphics for the connected devices. You can view HART or FOUNDATION fieldbus device information as images, charts, and graphs.

Each type of graphic lets you zoom in, zoom out, and reset the graphic. You can also use the drop down box to select a variable, if multiple variables are displayed.

Figure 3-46: Graphics options

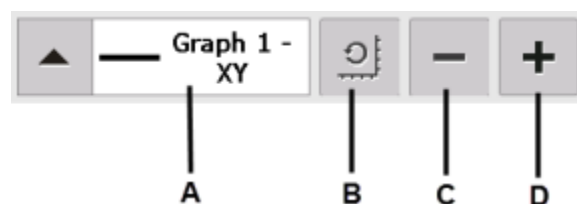

- A. Select a variable. The selected variable is displayed with a bold line.
- B. Reset the zoom level.
- C. Zoom out
- D. Zoom in

3.26.1 Images

An image is a full-screen picture of a device. Images can include logos and various graphics, such as tanks. To view the image, select the image or drawing label in the menu. The full screen image is shown. To close the image, tap the touchscreen.

Some images have links that let you run methods or view additional menus. If an image has a link, a button is displayed at the bottom of the screen.

3.26.2 Charts

Charts display a graphic view of variables as they occur over time. There are four types of charts:

Chart type	Description
Strip/sweep/scope	<p>Displays variable data with an x-axis of time.</p> <p>A strip chart continually updates the chart, scrolling from right to left.</p> <p>A sweep chart updates the window from left to right, and then updates the window from left to right again, overwriting the oldest data. A vertical line is used to separate the old and new data. When the data reaches the right edge of the screen, the data is then plotted from the left edge of the screen and the x-axis is updated.</p> <p>A scope chart updates the window from left to right. When the data reaches the right edge of the screen, the screen is cleared and the x-axis is updated.</p>
Horizontal bar	Displays data represented as bars from left to right.
Vertical bar	Displays data represented as bars from bottom to top.
Gauge	Displays a gauge chart, similar to an analog car speedometer.

Note

If a chart is displayed for an extended time period, the Trex unit may have decreased response time due to the large number of data points in the chart.

3.26.3 Strip/sweep/scope chart

The strip/sweep/scope chart formats device data into a line chart that displays device data over time. The labels and axis displayed are determined by the device manufacturer. Use the drop-down list to select the variable you want to highlight.

The selected variable is displayed as a bold, solid-colored line. Other variables that share the same source or same Y-axis appear as thin or dashed colored lines on the chart. The colors are determined by the device description and may vary between devices. A vertical line may be displayed in the chart to distinguish between the old and new data. The vertical line advances as new data is displayed.

The time shown on the x-axis starts at the time the chart starts. The chart update rate is determined by the device manufacturer. The default chart update rate is 1 second.

Figure 3-47: Strip chart

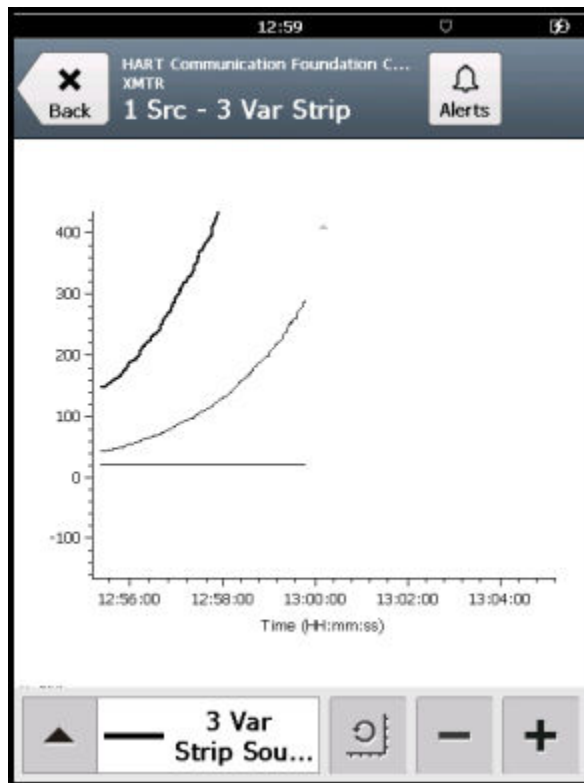

3.26.4 Horizontal bar charts

A horizontal bar chart formats device data into bars from left to right and varies with time. Use the drop-down list to select the variable you want to highlight. Additional horizontal bars may be present if more than one variable is defined for the option you selected in the drop-down list. The selected variable from the drop-down list is outlined in color and has a black dot at the end of it. The colors are determined by the device description and may vary between devices. The labels and axis displayed are determined by the device manufacturer.

The chart update rate is determined by the device manufacturer. The default chart update rate is 1 second.

Figure 3-48: Horizontal bar chart

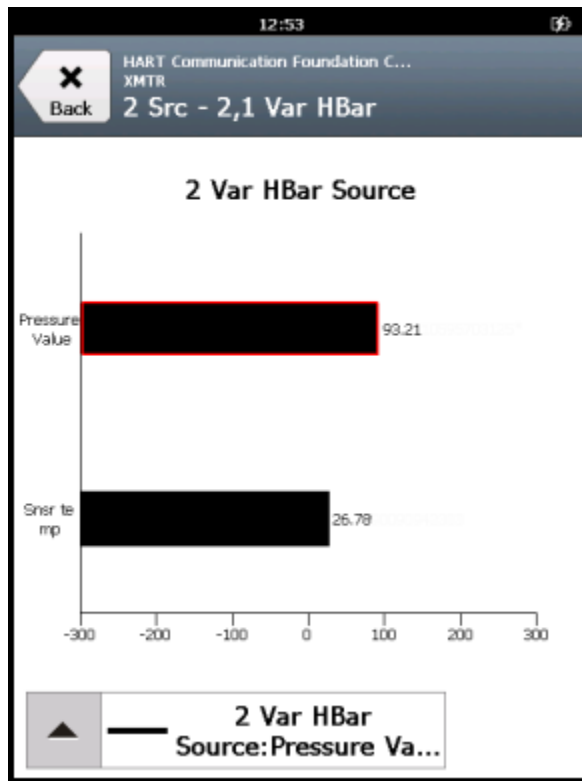

3.26.5 Vertical bar charts

A vertical bar chart formats device data into bars from bottom to top and varies with time. Use the drop-down list to select the variable you want to highlight. Additional vertical bars may be present if more than one variable is defined for the option you selected in the drop-down menu. The selected variable from the drop-down list is outlined in color and has a black dot above it. The colors are determined by the device description and may vary between devices. The labels and axis displayed are determined by the device manufacturer.

The chart update rate is determined by the device manufacturer. The default chart update rate is 1 second.

Figure 3-49: Vertical bar chart

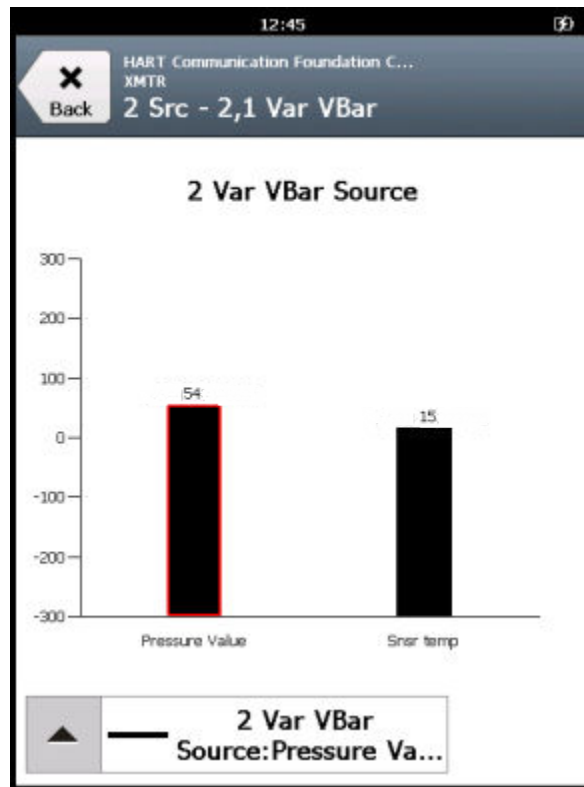

3.26.6 Gauge charts

A gauge chart formats device data into a view similar to an analog car speedometer and plots device data varying with time. Use the drop-down list to select the variable you want to highlight. Additional gauge needles may be present if more than one variable is defined.

The selected variable from the drop-down list appears as a long, colored needle while the other variables appear as short, colored needles. The colors displayed are determined by the device description and may vary between devices. A gauge chart can have up to three variables. The labels and axis displayed are determined by the device manufacturer.

The chart update rate is determined by the device manufacturer. The default chart update rate is 1 second.

Figure 3-50: Gauge chart



3.26.7 Graphs

A graph is a snapshot line drawing of device information. Use the drop-down list to select the variable you want to highlight. Additional variables may be present if more than one is defined for the option selected in the drop-down list.

The selected variable from the drop-down list appears as a bold, solid-colored line while the other variables with the same Y-axis appear as thin colored lines. The colors displayed are determined by the device description and may vary between devices. The labels and axis displayed are determined by the device manufacturer.

You may also see symbols such as circles on some variables. These show keypoints that indicate the important values on a graph. If more than seven variables are on the graph, "+" symbols are displayed for the keypoints.

Figure 3-51: Graph

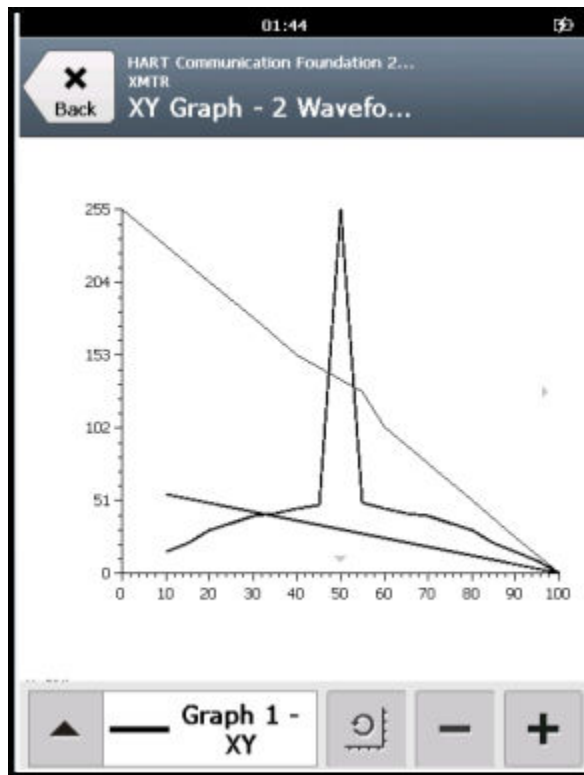

3.27 Disconnect a device

Prerequisites

Before you disconnect the Trex unit from a device, resolve any unsent data to the device.

Procedure

Tap Menu > Disconnect or remove the lead set from the device or the Trex unit.

The Trex unit detects the loss of voltage or current and stops communicating with the device. If the Trex unit was powering the device, the Trex unit stops providing power when the lead set is removed. The Connect - Select screen is displayed.

4 Loop Diagnostics application

Topics covered in this chapter:

- *Open or close the Loop Diagnostics application*
- *Loop Diagnostics screen*
- *Powering transmitters or positioners from Loop Diagnostics*
- *Voltage and current measurements in Loop Diagnostics*
- *Wiring diagrams for the Loop Diagnostics application*
- *Power a 2-wire transmitter*
- *Power a 2-wire transmitter and measure analog output*
- *Power a positioner*
- *Stroke a valve*
- *Settings for controlling current*
- *Loop checks*

The Loop Diagnostics application helps you troubleshoot the wiring of a 4-20 mA current loop by measuring the voltage and the current. The application can also power a transmitter or positioner to isolate the device from its current loop and to verify its operation.

Note

The Trex unit needs the Device Communicator Plus communication module to use the Loop Diagnostics application. You may also need a second lead set.

If you connect the Trex unit's HART terminals in series with an externally-powered loop, you can enable Trex Unit Current and have the Trex unit control current (similar to how a transmitter controls current). Controlling current lets you do the following:

- Verify the input module on a digital control system.
- Verify the cabling between the connection point and the input module on a digital control system.
- Move a positioner.

If the Trex unit is not connected to an externally-powered loop, you can enable Trex Unit Power to power one transmitter or positioner. This helps you isolate a problematic device from its current loop and verify its operation. Powering a device lets you do the following:

- Verify a transmitter in isolation by powering the device and measuring the output.
- Verify a positioner in isolation by powering and moving the positioner.
- Perform wiring continuity checks on cables where no power exists.

⚠ WARNING!

The Loop Diagnostics application is a generic tool that, if misused, can interfere with an operating HART loop or may damage the ammeter in the Device Communicator Plus communication module. Do not provide Trex power or current on a loop that is in operation. Do not provide external power directly across the Trex mA terminals because this may damage the ammeter.

4.1 Open or close the Loop Diagnostics application

1. To open the Loop Diagnostics application, tap the Loop Diagnostics icon on the Trex Home screen.
2. To close the Loop Diagnostics application, tap Exit.

If you enabled the Trex unit to power a device, the Trex unit stops providing power when you close the Loop Diagnostics. If the Trex unit was powering a positioner, the application prompts you to select a current value for the positioner before the application closes. This allows you to move the positioner to a safe position. After the selected current value is reached, the Trex unit stops providing power.

4.2 Loop Diagnostics screen

The Loop Diagnostics screen is divided into three sections:

Figure 4-1: Loop Diagnostics screen at start up

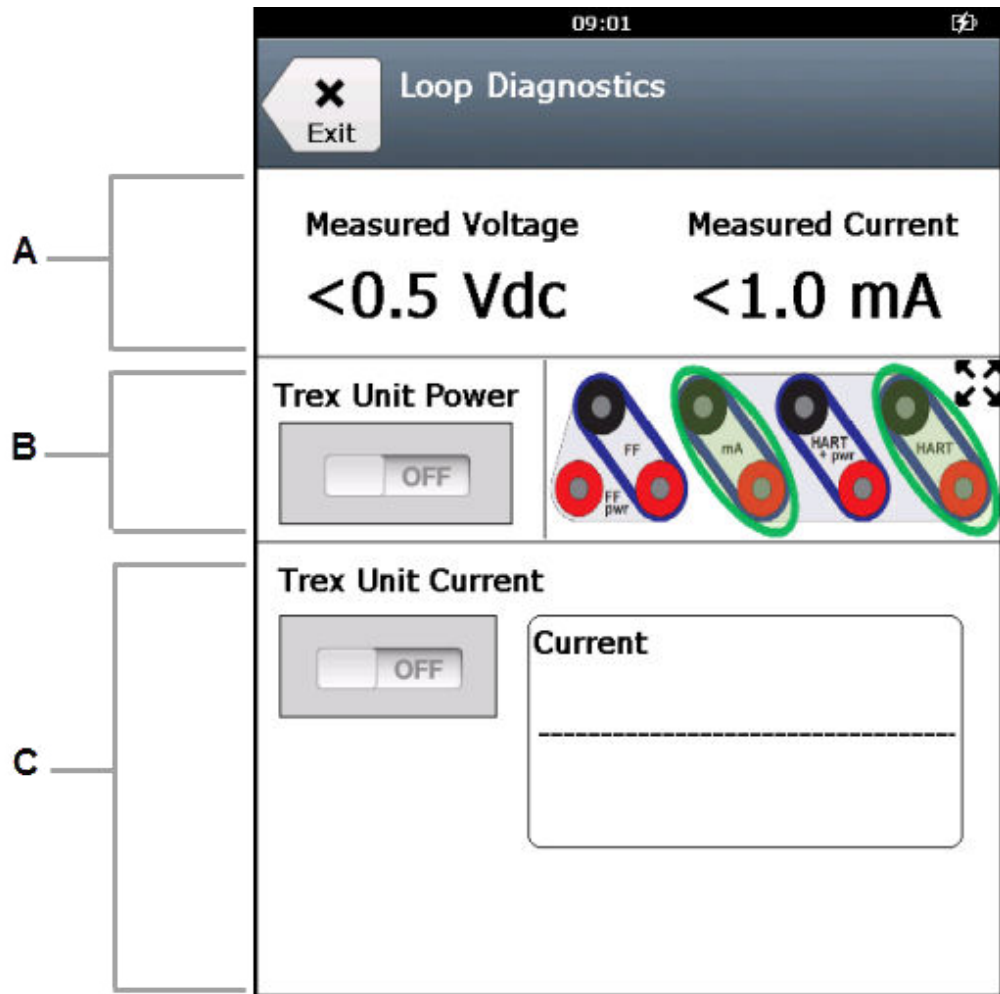

- A. **Measurement section:** Displays the measured voltage and current. The measurements begin when the Loop Diagnostics screen is displayed, and the measurements update about once per second. See [Section 4.4](#) for more information about the terminals used for each measurement.
- B. **Power/Help section:** Lets you enable/disable the Trex unit to power a transmitter or positioner. The connection diagram on the right shows the terminals on the Trex unit where measurements are being read.

By default, the HART and mA terminals are circled in green on the connection diagram. The diagram shows you one setup for reading voltage on the HART terminals and current on the mA terminals when Trex Unit Power is off. (This setup lets you take the measurements without interrupting the 4-20 mA current loop by connecting the Trex HART terminals to a transmitter's communication terminals and connecting the Trex mA terminals to a transmitter's test terminals.) The connection diagram is updated based on the options you select (Trex Unit Power and Trex Unit Current).

- C. **Current control/output section:** Lets you use multiple options for controlling current including quick buttons, keypad, and up/down keys for immediately adjusting current or for gradually changing current over 1 to 5 seconds. These options are displayed when either the Trex Unit Power or Trex Unit Current is ON.

Figure 4-2: Loop Diagnostics when powering a positioner and taking measurements

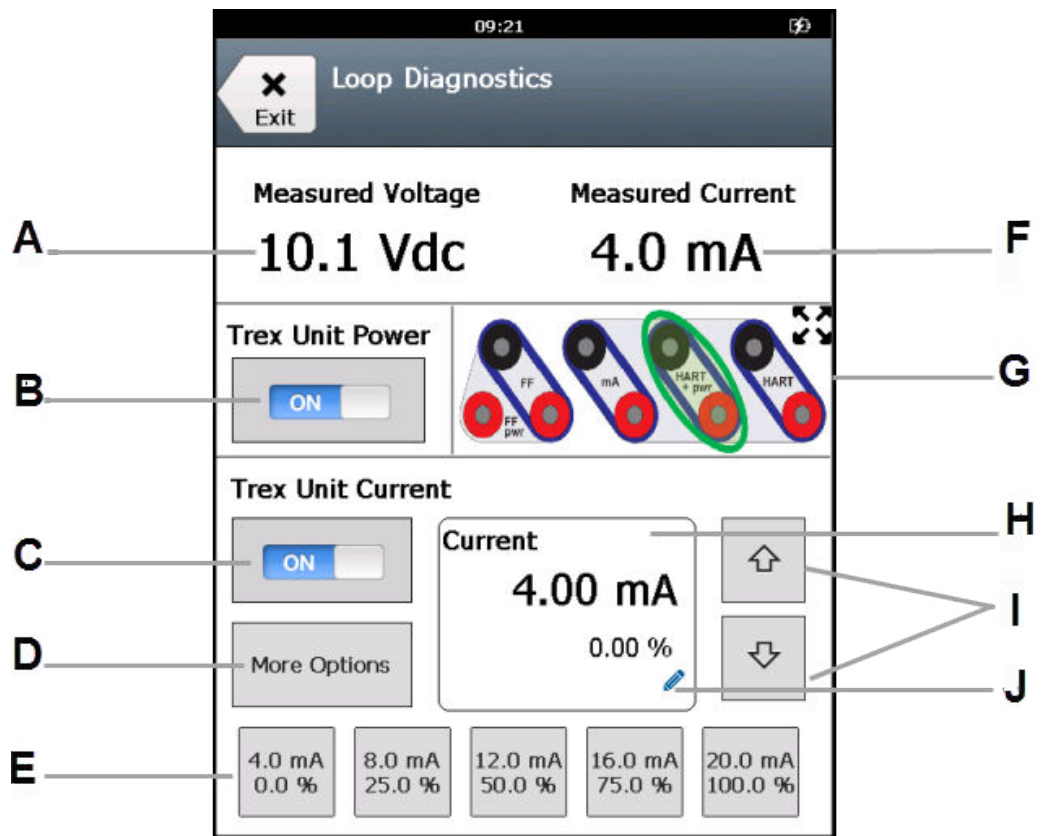

- A. The voltage measured at the HART or HART + pwr terminals
- B. Enable/disable the Trex unit to provide power to a transmitter or power and source current to a positioner. This lets you isolate a problematic device from its HART loop and verify its operation. Use the HART + pwr terminals on the Trex unit.
- C. Enable/disable the Trex unit to control current to an externally-powered positioner or to an analog input card on a digital control system. The Trex unit controls current the same way as a transmitter. Use the HART terminals on the Trex unit when the Trex Unit Power option is off. This option is automatically enabled if Trex Unit Power is on and the Trex unit is powering a positioner.
- D. Change the settings for supplying/controlling current, including the values of the quick buttons, the scale for the up and down arrows, and the time to change to a new current value. This option is enabled only when Trex Unit Power or Trex Unit Current is on.
- E. The quick buttons to control the current to the positioner or 4-20 mA current loop. You can change the values of the buttons from the More Options button.
- F. The current measured at the mA, HART + pwr, or HART terminals on the Trex unit. If Trex Unit Power is off and Trex Unit Current is on, use the HART terminals to measure current.
- G. The terminals that are controlling/measuring current and voltage are circled in green. Tap the image to see a larger version.
- H. The current that the Trex unit is supplying.
- I. The up and down arrows to gradually increase or decrease the current. The default increment is 0.10 mA. You can change this increment from More Options.
- J. Tap the pencil icon to enter a new current value to be supplied.

4.2.1 View the connection diagram as a full-screen image

The Loop Diagnostics screen displays an image of the terminals on the Trex unit to help you make the correct connection and to see where the measurements are read. The image changes to display the correct connection for a desired task, based on the measurements or options you selected. You can view a full-screen version of this image.

Procedure

1. Tap the image of the terminals on the Loop Diagnostics screen.
A larger image is displayed.
2. Tap OK to close the full-screen view, and return to the Loop Diagnostics screen.

4.3 Powering transmitters or positioners from Loop Diagnostics

The Trex Unit Power option in the Loop Diagnostics application enables the Trex unit to power one transmitter or positioner in a bench setup. This lets you isolate a problematic device from its HART loop and verify its operation, or perform wiring continuity checks on cables where no power exists.

Use the HART + pwr terminals on the Trex unit to connect to the transmitter or positioner. When you tap the Trex Unit Power option, you can select the type of device (transmitter or positioner) to power.

The Trex unit notifies you if it measures voltage at the HART + pwr terminals when you try to turn on Trex Unit Power. If the measured voltage is less than 8 volts, the Loop Diagnostics application assumes that the voltage may be from the device, and you can select to ignore the low voltage and provide power from the Trex unit. If the voltage is greater than or equal to 8 volts, the Loop Diagnostics application will not let you enable Trex Unit Power to power a device.

The Trex Unit Power immediately turns off if the Loop Diagnostics application detects one of the following:

- A short circuit.
- The lead set is no longer connected to the device.
- A very high device-load that exceeds the capacity of the Trex Unit Power option.

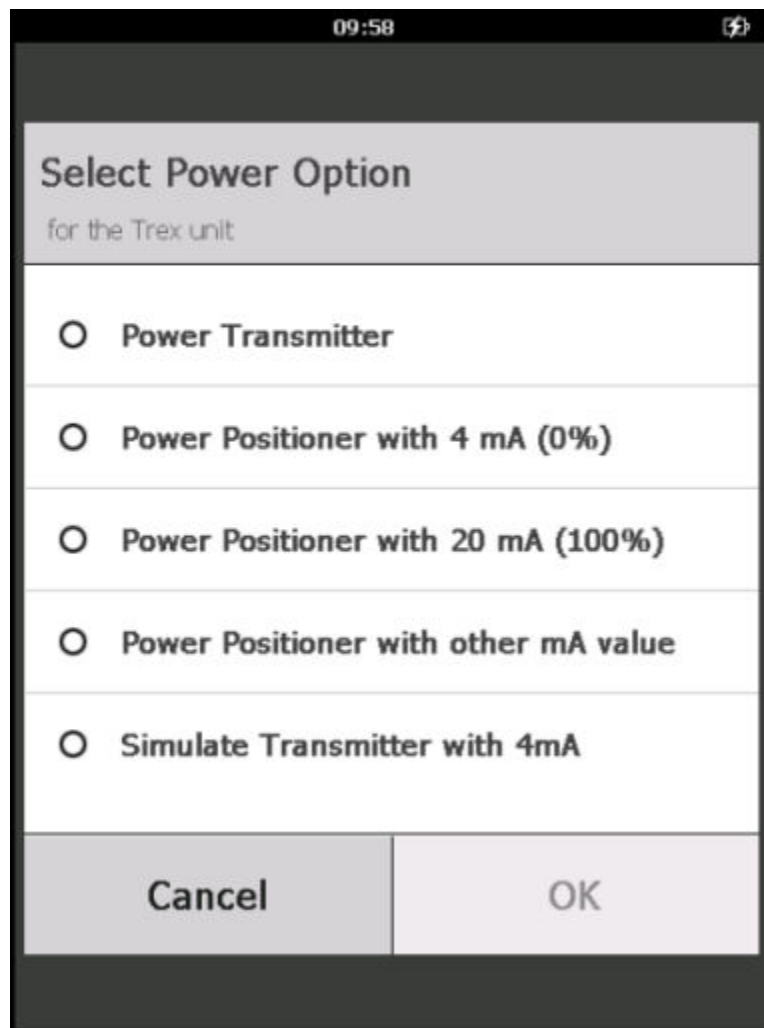
Figure 4-3: Select the type of device to power

Power a transmitter

The Trex unit can power one transmitter. When the Trex unit powers a transmitter, an internal 167 Ohm resistor is used, so an external resistor is not necessary. If you already connected an external resistor in series with the red or black HART terminal on the Trex unit, there will be less voltage available for the device, especially at 20 mA. This may cause the device to power off. The Trex unit begins providing power when you tap OK.

⚠ WARNING!

Do not insert a resistor in parallel with either the HART + pwr or HART terminals on the Trex unit or in parallel with the device's communication terminals. This will interfere with the current measurements.

Power a positioner

The Trex unit can power one positioner and set the current to 4 mA, 20 mA, or another value between 3.5 and 22.5 mA. This allows you to set the position of the valve. The Trex unit begins providing power and current when you tap OK.

When the Trex unit provides power to a positioner, the Trex Unit Current option is also enabled. This allows you to control the current to the device by using the quick buttons, the pencil icon, or the up/down arrow keys.

Simulate a transmitter with 4 mA

The Loop Diagnostics application lets you simulate a transmitter to verify an analog input loop before installing a device. This option is useful to perform a loop check on an analog input that will be wired to a 4-wire transmitter, or on an unpowered loop that has 2-wire devices. The Trex unit provides power and 4 mA to the current loop.

Disable power to a device

To disable power, tap Trex Unit Power to set it to OFF. The Trex unit also stops providing power if you tap Exit or remove the lead set from the device or the Trex unit.

If the Trex unit is powering a positioner, it is recommended that you disable power by tapping Trex Unit Power. This allows you to move the positioner to a safe position without causing any unexpected moves from the valve when the Trex unit stops providing power. You can select 4 mA, 20 mA, or the present value. After the desired current level is reached, the Trex unit stops providing power.

Note

The Loop Diagnostics application has a Duration of Current Change option that lets you set how quickly the device will reach the set current level. If the Duration of Current Change option is not set to zero, the current changes gradually to the selected current. This is intended to protect large equipment from potential damage from abrupt movement.

4.4 Voltage and current measurements in Loop Diagnostics

The Trex unit can read voltage and current in several ways.

The voltage is measured from the HART terminals on the Trex unit when Trex Unit Power is off, or from the HART + pwr terminals on the Trex unit when the Trex Unit Power is on.

The current measurements are taken at one of the following:

1. The mA terminals when the Trex Unit Power is off and Trex Unit Current is off. If a device has test terminals, you can measure current using the mA terminals on the Trex unit.
2. The HART terminals when the Trex Unit Power is off and Trex Unit Current is on.
3. The HART + pwr terminals when the Trex Unit Power is on and the Trex unit is powering a transmitter.

4. The HART + pwr terminals when the Trex Unit Power is on and the Trex unit is powering a positioner.

See [Section 4.5](#) for more information.

4.5 Wiring diagrams for the Loop Diagnostics application

⚠ CAUTION!

Remove the USB cable from the Trex unit before connecting to a device.

⚠ WARNING!

- Do not connect lead sets to the HART and HART + pwr terminals at the same time. If the lead sets are connected to devices, this increases the chance of wiring mistakes and could create a short in the HART loop.
 - Do not add any external power to the device when the Trex unit is powering the device. This can blow a fuse inside the Trex unit. The repair/replacement will need to be completed at an authorized service center. Ensure the device is disconnected from the loop/segment and no other wires are connected to the device before providing power from the Trex unit.
 - The Trex unit cannot power a 4-wire device. Do not connect Trex unit to the power terminals of a 4-wire device. This can blow a fuse inside the Trex unit. The repair/replacement will need to be completed at an authorized service center.
 - Do not connect the mA terminals (ammeter) in parallel with a powered 4-20 mA current loop. Ammeters have low resistance. This can disrupt the loop and cause devices to report incorrect values or positioners to move unexpectedly.
 - Do not connect the mA terminals on the Trex unit to a power supply that is not current limited to 250 mA. This can blow a fuse inside the Trex unit. The repair/replacement will need to be completed at an authorized service center.
-

Figure 4-4: Power a HART transmitter

The Trex unit measures both voltage and current from the HART + pwr terminals. An internal 167 Ohm resistor is used when the Trex unit powers the device.

⚠ CAUTION!

Do not insert a resistor in parallel with either the HART + pwr or HART terminals on the Trex unit, or in parallel with the device's communication terminals. This will interfere with the current measurements and may prevent communication.

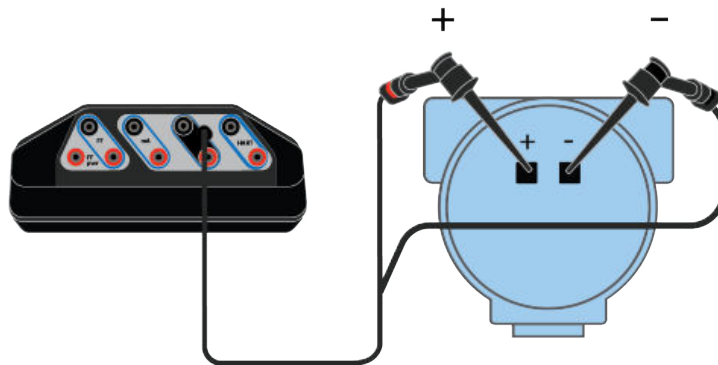
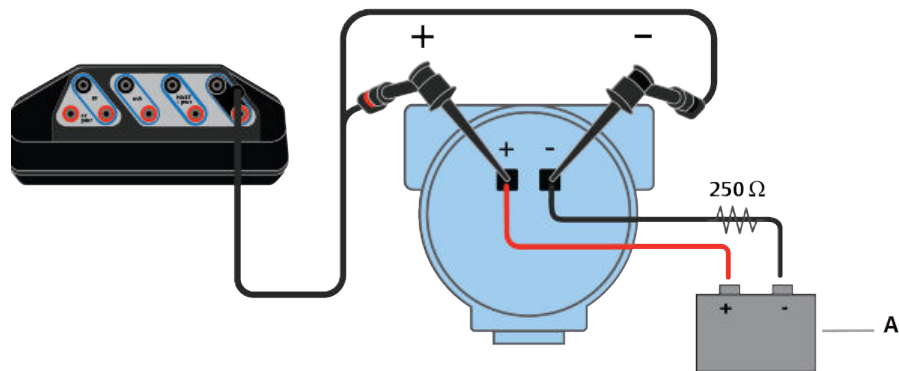
**Figure 4-5: Measure voltage on an externally-powered HART transmitter**

A. Voltage source

Figure 4-6: Power and control current to a positioner

The Trex unit measures both voltage and current from the HART + pwr terminals.

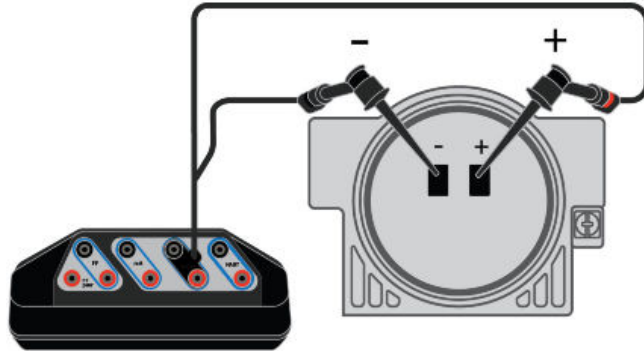
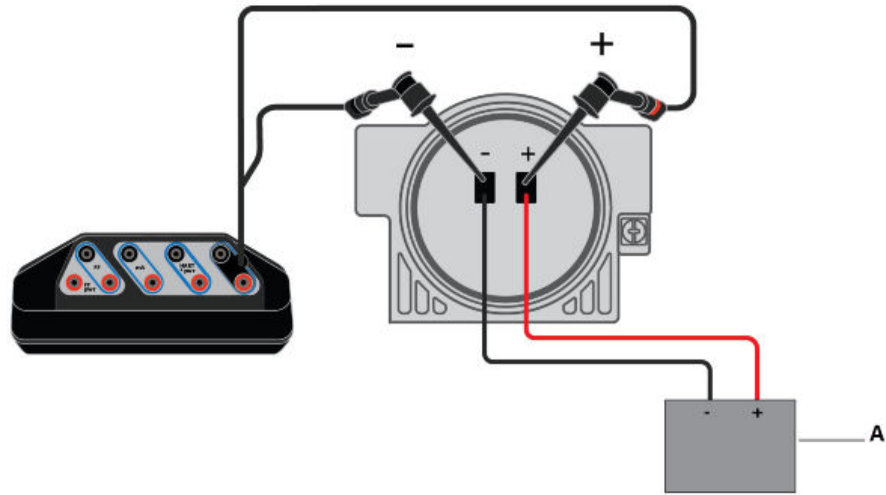

Figure 4-7: Connect to an externally-powered positioner in-parallel

The Trex unit measures voltage from the HART terminals. Voltage measurements can be taken at various points to identify voltage drops along the loop.



A. Current source

Figure 4-8: Connect to an externally-powered positioner in-series

The Trex unit controls current from the HART terminals.

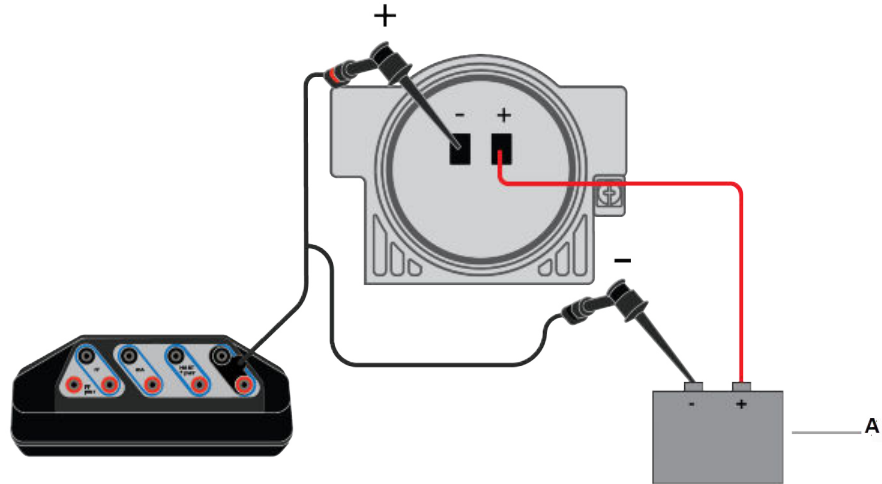

A. Voltage source

Figure 4-9: Control current to simulate a transmitter on an externally-powered loop

The Trex unit controls current from the HART terminals, which simulates a transmitter. The Trex unit controls current the same way as a transmitter controls current. The Trex unit is connected to the analog input (AI) channel.

You can connect the Trex unit at various points on the current loop, including a junction box, device connection point, etc.

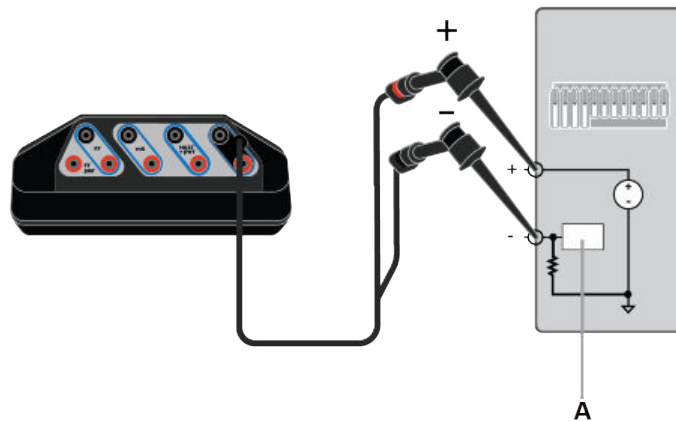

A. Analog input

Figure 4-10: Read current for an analog output loop check

The Trex unit is connected to an analog output and is measuring current from the mA terminals. You can connect the Trex unit at various points on the current loop, including a junction box, device connection point, etc.

⚠ WARNING!

Do not connect the mA terminals on the Trex unit to a power supply that is not current limited to 250 mA. This can blow a fuse inside the Trex unit. The repair/replacement will need to be completed at an authorized service center.

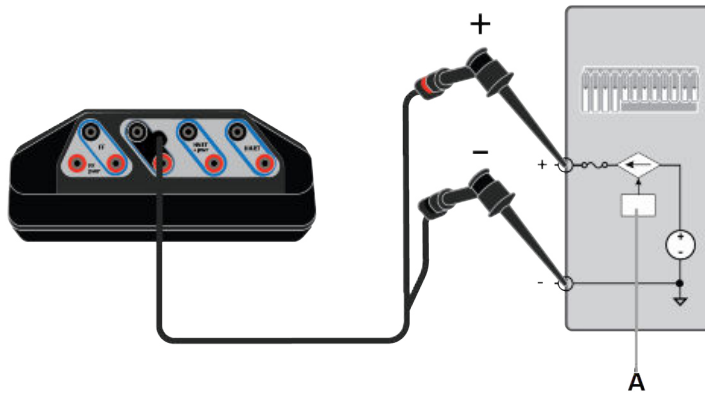

A. Analog output

Figure 4-11: Connect to an externally-powered positioner and read current

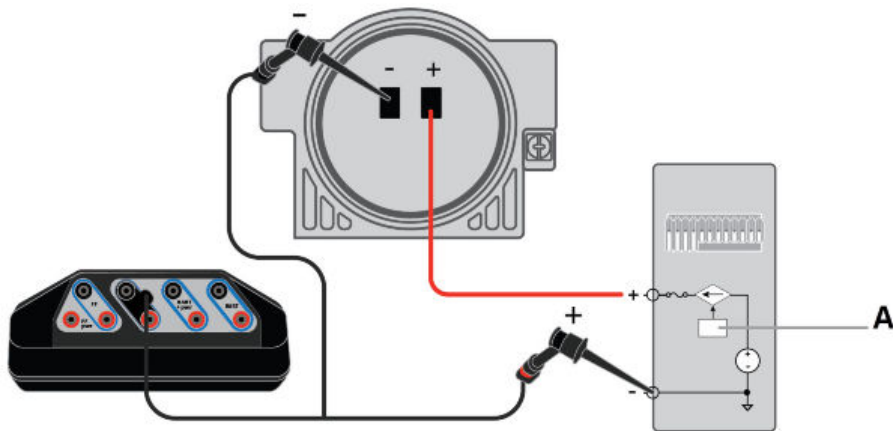

A. Analog output

Figure 4-12: Measure current from an externally-powered transmitter device with test terminals

The Trex unit measures current from the mA terminals on an externally-powered loop without breaking the loop and connecting the ammeter (mA terminals) in-series.

⚠ WARNING!

Do not insert a resistor in parallel with either the HART + pwr or HART terminals on the Trex unit, or in parallel with the device's communication terminals. This will interfere with the current measurements.

Note

Please review your device documentation for additional information about reading current from the test terminals. The orientation of the terminals on your device may be different. The drawing below is an example.

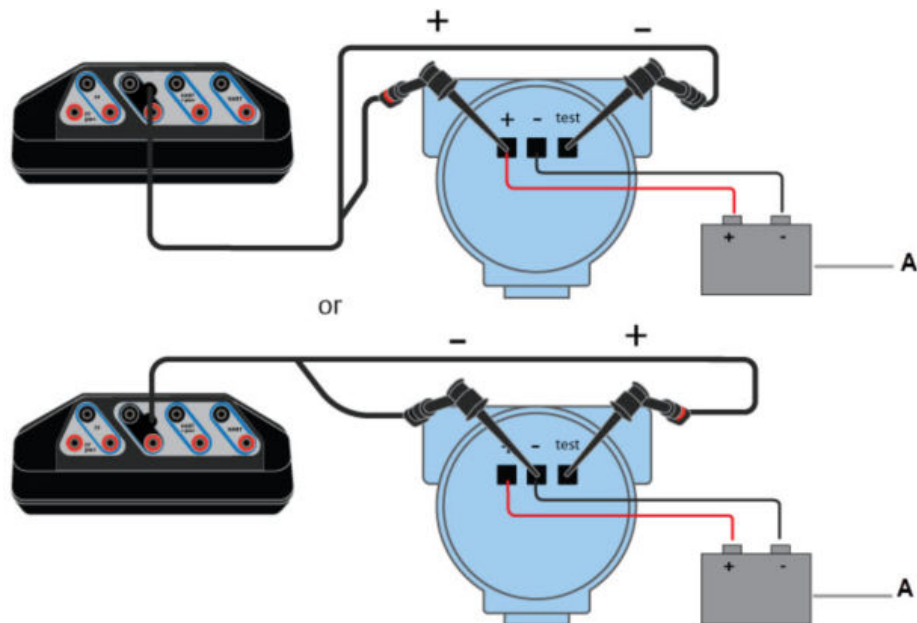

A. Voltage source

Figure 4-13: Power and control current to simulate a transmitter on an unpowered loop

Note

The Trex unit is connected to a 4-wire terminal block. Consult the host documentation for more information.

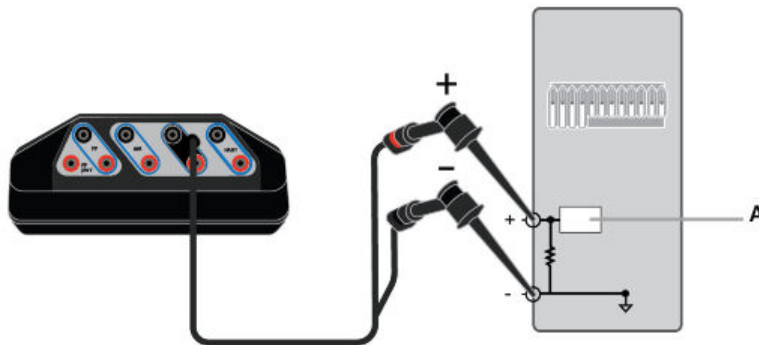

A. Analog input

4.6 Power a 2-wire transmitter

The Trex unit can provide up to 16 volts (at 22.5 mA) to power a HART device. You do not need to add an external resistor. The Trex unit has a 167 Ohm internal resistor in the HART + pwr terminals that is used when the Trex unit provides power to the transmitter.

If you try to apply power from the Trex unit when the device is externally-powered, the Loop Diagnostics application prevents the Trex unit from supplying power. This protects the Trex unit from damage.

⚠ CAUTION!

Remove the USB cable from the Trex unit before connecting to a device.

⚠ CAUTION!

Do not add any external power to the device when the Trex unit is powering the device. This can blow a fuse inside the Trex unit. The repair/replacement will need to be completed at an authorized service center. Ensure the device is disconnected from the loop/segment and no other wires are connected to the device before providing power from the Trex unit.

Note

Do not insert a resistor in parallel with either the HART + pwr or HART terminals on the Trex unit, or in parallel with the device's communication terminals. This will interfere with the current measurements and may prevent communication.

Procedure

1. Connect the lead set to the HART + pwr terminals on the Trex unit and to the transmitter.

Figure 4-14: Power a 2-wire transmitter

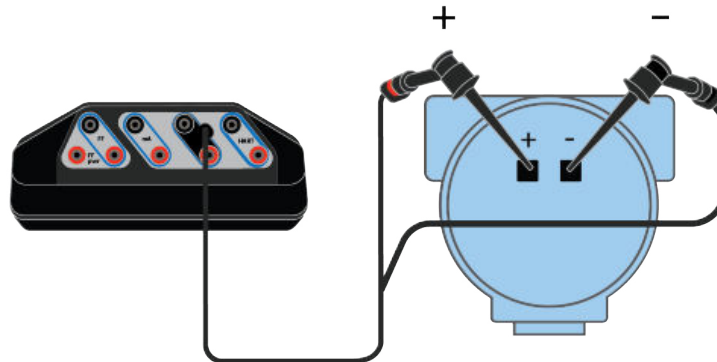

2. On the Loop Diagnostics screen, tap Trex Unit Power.
3. Tap Power Transmitter.
The Trex unit uses an internal resistor while powering the device.
4. Tap OK.
Loop Diagnostics is now powering the transmitter and measuring voltage and current.
5. To stop powering the device, do one of the following:
 - Tap Trex Unit Power to set the option to Off.
 - Tap Exit.
 - Remove the lead set from the Trex unit.

4.7 Power a 2-wire transmitter and measure analog output

You can remove a 2-wire HART transmitter from a loop, use the Trex unit to power the transmitter, and then measure the analog output.

If you try to apply power from the Trex unit when the device is externally-powered, the Loop Diagnostics application prevents the Trex unit from supplying power. This protects the Trex unit from damage.

⚠ CAUTION!

Remove the USB cable from the Trex unit before connecting to a device.

⚠ CAUTION!

Do not add any external power to the device when the Trex unit is powering the device. This can blow a fuse inside the Trex unit. The repair/replacement will need to be completed at an authorized service center. Ensure the device is disconnected from the loop/segment and no other wires are connected to the device before providing power from the Trex unit.

Note

Do not insert a resistor in parallel with either the HART + pwr or HART terminals on the Trex unit, or in parallel with the device's communication terminals. This will interfere with the current measurements.

Procedure

1. Connect the lead set to the HART + pwr terminals on the Trex unit and to the transmitter.

Figure 4-15: Connection for providing power to the device

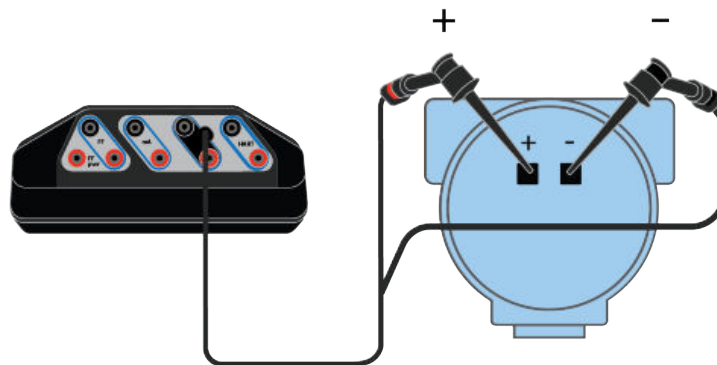

2. On the Loop Diagnostics screen, tap Trex Unit Power.
3. Tap Power Transmitter.
The Trex unit uses an internal resistor while powering the device.
4. Tap OK.
The Trex unit powers the device. The voltage and current measurements are displayed.
5. To stop powering the device, do one of the following:
 - Tap Trex Unit Power to set the option to Off.
 - Tap Exit.
 - Remove the lead set from the Trex unit.

4.8 Power a positioner

If you try to apply power from the Trex unit when the device is externally-powered, the Loop Diagnostics application prevents the Trex unit from supplying power. This protects the Trex unit from damage.

⚠ CAUTION!

Remove the USB cable from the Trex unit before connecting to a device.

⚠ CAUTION!

Do not add any external power to the device when the Trex unit is powering the device. This can blow a fuse inside the Trex unit. The repair/replacement will need to be completed at an authorized service center. Ensure the device is disconnected from the loop/segment and no other wires are connected to the device before providing power from the Trex unit.

Procedure

1. Connect the lead set to the HART + pwr terminals on the Trex unit and to the positioner.

Figure 4-16: Connection for powering a positioner

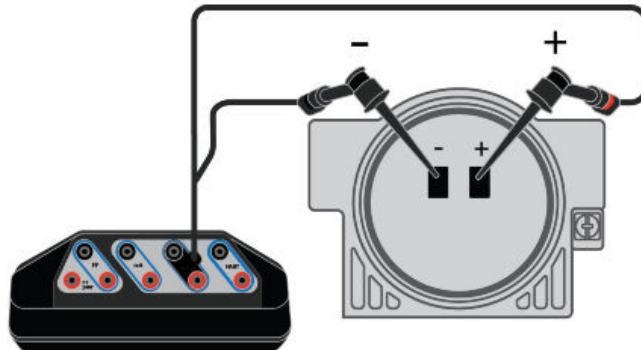

2. On the Loop Diagnostics screen, tap Trex Unit Power.
3. Select one of the following:

Option	Description
Power Positioner with 4 mA (0%)	Power a positioner using 4 mA.
Power Positioner with 20 mA (100%)	Power a positioner using 20 mA.
Power Positioner with other mA value	Power a positioner using a specified mA value.

4. Tap OK.

Loop Diagnostics is now powering the positioner and measuring voltage and current. The Trex Unit Current option is also enabled.

5. To change the current value, tap one of the quick current buttons (4 mA, 8 mA, 12 mA, 16 mA, 20 mA), or use the up and down arrow keys to manually increase the current value. The default increment is 0.1 mA.
6. To stop powering the device, do one of the following:
 - Tap Trex Unit Power to set the option to OFF. You are prompted to select a power option to set the position of the valve.
 - Tap Exit. You are prompted to select a power option to set the position of the valve.
 - Remove the lead set from the Trex unit. You are **not** prompted to select a power option to set the position of the valve.

4.9 Stroke a valve

If you try to apply power from the Trex unit when the device is externally-powered, the Loop Diagnostics application prevents the Trex unit from supplying power. This protects the Trex unit from damage.

⚠ WARNING!

Connecting power to the positioner may cause changes to the tuning set that cause the valve/actuator assembly to stroke. To avoid personal injury and property damage caused by moving parts, keep hands, tools, and other objects away from the valve/actuator assembly.

⚠ WARNING!

When power is provided to a positioner that is in service, the valve may move causing process fluid or pressure to be released. To avoid personal injury and property damage caused by the release of process fluid or pressure, isolate the valve from the process and equalize pressure on both sides of the valve or bleed off the process fluid.

Procedure

1. Connect the lead set to the HART + pwr terminals on the Trex unit and to the positioner.
2. On the Loop Diagnostics screen, tap Trex Unit Power.
3. Select one of the following options.

Option	Description
Power Positioner with 4 mA(0%)	Power a positioner with 4 mA.
Power Positioner with 20 mA (100%)	Power a positioner with 20 mA.

Option	Description
Power Positioner with other mA value	Power a positioner with a specified mA value.

4. Tap OK.
5. To change the current being supplied by the Trex unit, do one of the following:
 - Tap a quick current button.
 - Tap the up or down arrow keys to slowly increase or decrease the current. The default increment is 0.1 mA.
 - Tap the pencil icon to set a mA value.
6. Wait for the valve to move.
7. Repeat steps 5 and 6 until the valve moves through all the required positions.
8. To stop powering the device, do one of the following:
 - Tap Trex Unit Power to set the option to OFF. You are prompted to select a power option to set the position of the valve.
 - Tap Exit. You are prompted to select a power option to set the position of the valve.
 - Remove the lead set from the Trex unit. You are **not** prompted to select a power option to set the position of the valve.

4.10 Settings for controlling current

4.10.1 Change the values for the quick buttons

The Loop Diagnostics screen has five buttons that have default values of 4 mA, 8 mA, 12 mA, 16 mA, and 20 mA. These buttons let you quickly change the current. You can change the value for each button.

Figure 4-17: Quick buttons

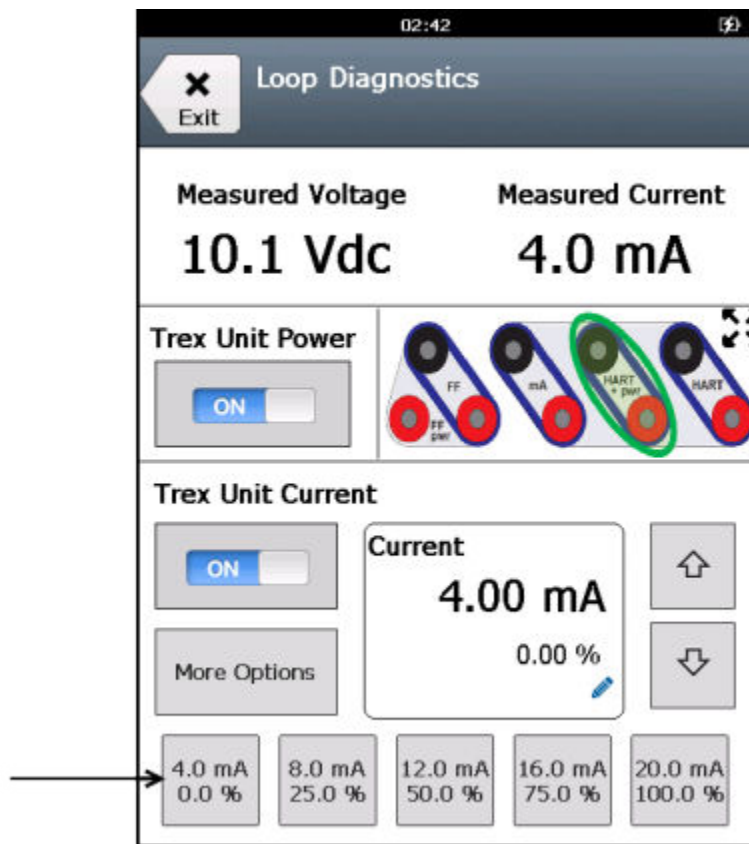

Procedure

1. On the Loop Diagnostics screen, tap Trex Unit Current > More Options > Quick Button Selection.
More Options does not appear unless the Trex Unit Power or Trex Unit Current is enabled.
2. Tap one of the Quick Button Selection options.
3. Enter a new value for the button, and tap OK.
4. Repeat until all buttons are set as desired.
5. Tap Back to save the changes and return to the Loop Diagnostics screen.

4.10.2 Change the scale for the up and down arrow keys

The Loop Diagnostics screen has up and down arrow keys that let you manually adjust the current in small increments to slowly move a valve. The default increment is 0.1 mA, but you can adjust the scaling.

Procedure

1. On the Loop Diagnostics screen, tap Trex Unit Current > More Options > Arrow Scaling for mA.
More Options does not appear unless the Trex Unit Power or Trex Unit Current is enabled.
2. Enter a value between 0.04 to 10.00 mA.
3. Tap OK.
4. Tap Back to save the changes and return to the Loop Diagnostics screen.

4.10.3 Set the duration to change the current

You can control how long it takes the Trex unit to change from sourcing one current value to another. Select a higher value to gradually change the current and avoid abrupt changes to a valve's position that may damage equipment. Select a value of zero to quickly move a valve.

This option applies to the quick current buttons, the up and down arrow keys, and the pencil icon that enable you to enter a new current value. It also applies when you tap Trex Unit Power to stop powering the positioner.

Note

This option does not apply to the initial current value that is applied when you first power the device. For example, if you power a device, the Loop Diagnostics application will immediately source 4 mA, 20 mA, or the mA value you entered. The delay applies to any change to the current value after initial start up.

Procedure

1. On the Loop Diagnostics screen, tap Trex Unit Current > More Options > Duration of Current Change.
More Options does not appear unless the Trex Unit Power or Trex Unit Current is enabled.
2. Tap the desired number of seconds.
3. Tap OK.
4. Tap Back to save the changes and return to the Loop Diagnostics screen.

4.11 Loop checks

The Loop Diagnostics application enables loop checks by measuring voltage and current, and controlling the current to simulate a transmitter.

Checks before installation

Before a device is installed, verify its operation. You can enable the Trex Unit Power option to power the device. For a transmitter, use the Trex unit to power the transmitter and measure the 4-20 mA output. For a positioner, use the Trex unit to power the positioner, control the current, and ensure the positioner moves as expected when the current changes.

Checks during installation

You can use the Trex unit to verify a partially-installed loop. You can do the following:

- Connect the Trex HART terminals where the device will be installed. Verify the power supply voltage is measured, and that the voltage is large enough for a device.
- Connect the Trex HART terminals where a transmitter will be installed and enable Trex Unit Current to simulate a transmitter's 4-20 mA output. Verify the digital control system reads current from the Trex unit.
- Connect the Trex HART + pwr terminals where the power supply will be installed on a transmitter loop and enable Trex Unit Power. The Trex unit can measure the 4-20 mA output from the transmitter.
- Connect the Trex HART + pwr terminals where the power supply will be installed on a positioner loop and enable Trex Unit Power. Verify the device is powered and the voltage level is set by the positioner.
- Connect the Trex HART + pwr terminals where the device will be installed on an unpowered transmitter loop and enable Trex Unit Power to simulate a transmitter. Verify the digital control system reads output current from the Trex unit.
- Connect the Trex mA terminals at the location where a positioner will be installed. Verify the ammeter reads 4-20 mA when the digital control system output module is enabled.

Checks after installation

Use the Field Communicator application on the Trex unit to verify the device is communicating.

For transmitters, use the Loop Diagnostics application to verify power and loop current. The HART terminals on the Trex unit can measure voltage. Connect the HART terminals to the communication terminals on the device to ensure there is adequate voltage. To measure the current, connect the mA terminals to the test terminal on the device to measure the 4-20 mA output. If the device does not have a test terminal and the loop is removed from control, connect the mA terminals in series with the device's negative communication terminals to verify the 4-20 mA output.

For positioners, connect the HART terminals to the device's communication terminals to measure and verify there is adequate voltage. If you suspect a bad digital control system output current, connect the mA terminals in series with the positioner's negative communication terminals to measure and verify the 4-20 mA output.

Troubleshoot a HART loop

- Attempt the tasks from the "Checks after installation" section.

- Simplify the problem by removing one or more components from the HART loop. Attempt tasks from the "Checks after installation" section.
- Isolate the device and perform tasks from "Checks before installation."

4.11.1 Measure voltage on an externally-powered loop

You can use the HART terminals on the Trex unit to measure the voltage on an externally-powered device/loop.

Note

Use the HART + pwr terminals if you want the Trex unit to power the device and measure voltage. See [Section 4.6](#).

⚠ CAUTION!

Do not connect lead sets to the HART and HART + pwr terminals at the same time.

Procedure

1. Connect the lead set to the HART terminals on the Trex unit and to the externally-powered device.
2. View the Measured Voltage section on the Loop Diagnostics screen.

4.11.2 Measure the control system output

Measure loop current to ensure a device or distributed control system is sending the correct value. You can measure loop current from 0 to 25 mA on a 4-20 mA current loop.

Note

Measurements are for reference purposes only. Do not make critical process-control decisions based on these measurements.

⚠ WARNING!

Do not connect the mA terminals on the Trex unit to a power supply that is not current limited to 250 mA. This can blow a fuse inside the Trex unit. The repair/replacement will need to be completed at an authorized service center.

⚠ WARNING!

Do not connect the mA terminals (ammeter) in parallel with a powered 4-20 mA current loop. Ammeters have low resistance. This can disrupt the loop and cause devices to report incorrect values or positioners to move unexpectedly.

Procedure

1. Connect the lead set to the mA terminals on the Trex unit and to a connection point on the loop.

The Trex unit can be connected at various point along the loop to measure current.

Figure 4-18: Example connection for measuring current

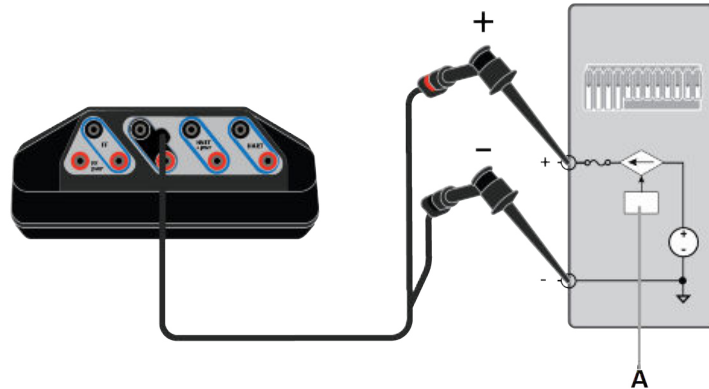

A. Analog output.

2. In the Loop Diagnostics application, view the measured current at the top of the screen.

4.11.3 Simulate a transmitter on an externally-powered loop for a loop check

The Loop Diagnostics application can control current to simulate a 2-wire transmitter on an externally-powered loop. In this setup, the digital control system is powering the current loop and the Trex unit is controlling the current that is input into the digital control system.

Procedure

1. Connect the lead set to the HART terminals on the Trex unit and to the powered 4-20 mA current loop.

Figure 4-20: Connection for providing power and simulating a transmitter

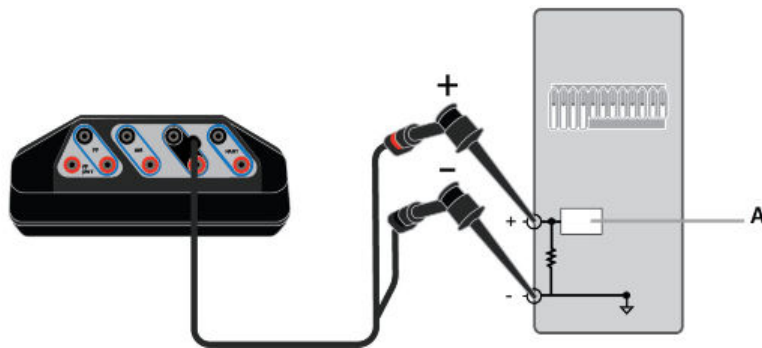

A. Analog input.

2. On the Loop Diagnostics screen, tap Trex Unit Power.
3. Tap Simulate Transmitter with 4 mA.
4. Change the current value by pressing the quick buttons or the up and down arrow keys.
5. Verify the digital control system is reading the same current value.

5 Fieldbus Diagnostics application

Topics covered in this chapter:

- *Open or close the Fieldbus Diagnostics application*
- *Fieldbus Diagnostics Overview screen*
- *GOOD, BAD, and CHECK measurements in Fieldbus Diagnostics*
- *Wiring diagrams for the Fieldbus Diagnostics application*
- *Power a FOUNDATION fieldbus device*
- *Connect to an externally-powered fieldbus segment*
- *Measure the DC voltage, noise, and the fieldbus signal*
- *Details screen*
- *View the live measurement values in Fieldbus Diagnostics*
- *View help for a measurement*
- *Noise spectrum*
- *Settings*
- *Saving measurements to a log file*
- *Troubleshooting Fieldbus Diagnostics*

The Fieldbus Diagnostics application lets you run diagnostics to troubleshoot fieldbus segments and devices. It provides power and basic communications for verifying device operations on an isolated mini-segment. The application provides optional communications for identifying the device list. You can connect the Trex unit at various points along the fieldbus segment, so you can isolate the location of a problem.

The Fieldbus Diagnostics application can help you identify problems caused by loose wire connections, water or moisture in cables or terminal housings, improper grounding, or issues with fieldbus segment installations.

Note

The Fieldbus Diagnostics application can be used with the Device Communicator communication module or Device Communicator Plus communication module. However, the Trex unit cannot power a FOUNDATION fieldbus device with the Device Communicator communication module. The application also requires a fieldbus license.

Measurements

The Fieldbus Diagnostics application lets you measure:

- DC voltage: -34 to 34 volts
- Noise: Low-frequency (870 Hz - 9 KHz), in-band frequency (9 KHz - 39 KHz), and high-frequency noise (39 KHz - 100 KHz)
- Fieldbus signal level: 100 - 1200 mV (peak-to-peak)

Quick ad-hoc network tests to isolate issues

You can use the Trex unit to connect to various connection points on the fieldbus segment to isolate an issue. For example, if the device fails to power due to a low-voltage at its terminals, use the Fieldbus Diagnostics application to measure the voltage at all cable connection points between the power supply and the device. These measurements can help you identify the section of cable or junction box where the voltage drop occurs.

Long-term tests to catch sporadic issues

If a device has issues for only part of the day, you can take measurements over a period of time to capture the time/date the issue occurs. For example, if you notice sporadic increases in noise, you can take a measurement for multiple hours to determine when the issue is occurring. This can help you relate the noise with another event, such as a variable-frequency drive starting and stopping throughout the day.

Periodic tests to help you track your network and create trends

You can take measurements every few months to create an overall trend/report for the fieldbus segment. For example, you can create one set of measurements when a device is installed, and another set of measurements a year later for comparison. This can help you track any slow degradation of the fieldbus segment.

The Fieldbus Diagnostics application has a logging feature that lets you save one or more sets of measurements to a comma-separated values (.csv) log file. The files can then be transferred to a PC for further review and analysis in a spreadsheet program.

5.1 Open or close the Fieldbus Diagnostics application

1. To open Fieldbus Diagnostics, tap the Fieldbus Diagnostics icon on the Trex Home screen.
2. To close Fieldbus Diagnostics, tap Exit.

5.2 Fieldbus Diagnostics Overview screen

The Fieldbus Diagnostics Overview screen is the home screen for the application. The screen displays the status of the measurements and lets you configure the application.

Note

The Power supply option is not displayed if the Trex unit has the Device Communicator communication module. The Device Communicator Plus communication module and FOUNDATION fieldbus Power Plug are required to power a FOUNDATION fieldbus device.

The measurements are labeled with a status of GOOD, BAD, or CHECK. You can configure the measurement criteria and ranges for the GOOD and BAD status labels. The INACTIVE status is displayed when there is no fieldbus signal, due to no device communication on the fieldbus segment. Review the measurement criteria in Settings to ensure they are appropriate for your installation.

Figure 5-1: Fieldbus Diagnostics screen at start up

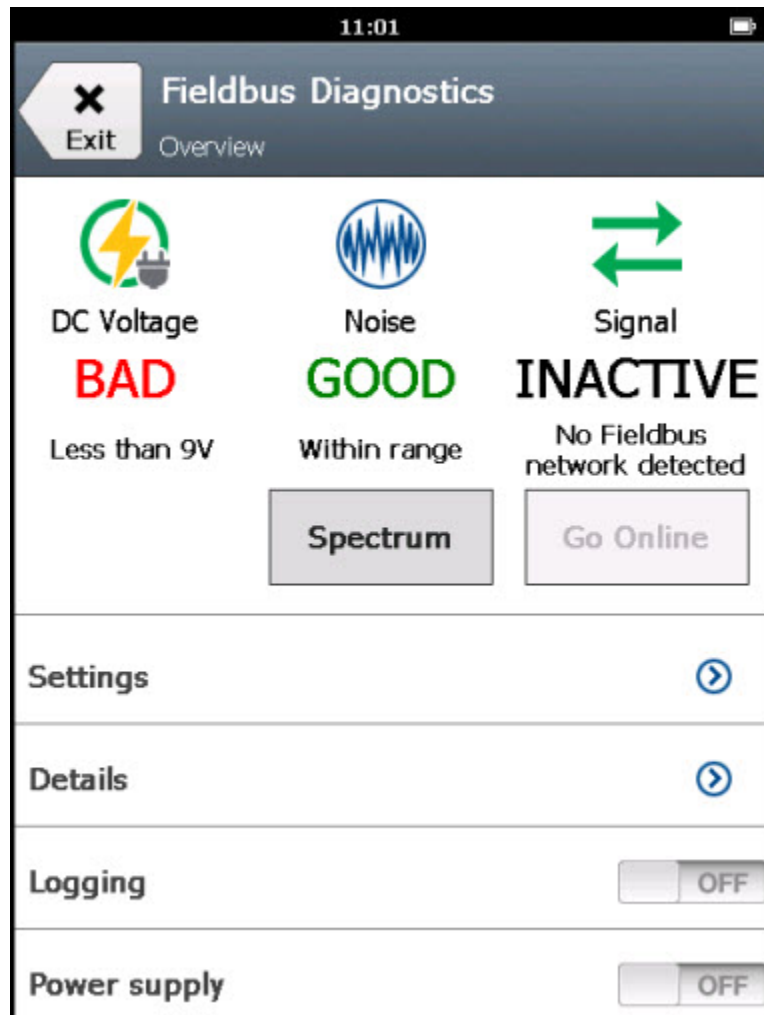
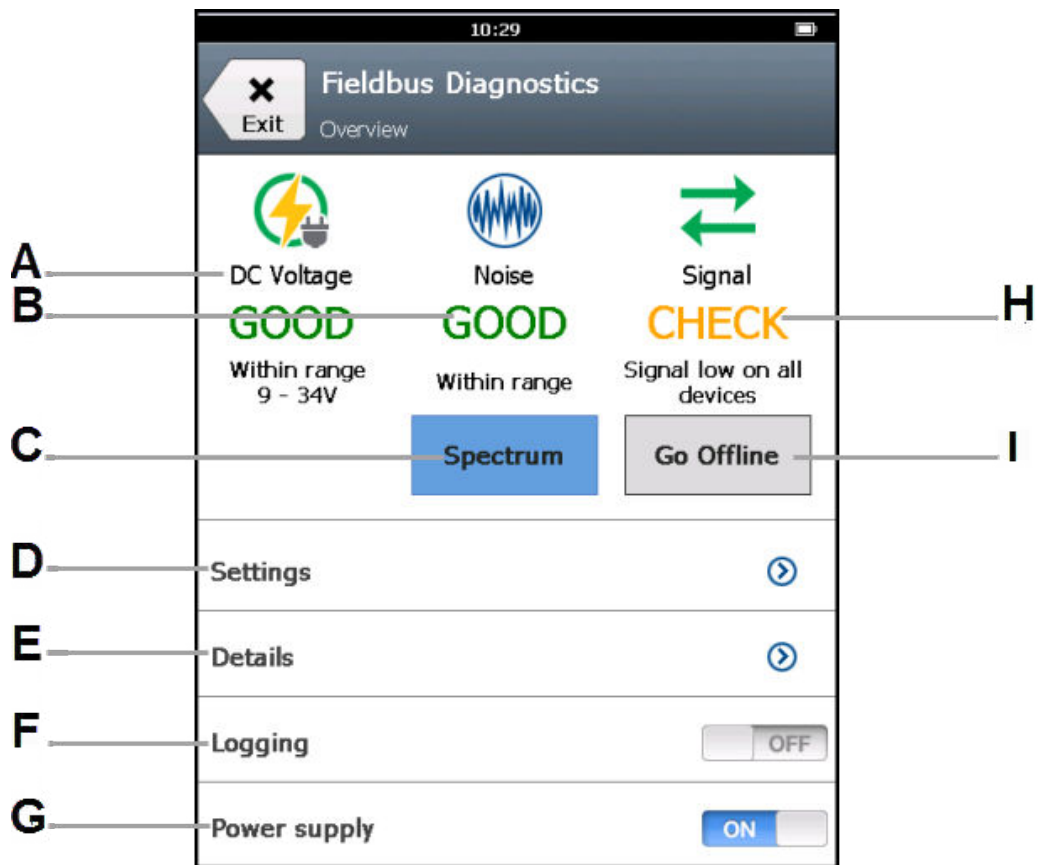

Figure 5-2: Fieldbus Diagnostics Overview screen while taking measurements



- A. View the status of the DC voltage measurement.
- B. View the status of the noise measurements.
- C. View a spectrum of the low-frequency, in-band, and high-frequency noise measurements.
- D. Set options for displaying and collecting the measurements.
- E. View the values for each measurement.
- F. Enable or disable saving the measurements to a log file (.csv), and set the logging settings. Multiple sets of measurements can be saved to create a trend/report.
- G. Enable or disable power to a FOUNDATION fieldbus device. The Trex unit needs the Device Communicator Plus communication module and the FOUNDATION fieldbus Power Plug to power a fieldbus device.
- H. View the status of the fieldbus signal measurement.
- I. Tap Go Online or Go Offline to have the Trex unit go online or offline. When the Trex unit is on an externally-powered fieldbus segment with fieldbus communications, Go Online queries devices for their tags. The option also adds the Trex unit to the device list on the Details screen, so you can compare the Trex unit's known good signal to a device's signal. When the Trex unit is powering a device or when there is no fieldbus communication on an externally- powered fieldbus segment, Go Online starts fieldbus network communications so fieldbus signals can be measured.

Note

If you connect the Trex unit to an active fieldbus segment with a LAS, the devices, the device addresses, and signal measurements are displayed on the Details screen. However, the device's tag is displayed only after you tap Go Online.

Note

The Fieldbus Diagnostics application does not show which device is the LAS on the fieldbus segment. The Trex unit will become the LAS if no other LAS is on the fieldbus segment.

⚠ CAUTION!

The Trex unit draws approximately 12 mA from the fieldbus segment when it is online. (The Trex unit draws 0 mA when it is offline.) Ensure the power supply or barrier on the fieldbus segment has the capacity to provide this additional current when the Trex unit is online. If a heavily loaded fieldbus segment is drawing near the capacity of the segment's power supply, connecting the Trex unit may result in loss of communication.

5.3 GOOD, BAD, and CHECK measurements in Fieldbus Diagnostics

The Fieldbus Diagnostics application uses labels of GOOD, BAD, and CHECK to indicate the status of a measurement. The label is applied based on the measurement being within a set of ranges that you can adjust. By default, the range of values includes typical operating levels of DC voltage, noise, and signal-level based on the Fieldbus standard.

You can set the range of measurement values that are labeled GOOD, BAD, or CHECK in the Settings. (Tap Settings > Measurement criteria.) You may want to increase or decrease the range of values based on where the Trex unit is connected on the fieldbus segment.

Status	Description
GOOD	The measurement is within the minimum and maximum values set in the measurement criteria.
BAD	The measurement is below the minimum value set in the measurement criteria. The BAD status is used for the DC voltage and signal measurements.
CHECK	The measurement is greater than the maximum value or less than the minimum value defined the measurement criteria. The CHECK status is used for the noise and signal measurements because the measurements may be GOOD or BAD depending on the location of where the measurement is taken and on the fieldbus segment's tolerance to noise. For example, if the device's signal measurement is 400 mV (peak-to-peak) and the Trex unit was connected near the device, the measurement is low and may be considered BAD. However, if the Trex unit was connected to the fieldbus segment far away from the device, the lower signal measurement is expected due to the length of the cable and it can be considered GOOD.
INACTIVE	The Trex unit is detecting no fieldbus communication. Tap Go Online to communicate with the device.

Default status labels for the DC voltage measurement



Default status labels for the noise measurement

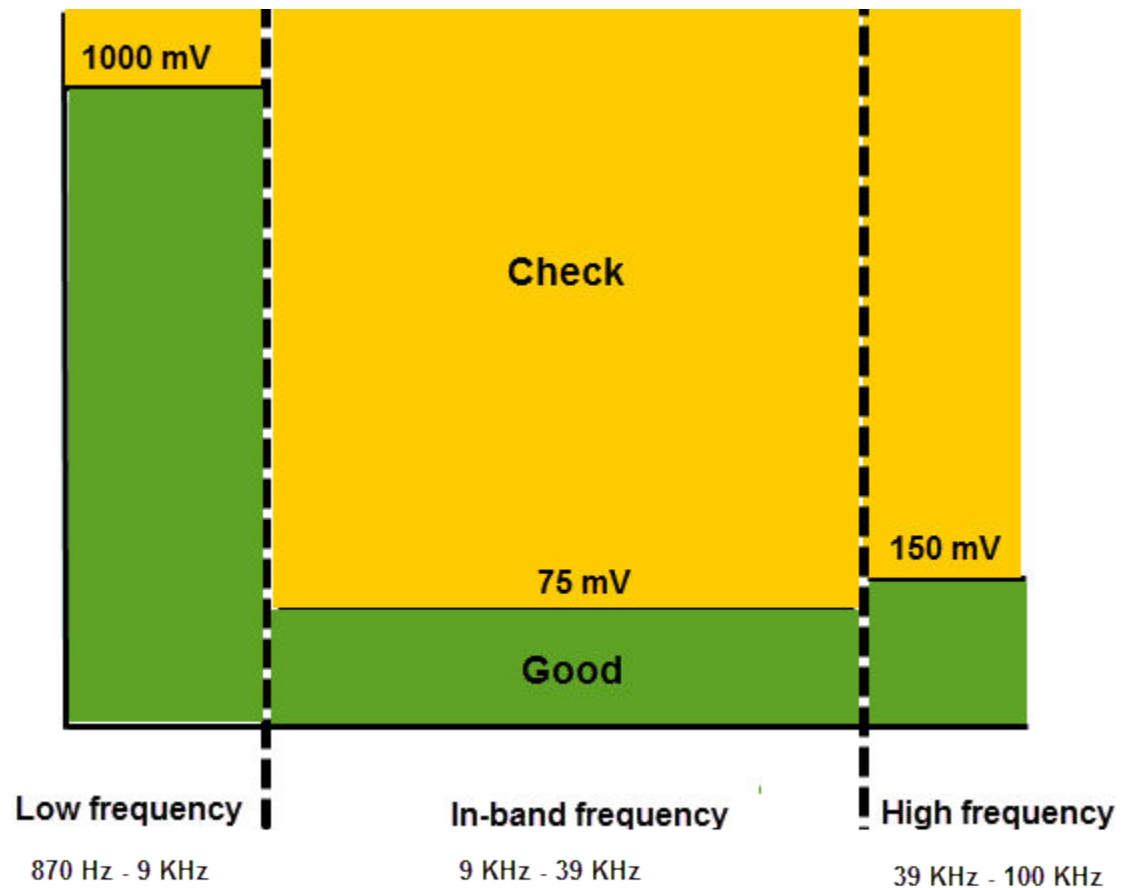

Default status labels for the signal measurement



If the fieldbus signal measurement has a BAD or CHECK status, an additional status note is listed on the Fieldbus Diagnostics Overview screen.

Fieldbus signal status note	Description
With in the range for all nodes	All devices on the fieldbus segment have a GOOD fieldbus signal.
Signal low/high on all devices	All devices on the fieldbus segment have signal measurements that are higher than the set maximum value or lower than the set minimum value.
Signal low/high on most devices	More than half of the devices on the fieldbus segment have signal measurements that are higher than the set maximum value or lower than the set minimum value.
Signal low/high on few devices	Fewer than half of the devices on the fieldbus segment have signal measurements that are higher than the set maximum value or lower than the set minimum value.
Signal low/high on <device address>	Only one fieldbus device has a signal measurement that is higher than the set maximum value or lower than the set minimum value.

5.4 Wiring diagrams for the Fieldbus Diagnostics application

⚠ CAUTION!

Remove the USB cable from the Trex unit before connecting to a device.

⚠ CAUTION!

The Trex unit draws approximately 12 mA from the fieldbus segment when it is online. (The Trex unit draws 0 mA when it is offline.) Ensure the power supply or barrier on the fieldbus segment has the capacity to provide this additional current when the Trex unit is online. If a heavily loaded fieldbus segment is drawing near the capacity of the segment's power supply, connecting the Trex unit may result in loss of communication.

Figure 5-3: Power and connect to a FOUNDATION fieldbus device

To power a FOUNDATION fieldbus device, the Trex unit needs the FOUNDATION fieldbus Power Plug. When the Trex unit powers a device, it also provides two terminators and a power conditioner.

⚠ WARNING!

The Trex unit can power only one FOUNDATION fieldbus device in a bench setup.

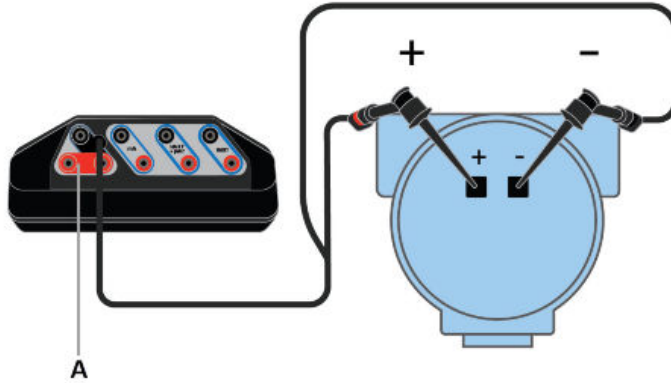

A. FOUNDATION fieldbus Power Plug

Figure 5-4: Connect to an externally-powered fieldbus segment

For small fieldbus segments, the power conditioner and terminators can be contained in a single wiring block.

Note

You can connect the Trex unit at any convenient place along the fieldbus segment (bus). In the field, this is typically done at the device or at the fieldbus junction box. The drawing below is one example.

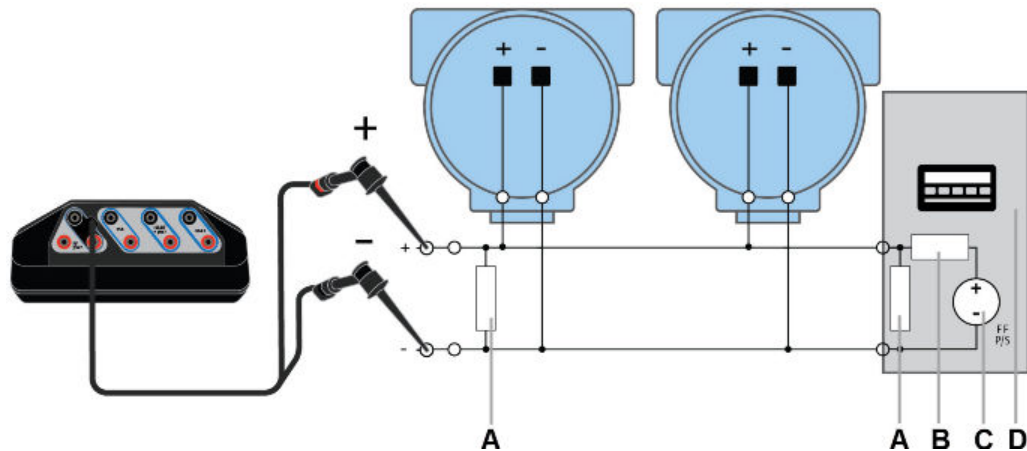

A. Terminators
 B. Power conditioner
 C. Fieldbus power supply
 D. Host system

5.5 Power a FOUNDATION fieldbus device

The Trex unit can power one FOUNDATION fieldbus device. The Trex unit can provide approximately 10 volts at 25 mA to power a FOUNDATION fieldbus device. (The Trex unit will draw approximately 12 mA when it is online)

If you try to apply power from the Trex unit when the device is externally-powered, the Fieldbus Diagnostics application prevents the Trex unit from supplying power. This protects the Trex unit from damage.

Note

When the Trex unit powers a FOUNDATION fieldbus device, two internal terminators and a power conditioner are applied. Ensure the device is not connected to a fieldbus segment, even if the segment is unpowered.

⚠ CAUTION!

Remove the USB cable from the Trex unit before connecting to a device.

⚠ WARNING!

Do not add any external power to the device when the Trex unit is powering the device. This can blow a fuse inside the Trex unit. The repair/replacement will need to be completed at an authorized service center. Ensure the device is disconnected from the loop/segment and no other wires are connected to the device before providing power from the Trex unit.

Procedure

1. Connect the lead set to the FF terminals on the Trex unit and directly to the communication terminals on the unpowered device. Ensure no other wires are connected to the device and there is no power to the device. Do not attach to a junction box.
2. Connect the FOUNDATION fieldbus Power Plug to the FF pwr terminal and the positive (red) terminal on the lead set.

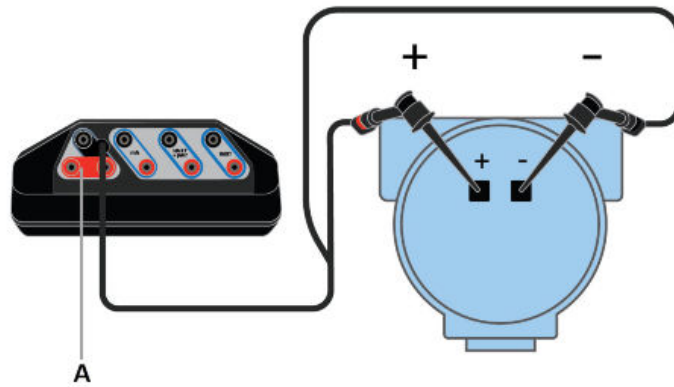
Figure 5-5: Connection for powering a FOUNDATION fieldbus device

A. FOUNDATION fieldbus Power Plug

3. On the Fieldbus Diagnostics Overview screen, tap Power Supply to enable power to the device.

The Trex unit powers the device.

4. To stop power, tap Power Supply or disconnect the lead set from the Trex unit.

5.6 Connect to an externally-powered fieldbus segment

You can connect the Trex unit at various points, including at the device terminals or a point along the fieldbus segment. The example below is for connecting to the fieldbus segment to take measurements in the Fieldbus Diagnostics application.

Procedure

1. Connect the lead set to the FF terminals on the Trex unit and to the fieldbus segment or device.

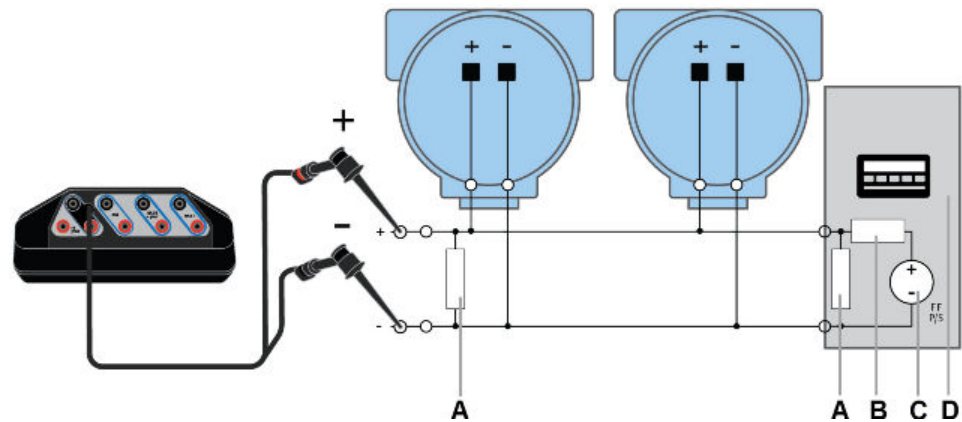
Figure 5-6: One connection option for connecting to the fieldbus segment

- A. Terminators
- B. Power conditioner
- C. Fieldbus power supply
- D. Host system

2. Open Fieldbus Diagnostics.

The Trex unit connects to the device/fieldbus segment and begins the measurements.

3. Optional - Tap Go Online to query devices for their tags.

5.7 Measure the DC voltage, noise, and the fieldbus signal

The Fieldbus Diagnostics Overview screen displays a GOOD, BAD, or CHECK status for the measurements to give you a quick summary. Check the measurement criteria in the Settings to ensure they are appropriate for your installation.

You can view the actual measurement values by tapping Details on the Fieldbus Diagnostics Overview screen.

Note

Before taking a noise measurement, remove the AC adapter from the Trex unit, if it is connected. This isolates the Trex unit from the local power grid.

Procedure

1. If the FOUNDATION fieldbus device is externally-powered, do the following:
 - a. Connect the lead set to the FF terminals on the Trex unit and to the fieldbus segment or device.
 - b. Open Fieldbus Diagnostics.

The measurement status appears on the screen.

- c. If the signal measurement status is "INACTIVE" or if you want to identify the device tags that are listed on the Details screen, tap Go Online.
2. If the FOUNDATION fieldbus device is not powered, do the following:
 - a. Connect the lead set to the FF terminals on the Trex unit and directly to the communication terminals on the unpowered device. Ensure no other wires are connected to the device and there is no power to the device. Do not attach to a junction box.
 - b. Connect the FOUNDATION fieldbus Power Plug to the FF pwr terminal and the positive (red) FF terminal on the lead set.
 - c. Open Fieldbus Diagnostics.
 - d. On the Fieldbus Diagnostics Overview screen, tap Power supply to enable power to the device. The Trex unit powers the device.
 - e. If the signal measurement status is "INACTIVE" or if you want to identify the device tags that are listed on the Details screen, tap Go Online.

Related information

*[View the live measurement values in Fieldbus Diagnostics](#)
[Set the range of values for the GOOD and BAD status](#)*

5.8 Details screen

By default, the Details screen displays information about the DC voltage, noise, and fieldbus signal measurements, including:

- The live measurement values, which are continuously updated.
- The units for each measurement.
- The minimum, maximum, and average measurement value.
- The number of devices on the fieldbus segment.
- The addresses of each device detected on the fieldbus segment. The device tag is also displayed if you selected Go Online on the Fieldbus Diagnostics Overview screen.

Note

By default, the Details screen is configured to show all the measurement data in columns, which do not fit on one screen. Scroll to the right on the screen to view additional columns. (To view only the measurements and the units, tap Settings > Show Min, Max, Avg to remove the checkmark.)

If a measurement is higher or lower than the set minimum or maximum values in the measurement criteria, the measurement is highlighted red or orange. Press and hold the measurement to display a Help option that lists some troubleshooting information. You can open Help for all cells on the Details screen.

5.9 View the live measurement values in Fieldbus Diagnostics

The Fieldbus Diagnostics Overview screen displays measurements as a GOOD, BAD, or CHECK status. However, you can view the actual measurement values in real-time.

The Details screen also displays all the devices found on the fieldbus segment. If you selected Go Online, the devices are listed by tag and address. Otherwise, only the device address is listed.

Procedure

1. Connect to the FOUNDATION fieldbus device or segment.
2. On the Fieldbus Diagnostics Overview screen, tap Details.

The measurement values for the DC voltage, noise, and signal measurements are displayed.

3. Touch the screen and scroll to the right to view additional measurement values on the side of the screen.

Measurements with a status of BAD are red. Measurements with a status of CHECK are orange.

Related information

[Troubleshooting Fieldbus Diagnostics](#)

5.10 View help for a measurement

You can view help text that provides information about each measurement. Each cell on the Details screen has help text that describes overview information or actions you can take to help troubleshoot the measurement or problem, if a problem is detected.

Procedure

1. Connect to the FOUNDATION fieldbus device or segment.
2. On the Fieldbus Diagnostics Overview screen, tap Details.
3. Press and hold on a measurement value, or highlight a cell and tap the checkmark button on the keypad.

A menu is displayed.

4. Tap Help

The Help text is displayed.

Figure 5-7: Help example

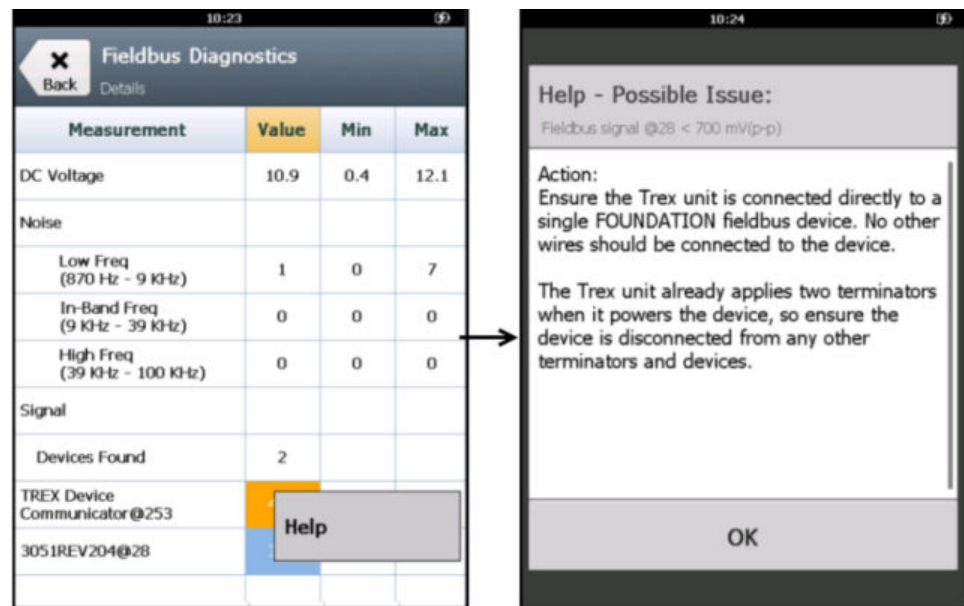

5. Tap OK to close the Help screen.

5.11 Noise spectrum

The noise spectrum gives you a real-time view of the different types of noise that were detected on the fieldbus segment. Various conditions can cause different types of noise. The spectrum displays the measurements grouped by low frequency, in-band, and high frequency noise. The frequencies between 9 and 39 KHz make the fieldbus signal.

Note

Before taking a noise measurement, remove the AC adapter from the Trex unit, if it is connected. This isolates the Trex unit from the local power grid.

Frequency	Frequency range	Typical measurement values
Low frequency	870 Hz - 9 KHz	Less than 1000 mV (peak-to-peak)
In-band frequency	9 KHz - 39 KHz	Less than 75 mV (peak-to-peak)
High frequency	39 KHz - 100 KHz	Less than 150 mV (peak-to-peak)

The gray/shaded area at the top of the noise spectrum shows the values that would exceed the maximum values set in the measurement criteria for the low-frequency, in-band frequency, and high-frequency measurements. If the measurement is in the gray/shaded area, the Fieldbus Diagnostics Overview screen shows a status of CHECK. If the measurement is below the gray/shaded area, the displayed status is GOOD.

The noise spectrum shows the highest measurement in mV (peak-to-peak) outlined in black. Tap **Reset Peak** to clear the black outline and have it reset to the most recent highest peak. For example, use **Reset Peak** to clear a noise spike that was detected when connecting the Trex unit or other hardware to the fieldbus segment.

The measurements on the spectrum are also color-coded to indicate if the status of the measurement. The colors become darker as the measurement increases.

- Green = GOOD
- Yellow = CHECK
- Orange = CHECK

Note

The spectrum measurement will fail if the noise amplitude exceeds 1.5 V (peak-to-peak). If you see multiple high-amplitude noise peaks, look for an unattached wire that may cause high noise and saturate the noise detection.

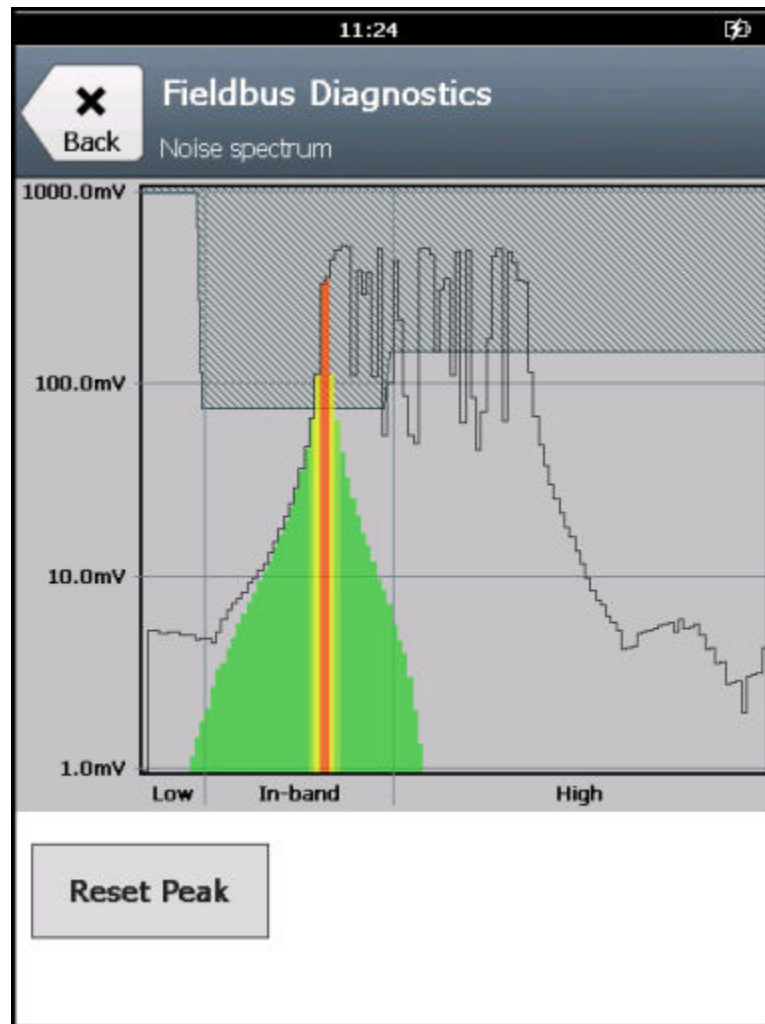
Figure 5-8: Highest amplitude marked with black outline

How noise affects the fieldbus segment

The fieldbus segment can function properly with large amounts of low-frequency noise, small amounts of in-band noise, or moderate amounts of high-frequency noise. In-band noise is most likely to directly impact fieldbus communications. Bursts of in-band noise can cause the fieldbus network to slow down due to the messages being resent multiple times. Devices may also disconnect from the network if the in-band noise becomes too high/frequent.

High-frequency noise seldom impacts fieldbus communications, but it may cause measurement errors or the device may restart.

Related information

[Troubleshooting Fieldbus Diagnostics](#)

5.11.1 View a spectrum of the noise measurement

You can view the noise spectrum that displays the levels of low frequency (870 Hz - 9 KHz), in-band (9 KHz - 39 KHz), and high frequency noise (39 - KHz - 100 KHz).

Note

Before taking a noise measurement, remove the AC adapter from the Trex unit, if it is connected. This isolates the Trex unit from the local power grid.

Note

The spectrum measurement will fail if the noise amplitude exceeds 1.5 V (peak-to-peak). If you see multiple high-amplitude noise peaks, look for an unattached wire that may cause high noise and saturate the noise detection.

Procedure

1. Connect to the FOUNDATION fieldbus device or segment.
2. On the Fieldbus Diagnostics Overview screen, tap Spectrum.

A spectrum displays the noise measurements. The highest peaks are outlined in black.

Figure 5-9: Example of noise spectrum

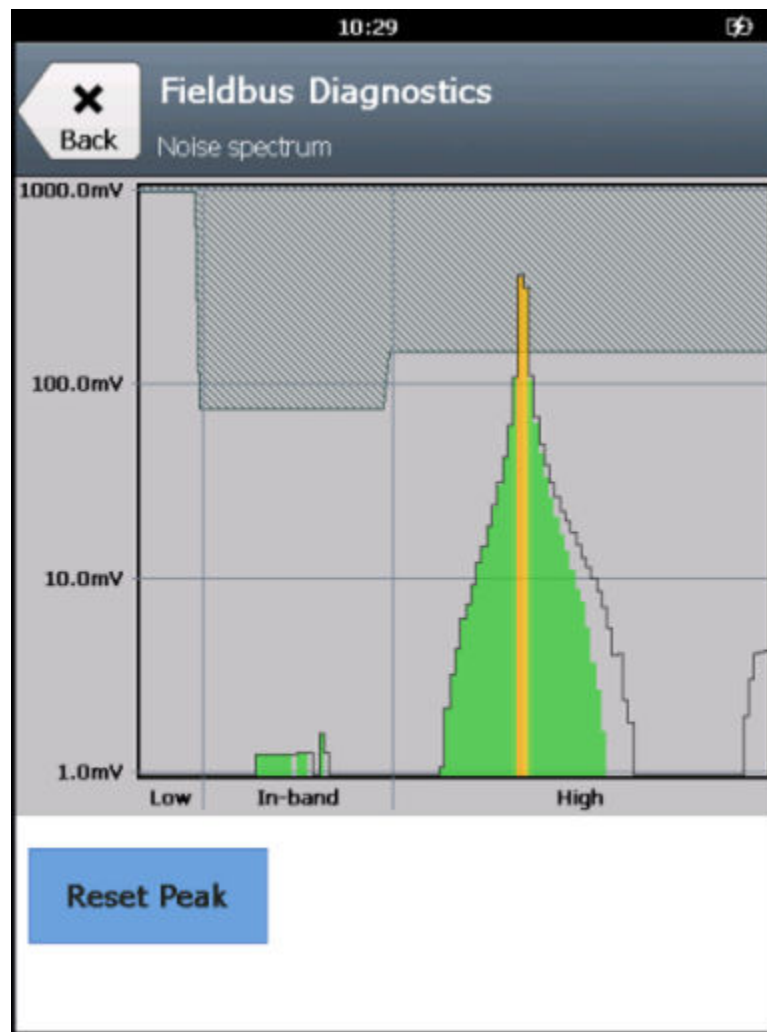

3. If necessary, tap **Reset Peak** to clear the peak on the spectrum.

5.12 Settings

Within the Fieldbus Diagnostics application, you can change the following settings:

- View or hide the minimum, maximum, and average values for each measurement.
- View or hide the host and device tags.
- Set the number of measurements to average.
- Set the minimum and maximum acceptable values for each type of measurement. This defines the range of values for the measurements labeled GOOD, BAD, and CHECK on the Fieldbus Diagnostics Overview screen.
- Reset all settings in the application to the default values.

5.12.1 View or hide the minimum, maximum, and average values for a measurement

The minimum, maximum, and average values are displayed on the Details screen. By default, these values are displayed.

Procedure

1. On the Fieldbus Diagnostics Overview screen, tap Settings.
2. Tap the Show Min Max Avg box to show or hide these values.

5.12.2 View or hide the device tags when online

When you tap Go Online on the Fieldbus Diagnostics Overview screen, the Trex unit is able to display the tag for the connected device and/or host system. However, you can hide these tags if you do not want the Trex unit to query a device for its identification.

Procedure

1. On the Fieldbus Diagnostics Overview screen, tap Settings.
2. Tap Device Tags (when online).
3. Select one of the following options.

Option	Description
Fieldbus Host and Devices	Display the tags for the host on the fieldbus segment and the devices.
Fieldbus Devices Only	Display only the tags from the devices.
No Tags	Display no tags.

4. Tap OK.

5.12.3 Set the number of measurements to average

You can set the number of measurements to average for the DC voltage, noise, and signal level measurements. The option below applies to all three measurements; you cannot set a different number of averages for each measurement.

By default, the Fieldbus Diagnostics application averages the ten most recent measurements. The average value is displayed on the Details screen.

Procedure

1. On the Fieldbus Diagnostics Overview screen, tap Settings.
2. Tap # of Measurements to Avg.
3. Enter the number of measurements to average between 0 and 100.

The default value is 10.

4. Tap OK.

5.12.4 Set the range of values for the GOOD and BAD status

You can set the range of measurement values that determine the GOOD and BAD status for a measurement on the Fieldbus Diagnostics Overview screen. Any measurements within the set minimum and maximum values are labeled GOOD. By default, the values are set to include typical operating levels of DC voltage, noise, and signal-level based on the Fieldbus standard.

If you adjust the minimum and maximum values, the values for the CHECK status adjust as well. If you expand range between the minimum and maximum values, the range of values for the CHECK status is reduced.

Procedure

1. On the Fieldbus Diagnostics Overview screen, tap Settings.
2. Tap Measurement criteria.
3. Enter the minimum and/or maximum values for each measurement type.
4. Tap Back to complete the changes.

5.12.5 Reset the Fieldbus Diagnostics settings to the default values

You can reset the settings back to the default values. You need to access two screens to set all settings back to their default values.

Procedure

1. On the Fieldbus Diagnostics Overview screen, tap Settings.
2. Tap Reset to Default to reset the options on the Settings screen to the default values.
3. Tap Measurement criteria on the Settings screen.
4. Tap Reset to Default to reset the options on the Measurement criteria screen to the default values.

5.13 Saving measurements to a log file

The Fieldbus Diagnostics application lets you save measurements to a log file, transfer the log file from the Trex unit to a PC, open the log file in a spreadsheet application, and chart the data to identify sporadic events or trends where the fieldbus segment is degrading.

You can log many measurements over 24 hours to catch a sporadic issue, or log measurements once a year to discover long-term changes in the performance of the fieldbus segment.

File type

The measurements are saved to a comma-separated values (.csv) log file on the Trex unit, so you can use several different spreadsheet programs, including Microsoft® Excel, on the PC to analyze and chart the data at a later time. You cannot view the contents of the log file from the Trex unit.

Creating trends/reports

When you enable logging, the Fieldbus Diagnostics application displays a screen of settings you can set for the log files. To create long-term trends/reports, set the Save option to Append and use the same log file for every measurement period. This allows the Fieldbus Diagnostics application to save multiple sets of measurements to one file, rather than overwriting the data each time you enable logging.

Related information

[Enable or disable logging](#)

[Save measurements to an existing log file](#)

5.13.1 Log file overview

The Fieldbus Diagnostics application can save measurements to a log file with the .csv (comma-separated values) file extension. The log file lists the information you entered when you enabled logging, including the fieldbus segment name, the name of the user taking the measurements, and the location of the measurements.

Note

As a best practice, create a new log file for each fieldbus segment and connection point you are monitoring, or ensure you update the segment name and measurement location fields each time you collect data.

Automatically generated file names

You can enter a file name for the log file or have the Fieldbus Diagnostics application generate one based on the device tag or the device ID of the host and devices found on the fieldbus segment. You must tap the Go Online option before enabling logging to automatically generate the file name.

Note

If multiple devices are on the fieldbus segment, the device or host system with the lowest address is chosen for the file name. (Typically, the fieldbus host system has the lowest address.) You can also enter a file name.

Displayed data

Each row represents a snap-shot in time when the measurement was taken and displays the values for the DC voltage, noise, and signal measurements. The DC voltage measurement value is displayed. The noise levels are divided by frequency into multiple columns, and the value in the row is the measurement value in mV (peak-to-peak). The

signal measurements are organized by valid fieldbus address (16 -255), one column for each address. The value in each column is the measurement value in mV (peak-to-peak). Scroll to the right to see all columns in the log file.

Figure 5-10: Example log file

1	Revision		1					
2	Segment Name	User Name	Location	Date	Time stamp	DcVoltage(V)	Number of Devices	Address 1
3	Segment 1	Tech1	AT_DEVICE	4/26/2016	12:53:20 PM	19.2		3 -
4	Segment 1	Tech1	AT_DEVICE	4/26/2016	12:53:30 PM	19.2		3 -
5	Segment 1	Tech1	AT_DEVICE	4/26/2016	12:53:40 PM	19.2		3
6	Segment 1	Tech1	AT_DEVICE	4/26/2016	12:53:50 PM	19.2		3
7	Segment 1	Tech1	AT_DEVICE	4/26/2016	12:54:00 PM	19.2		3
8	Segment 1	Tech1	AT_DEVICE	4/26/2016	12:54:10 PM	19.2		3
9	Segment 1	Tech1	AT_DEVICE	4/26/2016	12:54:20 PM	19.2		3
10	Segment 1	Tech1	AT_DEVICE	4/26/2016	12:54:30 PM	19.2		3
11	Segment 1	Tech1	AT_DEVICE	4/26/2016	12:54:40 PM	19.2		3
12	Segment 1	Tech1	AT_DEVICE	4/26/2016	12:54:50 PM	19.2		3
13	Segment 1	Tech1	AT_DEVICE	4/26/2016	12:55:00 PM	19.2		3
14	Segment 1	Tech1	AT_DEVICE	4/26/2016	12:55:10 PM	19.2		3
15	Segment 1	Tech1	AT_DEVICE	4/26/2016	12:55:20 PM	19.2		3
16	Segment 1	Tech1	AT_DEVICE	4/26/2016	12:55:30 PM	19.2		3
17	Segment 1	Tech1	AT_DEVICE	4/26/2016	12:55:40 PM	19.2		3
18								
19								

Measurement intervals

The Target Update Rate you set when you enable logging determines how many seconds occur between the sets of measurements, up to the maximum number of log entries you specify. The default is to take a DC voltage, noise, and signal measurement every 10 seconds up to 1,000 times. After 1,000 sets of measurements, the Fieldbus Diagnostics application turns off logging and stops saving measurements.

The measurements may be taken more frequently than the number you set for the Target Update Rate. If the Fieldbus Diagnostics application detects a device was added/removed or it detects a bad DC voltage, the application captures an extra measurement "row" in the log file to show the drop in voltage. The application attempts to take more data to help you troubleshoot and determine the cause of the readings.

Note

The actual update rate may be affected by conditions on the fieldbus network. For example, if the fieldbus network has a lot of scheduled activity, the rotation of the network token will be slow, and the Trex unit will wait longer to measure each device's signal.

Viewing the saved measurements on a PC

To view the saved measurements, you need use the File Transfer Utility to transfer the log file from the Trex unit to a PC. You cannot view the log files on the Trex unit. The File Transfer Utility is included with the install of Upgrade Studio. (You can access the Upgrade Studio installer on the resource DVD/media included with the Trex unit.)

5.13.2 Enable or disable logging

Use the logging option to save measurements to a comma-separated values (.csv) log file. You can save one set of measurements or append additional sets of measurements that you collect at a later date. Appending the measurements lets you create a trend/report of the fieldbus segment.

The log file will continue to save measurements until:

- You disable the logging option.
- The application has saved the selected number of measurements.
- The application has saved 100,000 entries in a log file. This is the maximum number.
- The file size is larger than 176 MB.

Note

As a best practice, create a new log file for each fieldbus segment and connection point you are monitoring. Otherwise, ensure you update the segment name and measurement location fields each time you collect data.

Procedure

1. Connect to the FOUNDATION fieldbus device or segment.
2. On the Fieldbus Diagnostics Overview screen, tap Logging.
3. Modify the following options, as needed.

Option	Description
User Name	The name of the person completing the measurements.
Segment Name	The name of the fieldbus segment. If you tap the Go Online option, the Fieldbus Diagnostics application creates a unique name. You can enter a new name.
File Name	The name of the .csv file that saves the measurements. You can enter a file name or you can have the application create one based on the device tag or device ID if you tapped Go Online before enabling logging. If multiple devices are on the fieldbus segment, the device with the lowest address is chosen for the file name.
Measurement Location	The location on the fieldbus segment where the Trex unit is connected to take the measurement. The options are At Device, At Fieldbus Control Module, and At Hub.

Option	Description
Save Option	<p>Select Append to save the measurements to an existing log file of the same filename, or select Replace to overwrite the data in an existing log file with the same filename. Append is the default option. The log file is limited to 176 MB. If the file exceeds 176 MB, the application can no longer append additional log files/measurements to the existing file.</p>
Target Update Rate	<p>The number of seconds in between each set of measurements. The default setting is to take a set of measurements every 10 seconds.</p> <p>If the Fieldbus Diagnostics application detects a device was added/removed from the device list or it detects a bad DC voltage, the application captures an extra DC voltage measurement in the log file to show the DC voltage dropping.</p> <hr/> <p>Note</p> <p>The actual update rate may be affected by conditions on the fieldbus network. For example, if the fieldbus network has a lot of scheduled activity, the rotation of the network token will be slow, and the Trex unit will wait longer to measure each device's signal.</p>
Max Log Entries	<p>The maximum number of measurement sets collected in one session and saved to the log file. A DC voltage, a noise, and signal measurement are one measurement set. These entries appear as a row in the .csv log file.</p> <hr/> <p>Note</p> <p>If the maximum number of entries is reached, the Fieldbus Diagnostics application stops saving data to the log file. You can continue to append log entries to an existing log file, until the log file reaches the maximum file size.</p>

The Fieldbus Diagnostics application begins saving the measurements.

5.13.3 Save measurements to an existing log file

You can save measurements to an existing file on the Trex unit to create a trend/report of the fieldbus segment.

Note

The Fieldbus Diagnostics application does not let you browse to an existing log file saved on the Trex unit. You need to enter the file name.

Procedure

1. On the Fieldbus Diagnostics Overview screen, tap Logging.
The Log Settings screen lists the current file name that is being used.
2. Check the name listed in the File Name field. If it is the desired file, tap OK.
3. If the desired file name is not listed, do the following:
 - a. Tap File Name on the Log Settings screen.
 - b. Tap File Name.
 - c. Enter the desired file name, and tap OK.
 - d. Tap OK.
4. Ensure Append is selected for the Save Option.
5. Tap OK.

5.13.4 Transfer a Fieldbus Diagnostics log file from the Trex unit to a PC

The Trex File Transfer Utility saves files to a default location on your PC. The utility can transfer one or more files. After the files are transferred to the PC, the files are removed from the Trex unit.

Procedure

1. Close the Fieldbus Diagnostics application on the Trex unit.
2. Connect the Trex unit to the PC where the Trex File Transfer Utility is installed using a USB cable.
3. Open the Trex File Transfer Utility.
The application connects to the Trex unit. The connected Trex unit is listed by its default name.
4. Next to Fieldbus Diagnostics Dataset, click Transfer.
The Trex File Transfer Utility creates the folder, if necessary, to save the files and then transfers the files from the Trex unit to the PC. The Fieldbus Diagnostics file is removed from the Trex unit.
5. Click OK.
6. Click the file directory next to Destination to open the folder and access the transferred files.
7. To disconnect the Trex unit, remove the USB cable.

5.14 Troubleshooting Fieldbus Diagnostics

If you see a measurement labeled BAD or CHECK, tap Details to view the values for each measurement. Press and hold a measurement value on the screen to view Help that describes overview or troubleshooting information. You can also access the Help menu by holding the checkmark button on the keypad when a measurement value is selected.

Note

To prevent inaccurate BAD or CHECK readings, review the measurement criteria in the Settings, and set the minimum and maximum values to ensure they are appropriate for your installation.

Figure 5-11: Help text example

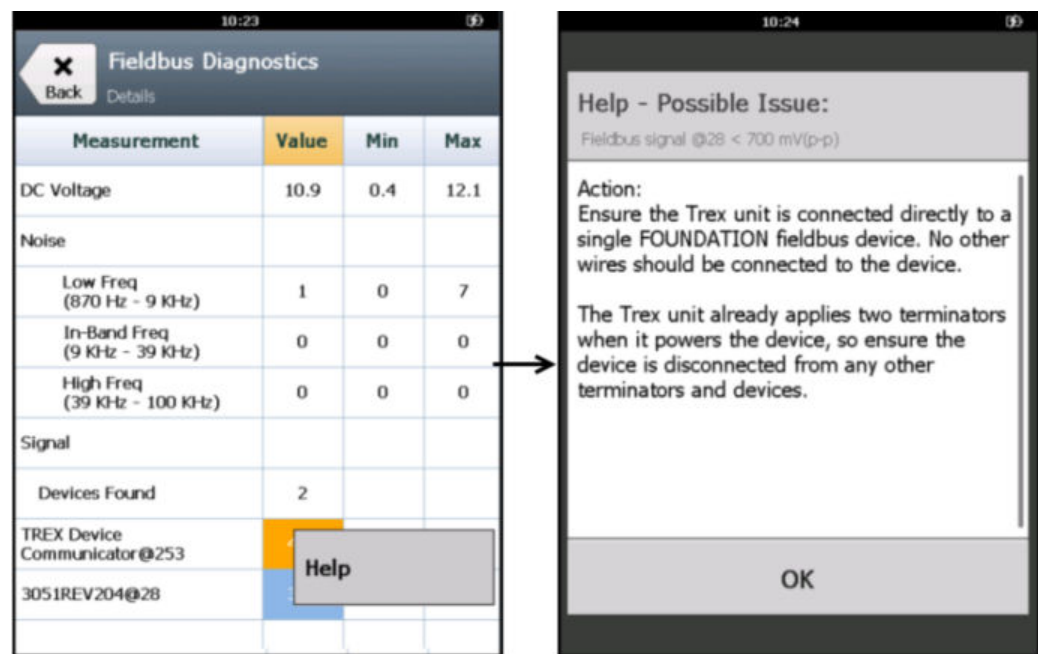

DC voltage measurement	Possible cause	Action
Lower than expected	The power supply's voltage setting may be set too low.	Verify the power supply's voltage setting is correct. If necessary, increase the power supply voltage.
	An unexpected voltage drop may be due to a damaged cable, corrosion in the terminals, low impedance to ground, water in the device terminals, or loose connections.	Measure the voltage at several points on the fieldbus segment to determine the location of the unexpected voltage drop. Start at the power supply and continue toward the original measurement point where the voltage was measured low.

DC voltage measurement	Possible cause	Action
Higher than expected	There may be more than one voltage source on the fieldbus segment.	Ensure there is only one voltage source.
	The power supply's voltage setting may be set too high.	Verify the power supply's voltage setting is correct. If necessary, decrease the power supply voltage.

Low-Frequency noise	Possible cause	Action
Higher than expected	When the AC adapter is attached to the Trex unit, it can appear as low-frequency noise.	Disconnect the AC adapter from the Trex unit to isolate it from the local power grid.
	The device or shield is not properly grounded.	Ensure the device is properly grounded. Ensure the shield is properly isolated from the terminal housing. The shield should be grounded at only one location on the entire fieldbus segment and it should be a high-quality ground. Repeat these checks for all devices on the fieldbus segment.
	The power supply is not supplying a good, stable voltage.	Ensure the power supply is properly installed. Isolate the power supply and check for noise.

In-band frequency noise	Possible cause	Action
Higher than expected	The device or shield is not properly grounded.	Ensure the device is properly grounded. Ensure the shield is properly isolated from the terminal housing. The shield should be grounded at only one location on the entire fieldbus segment and it should be a high-quality ground.
	A cable may be damaged.	Visually inspect the cables and test the resistance between the two wires and each wire against the ground.

High-frequency noise	Possible cause	Action
Higher than expected	There may be loose wire connections.	Check for loose connections. Vibration from nearby motors or wind gusts may cause loose connections to be displayed as high-frequency noise.
	Water or moisture may be in the device's terminal housing.	Check the device's terminal housing.
	A cable may be damaged.	Use the signal or DC voltage measurement to find the cable portion that may be damaged. Visually inspect the cables, and test the resistance between the two wires and each wire to the ground.
	Variable-frequency drives installed near the fieldbus segment may not have the recommended grounding and filtering.	Check the grounding and filtering that are used.

Fieldbus signal	Possible cause	Action
Lower than expected	The Trex unit is attached far away from the FOUNDATION fieldbus device that is transmitting the signal.	Connect the Trex unit directly to the communication terminals on the device. No other wires should be connected to the device. Ensure the device is disconnected from any other terminators or devices. Connect the Trex unit to a connection point that is closer to the device on the fieldbus segment.
	The cable between the Trex unit and the device is damaged.	Determine if the signal loss is acceptable. If it is not, replace the cable between the Trex unit and the device. Fieldbus signals can be received when they are 250 mVp-p or higher, so loss of signal amplitude is tolerable.

Fieldbus signal	Possible cause	Action
	There are too many terminators on the fieldbus segment.	Review the number of terminators. A fieldbus segment should have two terminators. Note The Trex unit adds two terminators when it powers a FOUNDATION fieldbus device.
Higher than expected	The Trex unit is attached to a block with short-circuit protection. Non-standard terminators are used to achieve short-circuit protection. This slightly changes the fieldbus signal, and the signal amplitude is increased by 20 to 30 percent.	To see the normal fieldbus signal amplitudes, connect the Trex unit to the trunk of the connector block.
	The Trex unit is powering a FOUNDATION fieldbus device, but it is not attached directly to the device terminals.	Ensure the Trex unit is connected directly to a single FOUNDATION fieldbus device. No other wires should be connected to the device. Ensure there are no resistors in-series with the device's terminals.
	When the Trex unit powers a FOUNDATION fieldbus device, non-standard terminators are used to meet Intrinsic Safety requirements. This slightly changes the fieldbus signal, and the signal amplitude is increased by 20 to 30 percent. The signal amplitude for the Trex unit is not impacted.	None. This is normal when the Trex unit is providing power. The higher signal level is acceptable on these terminators.
	The fieldbus segment is missing a terminator.	Attach another fieldbus terminator to the fieldbus segment.

Appendix A

Troubleshooting

Topics covered in this appendix:

- [Troubleshoot HART communication](#)
- [Troubleshoot fieldbus communication](#)

A.1 Troubleshoot HART communication

Symptom	Possible cause	Solution
"No Voltage Detected" message is displayed.	The lead set is improperly connected to the device.	Attach the lead set to the device.
	The Trex unit is connected to a 4-wire device or a wireless device that is powered by its battery.	None. This is expected behavior.
There is intermittent communication.	Insufficient loop current and voltage at the device terminals.	Verify there is at least 4 mA and 12 VDC at the device terminals.
	Noise on the loop, or noise or signal distortion from the control system. For example, noise from the power supply powering the devices, or front end analog circuitry inside the control system may be distorting the HART signal.	An oscilloscope can help determine noise or signal distortion of HART signals.
	Poor wiring.	Check the wiring terminations and exposed signal wire for damage.
There is no communication with device.	Insufficient loop resistance at the HART frequencies.	Add an additional 250 ohm resistor in series in the loop. Place the leads across the resistor and verify communication occurs.
	Insufficient loop current and voltage at the device terminals.	Verify there is at least 4 mA and 12 VDC at the device terminals.
	The AC adapter is attached to the Trex unit.	Remove the AC adapter from the Trex unit and try to connect to the device.

Symptom	Possible cause	Solution
	Device may be set to a HART address other than zero (multidrop mode).	Change the polling mode to Poll by Address.
Control system is communicating HART, but the Trex unit is not communicating properly.	An internal fuse may be blown.	Connect a meter capable of measuring M ohms to the HART or mA terminals. An OPEN reading may indicate a blown fuse.
	HART communication is being prevented by the control system.	Stop HART communications on the control system and verify if communication between the devices and the Trex unit is restored.
	More than one Trex unit or other secondary master may be attached to the control loop.	Ensure there is only one primary master and one secondary master on the control loop.
A HART device appears at the multiple addresses.	The incorrect polling addresses may be used.	Change the addresses being polled.
	HART Universal Revision 5 (or earlier), 6, and 7 devices are on the same loop.	Put HART Universal Revision 5 or earlier devices on a separate loop from HART Universal Revision 6 or 7 devices.
When the Trex unit tries to power a device, a message stating voltage still detected at HART terminals appears.	This message can appear if the Trex unit connects to a device that was recently powered. Some devices may hold voltage for several minutes after the power is removed.	The Trex unit asks if you want to ignore the voltage warning and proceed with sourcing power. If you select Yes, Trex powers the device. You can also wait a few minutes before connecting to and powering the device.

Symptom	Possible cause	Solution
The Trex unit needs to supply more current than the typical 4 mA to power a positioner. This can occur when the positioner needs more current to power the CPU at faster speed for diagnostics.	Use the device connection wizard in the Field Communicator application to increase mA.	<ol style="list-style-type: none"> 1. In the Field Communicator application, connect to the positioner. 2. Change its polling address to a non-zero value. 3. Disconnect the positioner, and restart the Field Communicator application. 4. Tap HART. 5. Tap Yes when prompted if you want to provide power from the Trex unit. 6. Tap Positioner. 7. Tap Yes when prompted to increase current. 8. Select the current value.

A.1.1 HART loops

Verify the HART loop current and voltage on the device. Almost all devices need at least 4 mA and 12V DC to operate properly. If there are multiple devices on a multidrop loop, set the Trex unit to Poll by Address and ensure the Auto-Connect option in the Field Communicator Settings is disabled.

Inspect the loop wiring to identify problems. The shield is normally grounded at one end only, which is usually the control system.

Sample values

Loop Current Flow Minimum voltage for 250 ohms.

mA	Volts
4 mA	1 Volt
8 mA	2 Volts
12 mA	3 Volts
16 mA	4 Volts
20 mA	5 Volts

If the voltage across the process-indicating device is greater than the value listed for a given current flow, the device has at least 250 ohms of internal resistance. If the voltage is less than the value listed in the table for the given current flow, more resistance needs to be added to the loop.

If an oscilloscope is available, use it to look for noise on the loop. Use a scope with differential mode capability or a battery powered/isolated scope to avoid grounding one side of the loop. Noise with a frequency of 500 Hz to 10,000 Hz is of particular interest, as this represents frequencies near the HART frequencies of 1200 and 2200 Hz.

A.2 Troubleshoot fieldbus communication

Symptom	Possible causes	Solution
No communication with the device.	The Trex unit is connected to a fieldbus segment with a host system and the device on the same segment is being commissioned using the host system.	The Trex unit is unable to communicate with this device until you go offline and then back online.
	An internal fuse may be blown.	Connect a meter capable of measuring M ohms to the FF terminals. An OPEN reading may indicate a blown fuse.
Unable to change the address of a device.	The Trex unit is unable to change the address of a device that is currently the LAS.	Establish communication by putting the Trex unit on the fieldbus segment first and then adding one or more devices. By putting the Trex unit on first, it remains the LAS and allows the address change.
The Trex unit does not remain the LAS on a fieldbus segment.	A host takes over as the LAS.	When a host is established on a fieldbus segment, it will take over as the LAS. No action is required.

Appendix B

Technical specifications

Topics covered in this appendix:

- *Physical specifications*
- *Communication module specifications*
- *Processor, memory, operating system specifications*
- *Environmental specifications*
- *Intrinsically Safe electrical parameters*
- *Power module specifications*
- *AC adapter specifications*

This chapter lists the specifications for the hardware and the AC adapter.

B.1 Physical specifications

Specification	Value
Weight	Approximately 1330 grams
Height x width	7.75" x 5.5" inches
Display	5.7 inch color VGA resistive touchscreen
	640 x 480 pixel
Buttons (front of the Trex unit)	X button - similar to a Back key
	4 arrow buttons to navigate menus
	Checkmark - similar to an Enter key
USB	Micro USB connector. USB 2.0 Remove the USB cable from the Trex unit before connecting to a device.

B.2 Communication module specifications

Device Communicator communication module

Terminal	Overview
HART terminals	<p>The terminals enable HART communication with the Trex unit.</p> <p>Connectors: Two banana jack plugs.</p> <p>Internal fuse rating: 50 mA</p> <p>Optional internal resistors 250 Ohm or 500 Ohm resistor</p>
Fieldbus (FF) terminals	<p>The terminals enable FOUNDATION fieldbus communication with the Trex unit.</p> <p>Connectors: Two banana jack plugs.</p>

Device Communicator Plus communication module

Terminal	Overview
HART terminals	<p>The terminals enable HART communication with the Trex unit.</p> <p>Connectors: Two banana jack plugs.</p> <p>Voltage measurement accuracy: +/- 2% of reading for measurements greater than 3 volts</p> <p>Internal fuse rating: 50 mA.</p> <p>Optional internal resistors 250 Ohm or 500 Ohm resistor.</p> <p>Current control Range: 3-22.5 mA Accuracy: 0.25% of span (4-20 mA) Resolution: 0.04 mA Drive capability: 650 ohms at 22.5 mA</p>

Terminal	Overview
<p>HART + pwr terminals (Includes HART power supply, resistors, current control, and ammeter)</p>	<p>The terminals enable HART communication with the Trex unit, and provide power to one HART device in a bench setup.</p> <p>Connectors: Two banana plugs.</p> <p>Voltage measurement accuracy: +/- 2% of reading for measurements greater than 3 volts.</p> <p>Internal resistor 167 Ohm resistor.</p> <p>HART power supply Power to a transmitter includes a 167 Ohm resistor and high-accuracy ammeter. Power to a positioner includes optional control of loop current and "for reference only" ammeter reading.</p> <p>Output: 22.9 V +/-0.2 V at no load. 16.4 V +/-0.3V at 22.5 mA.</p> <p>Internal ammeter The HART + pwr terminals have two ammeters: one for connections to transmitters and one for connections to positioners. Accuracy: +/- .25 % of the reading. Internal fuse rating: 50 mA. Range: Up to 24 mA. Ammeter resolution when powering a transmitter: 0.01 mA. Ammeter resolution when powering a positioner: 0.1 mA.</p> <p>Current control Range: 3-22.5 mA Accuracy: 0.25% of span (4-20 mA) Resolution: 0.04 mA Drive capability: 650 ohms at 22.5 mA</p>
<p>mA terminals (external ammeter)</p>	<p>The terminals measure current on a 4-20 mA current loop.</p> <p>Connectors: Two banana jack plugs.</p> <p>Internal fuse rating: 250 mA.</p> <p>Range: Up to 22.5 mA.</p> <p>Resolution: 0.1 mA.</p> <p>Shunt resistor: 2.43 Ohms.</p>
<p>FF terminals</p>	<p>The terminals enable FOUNDATION fieldbus communication with the Trex unit.</p> <p>Voltage measurement accuracy: +/- 3% of reading for measurements greater than 3 volts.</p>

Terminal	Overview
FF+ pwr terminal (Includes power supply, power conditioning, and two terminators)	<p>The terminal provides power to one FOUNDATION fieldbus device in a bench setup.</p> <p>Connector: One banana jack plug.</p> <p>Voltage measurement accuracy: +/- 3% of reading.</p> <p>Fieldbus power supply</p> <p>Output:</p> <p>0 mA (No device or Trex fieldbus communication)</p> <p>11 mA (No device, only Trex fieldbus communication)</p> <p>38 mA (38 mA for the device, no Trex fieldbus communication)</p> <p>38 mA (27 mA for the device and Trex fieldbus communication)</p> <p>Power conditioner: Included.</p> <p>Terminator: Two included.</p>

B.3 Processor, memory, operating system specifications

Specification	Value
Microprocessor	800 MHz ARM Cortex A8 / NXP
Memory	512 MB DDR3 SDRAM, 2 GB NAND Flash, 32 GB Extended Flash
Operating system	Windows Embedded Compact 2013

B.4 Environmental specifications

Specification	Value
Temperature limits	-20°C to +55°C (-4°F to 131°F) 0% to 95% RH non condensing for 0°C to +55°C (32°F to 131°F) For IS approval: -20°C to +50°C (-4°F to 122°F)
Charge	+10°C to +45°C (50°F to 113°F)
Storage with power module	-20°C to +50°C (-4°F to 122°F) (less than 1 month)
Storage without power module	-20°C to +60°C (-4 °F to 140°F)
Enclosure rating	IP54

Specification	Value
Shock	The unit shall survive a 1-meter, all sides and corners drop test onto concrete.

B.5 Intrinsically Safe electrical parameters

Table 1: Device Communicator communication module

	FOUNDATION™ fieldbus	FOUNDATION™ fieldbus	HART®
	(non-FISCO)	(FISCO)	
	FF + and -	FF + and -	
Ui	30 Vdc	30 Vdc	30 Vdc
li	380 mA	215 mA (IIC) 380 mA (IIB)	200 mA
Pi	1.3 W	1.9 W (IIC) 5.3 W (IIB)	1.0 W
Ci	0	0	0
Li	0	0	0
Uo	1.89 V	1.89 V	1.89 V
Io	32 μA	32 μA	32 μA
Po	61 μW	61 μW	61 μW
Co	14.3 μF	14.3 μF	14.3 μF
Lo	100 mH	100 mH	100 mH

Table 2: Device Communicator Plus communication module

	mA interface	FOUNDATION™ fieldbus		HART®		FOUNDATION™ fieldbus	
		(non-FISCO)				(FISCO)	
		mA	FF pwr and F-	FF + and -	HART + pwr	HART + and -	FF pwr and F -
Ui	30 Vdc	17.5 Vdc	30 Vdc	30 Vdc	30 Vdc	17.5 Vdc	30 Vdc
li	200 mA	380 mA	380 mA	200 mA	200 mA	380 mA	215 mA (IIC) 380 mA (IIB)
Pi	1.0 W	1.3 W	1.3 W	1.0 W	1.0 W	1.3 W	1.9 W (IIC) 5.3 W (IIB)
Ci	0	231 nF	0	0	0	231 nF	0
Li	0	0	0	0	0	0	0
Uo	0	17.31 V	1.89 V	25.69 V	1.89 V	17.31 V	1.89 V

	mA interface	FOUNDATION™ fieldbus		HART®		FOUNDATION™ fieldbus	
		(non-FISCO)				(FISCO)	
	mA	FF pwr and F-	FF + and -	HART + pwr	HART + and -	FF pwr and F -	FF + and -
Io	0	199 mA	32 μA	105 mA	1.9 mA	199 mA	32 μA
Po	0	0.94 W	61 μW	668 mW	3.6 mW	0.94 W	61 μW
Co	-	See table 3	14.3 μF	See table 4	14.3 μF	See table 3	14.3 μF
Lo	-	See table 3	100 mH	See table 4	100 mH	See table 3	100 mH

Table 3: Co and Lo values for FF pwr and F-			
Co [nf]	19	69	115
Lo [μH]	100	50	30

Table 4: Co and Lo values for HART + pwr				
Co [nf]	57	64	75	102
Lo [μH]	1000	750	500	100

B.6 Power module specifications

Specification	Value
Charge time	3 to 4 hours
LEDs	6 LEDs. Five LEDs for indicating the progress of charging. One LED to indicate the AC adapter is charging the power module.
Operating time	More than 8 hours of typical use
Type	Lithium Ion (Li-Ion)

B.7 AC adapter specifications

Electrical Specification	
AC input voltage range	90-264 VAC

Electrical Specification	
Frequency	47 - 63Hz
Input current	1.6A max. at low line input and full load output
Inrush current	60 A max. at 230VAC input and 25°C ambient temperature
Leakage current	<0.25 mA
Input protection	1.6A 250VAC Fuse
No load power consumption	<0.5W max. at nominal input and no load output
Output voltage	15 V
Output current	4.33 A
Ripple and noise	1% Vout
Hold up time	10ms at nominal input and full load output
No load operation	Yes, to protect power supply and system from damage
Short circuit protection	Auto recovery, cannot exceed 8A max. after 1 minute at nominal input line.
Over current protection	150-200%, foldback type, auto recovery
Over voltage protection	110-140%, voltage limiting, recycle input to recover
Operating temperature range	0°C to + 50°C
Operating humidity	8-90% RH non-condensing
Operating altitude	Maximum of 2000 meters
Storage temperature range	-20°C to +70°C
Storage humidity	5-95% RH non-condensing
Cooling	Free air convection
Dimensions	119 x 54x 36mm
Weight	0.33 kg
Withstand voltage	I/P-O/P (FG): 3kVAC / 10 mA / 1 minute
EMI	EN55022: 2006 Class B, EN61000-3-2:2006, EN61000-3-3: 1995+A1: 2001+A2:2005 EN55024:1998+A1: 2001+A2: 2003, IEC61000-4-2, -3, -4, -5, -6+A1:2004, -8, -11
Safety	CB (IEC60950-1: 2001), TUV GS (EN60950-1: 2005 +A1 + A2), cUL, CE, VCCI

Approvals

cUL North America, TUV GS Europe, Japan PSE, IRAM Argentina, Russian EAC, Kazakhstan EAC, South Africa SANS IEC 60 950, Korean EK, China CCC.

WEEE 2012/19/EU, RoHS (2011/65/EU)

Appendix C

Product certifications

See the AMS Trex Device Communicator website for the latest certificates, declaration of conformity, and approval information.

Approved manufacturing location

R. STAHL HMI Systems GmbH - Cologne, Germany

Labels

Each Trex unit has a main unit label. An Intrinsically Safe (KL option) Trex unit has another label on the side. If the Trex unit does not have this label, it is considered non-IS approved.

Certifications and approvals

European directive information - CE compliance	
ATEX (2014/34/EU)	This equipment complies with the ATEX Directive. Applicable standards are EN 60079-0:2012 / A11:2013 and EN 60079-11:2012
	Certification No.: SIRA 16ATEX2171
	 II 2 G (1GD) Ex ia [ia Ga] [ia Da IIIC] IIC T4 Gb (Ta = -20°C < Ta < +50°C)
	CE 0158
Electro Magnetic Compatibility (EMC) 2014/30/EU	Tested to the EN 61326-1:2013-07 and ETSI EN 301489-17:2012-09 specification.
Low Voltage 2014/35/EU	Tested to the IEC 61010-1:2010 specification.
RED (2014/53/EU)	This equipment is in conformity with the Radio Equipment Directive (RED) Directive, ETSI EN 300328: 2015-02, and IEC 62209-2: 2010-01 standards.
RoHS (2011/65/EU)	Product is compliant with the RoHS Directive.

International certifications	
IECEx	Certification No.: SIR 16.0057
	Ex ia [ia Ga] [ia Da IIIC] IIC T4 Gb (Ta = -20°C < Ta < +50°C)

North American certifications	
Canadian Standards Association - cSAus	Class I, Division 1, groups A, B, C, D, T4. Class 1, Zone 1 AEx ia [ia Ga] [ia Da IIIC] IIC T4 Gb.
CSA	Ex ia [ia Ga] [ia Da IIIC] IIC T4 Gb

EAC compliance	
EAC Ex TP TC 012/2011	<p>This equipment complies with the EAC Directive.</p> <p>Applicable standards are ГOCT 31610.11-2014 (IEC 60079-11:2011) and ГOCT 31610.0-2014 (IEC 60079-0:2011).</p>  <p>1Ex ia [ia Ga] [ia IIIC Da] IIC T4 Gb</p>
Electro Magnetic Compatibility TP TC 020/2011	Tested to the EN 61326-1:2013-07 and ETSI EN 301489-17:2012-09 specification.
Low Voltage TP TC 004/2011	Tested to the IEC 61010-1:2010 specification.

Appendix D

Wireless/Spectrum approvals

Wireless/Spectrum approvals	
FCC and IC	<p>Radio frequency radiation exposure Information: For body worn operation, this device has been tested and meets FCC RF exposure guidelines.</p> <p>Information sur l'exposition aux rayonnements des ondes radio : Pour le port sur une partie du corps, les directives de la FCC en rapport avec l'exposition aux fréquences RF ont été testées et respectées.</p> <p>NOTE: This equipment has been tested and found to comply with the limits for a Class B digital device, pursuant to Part 15 of the FCC Rules. These limits are designed to provide reasonable protection against harmful interference in a residential installation. This equipment generates, uses and can radiate radio frequency energy and, if not installed and used in accordance with the instructions, may cause harmful interference to radio communications. However, there is no guarantee that interference will not occur in a particular installation. If this equipment does cause harmful interference to radio or television reception, which can be determined by turning the equipment off and on, the user is encouraged to try to correct the interference by one or more of the following measures:</p> <ul style="list-style-type: none"> • Reorient or relocate the receiving antenna. • Increase the separation between the equipment and receiver. • Connect the equipment into an outlet on a circuit different from that to which the receiver is connected. • Consult the dealer or an experienced radio/TV technician for help. <p>NOTICE: This device complies with Part 15 of the FCC Rules and with Industry Canada licence-exempt RSS standard(s). Operation is subject to the following two conditions: (1) this device may not cause harmful interference, and (2) this device must accept any interference received, including interference that may cause undesired operation.</p> <p><i>Le présent appareil est conforme aux CNR d'Industrie Canada applicables aux appareils radio exempts de licence. L'exploitation est autorisée aux deux conditions suivantes:</i> (1) l'appareil ne doit pas produire de brouillage, et (2) l'utilisateur de l'appareil doit accepter tout brouillage radioélectrique subi, même si le brouillage est susceptible d'en compromettre le fonctionnement.</p> <p>NOTICE: Changes or modifications made to this equipment not expressly approved by R. Stahl HMI Systems may void the FCC authorization to operate this equipment.</p> <p>NOTICE : This Class B digital apparatus complies with Canadian ICES-003. <i>Cet appareil numérique de la classe B est conforme à la norme NMB-003 du Canada.</i></p>
NTC (Thailand)	This telecommunication equipment conforms to NTC technical requirements.

Wireless/Spectrum approvals	
IDA (Singapore)	Complies with IDA Standards DA 100927
TA-2016 /2442 (South Africa)	
Korea	 <ul style="list-style-type: none"> 1.Equipment Name/Model Name: 특정소출력무선기기 (무선데이터통신 시스템용 무선기기) Trex Device Communicator . 2.Registration No.:MSIP-CMM-ERN-71354986317987 3.Applicant Name: Emerson Process Management 4.Manufacture Date: 2016 5.Manufacturer/Country of Origin: Emerson Process Management / 독일 <p>"해당무선설비는 운용 중 전파혼신 가능성이 있음"</p>

Glossary

Activation	Activation updates the Trex unit with any needed licenses and enables the full functionality of the Trex unit. Activation also associates the Trex unit and its attached Trex modules with a user account/company.
Ammeter	The mA terminals on the Device Communicator Plus communication module that enable the Trex unit to measure current on a 4-20 mA current loop. The HART + pwr terminals can also measure current.
Burst mode	A communication mode in a HART transmitter to send data at regular intervals.
Commissioned device	A device that has been set up to communicate with a host system. This usually includes assigning a permanent address to the device. Some operations on the Trex unit are disabled for commissioned devices because they could cause process disruption.
Communication module	A term to refer to either the Device Communicator communication module or the Device Communicator Plus communication module.
Data Link Time	A network-wide time that is periodically distributed by the LAS to synchronize all device clocks on the bus.
Device	See HART device or FOUNDATION fieldbus device.
Device Communicator communication module	A communication module you can attach to the Trex unit. This module has terminals that enable the Trex unit to communicate with HART and FOUNDATION fieldbus devices.
Device Communicator Plus communication module	A communication module you can attach to the Trex unit. This module has terminals that enable the Trex unit to communicate with HART and FOUNDATION fieldbus devices, power a HART or FOUNDATION fieldbus device, and measure current on a 4-20 mA current loop.
Device description (DD)	A set of instructions written in the HART or FOUNDATION fieldbus Device Description Language that defines the parameters, commands, and methods that a host application uses to communicate with a HART or FOUNDATION fieldbus device.
Externally-powered device	A HART or FOUNDATION fieldbus device that is powered by a power supply or digital control system. The Trex unit is not powering the device, loop, or fieldbus segment.
Externally-powered loop	A HART or 4-20 mA current loop that is powered by a power-supply or digital control system. The Trex unit is not powering the loop.
FOUNDATION fieldbus	FOUNDATION fieldbus technology uses device descriptions and function blocks to enable intelligent devices to execute control functions traditionally performed by a distributed control system.
FOUNDATION fieldbus device	A device that communicates information using the fieldbus protocol on a digital, serial, multidrop data bus.
FOUNDATION fieldbus Power Plug	A connector with two banana jacks that allows the Trex unit to power a FOUNDATION fieldbus device. Attach the lead set to the FF terminals, and then

	attach the FOUNDATION fieldbus Power Plug to the FF pwr terminal and to the positive (red) FF terminal on top of the lead set.
HART device	A device that communicates information using the HART protocol.
HART loop	A network that combines an analog signal and digital signal to communicate the process variable and additional device diagnostics in a master/slave configuration. The network must have HART or HART-compatible devices and the proper amount of impedance, which may vary based on the device and network configuration.
HART protocol	Highway Addressable Remote Transducer communication protocol. An industry-standard protocol for digitally enhanced 4-20 mA communication with devices.
HART tag	An 8-character field used to identify a device. A 32-character long tag is also possible with HART Universal Revision 6 or higher devices. This field is stored in the HART device and can be modified.
Intrinsic Safety (IS)	<p>Circuits that are designed to limit the amount of energy consumed or provided to devices to levels below those that are required to ignite specific types of hazardous materials under fault and no fault conditions.</p> <p>It is also a method of providing safe operation of electronic process-control instrumentation in hazardous areas, such as flammable environments. IS systems keep the available electrical energy in the system low enough that ignition of the hazardous atmosphere cannot occur.</p>
Intrinsic Safety barrier	A physical entity that limits the current and voltage into a hazardous area to satisfy Intrinsic Safety requirements.
Lead set	A cable with two banana plugs to connect the Trex unit to a device.
Link Active Scheduler (LAS)	The bus arbiter for the fieldbus segment. The LAS recognizes and adds new devices to the link, removes non-responsive devices from the link, and distributes Data Link (DL) and Link Scheduling (LS) time on the link.
Link Master	A Link Master device controls when a device accesses the fieldbus segment and executes the link schedule, which synchronizes communications with function block execution on the fieldbus. The H1 card or any device that supports Link Master functionality can function as a Link Master device. Only one Link Master device can be active at a time on the fieldbus segment. This device is called the LAS.
Link Master Configuration	An option to set a device as a basic or link master device. Only devices that are capable of being a Link Active Scheduler have this option.
Link Scheduling time	Link Scheduling time is a link-specific time represented as an offset from Data Link Time. It is used to indicate when the LAS on each link begins and repeats its schedule. System management uses it to synchronize function block execution with the data transfers scheduled by the LAS.
Offline	The Trex unit is not connected to or communicating with a live device.
Online	The Trex unit is communicating with a live device.
Pairing	Associating an AMS Trex unit with an AMS Device Manager database using USB. Once paired, an AMS Trex unit can synchronize device data with AMS Device Manager. A Trex unit can be paired to one AMS Device Manager system.
Polling	A method of sequentially searching a network to determine which devices are present.

Positioner	A digital valve positioner.
Process variable	A process parameter that is being measured or controlled (for example, level, flow, temperature, mass, or density).
Segment (fieldbus only)	The section of a fieldbus that is terminated in its characteristic impedance. Segments are linked by repeaters to form a complete fieldbus.
Shortcut bar	The shortcut bar displays settings and information about the Trex unit, including viewing version numbers for the Trex unit and setting the screen brightness.
Shout/deaf mode	A communication mode where the amplitude of the signal is increased. The Trex unit determines when to enter this mode. The icon (with a solid or hollow heart) indicates when the Trex unit is in this mode.
Slot time	A setting that can help the Trex unit find FOUNDATION fieldbus devices on a fieldbus segment. A higher slot time helps the Trex unit find older FOUNDATION fieldbus devices on the fieldbus segment.
Status bar	A black bar that displays at the top of all screens. The status bar displays the time and the power module icon.
Suspend	A power management option to save power on the Trex unit. Suspend is similar to the standby mode on a phone.
Synchronization	Ability to update AMS Device Manager database with device information from a Trex unit that has been paired. Synchronization is automatic, and can occur using USB or Wi-Fi.
Upgrade Studio	A PC application that lets you update the Trex unit at your site. You can activate the Trex unit, download updated applications and device descriptions, and purchase new applications.

Index

A

- AC adapter
 - approvals 188, 189
 - charge power module 18
 - connector 5
 - overview 15
 - specifications 188, 189
- activate
 - applications 42
 - Trex unit 42
 - without internet connection 42
- activation
 - overview 36
 - verify status 36
- address
 - change 83, 84, 111
- Advanced menu 95
- alerts 88
- ammeter
 - communication module 10
 - overview 12
 - specifications 184
- ANSI (American National Standards Institute)
 - conventions 1
- application
 - activate 36
 - close 27, 36
 - get new or updated 40
 - purchase 36
 - simultaneous 36
 - supported (PC) 40
 - switch between multiple 36
 - update 36
 - view open 26, 27
 - view version number 31
- application bar 57
- approvals 191
- approved manufacturing location 191
- ATEX 191
- Auto mode
 - fieldbus block 105
- auto-connect to HART device
 - enable or disable 35
 - overview 48
- auto-detect a device
 - overview 47

- averages
 - set in Fieldbus Diagnostics 167

B

- backlight
 - change 27
 - timer 33, 34
- backlight timer
 - overview 33
 - set 34
- bar charts
 - horizontal 117
 - vertical 118
- basic device
 - set fieldbus device 112
- Basic Setup 83, 84
- block instantiation 104
- block mode
 - change 105
 - overview 105
- blocks
 - access 104
 - schedule 104
- brightness
 - adjust 26, 27
- burst mode 82

C

- calibration 44
- certifications 191
- charts
 - gauge 119
 - horizontal bar 117
 - overview 116
 - strip/sweep/scope 116
 - vertical bar 118
- communication module
 - install 13
 - location 9
 - overview 10
 - remove 14
- communication terminals
 - FF 96
 - HART 62
 - HART + pwr 62

- configuration
 - copy 91
 - create 90
 - delete 91
 - edit 86, 90
 - marked variable 86, 90
 - rename 91
 - save from a device 89
 - send to HART device 89
- Configure screen 53, 54, 57
- Connect - Select screen
 - overview 48
 - return to 48
- connected deployment
 - activate Trex unit 42
- connections
 - USB 41
- connectors
 - FF 10, 96
 - FF pwr 10
 - HART 10, 62
 - HART + pwr 10
 - mA 10
- CSA 191
- current
 - change button values 141
 - change duration 143
 - control 124, 139, 143, 144
 - increase 142, 179
 - measure 137, 145
 - settings 141, 142
- D**
- damping 83–85
- date
 - format 31
 - set 31
- DC voltage measurement
 - Fieldbus Diagnostics 159
 - fieldbus segment 159
 - Loop Diagnostics 124
 - measure on 4-20 mA current loop 145
 - save to log file 171
 - set range of values 168
 - view measurement status 159
- Detailed Setup 83, 84
- Details screen
 - view Help for a measurement 160
 - view measurement values 160
- device address
 - change 83, 84, 111
 - view for fieldbus device 109
- device blocks 104
- Device Communicator communication module
 - install 13
 - overview 10
 - remove 14
 - specifications 184
- Device Communicator Plus communication module
 - ammeter 12
 - install 13
 - measure current 145
 - overview 10
 - power a FOUNDATION fieldbus device 101, 157
 - power a HART device 78, 136, 137, 139
 - remove 14
 - required for application 123
 - specifications 184
- device configuration 89
- device connection wizard
 - overview 50, 51
- Device Dashboard
 - automatically open 48
 - overview 53, 54
- device description
 - forward compatibility rules 47
 - get new or updated 40
 - simulate 113
 - view available on Trex unit 113
 - view device revision 114
 - view device type 114
 - view manufacturer 114
 - view revision 114
- device ID
 - use as log filename 171
 - view for fieldbus device 109
- device interoperability 46
- Device List
 - automatically open 47
 - FOUNDATION fieldbus 100
 - HART 73
- device not found 100, 112
- device parameter
 - change 85, 109
- device revision
 - view for a connected device 109, 114
- device screen
 - bottom bar 55–57
 - layout 55–57
 - top bar 55–57

- Device Setup screen 53, 54
 - device tag
 - change 83, 84, 110
 - view for fieldbus device 109
 - view/hide in Fieldbus Diagnostics 167
 - diagnostics
 - fieldbus 149, 150
 - HART 123
 - Diagnostics and Service 83, 84
 - disconnected deployment
 - activate Trex unit 42
- E**
- email alerts
 - receive for available updates 41
 - EMC 191
 - environmental specifications 186
 - exchange port
 - changing 30
- F**
- favorites
 - add 92
 - overview 91
 - remove 93
 - view 92
 - FF pwr terminal 10
 - FF terminals 10
 - Field Communicator application
 - connect FOUNDATION fieldbus device 103
 - connect HART device 81
 - favorites 91
 - open or close 46
 - overview 45
 - power a FOUNDATION fieldbus device 101
 - power a HART device 78
 - power a Smart Wireless THUM adapter 80
 - settings 35
 - wiring diagrams 64, 69, 98
 - Fieldbus Diagnostics
 - create trend 168, 169
 - DC voltage measurement 150
 - noise measurement 150
 - open or close 150
 - overview 149, 150
 - Overview screen 150
 - power a FOUNDATION fieldbus device 150, 157
 - save measurements 168, 169, 171, 172
 - settings 150
 - signal measurement 150
 - troubleshoot 174
 - Fieldbus Diagnostics log file
 - transfer to a PC 173
 - fieldbus methods
 - run 108
 - fieldbus polling 112
 - fieldbus terminals 96
 - forward compatibility rules 47
 - FOUNDATION fieldbus device
 - connect 103
 - power 101, 157
 - wiring diagrams 98
 - FOUNDATION fieldbus Power Plug 20, 96, 98, 155
- G**
- gauge chart icon
 - on device menu 61
 - gauge charts 119
 - gestures 7
 - graphics 115
 - graphs 120
 - green LEDs 16
- H**
- hand strap 20
 - hard shut down 23
 - HART + pwr terminals 10
 - HART device
 - connect 64, 81
 - power 78, 136, 137, 139
 - wiring diagrams 64
 - HART Device List
 - automatically open 47
 - overview 73
 - HART icons 82
 - HART long tag 86
 - HART loop
 - diagnostics 123
 - troubleshooting 181
 - wiring diagrams 64
 - HART polling options 50, 51
 - HART short tag 86
 - HART terminals 10, 62
 - hazardous areas 4
 - Help
 - view for a DD parameter 115
 - view for Fieldbus Diagnostics measurement 161
 - view for the Trex unit 23

- high-frequency noise
 - measure 159
 - set range of values 168
 - view on spectrum 165
 - view values 161
 - Home screen
 - icons 23
 - return to 25
 - status bar 23, 25
 - hotkeys 91
- I**
- icons
 - Home screen 23
 - on device menus 61
 - ID
 - create for Trex unit 31
 - IECEX 191
 - images 115
 - in-band frequency noise
 - measure 159
 - set range of values 168
 - view on spectrum 165
 - view values 161
 - instantiation 104
 - internal resistors
 - enable or disable 76
 - overview 74, 75
 - values 74, 75
 - intrinsically safe electrical parameters 187
 - IO block schedule 107
- K**
- keypad 5
- L**
- labels
 - serial numbers 9
 - language
 - set 32
 - LAS
 - overview 100
 - view in Field Communicator application 100
 - view on fieldbus segment 103
 - lead set 20
 - LEDs 16, 183
 - lights
 - power module 16
 - link active scheduler 100
 - link master device
 - set fieldbus device 112
 - log file
 - overview 169, 170
 - save measurements to existing 172
 - transfer to a PC 43, 173
 - long tag 86
 - loop check
 - measure current 145
 - measure voltage 145
 - overview 143, 144
 - simulate a device 146, 147
 - Loop Diagnostics
 - home screen 124
 - measured current 124
 - measured voltage 124
 - open or close 124
 - overview 123
 - safely close valve 123
 - sourced current 124
 - loop resistance
 - increase 48, 76
 - resistors in Trex unit 74, 75
 - Low Voltage certification 191
 - low-frequency noise
 - measure 159
 - set range of values 168
 - view on spectrum 165
 - view values 161
- M**
- mA terminals 10
 - MAC address 30
 - maintenance and repair 44
 - Manual mode
 - fieldbus block 105
 - mark parameter 86, 90
 - measurement criteria 153, 154
 - memory
 - specifications 186
 - view available 32
 - menu
 - navigate using keypad 5
 - Menu screen 58
 - methods
 - run 108
 - mode
 - Auto 105
 - change 105
 - Manual 105

- Out of Service 105
- overview 105
- mode parameters 105
- multidrop HART loop 35, 94
- My Device Not Found 73, 100, 112

N

- name
 - create for Trex unit 31
 - view 31
- no internet connection
 - activate Trex unit 42
- noise
 - affecting the fieldbus segment 162, 164
- noise measurement
 - high frequency 165
 - in-band frequency 165
 - low frequency 165
 - overview 149, 150
 - save to log file 171
 - set range of values 168
 - view measurement status 159
 - view values 161
- noise spectrum 162, 164, 165

O

- offline deployment
 - activate Trex unit 42
- Online menu
 - automatically open 48
 - overview 53, 54
- open-source licenses 30
- operating system
 - version number 30
- orange LED 16
- Out of Service mode
 - fieldbus block 105
- Overview screen
 - device menu 53, 54
 - Fieldbus Diagnostics 149, 150

P

- pair an AMS Trex unit 38
- paired
 - icon 25
- parameter
 - change 84, 85, 109
 - mark 86, 90
- pc applications
 - supported 40

- pencil icon
 - on device menu 61
- polling options
 - FOUNDATION fieldbus devices 100, 112
 - HART devices 48, 94
- positioner
 - connect 81
 - power 78, 127–129, 139
 - wiring diagrams 64, 130
- power button 5, 22
- power management
 - backlight timer 34
 - enter or leave suspend 33
 - overview 33
 - shut down timer 34
 - suspend timer 34
- power module
 - charge 18
 - icon 25
 - install 18
 - LEDs 16, 17
 - location 9
 - maintain 19
 - overview 14
 - precautions 15
 - remove 19
 - specifications 188
 - view remaining charge 17
- power off timer
 - enable or disable 34
 - overview 33
- power on/off 22, 23
- power supply/charger, *See* AC adapter
- precautions
 - ammeter 12
 - before operating Trex unit 4
 - Device Communicator communication module 10
 - Device Communicator Plus communication module 10
 - power module and AC adapter 15
 - touchscreen 6
- Process Variables 83, 84
- processor 30, 186

R

- range values 83–85
- reboot 22, 23
- resistors
 - enable or disable 76
 - overview 74, 75
 - values 74, 75

Review 83, 84
right arrow icon
 on device menu 61

S

scope chart 116
screen
 calibrate 32
 clean 8
 gestures 7
 overview 6
 specifications 183
segment
 connect to 98, 158
serial numbers
 overview 9
 Trex unit 2
 view 2, 9, 30
Service Tools screen 53, 54, 57
settings
 Field Communicator application 35
 Fieldbus Diagnostics 166
 Loop Diagnostics 141
 Trex unit 26
short tag 86
shortcut bar 26
shout/deaf mode 82
shut down timer
 enable or disable 34
 overview 33
signal level measurement
 overview 149, 150
 save to log file 171
 set range of values 168
 view measurement status 159
simulate
 device for loop check 127–129
 FOUNDATION fieldbus device 113
 HART device 113
slot time 100
specifications
 AC adapter 188, 189
 Device Communicator communication module 184
 Device Communicator Plus communication
 module 184
 IS electrical parameters 187
 memory 186
 physical 183
 power module 188
 processor 186

 storage 186
 usage 186
stand
 replace 44
standby
 enter or leave 33
 set timer 34
status bar
 HART icons 82
 overview 25
 view shortcut bar 26
storage specifications 186
strip chart 116
stroke valve 140
suspend
 enter or leave 33
 set timer 34
sweep chart 116
synchronization
 unpairing 39
 using USB 38
 with AMS Device Manager 37

T

tag
 change 83–85, 110
 view HART long tag 86
 view HART short tag 86
technical support
 contact 2
 information to provide 2
temperature
 specifications 186, 188
text
 enter 8
THUM adapter
 automatically detect 35
 communicate 69
 power 69, 80
 wiring diagrams 69
time
 daylight saving 31
 format 31
 set 31
time zone 31
touchscreen
 calibrate 32
 clean 8
 gestures 7
 overview 6

- precautions 6
- specifications 183
- transfer data from AMS Trex to AMS Device Manager 38
- transmitter
 - connect 81, 103
 - power 78, 101, 127–129, 136
 - power and measure analog output 137
 - wiring diagrams 64, 69
- trend chart icon
 - on device menu 61
- turn on/off 22

U

- units
 - change 84
 - change for device 85
- unpair an AMS Trex unit 39
- Upgrade Studio
 - create user account 41
- USB
 - connect Trex unit 41
 - driver 41
 - overview 37
 - port location 5
- user account
 - create 41
- user configuration 89

V

- valve
 - stroke 140
- ValveLink Mobile
 - overview 23
 - transfer files to a PC 43

- version number
 - application 2, 31
 - operating system 2, 30
- vertical bar charts 118
- view spectrum 165
- voltage
 - measure 4-20 mA current loop 145
 - measure fieldbus segment 149, 150
 - measurement specification 184

W

- weight 183
- Wi-Fi
 - see Wireless 26
- wireless
 - add IP address 29
 - add network 29
 - connect to network 28
 - enable or disable 28
 - forget network 30
 - icon 25
 - icons 27
 - overview 27
- wireless network
 - add 29
- wiring diagrams
 - FOUNDATION fieldbus 98, 155
 - HART 64, 130
 - host system 130

Y

- yellow highlight on menu 84

Emerson
12001 Technology Drive
Eden Prairie, MN 55344 USA
T 1(952)828-3000
www.Emerson.com

©2017, Emerson.

The contents of this publication are presented for informational purposes only, and while every effort has been made to ensure their accuracy, they are not to be construed as warranties or guarantees, express or implied, regarding the products or services described herein or their use or applicability. All sales are governed by our terms and conditions, which are available on request. We reserve the right to modify or improve the designs or specifications of our products at any time without notice.

All rights reserved. The Emerson logo is a trademark and service mark of Emerson Electric Co. All other marks are property of their respective owners.

