



FLEXIM

Portable ultrasonic flow measurement of liquids

Portable instrument for non-invasive, quick flow and energy measurement with clamp-on technology for all types of piping

Features

- Transmitter configurable for flow and thermal energy measurement
 - Flow measurement for all acoustically penetrable fluids
 - Integrated thermal energy measurement for a typical heat and refrigerating agents
 - Temperature range -40...+200 °C, with WaveInjector max. +630 °C
- Precise bidirectional and highly dynamic flow measurement with the non-invasive clamp-on technology
- Calibrated transducers and transmitters with traceable certificates
- Automatic loading of calibration data and transducer detection for a fast and easy set-up (less than 5 min), providing precise and long-term stable results
- High precision at fast and slow flow rates, high temperature and zero point stability
- Portable, easy-to-use flow transmitter with 2 flow channels, multiple inputs/outputs, an integrated data logger with a serial interface
- Integrated wall thickness measurement with connectable wall thickness probe
- The transmitter is water and dust-tight (IP65), resistant against oil, many liquids and dirt
- Robust, water-tight (IP67) transport case with comprehensive accessories
- Li-Ion battery provides up to 25 hours of measurement operation
- User-friendly design
- QuickFix for a simple and fast transmitter fixation, e.g. on pipes

Applications

Designed for harsh environments and applicable in all areas such as drinking water and sewerage industry, power plants, producing industry, food industry and many more

Example applications:

- Operation measurements
- Data gathering in energy management and certifications according to ISO 50001
- Survey of pump performances
- Hydraulic balancing
- Verification of installed measuring systems
- Supervision of permanently installed meters, service and maintenance

Technical specification

FLUXUS F601



FLUXUS F601



Measurement with transducers mounted with fastening shoes, and flow transmitter fixed to the pipe with the QuickFix pipe mounting fixture



Measurement equipment in transport case

Function	3
Measurement principle	3
Calculation of volumetric flow rate	3
Number of sound paths	4
Typical measurement setup	5
Transmitter	6
Technical data	6
Dimensions	7
Standard scope of supply	8
Adapters	8
Example for the equipment of a transport case	9
Transducers	10
Transducer selection	10
Transducer order code	11
Technical data	12
Transducer mounting fixture	14
Coupling materials for transducers	16
Connection systems	17
Clamp-on temperature probe (optional)	18
Technical data	18
Fixation	19
Wall thickness measurement (optional)	20
Technical data	20

Function

Measurement principle

The transducers are mounted on the pipe which is completely filled with the fluid. The ultrasonic signals are emitted alternately by a transducer and received by the other. The physical quantities are determined from the transit times of the ultrasonic signals.

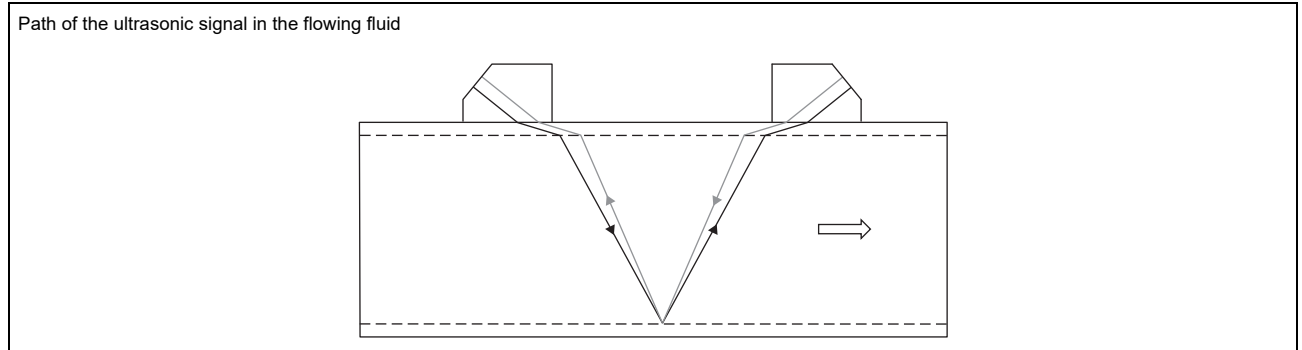

Transit time difference principle

As the fluid where the ultrasound propagates is flowing, the transit time of the ultrasonic signal in flow direction is shorter than the one against the flow direction.

The transit time difference Δt is measured and allows the flowmeter to determine the average flow velocity along the propagation path of the ultrasonic signals. A flow profile correction is then performed in order to obtain the area averaged flow velocity, which is proportional to the volumetric flow rate.

The integrated microprocessors control the entire measuring cycle. The received ultrasonic signals are checked for measurement usability and evaluated for their reliability. Noise signals are eliminated.

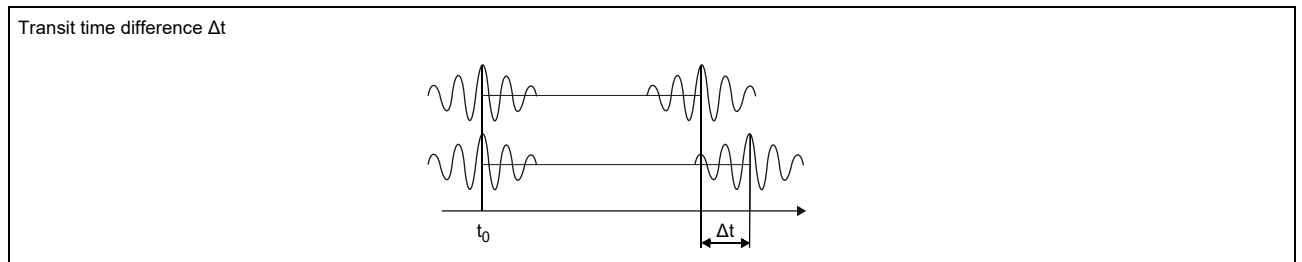

HybridTrek

If the gaseous or solid content in the fluid increases occasionally during measurement, a measurement with the transit time difference principle is no longer possible. NoiseTrek mode will then be selected by the flowmeter. This measurement method allows the flowmeter to achieve a stable measurement even with high gaseous or solid content.

The transmitter can switch automatically between transit time and NoiseTrek mode without any changes to the measurement setup.

Calculation of volumetric flow rate

$$\dot{V} = k_{Re} \cdot A \cdot k_a \cdot \frac{\Delta t}{2 \cdot t_y}$$

where

- \dot{V} - volumetric flow rate
- k_{Re} - fluid mechanics calibration factor
- A - cross-sectional pipe area
- k_a - acoustical calibration factor
- Δt - transit time difference
- t_y - average of transit times in the fluid

Number of sound paths

The number of sound paths is the number of transits of the ultrasonic signal through the fluid in the pipe. Depending on the number of sound paths, the following methods of installation exist:

- **reflection arrangement**

The number of sound paths is even. The transducers are mounted on the same side of the pipe. Correct positioning of the transducers is easier.

- **diagonal arrangement**

The number of sound paths is odd. The transducers are mounted on opposite sides of the pipe. In the case of a high signal attenuation by the fluid, pipe and coatings, diagonal arrangement with 1 sound path will be used.

The preferred method of installation depends on the application. While increasing the number of sound paths increases the accuracy of the measurement, signal attenuation increases as well. The optimum number of sound paths for the parameters of the application will be determined automatically by the transmitter.

As the transducers can be mounted with the transducer mounting fixture in reflection arrangement or diagonal arrangement, the number of sound paths can be adjusted optimally for the application.

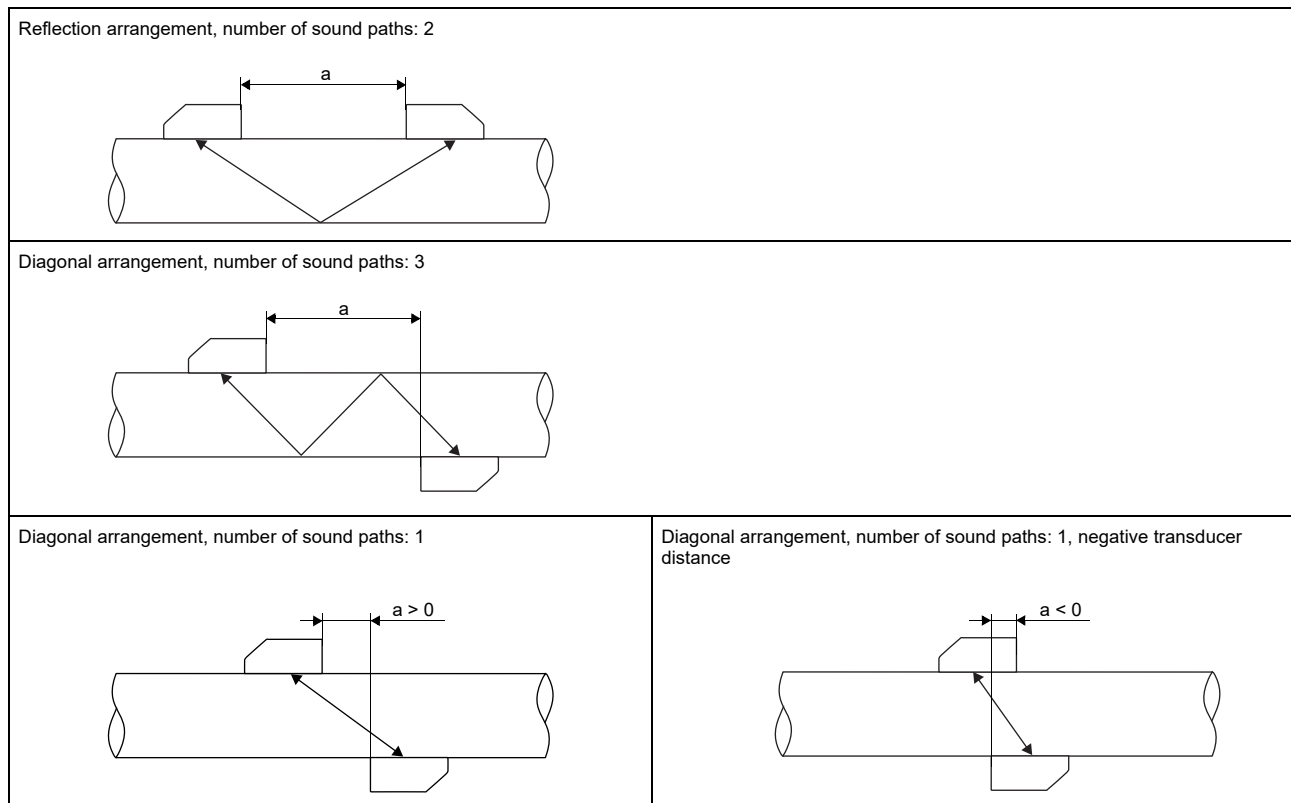

a - transducer distance

Typical measurement setup

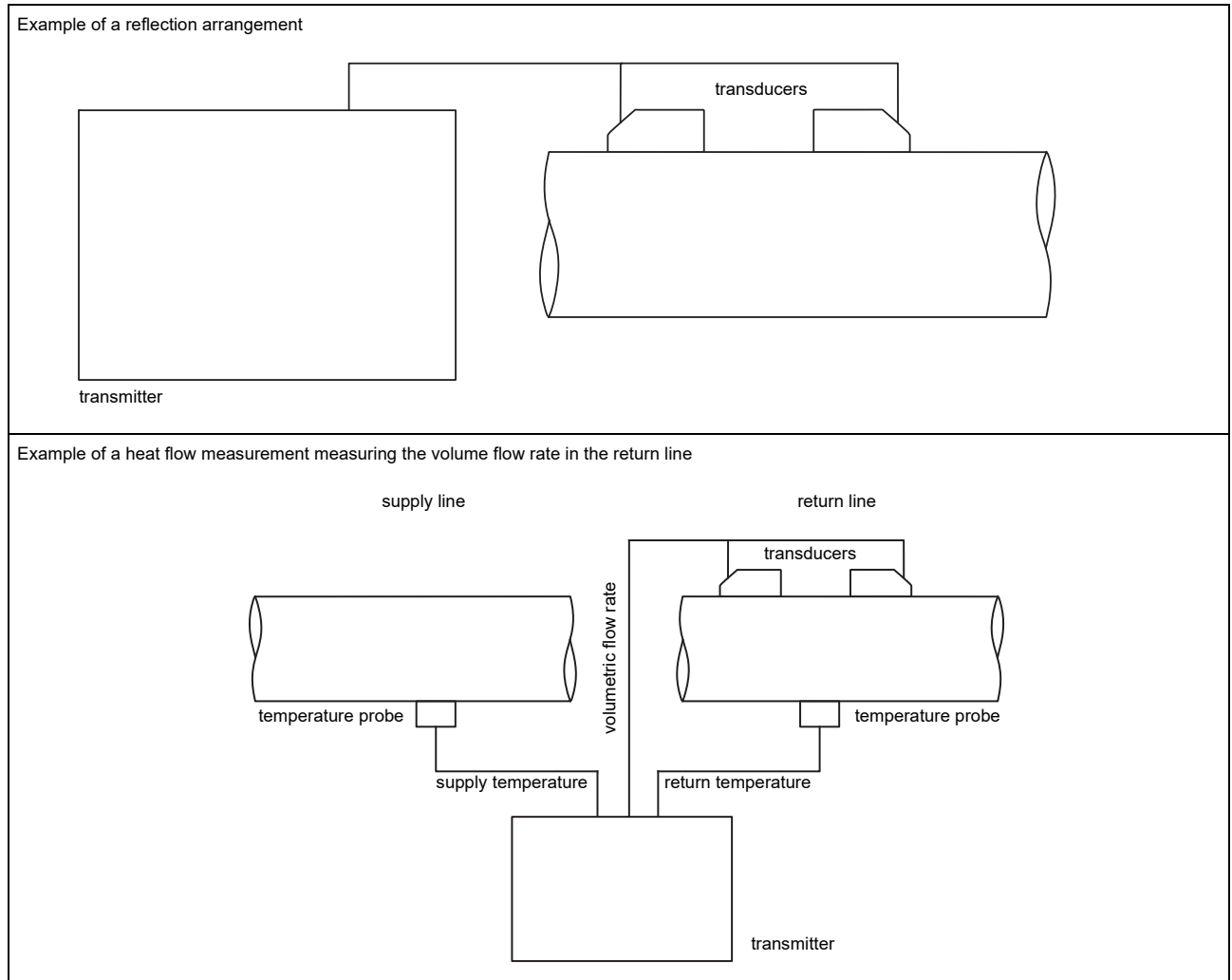

Transmitter

Technical data

FLUXUS F601	
	
design	portable
measurement	
measurement principle	transit time difference correlation principle, automatic NoiseTrek selection for measurements with high gaseous or solid content
flow velocity	m/s 0.01...25
repeatability	0.15 % of reading \pm 0.005 m/s
fluid	all acoustically conductive liquids with < 10 % gaseous or solid content in volume (transit time difference principle)
temperature compensation	corresponding to the recommendations in ANSI/ASME MFC-5.1-2011
measurement uncertainty (volumetric flow rate)	
measurement uncertainty of measuring system ¹	\pm 0.3 % of reading \pm 0.005 m/s
measurement uncertainty at the measuring point ²	\pm 1 % of reading \pm 0.005 m/s
transmitter	
power supply	<ul style="list-style-type: none"> 100...230 V/50...60 Hz (power supply unit: IP40, 0...40 °C) 10.5...15 V DC (socket at transmitter) integrated battery
integrated battery	Li-Ion, 7.2 V/6.2 Ah
operating time	<ul style="list-style-type: none"> > 14 (without outputs, inputs and backlight)³ > 25 (1 measuring channel, ambient temperature > 10 °C, without outputs, inputs and backlight)³
power consumption	< 6 (with outputs, inputs and backlight), charging: 18
number of measuring channels	2
damping	s 0...100 (adjustable)
measuring cycle	Hz 100...1000 (1 channel)
response time	s 1 (1 channel), option: 0.07
housing material	PA, TPE, AutoTex, stainless steel
degree of protection	IP65
dimensions	mm see dimensional drawing
weight	kg 2.1
fixation	QuickFix pipe mounting fixture
ambient temperature	°C -10...+60
display	2 x 16 characters, dot matrix, backlight
menu language	English, German, French, Dutch, Spanish
measuring functions	
physical quantities	volumetric flow rate, mass flow rate, flow velocity, heat flow (if temperature inputs are installed)
totalizer	volume, mass, optional: heat quantity
calculation functions	average, difference, sum
diagnostic functions	sound speed, signal amplitude, SNR, SCNR, standard deviation of amplitudes and transit times
communication interfaces	
service interfaces	<ul style="list-style-type: none"> RS232 USB (with adapter)
process interfaces	<ul style="list-style-type: none"> Modbus RTU (optional)
accessories	
serial data kit	
• cable	RS232
• adapter	RS232 - USB
software	<ul style="list-style-type: none"> FluxDiagReader: download of measured values and parameters, graphical presentation FluxDiag (optional): download of measurement data, graphical presentation, report generation
adapter	AO5, AO6, AO7, AO8, AI1, AI2
transport case	dimensions: 500 x 400 x 190 mm
data logger	
loggable values	all physical quantities, totalized values and diagnostic values
capacity	> 100 000 measured values

¹ with aperture calibration of the transducers

² for transit time difference principle and reference conditions

³ operating time extension using the power pack PP0026NN (optional, order code: ACC-PO-#601-/B6)

FLUXUS F601	
outputs	
	The outputs are galvanically isolated from the transmitter.
number	see standard scope of supply, max. on request
• switchable current output	
	The switchable current outputs are menu selectable all together as passive or active.
range	mA 4...20 (3.2...24)
accuracy	0.04 % of reading $\pm 3 \mu\text{A}$
active output	$U_{\text{int}} = 24 \text{ V}$, $R_{\text{ext}} < 500 \Omega$
passive output	$U_{\text{ext}} = 8...30 \text{ V}$, depending on R_{ext} ($R_{\text{ext}} < 900 \Omega$ at 30 V)
• frequency output	
range	kHz 0...5
open collector	24 V/4 mA
• binary output	
optorelay	26 V/100 mA
binary output as alarm output	
• functions	limit, change of flow direction or error
binary output as pulse output	
• functions	mainly for totalizing
• pulse value	units 0.01...1000
• pulse width	ms 1...1000
inputs	
	The inputs are galvanically isolated from the transmitter.
number	see standard scope of supply, max. 4
• temperature input	
type	Pt100/Pt1000
connection	4-wire
range	$^{\circ}\text{C}$ -150...+560
resolution	K 0.01
accuracy	± 0.01 % of reading $\pm 0.03 \text{ K}$
• current input	
accuracy	0.1 % of reading $\pm 10 \mu\text{A}$
passive input	$R_{\text{int}} = 50 \Omega$, $P_{\text{int}} < 0.3 \text{ W}$
• range	mA -20...+20
• voltage input	
range	V 0...1
accuracy	0.1 % of reading $\pm 1 \text{ mV}$
internal resistance	$R_{\text{int}} = 1 \text{ M}\Omega$

¹ with aperture calibration of the transducers

² for transit time difference principle and reference conditions

³ operating time extension using the power pack PP0026NN (optional, order code: ACC-PO-#601-/B6)

Dimensions

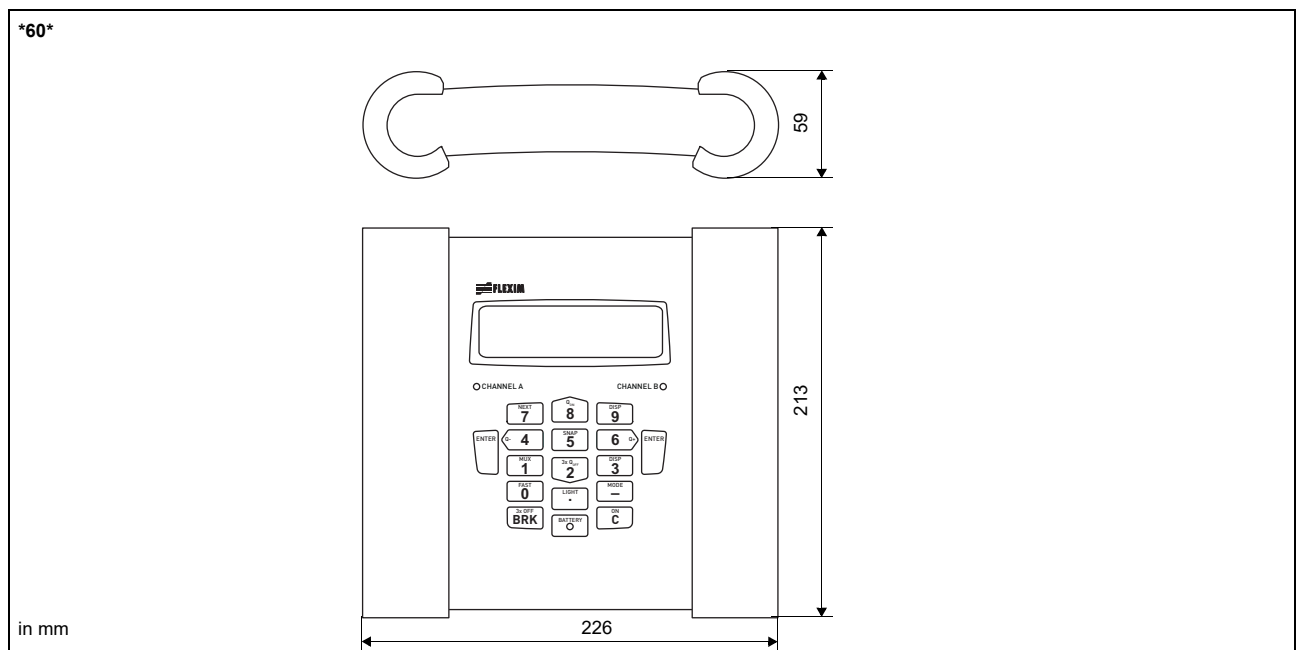

Standard scope of supply

	F601 Basic	F601 Energy
application	flow measurement of liquids	
	2 independent measuring channels, 2 calculation channels	
	wall thickness measurement (wall thickness probe to be ordered separately)	
		integrated thermal energy calculator
		simultaneous monitoring of 2 energy flows
		temperature-compensated calculation of mass flow rate
outputs		
switchable current output	2	2
inputs		
temperature input	-	4
accessories		
transport case	x	x
power supply unit, mains cable	x	x
battery	x	x
adapter	A06	A06, A11
QuickFix pipe mounting fixture for transmitter	x	x
serial data kit	x	x
measuring tape	x	x
user manual, Quick start guide	x	x

Adapters

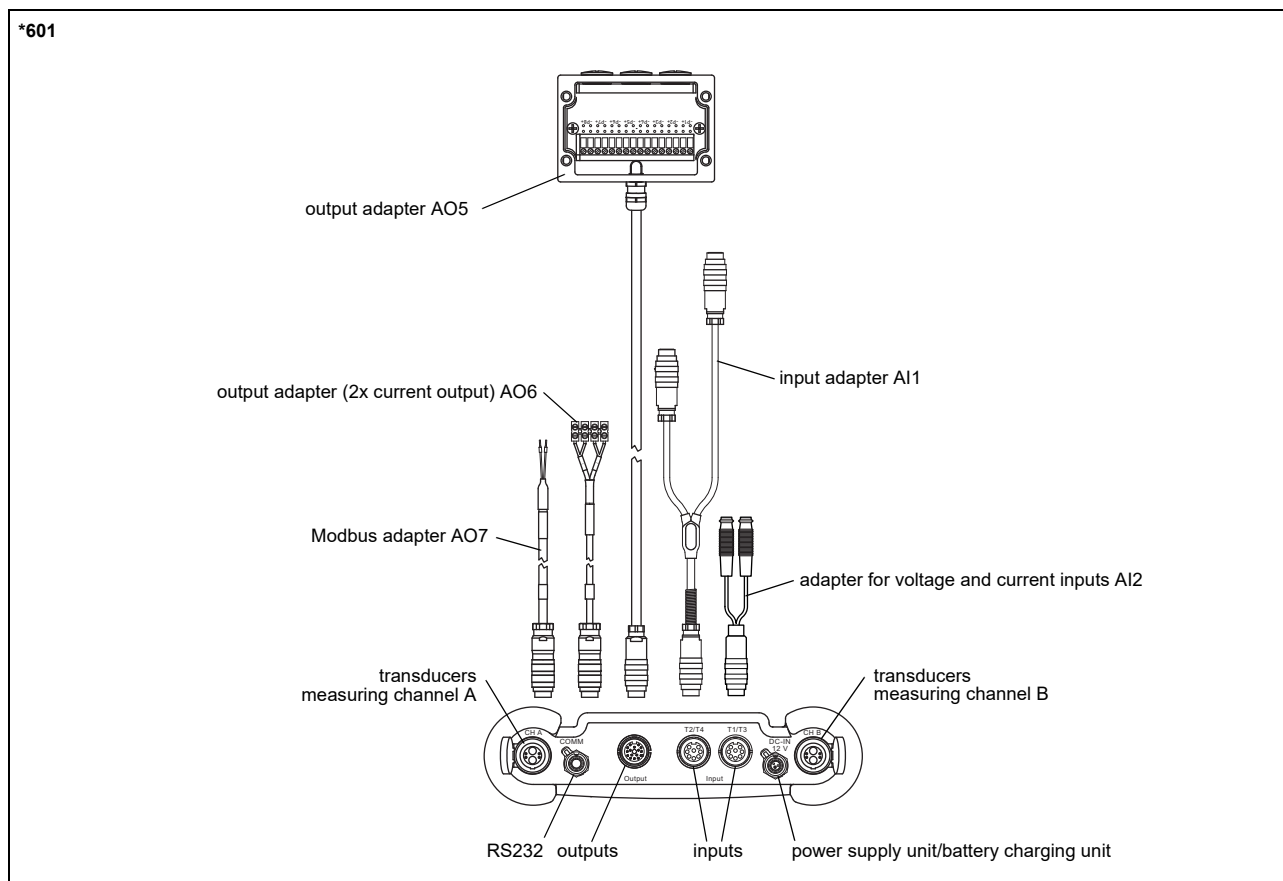

Example for the equipment of a transport case



Transducers

Transducer selection

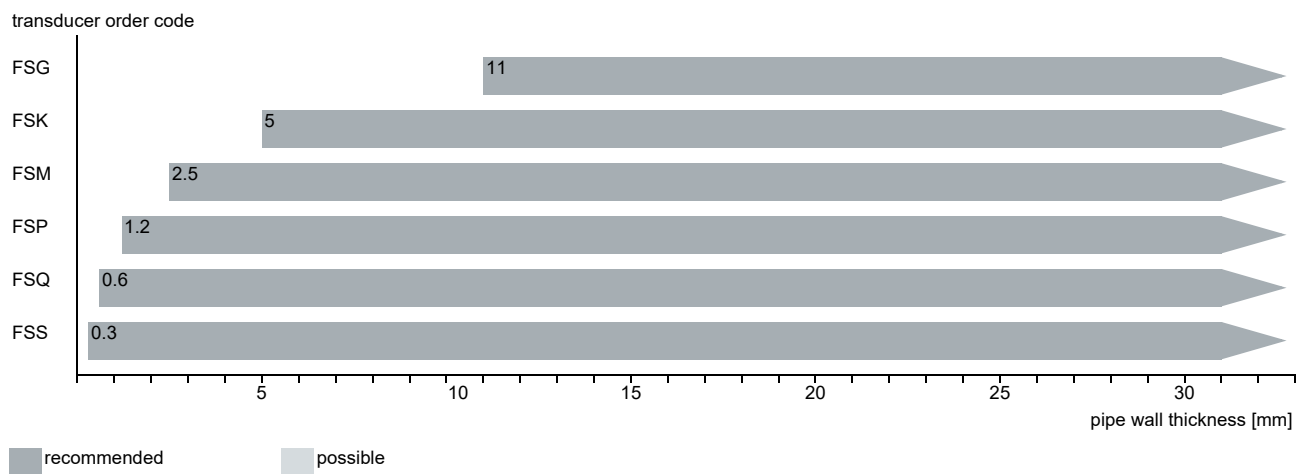
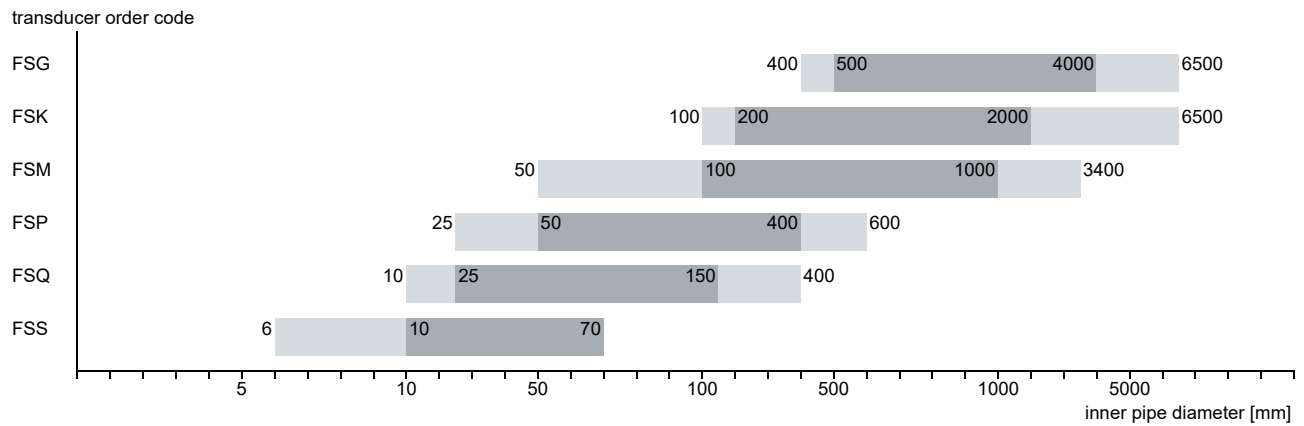

Transducer order code

1, 2	3	4	5, 6	7, 8	9...11	no. of character				
transducer	transducer frequency	-	ambient temperature	explosion protection	connection system	-	extension cable	/	option	description
FS										set of ultrasonic flow transducers for liquids measurement, shear wave
	G									0.2 MHz
	K									0.5 MHz
	M									1 MHz
	P									2 MHz
	Q									4 MHz
	S									8 MHz
			N							normal temperature range
			E							extended temperature range
				NN						not explosion proof
					NL					with Lemo connector
							XXX			0 m: without extension cable > 0 m: with extension cable
									LC	long transducer cable

Technical data

Shear wave transducers (nonEx, NL)

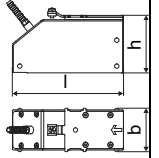
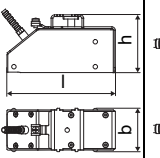
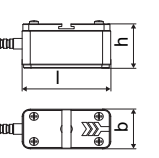
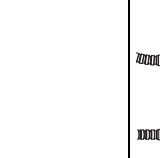
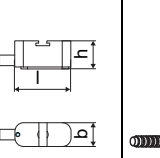
order code		FSG-NNNNL/**	FSK-NNNNL/**	FSM-NNNNL/**	FSP-NNNNL/**	FSQ-NNNNL/**	FSS-NNNNL/**	
technical type		C(DL)G1NZ7	C(DL)K1NZ7	C(DL)M1NZ7	C(DL)P1NZ7	C(DL)Q1NZ7	CDS1NZ7	
transducer frequency	MHz	0.2	0.5	1	2	4	8	
inner pipe diameter d								
min. extended	mm	400	100	50	25	10	6	
min. recommended	mm	500	200	100	50	25	10	
max. recommended	mm	4000	2000	1000	400	150	70	
max. extended	mm	6500	6500	3400	600	400	70	
pipe wall thickness								
min.	mm	11	5	2.5	1.2	0.6	0.3	
material								
housing		PEEK with stainless steel cap 304 (1.4301)		stainless steel 304 (1.4301)		stainless steel 304 (1.4301)		
contact surface		PEEK		PEEK		PEI		
degree of protection		IP67				IP65		
transducer cable								
type		1699						
length	m	5		4		3		
length (**-*****/LC)	m	9						
dimensions								
length l	mm	129.5	126.5	60	42.5	25		
width b	mm	51	51	30	18	13		
height h	mm	67	67.5	33.5	21.5	17		
dimensional drawing								
weight (without cable)	kg	0.47	0.36	0.035	0.011	0.004		
pipe surface temperature								
min.	°C	-40					-30	
max.	°C	+130					+130	
ambient temperature								
min.	°C	-40					-30	
max.	°C	+130					+130	
temperature compensation		x						

Shear wave transducers (nonEx, NL, extended temperature range)

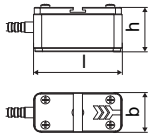
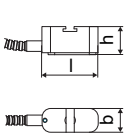
order code		FSM-ENNNL/**	FSP-ENNNL/**	FSQ-ENNNL/**
technical type		C(DL)M1EZ7	C(DL)P1EZ7	C(DL)Q1EZ7
transducer frequency	MHz	1	2	4
inner pipe diameter d				
min. extended	mm	50	25	10
min. recommended	mm	100	50	25
max. recommended	mm	1000	400	150
max. extended	mm	3400	600	400
pipe wall thickness				
min.	mm	2.5	1.2	0.6
material				
housing		stainless steel 304 (1.4301)		
contact surface		Sintimid		
degree of protection		IP65		
transducer cable				
type		1699		
length	m	4		3
length (***_***/LC)	m	9		
dimensions				
length l	mm	60		42.5
width b	mm	30		18
height h	mm	33.5		21.5
dimensional drawing				
weight (without cable)	kg	0.042		0.011
pipe surface temperature				
min.	°C	-30		
max.	°C	+200		
ambient temperature				
min.	°C	-30		
max.	°C	+200		
temperature compensation		x		

Transducer mounting fixture

Order code

1, 2	3	4	5	6	7...9	no. of character
transducer mounting fixture	transducer	measurement arrangement	size	fixation	outer pipe diameter	description
FS						fastening shoes
VP						portable Variofix
TB						tension belts
WL						transducer box for WaveInjector
	A					all transducers
	K					transducers with transducer frequency G, K
	M					transducers with transducer frequency M, P
	Q					transducers with transducer frequency Q
	S					transducers with transducer frequency S
		D				reflection arrangement or diagonal arrangement
		R				reflection arrangement
			S			small
			M			medium
				C		chains
				N		without fixation
					010	10...100 mm
					025	10...250 mm
					055	10...550 mm
					150	50...1500 mm
					210	50...2100 mm

fastening shoes FS and chains

transducer frequency: M, P, Q

material: stainless steel 304 (1.4301), 301 (1.4310), 303 (1.4305)

dimensions:
 M, P: 420 x 48 x 68 mm
 Q: 420 x 43 x 58 mm

chain length: 0.5/1/2 m

outer pipe diameter:
 max. 150/310/600 mm

transducer frequency: S

material: stainless steel 304 (1.4301), 301 (1.4310), 303 (1.4305)

dimensions:
 210 x 32 x 44 mm

chain length: 0.5 m

outer pipe diameter:
 max. 150 mm

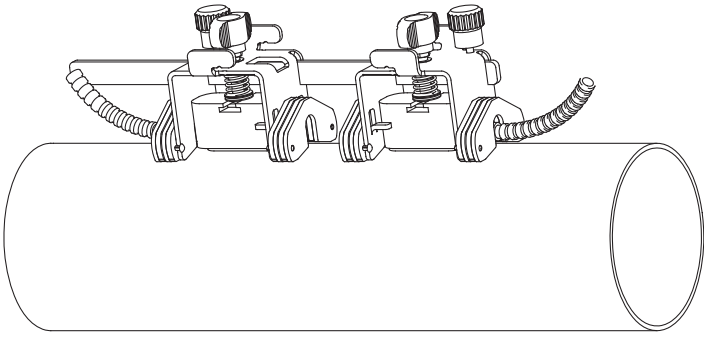
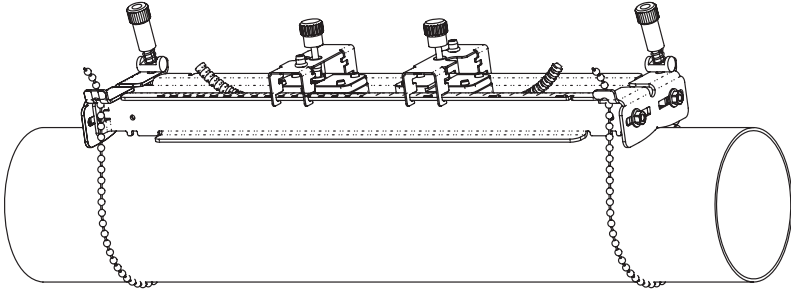
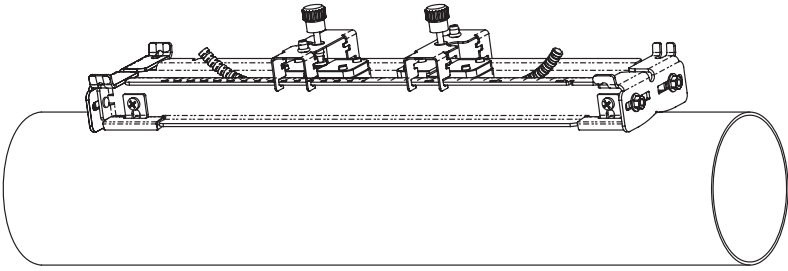
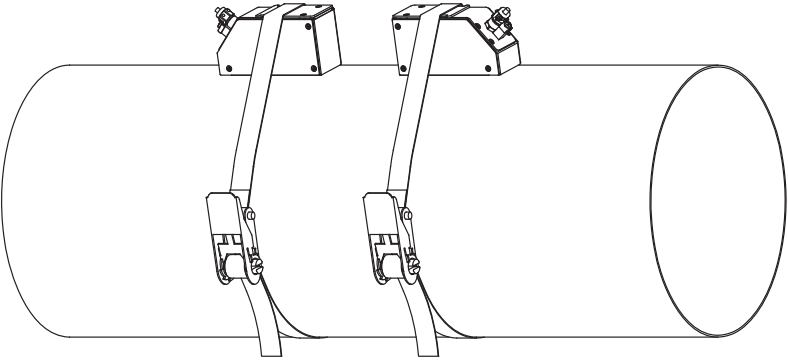
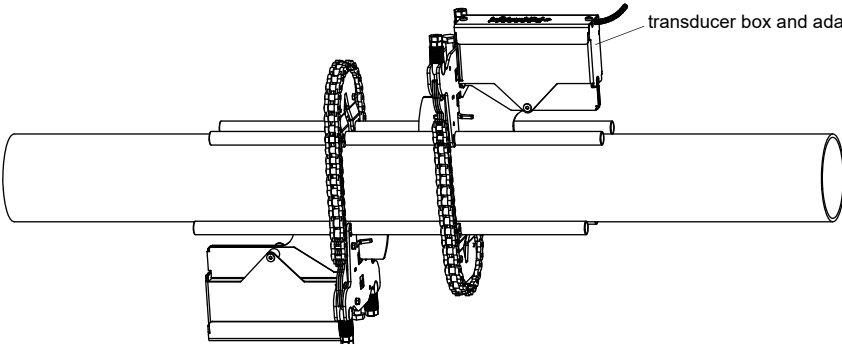
<p>fastening shoes FS and magnet (optional)</p> 	<p>material: stainless steel 304 (1.4301), 301 (1.4310), 303 (1.4305) dimensions: M, P: 420 x 48 x 68 mm Q: 420 x 43 x 58 mm</p>
<p>portable Variofix VP and chains</p> 	<p>material: stainless steel 304 (1.4301), 301 (1.4310), 303 (1.4305) dimensions: 414 x 94 x 76 mm chain length: 2 m</p>
<p>portable Variofix VP and magnet (optional)</p> 	<p>material: stainless steel 304 (1.4301), 301 (1.4310), 303 (1.4305) dimensions: 414 x 94 x 40 mm</p>
<p>tension belts TB</p> 	<p>transducer frequency: G, K material: steel, powder coated and textile tension belt length: 5/7 m ambient temperature: max. 60 °C outer pipe diameter: max. 1500/2100 mm</p>
<p>transducer box WL for WaveInjector</p>  <p style="text-align: right;">transducer box and adapter</p>	<p>see Technical specification TSWaveInjectorVx-x</p>

Coupling materials for transducers

normal temperature range (4th character of transducer order code = N)		extended temperature range (4th character of transducer order code = E)		WaveInjector	
< 100 °C	< 170 °C	< 150 °C	< 200 °C	< 280 °C	280...630 °C
coupling compound type N	coupling compound type E	coupling compound type E	coupling compound type E or H	coupling foil type A and coupling foil type VT	coupling foil type B and coupling foil type VT

Technical data

type	ambient temperature °C
coupling compound type N	-30...+130
coupling compound type E	-30...+200
coupling compound type H	-30...+250
coupling foil type A	max. 280
coupling foil type B	280...630
coupling foil type VT	-10...+200

coupling foil not to be used for transducer mounting fixture with magnets

Connection systems

connection system NL	
direct connection/connection with extension cable	transducers technical type
*****Z7	

Cable

transducer cable		
type		1699
weight	kg/m	0.094
ambient temperature	°C	-55...+200
cable jacket		
material		PTFE
outer diameter	mm	2.9
thickness	mm	0.3
colour		brown
shield		x
sheath		
material		stainless steel 304 (1.4301)
outer diameter	mm	8

extension cable			
type		1750	2551
standard length	m	5 10	-
max. length	m	10	see table below
weight	kg/m	0.12	0.083
ambient temperature	°C	< 80	-25...+80
cable jacket			
material		PE	TPE-O
outer diameter	mm	6	8
thickness	mm	0.5	
colour		black	black
shield		x	x
sheath			
material		stainless steel 304 (1.4301)	-
outer diameter	mm	9	-
remark		optional	

Cable length

transducer frequency	F, G, H, K				M, P			Q			S		
connection system NL													
transducers technical type	x	y	l	x	y	l	x	y	l	x	y	l	
*D***Z7 ¹	m	2	3	≤ 25	2	2	≤ 25	2	1	≤ 25	1	1	≤ 20
option LC: *L***Z7 ¹	m	2	7	≤ 25	7	2	≤ 25	8	1	≤ 25	-	-	-

¹ l > 25...100 m on request

x, y - transducer cable length
l - max. length of extension cable

Clamp-on temperature probe (optional)

Technical data

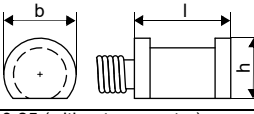
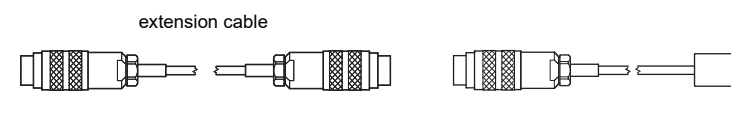
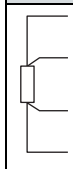
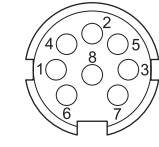
PT12N			
order code	<ul style="list-style-type: none"> ACC-PO-#601-/T311 ACC-PO-#601-/T511 (matched) 		
design	clamp-on with connector		
type	Pt100		
connection	4-wire		
measuring range	°C -30...+250		
accuracy T	$\pm(0.15 \text{ °C} + 2 \cdot 10^{-3} \cdot T \text{ [°C] })$ class A		
accuracy ΔT (2x Pt matched according to EN 1434-1)	$\leq 0.1 \text{ K}$ ($3 \text{ K} < \Delta T < 6 \text{ K}$), more corresponding to EN 1434-1		
response time	s 50 (t_{50} , $T_1 = 25 \text{ °C}$, $T_2 = 60 \text{ °C}$)		
housing material	aluminum		
degree of protection	IP54		
dimensions			
length l	mm 20		
width b	mm 15		
height h	mm 13		
dimensional drawing			
weight	kg 0.25 (without connector)		
accessories			
thermal conductivity paste 200 °C	x		
thermal conductivity foil 250 °C	x		
Connection system			
direct connection/connection with extension cable			
			
Connection			
	temperature probe	extension cable	connector
			pin
	red	grey	2
	red/blue	red	6
	white/blue	blue	1
	white	white	7
			
Cable			
	temperature probe	extension cable	
type	4 x 0.22 mm ²	LIYCY 8 x 0.14 mm ²	
standard length	m 3	5/10/25	
max. length	m -	200	
ambient temperature	°C -30...+250	-25...+80	
min. bend radius	mm 27	68	
cable jacket			
material	PFA	PVC	
outer diameter	mm 3.8 ±0.15	4.8 ±2	
colour	black	grey	

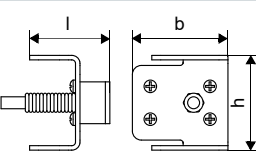
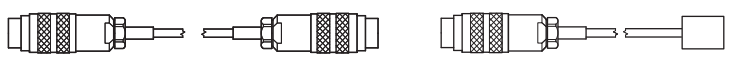
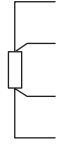
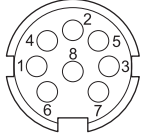
PT12F			
order code		<ul style="list-style-type: none"> ACC-PO-#601-/T111 ACC-PO-#601-/T211 (matched) 	
design		clamp-on short response time, with connector	
type		Pt100	
connection		4-wire	
measuring range	°C	-50...+250	
accuracy T		$\pm(0.15 \text{ °C} + 2 \cdot 10^{-3} \cdot T \text{ [°C] })$ class A	
accuracy ΔT (2x Pt matched according to EN 1434-1)		$\leq 0.1 \text{ K}$ ($3 \text{ K} < \Delta T < 6 \text{ K}$), more corresponding to EN 1434-1	
response time	s	8 (t50, T1 = 25 °C, T2 = 60 °C)	
housing material		PEEK, stainless steel 304 (1.4301), copper	
degree of protection		IP54	
dimensions			
length l	mm	14	
width b	mm	30	
height h	mm	27	
dimensional drawing			
weight	kg	0.32 (without connector)	
accessories			
thermal conductivity paste 200 °C		x	
thermal conductivity foil 250 °C		x	
plastic protection plate, insulation foam		x	
Connection system			
direct connection/connection with extension cable			
			
Connection			
	temperature probe	extension cable	connector
			pin
	red	grey	2
	red/blue	red	6
	white/blue	blue	1
	white	white	7
			
Cable			
		temperature probe	extension cable
type		4 x 0.22 mm ²	LIYCY 8 x 0.14 mm ²
standard length	m	3	5/10/25
max. length	m	-	200
ambient temperature	°C	-50...+250	-25...+80
min. bend radius	mm	27	68
cable jacket			
material		PFA	PVC
outer diameter	mm	3.8 ±0.15	4.8 ±2
colour		black	grey

Fixation

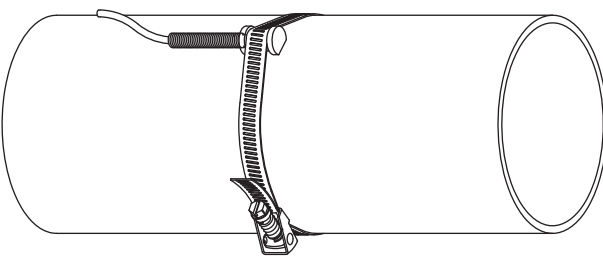
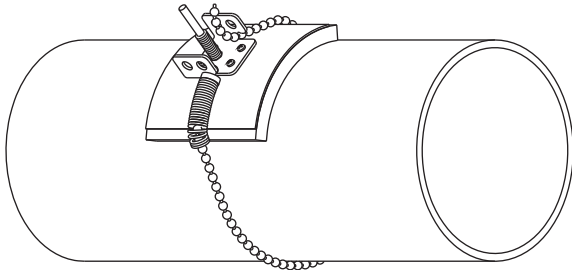
<p>tension strap PT12N</p> 	<p>material: stainless steel 301 (1.4310), 410 (1.4006) thermal insulation necessary</p>
<p>ball chain PT12F</p> 	<p>material: stainless steel 316L (1.4404) length: 1 m</p>

Wall thickness measurement (optional)

The pipe wall thickness is an important pipe parameter which has to be determined exactly for a good measurement. However, the pipe wall thickness often is unknown.

The wall thickness probe can be connected to the transmitter instead of the flow transducers and the wall thickness measurement mode is activated automatically.

Acoustic coupling compound is applied to the wall thickness probe which then is placed firmly on the pipe. The wall thickness is displayed and can be stored directly in the transmitter.

Technical data

		DWR1NZ7
order code		ACC-PO-G601-/W6
measuring range ¹	mm	1...250
resolution	mm	0.01
accuracy		1 % ±0.1 mm
fluid temperature	°C	-20...+200, short-time peak max. 500
cable		
type		2616
length	m	1.5

¹ The measuring range depends on the attenuation of the ultrasonic signal in the pipe. For strongly attenuating plastics (e.g. PFA, PTFE, PP) the measuring range is smaller.

Cable

		2616
ambient temperature	°C	<200
cable jacket		
material		FEP
outer diameter	mm	5.1
colour		black
shield		x

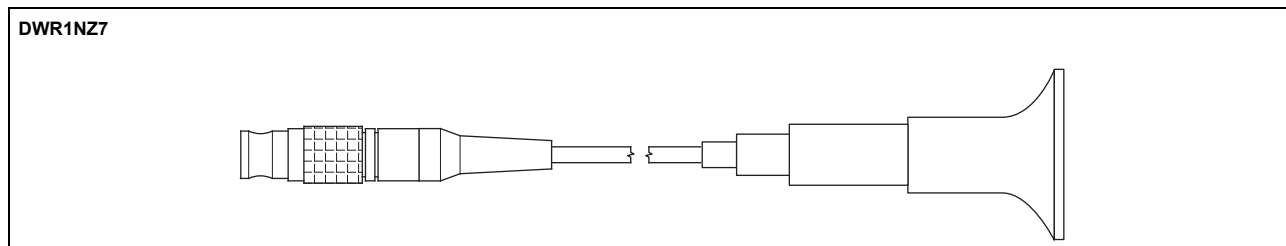

FLEXIM GmbH
Boxberger Str. 4
12681 Berlin
Germany
Tel.: +49 (30) 93 66 76 60
Fax: +49 (30) 93 66 76 80
internet: www.flexim.com
e-mail: info@flexim.com

Subject to change without notification.
Errors excepted.
FLUXUS is a registered trademark of FLEXIM GmbH.
Copyright (©) FLEXIM GmbH 2022