



Model 312AMX

1, 2, or 3Ø – Linear AC Power Source

1,200VA
20-5,000 Hz

- 1Ø → 0-150V_{L-N}
- 2Ø → 0-300V_{L-L}
- 3Ø → 0-150V_{L-N} / 0-260V_{L-L}



Standard Features:

- Advanced Linear Amplifiers Provide Very Low Voltage Distortion, no Switching Noise, Fast Voltage and Current Slew Rates, Exceptionally Low Output Impedance and High Peak Current Capability
- 1, 2, or 3 Phase Output Form selectable from front panel or bus command
- 20 to 5,000 Hz. Full Power Bandwidth Operation – 5Hz to 50KHz small signal bandwidth, 3dB at 10% of full voltage
- Precision Voltage Programming – 0.05% with Continuous Self-Calibration (CSC) engaged
- True-RMS Metering of Volts, Amps, and Power
- GPIB (IEEE-488.2) or RS-232 Interface
- Waveform Library – Arbitrary Waveform Generator
- Up to 99 Programs with Associated Transients for Static and Dynamic Test Applications
- UPC Studio Software Suite

Available Options:

- Programmable Output Impedance
- Harmonic Analysis and Waveform Synthesis
- Peak Inrush Capture and Waveform Analysis (Available on models with UPC3 controller)
- UPC Test Manager Software

UPC Manager Software Suite *Master the Power of the Wave!*

UPC Manager Software gives you the tools necessary to quickly and easily operate your AC Power Source. With our graphical interface control all areas of your AC Power Source testing with simple presets, user prompts, test sequences, test plans and custom reports.

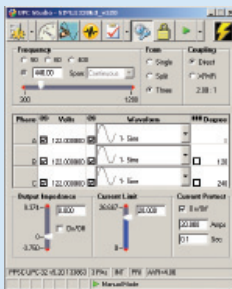

Model 312AMX

As a member of Pacific Power's AMX-Series popular family of high performance Linear AC Power Sources, the 312AMX offers the same low output voltage noise and distortion, ease of installation, and high AC waveform fidelity as found in all of Pacific Power's Linear AC Power Sources. Control and operational features provide a high degree of versatility and ease of use for applications ranging from simple, manually controlled frequency conversion to harmonic testing and sophisticated programmable transient simulation.

AC TEST POWER

All 312AMX models are equipped with a powerful micro-controller with the ability to operate as a fully integrated test system. This enables a variety of power conditions and transients to be applied to the device under test while metering and analyzing all output performance parameters. For higher power requirements, refer to the AMX & ASX series catalog.

FREQUENCY/VOLTAGE CONVERSION

The 312AMX is an excellent source of stable AC Voltage over the frequency range of 20 to 5,000 Hz when using the high-end UPC-32 controller. Also available in 1,200 Hz maximum output frequency when using UPC3 or Manual controller. The output frequency is quartz-crystal stabilized. Output voltages up to 300V_{L-L} in split phase mode and 260V_{L-L} in three phase mode are available on the 312AMX model.

PHASE CONVERSION

With the ability to provide either single or two phase output, the 312AMX is a good choice to convert one-phase line voltage into precisely controlled split (two-phase) or three-phase output power.

UPC SERIES CONTROLLER

Three controller models are available in both manual and programmable control version. All controllers provide manual operation from the front panel. Programmable Controllers may be operated from the front panel or from a remote interface via RS 232 or GPIB.

The Leader in AC Power Technology

An early pioneer in the development solid-state power conversion equipment, Pacific Power Source continues to develop, manufacture, and market both linear and high-performance PWM AC Power Sources. Pacific Power Source's reputation as a market and technology leader is best demonstrated by its continuing investments in both research and development and world-wide customer support. With corporate owned offices in the United States, France, the United Kingdom, and China, local personalized support is always available.



THE POWER OF EXPERTISE



FREQUENCY CONVERSION



AEROSPACE

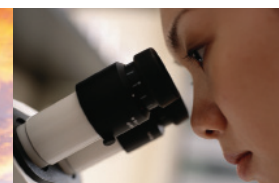

R & D



MILITARY



MANUFACTURING



CUSTOM

Output Ratings

312AMX

Rated Power (VA) ¹	Coupling Mode	Form ²	Output Voltage ³ V _{RMS} Max (L-N/L-L)	Current ⁴ (A _{RMS})	Frequency Range	Input Power	Unit Height In/mm/U	Unit Weight (Lbs/Kg)
1,200	Direct	1Ø/2Ø 3Ø	150/300 150/260	10/3.3 3.3/Ø	20-5000	1Ø 47-63Hz	5.25/133/3U	70/32

NOTES:

- Rated output power is based on a combination of nominal output voltage, rated current and load power factor. Values stated represent the maximum capabilities of a given model (maximum power in split phase (Form2) direct coupled mode is 800VA). Consult factory for assistance in determining specific unit capabilities as they might apply to your application.
- Unit is operable as single phase with dual range capability or 3 phase. Output voltage range and 1/2/3 conversions are selected by front panel or bus commands.
- Vmax is output voltage with nominal input and full rated load applied.
- Available current will vary with output voltage and power factor. Current shown is per phase.

AMX Power Source Specifications (PF = 1.0, V_{out} > 25% F.S.)

Output Frequency	Line Regulation	Load Regulation	Output Distortion	Ripple and Noise	Response Time
Full Power 20-5,000 Hz Direct Coupled	0.1% max for a ±10% line change	Direct Coupled Ranges: 0.25% 20 to 2,000 Hz. 0.50% 2,000 to 5,000 Hz. Improves to less than 0.03% with external sense and CSC enabled.	0.1% THD _{AVG} 45 to 1,000 Hz 0.25% THD _{AVG} 20 to 5,000 Hz	-72dB	5 µsec typ. For step load change. Small signal bandwidth = 5 Hz to 40 KHz

Input Power Requirements (47-63 Hz)

Input Voltage	100VAC ±10%	110VAC ±10%	120VAC ±10%	200VAC ±10%	230VAC ±10%	240VAC ±10%
Input Current	20A _{RMS}	19A _{RMS}	18A _{RMS}	10A _{RMS}	9A _{RMS}	9A _{RMS}
Recommended Input service	25A	25A	25A	15A	15A	15A

Thermal and Power Factor Rating Curves

Rated Continuous Load Current as a Function of Ambient Temperature and Power Factor and Output Voltage at Nominal Input Line.

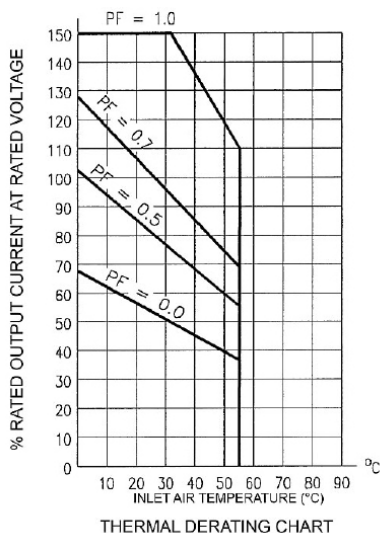

THERMAL RATING -AC CURRENT RMS

Short term overloads to 150% of rated current are permitted. Operating time before thermal shutdown or circuit breaker trip varies from seconds to several minutes depending upon line and temperature conditions.

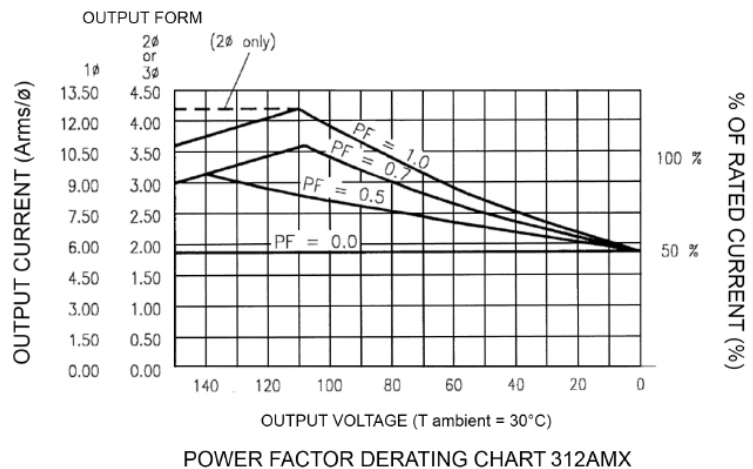

OUTPUT VOLTAGE-AC VOLTS RMS

Short term overloads to 150% are permitted. Operating time before thermal shutdown or circuit breaker trip varies from seconds to several minutes depending upon line and temperature conditions.

Total Control, Metering, and Analysis of AC Power- Simple, Intuitive Operation

The UPC Controller is a highly versatile one, two, or three phase oscillator/signal generator designed to control any of Pacific Power's AC Power Sources. Three controller models, UPC-3M, UPC-3, or UPC-32 are offered. To use the full 5KHz power bandwidth of the 312AMX, the UPC-32 controller is required.

Using the front panel keyboard and display, all controller models provide for selection of power source output mode, coupling, voltage, and frequency. Selecting the correct UPC controller for a given application varies with your test requirement, desired features, and price.

Both the UPC-3 and UPC-32 Controllers are available with either RS-232 or GPIB remote interface. Commands are structured in accordance with SCPI (Standard Commands for Programmable Instruments).

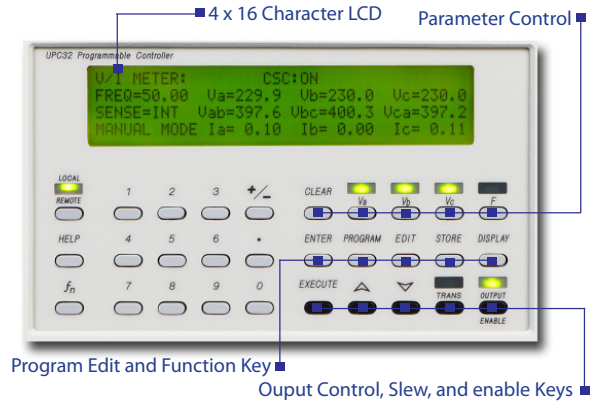

Controller Models

Features	UPC-3M	UPC-3	UPC-32
Output Modes	1Ø, 2Ø, & 3Ø	1Ø, 2Ø, & 3Ø	1Ø, 2Ø, & 3Ø
Waveform Library	Sine	Sine + 21 Editable	Sine + 15 Editable
Transient Functions	NO	YES, 50 Steps	YES, 99 Steps
Program Library	NO	99 Programs	99 Programs
Programmable Current Limit	YES	YES	YES
Programmable Current Protect	YES	YES	YES
Programmable Phase Angle	NO	YES, 0 to 359°	YES, 0 to 359°
CSC (Continuous Self-Calibration)	YES	YES	YES
Remote Interface	Std	NONE	GPIB
	Opt	NONE	RS-232
Waveform Synthesis/Analysis	NO	OPTIONAL	OPTIONAL
Prog. Output Impedance	NO	OPTIONAL	OPTIONAL
Inrush Peak Detect	NO	OPTIONAL	NO
DRM Link-Synchronization	NO	NO	OPTIONAL
Line Synchronization	NO	NO	OPTIONAL

External Inputs/Outputs

Analog Auxiliary Input	Each phase is algebraically summed with UPC waveform and amplified 25X to the direct coupled output. ±10Vpk (20Vpk-pk). One input per phase. $Z_{in} = 600 \Omega$
AM-Amplitude Modulation	±10 Vdc (20Vpk-pk) modulates the output voltage ±100% One input per phase. $Z_{in} = 600 \Omega$
Sync Outputs Zero Crossing	Positive Zero Crossing (0°) of Phase A analog output
Transient Trigger	Pulse at the start of a transient event. (UPC-32 only)
Transient Pedestal	TTL True when a transient is in progress
Output Clock	UPC-3, TTL level pulse rate varies with output frequency UPC-32, TTL level 1024 x output frequency

Waveform Control

Waveform Synthesis (/HAS Option)	Creates waveform by entering magnitude as % of fundamental and specified phase angle for 2nd through the 51st harmonic
Waveform Analysis (/HAS Option)	Reports waveform harmonic content and phase angle relative to the fundamental for the 2nd through the 51st harmonic as Total, Odd, and Even harmonic distortion

Output Control Specifications

	UPC-3M/UPC-3	UPC-32
Frequency	Range	20-1,200Hz
	Resolution	4 Significant Digits
	Accuracy	±0.01% of full scale
Voltage	Range (I-n)	0 - 150/375
	Resolution	0.1V/ 0.5V
	Accuracy	0.5% of full scale (CSC Disabled) ±0.05% referenced to Internal Meter (CSC Enabled)
Phase Angle ØB and ØC relative to ØA	Range	0 - 359°
	Resolution	± 1°
	Accuracy	15.00 - 150Hz, ± 0.5° 15.00 - 300 Hz, ± 1° 15.00 - 600 Hz, ± 2° 15.00 - 1,200Hz, ± 3°
Current Limit	Range	1Ø = 0 - 60A _{RMS} 3Ø = 0 - 20A _{RMS}
	Resolution	0.05% F.S.
	Accuracy	±3% F.S. ±1% F.S.

(1) Full power output limited to 1=5,000 Hz in AMX models

Output Metering

	UPC-3M/UPC-3	UPC-32
Voltmeter True V _{RMS} each phase	Range	0-354 V _{L-N} , 708V _{L-L}
	Resolution	0.1V front panel
	Accuracy	±0.2% FS plus Cal ref. 50-500Hz, ± 0.25% of rdg. ± 0.1% F.S. 20-5,000 Hz, ± 0.5% F.S.
Ammeter True A _{RMS} and Apk each phase	Range	1Ø = 60A _{RMS} , 3Ø = 20A _{RMS}
	Resolution	0.01A front panel
	Accuracy	±0.2% FS plus Cal ref. ±0.25% of rdg. 50-500Hz, ± 0.1% F.S. 20-5,000 Hz, ± 0.5% F.S.
Power Meter True Watts and Volt-Amps each phase	Range	1Ø = 21,240/Ø (W or VA), 3Ø = 7,080/Ø (W or VA)
	Resolution	1.0 Watt or VA front panel
	Accuracy	± 1% full range
Power Factor Ratio : kW _{mtr} /kVA _{mtr}	Resolution	Calculated and displayed to three digits following the decimal point.
	Accuracy	± 1% full range
Crest Factor Ratio: Apk/A _{RMS}	Resolution	Calculated and displayed to three digits following the decimal point.
	Accuracy	± 1% full range
Freq. Display	Range	15.00 - 1,200 Hz 20.00-5,000Hz
	Resolution	10.00-99.99 Hz, 0.01 Hz 100.0-999.9 Hz, 0.1 Hz 1,000-5,000 Hz, 1 Hz
	Accuracy	± 0.01% full range

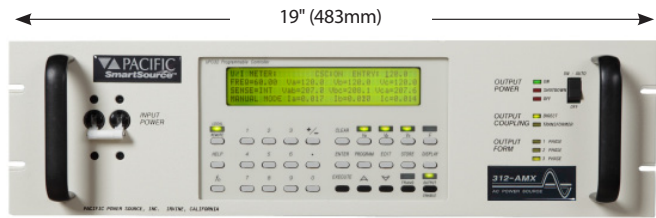
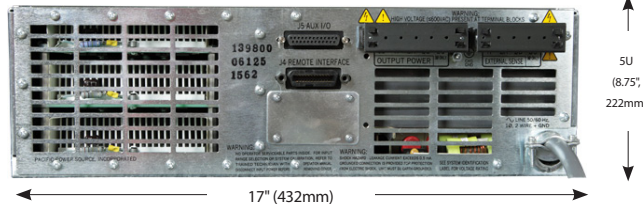

General/Environmental

Temperature	Operating: 0° to 55° C Storage: -10° to 70° C
Humidity	0 - 95%, Non-condensing
Cooling	Front and side forced air intake (200 CFM) with rear exhaust.
Altitude	Operating: 6,500 Ft (1,981m) Storage: 40,000 Ft (12,192 m)
Heat Dissipation	1.3kBTU/ hr (Full kW Load)
Audible Noise	65 dba Max @ 1 Meter
Agency Approvals	Safety UL 61010 -1 EN 61010 -1 EMC EN 61326 -1

Protection and Safety

Hardware	Over-current, short circuit, over-temperature
Programmable Current Limit	A single RMS programmed, average responding, value is provided for all phases. Limits current by reducing output voltage.
Programmable Current Protect	Allows the power source to operate in "constant voltage" mode, interrupting output when specified current protect limit is exceeded.

Mechanical Specifications

Height	312AMX: 3U (5.25", 133mm)
Depth	312AMX: 23" (584mm)
Weight	312AMX: 70 lbs (32kg)
Mounting	Standard 19" rack (483mm). Cabinet options available.

Hardware Options

/S	RS232 Interface. 38.4kbps, (Standard on UPC-3)
/G	GPIB Interface, IEEE-488.2. (Standard on UPC-32)
/M7073	Safety Interlock Normally Open Contacts
/M99413	Safety Interlock Normally Closed Contacts
/MXXXXX	Other factory specified modification

Software/Firmware Options

/Prog-Z	Programmable Output Impedance
/HAS	Harmonic Analysis and Synthesis
/IR	In-Rush Meter. Capture and view peak in-rush current values via front panel or remote interface (UPC-3 only).
Test MGR	UPC Test Manager License: Create, edit, and execute Test sequences and reports. Ordered as separate line item
Test SEQ	Avionics test sequences; DO-160, ABD-0100, ABD-0100 (A350), Ordered as separate line item, Requires 'Test' Manager License.

Ordering Information

Model	Controller	Options	Input Voltage (V_{IN})
<input type="checkbox"/> 312AMX	<input type="checkbox"/> UPC-3M <input type="checkbox"/> UPC-3 <input type="checkbox"/> UPC-32	See List Above	<input type="checkbox"/> 100VAC ± 10% <input type="checkbox"/> 110VAC ± 10% <input type="checkbox"/> 120VAC ± 10% <input type="checkbox"/> 200VAC ± 10% <input type="checkbox"/> 230VAC ± 10% <input type="checkbox"/> 240VAC ± 10%

Available Models

With Manual Controller

312AMX-UPC3M

With Programmable Controller

312AMX-UPC3

312AMX-UPC32

Order Example

312AMX-UPC32, V_{IN} : 120VAC

- 1,200VA, 3-Phase, AC Power Source with UPC-32 programmable controller.
- Standard GPIB Interface
- 120VAC, 1 Phase Input Voltage

Typical Delivery Items

- AC Power Source
- English Manuals (AC Source and Controller)
- UPC Studio Software - (Download)
- UPC Interactive LabVIEW™ Libraries (Download)
- Compliance Certificate with Test data
- CE Conformity Document (CE Models)



17692 Fitch, Irvine, CA 92614 USA
Phone: +1 949.251.1800
Fax: +1 949.756.0756
Toll Free: 800.854.2433
E-mail: sales@pacificpower.com
www.pacificpower.com