



Advanced Test Equipment Rentals
www.atecorp.com 800-404-ATEC (2832)

Agilent E4991A RF Impedance/Material Analyzer

Installation and Quick Start Guide

Tenth Edition



Manufacturing No. E4991-90201

June 2012

Notices

The information contained in this document is subject to change without notice.

This document contains proprietary information that is protected by copyright. All rights are reserved. No part of this document may be photocopied, reproduced, or translated to another language without the prior written consent of Agilent Technologies.

Microsoft®, MS-DOS®, Windows®, Visual C++®, Visual Basic®, VBA® and Excel® are registered

UNIX is a registered trademark in U.S. and other countries, licensed exclusively through X/Open Company Limited.

Portions ©Copyright 2012, Microsoft Corporation. All rights reserved.

© Copyright 2001, 2002, 2003, 2004, 2006, 2012 Agilent Technologies

Manual Printing History

The manual's printing date and part number indicate its current edition. The printing date changes when a new edition is printed (minor corrections and updates that are incorporated at reprint do not cause the date to change). The manual part number changes when extensive technical changes are incorporated.

March 2001	Preliminary (part number: E4991-90001)
April 2001	First Edition (part number: E4991-90011)
July 2001	Second Edition (part number: E4991-90021)
September 2001	Third Edition (part number: E4991-90031)
February 2002	Fourth Edition (part number: E4991-90041)
March 2003	Fifth Edition (part number: E4991-90051)
May 2003	Sixth Edition (part number: E4991-90061)
August 2003	Seventh Edition (part number: E4991-90071)
December 2004	Eighth Edition (part number: E4991-90081)
July 2006	Ninth Edition (part number: E4991-90091)
June 2012	Tenth Edition (part number: E4991-90201)

Safety Summary

The following general safety precautions must be observed during all phases of operation, service, and repair of this instrument. Failure to comply with these precautions or with specific WARNINGS elsewhere in this manual may impair the protection provided by the equipment. Such noncompliance would also violate safety standards of design, manufacture, and intended use of the instrument. Agilent Technologies assumes no liability for the customer's failure to comply with these precautions.

NOTE

The E4991A complies with INSTALLATION CATEGORY II as well as POLLUTION DEGREE 2 in IEC61010-1. The E4991A is an INDOOR USE product.

NOTE

The LEDs in the E4991A are Class 1 in accordance with IEC60825-1, CLASS 1 LED PRODUCT.









- Ground the Instrument
To avoid electric shock, the instrument chassis and cabinet must be grounded with the supplied power cable's grounding prong.
- DO NOT Operate in an Explosive Atmosphere
Do not operate the instrument in the presence of inflammable gasses or fumes. Operation of any electrical instrument in such an environment clearly constitutes a safety hazard.
- Keep Away from Live Circuits
Operators must not remove instrument covers. Component replacement and internal adjustments must be made by qualified maintenance personnel. Do not replace components with the power cable connected. Under certain conditions, dangerous voltage levels may remain in the instrument even after the power cable is disconnected. To avoid injuries, always disconnect the power and fully discharge circuits before touching them.
- DO NOT Service or Adjust the Instrument Alone
Do not attempt internal service or adjustment unless another person, capable of rendering first aid and resuscitation, is present.
- DO NOT Substitute Parts or Modify the Instrument
To avoid the danger of introducing additional hazards, do not install substitute parts or perform unauthorized modifications to the instrument. Return the instrument to an Agilent Technologies Sales and Service Office for service and repair to ensure that safety features are maintained in operational condition.
- Dangerous Procedure Warnings
Warnings, such as the example below, precede potentially dangerous procedures throughout this manual. Instructions contained in the warnings must be followed.

WARNING

Dangerous voltage levels, capable of causing death, are present in this instrument. Use extreme caution when handling, testing, and adjusting this instrument.

Safety Symbols

General definitions of safety symbols used on the instrument or in manuals are listed below.

-  Instruction Manual symbol: parts of the product are marked with this symbol when it is necessary for the user to refer to the instrument manual.
-  Alternating current.
-  Direct current.
-  On (Supply).
-  Off (Supply).
-  In-position of push-button switch.
-  Out-position of push-button switch.
-  A chassis terminal; a connection to the instrument's chassis, which includes all exposed metal structure.
-  Stand-by.

WARNING	This warning sign denotes a hazard. It calls attention to a procedure, practice, or condition that, if not correctly performed or adhered to, could result in injury or death to personnel.
----------------	--

CAUTION	This Caution sign denotes a hazard. It calls attention to a procedure, practice, or condition that, if not correctly performed or adhered to, could result in damage to or destruction of part or all of the instrument.
----------------	--

NOTE	This Note sign denotes important information. It calls attention to a procedure, practice, or condition that is essential for the user to understand.
-------------	---

Documentation Warranty

The material contained in this document is provided "as is," and is subject to being changed, without notice, in future editions. Further, to the maximum extent permitted by applicable law, Agilent disclaims all warranties, either express or implied with regard to this manual and any information contained herein, including but not limited to the implied warranties of merchantability and fitness for a particular purpose. Agilent shall not be liable for errors or for incidental or consequential damages in connection with the furnishing, use, or performance of this document or any information contained herein. Should Agilent and the user have a separate written agreement with warranty terms covering the material in this document that conflict with these terms, the warranty terms in the separate agreement will control.

Typeface Conventions

sample (bold)	Boldface type is used for emphasis.
<i>sample (Italic)</i>	Italic type is used for emphasized phrases and titles of manuals in English.
[sample]	Indicates the key on the front panel labeled “ sample ”. It also may refer to the label on the button.
sample	Indicates a menu, button, or box labeled “ sample ” that can be clicked to carry out a setting or chosen option. Menu includes menu bars, pull-down menus, and shortcut menus. Button includes buttons in dialog boxes and setup toolbars. Box includes spin boxes, drop-down list boxes, text boxes, and list boxes.
SAMPLE	Indicates a block or toolbar labeled “ SAMPLE. ” Block indicates the key group on the front panel. Toolbar indicates the setup toolbar (the group of buttons and boxes on the setup screen displayed in the right row).
s1 - s2 - s3 - s4	Indicates a series of operations using a menu or key labeled “ s1 ,” “ s2 ” and a button or box in the setup toolbar labeled “ s3 ,” “ s4 .”

E4991A Documentation Map

The following manuals are available for the Agilent E4991A.

- ***Operational Manual (Part Number E4991-900x0, attached to Option ABA)***

This manual describes most of the basic information needed to use the E4991A. It provides a function overview, detailed operation procedure for each function (from preparation for measurement to analysis of measurement results), measurement examples, specifications, and supplemental information. For programming guidance on performing automatic measurement with the E4991A, please see the *Programming Manual*.

- ***Installation and Quick Start Guide (Part Number E4991-902x1, attached to Option ABA)***

This manual describes installation of the instrument after it is delivered and the basic procedures for applications and analysis. Refer to this manual when you use the E4991A for the first time.

- ***Programming Manual (Part Number E4991-900x2, attached to Option ABA)***

This manual describes programming information for performing automatic measurement with the E4991A. It includes an outline of remote control, procedures for detecting measurement start (trigger) and end (sweep end), application programming examples, a command reference, and related information.

NOTE

The number position shown by “x” in the part numbers above indicates the edition number. This convention is applied to each manual, CD-ROM (for manuals), and sample programs disk issued. Here, “0” indicates the initial edition, and each time a revision is made this number is incremented by 1. The latest edition allows the customer to specify Option ABJ (Japanese) or Option ABA (English) of the product.

1. Introduction	
How to Use This Manual	12
Features of the Agilent E4991A	14
2. Installation Guide	
Incoming Inspection	17
How to Install Front Handles/Rack Mounting Flanges	22
How to Install the Handle Kit (Option 1CN)	23
How to Install the Rack-mount Kit (Option 1CM)	24
How to Install the Rack-mount and Handle Kit (Option 1CP)	24
Environmental Requirements	25
Operation Environment	25
Ventilation Space	26
Ensuring Adequate Free Space around Analyzer for Immediate Disconnection of Power Cable in Case of Emergency	26
Connection to Rear Panel	27
Connecting Mouse and Keyboard	27
Connecting BNC Cable (Option 1D5 Only)	27
Connecting the Test Head	28
Power Supply and Blown Fuses	29
Check the Power Supply	29
Verification and Connection of Power Cable	29
Blown Fuses	30
Turning the Power ON and OFF	31
Turning the Power ON	31
Turning the Power OFF	31
Disconnection from Supply Source	32
Initial Registration of E4991A	33
Test Fixtures Available for E4991A	36
Instructions for Cleaning	37
3. Basic Operations for RF Devices Measurement	
Impedance Measurement Overview	41
Flow for Impedance Measurement	41
Name of Each Area on LCD Screen	42
STEP 1. Preparation for Measurement	43
Selection of DUT and Test Fixture	43
Required Equipment	43
Connecting Mouse, Keyboard and Test Head	44
Turning the Power ON	44
STEP 2. Setting Measurement Conditions	45
Flow for Setting Measurement Conditions	45
(1) Frequency Characteristics of $ Z $ -Ls-Q	46
Procedure for Using Mouse and Keyboard	46
Procedure for Using Front Panel Keys	51
(2) Frequency Characteristics of $ Z $ -R-X	53
Presetting the E4991A	53
Setting the Measurement Parameters and Display Formats	53

Setting the Measurement Points, Sweep Parameter, and Sweep Type	54
Setting the Source Mode and Oscillator Level	54
Setting the Sweep Range (Frequency)	54
(3) Oscillator Level (Current) Characteristics of Ls-Q	55
Presetting the E4991A	55
Setting the Measurement Parameters and Display Formats	55
Setting the Measurement Points, Sweep Parameter and Sweep Type	56
Setting the Source Mode and CW Frequency	56
Setting the Sweep Range (Oscillator Level)	57
(4) Dc Bias (Current) Characteristics of Ls-Q (Option 001)	58
Presetting the E4991A	58
Setting the Measurement Parameters and Display Formats	58
Setting the Measurement Points, Sweep Parameter and Sweep Type	59
Setting the Source Mode, Oscillator Level and CW Frequency	59
Setting the Sweep Range (dc Bias)	59
STEP 3. Calibration	60
Procedure for Using Mouse and Keyboard	61
Preparing for Calibration	61
Measuring OPEN Calibration Data	62
Measuring SHORT Calibration Data	63
Measuring LOAD Calibration Data	64
Measuring LOW-LOSS CAPACITOR Calibration Data	65
Validating Calibration Data	66
Procedure for Using Front Panel Keys	67
Preparing for Calibration	67
Measuring OPEN Calibration Data	67
Measuring SHORT Calibration Data	68
Measuring LOAD Calibration Data	68
Measuring LOW-LOSS CAPACITOR Calibration data	68
Validating Calibration Data	69
STEP 4. Connecting Test Fixture	70
STEP 5. Setting Electrical Length	71
Procedure for Using Mouse and Keyboard	71
Procedure for Using Front Panel Keys	72
STEP 6. Fixture Compensation	73
Procedure for Using Mouse and Keyboard	73
Measuring OPEN Compensation Data (16197A)	73
Measuring SHORT Compensation Data (16197A)	75
Validating Fixture Compensation Data	76
Checking SHORT Compensation Data	77
Procedure for Using Front Panel Keys	79
Measuring OPEN Compensation Data (16197A)	79
Measuring SHORT Compensation Data (16197A)	79
Validating Fixture Compensation Data	80
Checking SHORT Compensation Data	80
STEP 7. Connecting DUT to Test Fixture	81
STEP 8. Measuring DUT and Analyzing Measurement Results	82
Applying dc Bias (Option 001)	82
Executing Auto scale	83

Adjusting Scale	86
Performing Averaging	87
Averaging	87
Performing Point Averaging	88
Performing Sweep Averaging	89
Using Marker Function	90
Reading Trace Values	90
Detecting Maximum Value	92
Displaying Marker List	93
Clearing Markers	95
Executing Equivalent Circuit Analysis	96
Calculating Approximate Values of Equivalent Circuit Parameters	96
Simulating Frequency Characteristics	98
Enlarging Trace (Zoom Function, Mouse Operation Only)	98
Displaying Traces on Individual Windows	99
Displaying Smith Chart	99
Displaying Five Windows	101
STEP 9. Changing Sweep Conditions	103
STEP 10. Measuring Other DUTs	103
4. Basic Operations for Dielectric Measurement	
Dielectric Measurement Overview	107
Flow for Dielectric Measurement	107
STEP 1. Preparation for Measurement	108
Selection of MUT and Test Fixture	108
Required Equipment	108
Connecting Mouse, Keyboard, and Test Head	109
Turning the Power ON	109
STEP 2. Selecting Measurement Mode	110
STEP 3. Setting Measurement Conditions	111
Setting the Measurement Parameters and Display Formats	111
Setting the Measurement Points, Sweep Parameter, and Sweep Type	112
Setting the Source Mode and Oscillator Level	112
Setting the Sweep Range (Frequency)	112
STEP 4. Connecting 16453A	113
STEP 5. Entering Thickness of Load Standard	114
STEP 6. Calibration	115
STEP 7. Entering Thickness of MUT	120
STEP 8. Connecting MUT	121
STEP 9. Measuring MUT and Analyzing Measurement Results	122
STEP 10. Changing Sweep Conditions	123
STEP 11. Measuring Other MUTs	123
5. Basic Operations for Magnetic Measurement	
Magnetic Measurement Overview	127
Flow for Magnetic Measurement	127
STEP 1. Preparation for Measurement	128
Selection of MUT and Test Fixture	128

Contents

Required Equipment	128
Connecting Mouse, Keyboard, and Test Head	129
Turning the Power ON	129
STEP 2. Selecting Measurement Mode	130
STEP 3. Setting Measurement Conditions	131
Setting the Measurement Parameters and Display Formats	131
Setting the Measurement Points, Sweep Parameter and Sweep Type	132
Setting the Source Mode and Oscillator Level	132
Setting the Sweep Range (Frequency)	132
STEP 4. Calibration	133
STEP 5. Connecting 16454A	135
STEP 6. Fixture Compensation	137
STEP 7. Entering MUT Dimensions	138
STEP 8. Mounting MUT	139
STEP 9. Measuring MUT and Analyzing Measurement Results	140
STEP 10. Changing Sweep Conditions	141
STEP 11. Measuring Other MUTs	141
A. Manual Changes	
Manual Changes	144
Miscellaneous Changes	145

1 Introduction

This Chapter explains how to use this manual efficiently and describes the features of the Agilent E4991A. Refer to this chapter first when you use the E4991A for the first time.

Contents of This Chapter

- o How to Use This Manual page 12
The chapter configuration of this manual (*Installation and Quick Start Guide*) and its use are explained.
- o Features of the Agilent E4991A page 14
The major features and functions of the E4991A are described.

How to Use This Manual

This Quick Start Guide has been prepared to quickly familiarize users with the E4991A and to overview its basic functions and measurements. Figure 1-1 shows the organization of the manual.

Figure 1-1

Organization of manual

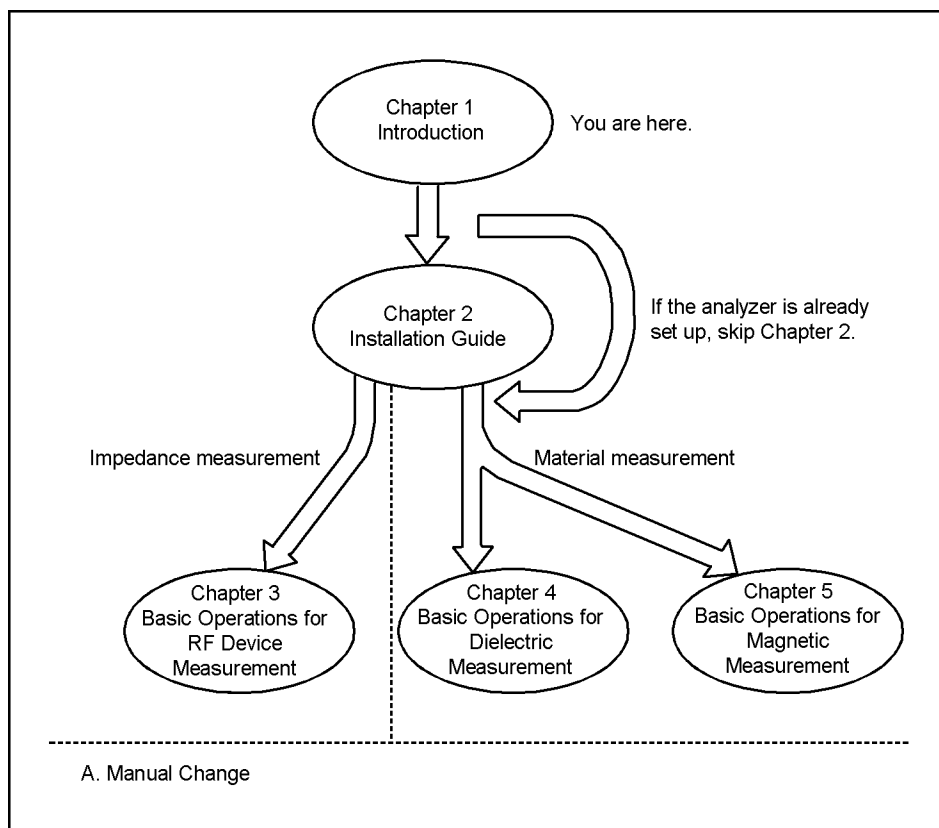

- o Chapter 1, “Introduction”

This Chapter explains how to use this manual efficiently and describes the features of the Agilent E4991A. Refer to this chapter first when you use the E4991A for the first time.

- o Chapter 2, “Installation Guide”

This chapter describes how to install and set up the Agilent E4991A after it is delivered and explains daily maintenance procedures.

- o Chapter 3, “Basic Operations for RF Devices Measurement”

This chapter explains the basic operations for taking impedance measurements with the Agilent E4991A. New users can quickly become familiar with these operations by performing procedures using chip-inductor measurements as examples.

- o Chapter 4, “Basic Operations for Dielectric Measurement”

This chapter explains the basic operations for taking dielectric measurements with the Agilent E4991A. To perform this type of measurement, the Option 002 (Material Measurement) software must be installed.

- o Chapter 5, “Basic Operations for Magnetic Measurement”

This chapter explains the basic operations for taking magnetic measurements with the Agilent E4991A. To perform this type of measurement, the Option 002 (Material Measurement) software must be installed.

- o Appendix A, “Manual Changes,”

This appendix contains the information required to adapt this manual to versions or configurations of the E4991A manufactured earlier than the current printing date of this manual.

NOTE

For the concept and basic method of material measurement, refer to Appendix C “Theory of Material Measurement” in the *E4991A Operation Manual*.

Features of the Agilent E4991A

As the replacement model of the Agilent 4291B, the E4991A (RF Impedance/Material Analyzer) is the most appropriate evaluation tool for taking impedance, dielectric and magnetic measurements of RF devices.

The E4991A is equipped with the following features to more efficiently develop and evaluate RF devices and to improve quality control.

1. Achieves high measurement accuracy in the high-frequency range (1 MHz to 3 GHz) needed to evaluate components for wireless equipment and EMI prevention.
2. Covers a wide impedance measurement range (0.2 Ω to 3 k Ω) with a single test head.
3. Dramatically improves repeatability with the improved test head.
4. Enables users to transfer and analyze measurement data efficiently with a windows-style GUI (Graphical User Interface), better PC connectivity through a LAN-based remote user interface, and the VBA programming environment.
5. Evaluates components with dc bias up to ± 50 mA/ ± 40 V if Option 001 (dc bias function) is installed.
6. Allows users to analyze measurement data with its marker function and equivalent circuit analysis function.
7. Enables users to measure surface mount devices (SMDs) of different sizes by using various types of test fixtures (sold separately) for high-frequency use.
8. Offers a material measurement solution by supporting material measurement software (Option 002) and material measurement fixtures (16453A and 16454A) that were also used with the Agilent 4291B.

2 **Installation Guide**

This chapter describes how to install and set up the Agilent E4991A after it is delivered and explains daily maintenance procedures.

Contents of this chapter

- o Incoming Inspection page 17
 - Inspection of the shipping container's contents after delivery of the analyzer.
- o How to Install Front Handles/Rack Mounting Flanges page 22
 - Installation of the front handle used for carrying the E4991A and the flange used for mounting the E4991A in a rack.
- o Environmental Requirements page 25
 - Environment requirements that must be met before using the E4991A.
- o Connection to Rear Panel page 27
 - Connecting the mouse, keyboard, and BNC cable to the rear panel.
- o Connecting the Test Head page 28
 - Connecting the test head to the E4991A.
- o Power Supply and Blown Fuses page 29
 - Verification and connection of the power cable; turning the power on/off; how to handle blown fuses.
- o Test Fixtures Available for E4991A page 36
 - Test fixtures available for the E4991A.
- o Instructions for Cleaning page 37
 - Cleaning the exterior of the E4991A.

Incoming Inspection

WARNING

To avoid dangerous electrical shock, do not turn the power on if any part of the instrument's exterior (top cover, bottom cover, side covers, front panel, rear panel, LCD display, connectors or line switch) appears to have been damaged during shipment.

Inspect the equipment by following these steps while unpacking the contents of the shipping container.

Figure 2-1

Flow for incoming inspection

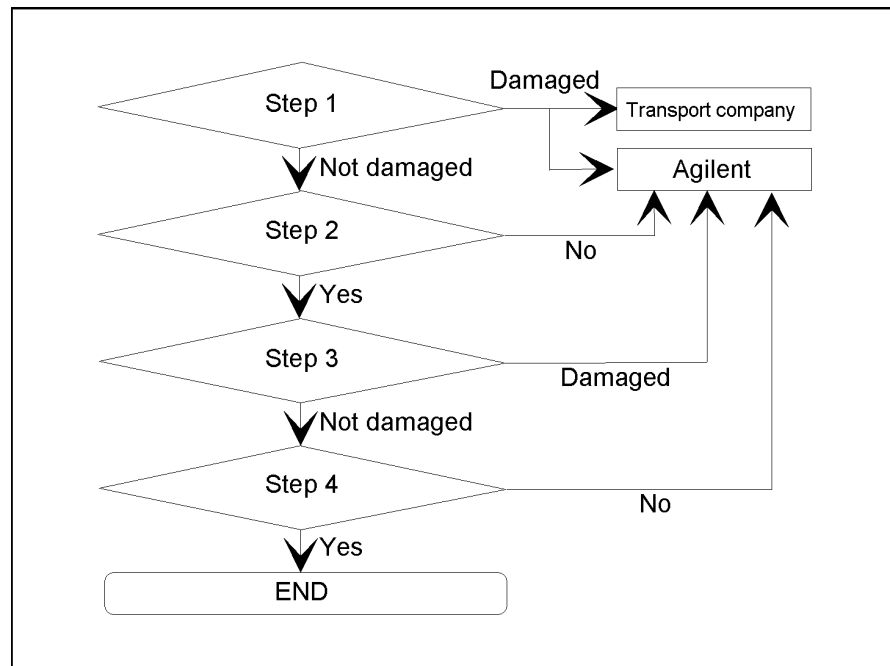

E4991aqe002

- Step 1.** Confirm that the shipping container or cushioning material is not damaged.
- Step 2.** Confirm that all of the contents of the shipment are included in the package.
- Step 3.** Confirm that there exists no mechanical or electrical defect.
- Step 4.** Confirm that the E4991A operates normally both mechanically and electrically.

For a list of the package's contents, refer to Table 2-1. Figure 2-2 shows the contents of the standard package that comes with the E4991A.

NOTE

If any of the contents of the package is missing or found to have mechanical damage or defects, or if any failure is found during verification of equipment operation, inform the nearest Agilent Technologies office. If the box is damaged or the cushioning materials show signs of unusual stress, inform the transport company in addition to the Agilent Technologies office. Keep the box, cushioning materials, and contents of the package as you found them; these materials will need to be examined in their delivered condition during the incoming inspection.

Table 2-1

Contents of E4991A package

Name of item	Agilent product/ part No.	Quantity
Standard Accessories		
o Main unit of E4991A	E4991A	1
o Test Head	E4991-60011	1
o CD-ROM (for installing E4991A VBA software)* ¹	E4991-1610x	1
o 7-mm Calibration Kit* ²	16195-60021	1
o Torque Wrench	8710-1766	1
o CD-ROM (for manuals)* ³	E4991-905xx	1
o Power Cable* ⁴	-	1
o GPIB Adapter* ⁵	E2078-62101	1
o E4991A Recovery Disk	E4991-16100	1
Options		
o Keyboard (Option 810)	-	1
o Mouse (Option 820)	-	1
o High-Stability Frequency Reference (Option 1D5)		
• BNC cable	8120-1838	1
o Manuals (Option ABA)* ⁶		
• Operation Manual	E4991-900x0	1
• Quick Start Guide	E4991-902x1	1
• Programming Manual	E4991-900x2	1
• Sample Programs Disk (3.5 inch floppy disk)	E4991-180x0	1
o Probe Station Connection Kit (Option 010)		
• Option 010 Test Head (with an extension cable)	-	1
• N(m) to SMA(f) Adapters	1250-2879	3
• 3.5-mm to 7-mm Adapter	1250-1747	1
• Screws	0515-1551	4
• Washers	3050-0891	4
o Temperature Characteristic Test Kit (Option 007)		
• Measurement Cable	-	1
• Test Fixture Stand	E4991-60005	1
• Test Head Stand Kit* ⁷	E4991-60006	1
• 7-mm OPEN Standard	E4991-60032	1
• 7-mm SHORT Standard	E4991-60031	1
• Extension Cable	04287-61651	1
• N(m) to SMA(f) Adapters	1250-1250	3
• N(f) to SMA(f) Adapters	1250-1404	3
• Pad (for the test fixture stand)	04291-09001	1
• Mount Cable Tie (for fixing the extension cable)	1400-0584	1
• Sample Program Disk (for VBA program, 3.5 inch floppy disk)	E4991-18002	1

Table 2-1 Contents of E4991A package

Name of item	Agilent product/ part No.	Quantity
Handle Kit (Option 1CN)	5063-9229	1
Rack Mount Kit (Option 1CM)	5063-9216	1
Rack Mount / Handle Kit (Option 1CP)	5188-4430	1

- *1. Used when installing VBA on an external PC. "x" in the part number indicates firmware revision, with "0" for revision 1.00 and then increments of one for each subsequent revision. The latest revision is supplied with the product.
- *2. Includes a 0 S (OPEN), 0 Ω (SHORT), and 50 Ω (LOAD) standard and a low-loss capacitor. Carrying case is not shown in Figure 2-2.
- *3. Contains the contents of the Operation Manual, Quick Start Guide, Programming Manual, and Sample Programs. "x" in the part numbers of CD-ROM indicates revision numbers, with "0" for the initial edition and then increments of one for each subsequent edition. The latest editions are supplied with the product.
- *4. This accessory is not shown in Figure 2-2. For the part number, refer to Figure 2-12 on page 30.
- *5. Use this adapter when a GPIB cable is connected to the rear panel GPIB connector.
- *6. "x" in the part numbers of manuals, and Sample Programs disk indicates edition or revision numbers, with "0" for the initial edition and then increments of one for each subsequent edition. The latest editions are supplied with the product.
- *7. Includes a stand, a holder kit (two items), and four screws.

Figure 2-2 Standard contents of package

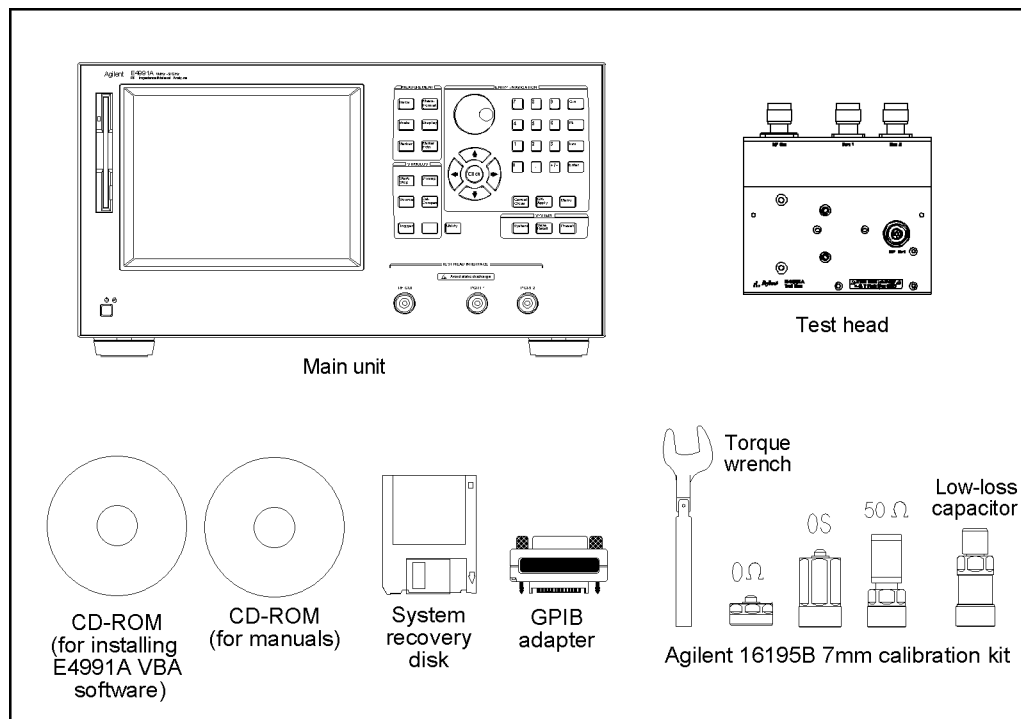

e4991aqa9001

Figure 2-3

Option 810 content

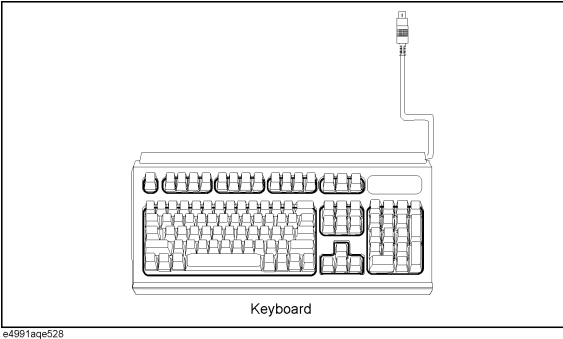

Figure 2-4

Option 820 content

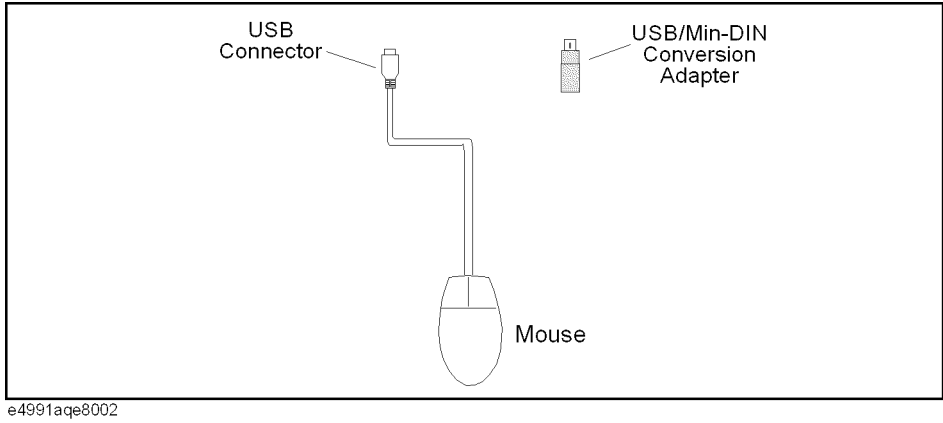

Figure 2-5

Option ABA contents

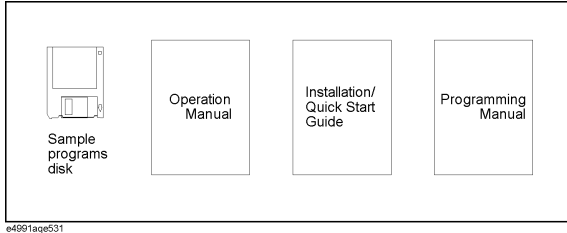
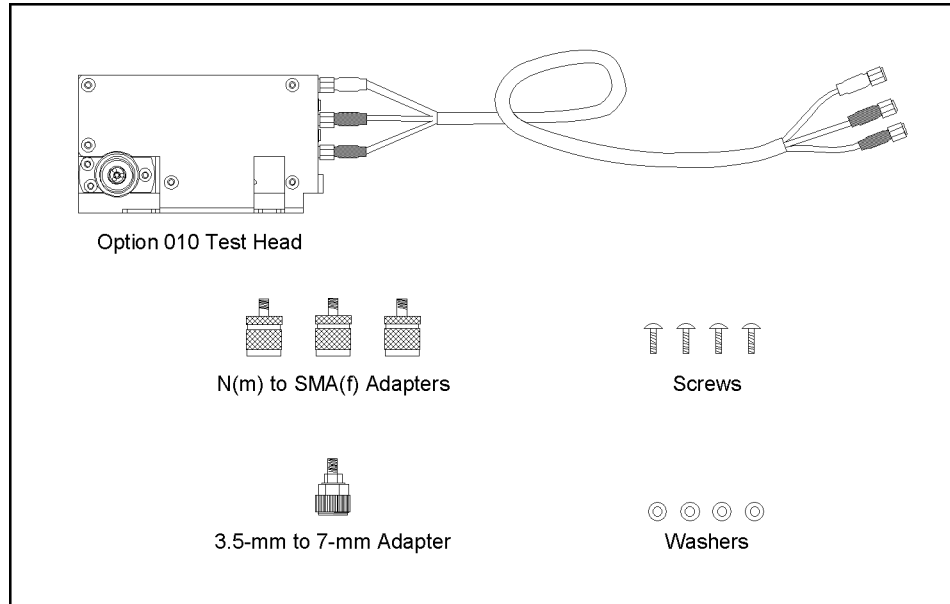

Figure 2-6

Option 010 contents



e4991aqe525

Figure 2-7

Option 007 contents

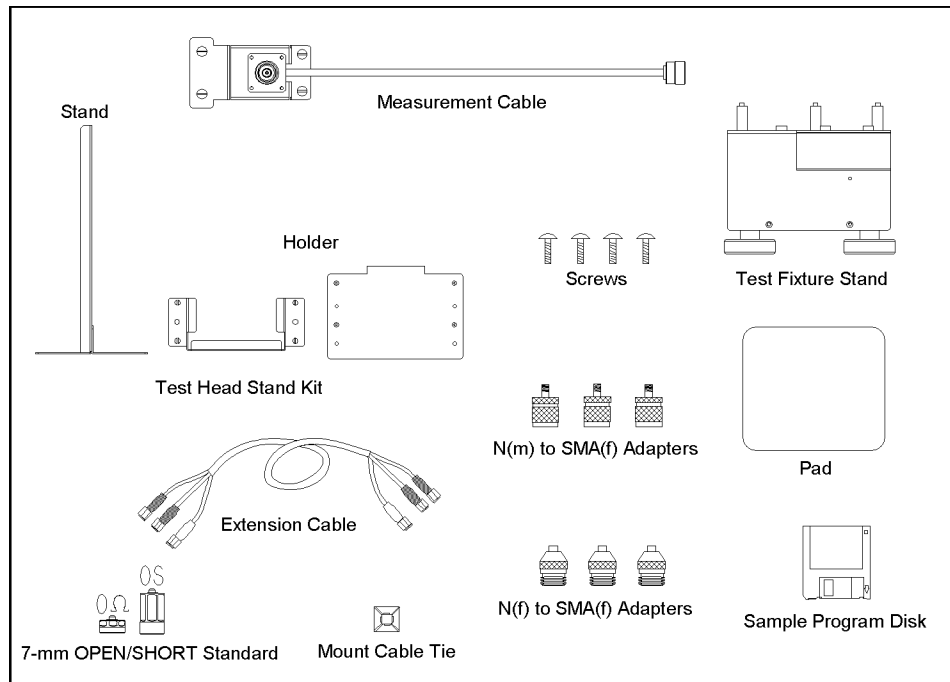

e4991aqe532

How to Install Front Handles/Rack Mounting Flanges

The E4991A can be made more convenient for use with two key options (Table 2-2): handles mounted on each side of the front for easy transport and flanges to attach the instrument to a rack as part of a multi-component measurement system.

Table 2-2

Agilent E4991A handles/rack mounting options

Option	Name	Agilent Part Number
1CN	Handle Kit	5063-9229
1CM	Rack-mount Kit	5063-9216
1CP	Rack-mount and Handle Kit	5188-4430

Table 2-3

Contents of each option

Option	Contents	Quantity
1CN	Front Handles	2
	Screws	6
	Trim Strips	2
1CM	Rack-mounting flanges (locking side plate)	2
	Screws	6
1CP	Rack-mounting flanges (locking side plate)	2
	Front Handles	2
	Screws	8

Figure 2-8 Installing front handle/rack-mount kits

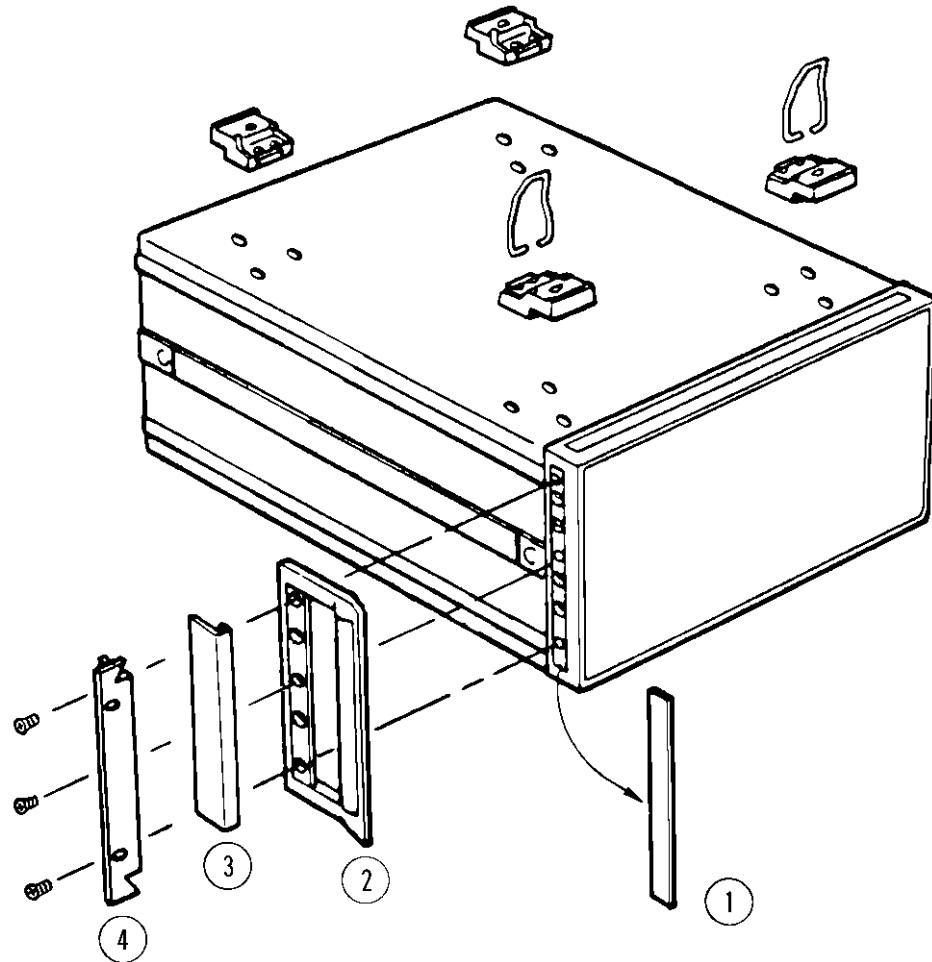

e4991aqj004

How to Install the Handle Kit (Option 1CN)

The handle kit is used for transport and relocation of the E4991A. While referring to Figure 2-8, install the handle kit by following these steps.

- Step 1.** Remove the adhesive-backed trim strip (1) from each side of the outer frame of the E4991A front panel.
- Step 2.** Use the provided screws to mount the front handles (2) on each side of the E4991A front panel frame.
- Step 3.** Attach the provided modified trim strip (3) to each front handle in order to cover the front panel locking screws.

WARNING

If the installed front handle becomes damaged, replace it with a new one immediately. A damaged handle can break while moving or lifting the instrument and cause personal injury or damage to the instrument.

How to Install the Rack-mount Kit (Option 1CM)

The rack-mount kit includes two flanges (locking side plates) for mounting the E4991A on a rack (482.6 mm/19 inches) conforming to the EIA Standard. While referring to Figure 2-8, install the rack-mount kit by following these steps.

- Step 1.** Remove the adhesive-backed trim strip (1) from each side of the outer frame of the E4991A front panel.
- Step 2.** Use the provided screws to mount a rack-mounting flange (4) on each side of the E4991A front panel frame.
- Step 3.** Remove the four bottom feet of the E4991A (lift the bar marked TAB on the inner side of the foot and slide the foot toward the bar).
- Step 4.** Mount the E4991A on the rack.

How to Install the Rack-mount and Handle Kit (Option 1CP)

The rack-mount and handle kit includes both the rack-mounting flanges (locking side plates) and front handles. While referring to Figure 2-8, install the rack-mount kit by following these steps.

- Step 1.** Remove the adhesive-backed trim strip (1) from each side of the outer frame of the E4991A front panel.
- Step 2.** Use the provided screws to mount a front handle (2) and rack-mounting flange (4) on each side of the E4991A front panel frame.
- Step 3.** Remove the four bottom feet of the E4991A (lift the bar marked TAB on the inner side of the foot and slide the foot toward the bar).
- Step 4.** Mount the E4991A on the rack.

Environmental Requirements

Ensure that the following environmental requirements are met before using the E4991A.

Operation Environment

Use the E4991A under the following environmental conditions.

Temperature	5°C to 40°C
Relative humidity (wet bulb temperature \leq 29°C, under non-condensation)	20% to 80% (Built-in floppy disk drive operating condition) 15% to 90% (Built-in floppy disk drive non-operating condition)
Altitude	0 to 2,000 m (0 to 6,561 feet)
Vibration	0.5 G maximum, 5 Hz to 500 Hz
Warm-up Time	more than 30 minutes

NOTE

The E4991A must be protected from temperature extremes that might cause condensation within the instrument.

Ventilation Space

To ensure the specifications and measurement accuracy of the product, you must keep ambient temperature around the product within the specified range by providing appropriate cooling clearance around the product or, for the rackmount type, by forcefully air-cooling inside the rack housing. For information on ambient temperature to satisfy the specifications and measurement accuracy of the product, refer to Specifications and “Supplemental Performance Characteristics” in *Operation Manual*.

When the ambient temperature around the product is kept within the temperature range of the operating environment specification (refer to “Operation Environment” on page 25), the product conforms to the requirements of the safety standard. Furthermore, under that temperature environment, it has been confirmed that the product still conforms to the requirements of the safety standard when it is enclosed with cooling clearance as follows:

Back	≥ 180 mm
Sides	≥ 60 mm (both right and left)

Figure 2-9

Ventilation space at installation site

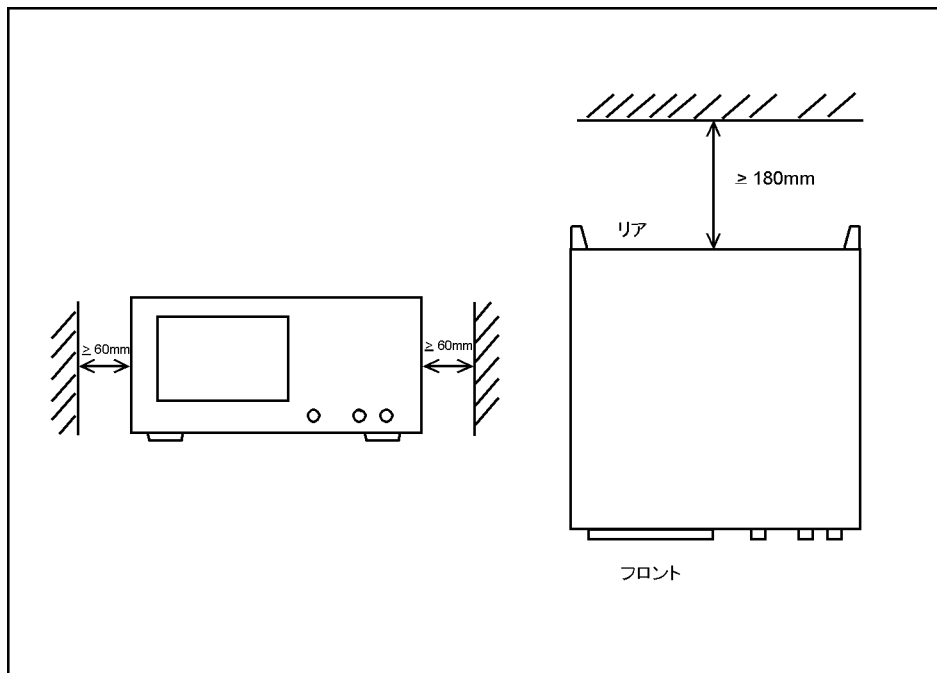

4287aoj004

Ensuring Adequate Free Space around Analyzer for Immediate Disconnection of Power Cable in Case of Emergency

As described in “Disconnection from Supply Source” on page 32, the power supply is disconnected by removing the power cable’s connector plug from either the AC outlet or the E4991A unit. When installing the E4991A, ensure that there is sufficient free space around the unit to permit quick disconnection of the plug (from AC outlet or E4991A unit) in case of emergency.

Connection to Rear Panel

Figure 2-10 Connection to rear panel

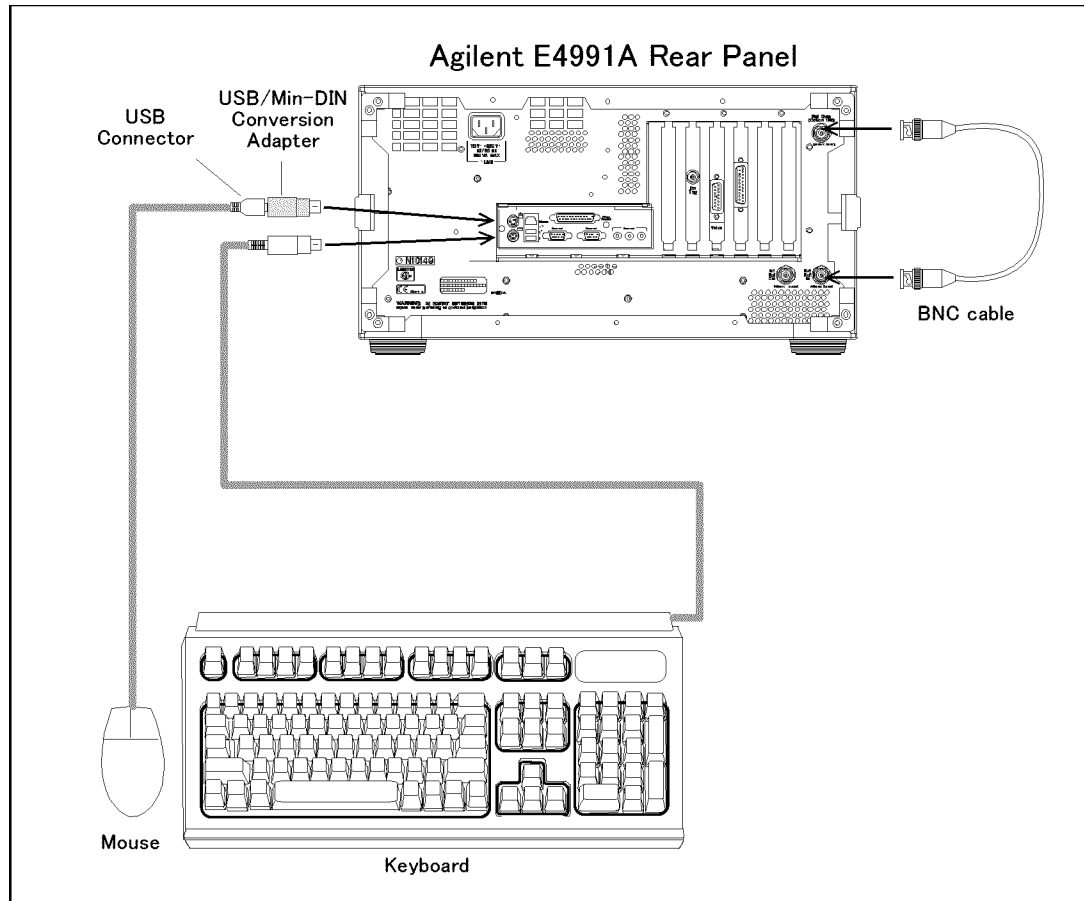

E4991aqe8003

Connecting Mouse and Keyboard

Before turning the power ON, connect the supplied mouse and keyboard as shown in Figure 2-10. The mouse allows efficient setting and operation by moving the cursor on the LCD display of the E4991A. The keyboard allows efficient entry of numerals and character strings.

Connecting BNC Cable (Option 1D5 Only)

When Option 1D5 (High-Stability Frequency Reference) is installed, connect the BNC cable between output terminal REF OVEN and input terminal EXT REF on the rear panel of the E4991A in accordance with Figure 2-10. The BNC cable is supplied with Option 1D5. Installation of Option 1D5 increases the instrument's frequency accuracy and stability.

Connecting the Test Head

When performing calibration with the 7-mm Calibration Kit or measuring DUTs with the test fixture and 7-mm terminal, you must first connect the test head to the E4991A. The procedure for making this connection is described below.

NOTE

When connecting the test head:

- Do not remove the four feet on the bottom of the E4991A; doing this would make the connection more difficult.
- Turn the N-type connectors in the order given in the instructions below when tightening them. The N-type connector for the RF OUT terminal is mounted with a special design for **flexible movement** to provide easier connection or removal of the test head.

Figure 2-11

Connecting test head to E4991A

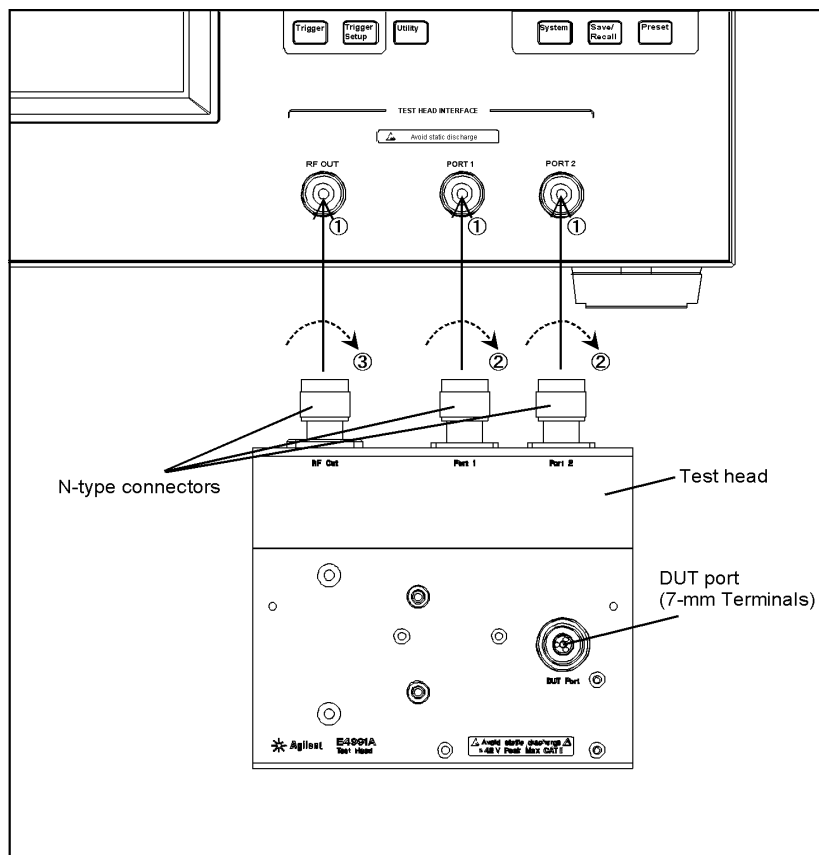

- Step 1.** Attach the N-type connectors (test head side) to their corresponding terminals (RF OUT, PORT 1 and PORT 2), which serve as the test head interface of the E4991A.
- Step 2.** Turn the N-type connectors for PORT 1 and PORT 2 at the same time to tighten them.
- Step 3.** Finally, turn the N-type connector for RF OUT to tighten it.

NOTE When removing the test head, loosen and disconnect the N-type connector connected to the RF OUT terminal first.

NOTE The N-type connector for the RF OUT terminal is mounted with a special design for **flexible movement** to provide easier connection or removal of the test head.

Power Supply and Blown Fuses

Check the Power Supply

Confirm that the power supplied to the E4991A meets the following requirements:

	Requirements
Voltage	90 to 132 VAC or 198 to 264 VAC *1
Frequency	47 to 63 Hz
Maximum power consumption	350 VA

*1. Switched automatically by the E4991A in conformity to the voltage used.

Verification and Connection of Power Cable

The three-wire power cable attached to the E4991A has one wire serving as a ground. Using this power cable allows the E4991A to be grounded, thereby protecting you against electrical shock from the power outlet.

Step 1. Confirm that the power cable is not damaged.

WARNING **NEVER use a power cable showing any sign of damage. Faulty cables can cause electrical shock.**

















Step 2. Use the supplied cable to connect between the power terminal (Figure 2-10 on page 27) on the rear panel of the E4991A and a three-wire power outlet with the grounding prong firmly connected in the ground slot.

WARNING **Use the supplied power cable with grounding wire to securely ground the E4991A.**

Figure 2-12 shows the power cable options.

Installation Guide
Power Supply and Blown Fuses

Figure 2-12 Power cable options

Option 900	United Kingdom/Singapore/Malaysia/Hong Kong	Option 901	Australia/New Zealand
	Plug: BS 1363/A, 250V, 10A Cable: 8120-8705		Plug: AS 3112, 250V, 10A Cable: 8120-1369
Option 902	Continental Europe/Indonesia/Korea/Vietnam	Option 903	U.S./Canada
	Plug: CEE 7 Standard Sheet V II, 250V, 10A Cable: 8121-1226		Plug: NEMA 5-15P, 125V, 10A Cable: 8120-1378
Option 906	Switzerland	Option 912	Denmark
	Plug: SEV 1011, 250V, 10A Cable: 8120-2104		Plug: SR107-2-D1 Sheet DK2-1A, 250V, 10A Cable: 8120-4521
Option 917	India	Option 918	Japan
	Plug: IS 1293 and IS6538, 250V, 10A Cable: 8120-4211		Plug: JIS C 8303, 125V, 12A Cable: 8120-4753
Option 920	Argentina	Option 921	Chile
	Plug: IRAM2073-10A, 250V, 10A Cable: 8121-0725		Plug: CEI23-16, 250V, 10A Cable: 8120-6978
Option 922	China	Option 923	South Africa
	Plug: GB 1002, 250V, 10A Cable: 8120-8376		Plug: SANS 164-1, 250V, 10A Cable: 8121-0564
Option 927	Thailand/Philippines	Option 930	Brazil
	Plug: NEMA 5-15P, 250V, 10A Cable: 8120-0674		Plug: NBR 14136, 250V, 10A Cable: 8121-1809
Option 931	Taiwan	Option 932	Cambodia
	Plug: CNS 10917-2, 125V, 10A Cable: 8121-1635		Plug: CS 0017:2003, 250V, 10A Cable: 8121-1638

Note: Each option number includes a "family" of cords and connectors of various materials and plug body configurations (straight, 90deg, etc).

Blown Fuses

If the fuse appears to have blown during operation, this equipment may be subject to failure and must be repaired. Contact the Agilent Technologies sales office or the company from which you purchased the equipment.

The E4991A uses the following fuse type: UL/CSA Type, Slo-Blo, 8 A/250 Vac

WARNING

Do NOT replace the fuse yourself; doing this may expose you to dangerous electrical shock.

Turning the Power ON and OFF

Perform the following steps to turn the power ON or OFF.

Turning the Power ON

Step 1. If the standby switch (⏻) in the lower-left part of the front panel is in the depressed (⏻) position, press it to put it in the popped up position (⏻).

Step 2. Press the standby switch to put it in the depressed position (⏻).
This operation turns ON the power, and the E4991A starts the self-test.

Step 3. Confirm that the self-test indicates normal operation.
Normal operation is confirmed by the self-test if no error message appears.

Turning the Power OFF

- Step 1.** Use either of the following methods to turn the power OFF.
- Press the standby switch (⏻) in the lower-left part of the front panel (now in the pressed down (⏻) position) to put it in the popped up (⏻) position.
 - Send the shutdown command from an external controller.

These operations will start the E4991A shutdown process (required software and hardware processes for turning the power off), and the power will turn OFF after a few seconds.

NOTE

Under normal circumstances, always press the standby switch (⏻), or send the shutdown command from an external controller, to execute the E4991A shutdown process. **Never cut off the power supply directly by disconnecting the power cable plug from the rear panel of the unit.**

If the power supply is cut off directly by disconnecting the power cable plug from the instrument or the AC outlet, the shutdown process is not carried out and there is a risk of damage to the E4991A's software or hardware.

Disconnection from Supply Source

The power supply of the E4991A is cut off by disconnecting the plug of the power cable (on either AC outlet side or E4991A side). When it is necessary to disconnect the power supply in order to avoid shock hazards, etc., pull out the power cable plug from either the AC outlet side or the E4991A side.

NOTE

To allow this operation to be performed smoothly, be sure to follow the guidelines in “Ensuring Adequate Free Space around Analyzer for Immediate Disconnection of Power Cable in Case of Emergency” on page 26.

When turning the power OFF under normal circumstances, always follow the methods described in “Turning the Power OFF” on page 31.

Initial Registration of E4991A

When you start up the E4991A for the first time or after executing system recovery, you need to perform the initial registration of the Windows 2000 operating system of the E4991A.

NOTE You cannot use the front panel keys during the initial registration of the E4991A therefore connect the mouse and the keyboard before turning on the power.

NOTE If you perform the following procedure incorrectly, a message asking you whether to return to the previous registration screen and perform the registration appears. In this case, follow the instruction to return to the previous registration screen.

Step 1. Turns on the E4991A.

Step 2. The Windows 2000 Professional Setup wizard appears. Click the **Next >** button (Figure 2-13).

Figure 2-13 Windows 2000 Professional Setup wizard



Installation Guide
Initial Registration of E4991A

Step 3. In the Windows 2000 Professional Setup dialog box, select the **I accept this agreement** box and click the **Next >** button (Figure 2-14). Then, the Windows 2000 operating system is restarted automatically.

Figure 2-14 Windows 2000 Professional Setup dialog box

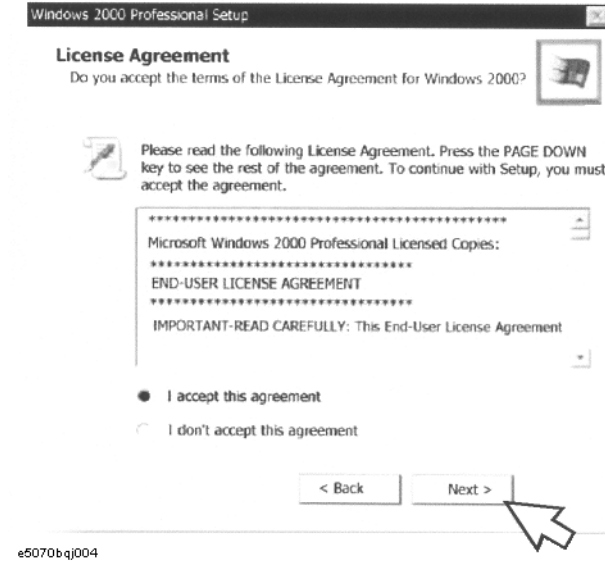

Step 4. The Network Identification wizard appears. Click the **Next >** button (Figure 2-15).

Figure 2-15 Network Identification wizard

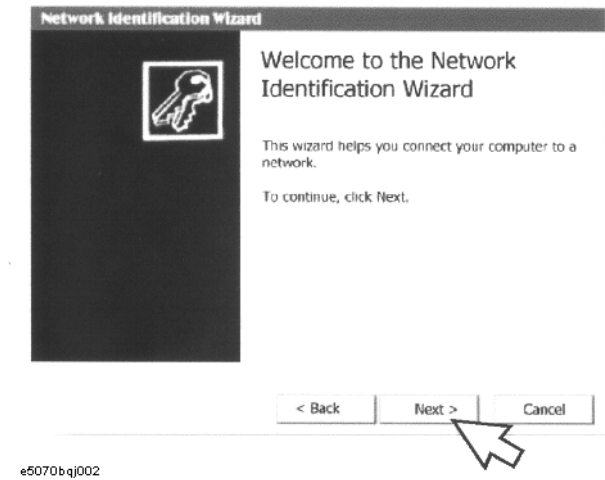

- Step 5.** In the Network Identification Wizard dialog box (1/2), select the **Windows always assumes the following user has logged on to this computer** box and check that **agt_instr** is in the **User Name** box. If not, type in **agt_instr**. Finally, click the **Next>** button (Figure 2-16).

Figure 2-16 Network Identification Wizard dialog box (1/2)

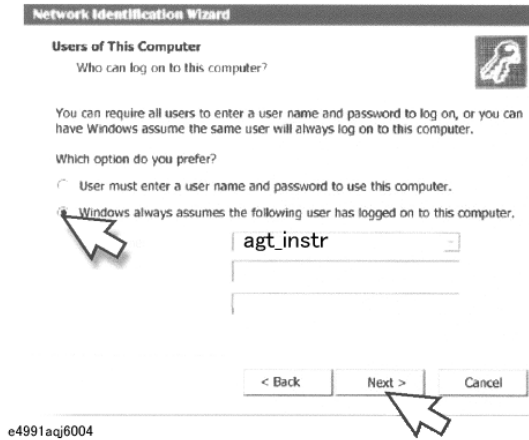

- Step 6.** In the Network Identification Wizard dialog box (2/2), click the **Finish** button to finish the initial registration of the E4991A (Figure 2-17). Then, the measurement display of the E4991A appears.

Figure 2-17 Network Identification Wizard dialog box (2/2)

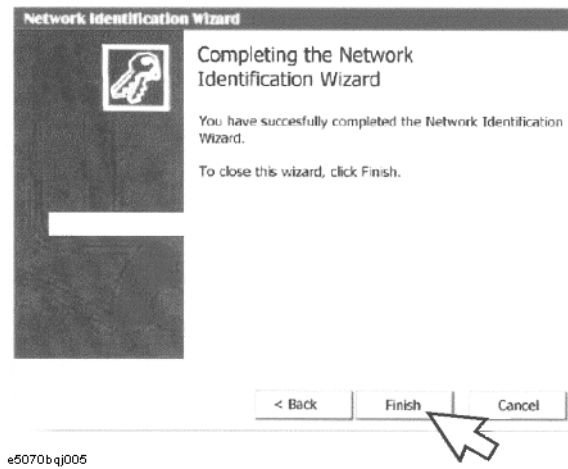

Test Fixtures Available for E4991A

Test fixtures are used to provide high stability and repeatability in measurements. The test fixtures that can be used with the E4991A are listed in the following table. Select the appropriate test fixture depending on the type and size of the DUT. For detailed specifications of the test fixtures, refer to accessory catalogs or the operation manual of each test fixture.

Figure 2-18 Type and sizes of DUTs

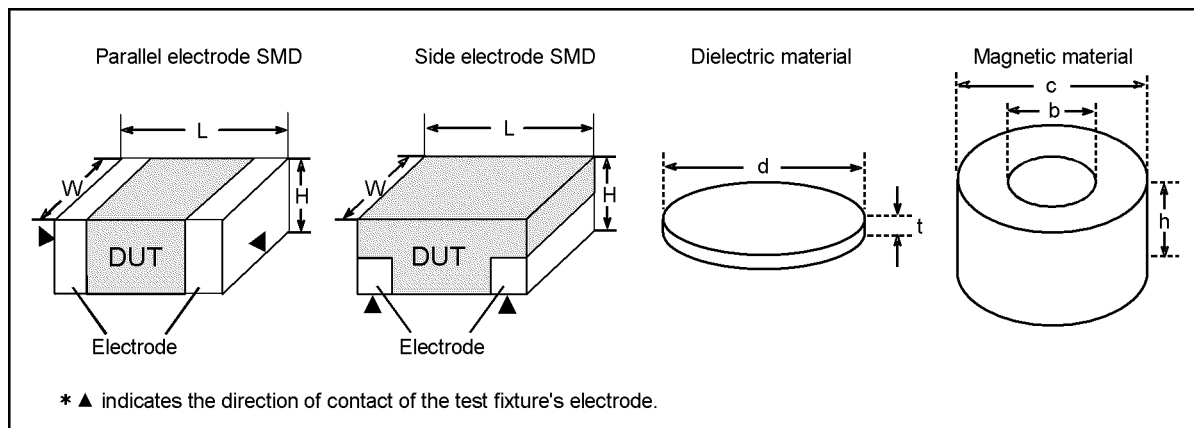

E4991aqe005

Table 2-4 Test fixtures for parallel electrode SMD

Test fixture	Frequency range	Size of DUT (SMD) (mm)		
		Length (L)	Width (W)	Height (H)
16196A	1 MHz to 3 GHz	1.6	0.8	0.5 to 0.8
16196B		1.0	0.5	0.35 to 0.5
16196C		0.6	0.3	0.3
16192A	1 MHz to 2 GHz	1.0 to 20.0	0.5 to 5.0	0.5 to 5.0

Table 2-5 Test fixtures for bottom electrode SMD

Test fixture	Frequency range	Size of DUT (SMD) (mm)		
		Length (L)	Width (W)	Height (H)
16197A ^{*1}	1 MHz to 3 GHz	1.0	0.5	0.4 to 3.0
		1.6	0.8	
		2.0	1.2	
		3.2	1.6 to 2.5	
16193A	1 MHz to 2 GHz	0.5 to 3.2	≤ 3.0	≤ 3.0

Table 2-5 Test fixtures for bottom electrode SMD

Test fixture	Frequency range	Size of DUT (SMD) (mm)		
		Length (L)	Width (W)	Height (H)
16191A	1 MHz to 2 GHz	2.0 to 12.0	0.5 to 5.0	0.5 to 5.0

*1. When Option 001 is selected, SMD size of 0603 (mm) / 0201 (inch) is covered.

Table 2-6 Test fixtures for dielectric materials

Test fixture	Frequency range	Size of DUT (dielectric materials) (mm)	
		Width / Diameter (d)	Thickness (t)
16453A	1 M to 1 GHz	$\geq \phi 15.0$	0.3 to 3.0

Table 2-7 Test fixtures for magnetic materials

Test fixture	Frequency range	Size of DUT (magnetic materials) (mm)		
		Inner diameter (b)	Outer diameter (c)	Height (h)
16454A	1 M to 1 GHz	$\geq \phi 3.1$	$\leq \phi 20.0$	≤ 8.5

NOTE In addition to the above test fixtures, you can also use your own custom-made fixtures.

Instructions for Cleaning

To clean the exterior of the E4991A, gently wipe the surfaces with a clean dry cloth or a clean cloth that has been soaked in water and wrung tightly. Do not attempt to clean the internal parts of the E4991A.

WARNING To prevent electrical shock, disconnect the E4991A's power cable from the AC outlet before cleaning.

3 Basic Operations for RF Devices Measurement

This chapter explains the basic operations for taking impedance measurements with the Agilent E4991A. New users can quickly become familiar with these operations by performing procedures using chip-inductor measurements as examples.

Contents of this chapter

- o Impedance Measurement Overview page 41
Measurement examples and a basic flow for impedance measurement.
- o STEP 1. Preparation for Measurement page 43
How to prepare for measurement.
- o STEP 2. Setting Measurement Conditions page 45
How to set sweeping conditions and measurement parameters.
- o STEP 3. Calibration page 60
How to perform OPEN / SHORT / LOAD (/ LOW-LOSS CAPACITOR) calibrations.
- o STEP 4. Connecting Test Fixture page 70
How to connect the test fixture (16197A) to the 7-mm terminal of the test head.
- o STEP 5. Setting Electrical Length page 71
How to set the electrical length for the test fixture.
- o STEP 6. Fixture Compensation page 73
How to perform OPEN/SHORT compensation. OPEN/SHORT compensation for the 16197A is explained as an example.
- o STEP 7. Connecting DUT to Test Fixture page 81
How to connect a DUT to the test fixture (16197A).
- o STEP 8. Measuring DUT and Analyzing Measurement Results page 82
How to achieve the optimum setting of the vertical axis scale and analyze the measurement results.
- o STEP 9. Changing Sweep Conditions page 103
How to change the sweep conditions.
- o STEP 10. Measuring Other DUTs page 103
How to measure other DUTs.

Impedance Measurement Overview

The following four measurement examples can help you learn how to use the E4991A.

- Frequency characteristics of impedance, inductance and Q
- Frequency characteristics of impedance, resistance and reactance
- Oscillator level (current) characteristics of inductance and Q
- Dc bias (current) characteristics of inductance and Q

Flow for Impedance Measurement

The basic procedure for impedance measurement is shown in the flow chart in Figure 3-1.

Figure 3-1 Basic flow for impedance measurement

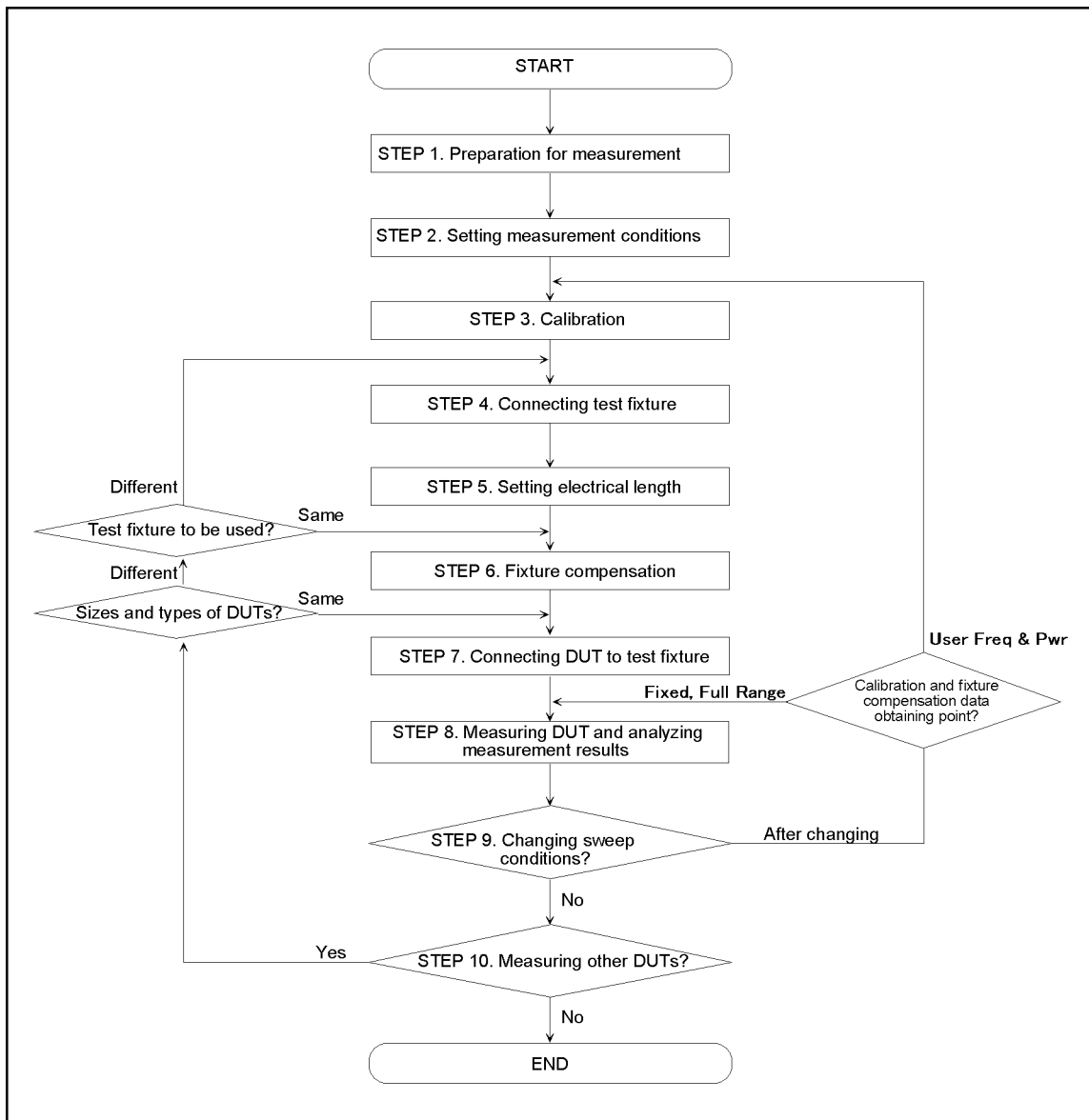

E4991aqe008

Name of Each Area on LCD Screen

The name of each area on the LCD screen is given in Figure 3-2 and Table 3-1.

Figure 3-2 LCD Screen

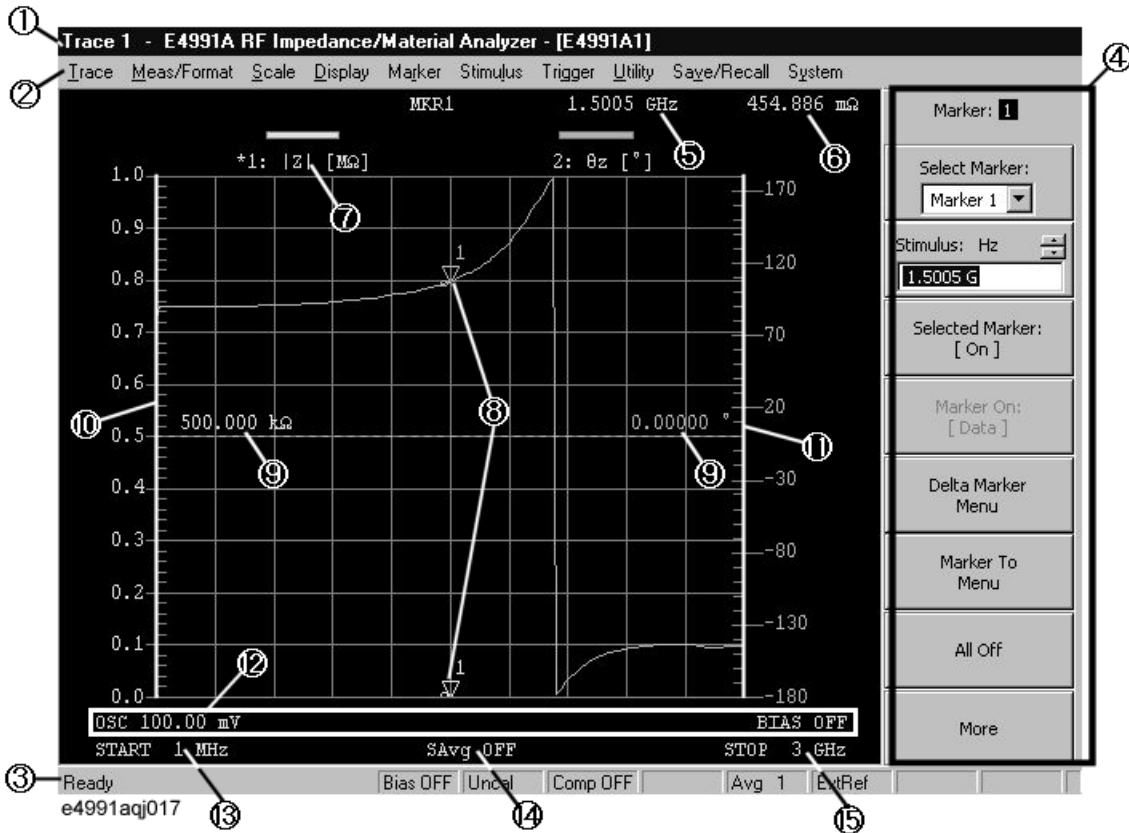

Table 3-1 Name of each area on LCD Screen

Number	Name	Number	Name
1	Title bar	2	Menu bar
3	Status bar	4	Setup toolbar
5	Stimulus value	6	Trace value
7	Trace 1	8	Marker
9	Scale reference line value	10	Trace 1 axis
11	Trace 2 axis	12*1	Source settings condition
13	Sweep start value	14	Sweep averaging counter
15	Sweep stop value		

*1. Indicates CW: Source frequency, OSC: Oscillator level, and BIAS: dc bias level [dc bias limit value]

NOTE

For each feature, refer to Chapter 2, “Function overview” in the *E4991A Operation Manual*.

STEP 1. Preparation for Measurement

Selection of DUT and Test Fixture

The test fixtures are used to provide measurements that have high stability and repeatability. Agilent Technologies provides test fixtures for different sizes and types of SMDs (surface mounted devices) such as chip inductors and chip capacitors. The following test fixtures can be used with the E4991A.

- o 16191A
- o 16192A
- o 16193A
- o 16196A/B/C
- o 16197A

NOTE

Select the appropriate test fixture depending on the type and size of the DUT by referring to “Test Fixtures Available for E4991A” on page 36.

This chapter describes measurement examples using a chip inductor of 1608 mm/0603 inches in size as the DUT and the 16197A as the test fixture.

Required Equipment

The measurement examples in this chapter require the following equipment.

Agilent E4991A RF Impedance/Material Analyzer <ul style="list-style-type: none">o E4991A (main unit)o Test heado Agilent 16195B calibration kito Mouseo Keyboard
Agilent 16197A single-sided electrode SMD test fixture <ul style="list-style-type: none">o 16197A test fixtureo Short device seto A pair of tweezers
Measurement DUT: Chip inductor [1608 mm/0603 inches]

Figure 3-3

Required equipment

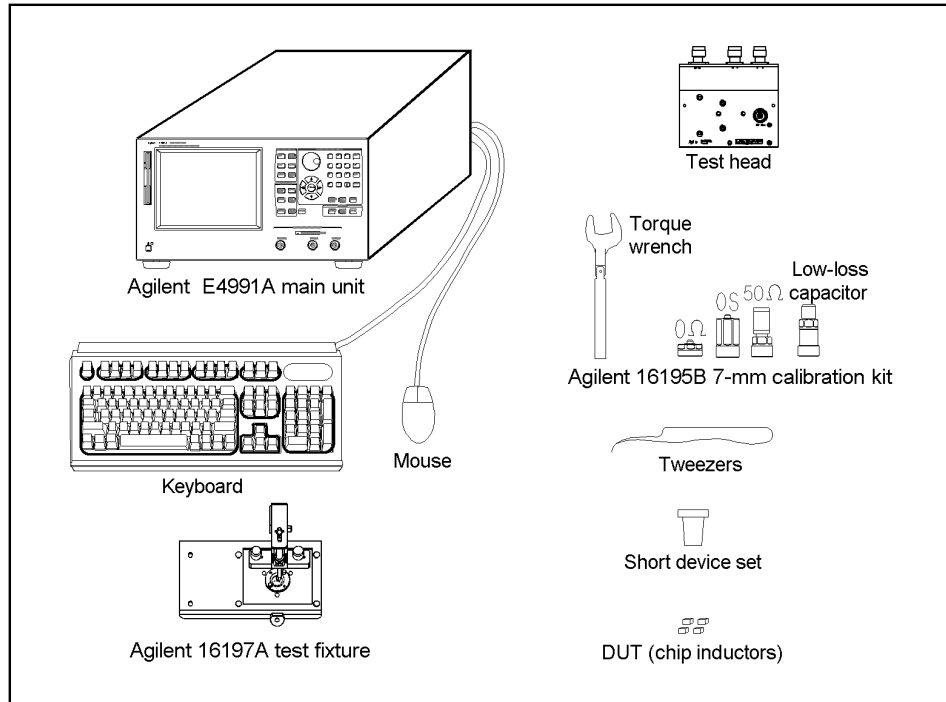

e4991aqe038

Connecting Mouse, Keyboard and Test Head

Connect the mouse, keyboard and test head to the E4991A as shown in “Connection to Rear Panel” on page 27 and “Connecting the Test Head” on page 28. Be sure not to remove the four feet on the bottom of the E4991A when connecting the test head.

NOTE Be sure to connect the mouse and keyboard before turning the power ON.

NOTE Do not connect the test fixtures to the test head at this point because calibration is performed on the DUT port (7-mm terminal) of the test head later.

Turning the Power ON

Perform the following steps to turn the power ON. The E4991A starts the self-test automatically when the power is turned ON.

Step 1. If the standby switch (⏻) in the lower-left part of the front panel is in the depressed (⏻) position, press the switch to put it in the popped up position (⏻).

Step 2. Press the standby switch to put it in the pressed down position (⏻).

NOTE Special caution is required when turning the power ON or OFF. Refer to “Turning the Power ON and OFF” on page 31.

STEP 2. Setting Measurement Conditions

Before starting the measurement, you must set measurement parameters and sweep conditions depending on your measurement requirements. This section describes the setup procedure for the following four measurements.

- (1) Frequency characteristics of $|Z|$ -Ls-Q
- (2) Frequency characteristics of $|Z|$ -R-X
- (3) Oscillator level (current) characteristics of Ls-Q
- (4) Dc bias (current) characteristics of Ls-Q

The procedure for measurement example (1) is carried out by using the mouse and keyboard as well as front panel keys. The procedures for measurement examples (2), (3) and (4) are carried out by using the mouse and keyboard only.

NOTE

When measuring a capacitor, the OSC level (voltage) and dc bias (voltage) characteristics are used.

Flow for Setting Measurement Conditions

The basic procedure for setting the measurement conditions is illustrated in Figure 3-4.

Figure 3-4

Basic flow for setting measurement conditions

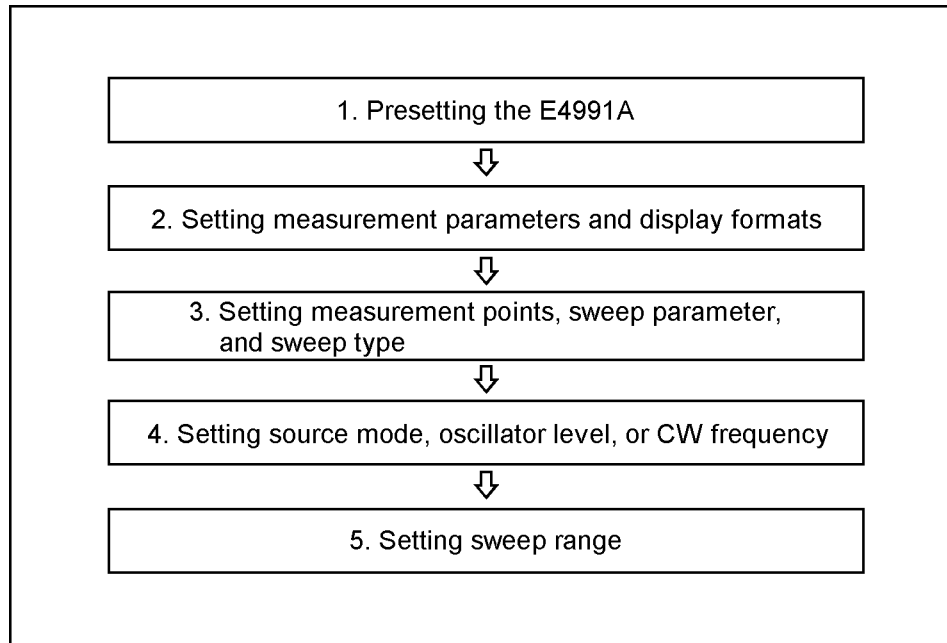

E4991aqe011

Basic Operations for RF Devices Measurement
STEP 2. Setting Measurement Conditions

(1) Frequency Characteristics of $|Z|$ - L_s - Q

You first have to change the measurement conditions from the initial state of the E4991A as shown in Table 3-2.

Table 3-2 Setup example for this measurement

Parameter setting		Setup example	Initial state
Measurement parameters	Trace 1	$ Z $	$ Z $
	Trace 2	L_s	θ_z
	Trace 3	Q	Q
Display formats	Trace 1	Log	Linear
	Trace 2	Linear	Linear
	Trace 3	Linear	Linear
Measurement points		201 points	201 points
Sweep parameter		Frequency	Frequency
Sweep type		Log	Linear
Source mode		Current	Voltage
Oscillator level		1 mA	100 mV (2 mA)
Sweep range (frequency)		1 MHz to 3 GHz	1 MHz to 3 GHz

Procedure for Using Mouse and Keyboard

Set up the E4991A by following the procedure given below.

Presetting the E4991A

Step 1. Click **Preset** on the **System** menu to set the initial state (Figure 3-5).

Figure 3-5

Presetting E4991A

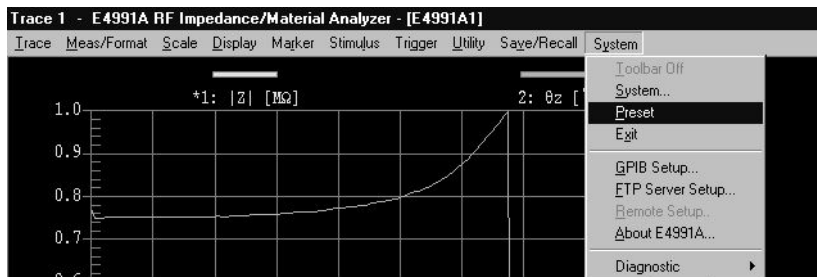

Setting the Measurement Parameters and Display Formats

Step 1. Click **Display...** on the **Display** menu (Figure 3-6).

Figure 3-6

Step 1

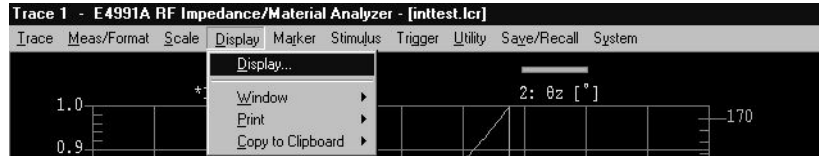

Step 2. Select **3 Scalar** in the **Num Of Traces** box (Figure 3-7).

Figure 3-7

Step 2

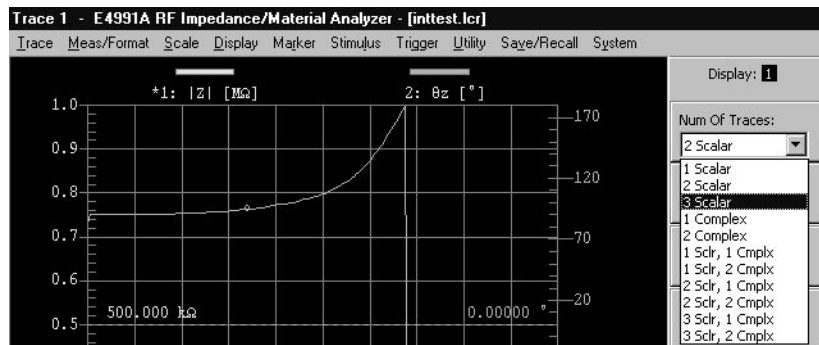

Table 3-3

Num Of Traces box and Types of traces

Num Of Traces box	Type of trace
x Scalar*1	Scalar trace
x Complex*1	Complex trace

*1.[x] represents the number of displayed traces.

Step 3. Click **Meas/Format...** on the **Meas/Format** menu (Figure 3-8).

Figure 3-8

Step 3



Step 4. Specify Trace 1 as the active trace by either of the following methods. When it is made active, “*” appears immediately before Trace 1.

- Click **Scalar 1** on the **Trace** menu (Figure 3-9).
- Move mouse pointer to **1: |Z| [Ω]** or **2: θz [rad]** (white framed area) on the display screen, where the cursor changes to a finger icon () (Figure 3-10). Then Click **1: |Z| [Ω]**.

Basic Operations for RF Devices Measurement
STEP 2. Setting Measurement Conditions

Figure 3-9

Step 4 (using Trace menu)

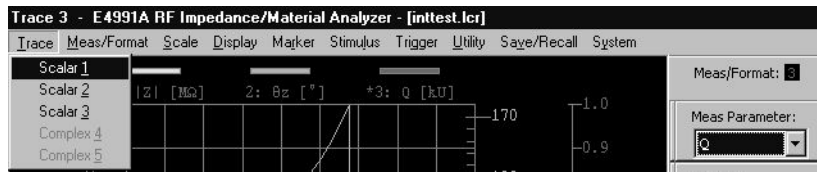
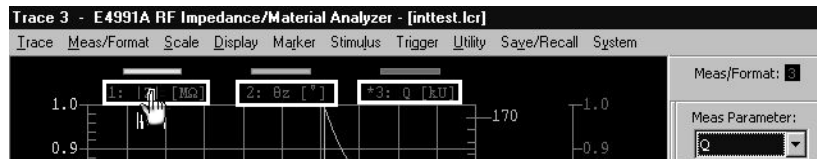

Figure 3-10

Step 4 (using the mouse)



Step 5. The **Meas Parameter** box is set to **|Z|** in the initial state.

Step 6. Select **Log Y-Axis** in the **Format** box (Figure 3-11).

Figure 3-11

Step 6

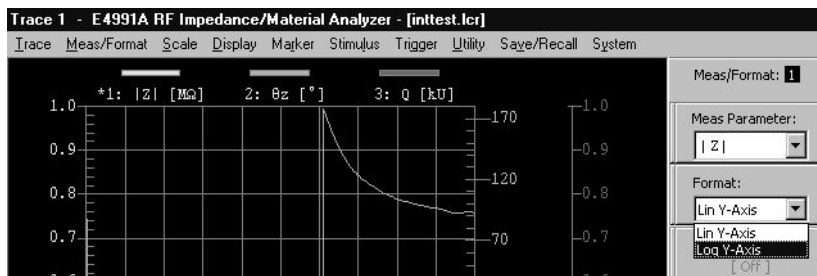

Step 7. Specify Trace 2 as the active trace (* mark) as shown in Figure 3-9 and Figure 3-10.

Step 8. Select **Ls** in the **Meas Parameter** box (Figure 3-12).

Figure 3-12

Step 8

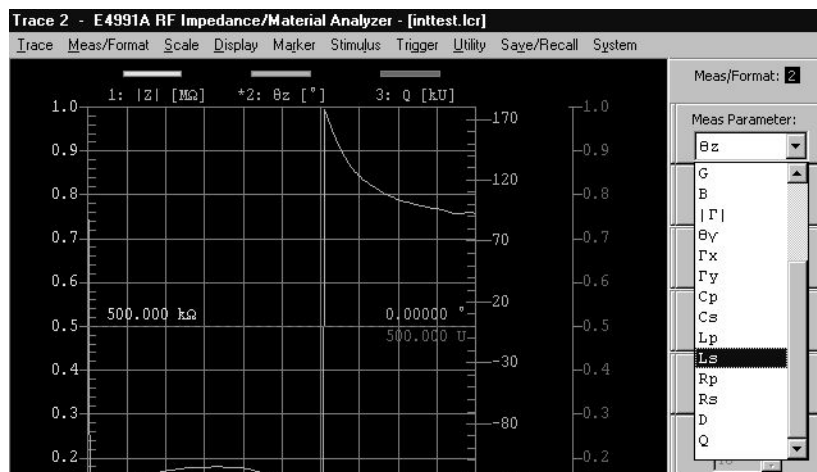

Step 9. The **Format** box is set to **Lin Y-Axis** in the initial state.

Step 10. Specify Trace 3 as the active trace (* mark) as shown in Figure 3-9 and Figure 3-10.

Step 11. The **Meas Parameter** box is set to **Q** in the initial state.

Step 12. The **Format** box is set to **Lin Y-Axis** in the initial state.

Setting the Measurement Points, Sweep Parameter, and Sweep Type

Step 1. Click **Sweep Setup...** on the **Stimulus** menu (Figure 3-13).

Figure 3-13

Step 1

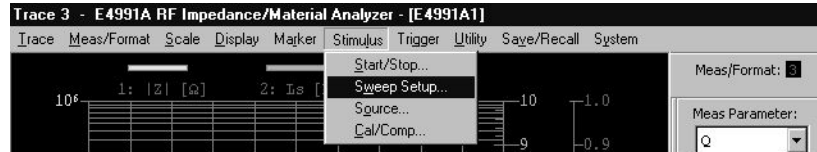

Step 2. The **Number Of Points** box is set to **201** in the initial state (Figure 3-14).

Figure 3-14

Steps 2, 3, 4

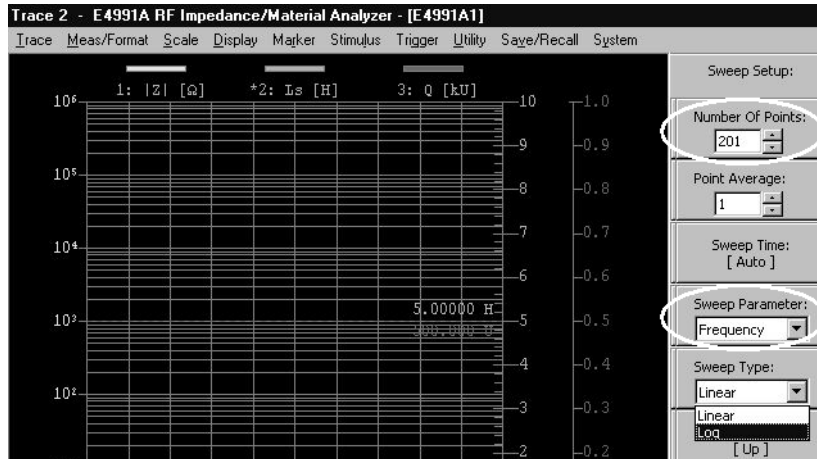

Step 3. The **Sweep Parameter** box is set to **Frequency** in the initial state (Figure 3-14).

Step 4. Select **Log** in the **Sweep Type** box (Figure 3-14)

Setting the Source Mode and Oscillator Level

Step 1. Click **Source...** on the **Stimulus** menu (Figure 3-15).

Figure 3-15

Step 1

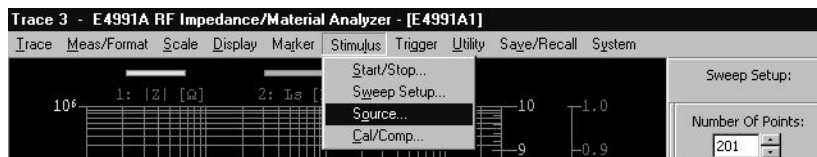

Basic Operations for RF Devices Measurement

STEP 2. Setting Measurement Conditions

Step 2. Select **Current** in the **Osc Unit** box (Figure 3-16).

Figure 3-16

Step 2

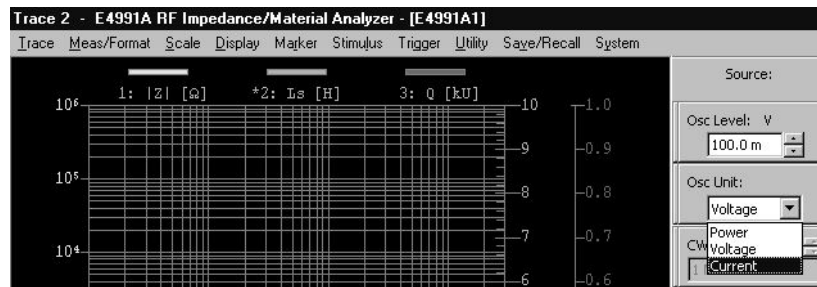

Step 3. Select **Osc Level** box and type **[1] [m] [Enter]** with the keyboard (Figure 3-17).

Figure 3-17

Step 3

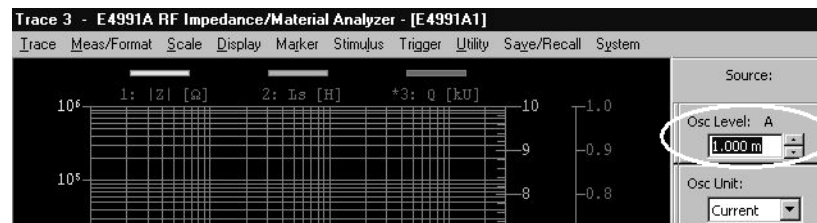

NOTE

When entering the unit of current with the keyboard, type **[m]** for mA.

Setting the Sweep Range (Frequency)

Step 1. Click **Start/Stop...** on the **Stimulus** menu (Figure 3-18).

Figure 3-18

Step 1



Step 2. The **Start** box is set to **1 M** Hz in the initial state (Figure 3-19).

Figure 3-19

Steps 2, 3

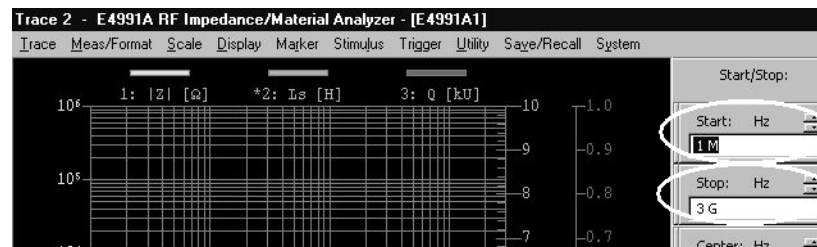

Step 3. The **Stop** box is set to **3 G** Hz in the initial state (Figure 3-19).

Procedure for Using Front Panel Keys







Set up the E4991A as shown in the following procedure.

Presetting the E4991A

Step 1. Press the **[Preset]** key in the **SYSTEM** block to return to the initial state.

Setting the Measurement Parameters and Display Formats







Step 1. Press the **[Display]** key in the **MEASUREMENT** block.

Step 2. Press the  or  key to move the cursor to the **Num Of Traces** box, and then press the  key to open the list. Next, press the  or  key to move the cursor to **3 Scalar** and press the  key (Figure 3-7).







Step 3. Press the **[Meas/Format]** key in the **SYSTEM** block.

Step 4. Press the **[Trace]** key in the **MEASUREMENT** block to specify Trace 1 as the active trace. When the trace is made active, “*” appears before Trace 1.

Step 5. The **Meas Parameter** box is set to **|Z|** in the initial state.

Step 6. Press the  or  key in the **ENTRY/NAVIGATION** block to move the cursor to the **Format** box and then press the  key to open the list. Next, press the  or  key to move the cursor to **Log Y-Axis** and press the  key (Figure 3-11).

Step 7. Press the **[Trace]** key in the **MEASUREMENT** block to specify Trace 2 as the active trace.

Step 8. Press the  or  key to move the cursor to the **Meas Parameter** box and then press the  key to open the list. Next, press the  or  key to move the cursor to **Ls** and press the  key (Figure 3-12).

Step 9. The **Format** box is set to **Lin Y-Axis** in the initial state.

Step 10. Press the **[Trace]** key in the **MEASUREMENT** block to specify Trace 3 as the active trace.

Step 11. The **Meas Parameter** box is set to **Q** in the initial state.

Step 12. The **Format** box is set to **Lin Y-Axis** in the initial state.

Setting the Measurement Points, Sweep Parameter and Sweep Type







Step 1. Press the **[Sweep]** key in the **STIMULUS** block.

Step 2. The **number Of Points** box is set to **201** in the initial state (Figure 3-14).

Basic Operations for RF Devices Measurement







STEP 2. Setting Measurement Conditions





Step 3. The **Sweep Parameter** box is set to **Frequency** in the initial state (Figure 3-14).

Step 4. Press the  or  key to move the cursor to the **Sweep Type** box and then press the  key to open the list. Next, press the  or  key to move the cursor to **Log** and press the  key (Figure 3-14).

Setting the Source Mode and Oscillator Level

Step 1. Press the **[Source]** key in the **STIMULUS** block.

Step 2. Press the  or  key to move the cursor to the **Osc Unit** box and then press the  key to open the list. Next, press the  or  key to move the cursor to **Current** and press the  key (Figure 3-16).

Step 3. Press the  or  key to move the cursor to the **Osc Level** box and then press the ,  keys in this order (Figure 3-17).

Setting the Sweep Range (Frequency)

Step 1. Press the **[Start/Stop]** key in the **STIMULUS** block.

Step 2. The **Start** box is set to **1 M** Hz in the initial state (Figure 3-19).

Step 3. The **Stop** box is set to **3 G** Hz in the initial state (Figure 3-19).

(2) Frequency Characteristics of $|Z|$ -R-X

You should first change the measurement conditions from the initial state of the E4991A as shown in Table 3-4.

Table 3-4 Setup example for this measurement

Parameter setting		Setup example	Initial state
Measurement parameters	Trace 1	$ Z $	$ Z $
	Trace 2	R	θ_z
	Trace 3	X	Q
Display formats	Trace 1	Log	Linear
	Trace 2	Log	Linear
	Trace 3	Linear	Linear
Measurement points		201 points	201 points
Sweep parameter		Frequency	Frequency
Sweep type		Linear	Linear
Source mode		Current	Voltage
Oscillator level		1 mA	100 mV (2 mA)
Sweep range (frequency)		1.5 GHz to 2.5 GHz	1 MHz to 3 GHz

Presetting the E4991A

Preset the E4991A to the initial state by referring to the procedure described in “Presetting the E4991A” on page 46.

Setting the Measurement Parameters and Display Formats

- Step 1.** Click **Display...** on the **Display** menu (Figure 3-6).
- Step 2.** Select **3 Scalar** in the **Num Of Traces** box (Figure 3-7).
- Step 3.** Click **Meas/Format...** on the **Meas/Format** menu (Figure 3-8).
- Step 4.** Specify Trace 1 as the active trace (* mark) as shown in Figure 3-9 and Figure 3-10.
- Step 5.** **Meas Parameter** box is set to $|Z|$ in the initial state.
- Step 6.** Select **Log Y-Axis** in the **Format** box (Figure 3-11).
- Step 7.** Specify Trace 2 as the active trace (* mark) as shown in Figure 3-9 and Figure 3-10.
- Step 8.** Select **R** in the **Meas Parameter** box as shown in Figure 3-12.

Basic Operations for RF Devices Measurement

STEP 2. Setting Measurement Conditions

- Step 9.** Select **Log Y-Axis** in the **Format** box (Figure 3-11).
- Step 10.** Specify Trace 3 as the active trace (* mark) as shown in Figure 3-9 and Figure 3-10.
- Step 11.** Select **X** in the **Meas Parameter** box as shown in Figure 3-12.
- Step 12.** **Format** box is set to **Lin Y-Axis** in the initial state.

Setting the Measurement Points, Sweep Parameter, and Sweep Type

- Step 1.** Click **Sweep Setup...** on the **Stimulus** menu (Figure 3-13).
- Step 2.** **Number Of Points** box is set to **201** in the initial state (Figure 3-14).
- Step 3.** **Sweep Parameter** box is set to **Frequency** in the initial state (Figure 3-14).
- Step 4.** **Sweep Type** box is set to **Linear** in the initial state.

Setting the Source Mode and Oscillator Level

Perform this setup in the same way as “Setting the Source Mode and Oscillator Level” on page 49.

Setting the Sweep Range (Frequency)

- Step 1.** Click **Start/Stop...** on the **Stimulus** menu (Figure 3-18).
- Step 2.** Select **Start** box, and type **[1] [.] [5] [G] [Enter]** on the keyboard (Figure 3-20).
- Step 3.** Select **Stop** box, and type **[2] [.] [5] [G] [Enter]** on the keyboard (Figure 3-20).

Figure 3-20

Steps 2, 3

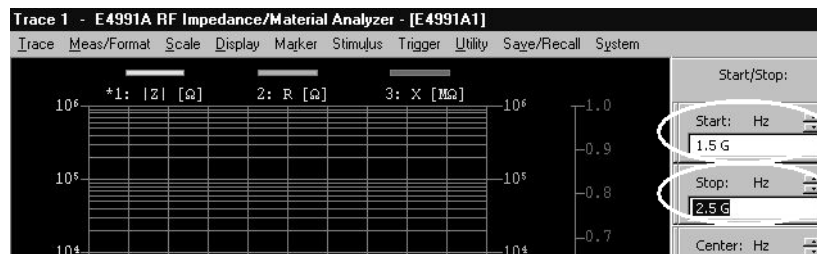

NOTE

When entering the frequency unit with the keyboard, type **[M]** for MHz and **[G]** for GHz.

(3) Oscillator Level (Current) Characteristics of Ls-Q

You should first change the measurement conditions from the initial state of the E4991A as shown in Table 3-5.

Table 3-5 Setup example for this measurement

Parameter Setting		Setup example	Initial state
Measurement parameters	Trace 1	Ls	Z
	Trace 2	Q	θ_z
Display formats	Trace 1	Linear	Linear
	Trace 2	Linear	Linear
Measurement points		201 points	201 points
Sweep parameter		Oscillator level	Frequency
Sweep type		Linear	Linear
Source mode		Current	Voltage
CW frequency		100 MHz	1 MHz
Sweep range (frequency)		100 μ A to 10 mA	4 mA to 8 mA

Presetting the E4991A

Preset the E4991A to the initial state by referring to the procedure described in “Presetting the E4991A” on page 46.

Setting the Measurement Parameters and Display Formats

- Step 1.** Click **Meas/Format...** on the **Meas/Format** menu (Figure 3-8).
- Step 2.** Specify Trace 1 as the active trace (* mark) as shown in Figure 3-9 and Figure 3-10.
- Step 3.** Select **Ls** in the **Meas Parameter** box (Figure 3-12).
- Step 4.** **Format** box is set to **Lin Y-Axis** in the initial state.
- Step 5.** Specify Trace 2 as the active trace (* mark) as shown in Figure 3-9 and Figure 3-10.
- Step 6.** Select **Q** in the **Meas Parameter** box as shown in Figure 3-12.
- Step 7.** **Format** box is set to **Lin Y-Axis** in the initial state.

Basic Operations for RF Devices Measurement

STEP 2. Setting Measurement Conditions

Setting the Measurement Points, Sweep Parameter and Sweep Type

- Step 1. Click **Sweep Setup...** on the **Stimulus** menu (Figure 3-13).
- Step 2. **Number Of Points** box is set to **201** in the initial state.
- Step 3. Select **Power** in the **Sweep Parameter** box (Figure 3-21).

Figure 3-21

Step 3

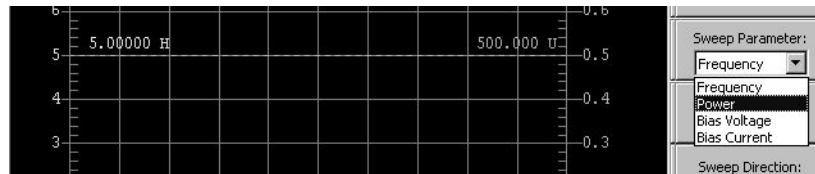

NOTE

Setting sweep parameter to **Power** automatically sets sweep type to Linear.

Setting the Source Mode and CW Frequency

- Step 1. Click **Source...** on the **Stimulus** menu (Figure 3-15).
- Step 2. Select **Current** in the **Osc Unit** box (Figure 3-16).
- Step 3. Select **CW Freq** box and type **[1] [0] [0] [M] [Enter]** on the keyboard (Figure 3-22).

Figure 3-22

Step 3



Setting the Sweep Range (Oscillator Level)

- Step 1.** Click **Start/Stop...** on the **Stimulus** menu (Figure 3-18).
- Step 2.** Select **Start** box and type **[1] [0] [0] [u] [Enter]** on the keyboard (Figure 3-23).
- Step 3.** Select **Stop** box and type **[1] [0] [m] [Enter]** on the keyboard (Figure 3-23).

Figure 3-23

Steps 2, 3

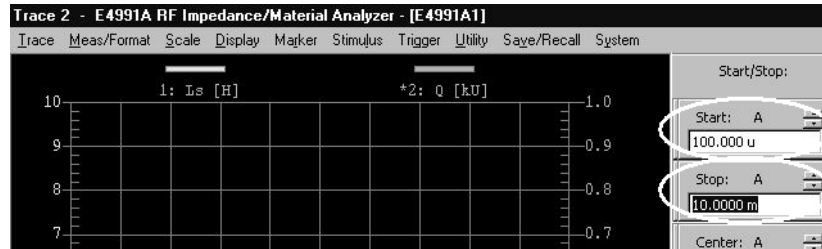

NOTE

When entering the current unit with the keyboard, type **[u]** for μA and **[m]** for mA.

(4) Dc Bias (Current) Characteristics of Ls-Q (Option 001)

When Option 001 is installed in the E4991A, dc bias can be applied to the DUT. First change the measurement conditions from the initial state of the E4991A as shown in Table 3-6.

NOTE

When measuring dc bias characteristics, you must set dc bias to ON after connecting the DUT to the test fixture. For the setting procedure, refer to “Applying dc Bias (Option 001)” on page 82.

Table 3-6

Setup example for this measurement

Parameter setting		Setup example	Initial state
Measurement parameters	Trace 1	Ls	Z
	Trace 2	Q	θ_z
Display formats	Trace 1	Linear	Linear
	Trace 2	Linear	Linear
Measurement points		201 points	201 points
Sweep parameter		dc bias (current)	Frequency
Sweep type		Linear	Linear
Source mode		Current	Voltage
Oscillator level		1 mA	100 mV (2 mA)
CW frequency		100 MHz	1 MHz
Sweep range (frequency)		100 μ A to 50 mA	100 μ A to 100 μ A

Presetting the E4991A

Preset the E4991A to the initial state by referring to the procedure described in “Presetting the E4991A” on page 46.

Setting the Measurement Parameters and Display Formats

Perform setup in the same way as “Setting the Measurement Parameters and Display Formats” on page 55.

Setting the Measurement Points, Sweep Parameter and Sweep Type

- Step 1.** Click **Sweep Setup...** on the **Stimulus** menu (Figure 3-13).
- Step 2.** **Number Of Points** box is set to **201** in the initial state.
- Step 3.** Select **Bias Current** in the **Sweep Parameter** box (Figure 3-24).

Figure 3-24

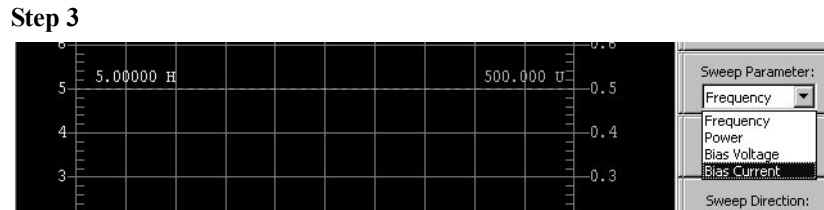

NOTE

Setting sweep parameter to **Bias Current (Voltage)** automatically sets sweep type to Linear.

Setting the Source Mode, Oscillator Level and CW Frequency

- Step 1.** Click **Source...** on the **Stimulus** menu (Figure 3-15).
- Step 2.** Select **Current** in the **Osc Unit** box (Figure 3-16).
- Step 3.** Select **Osc Level** box and type **[1] [m] [Enter]** on the keyboard (Figure 3-17).
- Step 4.** Select **CW Freq** box and type **[1] [0] [0] [M] [Enter]** on the keyboard (Figure 3-22).

Setting the Sweep Range (dc Bias)

- Step 1.** Click **Start/Stop...** on the **Stimulus** menu (Figure 3-18).
- Step 2.** **Start** box is set to **1 0 0 u A** in the initial state (Figure 3-25).
- Step 3.** Select **Stop** box and type **[5] [0] [m] [Enter]** on the keyboard (Figure 3-25).

Figure 3-25

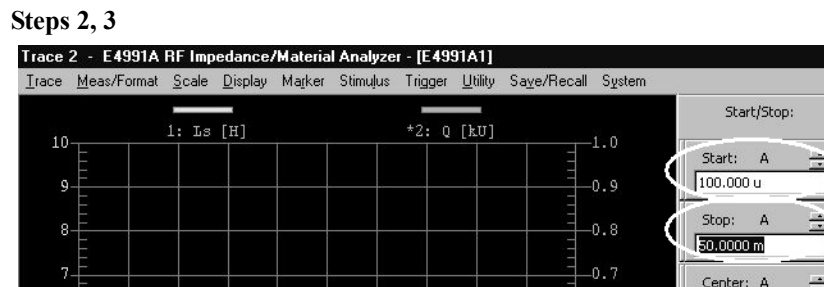

STEP 3. Calibration

After turning the power ON, be sure to connect the 0 S (OPEN), 0 Ω (SHORT), 50 Ω (LOAD), and low-loss capacitor (optional) to the calibration reference plane and perform calibration. The calibration reference plane of the E4991A is usually the 7-mm terminal of the test head. This step is done to ensure that the calibration reference plane meets the specified measurement accuracy.

Calibration and fixture compensation data are measured at either fixed frequency points (initial setting) and user-defined points. When selecting fixed frequency point calibration, the types of power points at which data are measured include fixed power points and user-defined power points (Table 3-7). In this section, calibration is performed at fixed frequency/fixed power points.

Table 3-7 Types of measurement points for calibration/fixture compensation data

Measurement points for calibration/fixture compensation data		Calibration/fixture compensation data when sweep conditions are changed	Accuracy of measurement	Time required to measure data
Fixed frequency points	Fixed power points	Valid	Good	Long
	User-defined power points	Valid (except when the OSC level setting is changed)	Good	↑
User-defined frequency/user-defined power points		Invalid	Better	Short

NOTE When performing oscillator level sweep and dc bias sweep, calibration and fixture compensation at the fixed frequency/user-defined power points cannot be selected.

The basic procedure for the calibration is illustrated in Figure 3-26.

Figure 3-26 Basic flow for calibration

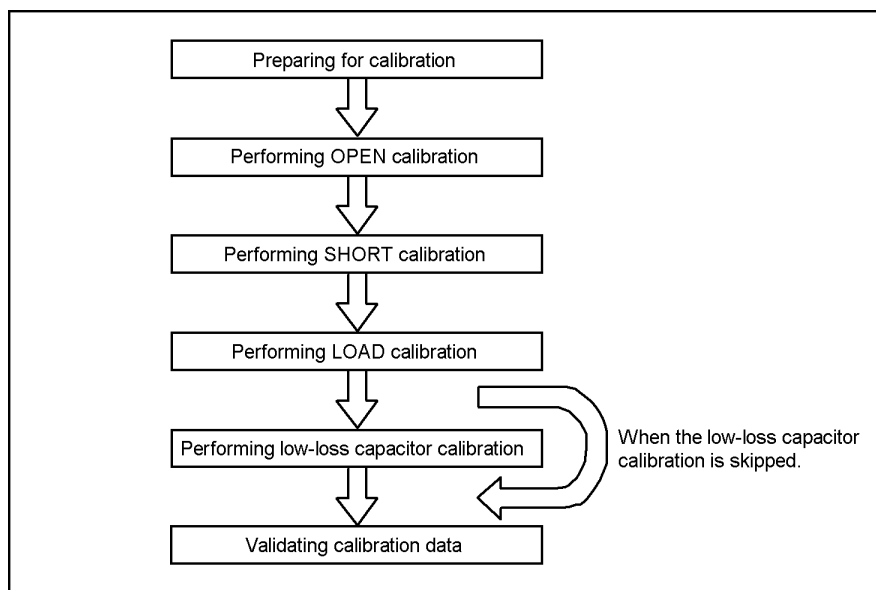

E4991aqe012

Procedure for Using Mouse and Keyboard

Preparing for Calibration

Prepare for calibration by following these steps.

Step 1. Click **Cal/Comp...** on the **Stimulus** menu (Figure 3-27)

Figure 3-27

Step 1

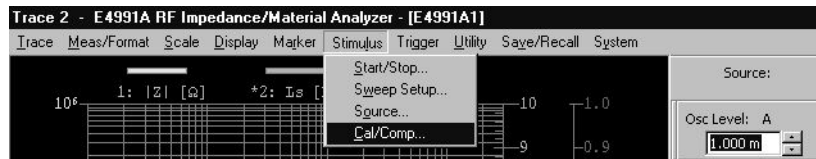

Step 2. Click the **Cal Menu** button (Figure 3-28).

Figure 3-28

Step 2

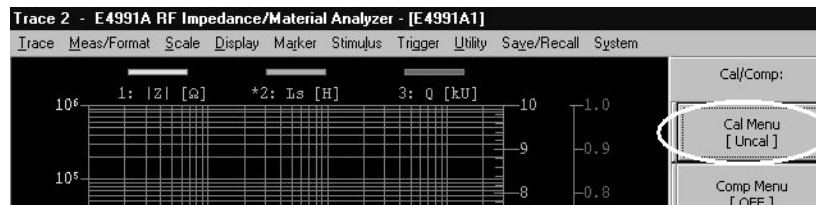

Step 3. Select **Fixed Freq&Pwr** in the **Cal Type** box (Figure 3-29).

Figure 3-29

Step 3

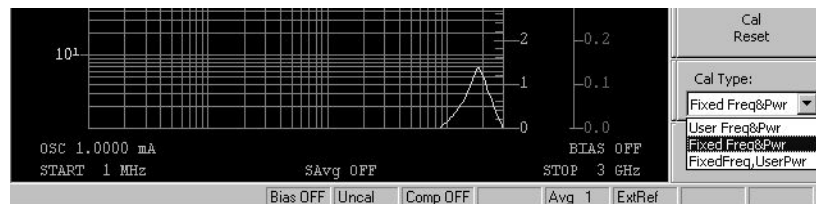

Table 3-8

Cal Type box settings and measurement points for calibration/fixture compensation data

Cal Type box	Measurement points for calibration/fixture compensation data (Table 3-7)
User Freq&Pwr	User-defined frequency/user-defined power points
Fixed Freq&Pwr	Fixed frequency/fixed power points
FixedFreq,UserPwr	Fixed frequency/user-defined power points

Basic Operations for RF Devices Measurement
STEP 3. Calibration

Step 4. As shown in Figure 3-30, turn the 7-mm connector nut of the test head clockwise until the 7-mm connector sleeve is fully extended.

Figure 3-30

Extending 7-mm connector sleeve

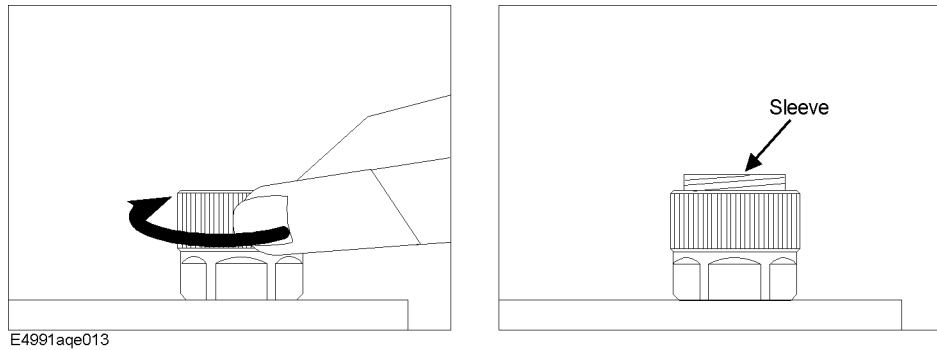

Measuring OPEN Calibration Data

Use the 0 S (OPEN) standard to perform OPEN calibration by following these steps.

Step 1. As shown in Figure 3-31, turn the 0 S (OPEN) standard clockwise with the provided torque wrench to connect it securely to the 7-mm terminal.

Figure 3-31

Connecting 0 S (OPEN) standard

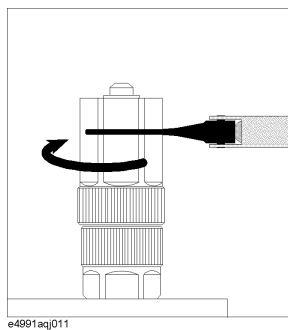

Step 2. Click the **Meas Open** button (Figure 3-32).

Figure 3-32

Step 2

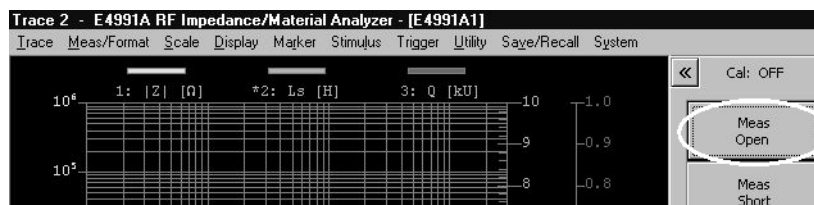

Step 3. A √ mark appears on the left side of the **Meas Open** button upon completion of the OPEN calibration data measurement.

Step 4. Turn the 0 S (OPEN) standard counterclockwise to remove it.

NOTE

Clicking the **Abort Cal Meas** button during measurement of OPEN, SHORT, LOAD, and LOW-LOSS CAPACITOR (optional) calibration data stops the measurement.

Measuring SHORT Calibration Data

Use the 0 Ω (SHORT) standard to perform SHORT calibration by following these steps.

Step 1. As shown in Figure 3-33, turn the 0 Ω (SHORT) standard clockwise with the provided torque wrench to connect it securely to the 7-mm terminal.

Figure 3-33

Connecting 0 Ω (SHORT) standard

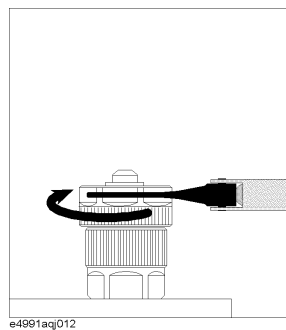

Step 2. Click the **Meas Short** button (Figure 3-34).

Figure 3-34

Step 2

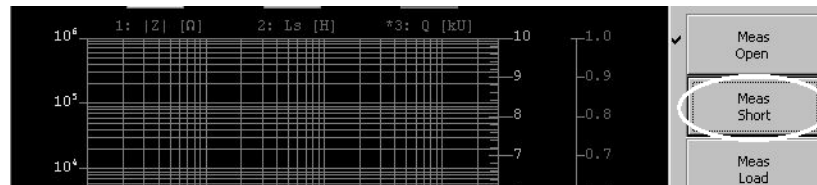

Step 3. A \checkmark mark appears on the left side of the **Meas Short** button upon completion of the SHORT calibration data measurement.

Step 4. Turn the 0 Ω (SHORT) standard counterclockwise to remove it.

Basic Operations for RF Devices Measurement
STEP 3. Calibration

Measuring LOAD Calibration Data

Use the 50 Ω (LOAD) standard to perform LOAD calibration by following these steps.

- Step 1.** As shown in Figure 3-35, turn the outside connector nut of the 50 Ω (LOAD) standard counterclockwise to fully retract the inside connector sleeve.

Figure 3-35

Retracting connector sleeve of 50 Ω (LOAD) standard

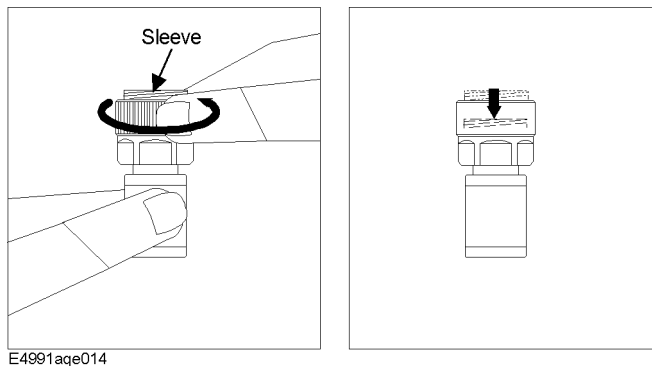

- Step 2.** As shown in Figure 3-36, turn the 50 Ω (LOAD) standard clockwise with the provided torque wrench to connect it securely to the 7-mm terminal.

Figure 3-36

Connecting 50 Ω (LOAD) standard

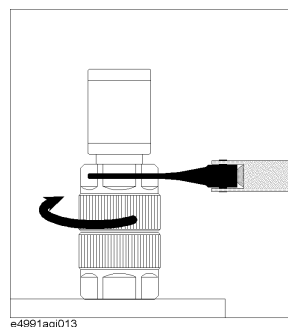

- Step 3.** Click the **Meas Load** button (Figure 3-37).

Figure 3-37

Step 3

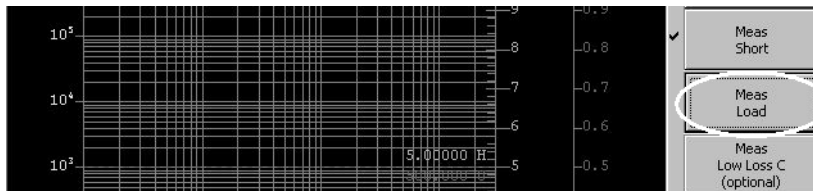

- Step 4.** A √ mark appears on the left side of the **Meas Load** button upon completion of the LOAD calibration data measurement.

- Step 5.** Turn the 50 Ω (LOAD) standard counterclockwise to remove it.

Measuring LOW-LOSS CAPACITOR Calibration Data

The LOW-LOSS CAPACITOR calibration should be performed for high Q (or low D: dissipation factor) measurements at high frequencies. The LOW-LOSS CAPACITOR calibration allows high accuracy for phase measurements. This calibration can be skipped if you do not need it for your purposes.

Step 1. As shown in Figure 3-38, turn the LOW-LOSS CAPACITOR clockwise with the provided torque wrench to connect it securely to the 7-mm terminal.

CAUTION

Do not turn the nob of the LOW-LOSS CAPACITOR. Lightly hold the nob to prevent the inner coaxial electrodes from moving when turning the outer connector nut of the LOW-LOSS CAPACITOR.

Figure 3-38

Connecting LOW-LOSS CAPACITOR

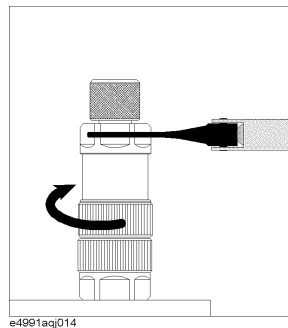

Step 2. Click the **Meas Low Loss C** button (Figure 3-39).

Figure 3-39

Step 2

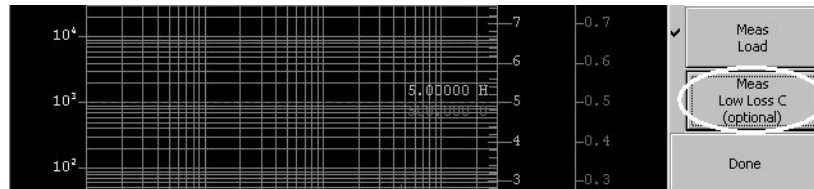

Step 3. A ✓ mark appears on the left side of the **Meas Low Loss C** button upon completion of the LOW-LOSS CAPACITOR calibration data measurement.

Step 4. Turn the LOW-LOSS CAPACITOR counterclockwise to remove it.

Basic Operations for RF Devices Measurement

STEP 3. Calibration

Validating Calibration Data

After completing all calibration data measurement, you should use the E4991A to calculate the calibration coefficient from the measured calibration data. The coefficient is automatically saved to the internal memory.

- Step 1.** Confirm that all of the calibration data measurement is completed and then click the **Done** button (Figure 3-40).

Figure 3-40

Step 1

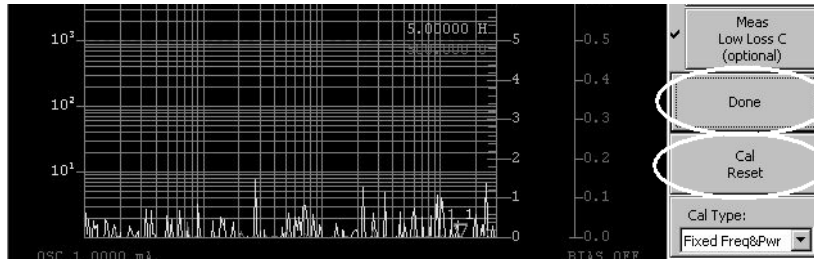

NOTE

Clicking the **Cal Reset** button (Figure 3-40) resets the calibration data. Turning the power OFF also resets the calibration data.

- Step 2.** Verify that the display below the **Cal Menu** button changes to **[Fix]** and the display of the status bar on the bottom of the screen changes to “Cal Fix” (Figure 3-41).

Figure 3-41

Display of status bar when completing calibration

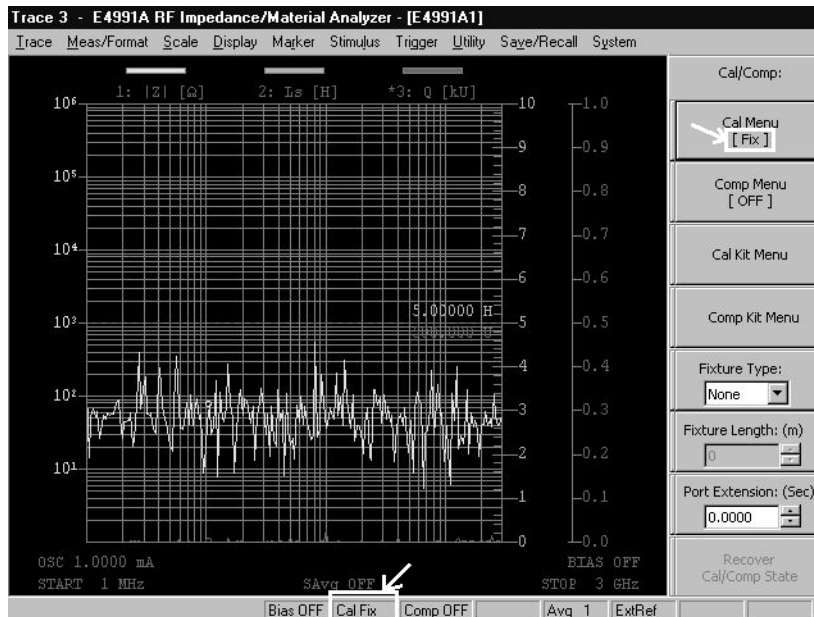









NOTE

Clicking the **Recover Cal/Comp State** button recovers the calibration data that became invalid. For details, refer to Chapter 4, “Calibration and Compensation” in the *E4991A Operation Manual*.

Procedure for Using Front Panel Keys



Preparing for Calibration

Prepare for calibration by following these steps.



- Step 1.** Press the **[Cal/Compen]** key in the **STIMULUS** block.
- Step 2.** Press the  or  key in the **ENTRY/NAVIGATION** block to move the cursor to the **Cal Menu** button and then press the  key (Figure 3-28).
- Step 3.** Press the  or  key to move the cursor to the **Cal Type** box and then press the  key to open the list. Next press the  or  key to move the cursor to **Fixed Freq&Pwr** and press the  key (Figure 3-29).
- Step 4.** Turn the 7-mm connector nut of the test head clockwise until the connector sleeve is fully extended (Figure 3-30).

Measuring OPEN Calibration Data

Use the 0 S (OPEN) standard to perform OPEN calibration by following the procedure described below.

- Step 1.** Turn the 0 S (OPEN) standard clockwise with the provided torque wrench to connect it securely to the 7-mm terminal (Figure 3-31).
- Step 2.** Press the  or  key to move the cursor to the **Meas Open** button and then press the  key (Figure 3-32).
- Step 3.** A \surd mark appears on the left side of the **Meas Open** button upon completion of the OPEN calibration data measurement.
- Step 4.** Turn the 0 S (OPEN) standard counterclockwise to remove it.



NOTE

The measurement of OPEN, SHORT, LOAD, or LOW-LOSS CAPACITOR (optional) calibration data can be stopped by pressing the  or  key to move the cursor to the **Abort Cal Meas** button and the pressing the  key during measurement.

STEP 3. Calibration



Measuring SHORT Calibration Data

Use the 0 Ω (SHORT) standard to perform SHORT calibration by following these steps.

- Step 1.** Turn the 0 Ω (SHORT) standard clockwise with the provided torque wrench to connect it securely to the 7-mm terminal (Figure 3-33).
- Step 2.** Press the  or  key to move the cursor to the **Meas Short** button and then press the  key (Figure 3-34).
- Step 3.** A \checkmark mark appears on the left side of the **Meas Short** button upon completion of the SHORT calibration data measurement.
- Step 4.** Turn the 0 Ω (SHORT) standard counterclockwise to remove it.



Measuring LOAD Calibration Data

Use the 50 Ω (LOAD) standard to perform LOAD calibration by following these steps.

- Step 1.** Turn the outside connector nut of the 50 Ω (LOAD) standard counterclockwise to fully retract the inside connector sleeve (Figure 3-35).
- Step 2.** Turn the 50 Ω (LOAD) standard clockwise with the provided torque wrench to connect it securely to the 7-mm terminal (Figure 3-36).
- Step 3.** Press the  or  key to move the cursor to the **Meas Load** button and then press the  key (Figure 3-37).
- Step 4.** A \checkmark mark appears on the left side of the **Meas Load** button upon completion of the LOAD calibration data measurement.
- Step 5.** Turn the 50 Ω (LOAD) standard counterclockwise to remove it.



Measuring LOW-LOSS CAPACITOR Calibration data

The LOW-LOSS CAPACITOR calibration should be performed for high Q (or low D: dissipation factor) measurements at high frequencies. The LOW-LOSS CAPACITOR calibration allows high accuracy for phase measurements. This calibration can be skipped if you do not need it for your purposes.



- Step 1.** Turn the LOW-LOSS CAPACITOR clockwise with the provided torque wrench to connect it securely to the 7-mm terminal (Figure 3-38).
- Step 2.** Press the  or  key to move the cursor to the **Meas Low Loss C** button and then press the  key (Figure 3-39).
- Step 3.** A \checkmark mark appears on the left side of the **Meas Low Loss C** button upon completion of the LOW-LOSS CAPACITOR calibration data measurement.
- Step 4.** Turn the LOW-LOSS CAPACITOR counterclockwise to remove it.

Validating Calibration Data

After completing all calibration data measurement, you should use the E4991A to calculate the calibration coefficient from the measured calibration data. The coefficient is automatically saved to the internal memory.



- Step 1.** Confirm that all of the calibration data measurement is completed and then press the  or  key to move the cursor to the **Done** button and press the  key (Figure 3-40).

NOTE

The calibration data can be reset by pressing the  or  key to move the cursor to the **Cal Reset** button and then pressing the  key (Figure 3-40). Turning the power OFF also resets the calibration data.

-
- Step 2.** Verify that the display below the **Cal Menu** button changes to **[Fix]** and the display of the status bar on the bottom of the screen changes to “Cal Fix” (Figure 3-41).

NOTE

The calibration data that became invalid are recovered by pressing the  or  key to move the cursor to the **Recover Cal/Comp State** button and then pressing the  key. For details, refer to Chapter 4, “Calibration and Compensation” in the *E4991A Operation Manual*.

STEP 4. Connecting Test Fixture

Connect the test fixture to the 7-mm terminal of the test head by following these steps. In this section, the method of connecting the 16197A test fixture is described as an example. When using other test fixtures, refer to the *Operation Manual* of the test fixture.

- Step 1.** As shown in Figure 3-42, turn the 7-mm connector nut of the test head counterclockwise until the connector sleeve is fully retracted.

Figure 3-42

Retracting 7-mm connector sleeve

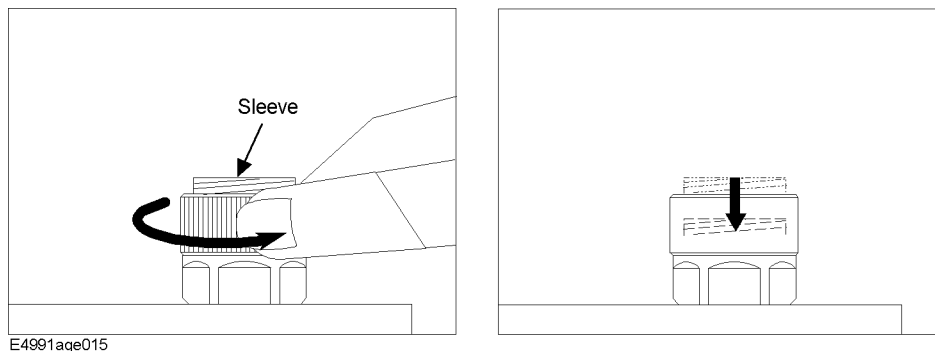

- Step 2.** Set the two mount posts of the test head to the two holes of the test fixture and set the 7-mm terminal of the test head to 7-mm connector of the test fixture (Figure 3-43: 2).
- Step 3.** Turn the 7-mm connector nut of the test head counterclockwise to connect it securely (Figure 3-43: 3). Use both hands to turn the connector nut because the space between the test head and the test fixture is narrow.

Figure 3-43

Connecting test fixture (16197A)

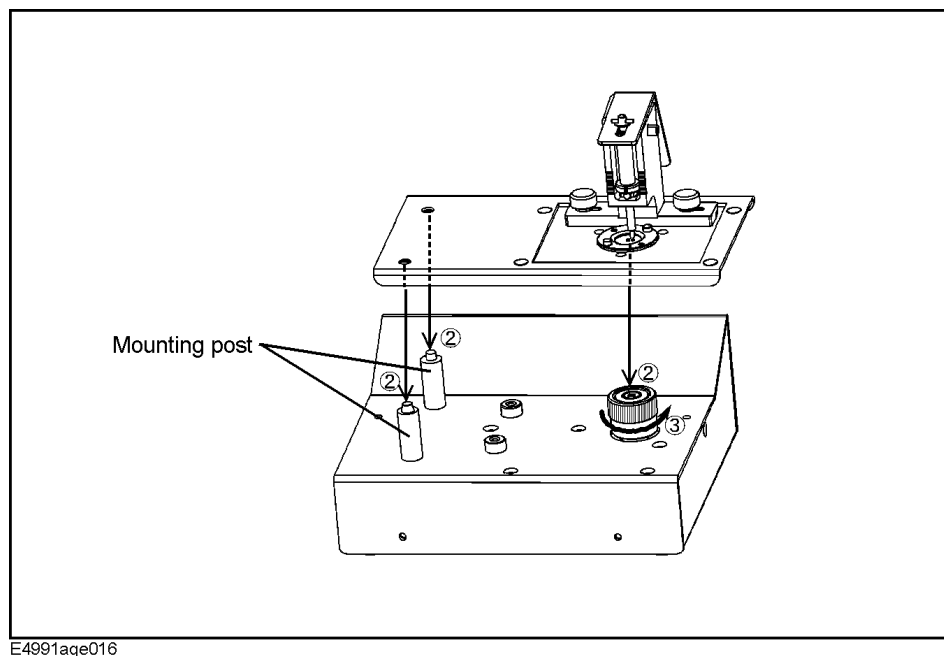

STEP 5. Setting Electrical Length

Phase shift produces measurement error in the test fixture's transmission line because the wavelength at RF frequency is very short relative to the transmission line's physical length. To remove this measurement error, you must set the electrical length of the test fixture (electrical length from 7-mm terminal to DUT connection plane).

For the E4991A, electrical length values are individually registered for standard Agilent test fixtures. By selecting the model number of a test fixture, the electrical length is set automatically. When connecting test fixtures custom-made by the user, it is necessary to input the electrical length values.

Procedure for Using Mouse and Keyboard

Step 1. Click **Cal/Comp...** on the **Stimulus** menu (Figure 3-27).

Step 2. Set the electrical length by either of the following methods.

- o Using a test fixture that is registered

Select the model number of the test fixture in the **Fixture Type** box (Figure 3-44).

Figure 3-44

Selecting test fixture

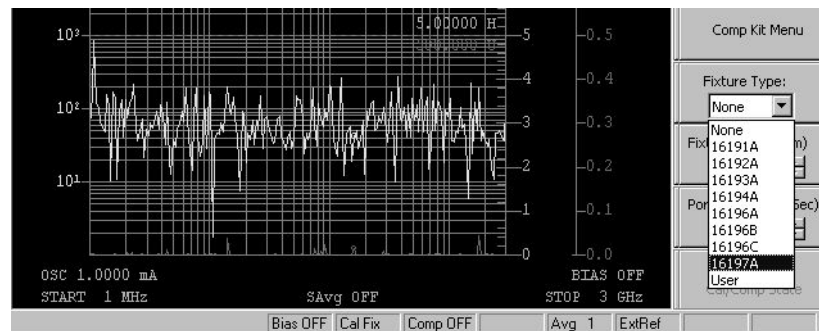

- o Using a test fixture that is made by the user

Select **User** in the **Fixture Type** box. Then select the **Fixture Length** box and input the electrical length with the keyboard. When inputting the electrical length of 14 mm, for example, type **[1] [4] [m] [Enter]** (Figure 3-45).

Figure 3-45

Inputting electrical length

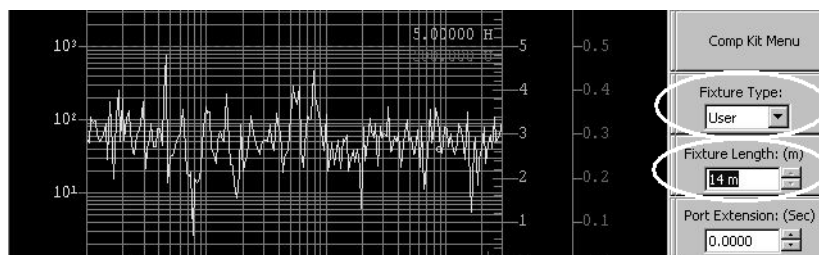

Basic Operations for RF Devices Measurement
STEP 5. Setting Electrical Length

Step 3. After setting the electrical length, confirm that “Del 14m” is shown in the status bar on the bottom of the screen (Figure 3-46).

Figure 3-46

Display of status bar when setting electrical length



NOTE

“Del xx” indicates Delay xx mm. This is a status display showing that the electrical length of xx mm is set.

Table 3-9 Electrical lengths of standard test fixtures







Model	16191A	16192A	16193A	16196A	16196B	16196C	16197A
Electrical length	14.0 mm	11.0 mm	14.0 mm	26.2 mm	26.9 mm	27.1 mm	14.0 mm

Procedure for Using Front Panel Keys











Step 1. Press the **[Cal/Compen]** key in the **STIMULUS** block.

Step 2. Set the electrical length by either of the following methods.

- o Using the a fixture that is registered

Press the  or  key in the **ENTRY/NAVIGATION** block to move the cursor to the **Fixture Type** box and then press the  key to open the list. Then press the  or  key to move the cursor to model number of test fixture to be used and press the  key (Figure 3-44).

- o Using a test fixture that is made by the user

Press the  or  key to move the cursor to the **Fixture Type** box and then press the  key to open the list. Press the  or  key to move the cursor to **User** and press the  key. Next, press the  or  key to move the cursor to the **Fixture Length** box and input the electrical length with the numerical keys. When inputting the electrical length of 14 mm, for example, press the , ,  keys in this order (Figure 3-45).

Step 3. After setting the electrical length, confirm that “Del 14m” is shown in the status bar on the bottom of the screen (Figure 3-46).

STEP 6. Fixture Compensation

The E4991A has a specified measurement accuracy at the 7-mm terminal (calibration reference plane) of a test head. However, in actual measurement, a measurement circuit (test fixture) is placed between the DUT connection terminal and the 7-mm terminal, and the influence of this circuit is included in the measurement result as a part of the DUT. Therefore, fixture compensation must be performed to remove the parasitic error that exists between the DUT connection terminal and the 7-mm terminal.

This section describes fixture compensation by using the 16197A as an example. When using other test fixtures, follow the procedure described in the *Operation Manual* of the test fixture.

Procedure for Using Mouse and Keyboard

Measuring OPEN Compensation Data (16197A)

Perform OPEN compensation to correct stray admittance due to the test fixture.

- Step 1.** Set the DUT connection terminal of the test fixture to the OPEN state by following the procedure illustrated in Figure 3-47. When using other test fixtures, follow the procedure described in the *Operation Manual* of the test fixture.

Figure 3-47 OPEN state (16197A)

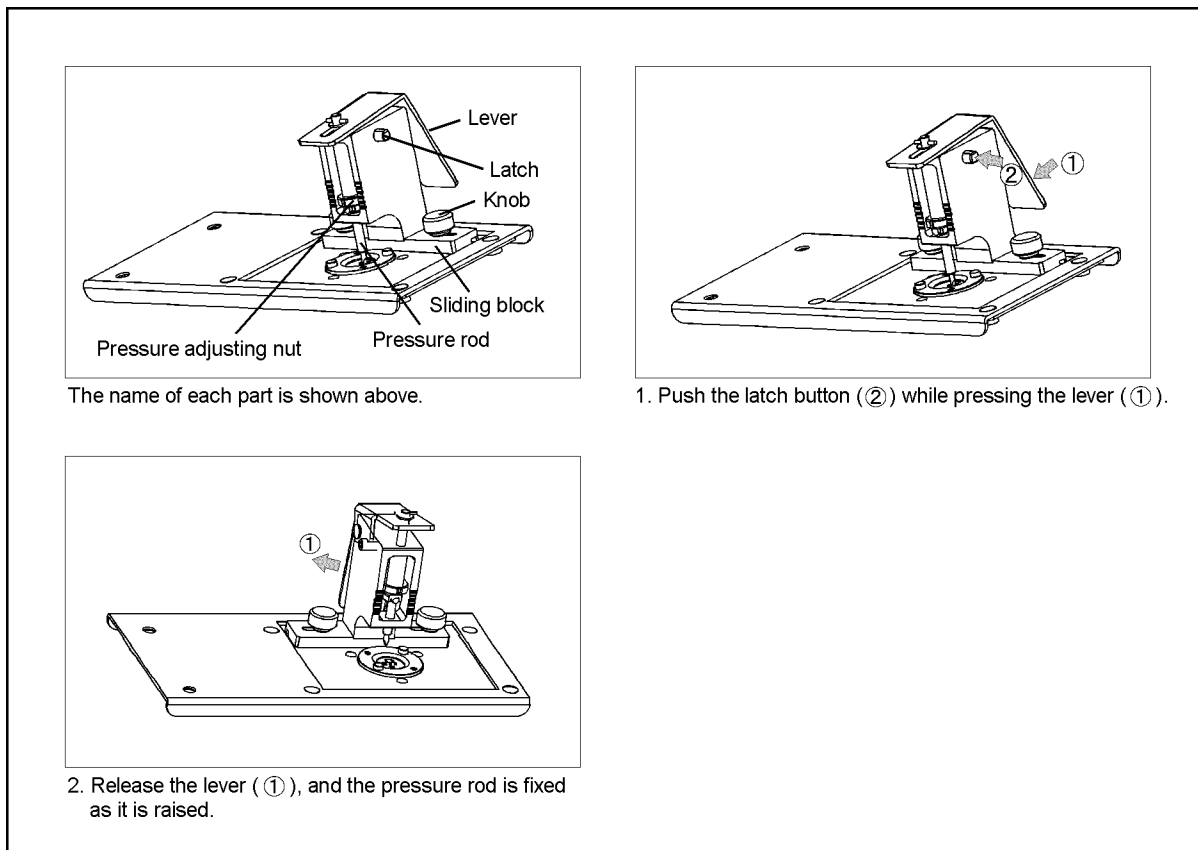

e4991aqe039

Basic Operations for RF Devices Measurement
STEP 6. Fixture Compensation

Step 2. Click **Cal/Comp...** on the **Stimulus** menu (Figure 3-27).

Step 3. Click the **Comp Menu** button (Figure 3-48)

Figure 3-48

Step 3

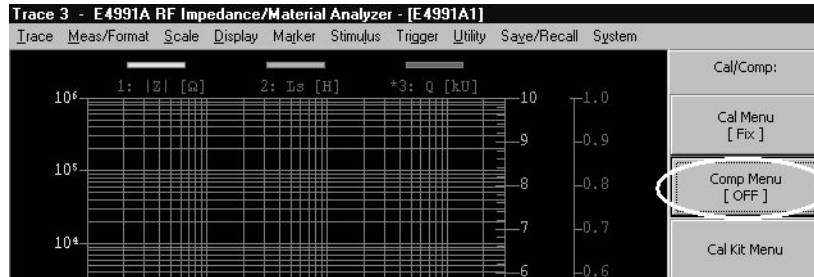

Step 4. Click the **Meas Open** button (Figure 3-49).

Figure 3-49

Step 4

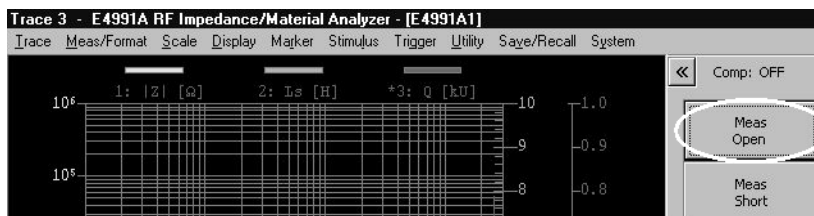

Step 5. A \surd mark appears on the left side of the **Meas Open** button upon completion of the OPEN compensation data measurement.

NOTE

Clicking the **Abort Comp Meas** button during measurement of OPEN or SHORT compensation data stops the measurement.

Measuring SHORT Compensation Data (16197A)

Perform SHORT compensation to correct residual impedance due to the test fixture.

Step 1. Connect a short device to the test fixture. Follow the procedure given in Figure 3-50 to set the DUT connection terminal of the test fixture to the SHORT state. When using other test fixtures, follow the procedure described in the *Operation Manual* of the test fixture.

Figure 3-50 SHORT state (16197A)

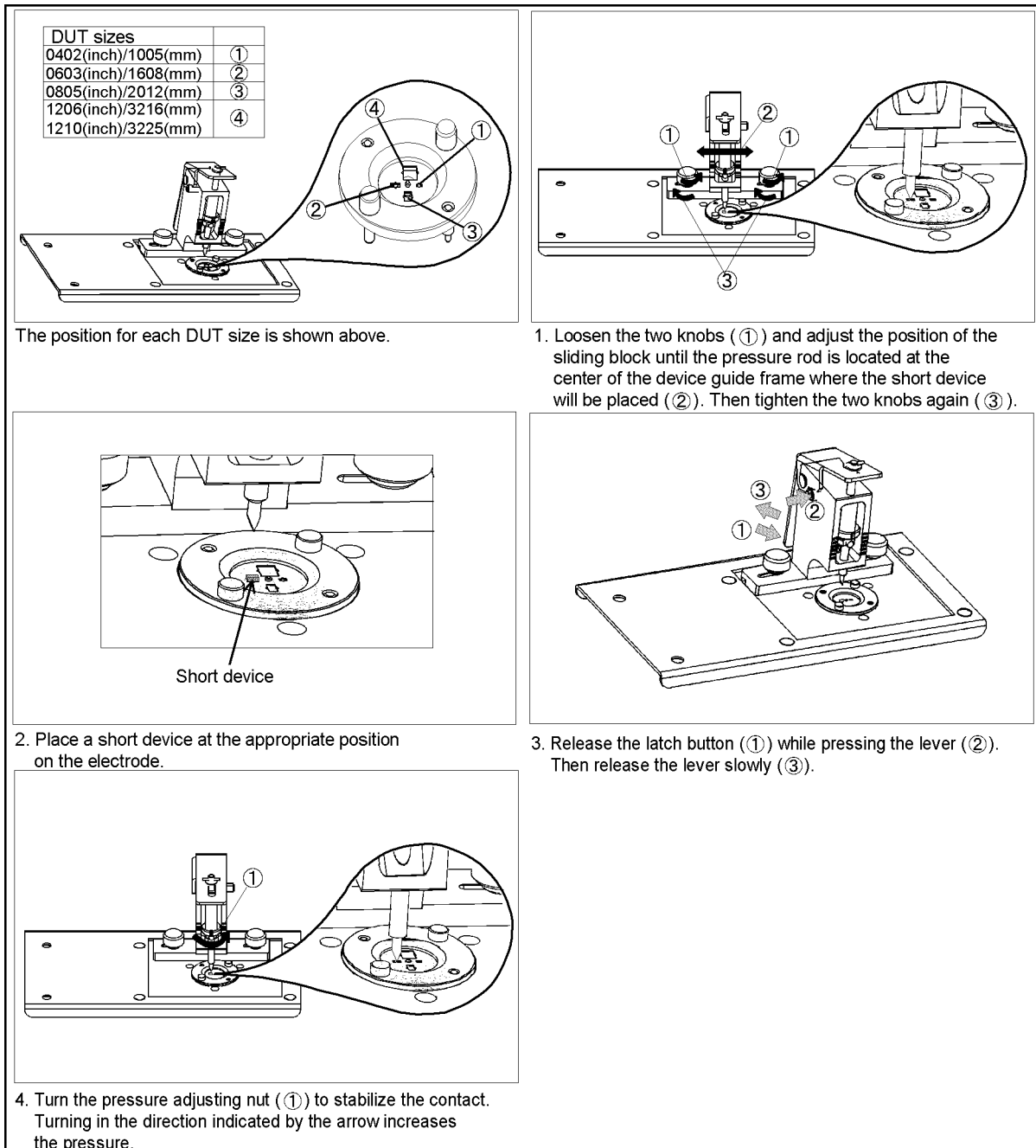

e4991aqe040

Basic Operations for RF Devices Measurement

STEP 6. Fixture Compensation

Step 2. Click the **Meas Short** button (Figure 3-51).

Figure 3-51

Step 2

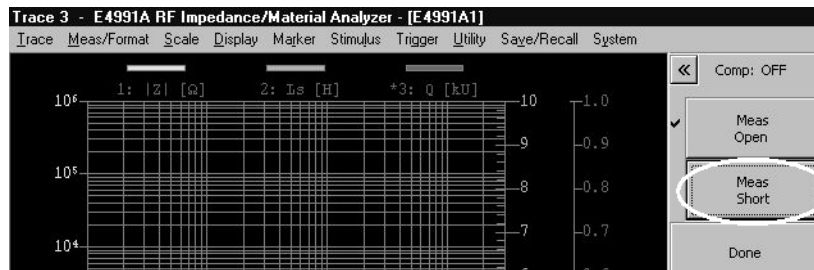

Step 3. A ✓ mark appears on the left side of the **Meas Short** button upon completion of the SHORT compensation data measurement.

Validating Fixture Compensation Data

After completing all fixture compensation data measurement, you should use the E4991A to calculate the fixture compensation coefficient from the measured fixture compensation data. The coefficient is automatically saved to the internal memory.

Step 1. Confirm that all of the fixture compensation data measurement is completed and then click the **Done** button (Figure 3-52).

Figure 3-52

Step 1

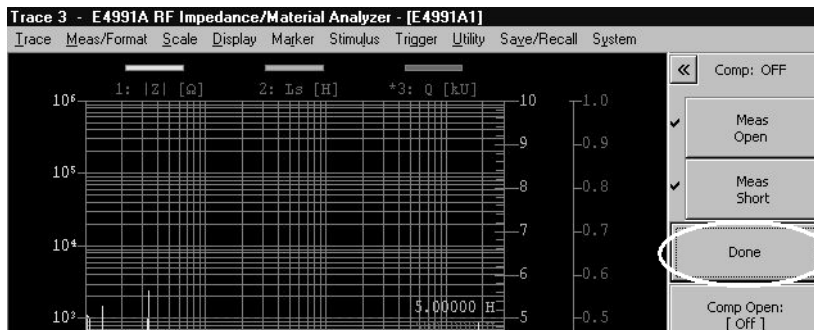

- Step 2.** Verify that the display below the **Comp Menu** button changes to **[ON]** and the display of the status bar on the bottom of the screen changes to “Comp ON” (Figure 3-53).

Figure 3-53

Display of status bar when completing fixture compensation

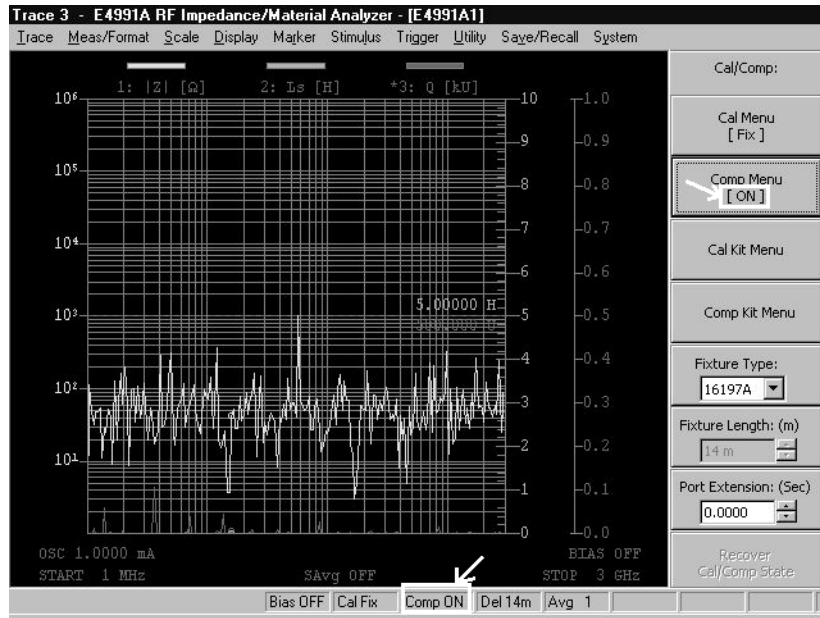

Checking SHORT Compensation Data

After completing the fixture compensation, use the marker function to check that the SHORT compensation data have been measured correctly.

- Step 1.** Specify the trace of the measurement parameter $|Z|$ (in this example it is Trace 1) as the active trace (* mark) as shown in Figure 3-9 and Figure 3-10. When the parameter $|Z|$ does not exist in the measurement parameter as in measurement conditions (3) and (4), perform the check after converting the measurement parameter of Trace 1 to the parameter $|Z|$. After the check, return it to the previous measurement parameter.
- Step 2.** Click **Autoscale** on the **Scale** menu (Figure 3-54).

Figure 3-54

Step 2

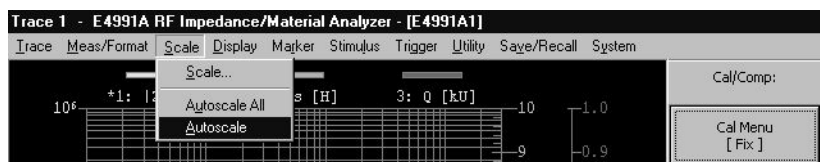

3. Basic Operations for RF
 Devices Measurement

Basic Operations for RF Devices Measurement

STEP 6. Fixture Compensation

Step 3. Click **Marker...** on the **Marker** menu (Figure 3-55).

Figure 3-55

Step 3

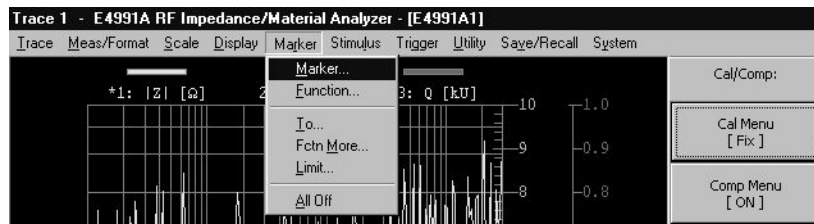

Step 4. Move the cursor with the mouse to the **Stimulus** box (Figure 3-56).

Figure 3-56

Step 4

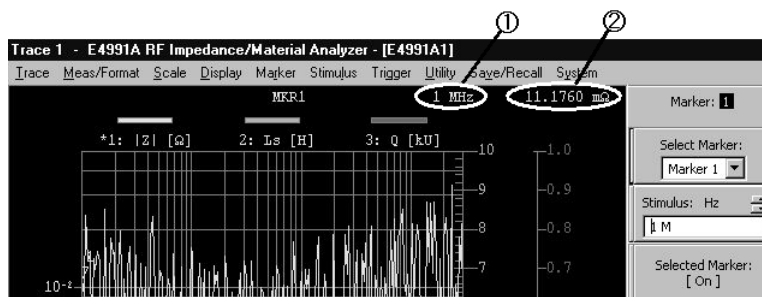

1: Stimulus value
2: Trace value

Step 5. Turn the rotary knob () in the **ENTRY/NAVIGATION** block to check that trace values of measurement parameter |Z| (Figure 3-56: 2) are equal to or less than 50 mΩ for all stimulus values (Figure 3-56: 1). If not, place the short device on both electrodes again, align the location of the test fixture's pressure rod, and repeat the fixture compensation.







NOTE

When changing the location of the pressure rod after performing fixture compensation, you must again obtain the fixture compensation data



Procedure for Using Front Panel Keys

Measuring OPEN Compensation Data (16197A)

Perform OPEN compensation to correct stray admittance due to the test fixture.



- Step 1.** Set the DUT connection terminal of the test fixture to the OPEN state by following the procedure described in Figure 3-47. When using other test fixtures, follow the procedure described in the *Operation Manual* of the test fixtures.
- Step 2.** Press the **[Cal/Compen]** key in the **STIMULUS** block.
- Step 3.** Press the  or  key in the **ENTRY/NAVIGATION** block to move the cursor to **Comp Menu** button and then press the  key (Figure 3-48).
- Step 4.** Press the  or  key to move the cursor to the **Meas Open** button and press the  key (Figure 3-49).
- Step 5.** A ✓ mark appears on the left side of the **Meas Open** button upon completion of the OPEN compensation data measurement.

NOTE

The measurement of OPEN and SHORT compensation data can be stopped by pressing the  or  key to move the cursor to the **Abort Comp Meas** button and then pressing the  key during measurement.

Measuring SHORT Compensation Data (16197A)

Perform SHORT compensation to correct residual impedance due to the test fixture.



- Step 1.** Connect a short device to the test fixture. Follow the procedure illustrated in Figure 3-50 to set the DUT connection terminal of the test fixture to the SHORT state. When using other test fixtures, follow the procedure described in the *Operation Manual* of the test fixture.
- Step 2.** Press the  or  key to move the cursor to the **Meas Short** button and then press the  key (Figure 3-51).
- Step 3.** A ✓ mark appears on the left side of the **Meas Short** button upon completion of the SHORT compensation data measurement.

Basic Operations for RF Devices Measurement

STEP 6. Fixture Compensation

Validating Fixture Compensation Data

Upon completion of all fixture compensation data, you should use the E4991A to calculate the fixture compensation coefficient from the measured fixture compensation data. The coefficient is automatically saved to the internal memory.

- Step 1.** Confirm that all compensation data measurement is completed and then press the  or  key to move the cursor to the **Done** button and press the  key (Figure 3-52).
- Step 2.** Verify that the display below the **Comp Menu** button changes to **[ON]** and the display of the status bar on the bottom of the screen changes to “Comp ON” (Figure 3-53).

Checking SHORT Compensation Data

After completing the fixture compensation, use the marker function to check that the SHORT compensation data has been measured correctly.







- Step 1.** Press the **[Trace]** key in the **MEASUREMENT** block to specify the trace of the measurement parameter $|Z|$ (in this example it is Trace 1) as the active trace (* marker). When the parameter $|Z|$ does not exist in the measurement parameter as in measurement conditions (3) and (4), perform the check after converting the measurement parameter of Trace 1 to the parameter $|Z|$. After the check, return it to the previous measurement parameter.
- Step 2.** Press the **[Scale]** key in the **MEASUREMENT** block. Then press the  or  key to move the cursor to the **Autoscale** button and press the  key (Figure 3-57).

Figure 3-57

Step 2

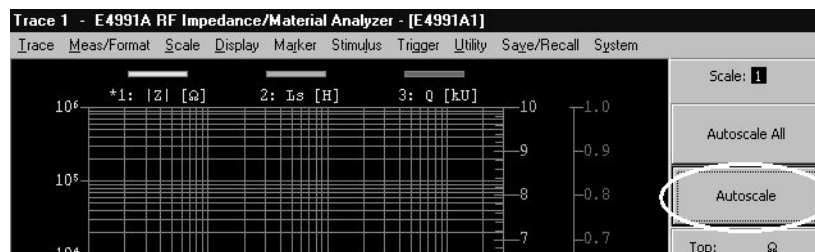

- Step 3.** Press the **[Marker]** key in the **MEASUREMENT** block.
- Step 4.** Press the  or  key to move the cursor to the **Stimulus** box and then press the  key (Figure 3-56).
- Step 5.** Turn the rotary knob () in the **ENTRY/NAVIGATION** block to check that trace values of measurement parameter $|Z|$ (Figure 3-56: 2) are equal to or less than 50 mΩ for all stimulus values (Figure 3-56: 1). If not, place the short device on both electrodes again, align the location of the test fixture’s pressure rod, and repeat the fixture compensation.

NOTE

When changing the location of the pressure rod after performing fixture compensation, you must again obtain the fixture compensation data.

STEP 7. Connecting DUT to Test Fixture

The method of connecting the DUT (1608 (mm) / 0603 (inch) size) to the 16197A is described as an example.

- Step 1.** Push the latch button while pressing the lever to set the DUT connection terminal of the test fixture to the OPEN state.
- Step 2.** Remove the short device.
- Step 3.** Place the DUT in the same way as you placed the short device (Figure 3-50).
- Step 4.** Release the latch button while pressing the lever and then release the lever slowly.

STEP 8. Measuring DUT and Analyzing Measurement Results

Results

After performing calibration and compensation, the measurement results are displayed on the screen when the DUT is connected to the test fixture. If you obtain the correct trace, you can analyze the measurement results by using the marker and the equivalent circuit analysis function. This section describes the procedure by using only the mouse and keyboard.

Applying dc Bias (Option 001)

When selecting “(4) Dc Bias (Current) Characteristics of Ls-Q (Option 001)” on page 58 in “STEP 2. Setting Measurement Conditions”, follow these steps to apply dc bias. For settings of the dc bias source level and dc bias limit, refer to Chapter 3, “Setting Measurement Condition” in the *E4991A Operation Manual*.

WARNING Never touch the DUT or the electrodes of the test fixture while dc bias is applied.

- Step 1. Click **Source...** on the **Stimulus** menu (Figure 3-15).
- Step 2. Click the **Dc Bias** button to change the button's display to **[On]** (Figure 3-58). Making dc bias ON places the measurement in the Hold Mode (mode that does not accept triggers).

Figure 3-58

Steps 2, 3

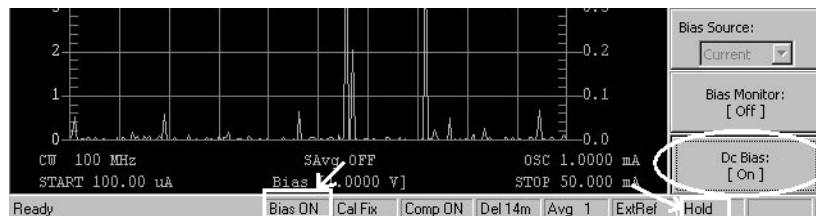

- Step 3. Confirm that the display of the status bar on the bottom of the screen changes to “Bias ON” and the trigger system is in the Hold Mode (Figure 3-58).
- Step 4. Set the trigger to start the measurement.
 - o Perform the single measurement.
 1. Click **Single** on the **Trigger** menu.

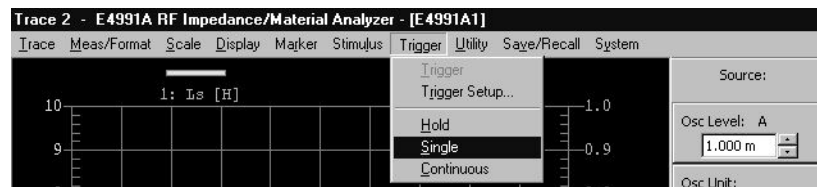

- o Repeat the measurement.
- 1. Click **Continuous** on the **Trigger** menu.

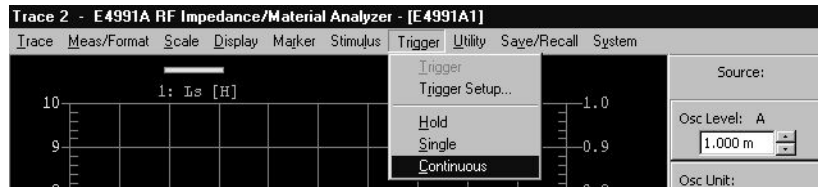

Executing Auto scale

Traces obtained after setting the sweep conditions and measurement parameters may extend beyond the screen because they are too large or too small along the direction of the vertical axis. In this case, the auto scale function can be used to set the appropriate scale. Follow these steps to execute auto scale.

- Step 1.** Specify the trace (measurement parameter) for which you want to execute auto scale as the active trace (Refer to Figure 3-9 and Figure 3-10).
- Step 2.** Click **Autoscale** on the **Scale** menu to execute auto scale (Figure 3-54).
- Step 3.** When it is necessary to execute auto scale for other trace numbers (measurement parameters), repeat the above Steps 1 and 2.

NOTE

Clicking **Autoscale All** on the **Scale** menu executes auto scale for all traces.

- Step 4.** Select **Toolbar Off** on the **System** menu (Figure 3-59) and hide the display of the setup toolbar.

Figure 3-59

Step 4

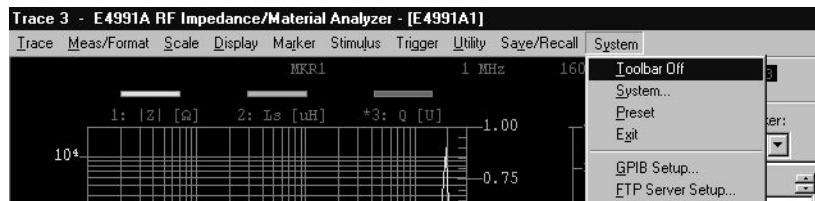

NOTE

The display of the setup toolbar can also be hidden by pressing the **[Cancel/Close]** key in the **ENTRY/NAVIGATION** block.

The measurement results, as shown in Figure 3-60, Figure 3-61, Figure 3-62 and Figure 3-63, can be obtained by executing auto scale for all traces by using the setup examples described in “STEP 2. Setting Measurement Conditions” on page 45.

Figure 3-60

(1) Frequency Characteristics of $|Z|$ -Ls-Q

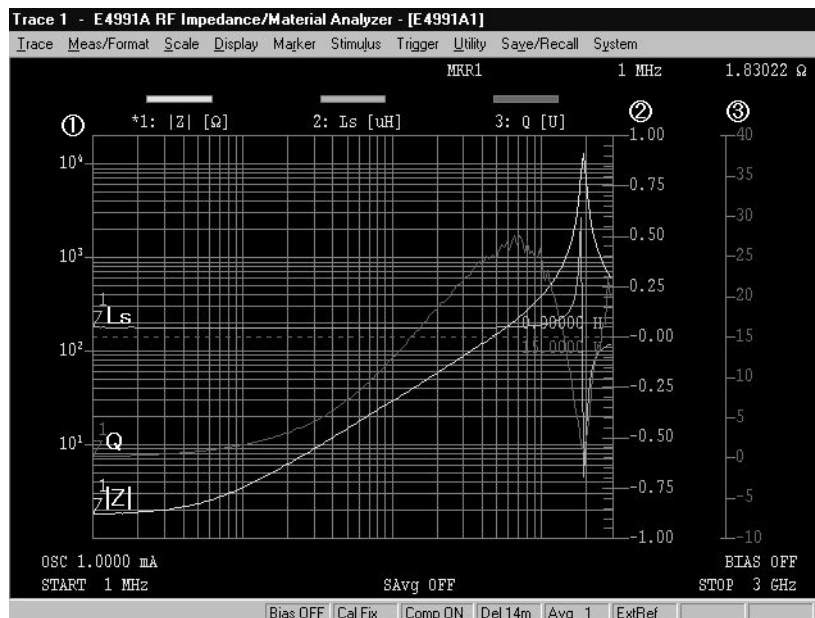

- ① Trace 1 axis : $|Z|$
- ② Trace 2 axis : Ls
- ③ Trace 3 axis : Q

Figure 3-61

(2) Frequency Characteristics of $|Z|$ -R-X

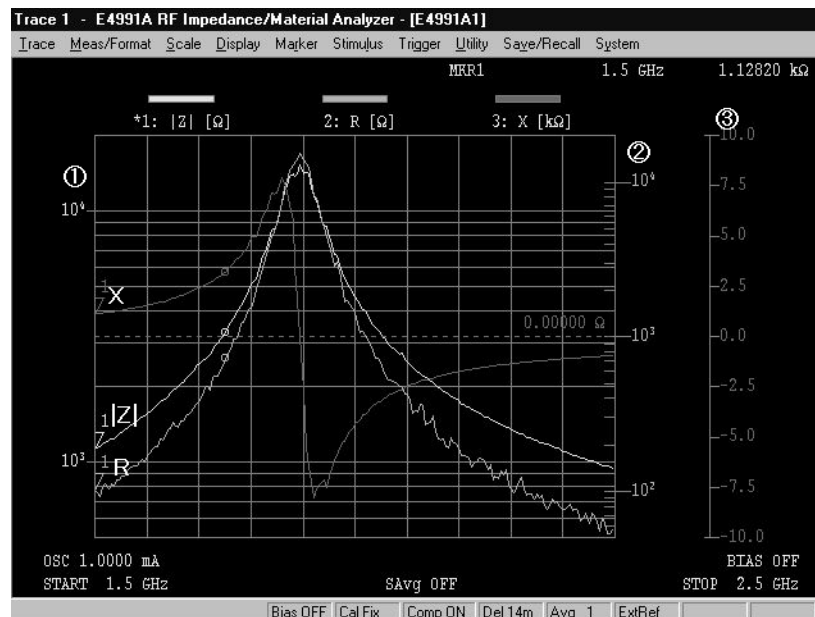

- ① Trace 1 axis : $|Z|$
- ② Trace 2 axis : R
- ③ Trace 3 axis : X

Figure 3-62

(3) Oscillator Level (Current) Characteristics of Ls-Q

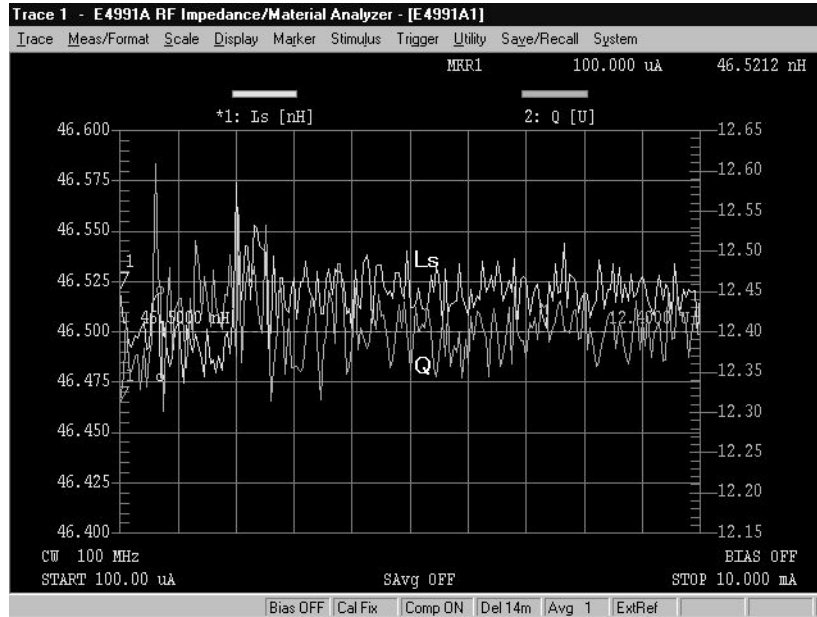

- ① Trace 1 axis : Ls
- ② Trace 2 axis : Q

Figure 3-63

(4) Dc Bias (Current) Characteristics of Ls-Q (Option 001)

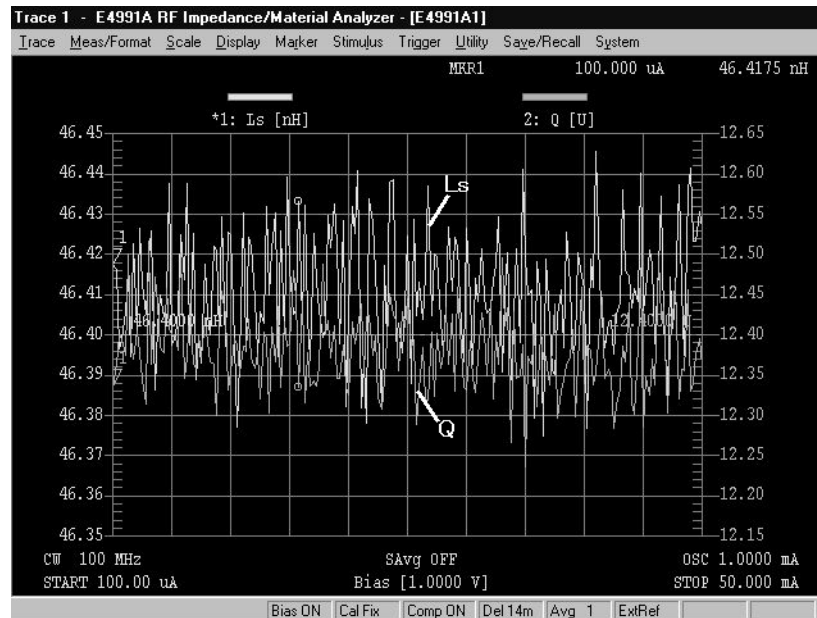

- ① Trace 1 axis : Ls
- ② Trace 2 axis : Q

3. Basic Operations for RF Devices Measurement

Adjusting Scale

When a trace is formed flat, executing auto scale makes the scale value of the grid smaller so that the overall trace can be monitored on the full screen (Figure 3-62 and Figure 3-63). To change the scale to a desired value, adjust it by following these steps. In this section, the scale is adjusted by using the setup example of Figure 3-62, “(3) Oscillator Level (Current) Characteristics of Ls-Q,” on page 85 (when the display format is linear).

NOTE Scaling parameters for the adjustment vary according to the display format. For details about scaling parameters, refer to Chapter 5, “Display Setting” in the *E4991A Operation Manual*.

Step 1. Click **Scale...** on the **Scale** menu.

Figure 3-64

Step 1

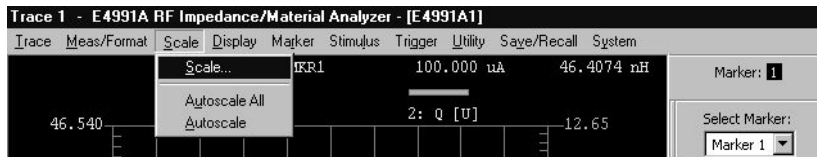

Step 2. Click the **Scale Entry** button and then select the button display of **[Scale/Ref]** or **[Top/Bottom]**.

Step 3. Adjust the scale by inputting the appropriate value in each scaling parameter box.

Table 3-10

Scaling parameters of Scale Entry button displays

Scale Entry button's display	Scaling parameter
Scale Entry: [Scale/Ref]	Full Scale, Ref Val or Ref Pos box
Scale Entry: [Top/Bottom]	Top, Bottom or Ref Pos box

Figure 3-65

Scaling parameters for linear display format

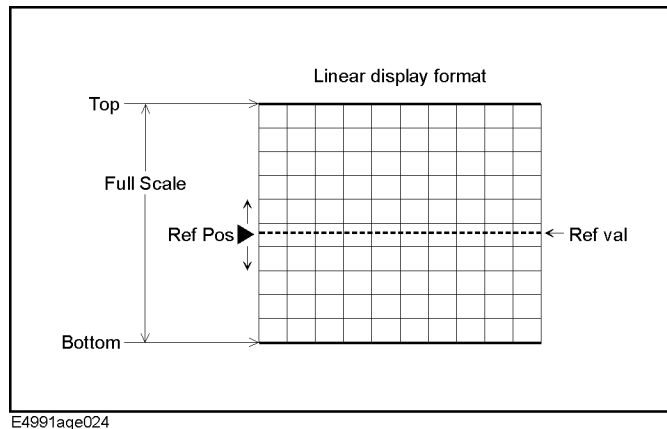

E4991aqe024

Figure 3-66

(3) Oscillator Level (Current) Characteristics of Ls-Q (after adjustment)

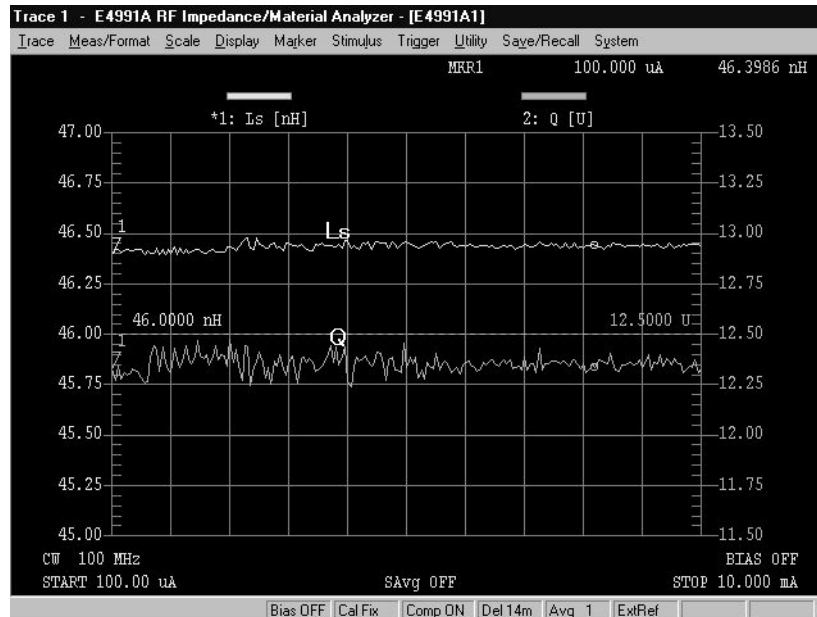

Performing Averaging

When the measured trace does not appear smooth on the display, a smooth trace may be obtained by performing point averaging or sweep averaging. Especially for the high Q (low D) measurement, you should perform averaging. This section describes the procedure for averaging by using the setup example of Figure 3-61, “(2) Frequency Characteristics of $|Z|$ -R-X,” on page 84.

Averaging

Averaging includes point averaging and sweep averaging.

- o Point averaging

Point averaging smooths the trace by repeating the measurement on each measurement point until the averaging count is reached (Figure 3-67).

- o Sweep averaging

Sweep averaging smooths the trace by repeating the sweep until the averaging count is reached (Figure 3-67).

NOTE

Point averaging and sweep averaging can be performed at the same time.

Basic Operations for RF Devices Measurement
STEP 8. Measuring DUT and Analyzing Measurement Results

Figure 3-67

Point averaging and sweep averaging

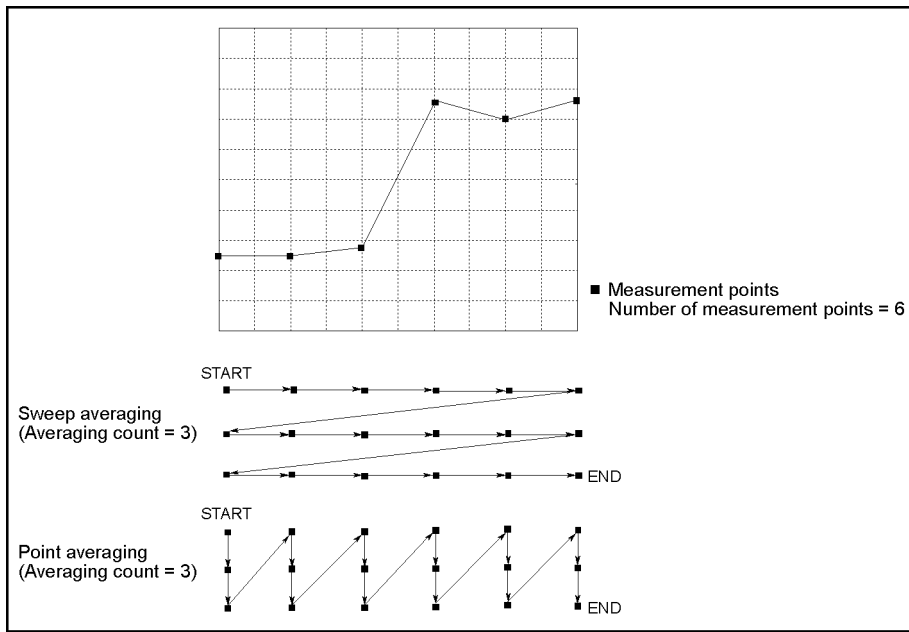

Performing Point Averaging

- Step 1. Click **Sweep Setup...** on the **Stimulus** menu (Figure 3-13).
- Step 2. Set the averaging count in the **Point Average** box (Figure 3-68).

Figure 3-68

Step 2

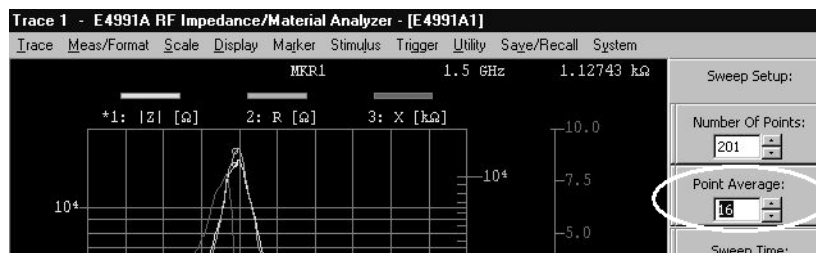

NOTE

Point averaging is started automatically when the averaging count is set to 2 or larger.

- Step 3. Verify that the display of the status bar on the bottom of the screen changes to “Avg x,” which indicates that the point averaging is performed x times (Figure 3-69).

Performing Sweep Averaging

- Step 1.** Click **Meas/Format...** on the **Meas/Format** menu (Figure 3-8).
- Step 2.** Click the **Sweep Average** button to change the button's display to **[On]** (Figure 3-69).

Figure 3-69

Step 2, 3, 4

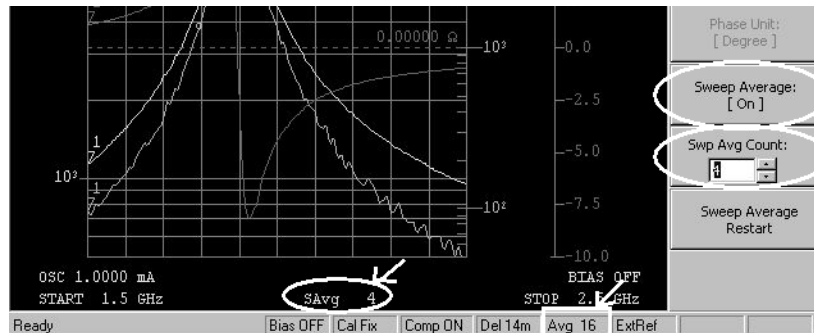

- Step 3.** Set the averaging count in the **Swp Avg Count** box (Figure 3-69).
- Step 4.** Verify that the display of the status bar on the bottom of the screen changes to “SAvg x,” which indicates that the sweep averaging is performed x times (Figure 3-69).

NOTE

If a smooth trace cannot be obtained by performing averaging, perform the measurement after setting the point averaging count to larger values and then performing calibration/fixture compensation at the user-defined frequency/user-defined power points (Figure 3-70).

Figure 3-70

(2) Frequency Characteristics of |Z|-R-X

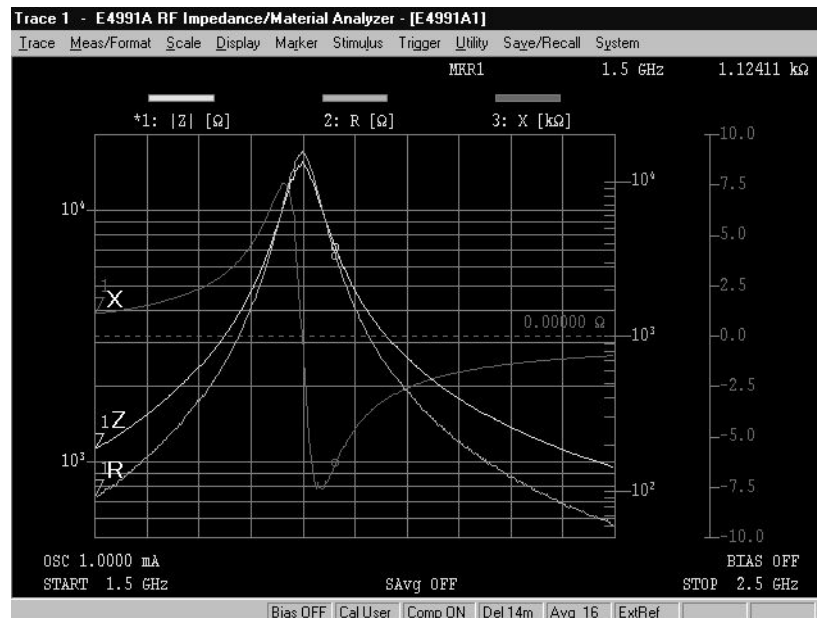

Using Marker Function

The marker function allows you to read trace values and stimulus values at any point on the active trace (Figure 3-56). The marker search function allows you to detect specific points such as maximum values, minimum values, peak values and target values. This section describes how to read trace values, detect maximum values, display a marker list, and clear the markers.

Reading Trace Values

- Step 1.** Click **Marker...** on the **Marker** menu (Figure 3-55).
- Step 2.** Specify the trace (measurement parameter) to be read as the active (refer to Figure 3-9, Figure 3-10).
- Step 3.** Move the marker by any of the following methods to read trace values and stimulus values in the upper right area of the screen (Figure 3-56).
 - Move the cursor with the mouse to the marker point, where the cursor changes to a finger icon (). Drag and drop to the point to be read (Figure 3-71).

NOTE

“Drag and drop” means a series of operations including moving the cursor to a desired point on the screen while pressing and holding the mouse button and then releasing the button.

- Move the cursor to the **Stimulus** box, and then turn the rotary knob () to move the maker to the point to be read.
- As shown in Figure 3-56, select the **Stimulus** box with the mouse and then enter the stimulus value of the point to be read with the keyboard. For example, when reading the trace value of a point with a stimulus value of 1 MHz, type **[1] [M] [Enter]**.

Figure 3-71

Moving marker point by using mouse

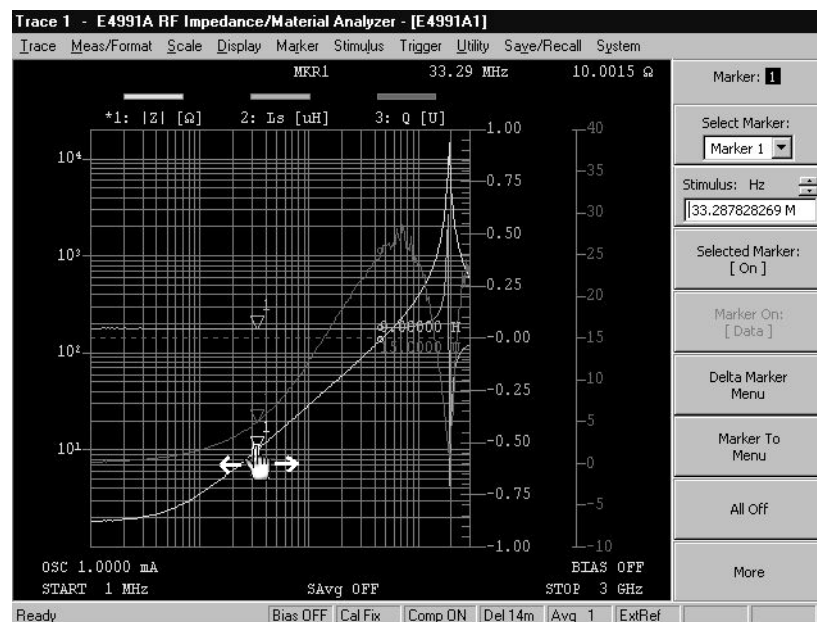

Step 4. Read the marker value displayed in the upper right area of the screen.

NOTE

When the **Marker** button's display is changed to **[Discrete]** by clicking it after clicking the **More** button, only the values of the measurement points on a trace can be read when using the marker function. By changing the button's display to **[Continuous]**, the value of any point on a trace can be read.

By clicking the **Marker Couple** button to change its display to **[Off]**, markers of individual traces can be controlled separately. That is, only the markers of the active trace can be controlled. By changing the button's display to **[On]**, the markers of all traces can be controlled together.

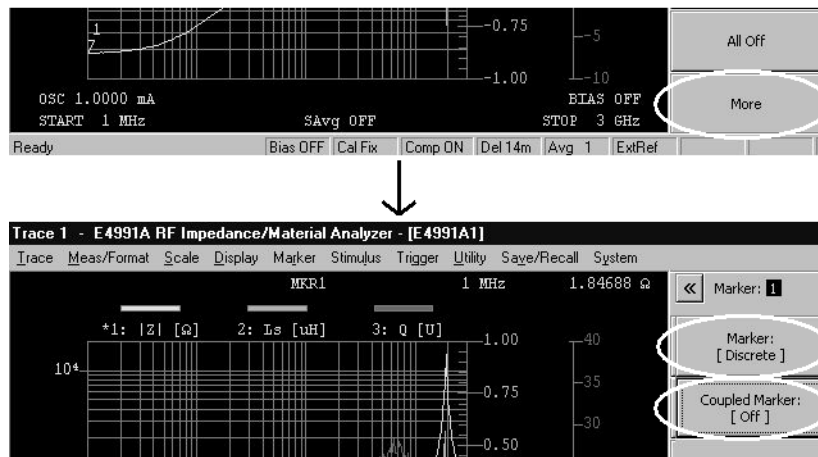

STEP 8. Measuring DUT and Analyzing Measurement Results

Detecting Maximum Value

This section describes how to search for the maximum value (self-resonance point) of the measurement parameter $|Z|$ by using the setup example of “(1) Frequency Characteristics of $|Z|$ -Ls-Q” on page 46.

- Step 1.** Specify the trace (measurement parameter) to be read as the active (refer to Figure 3-9, Figure 3-10). In this case, make Trace 1 (the measurement parameter $|Z|$) active.
- Step 2.** Click **Function...** on the **Marker** menu (Figure 3-72).

Figure 3-72

Step 2

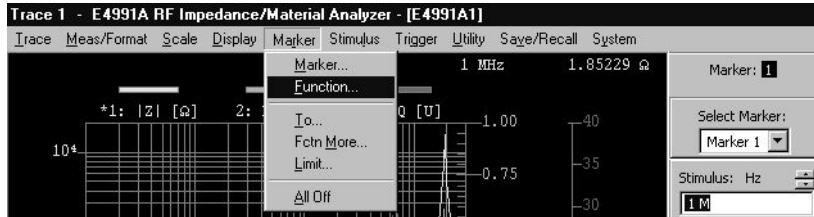

- Step 3.** Select **Maximum** in the **Search Type** box (Figure 3-73).

Figure 3-73

Step 3

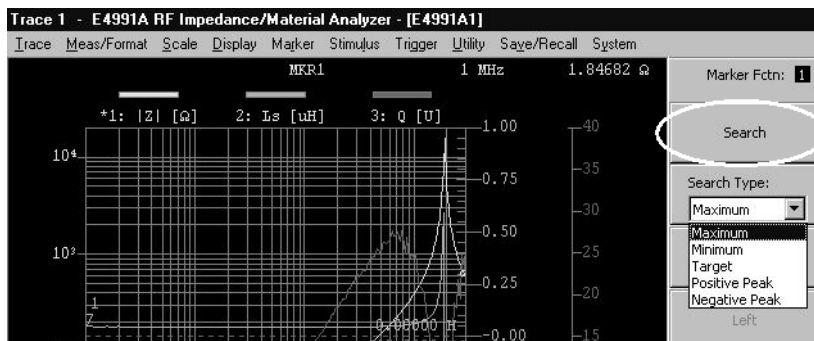

Table 3-11

Search Type box settings and search points

Search Type box	Search point
Maximum	Point where the trace value on the active trace is maximum
Minimum	Point where the trace value on the active trace is minimum
Target	Point where the trace value on the active trace is set to a target
Positive Peak	Point where the trace value on the active trace is a positive peak
Negative Peak	Point where the trace value on the active trace is a negative peak

- Step 4.** Click the **Search** button (Figure 3-73).
- Step 5.** Active marker moves to the maximum value on the active trace (Figure 3-74).
- Step 6.** Read the marker value displayed in upper right area of the screen.

Figure 3-74 Detecting maximum value

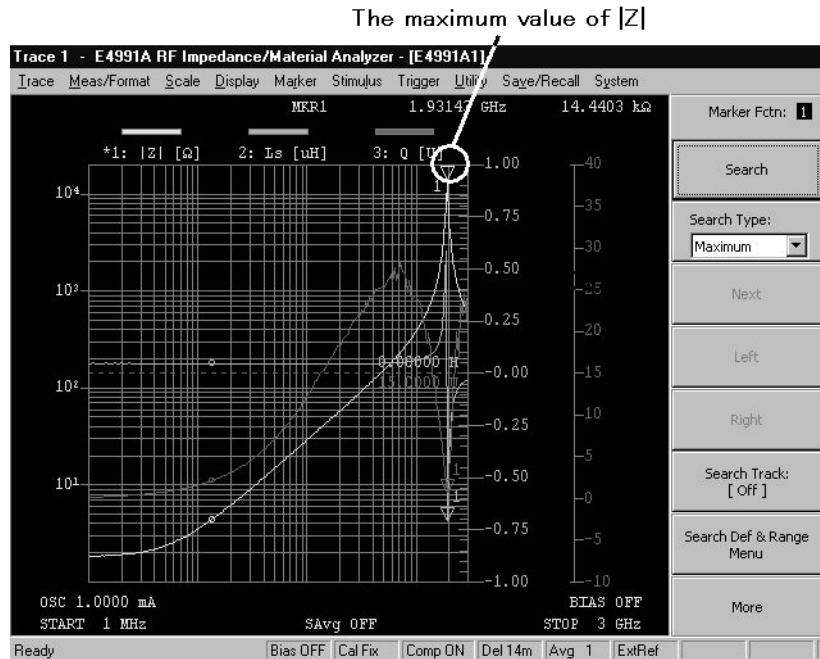

Displaying Marker List

Up to eight markers can be displayed in a list. In this section, six markers are displayed in a list for the measurement parameter Ls while using the setup example of “(1) Frequency Characteristics of $|Z|$ -Ls-Q” on page 46.

- Step 1.** Click **Display...** on the **Display** menu (Figure 3-6).
- Step 2.** Select **1 Scalar** in the **Num Of Traces** box as shown in Figure 3-7.
- Step 3.** Click **Meas/Format...** on the **Meas/Format** menu (Figure 3-8).
- Step 4.** Select **Ls** in the **Meas Parameter** box (Figure 3-12).
- Step 5.** Check that the **Format** box is set to **Lin Y-Axis**.
- Step 6.** Click **Autoscale** on the **Scale** menu (Figure 3-54).
- Step 7.** Click **Fctn More...** on the **Marker** menu (Figure 3-75).

Figure 3-75

Step 7

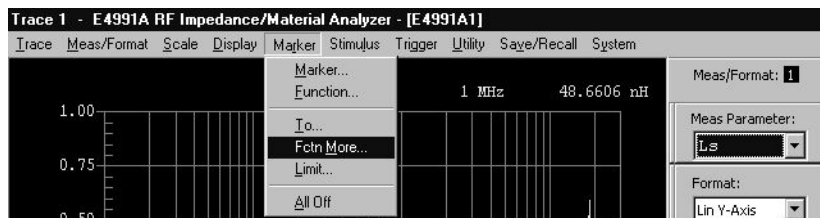

Basic Operations for RF Devices Measurement
STEP 8. Measuring DUT and Analyzing Measurement Results

Step 8. Click the **Marker List** button to change the button's display to **[On]** (Figure 3-76).

Figure 3-76

Step 8

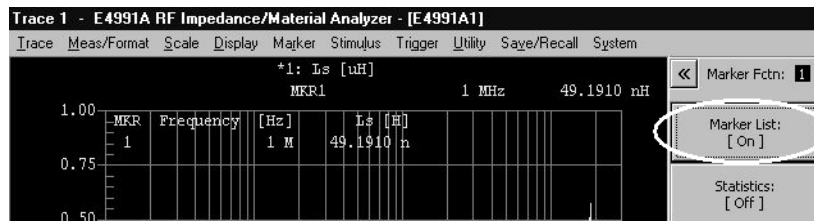

Step 9. Click **Marker...** on the **Marker** menu (Figure 3-55).

Step 10. Move the active marker to the point to be read. Then place it on the point of frequency, which is 1 MHz in this example.

Step 11. Select **Marker 2** in the **Select Marker** box (Figure 3-77).

Figure 3-77

Step 11

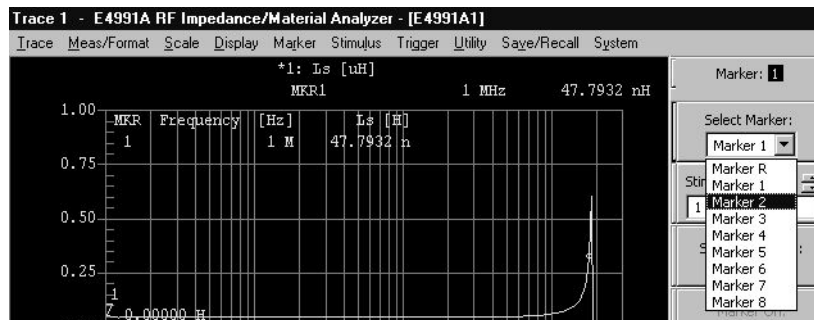

Step 12. Move the active marker to the point to be read.

Step 13. In the same way, place **Marker 3** through **Marker 6** on the points to be read individually (Figure 3-78).

NOTE

The marker point for the active marker is indicated by a large triangle (Δ).

Figure 3-78

Displaying marker list

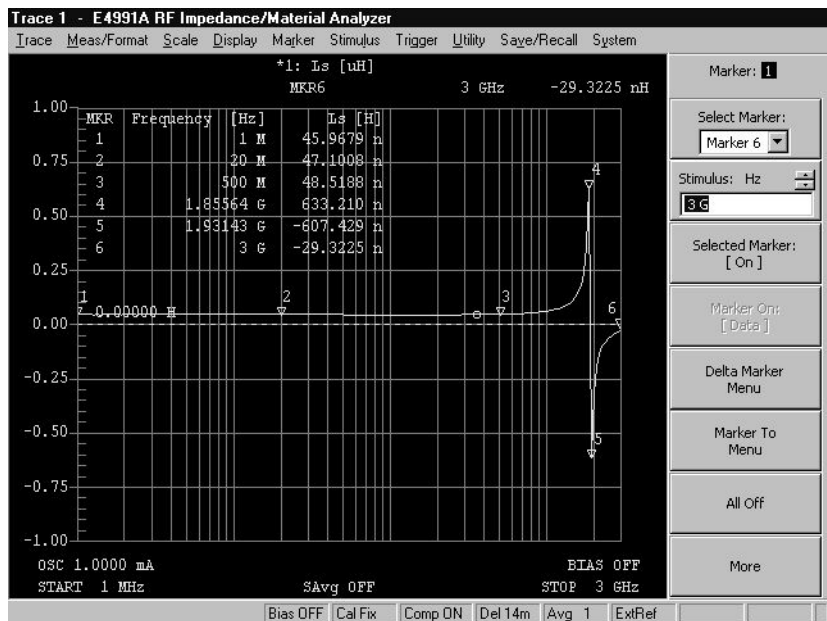

Clearing Markers

Follow the procedure given below to clear active markers.

- Step 1. Click **Marker...** on the **Marker** menu (Figure 3-55).
- Step 2. Select the marker number to be cleared in the **Select Marker** box. (Figure 3-79).
- Step 3. Click the **Selected Marker** button to change the button's display to **[Off]** (Figure 3-79).

Figure 3-79

Step 3

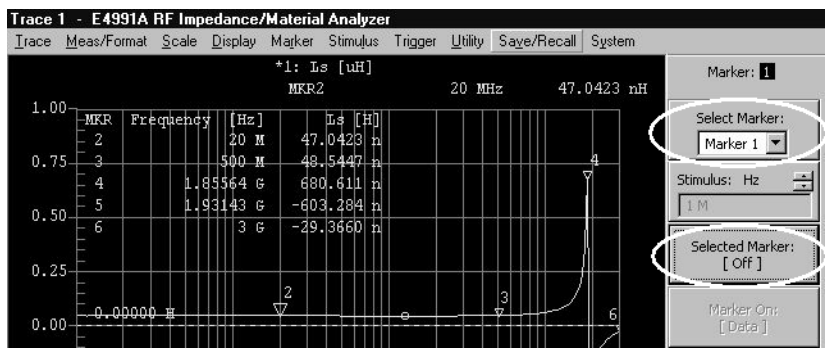

- Step 4. Active marker (**Marker 1**) is cleared.

NOTE



Click **All Off** on the **Marker** menu to clear all markers.

Executing Equivalent Circuit Analysis

The E4991A is provided with five types of equivalent circuit models that can be used to calculate approximate values of equivalent circuit parameters from measurement data. The approximate values of equivalent circuit parameters obtained by calculation can be used to simulate the frequency characteristics on the display screen.

NOTE The equivalent circuit analysis function can be used only when the sweep parameter is frequency.

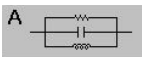
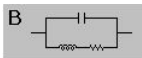
Table 3-12 Selection of equivalent circuit model

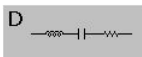
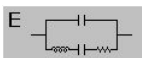
Equivalent circuit model	DUT type
	Inductors with high core loss
	Inductors and resistors
	High-value resistors
	Capacitors
	Resonators

Calculating Approximate Values of Equivalent Circuit Parameters

In this section, a chip inductor is used to calculate the approximate value by using the setup example of “(1) Frequency Characteristics of $|Z|$ -Ls-Q” on page 46.

Step 1. Click **Equivalent Circuit...** on the **Utility** menu (Figure 3-80).

Figure 3-80

Step 1

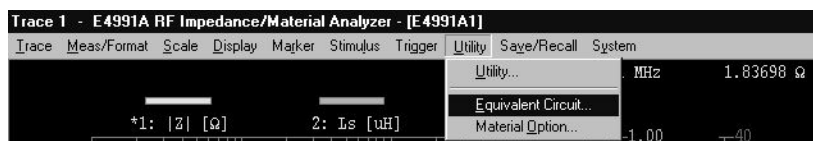

Step 2. Click **Select Circuit** button (Figure 3-81).

Figure 3-81

Step 2

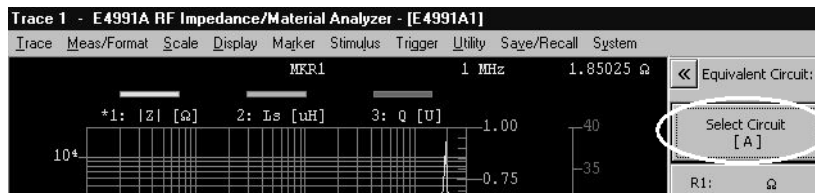

Step 3. Select equivalent circuit model **B** to analyze the chip inductor (Table 3-12). Then click the << button to return to the **Equivalent Circuit** toolbar (Figure 3-82).

Figure 3-82

Step 3

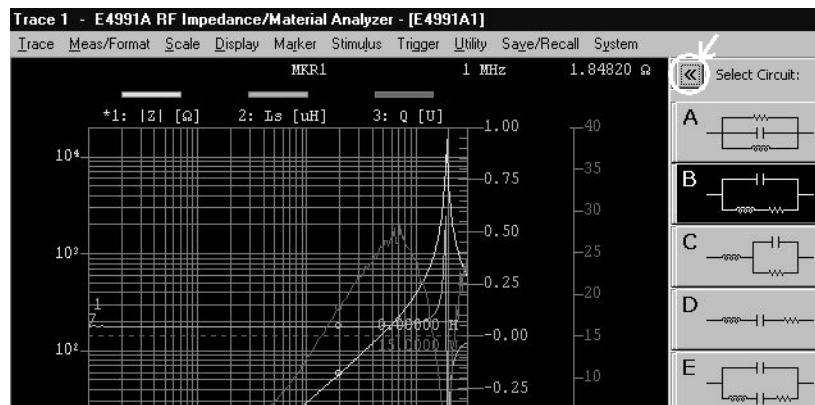

Step 4. Click the **Calculate Parameters** button to display the approximate values. (Figure 3-83).

Figure 3-83

Displaying approximate values and Simulating frequency characteristics

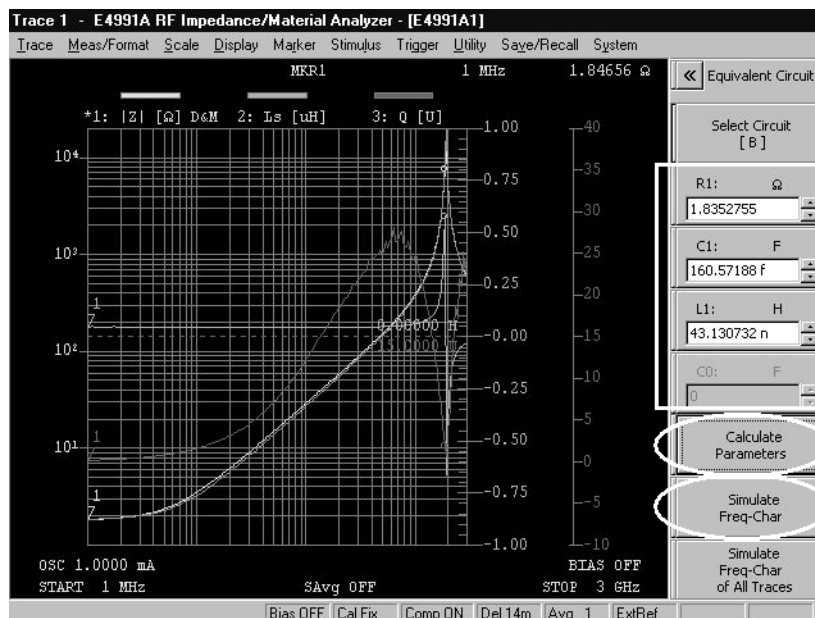

Simulating Frequency Characteristics

We can simulate the frequency characteristics of Trace 1 ($|Z|$) by using the approximate value obtained by the above calculation based on the setup example of “(1) Frequency Characteristics of $|Z|$ -Ls-Q” on page 46.

NOTE Simulation can also be done by inputting a desired value in the parameter box of an individual equivalent circuit model.

Step 1. Click **Equivalent Circuit...** on the **Utility** menu (Figure 3-80).

Step 2. Specify Trace 1 ($|Z|$) as the active trace (* mark) as shown in Figure 3-9 and Figure 3-10.

Step 3. Click the **Simulate F-Characteristics** button to simulate the frequency characteristics of Trace 1 ($|Z|$). The simulated data are traced on the display screen (Figure 3-83).

NOTE Clicking the **Simulate F-Characteristics to All Traces** button in the **Equivalent Circuit** toolbar simulates the frequency characteristics of all traces.

Enlarging Trace (Zoom Function, Mouse Operation Only)

The mouse can be used to select a range for enlarged display. This zoom function is accomplished by the following steps. Here, the zoom function is performed by using the example shown in Figure 3-61, “(2) Frequency Characteristics of $|Z|$ -R-X,” on page 84.

Step 1. Select the range to be enlarged by dragging with the mouse (Figure 3-84).

NOTE “Drag” means a series of operations including moving the mouse pointer while pressing and holding the mouse button to select a desired range before releasing the button.

Step 2. The selected area on the display is enlarged (Figure 3-84).

Figure 3-84 Zoom screen

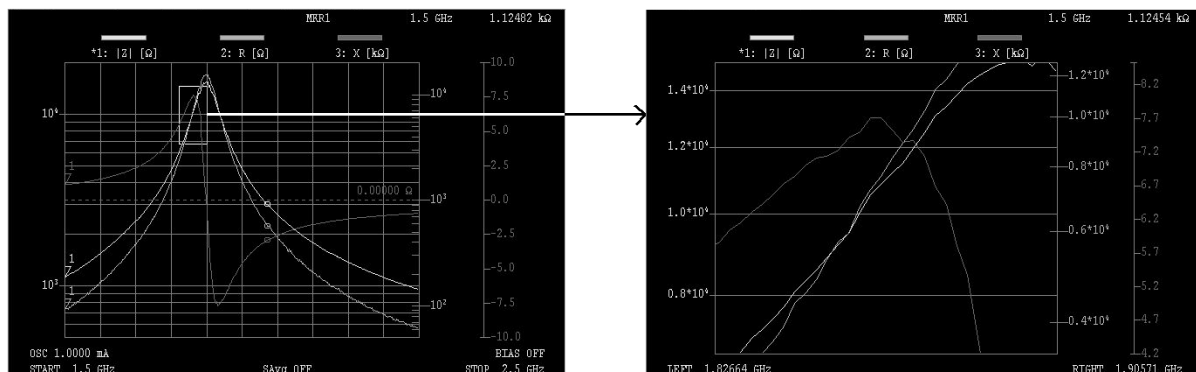

Step 3. Click the mouse on the screen to clear the zoomed image and return the display to the previous standard size.

Displaying Traces on Individual Windows

In scalar trace, there is a “split” function to divide a screen into windows for displaying each trace individually. Since the traces do not overlap, this function can be used to focus on the data you want to analyze. This section describes how to divide the screen using the setup example of “(1) Frequency Characteristics of $|Z|$ -Ls-Q” on page 46.

- Step 1.** Click **Display...** on the **Display** menu (Figure 3-6).
- Step 2.** Click the **Display Scalar Trace** button to change the button’s display to **[Split]** (Figure 3-85).
- Step 3.** The screen divides into three windows, and each scalar trace is displayed in an individual window (Figure 3-85)

Figure 3-85

Divided display screen

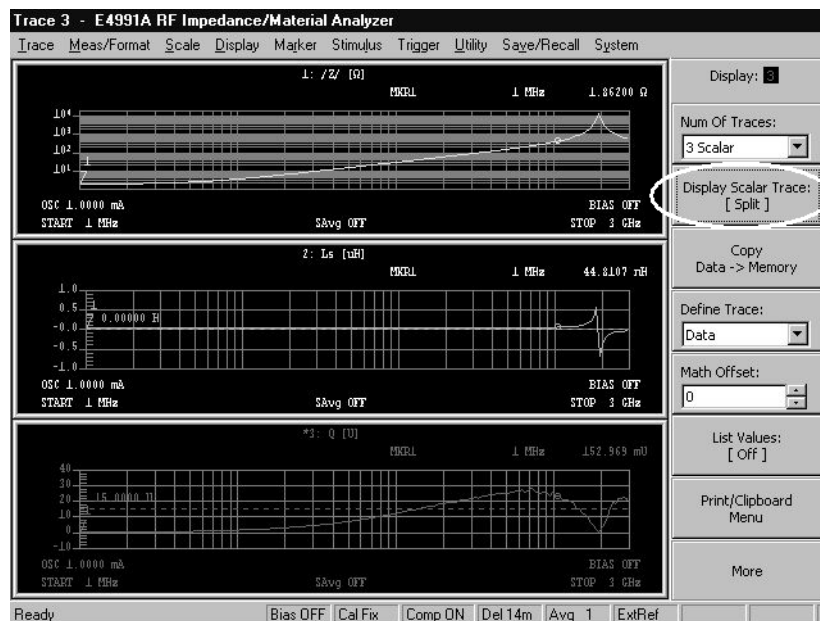

3. Basic Operations for RF Devices Measurement

- Step 4.** To return to overlay screen and displays all traces in one screen, click the **Display Scalar Trace** button to change the button’s display to **[Overlay]**.

Displaying Smith Chart

In addition to scalar trace, you can also display a complex trace (complex plane format, polar coordinate format, Smith chart, and admittance chart). In this section, a Smith chart is displayed by using the setup example of “(1) Frequency Characteristics of $|Z|$ -Ls-Q” on page 46.

NOTE

The Smith chart and admittance chart are used only for measuring reflection coefficient (Γ).

- Step 1.** Click **Display...** on the **Display** menu (Figure 3-6).

STEP 8. Measuring DUT and Analyzing Measurement Results

- Step 2.** Select **3 Sclr, 1 Cmplx** in the **Num Of Traces** box as shown in Figure 3-7.
- Step 3.** The scalar traces of three measurement parameters are displayed at the top of the screen, and the complex trace of measurement parameter ($|Z|$) is displayed at the bottom of the screen.
- Step 4.** Specify Trace 4 (the polar display format) as the active trace (* mark) as shown in Figure 3-9 and Figure 3-10.
- Step 5.** Click **Meas/Format...** on the **Meas/Format** menu (Figure 3-8).
- Step 6.** Select the reflection coefficient (Γ) in the **Meas Parameter** box (Figure 3-86).

Figure 3-86

Step 6

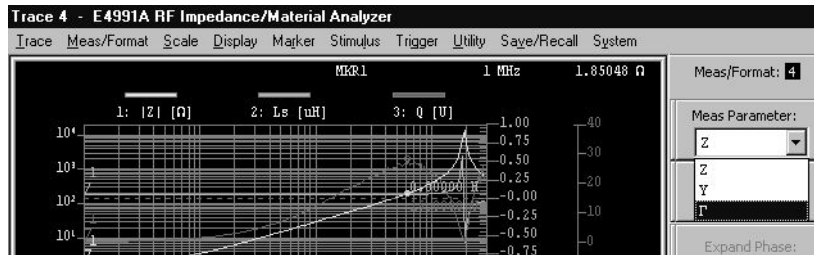

- Step 7.** Select **Smith** in the **Format** box (Figure 3-87).

Figure 3-87

Step 7

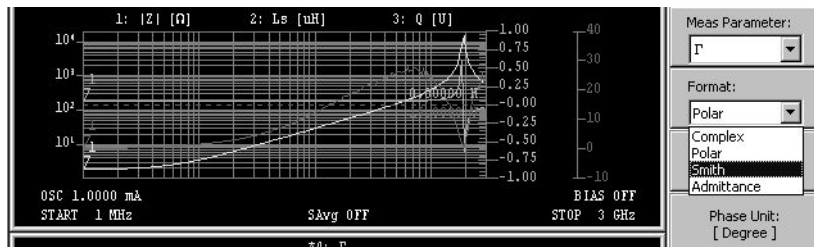

Table 3-13

Format box settings and Complex traces

Format box	Complex trace
Complex	Complex plane format
Polar	Polar coordinate format
Smith	Smith chart
Admittance	Admittance chart

- Step 8.** The display screen as shown in Figure 3-88 is obtained.

Figure 3-88

Smith chart screen

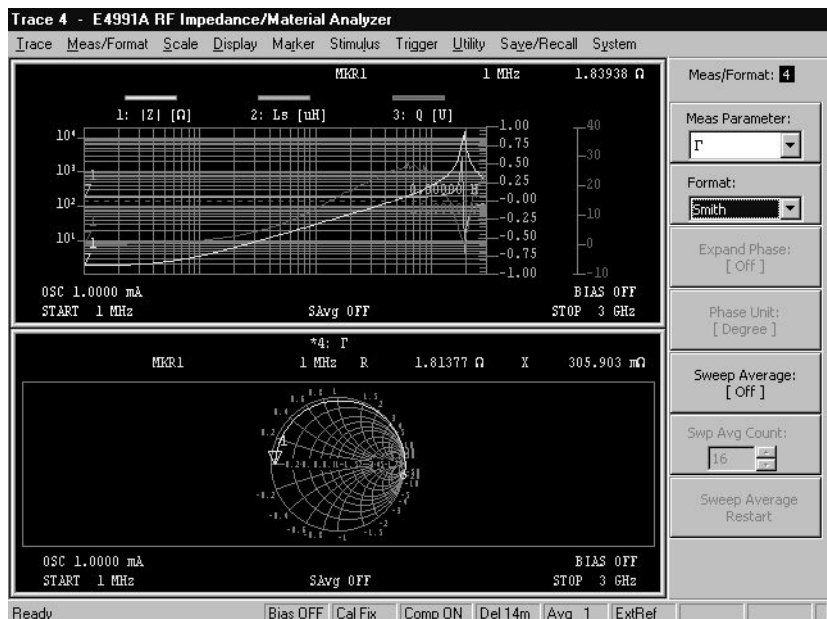

Displaying Five Windows

A maximum of five windows can be displayed at one time: up to three windows for scalar trace and up to two windows for complex trace. In this section, five windows are displayed by using the setup example of “(1) Frequency Characteristics of |Z|-Ls-Q” on page 46.

- Step 1.** Click **Display...** on the **Display** menu (Figure 3-6).
- Step 2.** Select **3 Sclr, 2 Cmplx** in the **Num Of Traces** box as shown in Figure 3-7.
- Step 3.** Click **Display Scalar Trace** button to change the button's display to **[Split]** (Figure 3-85).
- Step 4.** Five windows including three windows for scalar trace and two windows for complex trace are displayed (Figure 3-89).

Basic Operations for RF Devices Measurement
STEP 8. Measuring DUT and Analyzing Measurement Results

Figure 3-89

Five-window display

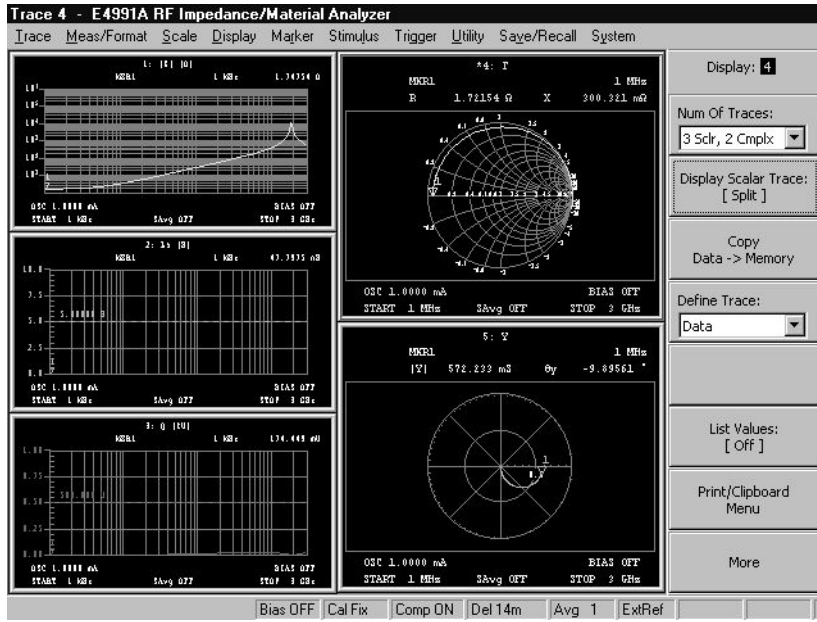

STEP 9. Changing Sweep Conditions

When the measurement points for calibration are user-defined frequency/user-defined power points, start measurement with “STEP 3. Calibration” on page 60 after changing the measurement conditions. When the measurement points for calibration are fixed frequency/fixed power points, start measurement with “STEP 8. Measuring DUT and Analyzing Measurement Results” on page 82.

NOTE

When the measurement points for calibration are fixed frequency/user-defined power points, start measurement with “STEP 3. Calibration” on page 60 after changing the oscillator level. When you change other sweep conditions, start measurement with “STEP 8. Measuring DUT and Analyzing Measurement Results” on page 82.

STEP 10. Measuring Other DUTs

If you measure another DUT of the same type and size as the one used in the previous measurement, start measurement with “STEP 7. Connecting DUT to Test Fixture” on page 81. If you use the same test fixture to measure a DUT of a different type and size, start measurement with “STEP 6. Fixture Compensation” on page 73. When using a different test fixture, start measurement with “STEP 4. Connecting Test Fixture” on page 70.

NOTE

When measuring a DUT in the initial state after turning the power ON, start measurement with “STEP 2. Setting Measurement Conditions” on page 45.

Basic Operations for RF Devices Measurement
STEP 10. Measuring Other DUTs

4**Basic Operations for Dielectric
Measurement**

This chapter explains the basic operations for taking dielectric measurements with the Agilent E4991A. To perform this type of measurement, the Option 002 (Material Measurement) software must be installed.

Contents of this chapter

- o Dielectric Measurement Overview page 107
 - Measurement example and a basic flow for dielectric measurement.
- o STEP 1. Preparation for Measurement page 108
 - How to prepare for measurement.
- o STEP 2. Selecting Measurement Mode page 110
 - How to set the E4991A measurement mode to dielectric measurement mode.
- o STEP 3. Setting Measurement Conditions page 111
 - How to set sweep conditions and measurement parameters.
- o STEP 4. Connecting 16453A page 113
 - How to connect the 16453A test fixture to the 7-mm terminal of the test head.
- o STEP 5. Entering Thickness of Load Standard page 114
 - How to enter the thickness of the provided load standard (made of PTFE).
- o STEP 6. Calibration page 115
 - How to perform OPEN, SHORT and LOAD calibrations on the MUT connection terminal of the 16453A test fixture.
- o STEP 7. Entering Thickness of MUT page 120
 - How to enter the thickness of the MUT (dielectric material).
- o STEP 8. Connecting MUT page 121
 - How to connect the MUT (dielectric material) to the test fixture.
- o STEP 9. Measuring MUT and Analyzing Measurement Results page 122
 - How to achieve the optimum setting of the vertical axis scale and analyze the measurement results.
- o STEP 10. Changing Sweep Conditions page 123
 - How to change sweep conditions.
- o STEP 11. Measuring Other MUTs page 123
 - How to measure other MUTs.

Dielectric Measurement Overview

When the E4991A has the option 002 installed, dielectric measurement is possible. This chapter describes the basic operations done by using the mouse and keyboard to evaluate the following characteristics:

- Frequency characteristics of ϵ_r' - ϵ_r'' - $\tan\delta$

Flow for Dielectric Measurement

The basic procedure for dielectric measurement is given in the flow chart of Figure 4-1.

Figure 4-1 Basic procedure for dielectric measurement

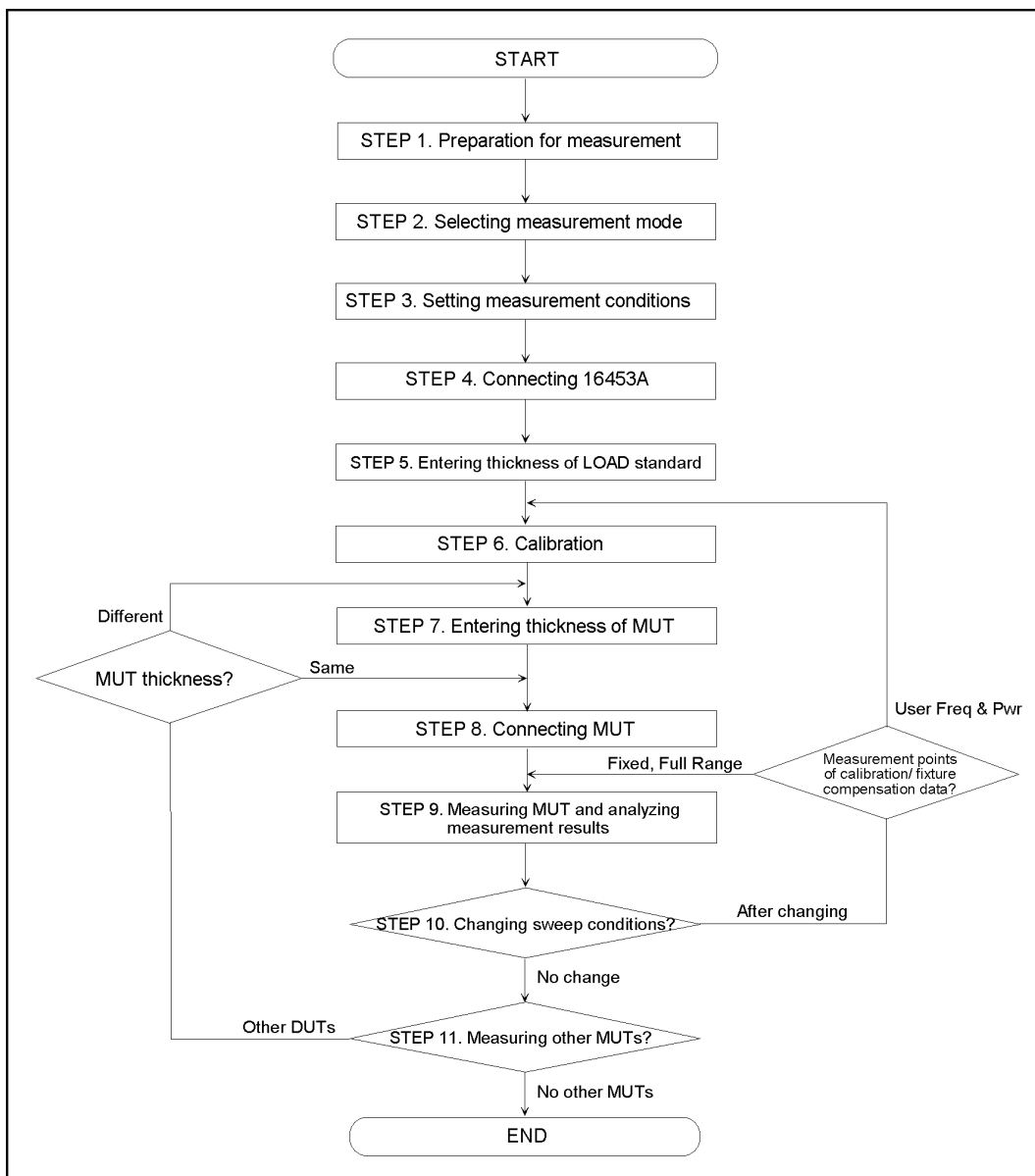

e4991aqe520

STEP 1. Preparation for Measurement

Selection of MUT and Test Fixture

With the E4991A, the 16453A test fixture can be used to measure dielectric materials (Table 4-1). The applicable dielectric materials are solid with a smooth surface, such as ceramic, PTFE, and resin (Figure 4-2).

Figure 4-2

Applicable dielectric materials

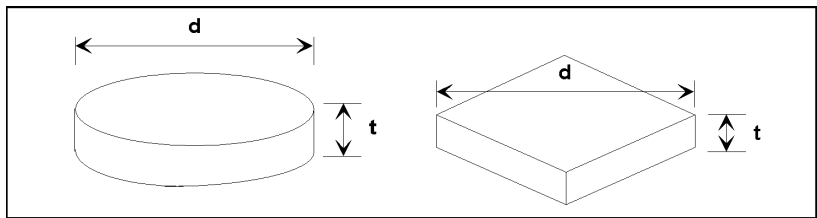

material_dielectric

Table 4-1

Features of 16453A test fixture

Frequency range	Maximum dc bias voltage value	Dielectric material size value
1 M to 1 GHz	± 40 V	$d \geq 15$ mm $0.3 \text{ mm} \leq t \leq 3$ mm

Required Equipment

The following equipment is required to perform dielectric measurement.

Figure 4-3

Required equipment

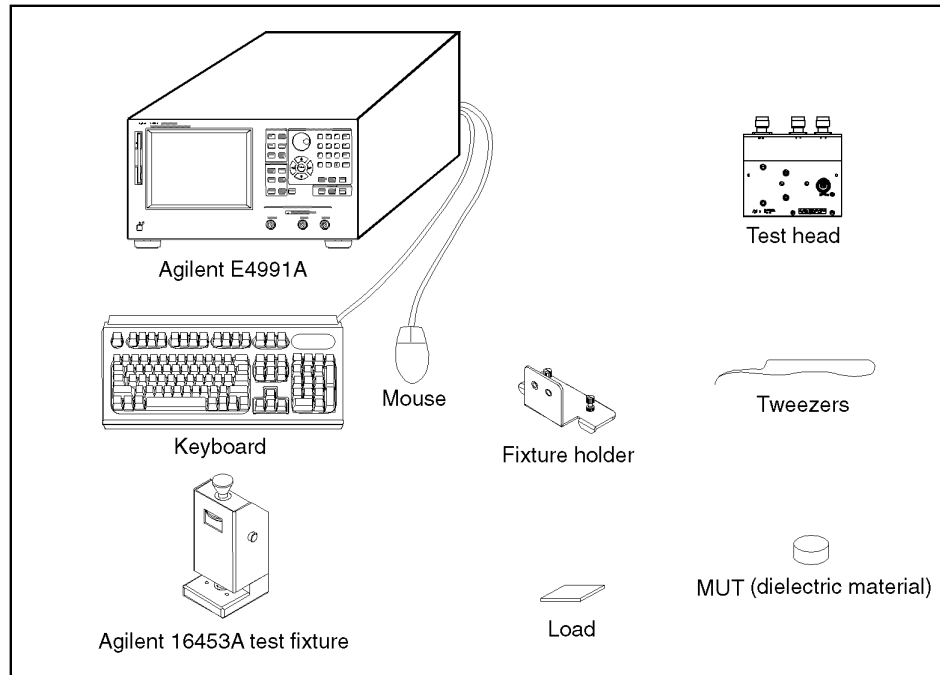



Connecting Mouse, Keyboard, and Test Head

Connect the mouse, keyboard and test head to the E4991A by referring to “Connection to Rear Panel” on page 27 and “Connecting the Test Head” on page 28. Be sure not to remove the four feet on the bottom of the E4991A when connecting the test head.

NOTE Be sure to connect the mouse and keyboard before turning the power ON.

Turning the Power ON

Perform the following steps to turn the power ON. The E4991A starts a self-test automatically when the power is turned ON.

- Step 1.** If the standby switch (⏻) in the lower-left part of the front panel is in the position () position, press it to put it in the popped up position ().
- Step 2.** Press the standby switch to the depressed position ().

NOTE Special caution is required when turning the power ON or OFF. Refer to “Turning the Power ON and OFF” on page 31.

STEP 2. Selecting Measurement Mode

You must set the E4991A measurement mode from the initial state to the dielectric measurement mode.

- Step 1.** Click **Preset** on the **System** menu to set the initial state.
- Step 2.** Click **Utility...** on the **Utility** menu.
- Step 3.** Click the **Material Option Menu** button.
- Step 4.** Select **Permittivity** in the **Material Type** box.

NOTE

When you set the E4991A measurement mode to Dielectric Material, the 16453A is automatically set as the texture fixture to be used.

STEP 3. Setting Measurement Conditions

Before starting the measurement, you must set the measurement parameters and sweep conditions according to your measurement requirements. This section describes the setup procedure for the following measurement.

- Frequency characteristics of ϵ_r' - ϵ_r'' - $\tan\delta$

First you should change the measurement conditions from the initial state of the E4991A as shown in Table 4-2.

Table 4-2 Setup example for this measurement

Parameter setting		Setup example	Initial state
Measurement parameters	Trace 1	ϵ_r'	ϵ_r'
	Trace 2	ϵ_r''	ϵ_r''
	Trace 3	$\tan\delta$	$\tan\delta$
Display formats	Trace 1	linear	linear
	Trace 2	linear	linear
	Trace 3	linear	linear
Sweep parameter		Frequency	Frequency
Sweep type		Log	Linear
Source mode		Voltage	Voltage
Oscillator level		100 mV	100 mV
Sweep range (Frequency)		1 MHz to 1 GHz	1 MHz to 3 GHz

Setting the Measurement Parameters and Display Formats

- Step 1.** Click **Display...** on the **Display** menu.
- Step 2.** Select **3 Scalar** in the **Num of Traces** box.
- Step 3.** Click **Meas/Format...** on the **Meas/Format** menu.
- Step 4.** Specify Trace 1 as the active trace (* mark) and select ϵ_r' in the **Meas Parameter** box.
- Step 5.** Select **Lin Y-Axis** in the **Format** box.
- Step 6.** Specify Trace 2 as the active trace (* mark) and select ϵ_r'' in the **Meas Parameter** box.
- Step 7.** Select **Lin Y-Axis** in the **Format** box.

Basic Operations for Dielectric Measurement

STEP 3. Setting Measurement Conditions

- Step 8.** Specify Trace 3 as the active trace (* mark) and select $\tan\delta$ (ϵ) from the **Meas Parameter** box.
- Step 9.** Select **Lin Y-Axis** in the **Format** box.

Setting the Measurement Points, Sweep Parameter, and Sweep Type

- Step 1.** Click **Sweep Setup...** on the **Stimulus** menu.
- Step 2.** In the **Number Of Points** box, enter the desired measurement points. For example, if you want to enter 301, type **[3] [0] [1] [Enter]** with the keyboard.
- Step 3.** Select **Frequency** in the **Sweep Parameter** box.
- Step 4.** Select **Log** in the **Sweep Type** box.

Setting the Source Mode and Oscillator Level

- Step 1.** Click **Source...** on the **Stimulus** menu.
- Step 2.** Select **Voltage** in the **Osc Unit** box.
- Step 3.** In the **Osc Level** box, enter the oscillator level. For example, if you want to enter 100 mV, type **[1] [0] [0] [m] [Enter]** with the keyboard.

Setting the Sweep Range (Frequency)

- Step 1.** Click **Start/Stop...** on the **Stimulus** menu.
- Step 2.** In the **Start** box, enter the start frequency. For example, if you want to enter 1 MHz, type **[1] [M] [Enter]** with the keyboard.
- Step 3.** In the **Stop** box, enter the stop frequency. For example, if you want to enter 1 GHz, type **[1] [G] [Enter]** with the keyboard.

STEP 4. Connecting 16453A

Connect the 16453A test fixture to the 7-mm terminal of the test head by following these steps.

- Step 1.** As shown in Figure 3-42 on page 70, turn the 7-mm connector nut of the test head counterclockwise until the connector sleeve is fully retracted.
- Step 2.** Tighten the two small screws of the fixture holder to secure the fixture holder to the test fixture body (Figure 4-4, 2).
- Step 3.** Connect the 7-mm connector of the test fixture to the 7-mm terminal of the test head (Figure 4-4, 3).
- Step 4.** Tighten the two large screws of the fixture holder to secure the test fixture to the test head (Figure 4-4, 4).

Figure 4-4

Connecting the 16453A

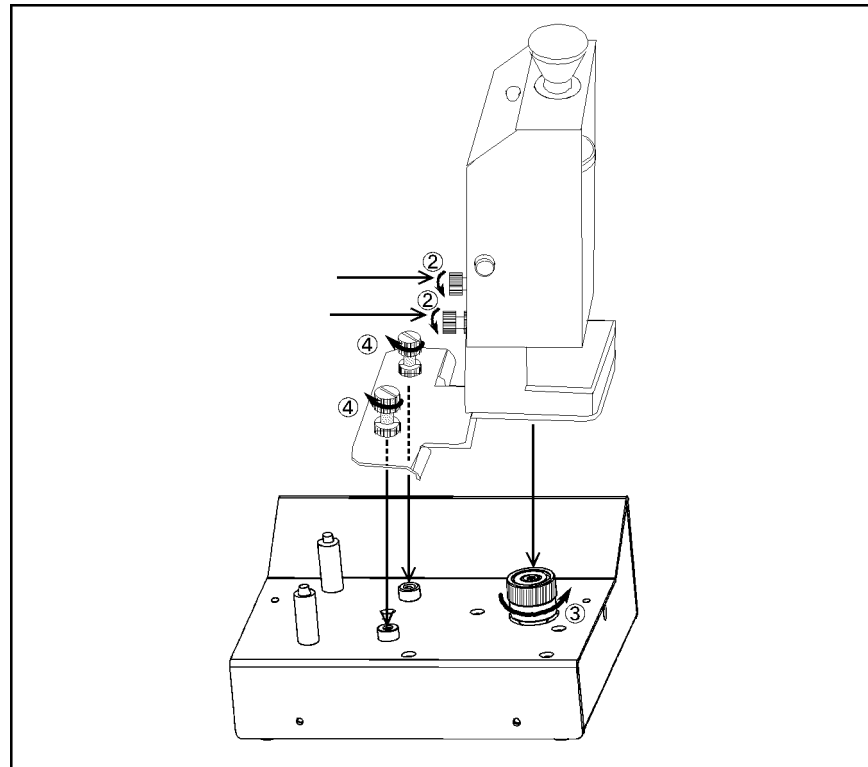

e4991aqj524

STEP 5. Entering Thickness of Load Standard

Enter the thickness of the PTFE load standard supplied with the 16453A test fixture by following these steps. The thickness is printed on the surface of the case. When you use a user-defined load standard for measuring dielectric materials, enter its thickness.

NOTE

The thickness value written on the case is a typical value. If you need to enter a highly accurate value, measure it with a micrometer or calipers.

Step 1. Click **Cal/Comp...** on the **Stimulus** menu.

Step 2. Click the **Cal Kit Menu** button.

Step 3. In the **Thickness** box, enter the thickness of the load standard. For example, if the load standard is 0.75 mm in thickness, type **[0] [.] [7] [5] [m] [Enter]** with the keyboard.

NOTE

The load standard supplied with the 16453A test fixture is made of PTFE with a relative permittivity of 2.1. Therefore, when the E4991A is in the initial state, the value in the **ϵ_r Real** box in the Cal Kit toolbar is set to 2.1000 and the value in the **ϵ_r Loss** box is set to 0.0000. If you use a user-defined load standard, change these values accordingly. For more on the calibration kit, refer to Chapter 4, “Calibration and Compensation” in the *E4991A Operation Manual*.

STEP 6. Calibration

Calibration is performed by using the MUT connection plane of the 16453A test fixture as the calibration reference plane (Figure 4-5). By performing calibration on the MUT connection plane, you can eliminate errors due to the test fixture's residuals and electric length. Therefore, unlike impedance measurement, electric length or fixture compensation is not required (see Table 4-3).

Figure 4-5

Error model of 16453A test fixture

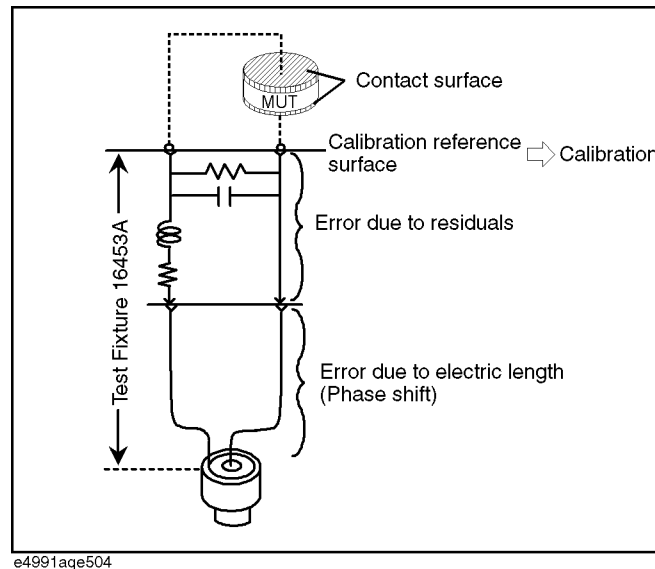

Table 4-3

Differences in calibration and fixture compensation between impedance and dielectric measurement

Correction	Impedance measurement	Dielectric measurement
Calibration reference surface	7-mm terminal (usual)	MUT connection plane
Electric length setting	Required	Not required
Fixture compensation	Required	Not required

Perform calibration by following these steps.

- Step 1.** Click **Cal/Comp...** on the **Stimulus** menu.
- Step 2.** In the **Fixture Type** box, confirm that the test fixture is set to **16453**. Otherwise, set the measurement mode to dielectric measurement mode.
- Step 3.** Click the **Cal Menu** button.
- Step 4.** In the **Cal Type** box, select the desired type of measurement points for the calibration data. For details on the measurement points of calibration data, refer to Table 3-7, “Types of measurement points for calibration/fixture compensation data,” on page 60, and Table 3-8, “Cal Type box settings and measurement points for calibration/fixture compensation data,” on page 61.

Basic Operations for Dielectric Measurement
STEP 6. Calibration

Step 5. Set the MUT connection plane of the test fixture to the SHORT state (Figure 4-6).

Figure 4-6

SHORT state (16453A)

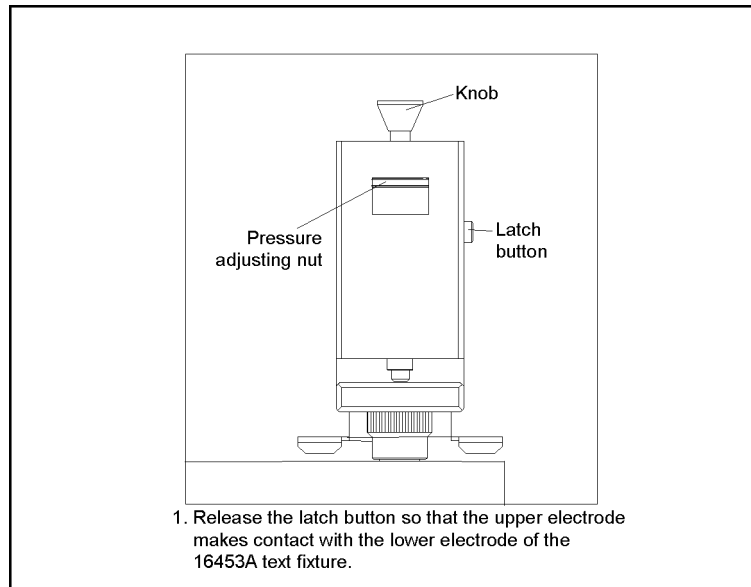

e4991aqe515

Step 6. Click the **Meas Short** button to start measuring SHORT calibration data. Upon completion of the SHORT calibration measurement, a \checkmark mark appears on the left side of the **Meas Short** button.

NOTE

During calibration data measurement, the message “Wait-Measuring Cal Standard” appears at the left end of the status bar at the bottom of the screen.

Step 7. Set the MUT connection plane of the test fixture to the OPEN state (Figure 4-7).

Figure 4-7 **OPEN state (16453A)**

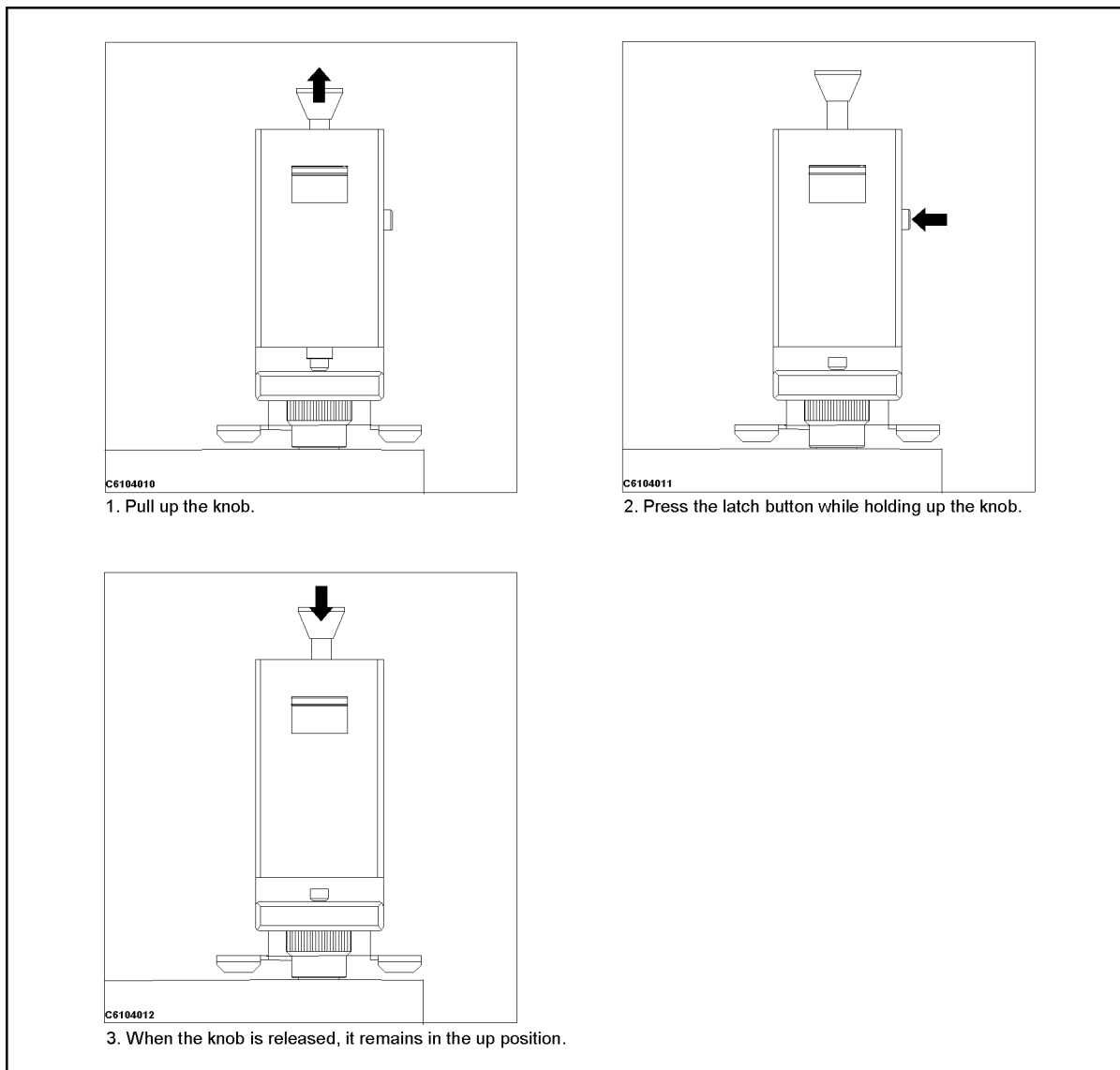

e4991aqe516

Step 8. Click the **Meas Open** button to start measuring OPEN calibration data. Upon completion of the OPEN calibration data measurement, a ✓ mark appears on the left side of the **Meas Open** button.

Basic Operations for Dielectric Measurement
STEP 6. Calibration

Step 9. Connect the load standard supplied with the 16453A test fixture to the test fixture by inserting it between the electrodes of the test fixture (Figure 4-8).

Figure 4-8 Connecting LOAD standard (16453A)

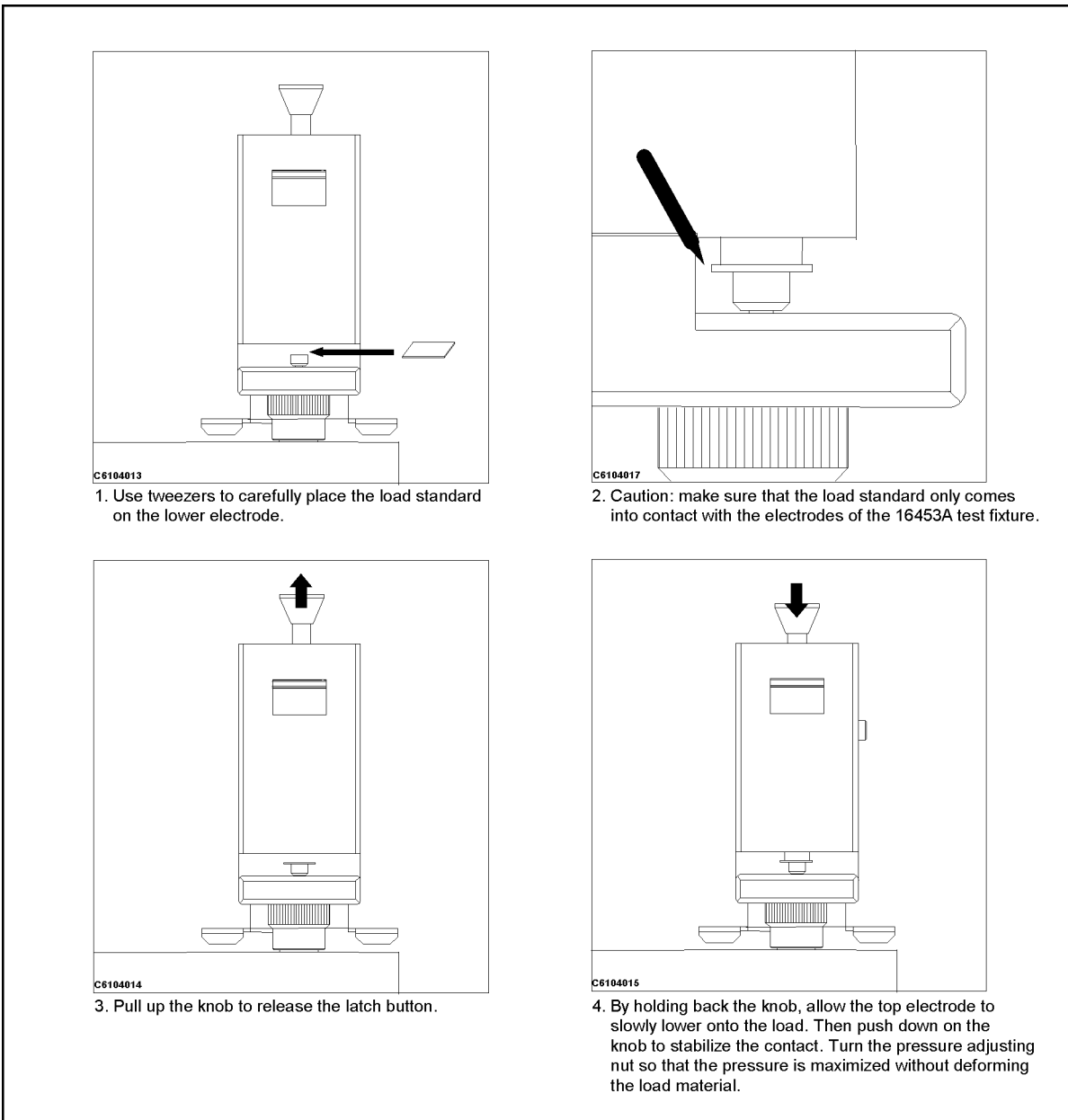

e4991aqe517

NOTE

When connecting a load standard or a MUT to the test fixture, make sure that it only comes into contact with the test fixture's electrodes. Also, be careful not to give the upper electrode horizontal pressure by moving the load standard or the MUT while it is in position between the electrodes.

- Step 10.** Click the **Meas Load** button to start measuring LOAD calibration data. Upon completion of the LOAD calibration data measurement, a \checkmark mark appears on the left side of the **Meas Load** button.
- Step 11.** Click the **Done** button to instruct the E4991A to calculate the calibration coefficient from the measured calibration data and save it to the internal memory.
- Step 12.** Depending on the measurement points of the calibration data specified in the **Cal Type** box, the display below the **Cal Menu** button and on the status bar at the bottom of the screen will change, as shown in the following table.

Table 4-4 Status display when calibration is completed

Cal Type box	Display below the Cal Menu button		Status bar on the bottom of the screen	
	Before calibration	After calibration	Before calibration	After calibration
User Freq&Pwr	[Uncal] →	[User]	Uncal →	Cal User
Fixed Freq&Pwr	[Uncal] →	[Fix]	Uncal →	Cal Fix
FixedFreq,UserPwr	[Uncal] →	[FixR]	Uncal →	Cal FixR

STEP 7. Entering Thickness of MUT

You must enter the thickness of the MUT before you can perform measurement. Use a micrometer or calipers to measure the thickness.

NOTE

The 16453A test fixture imposes restrictions on the thickness and diameter of the MUT (see Table 4-1 on page 108).

- Step 1.** Click **Utility...** on the **Utility** menu.
- Step 2.** Click the **Material Option Menu** button.
- Step 3.** In the **Thickness** box, enter the thickness of the MUT. For example, if the MUT is 1 mm in thickness, type **[1] [m] [Enter]** with the keyboard.

STEP 8. Connecting MUT

As with the load standard (Figure 4-8), connect the MUT to the 16453A test fixture by inserting it between the test fixture's upper and lower electrodes.

NOTE

When connecting a load standard or a MUT to the test fixture, make sure that it only comes into contact with the test fixture's electrodes. Also, be careful not to give the upper electrode horizontal pressure by moving the load standard or the MUT while it is in position between the electrodes.

NOTE

If the pressure from the upper and lower electrodes is too weak, this may create a gap between the MUT and the electrodes and thus cause measurement errors. It is recommended that the pressure be maximized to the extent that it does not deform the MUT. For best repeatability when measuring both a load standard and a MUT, connect them to the test fixture with the same pressure.

STEP 9. Measuring MUT and Analyzing Measurement Results

Results

After performing calibration, the measurement results are displayed on the screen when the MUT is set on the test fixture. Analyze the measurement results using a marker function while referencing to “STEP 8. Measuring DUT and Analyzing Measurement Results” on page 82 in Chapter 3, “Basic Operations for RF Devices Measurement.”

You will obtain the following measurement results by executing auto scale for individual parameters while using the setup example of “STEP 3. Setting Measurement Conditions” on page 111.

Figure 4-9

Frequency characteristics of ϵ_r' - ϵ_r'' - $\tan\delta$

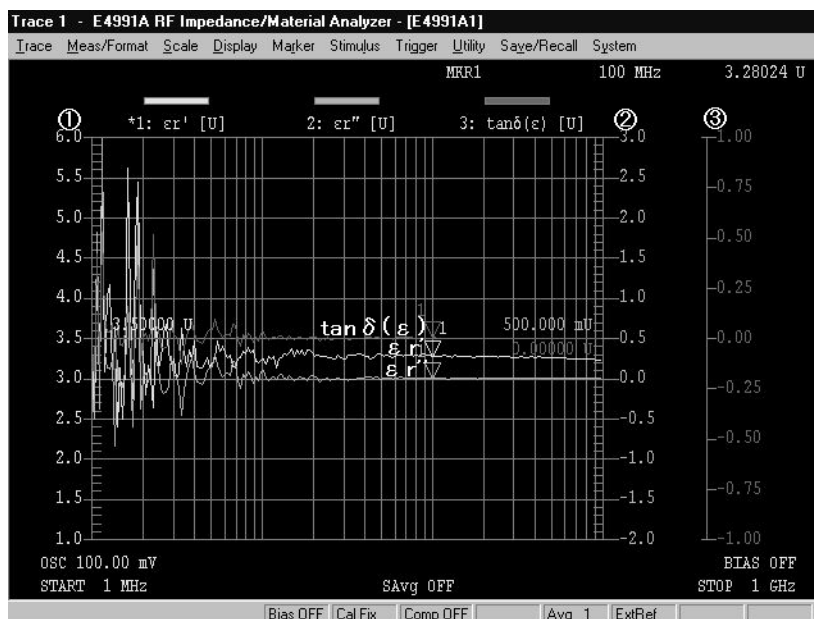

- ① Trace 1 axis : ϵ_r'
- ② Trace 2 axis : ϵ_r''
- ③ Trace 3 axis : $\tan \delta (\epsilon)$

STEP 10. Changing Sweep Conditions

When the measurement points for calibration are user-defined frequency/user-defined power points, start measurement with “STEP 6. Calibration” on page 115 after changing the measurement conditions. When the measurement points for calibration are fixed frequency/fixed power points, start measurement with “STEP 9. Measuring MUT and Analyzing Measurement Results” on page 122 after changing the measurement conditions.

NOTE

When the measurement points for calibration are fixed frequency/user-defined power points, start measurement with “STEP 6. Calibration” on page 115 after changing the oscillator level. When you change other sweep conditions, start measurement with “STEP 9. Measuring MUT and Analyzing Measurement Results” on page 122.

STEP 11. Measuring Other MUTs

If you measure another MUT of the same thickness as the one in the previous measurement, start measurement with “STEP 8. Connecting MUT” on page 121. If you measure a MUT of a different thickness, start measurement with “STEP 7. Entering Thickness of MUT” on page 120.

Basic Operations for Dielectric Measurement
STEP 11. Measuring Other MUTs

5 Basic Operations for Magnetic Measurement

This chapter explains the basic operations for taking magnetic measurements with the Agilent E4991A. To perform this type of measurement, the Option 002 (Material Measurement) software must be installed.

Organization of This Chapter

- o Magnetic Measurement Overview page 127
Measurement example and a basic flow for magnetic measurement.
- o STEP 1. Preparation for Measurement page 128
How to prepare for measurement.
- o STEP 2. Selecting Measurement Mode page 130
How to set the E4991A measurement mode to magnetic measurement mode.
- o STEP 3. Setting Measurement Conditions page 131
How to set sweep conditions and measurement parameters.
- o STEP 4. Calibration page 133
How to perform OPEN / SHORT / LOAD (/ LOW-LOSS CAPACITOR) calibrations.
- o STEP 5. Connecting 16454A page 135
How to connect the 16454A test fixture to the 7-mm terminal of the test head.
- o STEP 6. Fixture Compensation page 137
How to perform SHORT compensation. Describes how to perform SHORT compensation for the 16454A test fixture.
- o STEP 7. Entering MUT Dimensions page 138
How to enter MUT (magnetic material) sizes.
- o STEP 8. Mounting MUT page 139
How to mount a MUT (magnetic material) in the 16454A test fixture.
- o STEP 9. Measuring MUT and Analyzing Measurement Results page 140
How to achieve the optimum setting of the vertical axis scale and analyze the measurement results.
- o STEP 10. Changing Sweep Conditions page 141
How to change sweep conditions.
- o STEP 11. Measuring Other MUTs page 141
How to measure other MUTs.

Magnetic Measurement Overview

When the E4991A has option 002 installed, magnetic measurement is possible. This chapter describes the basic operations done by using the mouse and keyboard to evaluate the following characteristics:

- Frequency characteristics of μ_r' - μ_r'' - $\tan\delta$

Flow for Magnetic Measurement

The basic procedure for magnetic measurement is given in the flow chart of Figure 5-1.

Figure 5-1 Basic procedure for magnetic measurement

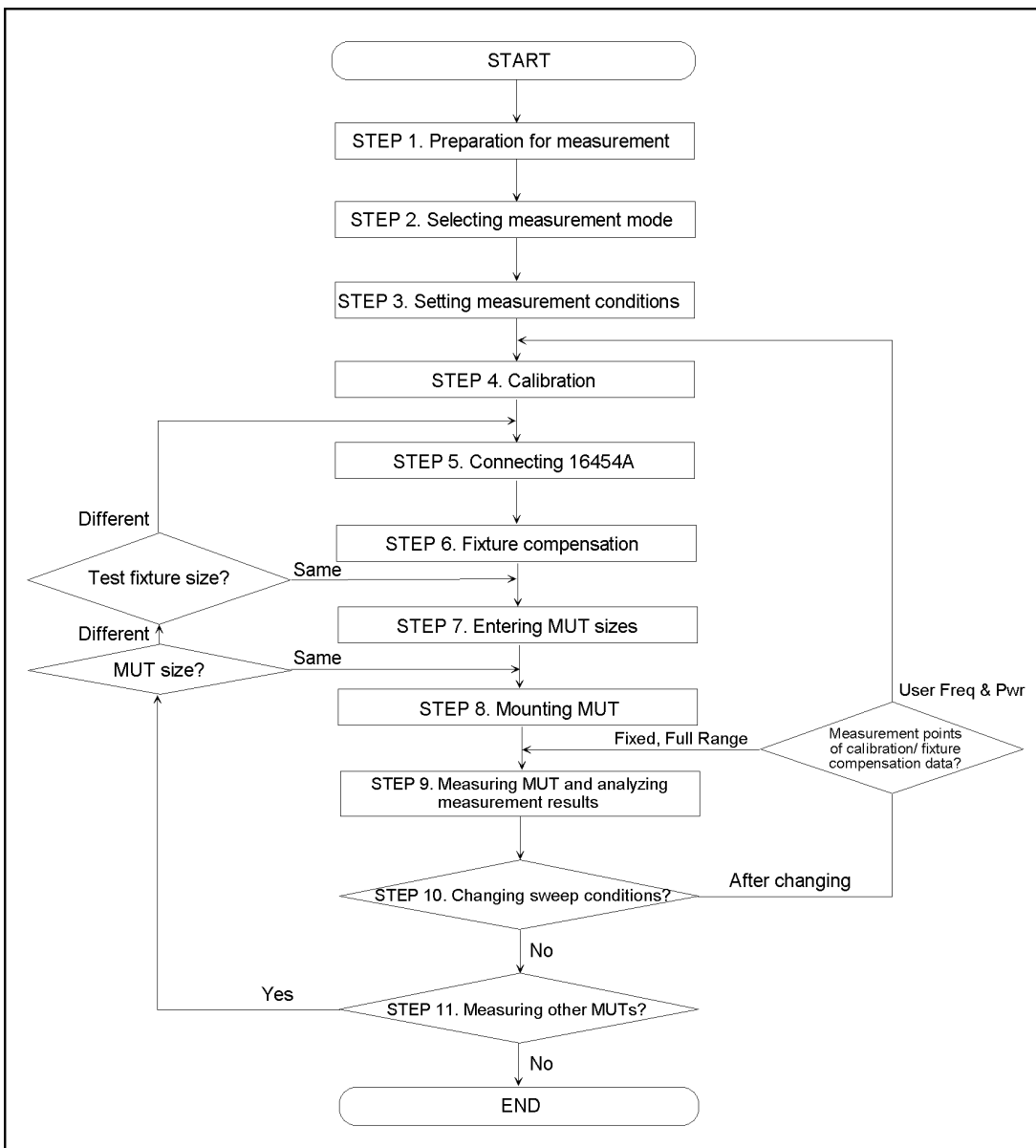

e4991aqe518

STEP 1. Preparation for Measurement

Selection of MUT and Test Fixture

With the E4991A, the 16454A test fixture can be used to measure magnetic materials. The applicable dielectric materials are toroidal cores with a donut shape, such as ferrite magnets (Figure 5-2).

Figure 5-2

Applicable magnetic materials

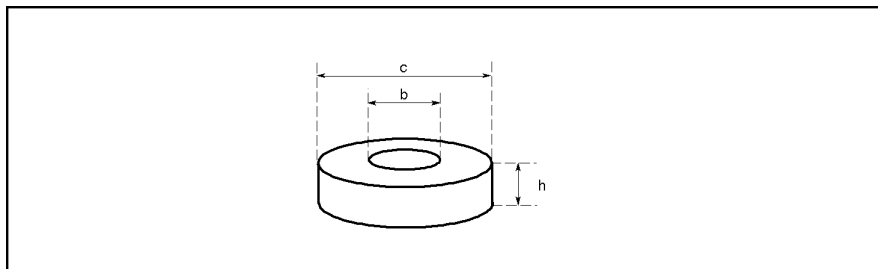

e4991aqj512

Table 5-1

Features of 16454A test fixture

Frequency range	Maximum dc bias current value	Magnetic material size
1 M to 1 GHz	± 50 mA	$b \geq \phi 3.1$ mm $c \leq \phi 20.0$ mm $h \leq 8.5$ mm

Required Equipment

The following equipment is required to perform magnetic measurement.

Figure 5-3

Required equipment

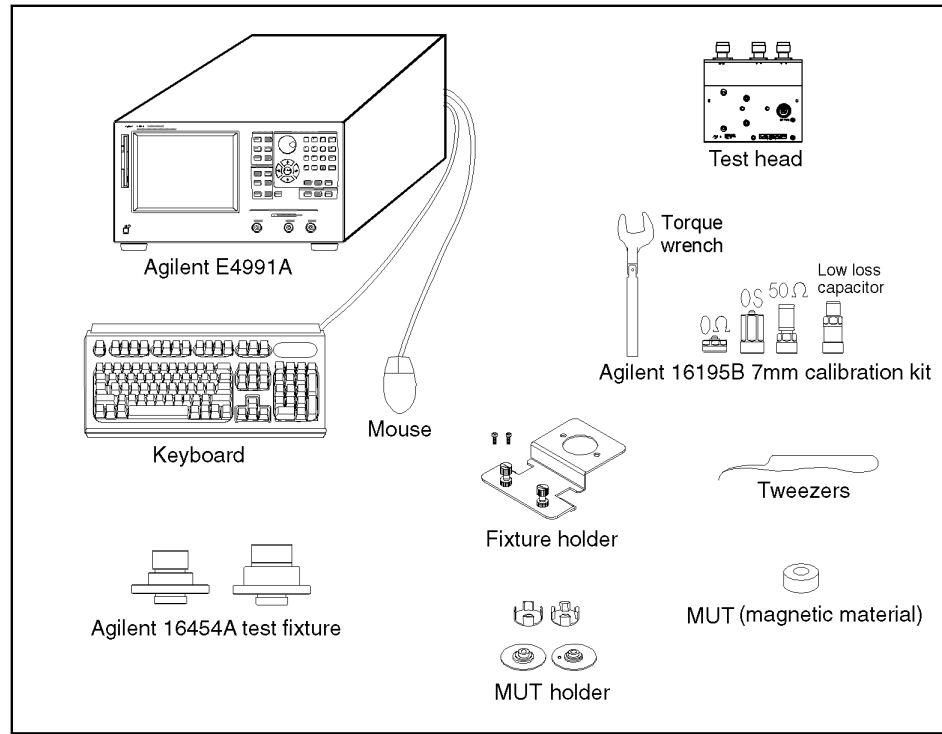

e4991aqe511

Connecting Mouse, Keyboard, and Test Head



Connect the mouse, keyboard, and test head to the E4991A by referring to “Connection to Rear Panel” on page 27 and “Connecting the Test Head” on page 28. Be sure not to remove the four feet on the bottom of the E4991A when connecting the test head.

NOTE Be sure to connect the mouse and keyboard before turning the power ON.

NOTE Do not connect the test fixtures to the test head at this point because a calibration is performed on the DUT port (7-mm terminal) of the test head later.

Turning the Power ON

Perform the following steps to turn the power ON. The E4991A starts a self-test automatically when the power is turned ON.

- Step 1.** If the standby switch (⏻) in the lower-left part of the front panel is in the depressed position (), press it to put it in the popped up position ().
- Step 2.** Press the standby switch to the depressed position ().

NOTE Special caution is required when turning the power ON or OFF. Refer to “Turning the Power ON and OFF” on page 31.

STEP 2. Selecting Measurement Mode

You must set the E4991A measurement mode from the initial state to the magnetic measurement mode.

- Step 1.** Click **Preset** on the **System** menu to set the initial state.
- Step 2.** Click **Utility...** on the **Utility** menu.
- Step 3.** Click the **Material Option Menu** button.
- Step 4.** Select **Permeability** in the **Material Type** box.

STEP 3. Setting Measurement Conditions

Before starting the measurement, you must set the measurement parameters and sweep conditions according to your measurement requirements. This section describes the setup procedure for the following measurement.

- Frequency characteristics of μ_r' - μ_r'' - $\tan\delta$

First you should change the measurement conditions from the initial state of the E4991A as shown in Table 5-2.

Table 5-2 Setup example for this measurement

Parameter setting		Setup example	Initial state
Measurement parameters	Trace 1	μ_r'	μ_r'
	Trace 2	μ_r''	μ_r''
	Trace 3	$\tan\delta$	$\tan\delta$
Display formats	Trace 1	linear	linear
	Trace 2	linear	linear
	Trace 3	linear	linear
Sweep parameter		Frequency	Frequency
Sweep type		Log	Linear
Source mode		Current	Voltage
Oscillator level		2 mA	100 mV(2 mA)
Sweep range (Frequency)		1 MHz to 1 GHz	1 MHz to 3 GHz

Setting the Measurement Parameters and Display Formats

- Step 1.** Click **Display...** on the **Display** menu.
- Step 2.** Select **3 Scalar** in the **Num of Traces** box.
- Step 3.** Click **Meas/Format...** on the **Meas/Format** menu.
- Step 4.** Specify Trace 1 as the active trace (* mark) and select μ_r' in the **Meas Parameter** box.
- Step 5.** Select **Lin Y-Axis** in the **Format** box.
- Step 6.** Specify Trace 2 as the active trace (* mark) and select μ_r'' in the **Meas Parameter** box.
- Step 7.** Select **Lin Y-Axis** in the **Format** box.
- Step 8.** Specify Trace 3 as the active trace (* mark) and select $\tan\delta$ (μ) in the **Meas Parameter** box.

Basic Operations for Magnetic Measurement

STEP 3. Setting Measurement Conditions

Step 9. Select **Lin Y-Axis** in the **Format** box.

Setting the Measurement Points, Sweep Parameter and Sweep Type

Step 1. Click **Sweep Setup...** on the **Stimulus** menu.

Step 2. In the **Number Of Points** box, enter the desired measurement points. For example, if you want to enter 300, type **[3] [0] [0] [Enter]** with the keyboard.

Step 3. Select **Frequency** in the **Sweep Parameter** box.

Step 4. Select **Log** in the **Sweep Type** box.

Setting the Source Mode and Oscillator Level

Step 1. Click **Source...** on the **Stimulus** menu.

Step 2. Select **Current** in the **Osc Unit** box.

Step 3. In the **Osc Level** box, enter the oscillator level. For example, if you want to enter 2 mA, type **[2] [m] [Enter]** with the keyboard.

Setting the Sweep Range (Frequency)

Step 1. Click **Start/Stop...** on the **Stimulus** menu.

Step 2. In the **Start** box, enter the start frequency. For example, if you want to enter 1 MHz, type **[1] [M] [Enter]** with the keyboard.

Step 3. In the **Stop** box, enter the stop frequency. For example, if you want to enter 1 GHz, type **[1] [G] [Enter]** with the keyboard.

STEP 4. Calibration

Calibration is performed by using the 7-mm terminal of the test head as the calibration reference plane (Figure 5-4). Unlike impedance measurement, fixture compensation after calibration requires only SHORT compensation (see Table 5-3).

Figure 5-4

Error model of 16454A test fixture

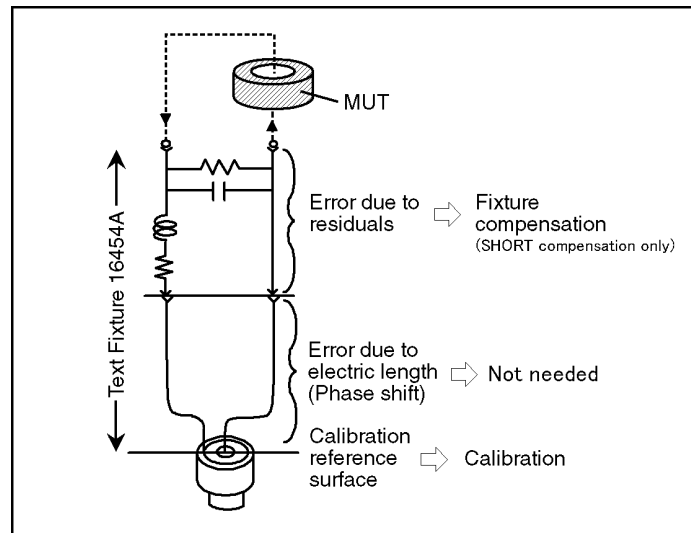

e4991aqe519

Table 5-3

Differences in calibration and fixture compensation between impedance and magnetic measurement

Correction	Impedance measurement	Magnetic measurement
Calibration reference surface	7-mm terminal (usual)	7-mm terminal
Electric length compensation	Required	Not required
Fixture compensation	OPEN/SHORT compensation	SHORT compensation only

- Step 1.** Click **Cal/Comp...** on the **Stimulus** menu.
- Step 2.** Click the **Cal Menu** button.
- Step 3.** In the **Cal Type** box, select the desired type of measurement points for the calibration/fixture compensation data. For details on the measurement points of the calibration data, refer to Table 3-7, “Types of measurement points for calibration/fixture compensation data,” on page 60, and Table 3-8, “Cal Type box settings and measurement points for calibration/fixture compensation data,” on page 61.
- Step 4.** Connect the 0 S (OPEN) standard to the 7-mm terminal of the test head (see Figure 3-31 on page 62).

STEP 4. Calibration

Step 5. Click the **Meas Open** button to start measuring OPEN calibration data. Upon completion of the OPEN calibration data measurement, a \checkmark mark appears on the left side of the **Meas Open** button.

NOTE

During calibration data measurement, the message “Wait-Measuring Cal Standard” appears at the left end of the status bar at the bottom of the screen.

Step 6. Connect the 0 Ω (SHORT) standard to the 7-mm terminal of the test head (see Figure 3-33 on page 63).

Step 7. Click the **Meas Short** button to start measuring SHORT calibration data. Upon completion of the SHORT calibration data measurement, a \checkmark mark appears on the left side of the **Meas Short** button.

Step 8. Connect the 50 Ω (LOAD) standard to the 7-mm terminal of the test head (see Figure 3-36 on page 64).

Step 9. Click the **Meas Load** button to start measuring LOAD calibration data. Upon completion of the LOAD calibration data measurement, a \checkmark mark appears on the left side of the **Meas Load** button.

Step 10. Measure LOW-LOSS CAPACITOR calibration data, if necessary. Connect the LOW-LOSS CAPACITOR to the 7-mm terminal of the test head (see Figure 3-38 on page 65). Then click the **Meas Low Loss C** button to start measuring LOW-LOSS CAPACITOR calibration data. Upon completion of the LOW-LOSS CAPACITOR calibration data measurement, a \checkmark mark appears on the left side of the **Meas Low Loss C** button.

NOTE

When you measure a low loss magnetic material, measure LOW-LOSS CAPACITOR calibration data. This allows high accuracy for high Q measurement at high frequencies.

Step 11. Click the **Done** button to instruct the E4991A to calculate the calibration coefficient from the measured calibration data and save it to the internal memory.

Step 12. Depending on the measurement points of the calibration/fixture compensation data specified in the **Cal Type** box, the display below the **Cal Menu** button and the status bar at the bottom of the screen will change, as shown in Table 4-4 on page 119.

STEP 5. Connecting 16454A

The 16454A test fixture has two sizes: Small and Large. In addition, it has four MUT holders. Select the size of the MUT holder that best suits your needs (see Table 5-4 and Figure 5-5). This selection determines whether the 16454A (Small) or 16454A (Large) test fixture is the appropriate test fixture, as shown in Figure 5-5.

Table 5-4 MUT size for test fixtures

Test fixture	16454A (Small)		16454A (Large)	
	A	B	C	D
MUT inner diameter (mm): b	$\geq \phi 3.1$ mm	$\geq \phi 3.1$ mm	$\geq \phi 6.0$ mm	$\geq \phi 5.0$ mm
MUT outer diameter (mm): c	$\leq \phi 8.0$ mm	$\leq \phi 6.0$ mm	$\leq \phi 20.0$ mm	$\leq \phi 20.0$ mm
MUT height (mm): h	≤ 3.0 mm	≤ 3.0 mm	≤ 8.5 mm	≤ 8.5 mm

Figure 5-5 MUT holder sizes

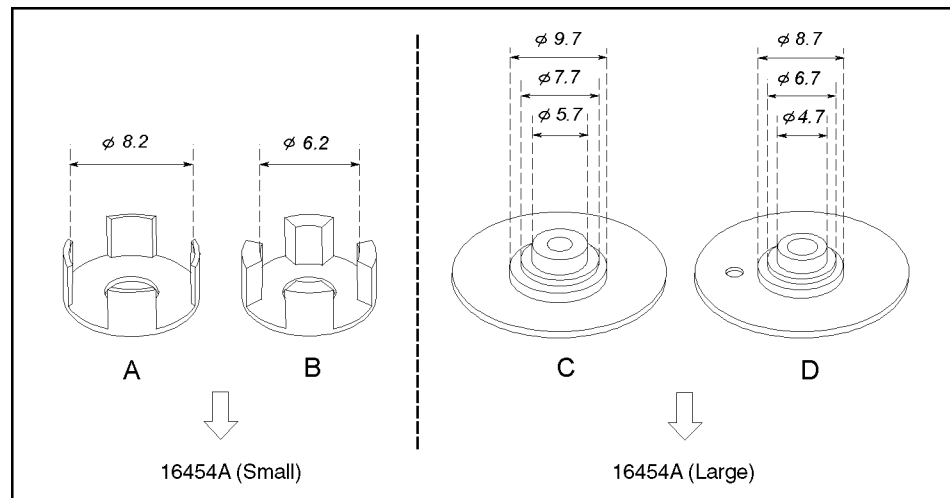

e4991aqe520

Connect the selected test fixture to the 7-mm terminal of the test head by following these steps.

- Step 1.** As shown in Figure 3-42 on page 70, turn the 7-mm connector nut of the test head counterclockwise until the connector sleeve is fully retracted.
- Step 2.** Tighten the two small screws of the fixture holder to secure the fixture holder to the test fixture body (Figure 5-6: 2).
- Step 3.** Tighten the two large screws of the test holder to secure the test fixture to the test head (Figure 5-6, 3).
- Step 4.** Connect the 7-mm connector of the test fixture to the 7-mm terminal of the test head (Figure 5-6, 4).

Basic Operations for Magnetic Measurement
STEP 5. Connecting 16454A

Figure 5-6

Connecting the 16454A

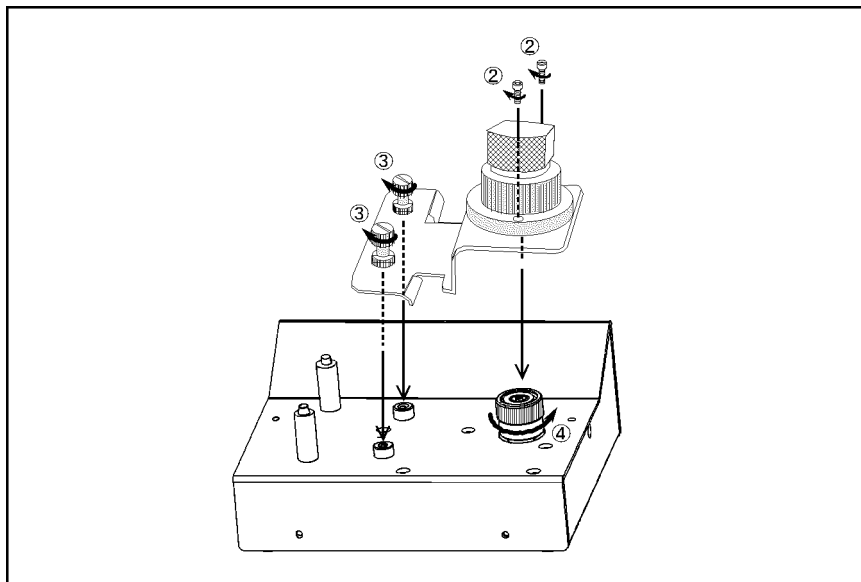

e4991aqj523

Step 5. Click **Cal/Compen...** on the **Stimulus** menu.

Step 6. In the **Fixture Type** box, select 16454A (S) or 16454A (L).

Table 5-5

Fixture Type box settings and test fixtures

Fixture Type box	Test fixture to be used
16454(S)	16454A (Small)
16454(L)	16454A (Large)

NOTE

When you select the E4991A Magnetic Material measurement mode, you can use either the 16454A (Small) or 16454A (Large) test fixture.

STEP 6. Fixture Compensation

With the 16454A test fixture, you perform only SHORT compensation to correct residual impedance due to the test fixture. OPEN compensation is not performed because errors due to stray admittance are so small that they can be neglected.

- Step 1.** Click **Cal/Conpen...** on the **Stimulus** menu.
- Step 2.** Click the **Comp Menu** button.
- Step 3.** Set the MUT connection plane of the test fixture to the SHORT state (Figure 5-7).

Figure 5-7 **SHORT state (16454A)**

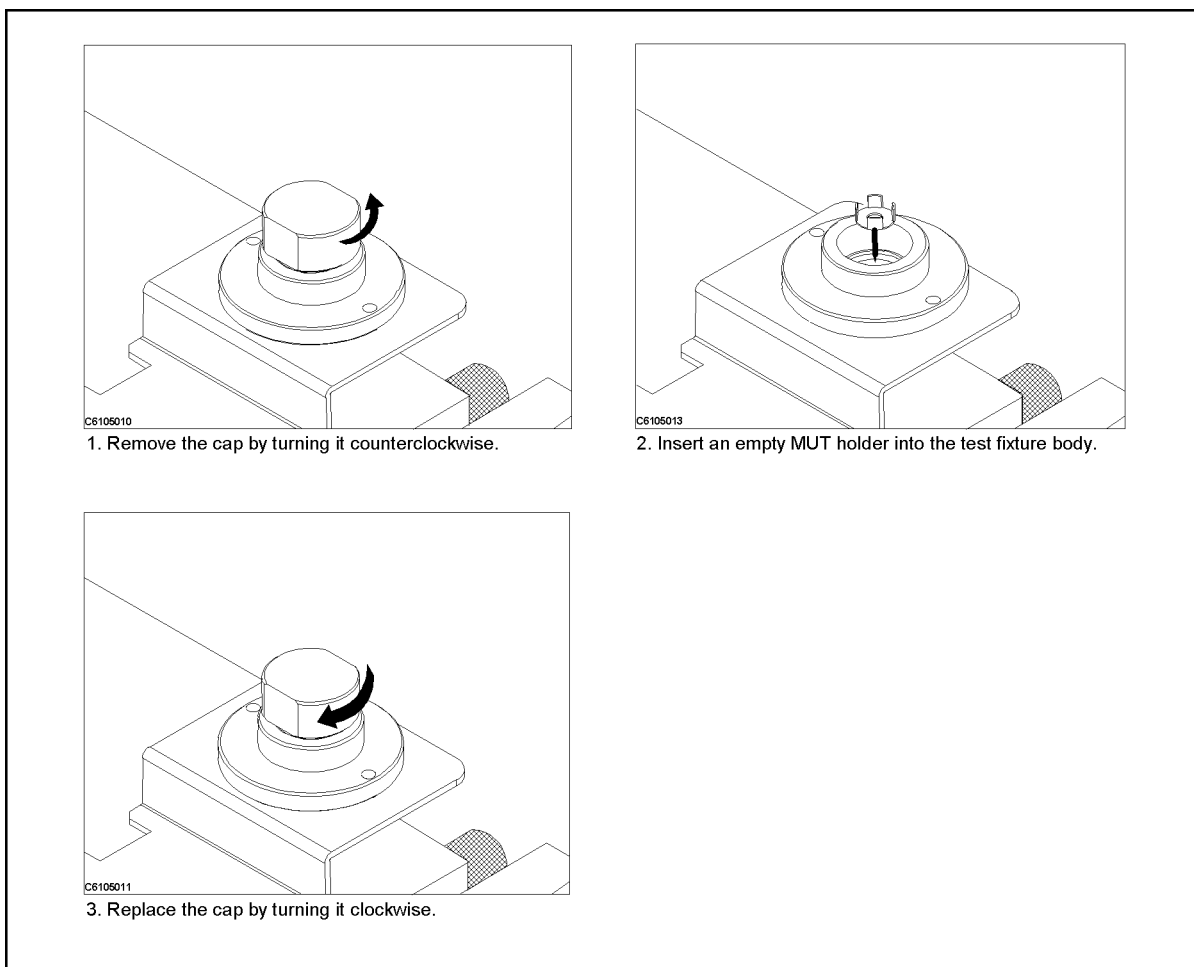

e4991aqe513

- Step 4.** Click the **Meas Short** button to start measuring SHORT compensation data. Upon completion of the SHORT compensation data measurement, a \checkmark mark appears on the left side of the **Meas Short** button.
- Step 5.** Click the **Done** button to instruct the E4991A to calculate the fixture compensation coefficient from the measured fixture compensation data and save it to the internal memory.

Basic Operations for Magnetic Measurement
STEP 7. Entering MUT Dimensions

Step 6. Verify that the display below the **Comp Menu** button changes to **[ON]** and the status bar at the bottom of the screen changes to “Comp ON”.

STEP 7. Entering MUT Dimensions

You must enter the MUT dimensions before you can perform measurement. Use a micrometer or calipers to measure the outer (see c of Figure 5-2 on page 128) and inner (see b of Figure 5-2 on page 128) diameters and height (see h of Figure 5-2 on page 128).

NOTE

The 16454A test fixture imposes restrictions on the outer and inner diameters and height of the MUT (see Table 5-1 on page 128).

Step 1. Click **Utility...** on the **Utility** menu.

Step 2. Click the **Material Option Menu** button.

Step 3. In the **Height** box, enter the height of the MUT (see h in Figure 5-2). For example, if the MUT is 3 mm in height, type **[3] [m] [Enter]** with the keyboard.

Step 4. In the **Inner Diameter** box, enter the inner diameter of the MUT (see b in Figure 5-2). For example, if the inner diameter is 4.5 mm, type **[4] [.] [5] [m] [Enter]** with the keyboard.

Step 5. In the **Outer Diameter** box, enter the outer diameter of the MUT (see c in Figure 5-2). For example, if the outer diameter is 7-mm, type **[7] [m] [Enter]** with the keyboard.

NOTE

The selection of a smaller test fixture imposes restrictions on the MUT dimensions that can be entered.

STEP 8. Mounting MUT

Mount a MUT (magnetic material) in the 16454A test fixture as shown in Figure 5-8.

Figure 5-8 **Mounting MUT (magnetic material)**

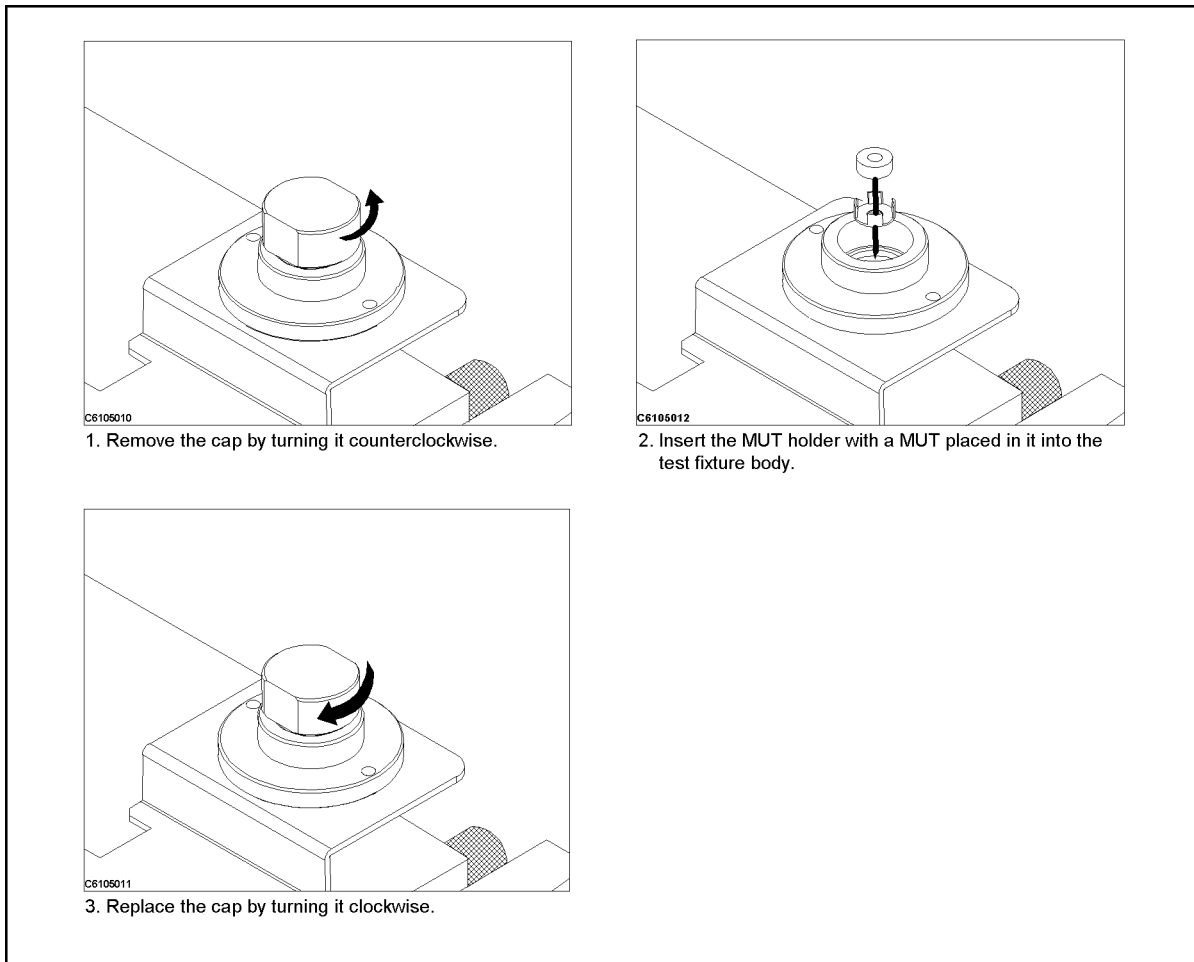

e4991aqe514

STEP 9. Measuring MUT and Analyzing Measurement Results

Results

After performing calibration, the measurement results are displayed on the screen when the MUT is set on the test fixture. Analyze the measurement results by using a marker function while referring to “STEP 8. Measuring DUT and Analyzing Measurement Results” on page 82 in Chapter 3, “Basic Operations for RF Devices Measurement.”

You will obtain the following measurement results by executing auto scale for individual parameters while using the setup example of “STEP 3. Setting Measurement Conditions” on page 131.

Figure 5-9

Frequency characteristics of $\mu_r' - \mu_r'' - \tan\delta$

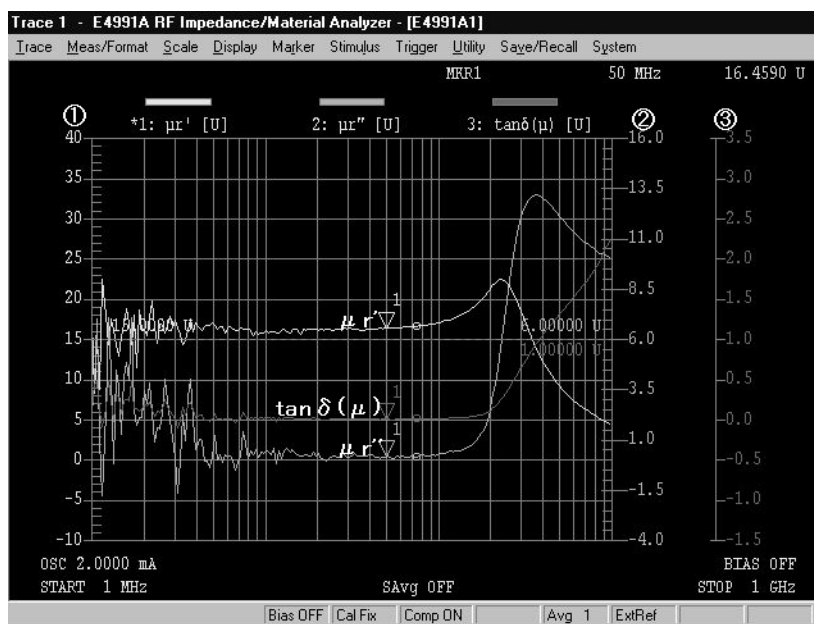

- ① Trace 1 axis : μ_r'
- ② Trace 2 axis : μ_r''
- ③ Trace 3 axis : $\tan\delta(\mu)$

STEP 10. Changing Sweep Conditions

When the measurement points for calibration/fixture compensation are user-defined frequency/user-defined power points, start measurement with “STEP 4. Calibration” on page 133 after changing the sweep conditions. When the measurement points for calibration/fixture compensation are fixed frequency/fixed power points, start measurement with “STEP 9. Measuring MUT and Analyzing Measurement Results” on page 140 after changing the sweep conditions.

NOTE

When the measurement points for calibration/fixture compensation are fixed frequency/user-defined power points, start measurement with “STEP 4. Calibration” on page 133 after changing the oscillator level. When you change other sweep conditions, start measurement with “STEP 9. Measuring MUT and Analyzing Measurement Results” on page 140.

STEP 11. Measuring Other MUTs

If you measure another MUT of the same size as the one used in the previous measurement, start measurement with “STEP 8. Mounting MUT” on page 139. If you use the same test fixture to measure a MUT of a different size, start with “STEP 7. Entering MUT Dimensions” on page 138. When using a different test fixture, start with “STEP 5. Connecting 16454A” on page 135.

Basic Operations for Magnetic Measurement
STEP 11. Measuring Other MUTs

A **Manual Changes**

This appendix contains the information required to adapt this manual to versions or configurations of the E4991A manufactured earlier than the current printing date of this manual.

Manual Changes

To adapt this manual to your E4991A, refer to Table A-1 and Table A-2.

Table A-1 Manual Changes by Serial Number

Serial Prefix or Number	Make Manual Changes

Table A-2 Manual Changes by Firmware Version

Version	Make Manual Changes

The ten-character serial number is stamped on the serial number plate (Figure A-1) on the rear panel.

Figure A-1 Serial Number Plate



e4991aj6001

Miscellaneous Changes

The option system of the E4991A has changed since May 2003. Apply the following changes.

New Option Number	Old Option Number	Remark
800 (Standard Frequency Reference, No DC Bias)	Standard	*1
same as the right number	1D5 (High Stability Frequency Reference)	
810 (Mini DIN Keyboard)	-	*2
-	1A2 (Delete Mini DIN Keyboard)	
820 (Mouse)	-	*3
-	1CS (Without Mouse)	
same as the right number	001 (Add DC Bias)	
same as the right number	002 (Material Measurement Firmware)	
same as the right number	007 (Temperature Characteristic test kit)	
same as the right number	010 (Probe Station Connection Kit)	
same as the right number	1CN (Handle Kit)	
same as the right number	1CM (Rack Mount Kit)	
same as the right number	1CP (Rack Mount & Handle Kit)	
ABA (Add Manual set (English))	-	*4
-	ABA (Select Manual set (English))	
ABJ (Add Manual set(Japanese))	-	*4
-	ABJ (Select Manual set (Japanese))	
same as the right number	0BW (Add Service Manual)	
-	0B1 (Delete Manual Sets)	*5
-	0B1 (Add Manual Sets)	

*1. In the previous system, an option for the frequency reference was available only for the high stability frequency reference. In the new option system, it is available for the high stability and standard references, requiring the customer to select either of them.

*2. In the previous option system, the keyboard comes as one of standard accessories. In the new option system, it will be attached only when you choose option 810.

*3. In the previous option system, the mouse comes as one of standard accessories. In the new option system, it will be attached only when you choose option 820.

Manual Changes

Manual Changes

- *4. In the previous system, the option number is used to choose the language of the manual set (standard accessory). In the new option system, it is used to add an manual set (optional accessory) of the language the customer desires.
- *5. No selection of addition/deletion is required for the manual set because it is only available as an optional accessory in the new option system. When 2 or more sets are required, specify option ABA,ABJ * (number of required sets).

Numerics

16197A

- connecting test fixture, 70
- method of OPEN compensation, 73
- method of SHORT compensation, 75

16453A

- connecting 16453A, 113
- error model, 115
- features of 16453A, 108
- LOAD calibration, 118
- OPEN calibration, 117
- SHORT calibration, 116

16454A

- connecting 16454A, 135
- error model, 133
- features of 16454A, 128
- SHORT compensation, 137

A

- Abort Cal Meas button, 63
- Abort Comp Meas button, 74
- active trace
 - Making a trace active, 48
- analysis
 - reading trace values, 90
- auto scale
 - performing auto scale, 83
- Autoscale All
 - performing auto trace for all traces, 83
- averaging
 - concept of point averaging, 87
 - concept of sweep averaging, 87
 - setting point averaging, 88
 - setting sweep averaging, 89

B

- block
 - Font rules in this manual, 5
- BNC cable
 - connecting BNC cable, 27
- bold
 - Font rules in this manual, 5
- Bottom box
 - scaling parameter, 86
- box
 - Font rules in this manual, 5
- button
 - Font rules in this manual, 5

C

- calibration
 - calibration for dielectric measurement, 115
 - calibration for impedance measurement, 60
 - calibration for magnetic measurement, 133
 - calibration reference plane, 60
 - calibration reference plane for dielectric measurement, 115

- calibration reference plane for magnetic measurement, 133
- difference between calibration for impedance measurement and dielectric measurement, 115
- difference between calibration for impedance measurement and magnetic measurement, 133
- LOW-LOSS CAPACITOR calibration, 65
- recover calibration data, 66
- reset calibration data, 66
- status display for validating calibration, 66, 119
- stopping calibration data measurement, 63
- types of calibration measurement data points, 60
- Calibration Type box, 61
 - setting calibration data points, 60
- cleaning
 - instructions for cleaning, 37
- compensation
 - fixture compensation for impedance measurement, 73
- connection to rear panel, 27
- Contents
 - Option 007, 21
 - Option 010, 21
- correction
 - calibration for dielectric measurement, 115
 - calibration for impedance measurement, 60
 - calibration for magnetic measurement, 133
 - fixture compensation for impedance measurement, 73
 - fixture compensation for magnetic measurement, 137
- CW Freq box
 - Setting CW frequency, 56
- CW frequency
 - continuous wave frequency, 56

D

- dc bias
 - applying dc bias, 82
 - dc bias (current) characteristics of Ls-Q, 58
 - Option 001, 58
- dielectric measurement
 - flow for dielectric measurement, 107
 - select dielectric measurement mode, 110
- display
 - displaying 3 traces, 47
 - displaying five windows, 101
 - displaying list of marker values, 93
 - displaying smith chart, 99
 - displaying traces on individual windows, 99
 - enlarging trace, 98
 - hide setup toolbar, 83
 - names of each area on LDC screen, 42
- drag & drop, 90
- DUT
 - connecting DUT(inductor), 81
- DUT port, 28
- DUTs
 - types and sizes of DUTs and test fixture, 36

E

E4991A
 features of E4991A, 14
electrical length
 electrical length of test fixture, 72
 inputting electrical length, 71
 selecting test fixture, 71
environmental requirements
 operation environment, 25
 ventilation space, 26
equivalent circuit
 performing equivalent circuit analysis, 96

F

features of E4991A, 14
Fixed Freq&Pwr, 61
FixedFreq&UserPwr, 61
fixture compensation
 case of taking fixture compensation data again, 78
 fixture compensation for magnetic measurement, 137
 status display for validating fixture compensation, 77
 stopping measurement of compensation data, 74
 types of fixture compensation measurement data points, 60
fixtures
 test fixture available for E4991A, 36
Font
 Font rules in this manual, 5
Format box
 setting display format, 48
frequency characteristics
 simulating frequency characteristics, 98
front handles
 how to install the handle kit, 23
Full Scale box
 scaling parameter, 86
fuse
 blown fuse, 30
 fuse type of the E4991A, 30

H

handle and rack-mount kit
 how to install the rack-mount and handle kit, 24
handle kit
 how to install the handle kit, 23
Height box
 enter sizes of magnetic material, 138
history,
 manual printing, 2
Hold Mode, 82

I

impedance measurement
 Dc bias (current) characteristics of Ls-Q, 58
 flow for impedance measurement, 41
 frequency characteristics of $|Z|$ -Ls-Q, 46
 frequency characteristics of $|Z|$ -R-X, 53

 oscillator level (current) characteristics of Ls-Q, 55
Initial registration, 33
Inner Diameter box
 enter sizes of magnetic material, 138
inspection
 incoming inspection, 17
Installation and Quick Start Guide, 6
Italic
 Font rules in this manual, 5

K

key
 Font rules in this manual, 5
keyboard
 connecting keyboard, 27

L

load standard
 enter thickness of load standard for dielectric measurement, 114

M

magnetic measurement
 flow for magnetic measurement, 127
 selecting magnetic measurement mode, 130
Manual
 About the Manual Regarding this Device, 6
manual
 how to use, 12
manual changes, 143
manual printing history, 2
marker
 clearing all markers, 95
 clearing marker, 95
 controlling markers of individual traces separately, 91
 detecting maximum value, 92
 displaying list of marker values, 93
 reading trace values, 90
 using marker function, 90
 using marker to read trace values in measurement points, 91
material
 applicable dielectric material, 108
measurement conditions
 Flow for setting measurement conditions, 45
measurement mode
 select dielectric measurement mode, 110
 selecting magnetic measurement mode, 130
measurement parameter
 dielectric measurement, 111
 magnetic measurement, 131
measurement parameters
 setting measurement conditions, 45
menu
 Font rules in this manual, 5
mouse
 connecting mouse, 27

-
- MUT**
 applicable dielectric material, 108
 applicable magnetic material, 128
 connecting MUT (dielectric material), 121
 enter sizes magnetic material, 138
 enter thickness for MUT, 120
 mounting MUT(magnetic material), 139
- N**
 Network Identification Wizard, 33
 noise
 performing averaging, 87
 NOP
 setting measurement points, 49
 Num Of Traces box
 displaying 3 traces, 47
 Number Of Points box
 Setting measurement points, 49
- O**
 Operational Manual, 6
 Option 001
 dc bias, 58
 Option 007 contents, 21
 Option 010 contents, 21
 OSC Level
 setting oscillator level, 50
 OSC Unit box
 setting source mode, 50
 Outer Diameter box
 enter sizes of magnetic material, 138
- P**
 package
 contents of package, 18
 power
 check the power supply, 29
 disconnecting device, 32
 disconnection from supply source, 32
 power cable options, 30
 shutdown, 31
 turning the power ON and OFF, 31
 verification and connection of power cable, 29
 power supply
 blown fuse, 30
 preparation
 preparation for dielectric measurement, 108
 preparation for impedance measurement, 43
 preparation for magnetic measurement, 128
 preset
 presetting the E4991A, 46
 Professional Setup wizard, 33
 Programming Manual, 6
- Q**
 Quick Start Guide, 6
- how to use, 12
- R**
 rack-mount and handle kit
 how to install the rack-mount and handle kit, 24
 rack-mount kit
 how to install the rack-mount kit, 24
 Recover Cal/Comp State box, 66
 Ref Pos box
 scaling parameter, 86
 Ref Val box
 scaling parameter, 86
 Registration, 33
 Reset Calibration button, 66
- S**
 safety
 symbols, 4
 safety summary, 3
 scale
 adjusting scale, 86
 performing auto scale, 83
 scaling parameter, 86
 screen
 displaying traces on individual windows, 99
 Serial number plate, 144
 shutdown
 turning the power OFF, 31
 simulation
 simulating frequency characteristics, 98
 smith chart, 99
 Softkey Off
 Turning off setup toolbar screen, 83
 Start box
 setting sweep range, 50
 Stop box
 setting sweep range, 50
 sweep
 setting sweep range, 50
 sweep conditions
 setting measurement conditions, 45
 Sweep Parameter box
 setting sweep parameter, 49
 Sweep Type box
 setting sweep type, 49
- T**
 test fixture
 connecting 16453A, 113
 connecting 16454A, 135
 connecting test fixture (16197A), 70
 error model of 16453A, 115
 error model of 16454A, 133
 features of 16453A, 108
 features of 16454A, 128
 LOAD calibration for 16453A, 118

-
- OPEN calibration for 16453A, 117
 - SHORT calibration for 16453A, 116
 - SHORT compensation for 16454A, 137
 - test fixtures available for E4991A, 36
 - test head
 - connecting test head, 28
 - N type connector, 28
 - thickness
 - enter thickness for MUT, 120
 - enter thickness of load standard for dielectric measurement, 114
 - Thickness box, 120
 - This Manual
 - Font Rules, 5
 - toolbar
 - Font rules in this manual, 5
 - Toolbar Off
 - hide setup toolbar, 83
 - Top box
 - scaling parameter, 86
 - trace
 - displaying 3 traces, 47
 - displaying traces on individual windows, 99
 - making a trace active, 48
 - smoothing a trace, 87
 - Trace menu
 - making a trace active, 48
 - trigger
 - activating continuous trigger, 83
 - activating single trigger, 82
 - U**
 - User Freq&Pwr, 61
 - W**
 - window
 - displaying five windows, 101
 - Windows 2000, 33
 - Z**
 - zoom
 - enlarging trace, 98