



The Next Generation
Optical Comparator

INSTANT MEASUREMENT

IMseries

NEW

Now It Is Possible To Take Faster, Easier, and More Consistent Measurements

Width, Radius, and Height Measurements.
All With One Device.

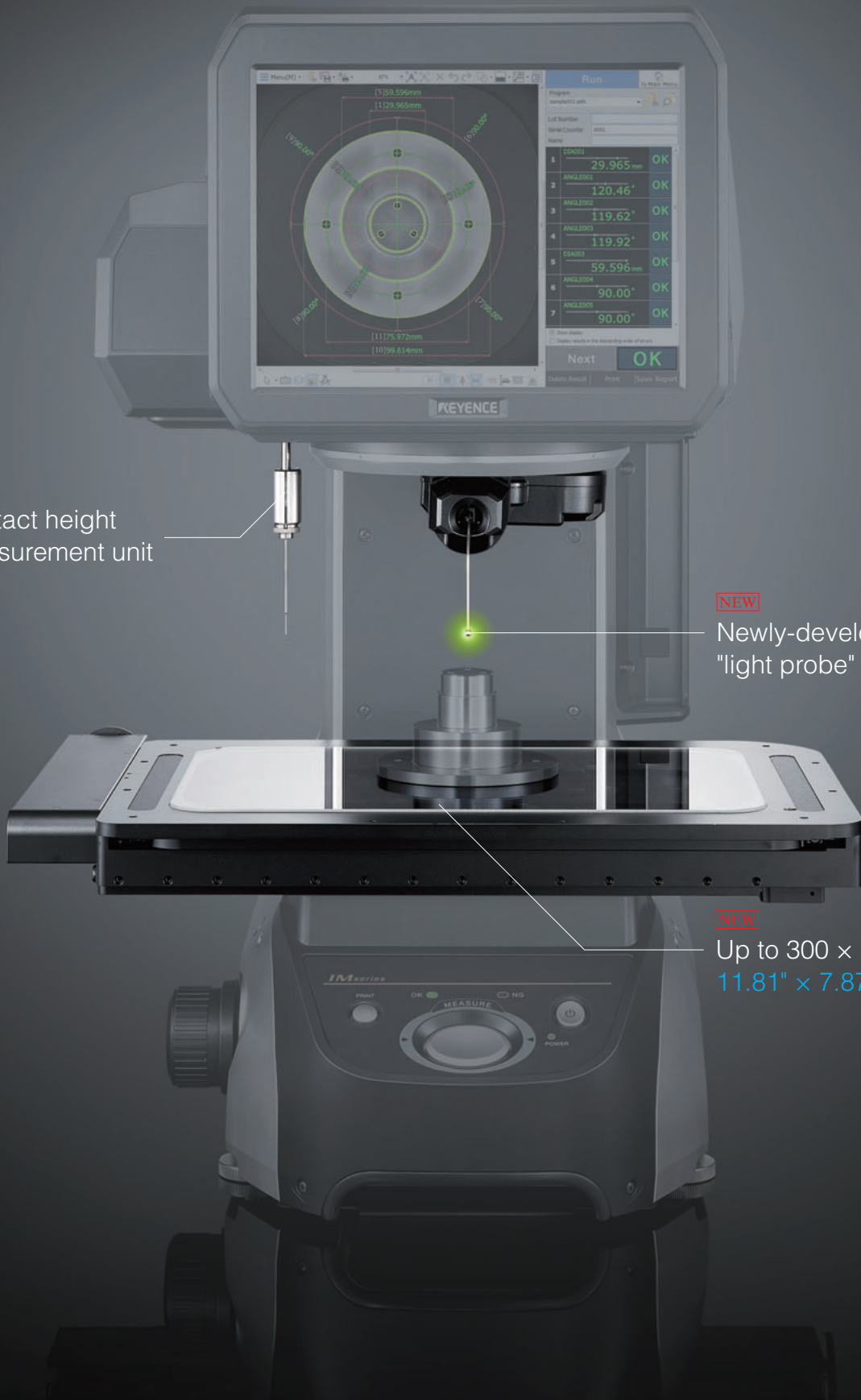

NEW

Contact height measurement unit

NEW

Newly-developed "light probe"

NEW

Up to 300 x 200 mm
11.81" x 7.87" stage

Run	
1	CSND01 29.965mm OK
2	ANGLED01 120.46° OK
3	ANGLED02 119.62° OK
4	ANGLED03 119.92° OK
5	CSND02 59.596mm OK
6	ANGLED04 90.00° OK
7	ANGLED05 90.00° OK

INSTANT MEASUREMENT

Increasing productivity by innovating inspection



Instant Measurement System Advantages

IM-7000 Series

Measurements Performed in Seconds

Drastically reduce the amount of time and effort required for inspection. With conventional methods, measurement time increases in relation to the amount of dimensions taken. With the IM Series, up to 99 dimensions can be measured in seconds.

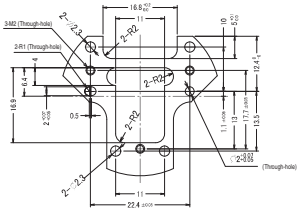

Intuitive Interface That Anyone Can Use

The easy-to-use interface allows anyone to operate the system at the push of a button, allowing for accurate and repeatable measurement results.

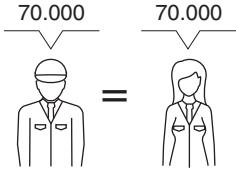

Measurement Results Are Automatically Recorded

Measurement data is automatically saved and managed as soon as a part is measured. Inspection reports can also be created with the push of a button to increase post-measurement work efficiency.

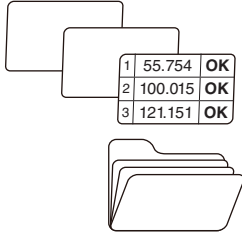

Common Problems with Dimensional Measurements

Conventional Measurement Tools

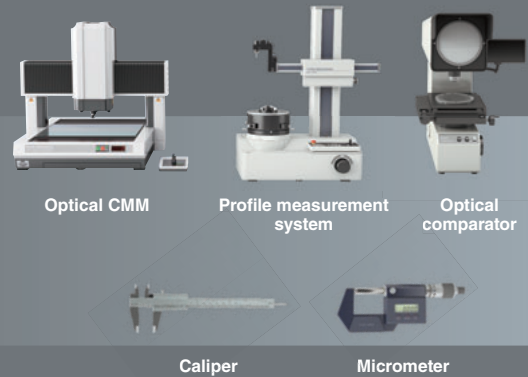

SLOW

- ▮ Adjusting complex fixtures for part placement and datum setup is time consuming
- ▮ An increase in the number of targets or measurement points can mean an exponential increase in required time
- ▮ Data management and creating inspection reports can be tedious

INCONSISTENT

- ▮ Differences in the way the tool is used can result in inconsistent measurements
- ▮ Changes in focus due to setup by different operators result in inconsistent values
- ▮ Measurements rely heavily on operator judgment and experience

COMPLICATED

- ▮ Learning how to operate the measuring instrument takes time
- ▮ Operator error easily occurs during measurement, especially radius inspection
- ▮ Dimensions requiring virtual lines or points add a layer of complexity

The IM-7000 Series Solves These Problems by Consolidating Conventional Tools into a Single System.



FAST

- No time consuming positioning work or datum setup required
- Measure up to 99 dimensions on up to 100 parts with the push of a button
- Automatically saves measurement data and creates inspection reports

CONSISTENT

- Automatically identifies measurement points, ensuring that the same measurement results are obtained each time
- Automatic focal adjustment prevents inconsistent values
- The simple place-and-press operation means consistent measurement results regardless of the operator

EASY

- Easily set up measurements with just a few clicks
- Setting up virtual lines and points is just as simple
- No measurement expertise is required to measure parts

Measurements Performed in Seconds

Step 1

Place

Step 2

Press



Automatic Recognition of Position and Orientation

The location and orientation of the part placed on the measurement stage are automatically detected. No need for precise positioning of the part.

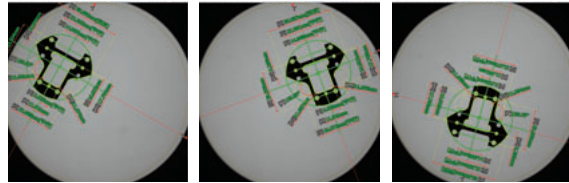

Parts can be measured no matter where they are placed within the field of view

Up to 99 Dimensions Measured at the Push of a Button

Identifies and measures up to a maximum of 99 dimensions with a single button press. Even if the number of dimensions is increased, the measurement time remains the same.

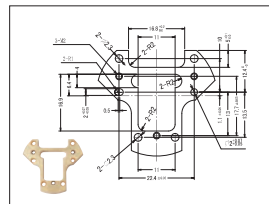

Drawing

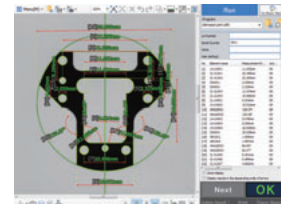

Measurement result

Inspect up to 99 Parts Simultaneously

The dimensions of all parts on the stage are measured simultaneously. There is no need to measure each part individually.

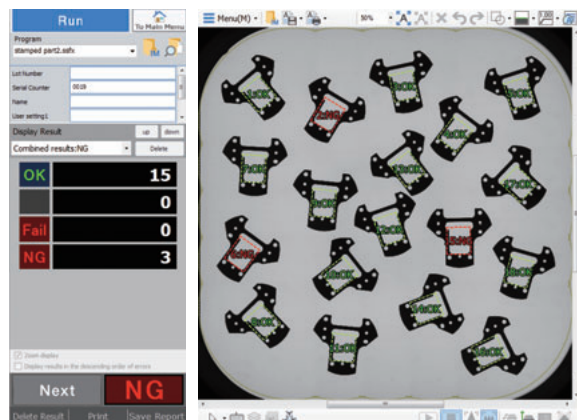

Eliminate Operator Error

Problems with Conventional Methods

Positioning errors

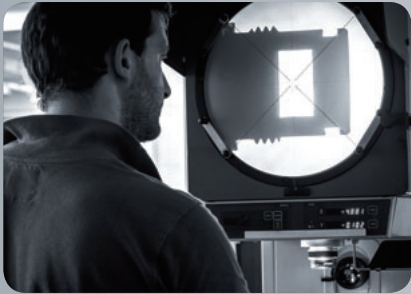

Focus errors



Skill level errors



Resolved with the IM-7000 Series

No positioning
required

Automated focus
adjustment

Consistent results
regardless of operator



Automated Focus Adjustments

The IM-7000 Series is equipped with a specifically designed optical lens with a large depth of field. It also automatically brings measurement points into focus. This is useful for parts with uneven surfaces, where all of the measurement areas cannot be brought into focus at the same time.

Parts with large height differences

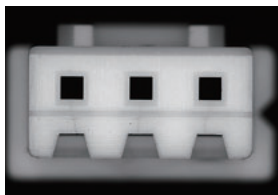

Only the upper image is in focus.



Only the lower image is in focus.



The focus is automatically adjusted for measurement

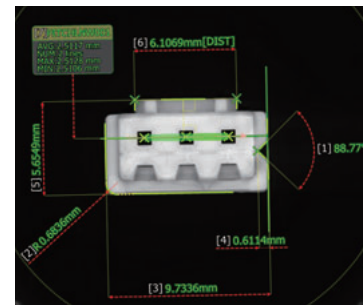

Automatic Edge Detection

Sub-pixel processing

By splitting each pixel into 100 or more sub-pixels, the IM-7000 Series is able to provide a wide field-of-view while maintaining its high-precision measurement capability.

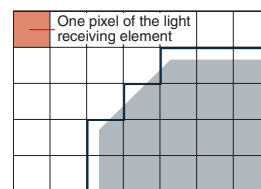

Without sub-pixel processing

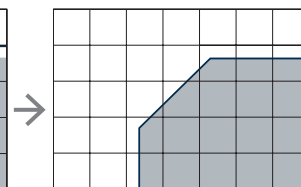

With sub-pixel processing

Shape processing

Lines and circles are detected using a least square fitting of 100 or more* detection points.

*There may be less than 100 points depending on the shape.

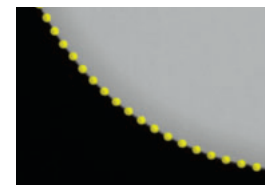

Automatic identification of burrs and chips

Burrs and chips found in the detection area are automatically recognized and excluded from the fitting process as abnormal locations. It is also possible to set the system to interrupt measurement when burrs or chips are found that are larger than the threshold.

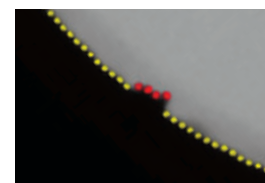

Easily Set up Measurements with Just a Few Clicks



Step 2

Select the measurement area

Step 1

Select tools

Easily Program Parts

Just select the desired tool from the menu and use the mouse to define the tool on the part. Settings are easy to make with intuitive mouse operations while verifying the image of the entire part.

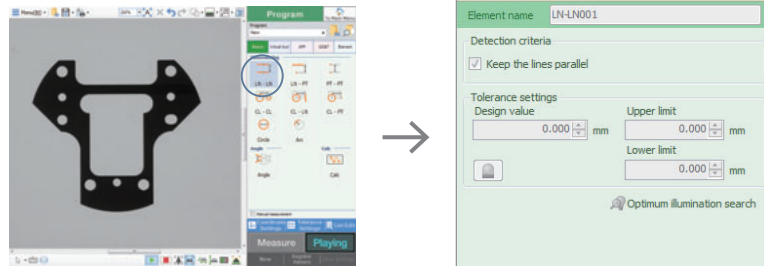

A Wide Range of Auxiliary Measurement Tools

Even complicated measurements using center lines and other virtual lines that are difficult to handle with conventional measurement systems can be set with intuitive clicks while viewing the screen.

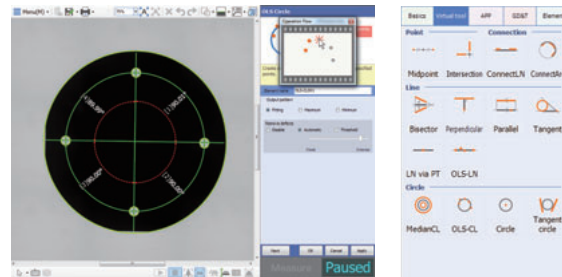

The Automatic Measurement Function Makes Setup Even Easier

This new function truly achieves "place and press" operation. Simple dimensions can be measured without any prior setup by simply selecting the types of measurements expected. Anyone can use it right away, just as they would use a caliper or micrometer.

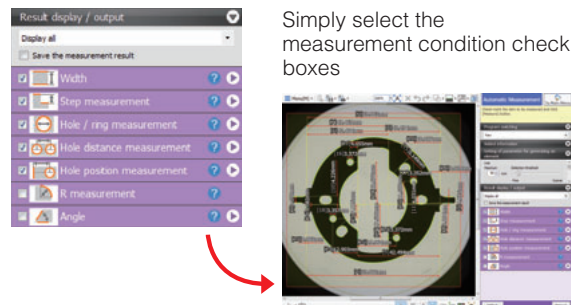

Simply select the measurement condition check boxes

Automatic Inspection Reports



Automatically Calculate Cp and Cpk

The system automatically calculates and displays key statistical values for each measurement item including OKs, NGs, maximum point, minimum point, average, (sigma, 3sigma, 6sigma) Cp, Cpk, and others. Processing capability management by lot is also possible.

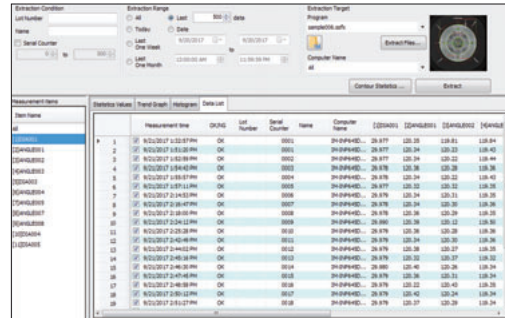

Item Name	Measurement time	OK/NG	Lot Number	Serial Counter	Name	Computer Name	(Sigma)	(3Sigma)	(6Sigma)	(Cp)	(Cpk)
all											
1	9/20/2017 1:52:07 PM	OK	0002	0000	SH-PPH-VCL	28.877	128.28	128.28	128.24	1.0824	1.0824
2	9/20/2017 1:52:08 PM	OK	0002	0001	SH-PPH-VCL	28.877	128.24	128.24	128.23	1.0840	1.0840
3	9/20/2017 1:52:09 PM	OK	0002	0002	SH-PPH-VCL	28.877	128.24	128.24	128.22	1.0844	1.0844
4	9/20/2017 1:54:42 PM	OK	0002	0003	SH-PPH-VCL	28.876	128.26	128.26	128.28	1.0838	1.0838
5	9/20/2017 1:58:07 PM	OK	0004	0004	SH-PPH-VCL	28.878	128.24	128.24	128.22	1.0840	1.0840
6	9/20/2017 1:57:14 PM	OK	0002	0005	SH-PPH-VCL	28.877	128.22	128.22	128.20	1.0844	1.0844
7	9/20/2017 2:14:03 PM	OK	0008	0006	SH-PPH-VCL	28.878	128.24	128.24	128.21	1.0839	1.0839
8	9/20/2017 2:14:04 PM	OK	0007	0007	SH-PPH-VCL	28.876	128.24	128.24	128.20	1.0840	1.0840
9	9/20/2017 2:14:05 PM	OK	0008	0008	SH-PPH-VCL	28.878	128.26	128.26	128.28	1.0838	1.0838
10	9/20/2017 2:14:06 PM	OK	0008	0009	SH-PPH-VCL	28.881	128.26	128.26	128.22	1.0836	1.0836
11	9/20/2017 2:15:28 PM	OK	0010	0010	SH-PPH-VCL	28.878	128.26	128.26	128.28	1.0838	1.0838
12	9/20/2017 2:14:07 PM	OK	0012	0011	SH-PPH-VCL	28.878	128.24	128.24	128.20	1.0840	1.0840
13	9/20/2017 2:14:08 PM	OK	0012	0012	SH-PPH-VCL	28.878	128.26	128.26	128.27	1.0833	1.0833
14	9/20/2017 2:14:09 PM	OK	0013	0013	SH-PPH-VCL	28.878	128.22	128.22	128.20	1.0844	1.0844
15	9/20/2017 2:14:10 PM	OK	0014	0014	SH-PPH-VCL	28.880	128.45	128.26	128.24	1.0834	1.0834
16	9/20/2017 2:14:11 PM	OK	0015	0015	SH-PPH-VCL	28.878	128.26	128.26	128.21	1.0839	1.0839
17	9/20/2017 2:14:12 PM	OK	0016	0016	SH-PPH-VCL	28.878	128.22	128.45	128.28	1.0835	1.0835
18	9/20/2017 2:15:12 PM	OK	0017	0017	SH-PPH-VCL	28.878	128.42	128.24	128.24	1.0834	1.0834
19	9/20/2017 2:15:17 PM	OK	0018	0018	SH-PPH-VCL	28.878	128.27	128.28	128.24	1.0834	1.0834

Immediate Feedback on Trends and Variations

Built-in trend graph and histogram functions allow for verification of trends and variations such as those detailed below in each measured item using graphs.

- Measured values are gradually decreasing
- Variation has increased
- Measured values are fluctuating in a cyclical manner

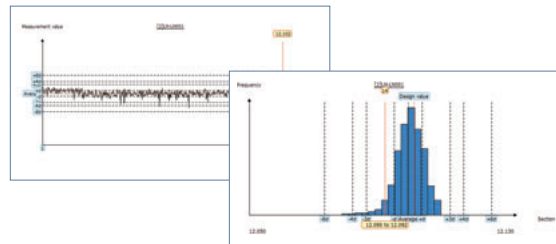

Complete Inspection Reports in Seconds

IM Series measurement results can be automatically transferred to specific spreadsheet software on a PC.

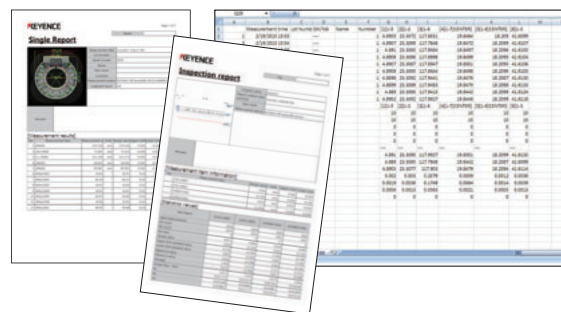

Profiles Are Also Automatically Aggregated

Records not only the measurement results, but also the profiles of measured parts. This allows for changes in appearance to be visualized in a way that cannot be achieved using measurement results alone.

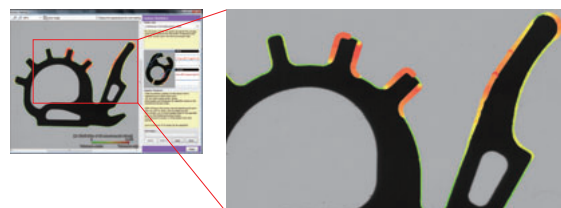



Advanced Technologies for Achieving Place-and-Press Measurement

Large Diameter Telecentric Lenses

No extreme focus adjustment or positioning required

Programmable Ring-Illumination Unit

Accurately extracts edges with optimal lighting conditions

Light Probe Unit

New technology allows measurements of features at specific heights

Large High Speed/High Precision Stage

6x the measurement volume

Advanced Technologies for Achieving Place-and-Press Measurement

Large Diameter Telecentric Lenses



No Extreme Focus Adjustment or Positioning Required

Clear Focus Regardless of Height Differences

The IM-7000 Series is equipped with a specially designed lens with a large depth of field. This ensures accurate measurements despite height differences on the part.

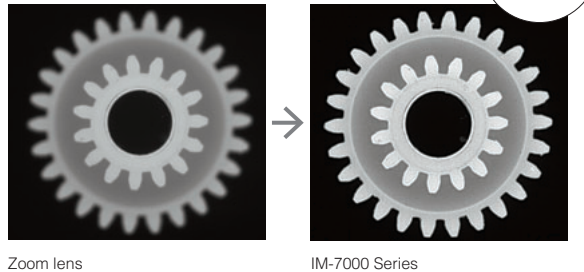

Apparent Feature Size Not Affected by Height Differences

The IM-7000 Series is equipped with telecentric lenses, which means that the image is not affected by the height differences of the part. This enables accurate measurements of parts with uneven surfaces.

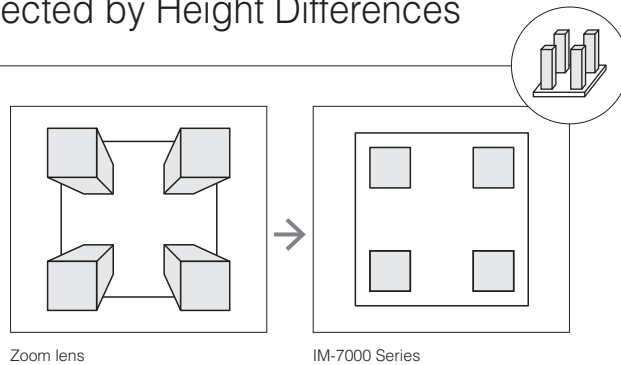

Reduced Distortion Throughout the Entire Field of View

The IM-7000 Series is equipped with a low distortion lens designed to not only minimize distortion near the centre, but also at the outer reaches of the field of view. This allows parts to be measured accurately despite its location on the stage.

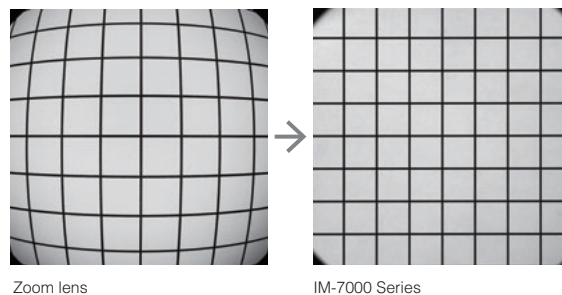

Advanced Technologies for Achieving Place-and-Press Measurement

Large High Speed/High Precision Stage



6x the Measurement Volume

300 x 200 mm **11.81" x 7.87"** Field of View, 3x Faster Stage Movement

The newly developed high-speed and high-precision stage offers a measurement field of view that is 300 x 200 mm **11.81" x 7.87"** in size. Also, thanks to the high speed of the stage, the field of view can be measured at three times the speed of conventional systems.

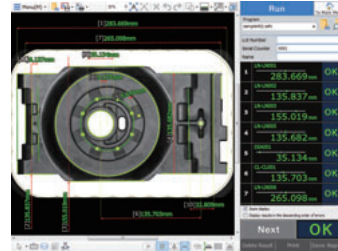

Measure Taller Parts

Innovations in the structures of the stage system and lens unit have dramatically improved support for the measurement of tall parts.

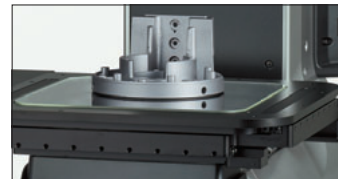

High-Precision Stage with High Linearity

By utilizing precision cross-roller bearings, we are able to offer high accuracy while maintaining increased durability. This eliminates measurement errors due to stage movement.

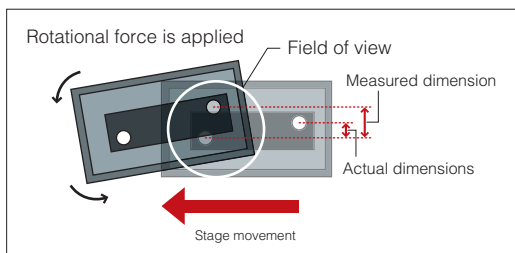

Without adjustment

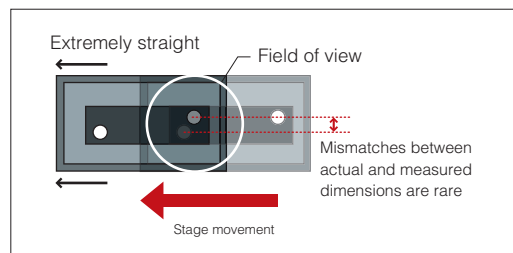

IM-7000 Series

Custom High-Precision Linear Scale

A high-precision linear scale designed specifically for the IM-7000 Series allows the stage movement to be tracked in micron increments. This makes it possible to perform accurate measurements, even on large parts.

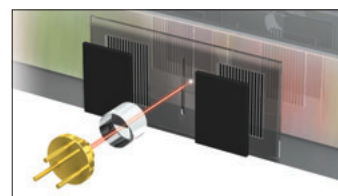

Advanced Technologies for Achieving Place-and-Press Measurement

Programmable Ring-Illumination Unit



Accurately Extract Edges with Optimal Lighting Conditions

Multiple Illumination Units All in One

The programmable ring-illumination unit integrates multiple ring illumination functions into a single unit. This allows a wide variety of features to be inspected without the need for lighting changeover to maximize efficiency.

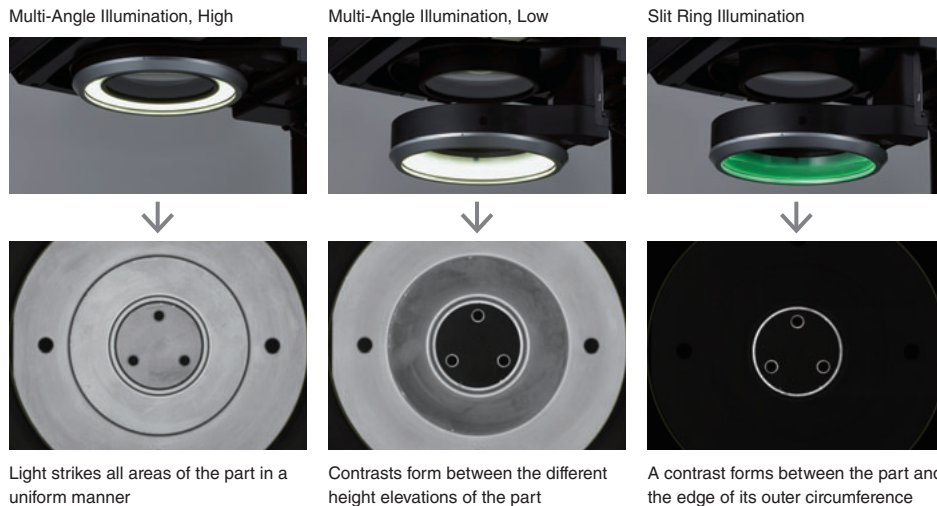

Programmable Ring-Illumination Unit Mechanism

Cross section image with multi-angle lights turned on



A wide area is illuminated. Placing at a high position causes the entire target to be illuminated evenly. The lower the position, the greater the contrast in lighting due to height differences.

Cross section image with slit ring illumination turned on

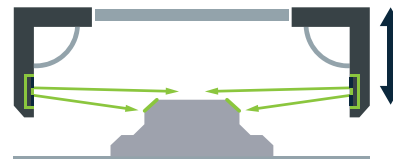

Narrow bands of light are projected horizontally. Place the illumination unit at the height with edges to detect in order to create a clear contrast at the desired location.

Automatically Finds the Optimal Lighting Settings

It is often difficult to determine the correct lighting settings for a given feature. The optimal lighting search function simplifies this by showing you the actual images using different lighting techniques so you can simply select the one you want. This means that even first time users can feel confident in their ability to use the instrument.

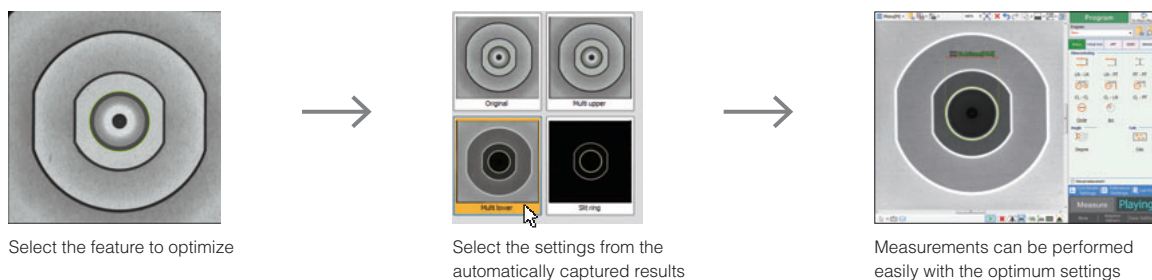

Select the feature to optimize

Select the settings from the automatically captured results

Measurements can be performed easily with the optimum settings

Advanced Technologies for Achieving Place-and-Press Measurement

Light Probe Unit



New Technology Allows Measurement of Features at Specified Heights

Accurately Measure Dimensions Previously Impossible with Vision Systems

The newly developed light probe unit has a deep-set shape and rounded corners that allow for easy and accurate measurements even on targets with shapes and processing states that made them difficult to measure for systems using conventional images.

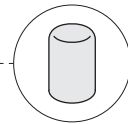

New Technology Accurately Measures Sides not Visible to the Camera

- 1 A glowing sphere is brought into contact with the desired point on the part
- 2 A camera is used to recognize the motion of the probe and measure distance

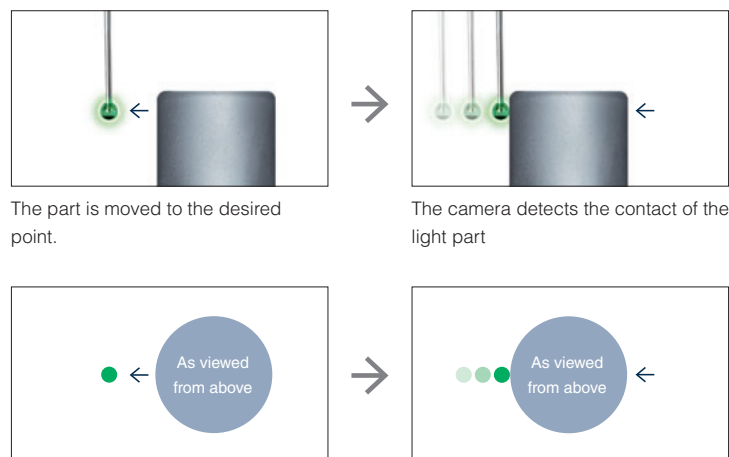

The Extremely Low Force Measurement of Light and Small Parts

Conventional contact-type measurement systems use a strong measuring force that can cause misalignment due to the pressure applied to small and light targets. The light probe unit uses an extremely low measuring force of 0.015 N to accurately take measurements without the hassle or cost of fixturing parts. This also eliminates the concern of deformation when soft parts are measured.

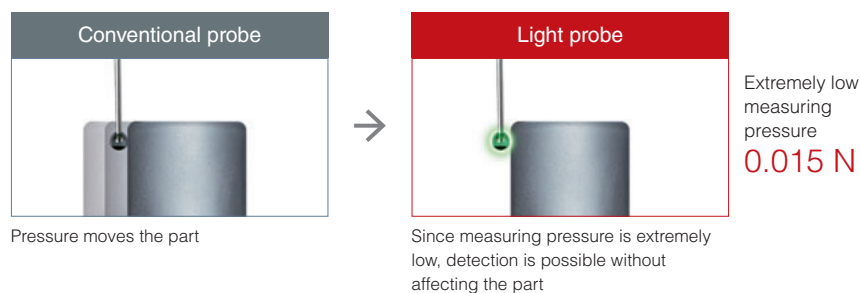

Shop Floor Ready Performance and Reliability

Traceability System Diagram

The reference scales used for manufacturing, inspection, and calibration conform to the reference scale of JCSS accredited calibration laboratories to establish traceability back to the national standard.

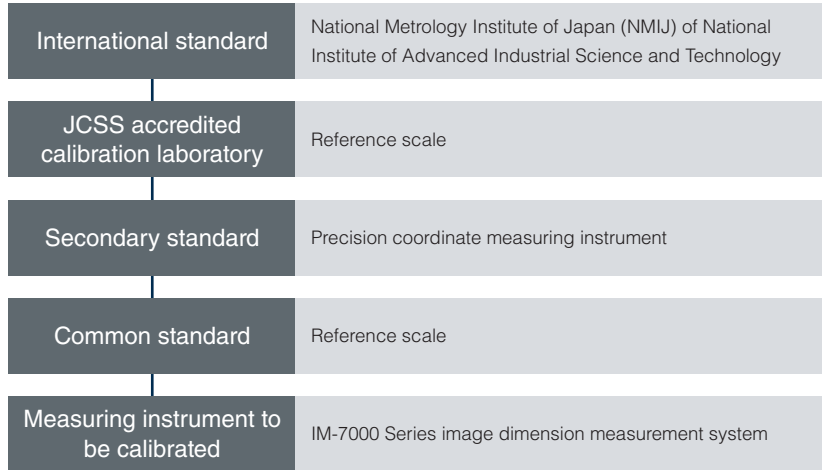

Includes a Highly Rigid Body and Temperature Sensor

Highly rigid body and temperature sensor ensures practical installation anywhere. The design was optimized using topological and strength analysis in order to develop the housing stiffness necessary for the required accuracy. Temperature compensation ensures accurate measurement in the field.

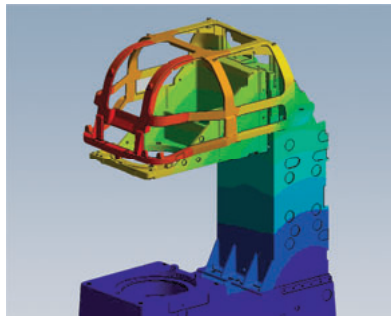

Frame strength analysis diagram

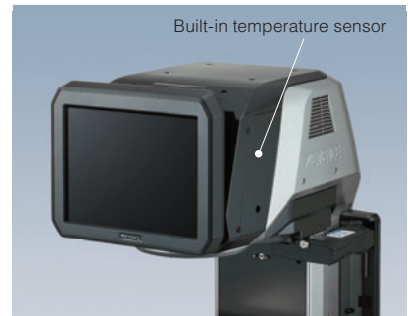

Temperature sensor ensures more stable measurement

Space-Saving Design

In addition to the small footprint from the compact body, the built-in monitor saves significant space. This allows the IM-7000 Series to be installed anywhere.

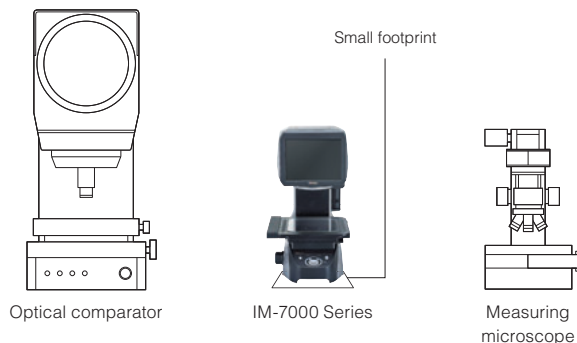

Optical comparator

IM-7000 Series

Measuring microscope

Comprehensive Coverage All Over the World & Global Support System

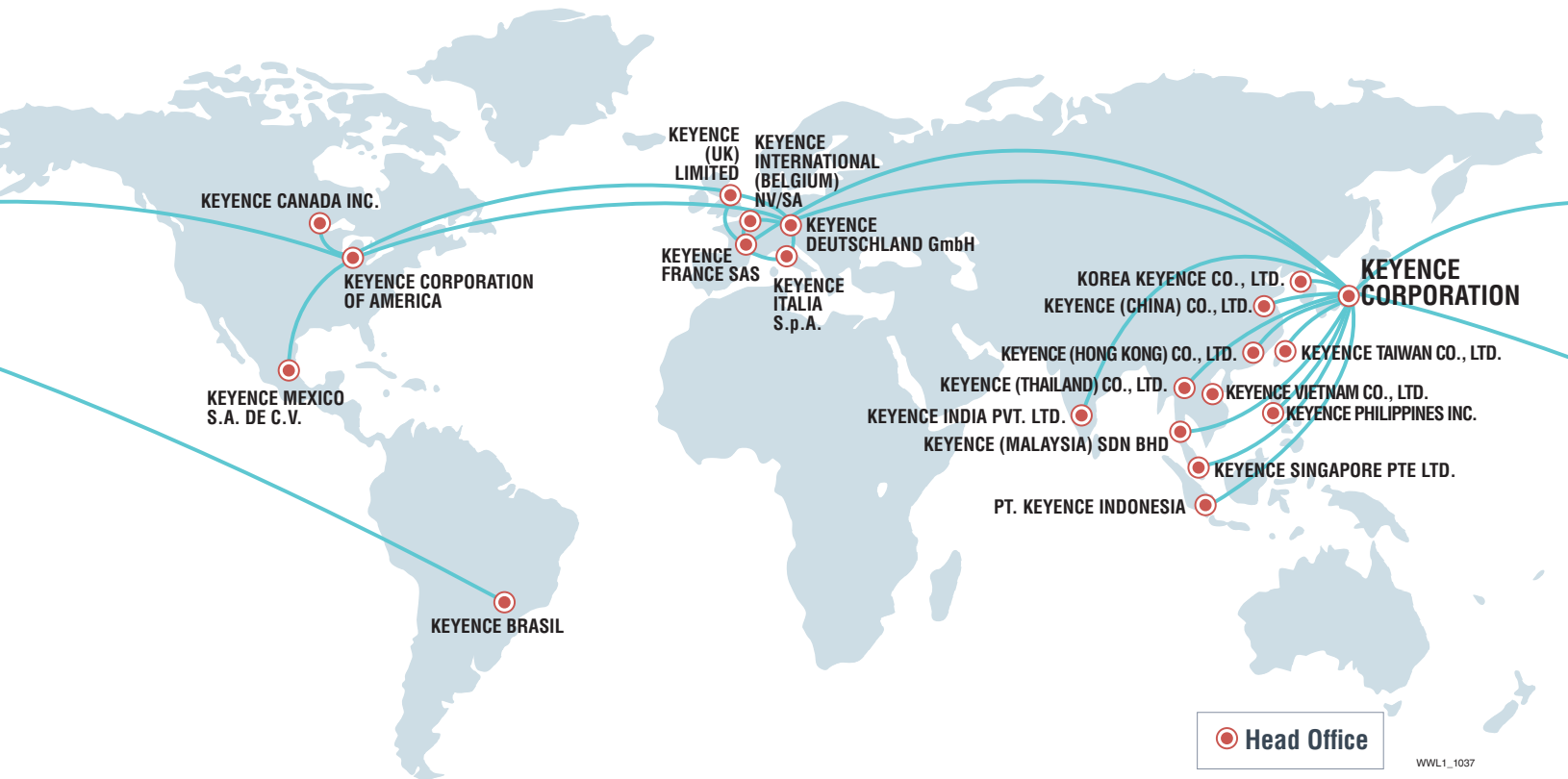

Quality Support Only Possible With a Direct Sales System

Our comprehensive after-sales support through technical sales technicians can only be achieved by our direct sales system. You can be confident that you will get the support you want immediately, without the hassle and delay of dealing with reps or distributors.

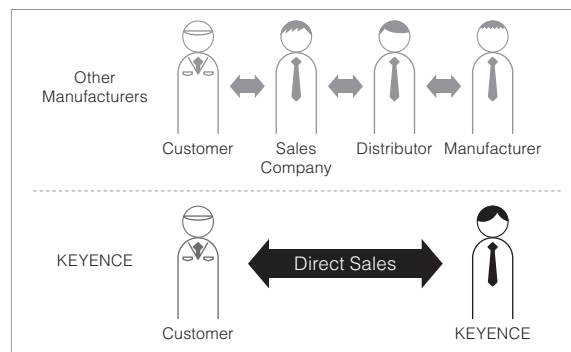

Support for Multiple Languages

In addition to the system's control screen, manuals and other documentation are also provided in a wide range of languages. Local staff can easily use KEYENCE's products after they are installed at international manufacturing bases.

Languages

English	German	French
Italian	Simplified Chinese	Traditional Chinese
Spanish	Thai	Korean

*To be released periodically

Instant Delivery System Also Available Internationally

KEYENCE's product inventory is not limited to Japan. A wide variety of products are stocked at distribution sites in each country so that they can be delivered promptly on the day we receive your order. You do not need to worry about if it may take considerable effort and time to obtain a product from an overseas factory.



IM Series Application Examples

For a Variety of Inspection Needs

Inspections of Prototypes and First Off-Tool Parts

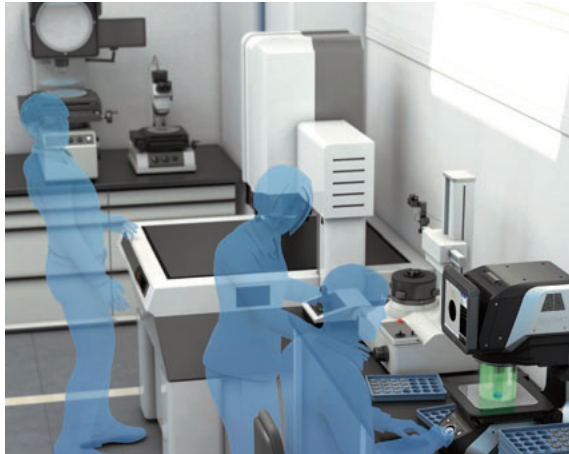

- Improvement of productivity through reductions in launch periods
- Measurement that does not depend on the inspector's experience level
- Measurement based on the traceability of international standards

In-Process Inspections of Samples and Parts



- Improvement of equipment availability through reductions in setup time
- Improvement of yield rates through better accuracy in equipment adjustment
- Since inspection can be performed by other operators in addition to the original inspector, this reduces the workload of the quality department.
- Symptom management within processes

Reduction of Inspection Time

Reductions in inspection time can improve manufacturing efficiency and reduce cost.

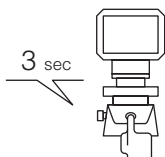

Reduction of Recording Time

Reductions in the work required to record inspection data can lead to reductions in data management cost.



Operators Other than Inspectors Can Also Perform Inspections

Reductions in the workload placed on the quality department can also lead to improvements in equipment availability.



In a wide variety of applications...

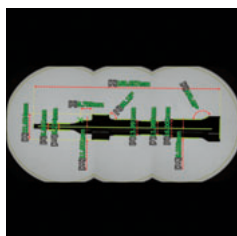

Lathe processing and cutting

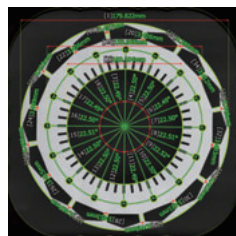

Pressing

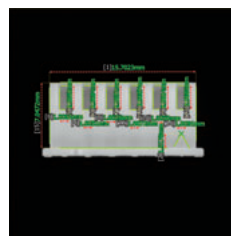

Plastic molding

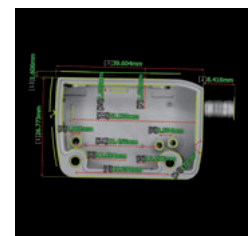

Sintering

Pre-Shipping Inspections



- Allows for shipping inspections with shortened delivery schedules
- Reduction of the work required to create inspection report tables
- Reduction of training time and labor costs associated with inspectors

Incoming Inspections



- Can manage acceptance inspections for multiple types with constant standards
- Reduction of the risk of defects even when the quantity of inspections is increased
- Improved quality through measurement of previously uninspected points

Constant Inspection Standards

The use of constant inspection standards enables manufacturing with more stable quality levels.

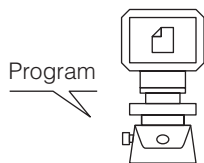

Increased Quantity of Inspections

Since it is easy to increase the quantity of inspections, the risk of defects is decreased.

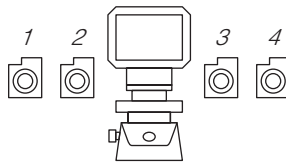

Increased Number of Dimensions

Since it is possible to measure uninspected dimensions without an increased workload, this leads to improvements in quality.

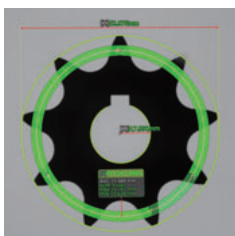
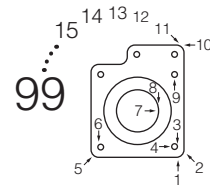

Forged parts

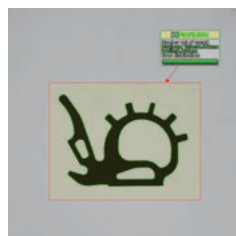

Molded object
(profile tolerance)

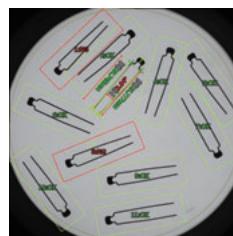

Electronic parts

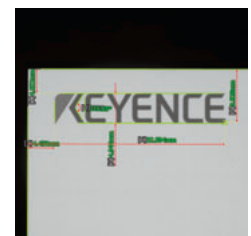

Printing

NEW

Contact Height Measurement Unit

IM-7030T Option

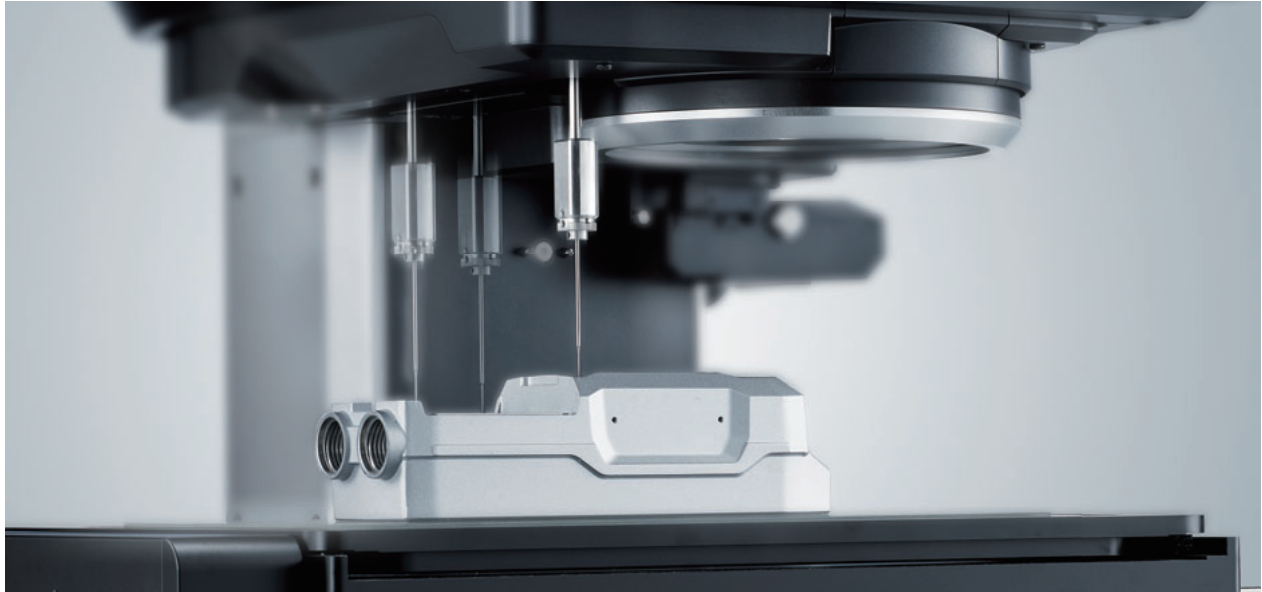

Instant Measurement Including Height

A dedicated contact height probe for the Instant Measurement system that helps reduce the amount of time required for using other measurement tools for different dimensions and the amount of work required for taking measurement results. The pattern search function enables the system to automatically detect and measure any pre-specified height/depth dimensions. It can help drastically reduce the amount of time required for measurement related tasks such as creating work procedure documentation or for training workers. Furthermore, centralized management of the measurement results enables an overall improvement in working efficiency of measurement tasks.



Simply place the target on the stage and press



The probe automatically performs the measurements

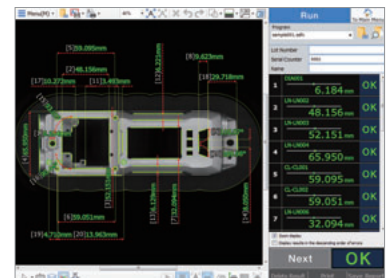

Display the height measurement results

		Height Measurement Unit
Measurement range		0 to 75 mm 0" to 2.95"
Measuring force		0.3 N
Measurement accuracy (XY)		±0.2 mm ^{*1} ±0.0079"
Minimum display unit		1 µm
Measurable area (XY)	Wide-field measurement mode	145 x 95 mm 5.71" x 3.74"
	High-precision measurement mode	107.5 x 95 mm 4.23" x 3.74"
Repeatability		±2 µm ^{*2}
Measurement accuracy		±7.5 µm ^{*3}

*1 Operating ambient temperature: 23°C ±1°C 73.4°F ± 1.8°F.

*2 With a maximum measurement height of 30 mm 1.18" or less. ±3 µm when maximum measurement height is between 30 mm 1.18" and 75 mm 2.95".

*3 With a maximum measurement height of 30 mm 1.18" or less. ±9.5 µm when maximum measurement height is between 30 mm 1.18" and 75 mm 2.95".

Network Functions and Software

Measurement setup editor

Offline Programming Optional: IM-H2EA

A PC can be used to add or change measurement locations in a setting file created by the IM-7000 Series system, or in data created with the CAD import module.

CAD import module

Import CAD Data Optional: IM-H2C

The data required for measurements can be acquired from CAD drawing data in DXF format. Even when a target is not at hand, it is still possible to quickly create measurement setting files.

*Measurement setup editor (IM-H2EA) is also required.

PC software operating environment

Supported OS	Windows 7 Ultimate/Professional/Home Premium (64-bit version) Windows 8.1/Windows 8.1 Pro (64-bit version) Windows 10 Home/Pro/Enterprise (64-bit version)
Required free space on hard disk	5 GB or more

- Windows® is a trademark or registered trademark of Microsoft Corporation in the United States and other countries.
- The formal name of Windows is Microsoft Windows® operating system.

Data transfer software

Creating Inspection Reports Optional: IM-H1T

IM Series measurement results can be automatically transferred to specific cells in spreadsheet software on a specified PC.

Data transfer over a LAN connection

Communicating with PCs

It is easy to transfer a setting file created on an IM Series system or a PC to another IM Series system in another location.

System Configuration

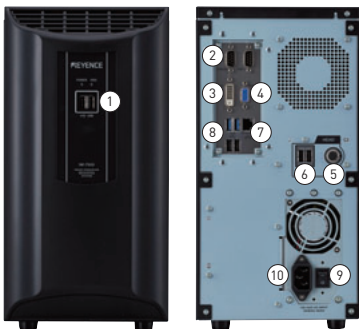
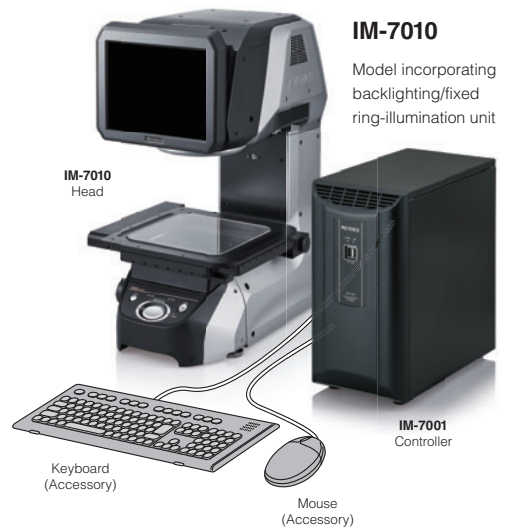
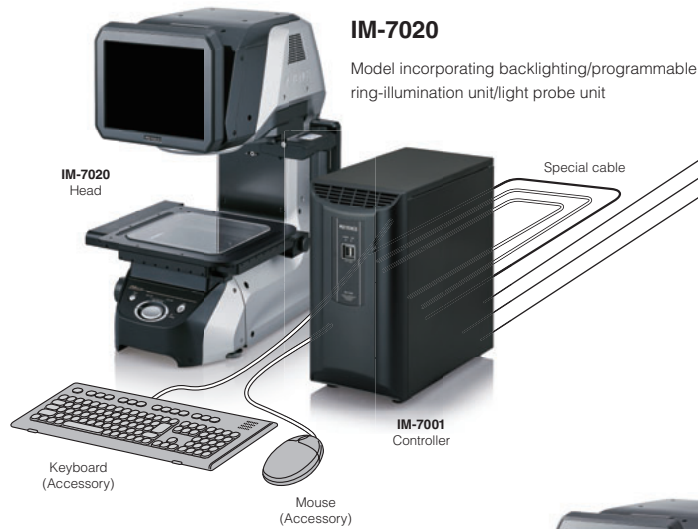

- (1) USB ports (two in front)
- (2) Communication port
- (3) DVI connector
- (4) MONITOR connector
- (5) POWER connector
- (6) CAMERA CONTROL port (x 2)
- (7) LAN port
- (8) USB ports (four in back)
- (9) Main power switch
- (10) AC power input connector

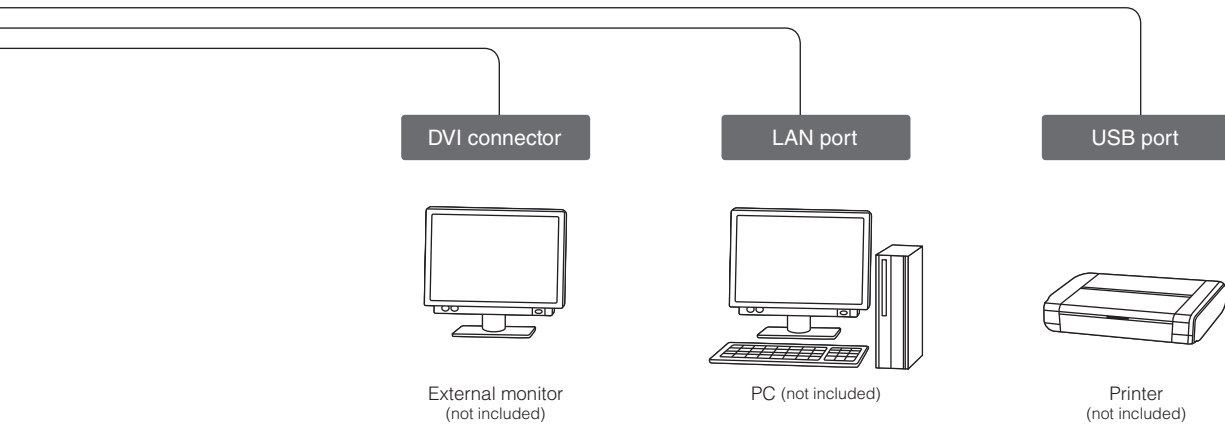

PC Software

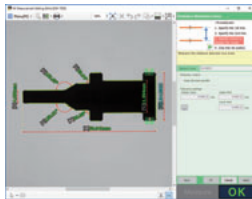

IM-H2EA
IM measurement setup editor

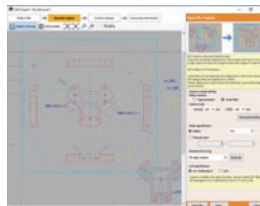

IM-H2C
CAD import module



IM-H1T
IM data transfer software

Precision fixturing base



OP-87761
Precision fixturing base
(for long measurement targets)



OP-87501
Precision fixturing base



IM-DXW12N
Coaxial illumination

Optional Lighting

Stage glass



OP-88179¹
Stage glass



IM-SG2
Tempered stage glass

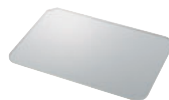

OP-88239²
Stage glass for IM-7030

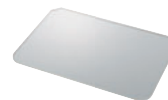

IM-SG3
Tempered stage glass for
IM-7030

OP-88185
Fixture sheet



OP-88214³
Stylus for
IM-7030T



OP-88215
Flat stylus for
IM-7030T

¹ One of these is included with the purchase of the IM-7020 or 7010.
² One of these is included with the purchase of the IM-7030.
³ One of these is included with the purchase of the IM-7030T.

SPECIFICATIONS



Model	Controller		IM-7001			
	Head		IM-7010	IM-7020	IM-7030	
Image sensor		1" 6.6 mega pixel monochrome CMOS				
Display		10.4" LCD monitor (XGA: 1024 x 768)				
Receiver lens		Double telecentric lens				
Image measurement	Field of view	Wide-field measurement mode		200 mm x 200 mm $7.87^{\circ} \times 7.87^{\circ}$ (4x R50)		
		High-precision measurement mode		125 x 125 mm $4.92^{\circ} \times 4.92^{\circ}$		
	Minimum display unit		0.1 μm			
	Repeatability	Wide-field measurement mode	W/o stage movement		$\pm 1 \mu\text{m}$	
			With stage movement		$\pm 2 \mu\text{m}$	
	Measurement accuracy ($\pm 2\sigma$)	High-precision measurement mode	W/o stage movement		$\pm 0.5 \mu\text{m}$	
			With stage movement		$\pm 1.5 \mu\text{m}$	
	Measurement accuracy ($\pm 2\sigma$)	Wide-field measurement mode	W/o binding		$\pm 5 \mu\text{m}^{-1}$	
With binding			$\pm (7 + 0.02 L) \mu\text{m}^{-2}$			
Measurement accuracy ($\pm 2\sigma$)	High-precision measurement mode	W/o binding		$\pm 2 \mu\text{m}^{-3}$		
		With binding		$\pm (4 + 0.02 L) \mu\text{m}^{-5}$		
Light probe Measurement	Measurable area (XY)		-	90 x 90 mm $3.54^{\circ} \times 3.54^{\circ}$	190 x 90 mm $7.48^{\circ} \times 3.54^{\circ}$	
	Maximum measurement depth		-	30 mm	1.18"	
	Light probe diameter		-	$\varnothing 3 \text{ mm}$		
	Measuring force		-	0.015 N		
	Repeatability		-	$\pm 2 \mu\text{m}^7$		
	Measurement accuracy		-	$\pm (8 + 0.02 L) \mu\text{m}^8$	$\pm (8 + 0.02 L) \mu\text{m}^9$	
External remote input		Non-voltage input (with and without contact)				
External output		OK/NG/FAIL/MEAS. PhotoMos output Rated load 24 VDC 0.5 A ON resistance 50 m Ω or lower				
Interface		LAN USB 2.0 series A RJ-45 (10BASE-T/100BASE-TX/1000BASE-T) 6 ports (front: 2, rear: 4)				
Record		Hard disk drive 500 GB				
Environmental resistance		Operating ambient temperature $+10^{\circ}\text{C}$ to 35°C $+50^{\circ}\text{F}$ to 95°F Operating ambient humidity 20% RH to 80% RH (no condensation)				
Illumination system	Transparent		Telecentric transparent illumination			
	Ring	Four division ring illumination	-			
	Ring	-	Four division, multi-angle illumination (electric)			
	Ring	-	Slit ring (directivity) illumination (electric)			
XY stage	Moving range		100 x 100 mm $3.94^{\circ} \times 3.94^{\circ}$ (electric)		200 x 100 mm $7.87^{\circ} \times 3.94^{\circ}$ (electric)	
	Withstand load		5 kg		7.5 kg	
Z stage	Moving range		75 mm 2.95° (electric)			
Power supply	Power voltage		100–240 VAC, 50/60 Hz			
	Power consumption		430 VA or lower			
Weight	Controller		Approx. 8 kg			
	Head		Approx. 30 kg	Approx. 31 kg	Approx. 33 kg	

- *1. In the range of $\varnothing 80 \text{ mm } \varnothing 3.15^{\circ}$, within the operating ambient temperature range of $+23^{\circ}\text{C} \pm 1^{\circ}\text{C}$ $+73.4^{\circ}\text{F} \pm 1.8^{\circ}\text{F}$ at the focused focal point position
- *2. In the range of $180 \times 180 \text{ mm } 7.09^{\circ} \times 7.09^{\circ}$ (4x R40), within the operating ambient temperature range of $+23^{\circ}\text{C} \pm 1^{\circ}\text{C}$ $+73.4^{\circ}\text{F} \pm 1.8^{\circ}\text{F}$ at the focused focal point position, and with a load weighing 2 kg or less on the stage (L = amount of stage movement in mm units)
- *3. In the range of $280 \times 180 \text{ mm } 11.02^{\circ} \times 7.09^{\circ}$ (4x R40), within the operating ambient temperature range of $+23^{\circ}\text{C} \pm 1^{\circ}\text{C}$ $+73.4^{\circ}\text{F} \pm 1.8^{\circ}\text{F}$ at the focused focal point position, and with a load weighing 3 kg or less on the stage (L = amount of stage movement in mm units)
- *4. In the range of $\varnothing 20 \text{ mm } \varnothing 0.79^{\circ}$, within the operating ambient temperature range of $+23^{\circ}\text{C} \pm 1^{\circ}\text{C}$ $+73.4^{\circ}\text{F} \pm 1.8^{\circ}\text{F}$ at the focused focal point position
- *5. In the range of $120 \times 120 \text{ mm } 4.72^{\circ} \times 4.72^{\circ}$, within the operating ambient temperature range of $+23^{\circ}\text{C} \pm 1^{\circ}\text{C}$ $+73.4^{\circ}\text{F} \pm 1.8^{\circ}\text{F}$ at the focused focal point position, and with a load weighing 2 kg or less on the stage (L = amount of stage movement in mm units)
- *6. In the range of $220 \times 120 \text{ mm } 9.45^{\circ} \times 4.72^{\circ}$, within the operating ambient temperature range of $+23^{\circ}\text{C} \pm 1^{\circ}\text{C}$ $+73.4^{\circ}\text{F} \pm 1.8^{\circ}\text{F}$ at the focused focal point position, and with a load weighing 3 kg or less on the stage (L = amount of stage movement in mm units)
- *7. When the detection system is standard. If the detection system is at a deep position, then $\pm 3 \mu\text{m}$
- *8. When the detection system is standard, and the ambient temperature is $+23^{\circ}\text{C} \pm 1^{\circ}\text{C}$ $+73.4^{\circ}\text{F} \pm 1.8^{\circ}\text{F}$, with a stage load weighing 2 kg or less. If the detection system is at a deep position, then $\pm (10 + 0.02 L) \mu\text{m}$ with L as the measurement length in mm.
- *9. When the detection system is standard, and the ambient temperature is $+23^{\circ}\text{C} \pm 1^{\circ}\text{C}$ $+73.4^{\circ}\text{F} \pm 1.8^{\circ}\text{F}$, with a stage load weighing 3 kg or less. If the detection system is at a deep position, then $\pm (10 + 0.02 L) \mu\text{m}$ with L as the measurement length in mm.

DIMENSIONS

Unit (mm inch)

IM-7010 head

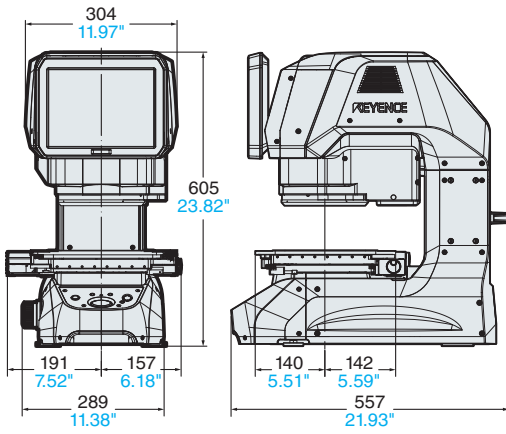

IM-7020 head

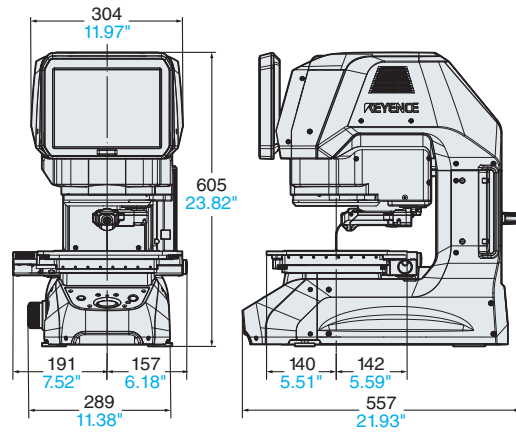

IM-7030 head

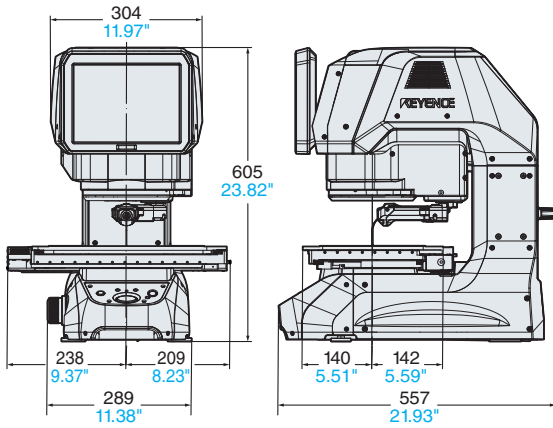

IM-7030T head

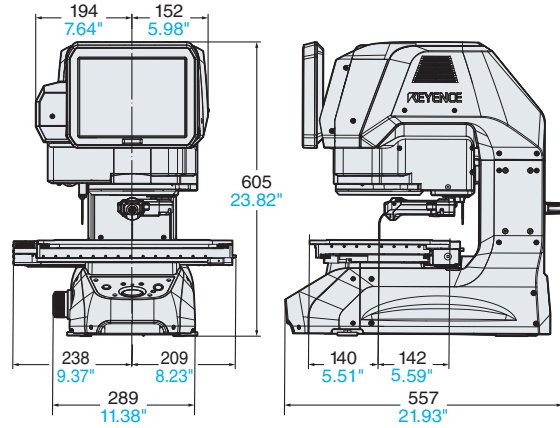

IM-7001 controller

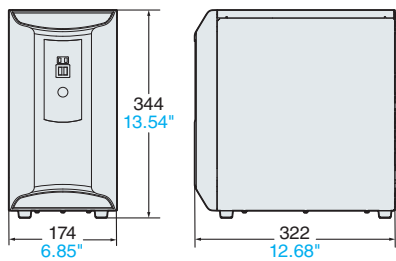



CALL
TOLL
FREE

TO CONTACT YOUR LOCAL OFFICE
1-888-KEYENCE
1 - 8 8 8 - 5 3 9 - 3 6 2 3

www.keyence.com



SAFETY INFORMATION

Please read the instruction manual carefully in order to safely operate any KEYENCE product.

CONTACT YOUR NEAREST OFFICE FOR RELEASE STATUS

KEYENCE CORPORATION OF AMERICA

Head Office 500 Park Boulevard, Suite 200, Itasca, IL 60143, U.S.A. **PHONE:** +1-201-930-0100 **FAX:** +1-855-539-0123 **E-mail:** keyence@keyence.com

AL Birmingham	CA San Jose	CO Denver	IL Chicago	MI Detroit	MO St. Louis	NC Raleigh	PA Philadelphia	TN Nashville	WI Milwaukee
AR Little Rock	CA Cupertino	FL Tampa	IN Indianapolis	MI Grand Rapids	NJ Elmwood Park	OH Cincinnati	PA Pittsburgh	TX Austin	
AZ Phoenix	CA Los Angeles	GA Atlanta	KY Louisville	MN Minneapolis	NY Rochester	OH Cleveland	SC Greenville	TX Dallas	
CA San Francisco	CA Irvine	IA Iowa	MA Boston	MO Kansas City	NC Charlotte	OR Portland	TN Knoxville	WA Seattle	

KEYENCE CANADA INC.

Head Office PHONE: +1-905-366-7655 FAX: +1-905-366-1122 E-mail: keyencecanada@keyence.com
Montreal PHONE: +1-514-694-4740 FAX: +1-514-694-3206 Windsor PHONE: +1-905-366-7655 FAX: +1-905-366-1122

KEYENCE MEXICO S.A. DE C.V.

PHONE: +52-55-8850-0100 FAX: +52-81-8220-9097
E-mail: keyencemexico@keyence.com

The information in this publication is based on KEYENCE's internal research/evaluation at the time of release and is subject to change without notice. Company and product names mentioned in this catalog are either trademarks or registered trademarks of their respective companies. The specifications are expressed in metric units. The English units have been converted from the original metric units.

Copyright (c) 2018 KEYENCE CORPORATION. All rights reserved.

KA1-1017

IM7000-KA-C2-US 1028-1 **61G17**