



**Advanced Test Equipment Rentals**  
**www.atecorp.com 800-404-ATEC (2832)**

**FLUKE®**

**1625**  
Earth/Ground Tester

**Users Manual**

January 2006  
© 2006 Fluke Corporation, All rights reserved. Printed in USA  
All product names are trademarks of their respective companies.

## **LIMITED WARRANTY AND LIMITATION OF LIABILITY**

Each Fluke product is warranted to be free from defects in material and workmanship under normal use and service. The warranty period is two years and begins on the date of shipment. Parts, product repairs, and services are warranted for 90 days. This warranty extends only to the original buyer or end-user customer of a Fluke authorized reseller, and does not apply to fuses, disposable batteries, or to any product which, in Fluke's opinion, has been misused, altered, neglected, contaminated, or damaged by accident or abnormal conditions of operation or handling. Fluke warrants that software will operate substantially in accordance with its functional specifications for 90 days and that it has been properly recorded on non-defective media. Fluke does not warrant that software will be error free or operate without interruption.

Fluke authorized resellers shall extend this warranty on new and unused products to end-user customers only but have no authority to extend a greater or different warranty on behalf of Fluke. Warranty support is available only if product is purchased through a Fluke authorized sales outlet or Buyer has paid the applicable international price. Fluke reserves the right to invoice Buyer for importation costs of repair/replacement parts when product purchased in one country is submitted for repair in another country.

Fluke's warranty obligation is limited, at Fluke's option, to refund of the purchase price, free of charge repair, or replacement of a defective product which is returned to a Fluke authorized service center within the warranty period.

To obtain warranty service, contact your nearest Fluke authorized service center to obtain return authorization information, then send the product to that service center, with a description of the difficulty, postage and insurance prepaid (FOB Destination). Fluke assumes no risk for damage in transit. Following warranty repair, the product will be returned to Buyer, transportation prepaid (FOB Destination). If Fluke determines that failure was caused by neglect, misuse, contamination, alteration, accident, or abnormal condition of operation or handling, including overvoltage failures caused by use outside the product's specified rating, or normal wear and tear of mechanical components, Fluke will provide an estimate of repair costs and obtain authorization before commencing the work. Following repair, the product will be returned to the Buyer transportation prepaid and the Buyer will be billed for the repair and return transportation charges (FOB Shipping Point).

THIS WARRANTY IS BUYER'S SOLE AND EXCLUSIVE REMEDY AND IS IN LIEU OF ALL OTHER WARRANTIES, EXPRESS OR IMPLIED, INCLUDING BUT NOT LIMITED TO ANY IMPLIED WARRANTY OF MERCHANTABILITY OR FITNESS FOR A PARTICULAR PURPOSE. FLUKE SHALL NOT BE LIABLE FOR ANY SPECIAL, INDIRECT, INCIDENTAL OR CONSEQUENTIAL DAMAGES OR LOSSES, INCLUDING LOSS OF DATA, ARISING FROM ANY CAUSE OR THEORY.

Since some countries or states do not allow limitation of the term of an implied warranty, or exclusion or limitation of incidental or consequential damages, the limitations and exclusions of this warranty may not apply to every buyer. If any provision of this Warranty is held invalid or unenforceable by a court or other decision-maker of competent jurisdiction, such holding will not affect the validity or enforceability of any other provision.

Fluke Corporation  
P.O. Box 9090  
Everett, WA 98206-9090  
U.S.A.

Fluke Europe B.V.  
P.O. Box 1186  
5602 BD Eindhoven  
The Netherlands

# Table of Contents

Title	Page
Introduction .....	1
Models and Accessories .....	3
Safety Instructions .....	4
Qualified Staff .....	5
Setup .....	5
Unpacking .....	5
Checking the Scope of Delivery .....	5
General .....	6
Additional Accessories .....	6
Assembly .....	7
Description of Functions .....	7
Measurement of Interference Voltage ( $U_{ST}$ ) .....	8
Measurement of Interference Frequency ( $F_{ST}$ ) .....	8
Measurement of Earthing Resistance ( $R_E$ ) .....	9
Selective Measurement of Earthing Resistance ( $R_E \text{ } \gg \text{ } C$ ) .....	9
Resistance Measurement ( $R_{\sim}$ ) .....	9
Low Resistance Measurement ( $R_{\overline{\sim}}$ ) .....	9
Checking for Correct Measuring Connection .....	9
Beeper .....	9
LO-BAT .....	10
Specifications .....	10
Measurement of Interference Voltage DC + AC ( $U_{ST}$ ) .....	13
Measurement of Interference Frequency ( $F_{ST}$ ) .....	13
Earthing Resistance ( $R_E$ ) .....	13
Selective Measurement of the Earthing Resistance ( $R_E \text{ } \gg \text{ } C$ ) .....	17
Resistance Measurement ( $R_{\sim}$ ) .....	18
Resistance Measurement ( $R_{\overline{\sim}}$ ) .....	19
Compensation of Lead Resistance ( $R_K$ ) .....	20
Description of the Operating Elements .....	21
Description of Display Elements .....	23
Procedure of Measurements .....	24
POWER ON Functions .....	25
Operation .....	26
Checking of Correct Measuring Connection (Socket Allocation) .....	30
Safety Control Measurements .....	31

Measurement of Interference - Voltages and Frequencies.....	31
Measurement of Earthing Resistances.....	32
3-pole/4-pole Measurement of Earthing Resistance.....	33
Measurement of Single Earth Electrode Resistances in Mesh Operated Earthing Systems Using Selective Clamp Method.....	36
3-pole/4-pole Measurement of Single Earth Electrode Resistances.....	37
Measurements on High Voltage Pylons.....	39
Correcting Clip-on Transformer Errors.....	42
Compensation of Earth Electrode Connecting Lead.....	44
Measurement of Soil Resistivity.....	45
Measurement of Resistances.....	48
Resistance Measurement ( $R_{\sim}$ ).....	48
Resistance Measurement ( $R_{\rightarrow}$ ).....	49
Compensation of Measuring Lead Resistance.....	50
Changing of All Data Settings with Personalized CODE.....	51
Storing a Code.....	53
Deleting a Code.....	54
Description of Displays.....	55
Care and Maintenance.....	60
Replacing Batteries.....	61
Recalibration.....	62
Storage.....	62
Specifications.....	64
Principle of Operation.....	65
Purpose.....	65
Operation.....	68
Settings on the Tester.....	69
Applications.....	70
Description of Displays.....	72

## ***List of Tables***

<b>Table</b>	<b>Title</b>	<b>Page</b>
1.	Models and Accessories .....	3
2.	Electrical Measurement Specifications .....	14
3.	Description of Displays .....	55



## List of Figures

Figure	Title	Page
1.	Fluke 1625 Earth/Ground Tester.....	2
2.	Description of Functions.....	8
3.	Display.....	10
4.	Operating Elements.....	21
5.	Display Elements.....	23
6.	Operational Modes.....	27
7.	Measurement of Interference - Voltages and Frequencies.....	32
8.	Earthing Resistances Measurement - Method.....	33
9.	3-pole/4-pole Measurement of Earthing Resistance - Process.....	34
10.	Earth Resistance - Maximum Permissible Value.....	35
11.	Measurement of Single Earth Electrode Resistances in Mesh Operated Earthing Systems.....	36
12.	3-pole/4-pole Measurement of Single Earth Electrode Resistances.....	37
13.	Measuring the Earthing Resistance without Disengaging the Overhead Earth Wire.....	40
14.	Correcting Clip-on Transformer Errors.....	43
15.	Compensation of Earth Electrode Connecting Lead.....	44
16.	Measurement of Soil Resistivity.....	45
17.	Resistance Measurement ( $R_{\sim}$ ).....	48
18.	Resistance Measurement ( $R_{\overline{\sim}}$ ).....	49
19.	Evaluation of Measured Value.....	50
20.	Compensation of Measuring Lead Resistance.....	51





# ***Earth/Ground Tester***

## ***Introduction***

At locations involving the generation, distribution and consumption of electrical energy, certain safety measures must be met in order to protect human life. In many cases, these safety measures are national and international regulations which must be checked regularly. Grounding, the connection of exposed conductive parts to the earth in case of a fault, represents the most fundamental safety measure. There are requirements for grounding of transformers, high and medium voltage power pylons, railway tracks, tanks, vats, foundations and lightning protection systems.

The effectiveness of grounding systems should be checked using a ground test instruments such as the 1625 which checks the effectiveness of connections to the ground. The 1625 provides the perfect solution by combining the latest technology into a compact, field-rugged and extremely easy to use instrument. In addition to performing standard 3- and 4-pole ground resistance measurements, an innovative process accurately measures individual earth electrode resistances in single and meshed earthed systems without disconnecting any parallel electrodes. One specific application of this capability is quick and accurate measurement of power pylon grounds. The 1625 also incorporates automatic frequency control (AFC) to minimize interference. Before measuring, the instrument identifies existing interference and selects a measurement frequency to minimise its effect. The 1625 incorporates microprocessor controlled automatic measurements including checking probe hookup to ensure that measurements are taken correctly. It measures all probe ground resistances to ensure reliable, repeatable results. Probe resistance and auxiliary earth resistance are also measured and displayed.

Notes

- The terms earth and earthing also refer to ground and grounding and is used interchangeably throughout this manual.
- For stakeless earth resistance measurements, the EI-1625 must be purchased. (The EI-1625 comes standard with the 1625 Kit). Refer to Appendix A for a complete set of operating information including specifications.
- Selective measurements are described in the main section of this manual.

Figure 1 displays the Fluke 1625 Earth/Ground Tester:

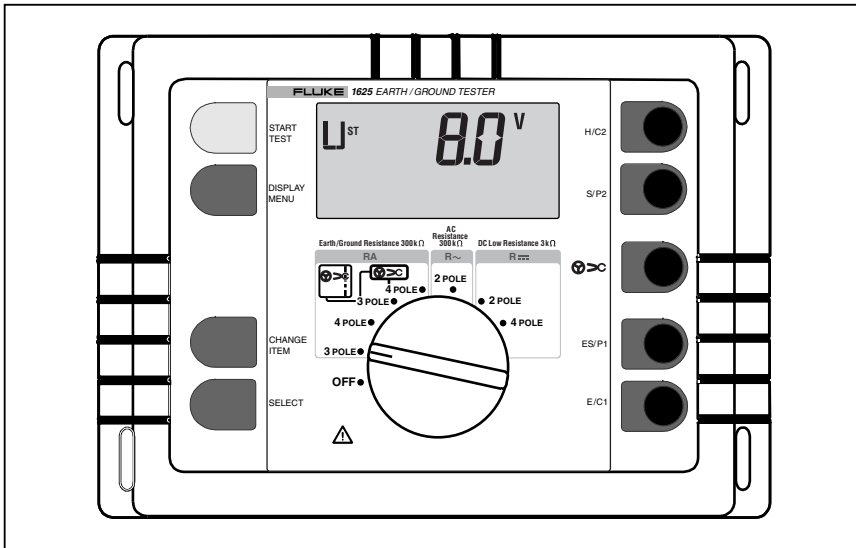

edw001.eps

**Figure 1. Fluke 1625 Earth/Ground Tester**

## Models and Accessories

Table 1 lists the models and accessories.

**Table 1. Models and Accessories**

Description	Item/Part Number
Earth Ground Tester - Basic (Includes manual, 2 leads and 2 clips)	Fluke-1625
Earth Ground Tester - Fully Loaded (Includes manual, 2 leads and 2 clips, ES162P4, EI-1623)	Fluke-1625 Kit
Service Replacement Kit (Includes 2 Leads, 2 Clips)	Fluke-162x-7001
Stake Set for 3 Pole Measurement (Includes three stakes, one 25 m cable reel, one 50 m cable reel)	ES-162P3
Stake set for 4 Pole Measurement (Includes four stakes, two 25 m cable reels, one 50 m cable reel)	ES-162P4
Selective/Stakeless Clamp Set for 1625. (Includes EI-162X and EI- 162AC and 2-3 wire adapter cable)	EI-1625
Clip-on Current Transformer (sensing) with shielded cable set	EI-162X
Shielded Cable (Used w/EI-162X Clamp)	2539195
Clip-on Current Transformer (inducing)	EI-162AC
12.7 Inch (320mm) Split Core Trans- former	EI-162BN
2-3 Wire Adapter Cable for 1625 for EI- 162AC Current Transformer	2577171
Earth Stake	2539121
Cable Reel w/25m Wire	2539100
Cable Reel w/50m Wire	2539117
1625 Users Manual	2560348

## Safety Instructions

### Warning

**This measuring equipment is only to be operated by qualified staff and in accord with its technical data in compliance with the safety precautions and instructions set forth below. In addition, use of this equipment requires compliance with the legal and safety instructions pertaining to the specific application in question. Similar precautions apply to the use of accessories.**

### Caution

**Operation of electrical equipment inevitably causes certain parts of such equipment to carry dangerous voltage. Non-compliance with precautions may therefore cause major physical or material damage.**

Fault-free and reliable operation of this instrument requires suitable transport and storage, setting-up and assembly, as well as care in operation and maintenance.

If there is reason to believe that risk-free operation is no longer possible, the instrument should be switched off immediately and protected against accidental restarting. Risk-free operation shall be deemed to be no longer possible if and when the instrument

- shows visible damage,
- fails to work in spite of functioning batteries,
- has been exposed for some time to unfavorable conditions ( e.g. storage beyond the permissible climatic limits without adaptation to the ambient climate, dewing etc.),
- has been exposed to major strain during transport ( e.g. been dropped from some height without visible external damage etc.), or
- shows " E1 ... E5 " on the display.

## ***Qualified Staff***

Consists of persons familiar with the setting up, assembly, starting up and operation of the product and possess the qualifications required for such activities, such as

- training, instruction and/or authorization to perform the following operations on circuits and equipment according to safety engineering standards: switching on and off, disconnecting, earthing/grounding, labeling;
- training or instructions according to safety engineering standards in the care and main tenance of adequate safety equipment.
- training in rendering first aid.

## ***Setup***

### ***Unpacking***

Check delivery for damage during transport. Keep the packing material for later transport and check scope of delivery.

### ***Checking the Scope of Delivery***

Upon unpacking immediately check the accessories for missing parts. The accessories supplied are listed on page 2.

### **Caution**

**Although the instrument is easy to operate please read these operating instructions carefully for safety reasons and in order to make optimum use of the instrument.**

The measuring functions are only all activated when the instrument is connected.

## General

Microprocessor controlled universal earth resistance meter with fully automated measuring frequency selection process as well as automatic testing of probe- and auxiliary earth electrode resistances and possible interference voltages as per DIN IEC61557-5/EN61557-5.

- Measurement of interference voltage ( $U_{ST}$ )
  - Measurement of interference frequency ( $F_{ST}$ )
  - Measurement of probe resistance ( $R_S$ )
  - Measurement of auxiliary earth electrode resistance ( $R_H$ )
  - Measurement of earthing resistance 3pole, 4pole, ( $R_E$ ) with or without using the external clip-on current transformer for selective measurement of single earthing branches in mesh operated earthing systems
- 
- Resistance measurement 2pole with AC voltage ( $R_{\sim}$ )
  - Resistance measurement with DC voltage 2pole, 4pole, ( $R_{\text{---}}$ )

With its various possibilities of measurement and the fully automated measuring sequence control (incl. automatic frequency control AFC), this instrument offers the latest measuring technology in the field of earthing resistance measurements. By means of the selectable limit input with visual and accoustical confirmation/error message and with the code programmable and customer defined special functions, e.g. measuring voltage 20 V (for agricultural systems), earthing impedance  $R^*$  (measuring frequency 55 Hz) switched on or off etc., these instruments are individually programmable for use as a simple meter as well as a high end fully automated measuring device.

## Additional Accessories

An **external current transformer** with a transformation ratio between 80 and 1200:1 for the measurement of a single branch in mesh operated earthing systems is available as an option and enables the user to measure on high voltage pylons without separating the overhead earth wires or earth strips at the bottom of the pylons and also to measure lightning protection systems without separating the individual lightning protection wires.

## ***Assembly***

The instrument is made up of two parts:

1. The base part which contains the measuring electronics.
2. The protective housing.

The functions are selected with the central rotary switch. Four rubber buttons, which start measurements, read out supplementary measuring values and select special functions, are located on the left hand side of the front panel. This design enables quick and clear one-hand operation.

The measured values are displayed on a liquid crystal display with correct decimal point and unit. Various additional special characters indicate measuring mode, operating condition and error messages.

The auxiliary power supply consists of 6 x 1.5 V batteries (IEC R6 or LR6 or type AA).

This device has been developed, designed and manufactured in compliance with quality system DIN ISO 9001.

## ***Description of Functions***

The following flowchart presents a description of the functions of the 1625 Earth/Ground Tester.

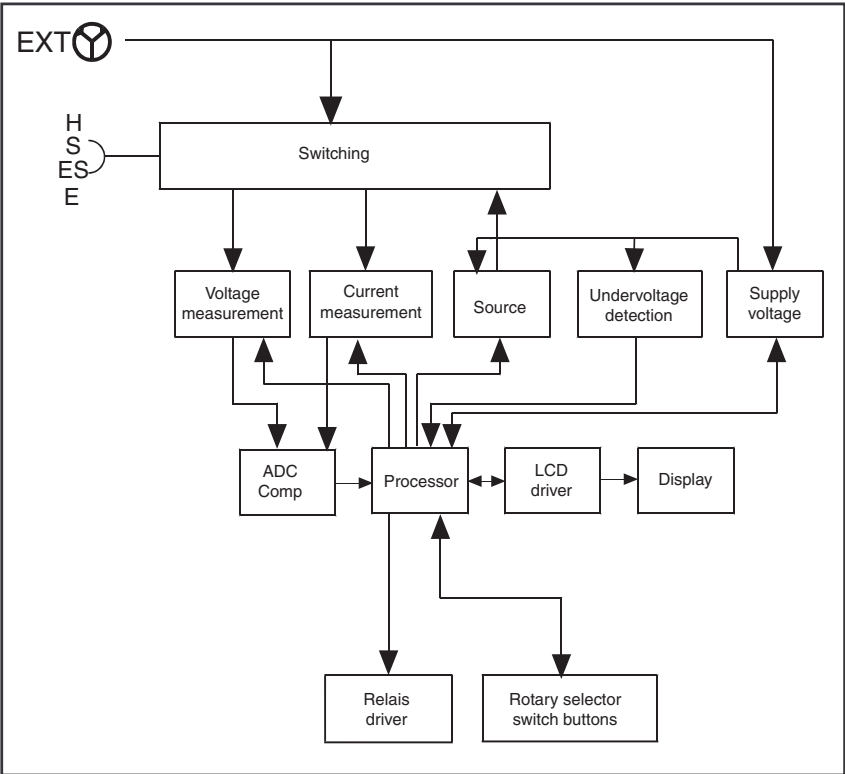

edw003.eps

Figure 2. Description of Functions

### **Measurement of Interference Voltage ( $U_{ST}$ )**

Fullwave rectification for DC and AC (DC without operational sign, AC signal sinus calibrated for r.m.s. values). If limit values are exceeded no measurement will be started.

### **Measurement of Interference Frequency ( $F_{ST}$ )**

For interference voltage  $>1$  V its frequency is derived from the period time.



### **Measurement of Earthing Resistance ( $R_E$ )**

The earthing resistance is determined by a 3- or 4-pole current and voltage measurement. The measuring voltage is a square pulse AC voltage with 48 / 20 V and a frequency of 94, 105, 111 or 128 Hz. The frequency can be selected manually or automatically (AFC).

### **Selective Measurement of Earthing Resistance ( $R_E \gg C$ )**

Measurement of a single earth electrode in a mesh operated (parallel) earthing system. The current flowing through the single earth electrode is measured with an external current transformer.

### **Resistance Measurement ( $R_{\sim}$ )**

The resistance is determined by a 2 pole current and voltage measurement. The measuring voltage is a square pulse AC voltage with 20 V and a frequency of 94, 105, 111 or 128 Hz. The frequency can be selected manually or automatically (AFC).

### **Low Resistance Measurement ( $R_{\sim}$ )**

The resistance is determined by DC current and voltage measurement. 2- as well as 4-pole measurement is possible. The short circuit current is  $> 200$  mA. The resistance of both current directions is measured and stored.

### **Checking for Correct Measuring Connection**

The processor checks if the measuring lead is properly connected according to the selected function via isolated, two piece contacts, inside of each 4 mm (banana) input socket, in combination with detection circuitry. A wrong or missing connection is indicated by an optical or acoustical signal.

### **Beeper**

The built in beeper has two functions:

1. Giving messages if set limit values are exceeded.
2. Indicating dangerous conditions or maloperation.

Controlling is done by means of the microprocessor.

**LO-BAT**

Supervision of the battery charge status is done with a comparator circuit. Via microprocessor, a drop in battery capacity down to typ. 10 % of its specified value is indicated on the display with symbol **LO-BAT**.

**Specifications**

- General: Microprocessor controlled, fully automated earth measuring instrument with additional functions
- Measuring function: interference voltage and frequency, earthing resistance 3- and 4-pole with / without clip-on current transformer, resistance 2-pole with AC, 2- and 4-pole with DC
- Display (see Figure 4): 4 digit (2999 Digit) - 7 segment liquid crystal display, digit size 18 mm with supplementary signs and active illumination.

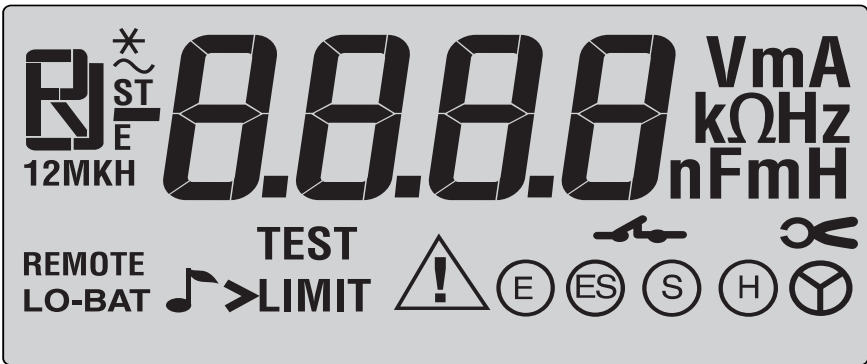

Figure 3. Display

edw004.eps

Operation:	Central rotary switch and function keys
Working temperature range:	-10 °C ... +50 °C
Operating temperature range:	0 °C ... +35 °C
Nominal temperature range:	18 °C ... +28 °C
Storage temperature range:	-30 °C ... +60 °C

*Note*

*The chart of four temperature ranges for the instrument exist to satisfy European Standards requirements; the instrument can be used over the full Working temperature range by using the temperature coefficient to calculate accuracy at the ambient temperature of use.*



Temperature coefficient:	± 0.1 % of range / Kelvin
Operating errors:	refer to operating temperature range and RH < 20 RE, RS < 100 RE

The maximum percentage operating error within the measurement range does not exceed ± 30 % with the measured value as fiducial value, as determined in accordance with TABLE 1.

The operating error applies under the rated operating conditions given in IEC1557-1 and the following:

- injection of series interference voltages with system frequencies of 400 Hz, 60 Hz, 50 Hz, 16 <sup>2</sup>/<sub>3</sub> Hz or with d.c. voltage respectively across the terminals E (ES) and S. The r.m.s. value of the series interference voltage shall be 3 V;
- resistance of the auxiliary earth electrode and of the probes: 0 to 100 x R<sub>A</sub> but ≤ 50 kΩ;
- system voltages between 85 % and 110 % of the nominal voltage and between 99 % and 101 % of the nominal system frequency for measuring equipment with a mains supply and/or measuring equipment deriving its output voltage directly from the distribution system.

Limits of error:	refer to nominal temperature range
Climate class:	C1 (IEC 654-1), -5 °C...+45 °C, 5 %...95 % RH
Type of protection:	IP 56 for case, IP 40 for battery door according to EN 60529

Max voltage:	 socket  to socket (E) (ES) (S) (H) Urms = 0 V Sockets " E ES S H " to each other in any combination, max. Urms= 250 V (pertains to misuse)
EMC (Emission Immunity):	IEC 61326-1:1997 Class A
Quality standard:	developed, designed and manufactured to comply with DIN ISO 9001
External field influence:	complies with DIN 43780 (8/76)
Auxiliary power:	6 x 1,5 V alkali-manganese-batteries (IEC LR6 or type AA )
Battery life span:	with IEC LR6/type AA: typ. 3000 measurements ( $R_E + R_H \leq 1 \text{ k}\Omega$ ) with IEC LR6/type AA : typ. 6000 measurements ( $R_E + R_H > 10 \text{ k}\Omega$ )
Dimensions:	240 mm (W) x 220 mm (D) x 90 mm ( H )
Weight:	$\leq 1.1 \text{ kg}$ without accessories $\leq 5.5 \text{ kg}$ incl. accessories and batteries in carrying case
Case material:	NORYL, shock -and scratch proof thermoplast

### Measurement of Interference Voltage DC + AC ( $U_{ST}$ )

Measuring method: fullwave rectification

Measuring Range	Display Range	Resolution	Frequency Range	Limits of Error
1...50 V	0.0...50 V	0.1 V	DC/AC 45...400 Hz sine	± (5% of reading +5 digit)

Measuring sequence: approx. 4 measurements /s

Internal resistance: approx. 1.5 MΩ

Max. overload:  $U_{RMS} = 250$  V

### Measurement of Interference Frequency ( $F_{ST}$ )

Measuring method: Measurement of oscillation period of the interference voltage

Measuring Range	Display Range	Resolution	Range	Limits of Error
16.0 ... 400 Hz	16.0...299.9...999 Hz	0.1 ... 1 Hz	1 V ... 50 V	± (1% v. mv +2 digit)

### Earthing Resistance ( $R_E$ )

Measuring method: current and voltage measurement with probe as IEC61557-5

Open circuit voltage: 20 / 48 V, AC

Short circuit current: 250 mA AC

Measuring frequency: 94 , 105 , 111 , 128 Hz selected manually or automatic.(AFC) 55 Hz in function R\*

Noise rejection: 120 dB ( 16 2/3, 50 , 60, 400 Hz )

Max. overload:  $U_{RMS} = 250$  V

Table 2. Electrical Measurement Specifications

Intrinsic Error or Influence Quantity	Reference Conditions or Specified Operating Range	Designation Code	Requirements or Test in Accordance with the Relevant Parts of IEC 1557	Type of Test
Intrinsic error	Reference conditions	A	Part 5, 6.1	R
Position	Reference position $\pm 90^\circ$	E1	Part 1, 4.2	R
Supply voltage	At the limits stated by the manufacturer	E2	Part 1, 4.2, 4.3	R
Temperature	0 °C and 35 °C	E3	Part 1, 4.2	T
Series interference voltage	See 4.2 and 4.3	E4	Part 5, 4.2, 4.3	T
Resistance of the probes and auxiliary earth electrodes	0 to 100 x $R_A$ but $\leq 50 \text{ k}\Omega$	E5	Part 5, 4.3	T
System frequency	99 % to 101 % of the nominal frequency	E7	Part 5, 4.3	T
System voltage	85 % to 110 % of the nominal voltage	E8	Part 5, 4.3	T
Operating error	$B = \pm( A  + 1,15\sqrt{E_1^2 E_2^2 E_3^2 E_4^2 E_5^2 E_6^2 E_7^2 E_8^2})$		Part 5, 4.3	R

<p>A = intrinsic error En = variations R = routine test T = type test</p>	$B[\%] = \pm \frac{B}{\text{fiducial value}} \times 100\%$
---	--

Measuring Range	Display Range	Resolution	Intrinsic Error	Max. Operating Error
0.020 Ω 300 kΩ	0.001 Ω...2.999 Ω	0.001 Ω	± ( 2 % of mv +2 digit )	± ( 5% of mv +5 digit )
	3.00 Ω...29.99 Ω	0.01 Ω		
	30.0 Ω...299.9 Ω	0.1 Ω		
	0.300 kΩ...2.999 kΩ	1 Ω		
	3.00 kΩ...29.99 kΩ	10 Ω		
	30.0 kΩ...299.9 kΩ	100 Ω		

Measuring time:                                    typ. 8 sec. with a fixed frequency  
   30 sec. max. with AFC and complete cycle of all measuring frequencies

Additional error because of probe-and auxiliary earth electrode resistance:  $\frac{R_H (R_S + 2000\Omega)}{R_E} \times 1.25 \times 10^{-6}\% + 5 \text{ digits}$

Measuring error of RH and RS:            typ. 10 % of  $R_E + R_s + R_H$

Max. probe resistance:                        ≤ 1 M Ω

Max. auxiliary earth electrode resistance: ≤ 1 M Ω

Automatic check if error is kept within the limits required by IEC61557-5.

If after a measurement of probe-, auxiliary earth electrode- and earthing resistance, a measurement error of higher than 30 % is assumed because of the in-

fluencing conditions (see diagramm), the display shows a warning symbol  $\Delta$  and a notice that RS or RH are too high.

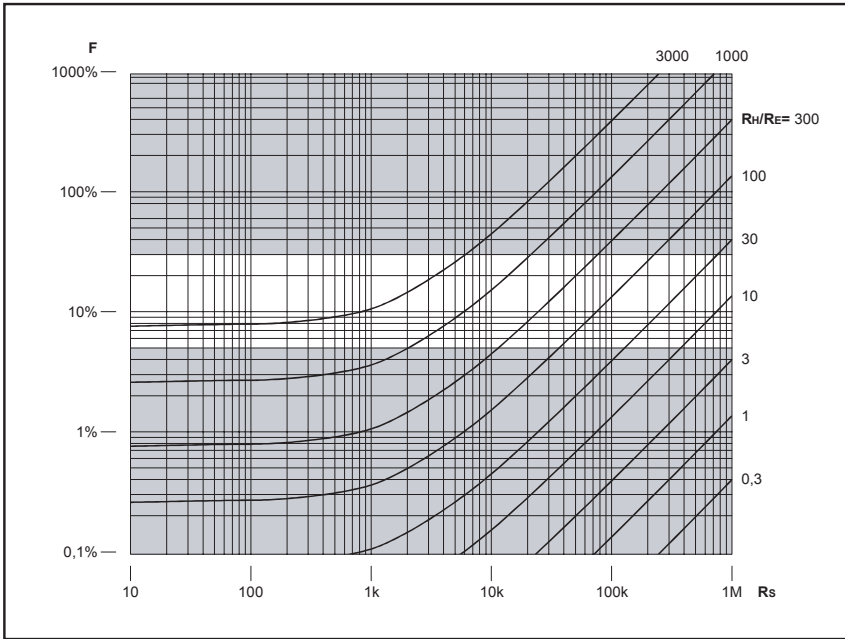

edw005.eps

Automatic switchover of measuring resolution in dependence to auxiliary earth electrode resistance  $R_H$ :

RH with $U_{meas} = 48 V$	RH with $U_{meas} = 20 V$	Resolution
< 300 $\Omega$	< 250 $\Omega$	1 m $\Omega$
< 6 k $\Omega$	< 2,5 k $\Omega$	10 m $\Omega$
< 60 k $\Omega$	< 25 k $\Omega$	100 m $\Omega$
< 600 k $\Omega$	< 250 k $\Omega$	1 $\Omega$



## Selective Measurement of the Earthing Resistance ( $R_E$

Measuring method:	Current and voltage measurement with probe as per EN61557-5 and current measurement in the individual branch with additional current transformer (patent applied for).
Open circuit voltage:	20 / 48 V AC
Short circuit current:	250 mA AC
Measuring frequency:	94, 105, 111, 128 Hz selected manually or automatically (AFC), 55 Hz ( $R^*$ )
Noise rejection:	120 dB (16 2/3 , 50 , 60 , 400 Hz)
Max. overload:	max. Urms = 250 V (measurement will not be started)

Measuring Range	Display Range	Resolution	Intrinsic Error *	Operating Error *
0.020 $\Omega$ ... 30 k $\Omega$	0.001...2.999 $\Omega$	0.001 $\Omega$	$\pm$ (7 % of m.v. +2 digit)	$\pm$ (10% of m.v. +5 digit)
	3.00...29.99 $\Omega$	0.01 $\Omega$		
	30.0...299.9 $\Omega$	0.1 $\Omega$		
	0.300...2.999 k $\Omega$	1 $\Omega$		
	3.00...29.99 k $\Omega$	10 $\Omega$		

\* With recommended current clamps / transformers.

Additional error because of probe- and auxiliary earth typ.electrode resistance:

$$\frac{R_H (R_S + 2000\Omega)}{R_{ETOTAL}} \times 1.25 \times 10^{-6}\% + 5 \text{ digits}$$

Measuring error of  $R_H$  and  $R_S$ :      typ.of 10% of  $R_{ETOTAL} + R_S + R_H$

Measuring time:      typ. 8 sec. with a fixed frequency 30 sec.max. with AFC and complete cycle of all measuring frequencies

Minimal current in single branch to be measured:	0.5 mA	with transformer (1000:1)
	0.1 mA	with transformer (200:1)
Max. interference current through transformer:	3 A	with a transformer (1000:1)

### **Resistance Measurement (R~)**

Measuring method:	current and voltage measurement
Measuring voltage:	20 V AC, square pulse
Short circuit current:	> 250 mA AC
Measuring frequency:	94, 105, 111, 128 Hz selected manually or automatically (AFC)

Measuring Range	Display Range	Resolution	Intrinsic Error	Operating Errors
0.020 Ω... 300 kΩ	0.001 Ω ... 2.999 Ω	0.001 Ω	± ( 2 % of m.v. +2 digit )	± ( 5% of m.v. +5 digit )
	3.0 Ω ... 29.99 Ω	0.01 Ω		
	30 Ω ... 299.9 Ω	0.1 Ω		
	300 Ω ... 2999 Ω	1 Ω		
	3.0 kΩ ... 29.99 kΩ	10 Ω		
	30.0 kΩ ... 299.9 kΩ	100 Ω		

Measuring time:	typ. 6 sec.
Max. interference voltage:	24 V, with higher voltages measurement will not be started
Max overload:	Urms max. = 250 V

## Resistance Measurement ( $R_{\rightarrow}$ )

Measuring method:	current- voltage measurement as per IEC61557-4 possible
Open circuit voltage:	20 V DC
Short circuit current:	200 mA DC
Formation of measured value:	with 4-pole measurement wires on H, S, ES can be extended without additional error.  Resistances $>1 \Omega$ in wire E can cause additional error of $5m \Omega/\Omega$ .

Measuring Range	Display Range	Resolution	Intrinsic Error	Operating Error
0.020 $\Omega$  3 k $\Omega$	0.001 $\Omega$ ... 2.999 $\Omega$	0.001 $\Omega$	$\pm(2\%$ of m.v. +2 digit)	$\pm(5\%$ of m.v. +5 digit)
	3.0 $\Omega$ ... 29.99 $\Omega$	0.01 $\Omega$		
	30.0 $\Omega$ ... 299.9 $\Omega$	0.1 $\Omega$		
	300 $\Omega$ ... 2999 $\Omega$	1 $\Omega$		

Measuring sequence:	approx. 2 measurements/s
Measuring time:	typ. 4 sec. incl. reversal of polarity (2 pole or 4 pole)
Max. interference voltage:	$\leq 3$ V AC or DC, with higher voltages measurement will not be started
Max inductivity:	2 Henry
Max. overload:	Urms = 250 V

## Compensation of Lead Resistance ( $R_K$ )

Compensation of lead resistance ( $R_K$ ) can be switched on in functions  $R_E$  3pole,  $R_E$  4pole ,  $R_{\sim}$ , and  $R_{\equiv}$  2pole

Formation of measured value:

$$R_{\text{display}} = R_{\text{measured}} - R_{\text{compensated}}^*$$

\* Value of setpoint entry  $R_K = 0.000\Omega$ , variable from  $0.000 \dots 29.99 \Omega$  by means of measuring adjustment.

## Description of the Operating Elements

Figure 4 illustrates the operating elements described below.

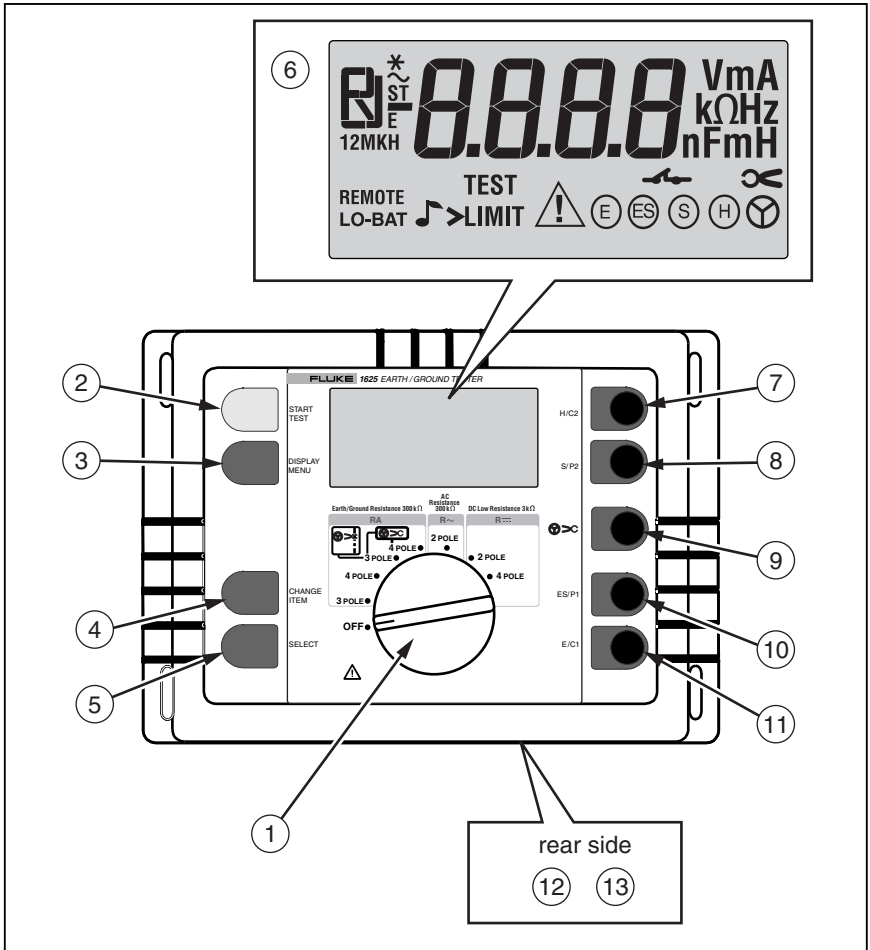

**Figure 4. Operating Elements**

edw006.eps

- ① Central rotary switch to select measuring function or switch ON/OFF
- ② "START TEST"-button to start the set measuring function.
- ③ "DISPLAY MENU"-button to call corresponding supplementary values.

- ④ "CHANGE ITEM" button to change the set point entry values.
- ⑤ "SELECT" button to select the digit to be changed.
- ⑥ Display unit, liquid crystal digits, 18 mm high with automatic decimal point as well as active illumination.
- ⑦ Connecting socket  $\text{Ⓜ}$  (auxiliary earth electrode) (4 mm  $\emptyset$ ) also usable with safety measuring lead
- ⑧ Connecting socket  $\text{Ⓢ}$  (probe) (4 mm  $\emptyset$ ) also usable with safety measuring lead.
- ⑨ Connecting socket for an ext. clip-on current transformer (optional).

### **⚠ Warning**

**No voltage permissible to sockets  $\text{ⓔ}$   $\text{Ⓢ}$   $\text{Ⓢ}$   $\text{Ⓜ}$  .**

- ⑩ Connecting socket  $\text{Ⓢ}$  (earthing probe) (4 mm  $\emptyset$ ) also usable with safety measuring lead. Potential pick off with 4-pole earthing measurement.
- ⑪ Connecting socket  $\text{ⓔ}$  (earth electrode) (4 mm  $\emptyset$ ) also usable with safety measuring lead.

### **⚠ Attention**

**Do not open or close the instrument with force!**

- ⑫ Battery compartment for: 6 x IEC LR6 batteries or type AA batteries.

### **⚠ Warning**

**Disconnect all leads before opening the instrument!**

- ⑬ Screws to fasten the battery compartment

## Description of Display Elements

The display (Figure 5) is divided into four display elements:

1. Digital display of measured value
2. Measuring function field to display measuring function
3. Unit field: V,  $\Omega$ , k $\Omega$ , Hz
4. Special characters for operator guidance

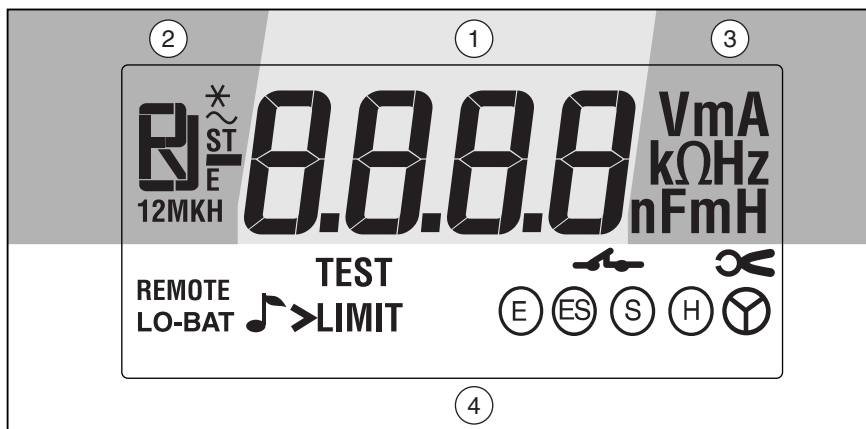





**Figure 5. Display Elements**

edw008.eps

Description of display symbols:

$U_{ST}$	Interference voltage (AC + DC)
$F_{ST}$	Frequency of interference voltage
$F_M$	Frequency of measuring voltage
$U_M$	Measuring voltage limit 20/48 V
$R_E$	Earthing resistance
$R_H$	Auxiliary earth electrode resistance
$R_S$	Probe resistance
$R_K$	Compensation resistance
$R_1, R_2$	Low voltage measurement with polarity indication

R ~	AC- resistance
R*	Earthing impedance (measuring frequency 55 Hz)
AFC	Automatic-frequency-control
TEST	Measuring sequence in process
LIMIT	Limit value
> LIMIT	Limit value exceeded
	Socket recognition
	Recognition of current transformer socket
	Message of an exceeded limit with beeper
LO-BAT	Battery voltage too low, replace batteries.
REMOTE	Interface ( optional ) active - button operation locked
	Measuring circuit ( E-S,E-H ) interrupted or measured value instable

### **⚠ Warning**

**Refer to Operating Instructions.**

## ***Procedure of Measurements***

### **⚠ Warning**

**Use the instrument on voltage free systems only.**

1. Set measuring function with the central rotary switch ①
2. Connect instrument without measuring lead connected START is omitted
3. Start measurement with "START TEST" button.
4. Read out measured value.

For optimum performance and utilization of the device observe the following points:



## **POWER ON Functions**

During switching on of the instrument with the central rotary switch it is possible to access certain operating conditions by pressing certain button combinations:

### **a) Standard mode**

If the device is put into operation without further button control, it switches into a battery saving condition (Stand by-display "---") approx. 50 seconds after the termination of a measurement, or after a button push or turn of the rotary switch. Pressing the "DISPLAY MENU" reactivates the instrument; the "old" measured values can be read out again. After 50 min. of stand by the Display is turned off completely. Instrument is reactivated with ON / OFF on the rotary switch

### **b) Stand by disable**

A simultaneous push of buttons "DISPLAY MENU" and "CHANGE ITEM" during switching on prevents the instrument from being switched off automatically (Stand by). The battery saving mode is reactivated with ON / OFF on the central rotary switch.

### **c) Prolonged displaytest**

By keeping the "DISPLAY MENU" button pressed during switching on, the display test can be prolonged for any length of time. Return to the standard operation mode by pressing any button or turning of the central rotary switch.

### **d) Number of software version**

By keeping the "SELECT" button pressed during the switch on sequence, the number of the software version is indicated on the display. By pressing the "DISPLAY MENU" button a switch over to the last calibration date is possible. This display sequence is terminated by turning the central rotary switch or pressing the "START TEST" button.

Display format:	SOFTWARE-version:	X. X X
	Date of calibration:	M M . J J

#### *Note*

*At delivery the date of calibration is set to 0.00. Only after the first recalibration a proper date is indicated.*

**e) Activation of display illumination**

By keeping the "CHANGE ITEM" button pressed during the switch on sequence the display illumination is activated. Illumination fades away automatically if the instrument is switched to "Stand by" and, together with the instrument, is switched on again by pressing any button. The instrument is switched off with ON/OFF on the central rotary switch exclusively.

***Operation***

The measuring functions have two initial operational modes: the Control loop and the Measuring loop (see Figure 6).

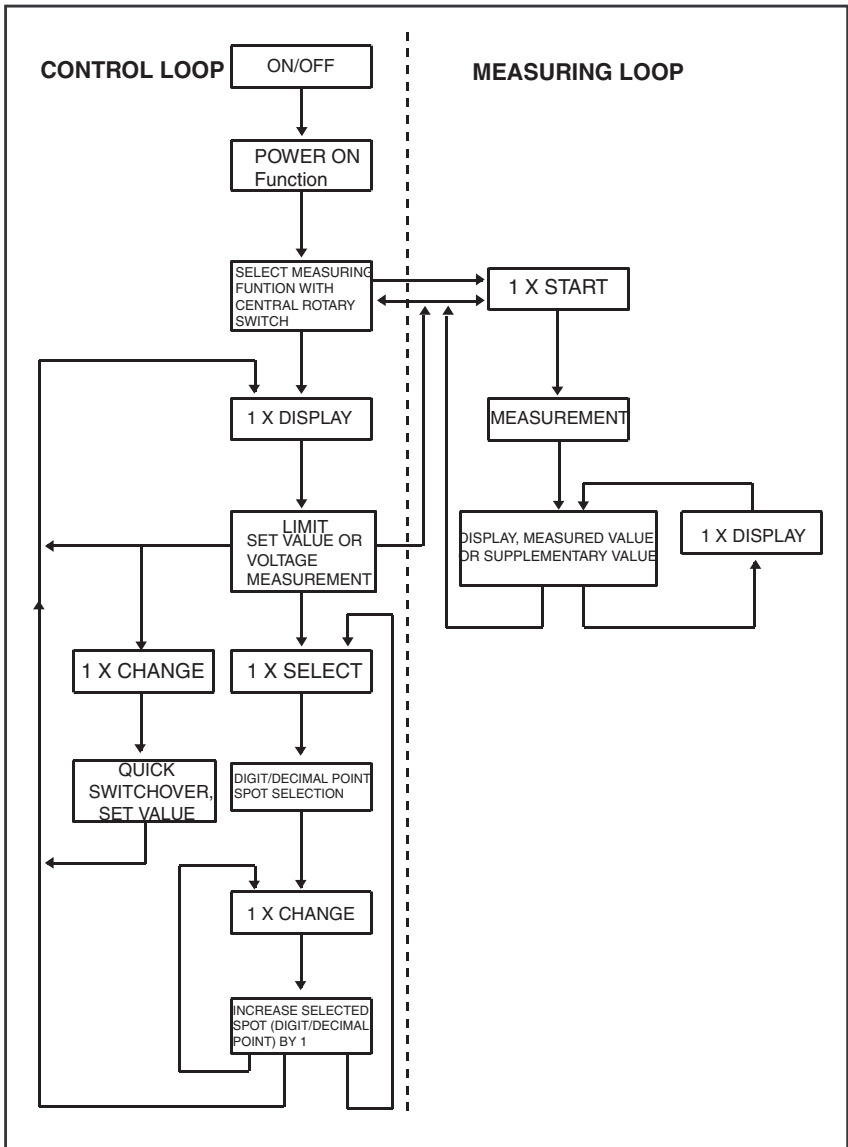

**Figure 6. Operational Modes**

edw009.eps

## Control Loop

After turning the function rotary switch, the voltage display mode is reached. Pushing "DISPLAY MENU" now calls up the control loop. According to the selected measuring function, different setting values can be displayed and changed in the control loop. The "DISPLAY MENU" button switches between the different set values inside a continuous loop. The "SELECT" button selects the decimal point to be changed. Pushing the "CHANGE ITEM" button the instrument either switches between certain set values or increases the decimal point selected with "SELECT" by 1.

After parameter setting has been finished the next display can be called with "DISPLAY MENU" or the measurement can be started with "START TEST".

Depending on the selected function, the following parameters can be displayed or changed:

Function	Parameter	Setting Range	Remarks
RE 3pole	U ST		display only
	F ST		display only
	FM	(AFC/94/105/111/128) Hz	
	UM	48 V/20 V	selectable to 20 V with CODE
and	RK	0.000 Ω ... 29.99 Ω	in position RE 3pole only *
	RE LIMIT	0.000 Ω ... 999 kΩ	only if activated with CODE
RE 4pole	♪(warning Sound)	On/Off	only if RE LIMIT is activated with CODE
	R*	On/Off	only if activated with CODE
RE	U ST		display only
	F ST		display only

**Earth/Ground Tester**  
Procedure of Measurements

<b>&gt;C</b>	UM	48 V/20 V	selectable to 20 V with CODE
and	R <sub>K</sub>	0.000 Ω ... 29.99 Ω	in position R <sub>E</sub> 3pole only *
R <sub>E</sub> 4pole	I ( ratio )	80 ... 1200	display only
<b>&gt;C</b>	R <sub>E</sub> LIMIT	0.000 Ω ... 999 kΩ	only if activated with CODE
	♪(warning-sound)	On / Off	only if R <sub>E</sub> LIMIT is activated with CODE
	R*	On / Off	only if activated with CODE

\* (see Compensation of Earth Electrode Connecting Lead)

Function	Parameter	Setting Range	Remarks
R~	U <sub>ST</sub>		display only
	F <sub>ST</sub>		display only
	F <sub>M</sub>	(AFC/94/105/111/128) Hz	
	R <sub>K</sub>	0.000 Ω ... 29.99 Ω	
	R ~ LIMIT	0.000 Ω ... 999 kΩ	only if activated with CODE
	♪(warning-sound)	On / Off	only if R ~ LIMIT is activated with CODE
R <sub>...</sub> 2pole and 4pole	U <sub>ST</sub>		display only
	F <sub>ST</sub>		display only
	R <sub>K</sub>	0.000 Ω ... 29.99 Ω	
	R LIMIT	0.000 Ω ... 9,99 kΩ	only if activated with CODE
	♪(warning - sound)	On / Off	only if R LIMIT is activated with CODE

## Measuring Loop

This loop is entered by pressing the "START TEST" button. After releasing "START TEST" the last measured value stays on the display. By repeated pressing of the "DISPLAY MENU" button all supplementary values can be called. If a measured value exceeds or falls below the pre-set limit, the limit can be displayed as well (with "DISPLAY MENU"). In that case the measured value is displayed with a flashing "LIMIT" whereas the limit value is displayed with a steady "LIMIT"-symbol.







### **Inside the measuring loop parameters cannot be changed.**

Further possibilities of button operation:

Warning sound (🔊) cancel with "DISPLAY MENU" (with display switchover) or with "CHANGE ITEM" or "SELECT" button (without display switchover).

## *Checking of Correct Measuring Connection (Socket Allocation)*

The instrument implements an automatic check, corresponding to the measurement selected, to see if the correct input sockets are used.

The display symbols     and   are assigned to a specific socket as shown in Figure 4.

From the way the symbols are displayed, the validity of the connected wiring can be concluded by the following features:

- socket incorrectly wired (or, by mistake, not wired): corresponding symbol flashes.
- socket correctly wired: corresponding symbol is steady active
- socket with no connection: corresponding symbol is blank

### **Safety Control Measurements**

Before each measurement the instrument automatically checks the measuring conditions and, while simultaneously displaying the kind of error, prevents measurements from being started under the following conditions:

- excessive voltage on the sockets ( $> 24$  V in RE and R~;  $> 3$  V in R $\overline{\text{---}}$ )
- wrong or incomplete connection
- Problems during the measuring sequence (display "E1 ... E5") see display description in the section 'Procedure of Measurements'.
- Battery voltage too low ( display LO-BAT )

### **Measurement of Interference - Voltages and Frequencies**

This measuring function detects possible interference voltages and their frequencies. This function is automatically active in every switch position before an earthing or resistance measurement. If the pre-set limit values are exceeded, the interference voltage is indicated as too high and a measurement automatically prevented. The frequency of an interference voltage is only measurable if the level of this interference voltage is higher than 1 V. See Figure 7.

Bring central rotary switch in desired position, read out measured value of interference voltage, measured value of interference frequency is displayed with "DISPLAY".

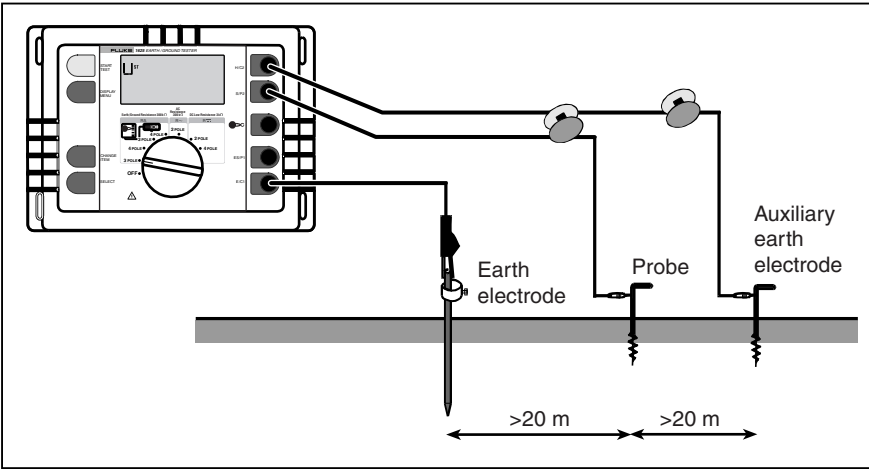

edw010.eps

**Figure 7. Measurement of Interference - Voltages and Frequencies**

## **Measurement of Earthing Resistances**

This instrument is equipped with a 3 pole as well as a 4 pole resistance measurement which renders measurements of resistances of earthing systems possible, as well as measurements of the soil resistivity of geological strata. A specific description of the different applications is given further on in this manual. As a special function, the instrument offers measurements with an external current transformer, with which a measurement of single resistance branches in interlinked networks (lightning protection and high voltage pylons with cabling) can be performed without separating parts of the system.

To ensure most feasible interference suppression during measurements, the instrument is equipped with 4 measuring frequencies (94 Hz, 105 Hz, 111 Hz, 128 Hz), with automatic switch over if necessary (AFC - Automatic Frequency Control). The corresponding measuring frequency used for a specific measurement can be called and displayed with "DISPLAY MENU" after the measurement. Additionally, one of the four measuring frequencies can be selected and permanently set in special cases. In that case, in order to stabilize the display, an average measurement can be carried out for up to 1 minute by keeping the "START TEST" button pressed.

To determine the earthing impedance ( $R^*$ ) a measurement with a frequency close to the mains frequency (55 Hz) is carried out. At the activation of  $R^*$  through user's code, this measuring frequency is activated automatically.



To keep the instrument as simple as possible at the time of delivery, all special functions, such as LIMIT input, BEEPER programming, measurement of earthing impedance ( $R^*$ ) etc, are not activated at delivery. They can be activated with personalized user's code (see "Changing of all Pre-set Data with Personalized Code"). Refer to Figure 8.

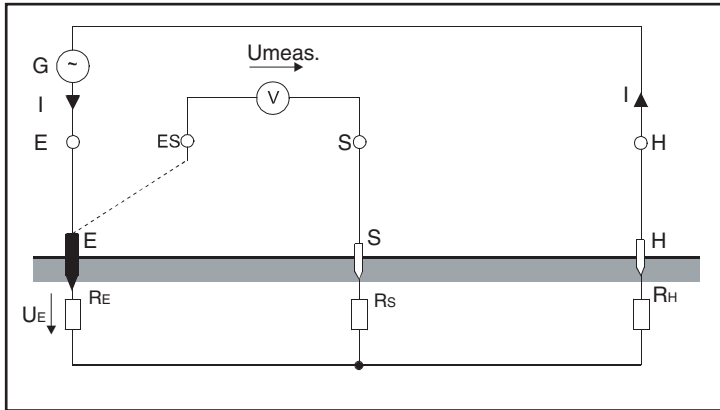

edw011.eps

**Figure 8. Earthing Resistances Measurement - Method**

### ***3-pole/4-pole Measurement of Earthing Resistance***

This measuring function measures earthing and earth dissipation resistances of single earth electrodes, foundation earth electrodes and other earthing systems by using 2 earth spikes. See Figure 9.

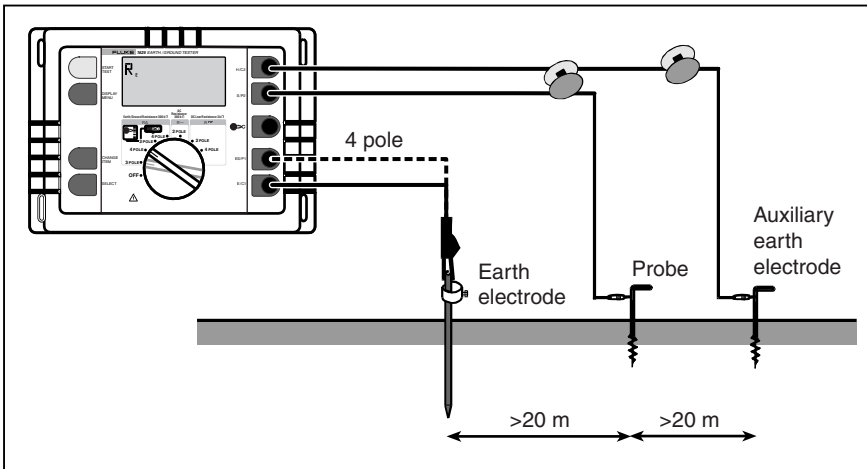

edw012.eps

**Figure 9. 3-pole/4-pole Measurement of Earthing Resistance - Process**

1. Turn central rotary switch to position "R<sub>E</sub> 3pole" or "R<sub>E</sub> 4pole"

The instrument is to be wired according to picture and notices given on the display.

A flashing of the sockets symbols (E) (ES) (S) (H) or  $\infty$ , points to an incorrect or incomplete connection of the measuring lead.

2. Press "START TEST" button

Now a fully automated test sequence of all relevant parameters like auxiliary earth electrode, probe- and earth electrode resistance, is implemented and finished with the display of the result R<sub>E</sub>.

3. Read out measured value R<sub>E</sub>
4. Call R<sub>S</sub> and R<sub>H</sub> with "DISPLAY MENU".

#### Remarks for the setting of earth spikes:

Before setting the earth spikes for probe and auxiliary earth electrode make sure that the probe is set outside the potential gradient area of earth electrode and auxiliary earth electrode (also see "The Influence of Potential Gradient areas on Earth Resistance Measurement"). Such a condition is normally reached by allowing a distance of > 20 m between the earth electrode and the earth spikes as well as of the earth spikes to each other.

An accuracy test of the results is made with another measurement following repositioning of the auxiliary earth electrode or probe. If the value stays the same, the distance is sufficient. If the measured value changes, probe or auxiliary earth electrode must be repositioned until the measured value  $R_E$  stays constant.

Spike wires should not run too close to each other.

### **3-pole measurement with longer earth electrode connecting leads**

Use one of the accessory cable drums as earth electrode connecting lead. Spool off cable completely and compensate line resistance as described in "Compensation of Earth Electrode Connecting Lead".

#### **Time average measurement:**

If there is a warning "measured value unstable" (see "Procedures of Measurement", "Description of display") after a test sequence, most likely it is caused by strong interference signals (e.g. unsteady noise voltage). Nevertheless, to get reliable values, the instrument offers the possibility of averaging over a longer period.

1. Select a fixed frequency (see "Control loop" in "Operation")
2. Keep the "START TEST" button pressed until the warning "measured value unstable" disappears. Max. averaging time is approx. 1 min.

#### **Evaluation of measured value:**

Figure 10 shows the maximum permissible value of the Earth resistance which will not exceed a permissible limit value, taking into account the maximum usage error.

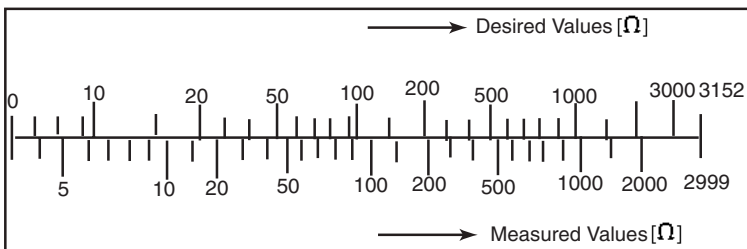

**Figure 10. Earth Resistance - Maximum Permissible Value**

edw013.eps

### Measurement of Single Earth Electrode Resistances in Mesh Operated Earthing Systems Using Selective Clamp Method

This measuring method has been created to measure single earth electrodes in permanently wired or mesh operated systems (e.g. lightning protection system with several electrodes or high voltage pylons with earth cabling etc.). By measuring the actual current flow through the earth electrode, this special measuring method provides the unique possibility to measure selectively only this particular resistance by means of a clip-on transformer (accessory). Other parallel resistances applied are not taken into account and do not distort the measuring result.

A disconnection of the earth electrode before the measurement is therefore no longer necessary.

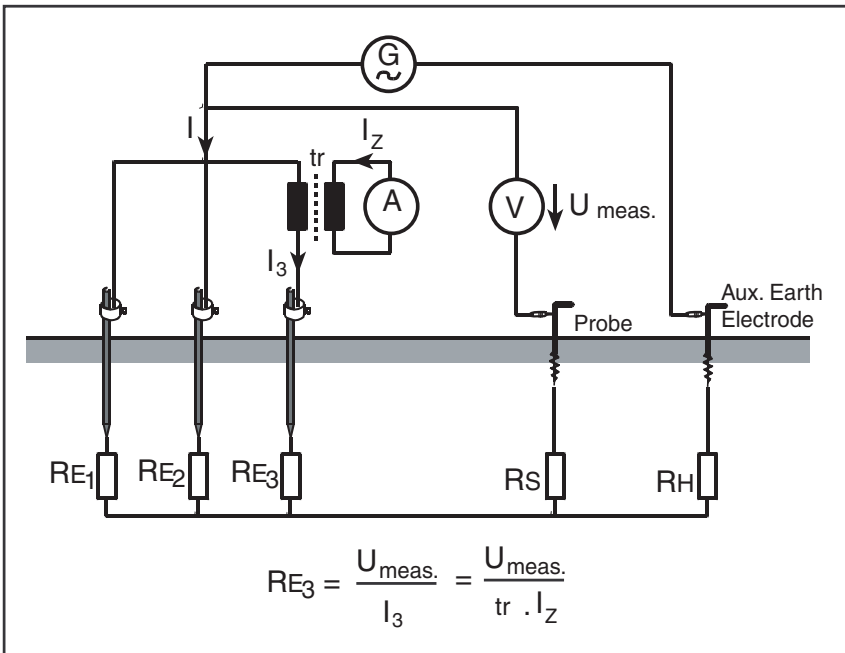

edw014.eps

Figure 11. Measurement of Single Earth Electrode Resistances in Mesh Operated Earthing Systems

Errors of the current transformer can be corrected as described in “Correcting Clip-on Transformer Error”.

### **3-pole/4-pole Measurement of Single Earth Electrode Resistances**

See Figure 12.

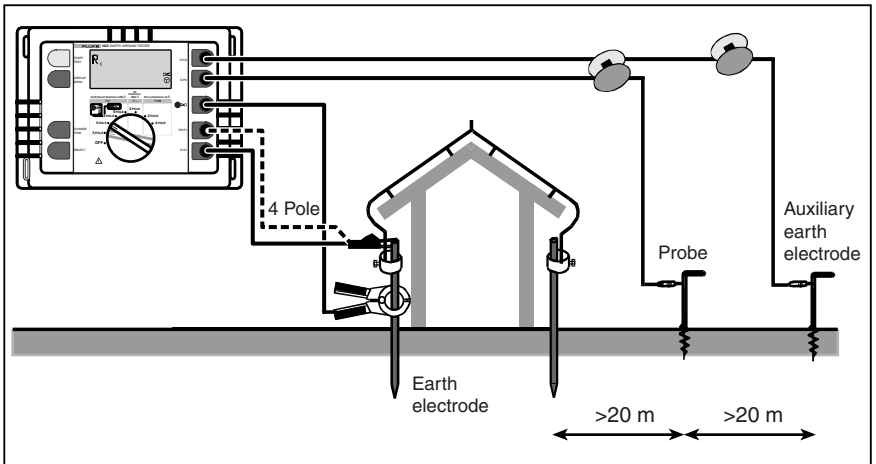

**Figure 12. 3-pole/4-pole Measurement of Single Earth Electrode Resistances**

Turn central rotary switch to position "⊗ RE 3pole" or "⊗ RE 4pole". The instrument is to be wired according to picture and notices given on the display.

A flashing of the sockets symbols (E) (ES) (S) (H) or ⊗, points to an incorrect or incomplete connection of the measuring lead.

#### **Fix clip-on transformer around the earth electrode to be measured.**

Make sure that the clip-on transformation ratio set on the instrument corresponds to the clip-on transformer used. Change settings if necessary (see “Changing of all Data Settings with Personalised CODE”)

*Note*

*The ratio that is preset from factory is correct for the EI162X sensing clamp*

**Press "START TEST" button.**

Now a fully automated test sequence of all relevant parameters like auxiliary earth electrode, probe- and earth electrode resistance, is implemented and finished with the display of the result  $R_E$ .

1. Read out measured value  $R_E$
2. Call  $R_S$  and  $R_H$  with "DISPLAY MENU".

### Remarks for the Setting of Earth Spikes

Before setting the earth spikes for probe and auxiliary earth electrode make sure that the probe is set outside the potential gradient of earth electrode and auxiliary earth electrode (see also 12.5). Such a condition is normally reached by allowing a distance of  $>20$  m between the earth electrode and the earth spikes as well as to the earth spikes to each other. An accuracy test of the results is made by another measurement following repositioning of the auxiliary earth electrode or probe. If the value stays the same, the distance is sufficient. If the measured value changes, probe or auxiliary earth electrode must be repositioned until the measured value  $R_E$  stays constant.

Spikes wires should not run too close.

### 3-pole Measurement with Longer Earth Electrode Connecting Leads

1. Use one of the accessory cable drums as earth electrode connecting lead.
2. Spool off cable completely and compensate line resistance as described in "Compensation of Earth Electrode Connecting Lead".

### Time Average Measurement

If there is a warning "measured value unstable" (see "Description of Displays", Procedure of Measurements) after a test sequence, most likely it is caused by strong interference signals (e.g. unsteady noise voltage). Nevertheless, to get

reliable values, the instrument offers the possibility of averaging over a longer period.

1. Select a fixed frequency (see "Control loop", Operation)
2. Keep the "START TEST" button pressed until the warning "measured value unstable" disappears. Max. averaging time is approx. 1 min.

## *Measurements on High Voltage Pylons*

### **Measuring the Earthing Resistance without Disengaging the Overhead Earth Wire Using the Selective Clamp Method**

The measurement of the earth resistance of a single high voltage pylon usually requires the overhead earth wire to be disengaged (lifted off) or the separation of the earthing system from the pylon construction. Otherwise false reading of the resistance of the pylon earth electrode are liable to occur because of the parallel circuit of the other pylons connected to each other by an overhead earth wire.

The new measuring method employed in this instrument - with its external current transformer to measure the true current flowing through the earth electrode - allows measurements of earth electrode resistances without disconnection of the earthing system or disengaging the overhead earth wire.

As all four pylon stubs are connected to the foundation earth of the pylon, the measuring current  $I_{\text{meas}}$  is divided into five components according to the present resistances involved.

One part flows via pylon construction to the overhead earth wire and further to the parallelly circuited pylon earthing resistances.

The other four current components ( $I_1 \dots I_4$ ) flow via the individual pylon foots.

The addition of all currents result in a current  $I_E$  going through the earthing resistance, i.e. the resistance of the "composite" earth electrode to the soil.

If the current transformer is fixed to each pylon stub, one after the other, four resistances have to be measured which show a behaviour inversely proportional to the corresponding current components  $I_1 \dots I_4$ . The feeding point of the measuring current is to be left unchanged to avoid a change in the current distribution.

Accordingly, these equivalent resistances are displayed as:

$$R_{Ei} = \frac{U_{meas}}{I_i}$$

Therefore the earthing resistance  $R_E$  of the pylon is determined as a parallel circuit of the individual equivalent resistances:

$$R_E = \frac{1}{\frac{1}{R_{E1}} + \frac{1}{R_{E2}} + \frac{1}{R_{E3}} + \frac{1}{R_{E4}}}$$

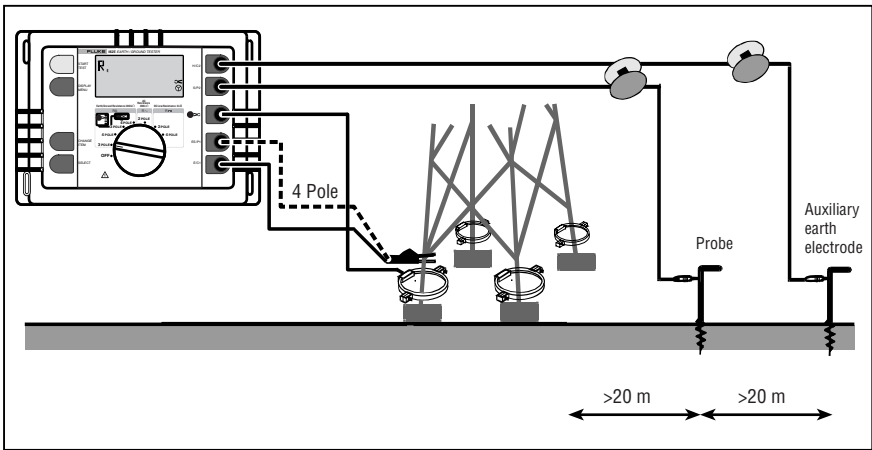

edw016.eps

**Figure 13. Measuring the Earthing Resistance without Disengaging the Overhead Earth Wire**

1. Turn central rotary switch to position “ $\text{⌘} R_E$  3pole” or  $\text{⌘} R_E$  4pole”. The instrument is to be wired according to picture and notices given on the display.

A flashing of the sockets symbols  $\text{ⓔ}$   $\text{ⓔ}$   $\text{ⓔ}$   $\text{ⓔ}$  or  $\text{ⓔ} \text{⌘}$ , points to an incorrect or incomplete connection of the measuring lead.

2. Apply current transformer to the pylon stub. Make sure that the transformation ratio set on the instrument corresponds to the current transformer used. Change settings if necessary (see “Changing of All Data Settings with Personalised CODE”)



3. Press “START TEST” button

Now a fully automated test sequence of all relevant parameters like auxiliary earth electrode, probe- and earth electrode resistance, is implemented and finishes with the display of the result  $R_E$ .

4. Read out measured value  $R_E$
5. Call  $R_S$  and  $R_H$  with “DISPLAY MENU”.

**Notices for the setting of earth spikes:**

Before setting the earth spikes for probe and auxiliary earth electrode make sure that the probe is set outside the potential gradient of earth electrode and auxiliary earth electrode (see also “The Influence of Potential Gradient Areas on Earth Resistance Measurement”). Such a condition is normally reached by allowing a distance of  $>20$  m between the earth electrode and the earth spikes as well as to the earth spikes to each other. An accuracy test of the results is made with another measurement after repositioning of auxiliary earth electrode or probe. If the result is the same, the distance is sufficient. If the measured value changes, probe or auxiliary earth electrode must be repositioned until the measured value  $R_E$  remains constant. Spike wires should not run too close.

1. Apply current transformer to next pylon stub.
2. Repeat measuring sequence.

Current feeding point of measuring current (alligator clip) and the polarity of the split core current transformer has to be left unchanged.

After values of  $R_{Ei}$  of all pylon foots are determined, the actual earth resistance  $R_E$  has to be calculated:

$$R_E = \frac{1}{\frac{1}{R_{E1}} + \frac{1}{R_{E2}} + \frac{1}{R_{E3}} + \frac{1}{R_{E4}}}$$

*Note*

*If the displayed  $R_E$  value is negative despite correct orientation of the current transformer, a part of the measuring current is flowing upwards into the tower body. The earthing resistance, thus coming into effect, correctly calculates, if the individual equivalent resistances (under observation of their polarity) are inserted into the equation above.*

**Time average measurement:**

If there is a warning "measured value unstable" (see "Description of displays", Procedure of Measurement) after a test sequence, most likely it is caused by strong interference signals (e.g. unsteady noise voltage).

Nevertheless, to get reliable values, the instrument offers the possibility of averaging over a longer period.

1. Select a fixed frequency (see "Control loop", Operation)
2. Keep the "START TEST" button pressed until the warning "measured value unstable" disappears. Max. averaging time is approx. 1. min.

**Measuring Earthing Impedance with 55 Hz ( $R^*$ )**

For the calculation of short circuit currents in power supply plants, the complex earthing impedance is important. Direct measurement is possible under the following conditions:

Phase angle at 50 Hz:  $30^\circ \dots 60^\circ$  inductive

auxiliary earth electrode (ohmic):  $>100 \cdot Z_E$

**Measuring process:**

The measurement of the earthing impedance ( $R^*$ ) is only possible if it is activated by putting in a personalized user's code (see "Change of Setup Data with Personalized Code"). If this measuring function is activated, in every measurement of the four RE positions, the earthing impedance  $R^*$  is displayed before all other measured values.

**Correcting Clip-on Transformer Errors**

If the measurement of an earthing resistance by means of a clip-on transformer results in a significantly different value as if measured without the clip-on, the deviation may be due to the tolerances of the clip-on current transformer. This error can be corrected by fine tuning the clip-on transformation ratio (basic settings 1000:1). This correction applies to the transformer current range it was performed with. For other ranges a different correction may be necessary.

1. Connect a low Ohm resistor (approx. 1 Ohm - in the range you want to correct) as described in the picture below.

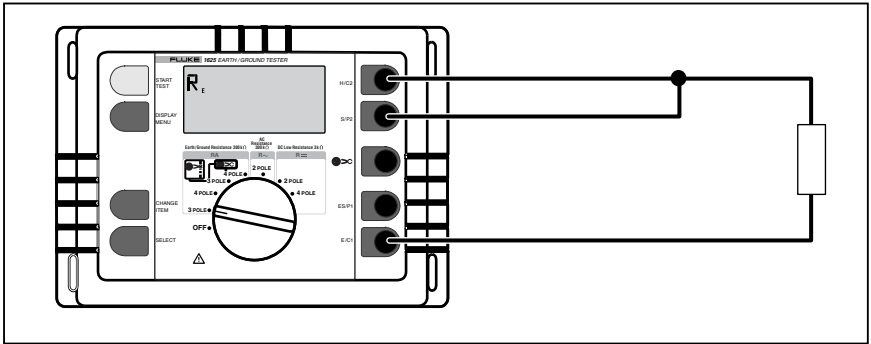

edw017.eps

**Figure 14. Correcting Clip-on Transformer Errors**

2. Turn central rotary switch to position "∞ RE 3pole".
3. Press "START TEST"-button and note result of RE value.
4. Connect clip-on transformer.

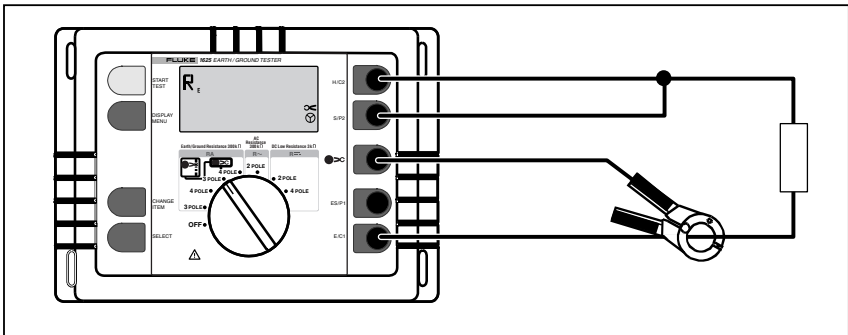

edw018.eps

5. Turn central rotary switch to position "∞ RE 3pole".
6. Press "START TEST" again.

If the thus measured value  $R_E$  deviates from the  $R_E$  value determined without clip-on transformer by more than 5 %, adjust the clip-on transformation ratio ( $tr$ ) correspondingly:

$$tr_{new} = tr_{old} \times \frac{R_E(\text{withclip-ontransformer})}{R_E(\text{withoutclip-onTransformer})}$$

Example:

Your clip-on transformer has a transformation ratio of  $tr = 1000:1$ . The measurement without clip-on transformer results in a value  $R_E = 0.983 \Omega$ . With a clip-on transformer a value of  $R_E = 1.175 \Omega$  is measured.

The deviation thus reads  $(1.175 - 0.983) \Omega = +0.192 \Omega$  and referring to  $R_E = 0.983 \Omega$  an error evolves as following:

$$100\% \times \frac{0.192 \Omega}{0.983 \Omega} = +19.5\%$$

The new transformation ratio to be set calculates:

$$tr_{new} = 1000 \times \frac{1.175}{0.983} = 1195$$

### Compensation of Earth Electrode Connecting Lead

If the line resistance to the earth electrode can not be ignored, a compensation of the connecting lead resistance to the earth electrode is possible. Proceed as described below:

#### Measuring process:

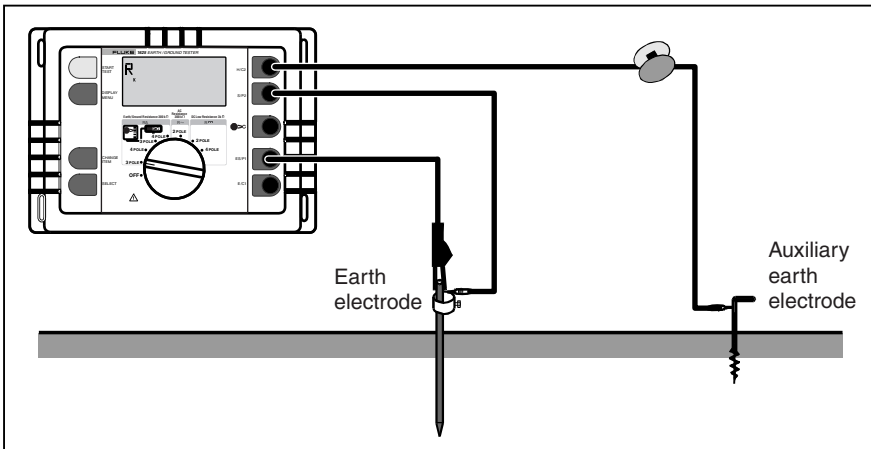

edw019.eps

**Figure 15. Compensation of Earth Electrode Connecting Lead**

1. Turn central rotary switch to position "R<sub>E</sub> 3pole".
2. Wire instrument according to picture.

3. Call display  $R_K$  with "DISPLAY MENU" button.
4. Implement compensation with "START TEST" button.

The compensation resistance is displayed only for as long as the "START TEST" button is kept pressed. After releasing the "START TEST" button the measured value is stored and the measuring instrument returns to the standard settings at the beginning of the measurement so that a succeeding measurement of the earthing resistance can be implemented by pressing "START TEST" again. Thereafter,  $R_K$  is subtracted from the actual measured value.

If the compensation value has to be reset to the basic setting ( $0.000 \Omega$ ), the compensation sequence has to be implemented with an open (disconnected) measuring lead or turn the switch to the next position and back.

### **Measurement of Soil Resistivity**

The soil resistivity is the geological and physical quantity for calculation and design of earthing systems. The measuring procedure applied below uses the method developed by Wenner (F. Wenner, A method of measuring earth resistivity; Bull. National Bureau of Standards, Bulletin 12 (4), Paper 258, S 478-496; 1915/16).

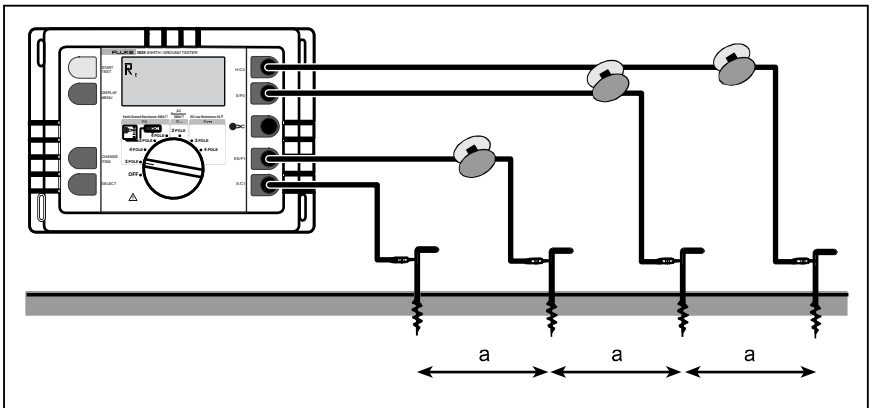

edw020.eps

**Figure 16. Measurement of Soil Resistivity**

1. Four earth spikes of the same length are positioned into the soil in an even line and with the same distance "a" to each other. The earth spikes should not be hammered in deeper than a maximum of 1/3 of "a".
2. Turn central rotary switch to position "R<sub>E</sub> 4pole".

The instrument is to be wired according to picture and notices given on the display.

A flashing of the sockets symbols  $\text{ⓔ}$   $\text{ⓔ}$   $\text{ⓔ}$   $\text{ⓔ}$  or  $\text{Ⓜ}$   $\text{Ⓜ}$ , points to an incorrect or incomplete connection of the measuring lead.

3. Push "START TEST" button.
4. Read out measured value R<sub>E</sub>.

From the indicated resistance value R<sub>E</sub>, the soil resistivity calculates according to the equation:

$$\rho_E = 2\pi \cdot a \cdot R_E$$

$\rho_E$  ..... mean value of soil resistivity ( $\Omega\text{m}$ )

R<sub>E</sub> ..... measured resistance ( $\Omega$ )

a ..... probe distance (m)

The measuring method according to Wenner determines the soil resistivity down to a depth of approx. the distance "a" between two earth spikes. By increasing "a", deeper strata can be measured and checked for homogeneity. By changing "a" several times, a profile can be measured from which a suitable earth electrode can be determined.

According to the depth to be measured, "a" is selected between 2 m and 30 m. This procedure results in curves depicted in the graph below.

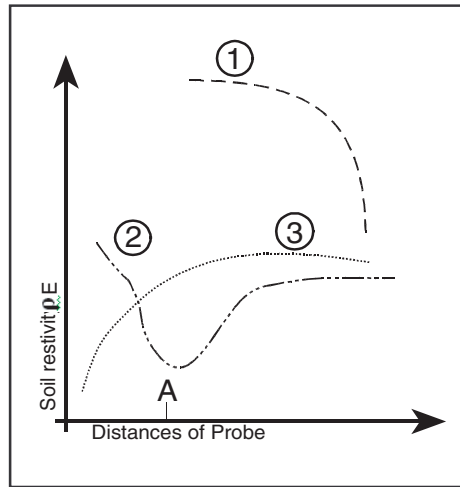

edw021.eps

Curve 1: As  $\rho E$  decreases only deeper down, a deep earth electrode is advisable

Curve 2: As  $\rho E$  decreases only down to point A, an increase in the depth deeper than A does not improve the values.

Curve 3: With increasing depth  $\rho E$  is not decreasing: a strip conductor electrode is advisable.

As measuring results are often distorted and corrupted by underground pieces of metal, underground aquifers etc, a second measurement, in which the spike axis is turned by an angle of  $90^\circ$ , is always advisable (see picture).

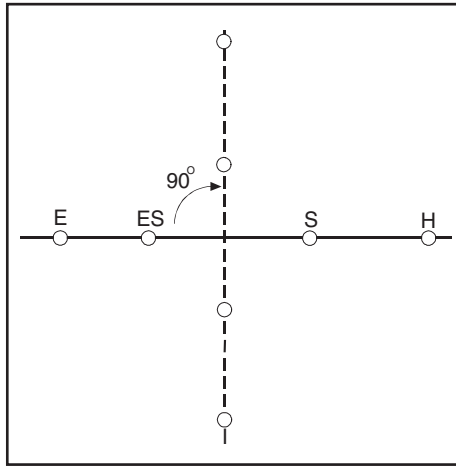

edw022.eps

## Measurement of Resistances

### Resistance Measurement (R~)

This measuring function determines the ohmic resistance between 0.001  $\Omega$  and 300 k $\Omega$ . The measurement is done with AC voltage. For measurements of very low resistances a compensation of the connecting leads is suggested (see “Compensation of Measuring Lead Resistance”).

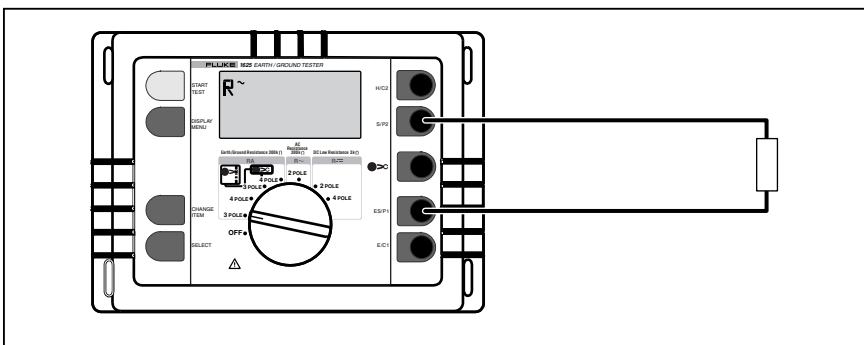

edw023.eps

Figure 17. Resistance Measurement (R~)

1. Turn central rotary switch to position "R~".



2. Connect instrument according to picture.
3. In this mode, all settings and LIMIT values available can be called with "DISPLAY MENU" and the measuring frequency can be set.
4. Press "START TEST" button.
5. Read out measured value.

### **Resistance Measurement (R<sub>∞</sub>)**

In this measuring mode all resistances from 0.001 Ω to 3 kΩ can be measured with DC voltage and automatic polarity reversal as per EN61557-5.

To achieve highest accuracy 4 pole measurements are possible. To balance the extension lead, a compensation has to be done.

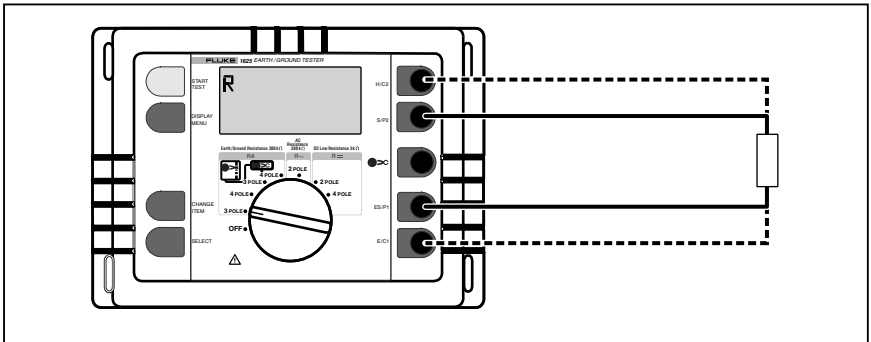

edw024.eps

**Figure 18. Resistance Measurement (R<sub>∞</sub>)**

1. Connect instrument according to picture.
2. Turn central rotary switch to position "R<sub>∞</sub>".
3. In this mode, all settings and LIMIT values available can be called with "DISPLAY MENU".

### **⚠ Warning**

**Before starting a measurement bring plant or test object to off or de-energized circuit condition! With an external voltage higher than 3 V measurement will not be started.**

## ⚠ Warning

**Due to the high measuring current inductive loads can cause lethal induced voltages during disconnection from the measuring circuit.**

4. Start measurement with "START TEST" button. First, "R<sub>1</sub>" with positive voltage is measured on jack "E". After releasing the "START TEST" button "R<sub>2</sub>" is measured with negative voltage on jack "E". The respectively higher measured value is displayed first.
5. The second measured value can be called with "DISPLAY MENU". If the set limit value (R LIMIT) is exceeded the limit can also be displayed.

### Evaluation of measured value:

Taking into account the maximum operating error, the diagrams show the maximum admissible display values to be displayed so not to exceed the required resistance.

Measuring Range 29, 99 ... 299, 9 ... 2999 Ω

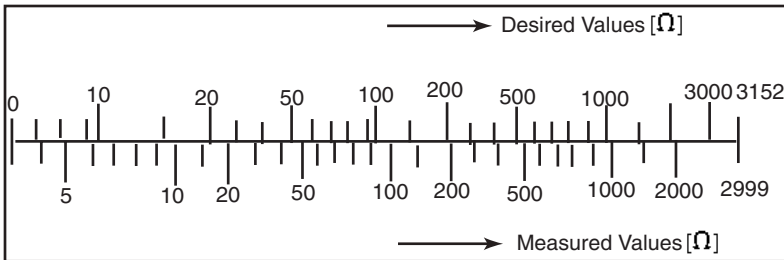

edw025.eps

**Figure 19. Evaluation of Measured Value**

### Compensation of Measuring Lead Resistance

1. Call display of  $R_K$  with button "DISPLAY MENU".
2. Short circuit measuring lead according to picture.
3. Press "START TEST" button. Value  $R_K$  is stored after the release of the "START TEST" button, the display jumps back to voltage measurement. Thereafter,  $R_K$  is subtracted from the actual measured value.

Turning the central rotary switch for a short moment deletes the line compensation again.

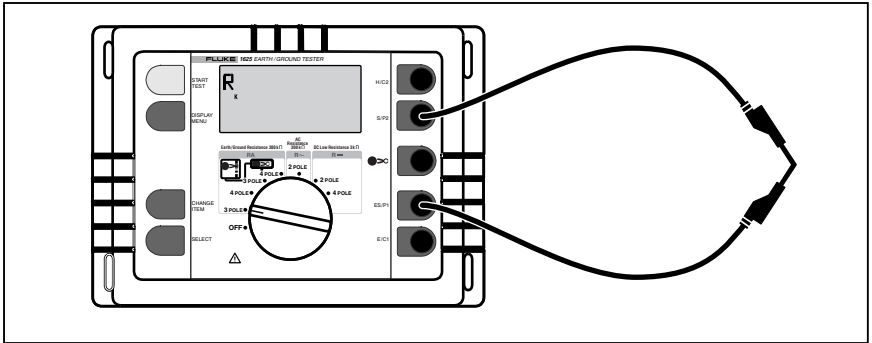



**Figure 20. Compensation of Measuring Lead Resistance**



edw026.eps

### ***Changing of All Data Settings with Personalized CODE***

With this function (FM, UM-Limit, Limit, beeper, ratio, R\*, F\*) limit- and set values can be programmed which keeps them memorized even if the instrument is switched ON/OFF. This feature enables the operator to create an instrument set-up with customer defined settings according to the specific need.

Settings can only be made in the respective functions:

Function	Parameter	Setting range	Standard presetting
<b>RE 3pole</b> and <b>RE 4pole</b>	FM	(AFC/94/105/111/128) Hz	AFC
	UM	48 V/20 V	48V
	RK	0.000 Ω ... 29.99 Ω	0.000 Ω
	LIMIT	On / Off	Off
	RE LIMIT	0.000 Ω ... 999 kΩ	999 kΩ
	♪(Warning sound)	On/Off	Off
	R*	On/Off	Off
<b>RE 3pole</b>  and <b>RE 4pole</b> 	FM	(AFC/94/105/111/128) Hz	AFC
	UM	48 V/20 V	48V
	RK	0.000 Ω ... 29.99 Ω	0.000 Ω
	I ( ratio )	80 ... 1200	1000
	LIMIT	On/Off	Off
	RE LIMIT	0.000 Ω ... 999 kΩ	999 kΩ
	♪(Warning sound)	On/Off	Off
R*	On/Off	Off	
<b>R~</b>	FM	(AFC/94/105/111/128) Hz	AFC
	RK	0.000 Ω ... 29.99 Ω	0.000 Ω
	LIMIT	On/Off	Off
	R ~ LIMIT	0.000 Ω ... 999 kΩ	999 kΩ
	♪(Warning sound)	On/Off	Off

<b>R</b>   <b>2pole</b>  <b>and</b>  <b>4pole</b>			
	R $\kappa$	0.000 $\Omega$ ... 29.99 $\Omega$	0.000 $\Omega$
	LIMIT	On/Off	Off
	R LIMIT	0.000 $\Omega$ ... 9,99 k $\Omega$	9.99 k $\Omega$
	 (Warning sound)	On/Off	Off

### Storing a Code

1. Press all 4 keys simultaneously and move central selector from OFF to the desired measuring mode.

The display shows "C \_ \_ \_".

2. Now enter the CODE-number. Any three-digit number can be entered.

#### *Note*

*Once a CODE has been entered, all subsequently programmed values can only be changed after entering the CODE number. Once a "CODE" has been entered, it cannot be erased or changed unless it is known. If an unknown "CODE" has been programmed, it can only be read or erased by its author or manufacturer. Therefore note down your personal "CODE" here.*

CODE . . .

3. Inputting the code is done by means of the "CHANGE ITEM" and "SELECT" keys.
4. Pressing the "DISPLAY MENU" key completes input.

The CODE is now stored, and the display shows "C ON".

5. If the display "C ON" is acknowledged by pressing "DISPLAY MENU", the first parameter of the selected measuring function is displayed and can be changed with the "CHANGE ITEM" and "SELECT" keys.

6. The changed value is stored by pressing the "DISPLAY MENU" key.
7. Pressing the "START TEST" key exits the setting program.

*Note*





*If the limit values required by regulations are changed incorrect, erroneous test results may be displayed.*

### **Deleting a Code**



1. Press all 4 keys simultaneously and move central selector from OFF to any measuring mode.  
The display shows " C \_ \_ \_ ".
2. Now enter the existing CODE-number.
3. Inputting the code is done by means of the "CHANGE ITEM" and "SELECT" keys. Pressing the "DISPLAY MENU" key completes input.
4. Display shows "C ON". In the "C ON" state the CODE function can be disabled by pressing the "CHANGE ITEM" key. The display then shows "C OFF".
5. If this display is acknowledged by pressing the "DISPLAY MENU" key, the user code and all changes of the limit values are erased. The original default values are restored into memory.
6. Now a new CODE-number may be programmed and used for setting new parameters.

## Description of Displays

**Table 3. Description of Displays**

Function	Displays	Condition	Note
Before "START"	 <p>edw027.eps</p>	Stand by position to reduce power consumption	Turn rotary switch or push button. All measured values remain stored
	 <p>edw028.eps</p>	No or incorrect measuring lead connection	Apart from voltage measurement all measuring functions are locked.
	 <p>edw029.eps</p>	Battery voltage too low	Replace batteries.
	 <p>edw030.eps</p>	Beeper on	Acoustical warning if limit is exceeded.

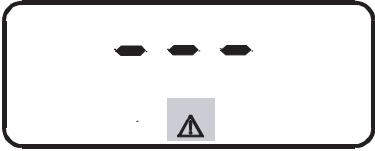
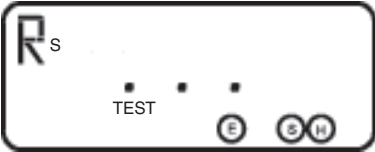

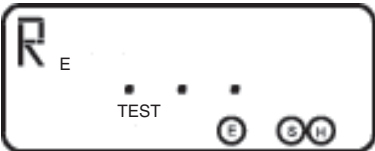
Legend:  = displayed flashing

Function	Displays	Condition	Note
	 <p>edw031.eps</p>	<p>Dangerous AC - voltage &gt; 50 V</p>	<p>Apart from voltage measurement all measuring functions are locked.</p>
<p>Before "START"</p>	 <p>edw033.eps</p>	<p>Rotary switch in intermediate position</p>	<p>Select correct position.</p>
<p>After "START"</p>	 <p>edw034.eps</p>	<p>Probe resistance is being tested</p>	<p>Wait for test result.</p>
	 <p>edw035.eps</p>	<p>Aux. current spike-resistance is being tested.</p>	<p>Wait for test result.</p>
	 <p>edw036.eps</p>	<p>Earth resistance is being tested.</p>	<p>Wait for test result.</p>





Legend:  = displayed flashing

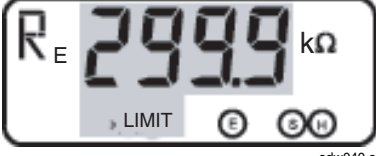



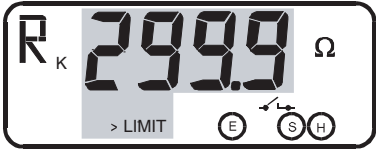

**Earth/Ground Tester**  
Description of Displays

Function	Displays	Condition	Note
	 <p style="text-align: right; font-size: small;">edw037.eps</p>	Measuring circuit of earth- and auxil. earth electrode disconnected.	Check lead connection on earth spikes measuring lead might be defective.
	 <p style="text-align: right; font-size: small;">edw038.eps</p>	Measuring circuit of earth- and probe electrode disconnected.	Check lead connection on earth spikes measuring lead might be defective.
	 <p style="text-align: right; font-size: small;">edw039.eps</p>	Max allowable error exceeded because of too high sense or aux earth spike resistance.	Try to moisten soil or connect 2nd aux earth spike in parallel.
After "START"	 <p style="text-align: right; font-size: small;">edw040.eps</p>	Measuring range exceeded.	Measured value is higher than 300 kΩ.

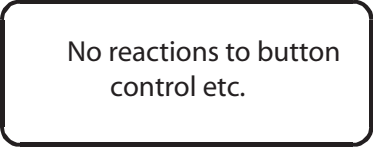

Legend: = displayed flashing

Function	Displays	Condition	Note
	 <p style="text-align: right; font-size: small;">edw041.eps</p>	Display of measured value exceeds LIMIT.	Measured value is higher than set LIMIT.
	 <p style="text-align: right; font-size: small;">edw042.eps</p>	Compensation higher than measured value.	Delete compensation or switch instrument ON/OFF.
	 <p style="text-align: right; font-size: small;">edw043.eps</p>	Wrong polarity on jacks E and ES.	Reverse polarity.
	 <p style="text-align: right; font-size: small;">edw044.eps</p>	Measured value unstable.	Unsteady noise voltage. Try time average measurement.
	 <p style="text-align: right; font-size: small;">edw045.eps</p>	Current in external transformer to low.	Reduce auxiliary current spike resistance.

Legend: = displayed flashing

Function	Displays	Condition	Note
	 <p style="text-align: right; font-size: small;">edw046.eps</p>	<p>Operation under faulty conditions.</p>	<p>Check batteries. Switch ON/OFF if still faulty, contact service.</p>
<p>After "START"</p>	 <p style="text-align: right; font-size: small;">edw047.eps</p>	<p>Reverse orientation of current clamp or "upwards" current.</p>	<p>Reverse clamp or see note on page 28.</p>
	 <p style="text-align: right; font-size: small;">edw048.eps</p>	<p>Checksum of EE PROM incorrect.</p>	
	 <p style="text-align: right; font-size: small;">edw049.eps</p>	<p>Hardware malfunction (e.g. current overload).</p>	<p>Switch ON/OFF if still faulty; The symbol may appear when using the stakeless measurement on low resistance circuits.</p>

Legend:  = displayed flashing

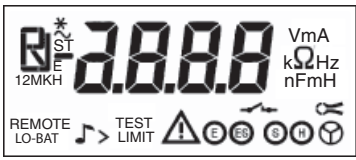
Function	Displays	Condition	Note
	 edw050.eps	EE PROM memory access malfunction.	contact service.
	 edw051.eps	Internal computation malfunction.	
	 edw052.eps	Thermal overload.	Cool thoroughly.
	 edw053.eps	Battery voltage decreases at measurement.	The internal resistance of the batteries is too high (worn out, low temperature). Replace batteries, warm up instrument.

Legend:  = displayed flashing

## Care and Maintenance

If used and treated properly, the instrument needs no maintenance. To clean the instrument, use only a moist cloth with some soap water or soft household

detergent or spirit. Avoid aggressive cleaning agents and solvents (trilene, chlorothene etc.).

Service work must only be undertaken by trained qualified staff.

In all repair work care must be taken that the design parameters of the instrument are not modified to the detriment of safety, that assembled parts correspond to the original spares and that they are reassembled properly (factory state).

### **Caution**

**Before any maintenance, repair or parts replacement the instrument must be disconnected from all voltage sources.**

## **Replacing Batteries**

### *Note*

*NiMH or NiCAD cells may be used but must be charged outside of the instrument. The number of measurements available with these cells will typically be different to those available using alkaline cells.*

This instrument is equipped with six 1.5 V batteries IEC RL 6 or type AA. If after pressing the START-button all display-segments are lit (instrument resets, display-test) or if "LO-BAT" appears on display during a measurement the batteries must be replaced or the accumulators must be recharged.

### **Caution**

**For replacement of batteries the measuring cable must be disconnected, and the instrument switched off. Now the two screws at the rear of the instrument can be loosened with a suitable tool (screwdriver) and the battery recess cover removed. When replacing batteries, mind the correct polarity.**

Always replace the complete set of batteries.

### *Note*

*For protection of the environment, please ensure proper disposal of the batteries.*

## **Recalibration**

This instrument exceeds the prescribed accuracies by multiples as it leaves the factory. To maintain it in this state, we recommend a check at 1-year intervals. Please contact the nearest sales or service center for this purpose.

As an extra service feature we offer you periodic checking and calibration of your meters. You may order, for a fee, either company test certificates or test certificates of the public calibration service at your option. These orders will be carried out either generally or with additional test records (measuring points) as ordered by you.

## **Service**

If you suspect that the tester has failed, review this manual to make sure you are operating it correctly. If the meter still fails to operate properly, pack I securely (in its original container if available) and forward it, postage paid, to the nearest Fluke Service Center. Include a brief description of the problem. Fluke assumes NO responsibility for damage in transit.

To locate an authorized service center, call Fluke using any of the phone numbers listed below:

USA: 1-888-99-FLUKE (1-888-993-5853)

Canada: 1-800-36-FLUKE (1-800-363-5853)

Europe: +31 402-678-2005

Japan: +81-3-3434-0181

Singapore: +65-738-5655

Anywhere in the world: +1-425-446-5500

Or, visit us on the World Wide Web: [www.fluke.com](http://www.fluke.com). To register your product, visit [register.fluke.com](http://register.fluke.com)

## **Storage**

If the instrument is stored or remains unused for some time, the batteries should be removed and stored separately to guard against damage by leaking electrolyte.

# **Appendix A**

## **Stakeless Earth/Ground Resistance Testing**

### **Introduction**

Stakeless testing provides the ground tester with the unique capability to measure individual ground resistances in multi-grounded systems using two clamp-on current transformers.

The use of ground stakes is not necessary.

Before this method was available, users were required to disconnect an individual ground path to be tested from other grounds to eliminate the influence of parallel ground paths.

This was time consuming at the minimum and in many cases dangerous.

Once disconnected, the standard 3-pole/terminal ground testing method was used which requires auxiliary earth stakes. In addition to consuming additional time, finding suitable locations for the ground stakes can be difficult and in some cases, impossible. The "stakeless" method of ground resistance testing eliminates these problems and ideally complements the ground testers' standard testing methods.

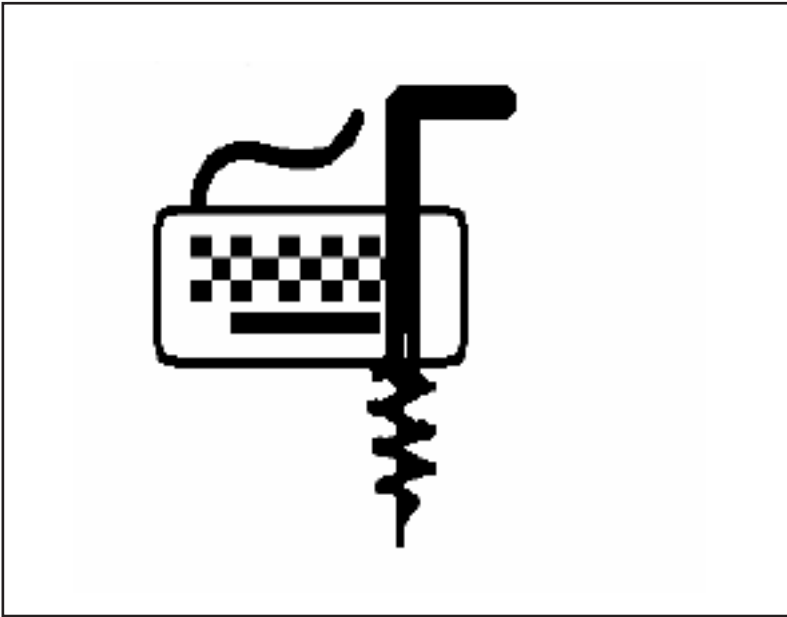

edw060.eps

## Specifications

General: Adapter unit for use with ground testers in the mode:  $R_E$   $\text{III}$   
3 pole (Order No. EI-1625)

All information contained in this section exclusively refers to this application.

Principle:	Ground testing without using earth stakes for the probe and the auxiliary earth electrode.
Working temperature range	-10 °C ... +55 °C.
Operating temperature range	0 °C ... +30 °C.
Storage temperature range	-30 °C ... +70 °C.
Quality standard:	Developed, designed and manufactured to comply with DIN ISO 9001.



## **Stakeless Earth/Ground Resistance Testing**

### *Principle of Operation*

---

Dimensions	Total length of adaptercable 1,8 m, Length of shielded cable to clamp-on CT 1,5 m.
Operating error*:	$\pm$ (10% of m.v. + 5 digit).
Display range*:	0,010 $\Omega$ ... 130 $\Omega$ .
Measuring frequency:	128 Hz.
Measuring voltage:	$U_m=48$ VAC (primary).
Measuring range*:	0,020 $\Omega$ ... 100 $\Omega$ .
Resolution:	.001... .1 ohm.
*when using:	CT EI-162AC to induce voltage and CT EI-162X to detect current.  Recommended distance between CT's: 10 cm.

## ***Principle of Operation***

### ***Purpose***

Testing the resistances of individual ground connections in systems with parallel ground connections (multi-grounded systems).

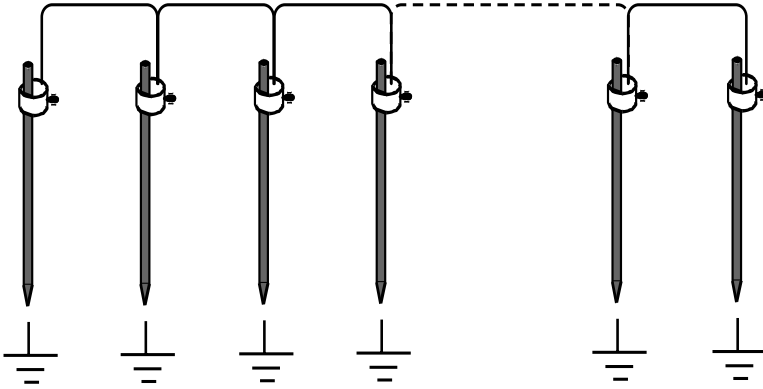

Equivalent diagram

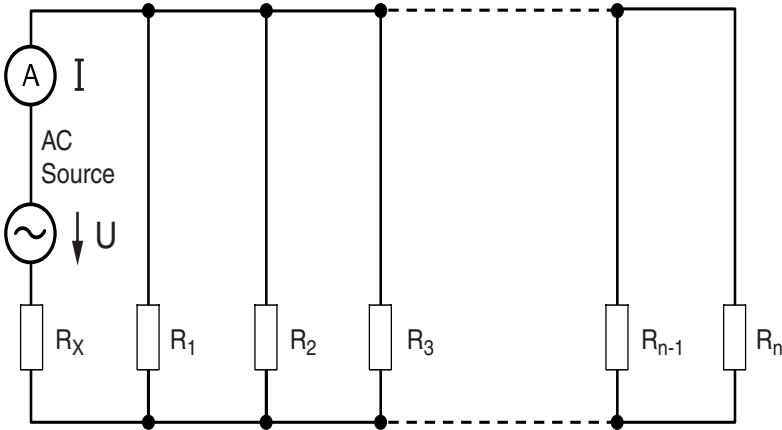

edw061.eps

$$\frac{U}{I} = R_x + \frac{1}{\frac{1}{R_1} + \frac{1}{R_2} + \dots + \frac{1}{R_n}}$$

## Stakeless Earth/Ground Resistance Testing Principle of Operation

If the parallel connection of resistors,  $R_1 \dots R_n$  is considerably lower than the ground connection under test  $R_X$ :

$$\frac{1}{\frac{1}{R_1} + \frac{1}{R_2} + \dots + \frac{1}{R_n}} \ll R_X$$

then  $R_X = \frac{U}{I}$  is a reasonable approximation.

The test voltage ( $U$ ) is applied without disconnecting ground rod and/or the direct electrical connection by means of a clamp-on current transformer and the current detected by a second current transformer.

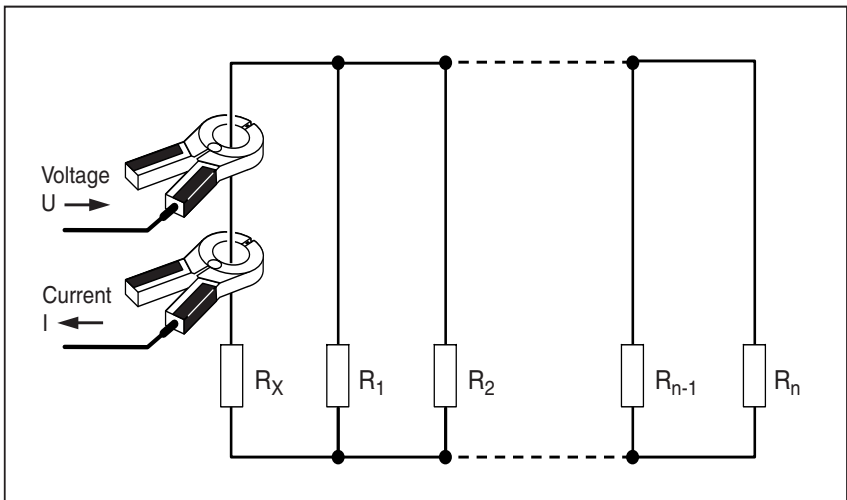

edw062.eps

After synchronous rectification of current and voltage the tester displays  $R_X$ .

## Operation

Connect the adapter according to the diagram and the designations E, S and H (C1, P1 and P2 for US-version) to the tester and to a current clamp.

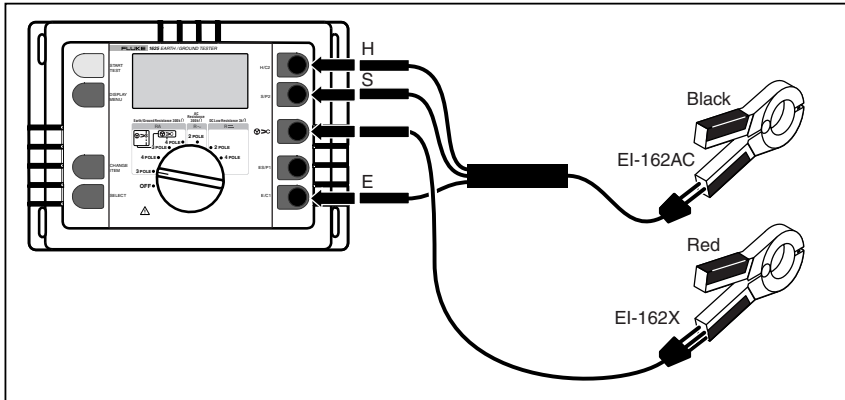

edw063.eps

Use the test cable contained in the set to connect the second current clamp to the socket. Ensure that connections are in the correct polarity. Turn the rotary switch of the tester to position **R<sub>E</sub>** 3 pole.

### Note

*Use only current transformers referred to in this manual.*

Clamp both transformers around the ground conductor to be tested.

### Note

*Try to have a distance > 10 cm between the clamps for optimal results.*

## Stakeless Earth/Ground Resistance Testing

### Principle of Operation

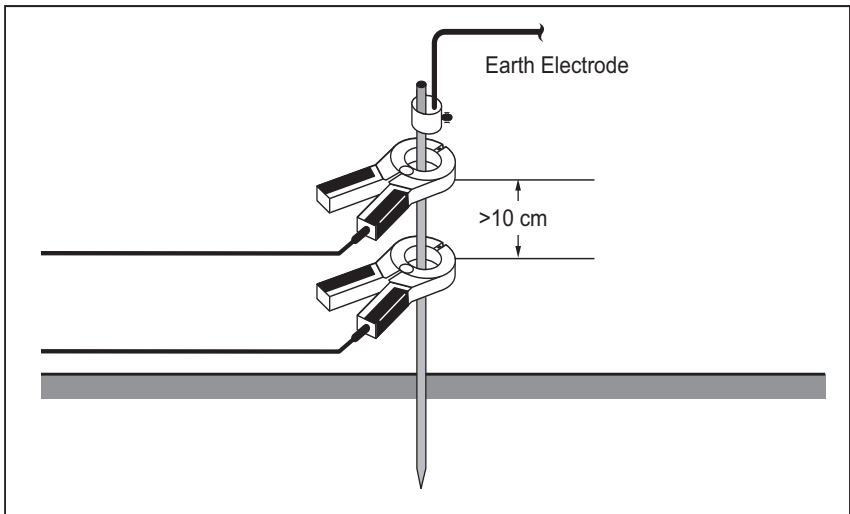

edw064.eps

Pushing the START-button will display the value of  $R_E$ .

#### *Note*

*In this particular mode the values of  $R_H$  and  $R_S$  have no meaning.*

### **Settings on the Tester**

Refer to the *Operation* section in the Testers instruction manual.

The rotary switch of the tester must be in the  $R_E$  3 pole position.

- $U_m$  Set Test Voltage to 48 V (standard value)
- $R_k$  Set compensation resistance to 0,000 Ohms
- I Set transformer ratio to 1000 (standard value)
- $R^*$  Set to OFF (no meaning in this mode).

## Applications

Example1 : Ground rod on power poles.

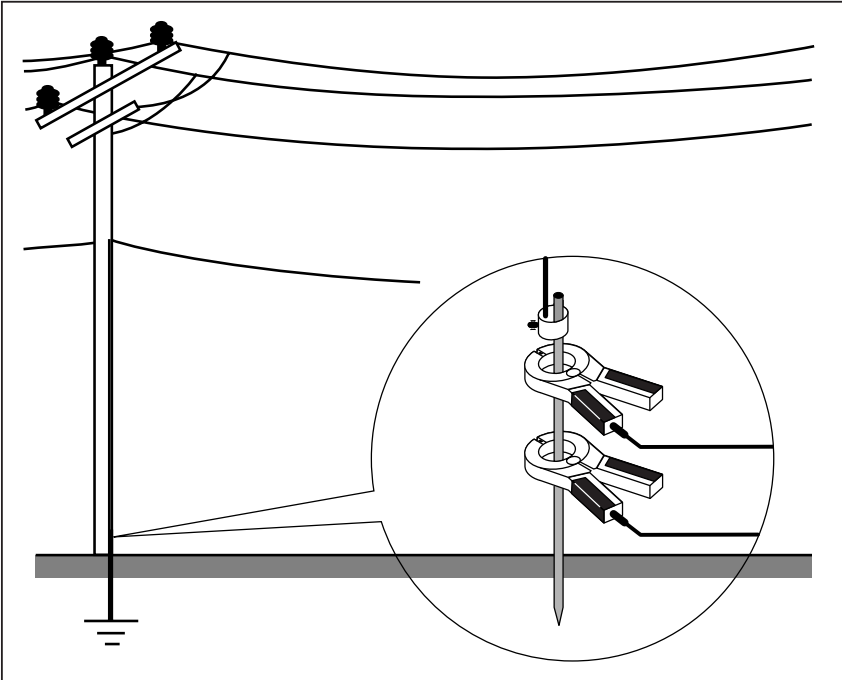

edw065.eps

Example 2: Tests on multi-grounded (inter-connected) systems:

Ground conductors are for example bonded to grids or concrete-footing grounds and other conducting elements such as lightning protection systems or frameworks.

In this case the resistances of individual ground paths are not of significance.

It must be tested if the resistance of the bonding is sufficiently low and reliable.

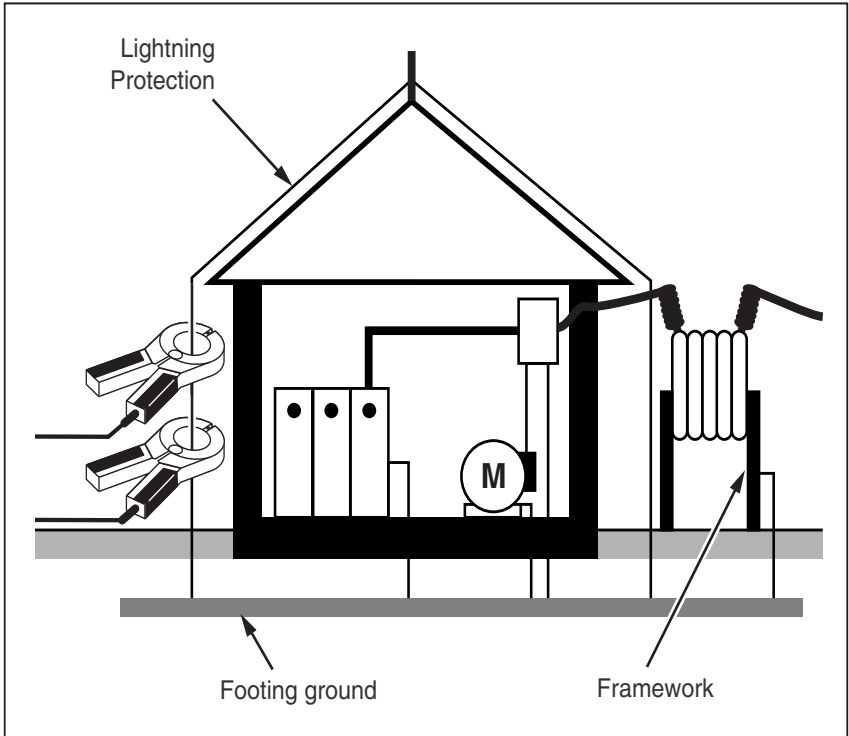

**Stakeless Earth/Ground Resistance Testing**  
*Principle of Operation*



edw066.eps

### Description of Displays

With stakeless ground testing some display combinations have certain significance.

Display	Significance	Note
 <p>edw067.eps</p>	<p>Polarity of CT's is reversed</p>	<p>Turn one CT</p>
 <p>edw068.eps</p>	<p>Resistance under test is below measuring range or adapter cable is plugged into ground tester incorrectly</p>	<p>Switch on/off for next test</p>

Legend:  = displayed flashing



**Stakeless Earth/Ground Resistance Testing**  
*Principle of Operation*

Display	Significance	Note
 <p>The image shows a digital display with 'U ST' on the left and '0.0 V' in the center. A small triangle symbol is positioned below the '0.0' digits. Below the display is a small graphic of a test probe. The text 'edw069.eps' is located at the bottom left of the display area.</p>	Resistance under test is above measuring range	

Legend:  $\triangle$  = displayed flashing

# **Appendix B**

## **Earthing Resistance**

### **Introduction**

Per definition, the earthing resistance consists of several individual resistances.

1. The resistance of connecting lead to earth electrode
2. The resistance of the actual earth electrode; earthing rod, earthing plate, earthing strip, mesh earth electrode etc.
3. The dissipation resistance, the resistance between earth electrode and soil potential.

As the connecting cable and the resistance of the earth electrode are negligibly small after correct dimensioning, the earthing resistance dominantly depends on the dissipation resistance. This shows that an accurate measurement of the dissipation resistance is necessary to determine the exact earthing conditions for protective measures. As the dissipation resistance is not only dependent on the specific soil resistivity, that is the resistance of the actual soil ( gravel, clay, granite ), but also significantly depends on the shape of the earth electrode, a metrological check has to be made even if the position of the earth electrode and the condition of the soil is well known.

For redimensioning of an earthing system, e.g. a lightning protection, an approximate calculation, according to the table below, is possible. As a basis for this calculation the soil resistivity of the spot where the earth electrode is to be installed has to be known.

**Earthing Resistance**  
*Principle of Operation*

Type of Soil	Soil Resistivity [ $\rho_e$ ]	Earthing Resistance ( $\Omega$ )					
		Earthing Rod m Depth			Earthing Strip m		
	$\Omega.m$	3	6	10	5	10	20
Moist humus soil, moor soil, swamp	30	10	5	3	12	6	3
Farming soil, loam y and clay soils	100	33	17	10	40	20	10
Sandy clay soils	150	50	25	15	60	30	15
Moist sandy soil	300	66	33	20	80	40	20
Dry sandy soil	1000	330	165	100	400	200	100
Concrete 1 : 5 <sup>+</sup>	400				160	80	40
Moist gravel	500	160	80	48	200	100	50
Dry gravel	1000	330	165	100	400	200	100
Stoney soil	30000	1000	500	300	1200	600	300
Rock	$10^7$	-	-	-	-	-	-

\* for concrete mixtures 1 : 7 the values have to be increased by 24 %

## Soil Resistivity $\rho_E$

The soil resistivity is the resistance measured between two opposing surfaces of a cube of homogenous soil material with a lateral length of 1 meter. The unit is  $\Omega\text{m}$  (see picture)

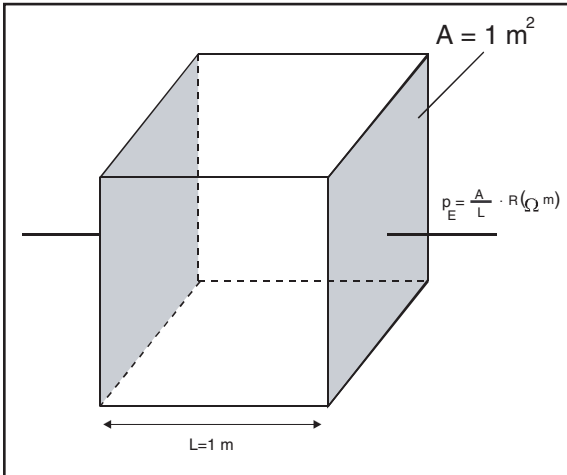

edw054.eps

The soil resistivity significantly depends on the specific kind of material (farming soil, dry sand, moist sand, concrete, gravel etc.), but also depends on seasonal changes. Dry soil has a higher resistivity than moist soil and frozen ground has a higher resistivity than dry, warm sand (see picture).

The two examples below show the change of resistivity during the course of one year.

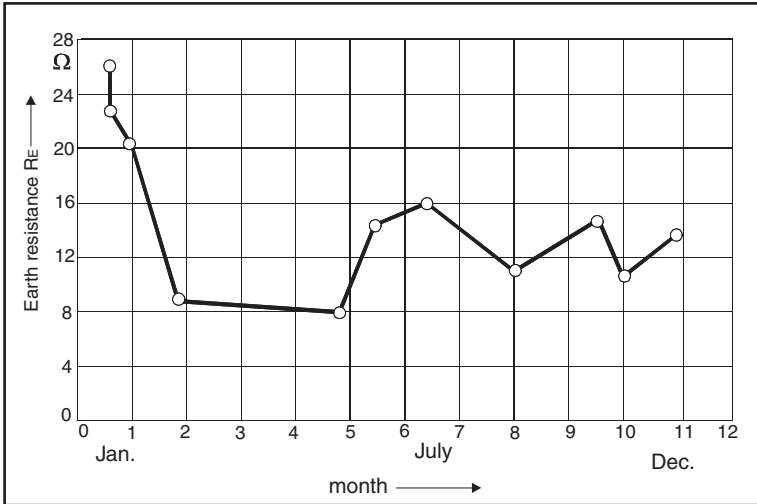

edw055.eps

Temporal change of the earthing resistance of a conductor earth electrode (earth strip, earth cable).

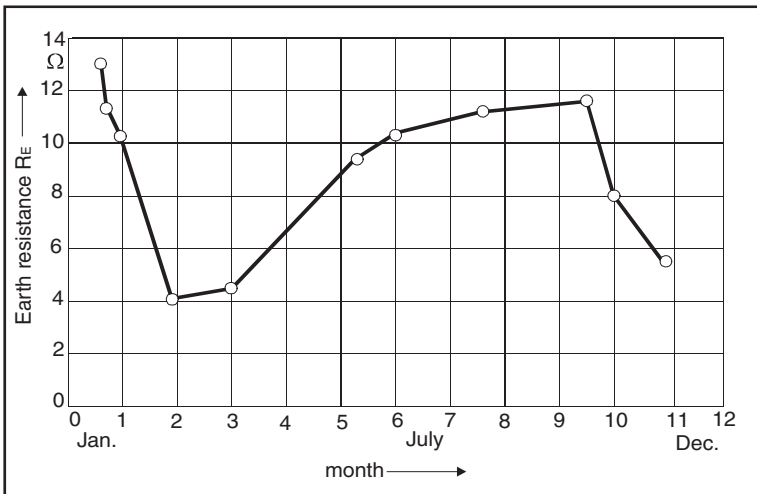

edw056.eps

Temporal change of the earthing resistance of a buried earth electrode (earth pipe, earth plate)

## Measuring Method

The current voltage measuring method is based on the block diagram circuit shown in the figure below.

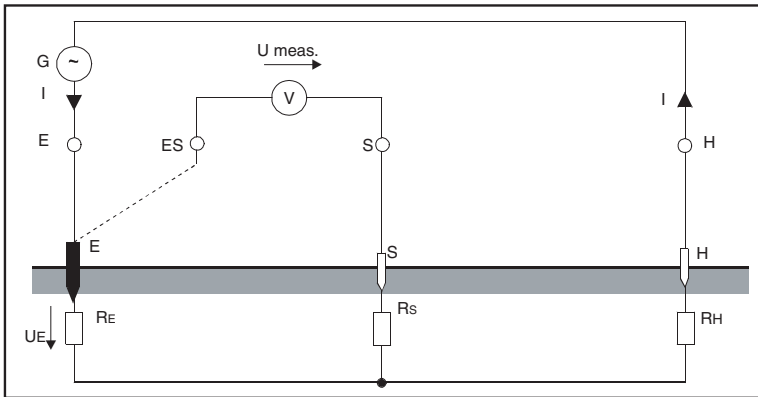

edw057.eps

An AC generator  $G$  feeds current  $I$  via earth electrode  $E$  (earth electrode resistance  $R_E$ ) and auxiliary earth electrode  $H$  (auxiliary earth electrode resistance  $R_H$ ).

Voltage  $U_E$  drops on earthing resistance  $R_E$  ( $U_E$  proportional to  $R_E$ .) This voltage is picked up and measured by probe  $S$ . With the so called three wire circuit, the instrument sockets  $E$  and  $ES$  are connected to each other. In a four wire circuit an separate cable is used to connect socket  $ES$  with the earth electrode.

With that, the voltage drop of the cable between socket  $E$  and earth electrode is not measured. As the voltage measuring circuit has such a high impedance, the influence by the probe resistance  $R_S$  is neglectable within certain limits.

Thus the earthing resistance evolves

$$R_E = \frac{U_{\text{Meas}}}{1}$$

and is independent from the resistance of the auxiliary earth electrode  $R_H$ . The generator runs at a frequency between 70 and 140 Hz.

It has to hold a minimum distance of 5 Hz to one of the nominal frequencies between 16 2/3, 50 or 60 Hz and their harmonic waves. A frequency selective filter adjusted to the generator frequency is inserted.

## The Potential Gradient Area

Around every earth electrode a so called potential gradient area develops during the flow of an electric current (see picture below).

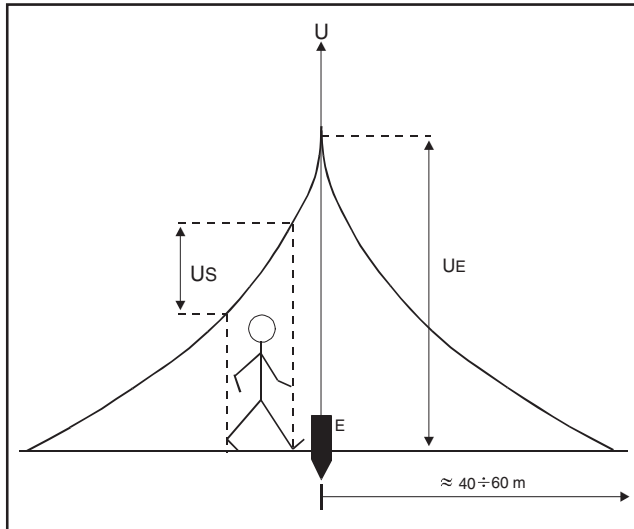

edw058.eps

If the voltage between the earth electrode and a probe with a distance "a" from the earth electrode is measured, the value increases less with increasing distance. Once the voltage does not increase, the probe is levelled to earth potential  $F_E$  that is, outside the potential gradient area.

It is the soil resistivity that mainly affects the diameter of the potential gradient area. This means the diameters in soils with a bad conductivity are correspondingly wide (30 ... 60 m), soils with a good conductivity correspondingly narrow (10 ... 15 m).

Determining the probe- and auxiliary earth electrode resistance provides information about the size of a possible potential gradient area. High resistances lead to correspondingly large gradient areas and vice versa. In this context it has to be taken into account that soils with a good conductivity and correspondingly small potential gradient areas result in a relatively steep voltage shape and therefore in a relatively high step voltage. If necessary, such systems have to undergo a potential check.

## The Influence of Potential Gradient Areas on Earth Resistance Measurement

To pick off the true voltage drop from the earthing resistance (= the resistance between the earth electrode and the soil potential  $F_E$ ) it is to be assured that the probe is set outside the potential gradient area of all connected earth electrodes and the auxiliary earth electrode H.

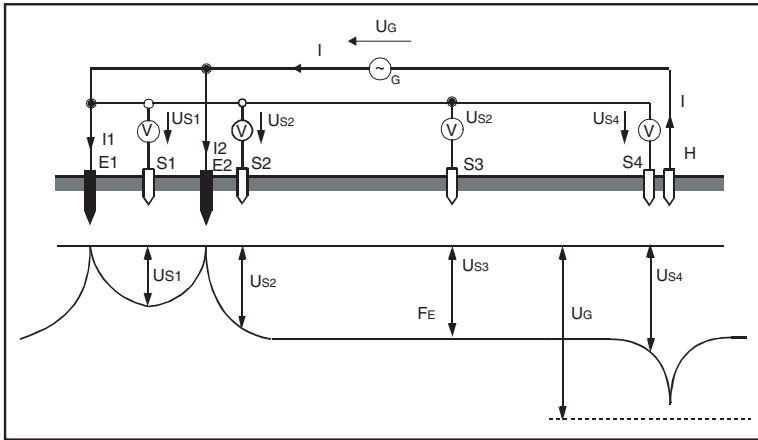

edw059.eps

A probe positioned inside a potential gradient area leads to incorrect measuring results. As it can be seen in the picture above, probe voltages  $U_{S1}$  and  $U_{S2}$  of probes  $S_1$  and  $S_2$  deliver a value too low, which also means that the earthing resistance appears to be lower than it actually is (low resistance). Probe  $S_4$  with  $U_{S4}$  on the other hand, picks up a value too high which indicates a worse (high resistance) earthing conditions.

Only probe  $S_3$  picks up the correct voltage between earth electrode and soil potential  $F_E$ .

For that reason it is advisable to repeat each measurement with repositioned probes and only to regard a measurement as successful and accurate if several subsequent measurements result in the same values.

Normally, a distance of 20 m to the earth electrode and to the probes to each other is sufficient.



### **Earth Impedance ( $R^*$ ) on High Voltage Transmission Lines**

The earthings of transmission line pylons are interconnected via the overhead earth wire.

This wire is not only ohmic. There is also inductivity and resistivity ( $L'$ ,  $R'$ ). For calculation of the short circuit current this impedance at line frequency has to be determined.

Inductivity and resistivity are known in most cases. Therefore the actual impedance can be calculated for each point of the line by a complex computation considering individual pylon resistance. This (computation) has to be done for each single pylon.

The earth impedance can be measured with this instrument.

The inductive portion of the impedance of the overhead wire is frequency dependent.

Accordingly, the measuring frequency applied by the tester has to be close to the mains frequency in order to get correct readings.

For that reason ordinary testers using frequencies between 70 Hz and 140 Hz show incorrect readings. This instrument measures with 55 Hz to be near enough to 50 / 60 Hz line frequency but to avoid interference with them

