



# **Sorensen**

---

## ***DCS-E SERIES POWER SUPPLIES***

### **Instruction Manual**

**This manual covers models:**

<b>8-125E</b>	<b>60-18E</b>
<b>20-50E</b>	<b>80-13E</b>
<b>33-33E</b>	<b>150-7E</b>
<b>40-25E</b>	<b>300-3.5E</b>
<b>50-20E</b>	<b>600-1.7E</b>

#### **SORENSEN**

**Elgar Electronics Corporation**  
**9250 Brown Deer Road**  
**San Diego, CA 92121-2294**  
**1-800-733-5427**  
**Tel: (858) 450-0085**  
**Fax: (858) 458-0267**  
**Email: sales@elgar.com**  
**www.elgar.com**

©1998 by Sorensen, Division of Elgar Electronics Corporation

This document contains information proprietary to Sorensen, Elgar Electronics Corporation. The information contained herein is not to be duplicated or transferred in any manner without prior written permission from Sorensen.



## **SORENSEN FIVE-YEAR WARRANTY**

---

Sorensen, a division of Elgar Electronics Corporation, warrants its products to be free from defects in material and workmanship. This warranty is effective for five years from the date of shipment of the product to the original purchaser. Liability of Sorensen under this warranty shall exist provided that:

- the Buyer exposes the product to normal use and service and provides normal maintenance on the product;
- Sorensen is promptly notified of defects by the Buyer and that notification occurs within the warranty period;
- the Buyer receives a Return Material Authorization (RMA) number from Sorensen's Repair Department prior to the return of the product to Sorensen for repair, phone 800-458-4258;
- the Buyer returns the defective product in the original, or equivalent, shipping container;
- if, upon examination of such product by Sorensen it is disclosed that, in fact, a defect in materials and/or workmanship does exist, that the defect in the product was not caused by improper conditions, misuse, or negligence; and,
- that Sorensen QA seal and nameplates have not been altered or removed and the equipment has not been repaired or modified by anyone other than Sorensen authorized personnel.

This warranty is exclusive and in lieu of all other warranties, expressed or implied, including, but not limited to, implied warranties of merchantability and fitness of the product to a particular purpose. Sorensen, its agents, or representatives shall in no circumstance be liable for any direct, indirect, special, penal, or consequential loss or damage of any nature resulting from the malfunction of the product. Remedies under this warranty are expressly limited to repair or replacement of the product.

### **CONDITIONS OF WARRANTY**

- To return a defective product, contact an Sorensen representative or the Sorensen factory for an RMA number. Unauthorized returns will not be accepted and will be returned at the shipper's expense.
- For Sorensen products found to be defective within thirty days of receipt by the original purchaser, Sorensen will absorb all ground freight charges for the repair. Products found defective within the warranty period, but beyond the initial thirty-day period, should be returned prepaid to Sorensen for repair. Sorensen will repair the unit and return it by ground freight pre-paid.
- Normal warranty service is performed at Sorensen during the weekday hours of 7:30 am to 4:30 pm Pacific time. Warranty repair work requested to be accomplished outside of normal working hours will be subject to Sorensen non-warranty service rates.
- Warranty field service is available on an emergency basis. Travel expenses (travel time, per diem expense, and related air fare) are the responsibility of the Buyer. A Buyer purchase order is required by Sorensen prior to scheduling.
- A returned product found, upon inspection by Sorensen, to be in specification is subject to an inspection fee and applicable freight charges.
- Equipment purchased in the United States carries only a United States warranty for which repair must be accomplished at the Sorensen factory.

**Sorensen**

*Committed to Quality...Striving for Excellence*

This Page Intentionally Left Blank

## SAFETY NOTICE

---

Before applying power to the system, verify that the DCS Series unit is configured properly for the user's particular application.



**WARNING!**

**HAZARDOUS VOLTAGES IN EXCESS OF 280 VRMS, 600V PEAK MAY BE PRESENT WHEN COVERS ARE REMOVED. QUALIFIED PERSONNEL MUST USE EXTREME CAUTION WHEN SERVICING THIS EQUIPMENT. CIRCUIT BOARDS, TEST POINTS, AND OUTPUT VOLTAGES MAY BE FLOATING ABOVE (BELOW) CHASSIS GROUND.**

Installation and service must be performed by qualified personnel who are aware of dealing with attendant hazards. This includes such simple tasks as fuse verification.

**Ensure that the AC power line ground is connected properly to the DCS Series unit input connector or chassis. Similarly, other power ground lines including those to application and maintenance equipment must be grounded properly for both personnel and equipment safety.**

Always ensure that facility AC input power is de-energized prior to connecting or disconnecting the input/output power cables.



During normal operation, the operator does not have access to hazardous voltages within the chassis. However, depending on the user's application configuration, HIGH VOLTAGES HAZARDOUS TO HUMAN SAFETY may be generated normally on the output terminals.

Ensure that the output power lines are labeled properly as to the safety hazards and that any inadvertent contact with hazardous voltages is eliminated. To guard against risk of electrical shock during open cover checks, do not touch any portion of the electrical circuits. Even when the power is off, capacitors can retain an electrical charge. Use safety glasses during open cover checks to avoid personal injury by any sudden failure of a component.

Due to filtering, the unit has high leakage current to the chassis. Therefore, it is essential to operate this unit with a safety ground.

**Some circuits are live even with the front panel switch turned off. Service, fuse verification, and connection of wiring to the chassis must be accomplished at least five minutes after power has been removed via external means; all circuits and/or terminals to be touched must be safety grounded to the chassis.**

After the unit has been operating for some time, the metal near the rear of the unit may be hot enough to cause injury. Let the unit cool before handling.

Qualified service personnel need to be aware that some heat sinks are not at ground, but at high potential.

These operating instructions form an integral part of the equipment and must be available to the operating personnel at all times. All the safety instructions and advice notes are to be followed.

Neither Sorensen, San Diego, California, USA, nor any of the subsidiary sales organizations can accept any responsibility for personal, material or consequential injury, loss or damage that results from improper use of the equipment and accessories.

## SAFETY SYMBOLS



CAUTION  
Risk of Electrical Shock



CAUTION  
Refer to Accompanying Documents



Off (Supply)



Standby (Supply)



On (Supply)



Protective Conductor Terminal



Direct Current (DC)



Alternating Current (AC)



Three-Phase Alternating Current



Fuse



Earth (Ground) Terminal

## ABOUT THIS MANUAL

This manual has been written expressly for the Sorensen DCS 1KW series of power supplies which have been designed and certified to meet the 1997 Low Voltage and Electromagnetic Compatibility Directive Requirements of the European Community. Units that comply with the directive are designated by an 'E' after the model designator (e.g., DCS 40-25E would indicate that the model is certified) when configured for 230 VAC input only.

Since the goal of the Low Voltage Directive is to ensure the safety of the equipment operator, universal graphic symbols (see below) have been used both on the unit itself and in this manual to warn the operator of potentially hazardous situations.

# TABLE OF CONTENTS

<b>SECTION 1. FEATURES AND SPECIFICATIONS.....</b>	<b>1-1</b>
1.1 DESCRIPTION .....	1-1
1.2 OPERATING MODES .....	1-1
1.3 POWER SUPPLY FEATURES .....	1-1
1.4 SPECIFICATIONS .....	1-2
1.4.1 Electrical Specifications.....	1-2
1.4.2 Mechanical Specifications.....	1-3
<b>SECTION 2. INSTALLATION AND OPERATING INSTRUCTIONS.....</b>	<b>2-1</b>
2.1 GENERAL.....	2-1
2.2 INITIAL INSPECTION .....	2-1
2.3 INSTALLATION .....	2-1
2.3.1 Input Voltage Selection .....	2-1
2.3.2 Input Line Impedance.....	2-2
2.3.3 Ventilation Requirements .....	2-2
2.3.4 Output Voltage Biasing .....	2-2
2.3.5 Rack Mounting.....	2-2
2.4 INITIAL FUNCTIONAL TESTS.....	2-4
2.5 CONTROLS, CONNECTORS, AND INDICATORS.....	2-5
2.5.1 Front Panel.....	2-5
2.5.2 Rear Panel .....	2-5
2.6 STANDARD OPERATION .....	2-7
2.6.1 Load Conductor Ratings.....	2-7
2.6.2 Load Connection and Grounding.....	2-7
2.6.3 Inductive Loads.....	2-7
2.6.4 Remote Sensing .....	2-8
2.6.5 Negative Output Operation .....	2-8
2.7 SINGLE SUPPLY OPERATION (LOCAL MODE).....	2-9
2.8 MULTIPLE SUPPLIES .....	2-9
2.8.1 Series Operation .....	2-10
2.8.2 Parallel Operation .....	2-10
2.8.3 Split Supply Operation .....	2-10
2.9 OVER VOLTAGE PROTECTION (OVP) .....	2-10
2.9.1 Front Panel OVP Operation.....	2-11
2.9.2 Remote Programming of OVP With External Voltage Sources.....	2-11
2.9.3 Remote Programming of OVP with an External Resistance .....	2-13
2.9.4 Remote Programming of OVP with External Current Sources.....	2-14
2.9.5 Remote OVP Sensing.....	2-15
2.10 REMOTE ON/OFF .....	2-15
2.10.1 Remote ON/OFF by Contact Closure.....	2-15
2.11 REMOTE PROGRAMMING OF OUTPUT VOLTAGE AND CURRENT LIMIT .....	2-16
2.11.1 Programming With External Voltage Sources.....	2-16
2.11.2 Programming With an External Resistance.....	2-18
2.11.3 Programming With an External Current Source .....	2-20
2.12 REMOTE MONITORING AND STATUS INDICATORS.....	2-21

## TABLE OF CONTENTS (Continued)

<b>SECTION 3. THEORY OF OPERATION.....</b>	<b>3-1</b>
3.1 POWER CIRCUIT (A2 ASSEMBLY) .....	3-1
3.1.1 <i>Basic Off-Line Switching Regulator Theory</i> .....	3-1
3.1.2 <i>Simplified Full Bridge Converter Theory</i> .....	3-1
3.1.3 <i>Detailed Circuit Description</i> .....	3-3
3.2 METER CIRCUIT (A1 ASSEMBLY) .....	3-8
3.2.1 <i>Voltmeter</i> .....	3-8
3.2.2 <i>Current Meter</i> .....	3-8
<b>SECTION 4. MAINTENANCE, TROUBLESHOOTING, AND CALIBRATION .....</b>	<b>4-1</b>
4.1 GENERAL .....	4-1
4.2 PERIODIC SERVICE .....	4-1
4.3 TROUBLESHOOTING .....	4-1
4.3.1 <i>Preliminary Checks</i> .....	4-1
4.3.2 <i>Internal Troubleshooting</i> .....	4-2
4.4 CALIBRATION .....	4-2
<b>SECTION 5. PARTS LISTS .....</b>	<b>5-1</b>
5.1 GENERAL .....	5-1
5.2 PARTS ORDERING .....	5-1
5.3 PARTS LISTS.....	5-1
<b>SECTION 6. DRAWINGS AND SCHEMATICS.....</b>	<b>6-1</b>
6.1 GENERAL .....	6-1
6.2 DRAWINGS AND SCHEMATICS.....	6-1



## **SECTION 1. FEATURES AND SPECIFICATIONS**

### **1.1 Description**

DCS Series power supplies are 1000W supplies designed to provide highly stable, continuously variable output voltage and current for a broad range of development, system and burn-in applications. The series consists of ten models designated by the DCS prefix, followed by the output voltage and current ratings. For example, the model number DCS 60-18E indicates that the unit is rated at 0-60 Vdc and 0-18 Amps while a model DCS 20-50E is rated at 0-20 Vdc and 0-50 Amps. The DCS Series employs high frequency switching regulator technology to achieve high power density and small package size.

### **1.2 Operating Modes**

The DCS Series supply has two basic operating modes: Constant Voltage and Constant Current. In constant voltage mode the output voltage is regulated at the selected value while the output current varies with the load requirements. In constant current mode the output current is regulated at the selected value while output the voltage varies with the load requirements.

An **automatic crossover** system enables the unit to switch operating modes in response to varying load requirements. If, for example, the unit is operating in voltage mode and the load current attempts to increase above the setting of the current control, the unit will switch automatically from voltage mode to current mode. If the load current is subsequently reduced below the setting of the current control the unit will return to voltage mode automatically.

### **1.3 Power Supply Features**

- Ten models with voltage ranges from 0-8 Vdc to 0-600 Vdc and current outputs from 1.7A to 125A.
- 115/230 Vac selectable input voltage, 50-60 Hz single phase, Installation Category II. For Indoor Use.
- Simultaneous digital display of both voltage and current.
- Ten turn potentiometer voltage and current controls permit high resolution setting of the output voltage and current from zero to the rated output.
- Automatic mode crossover into current or voltage mode.
- Flexible output configuration: multiple units can be connected in parallel or series to provide increased current or voltage.
- High frequency switching technology allows high power density, providing increased power output in a small, light package.
- Remote sensing to compensate for losses in power leads.
- Adjustable Over-Voltage Protection (OVP)
- External TTL, AC or DC shutdown
- Remote voltage, resistive, current limit and OVP programming with selectable programming constants.

- External indicator signals for remote monitoring of OVP status, local/remote programming status, thermal shutdown, and output voltage and current.
- Optional IEEE-488 interface for complete remote programming and readback capability.

## 1.4 Specifications

### 1.4.1 Electrical Specifications<sup>1</sup>

MODELS	8-125	20-50	33-33	40-25	50-20	60-18	80-13	150-7	300-3.5	600-1.7
Output Ratings:										
Output Voltage	0-8V	0-20V	0-33V	0-40V	0-50V	0-60V	0-80V	0-150V	0-300V	0-600V
Output Current	0-125A	0-50A	0-33A	0-25A	0-20A	0-18A	0-13A	0-7A	0-3.5A	0-1.7A
Output Power	1000W	1000W	1089W	1000W	1000W	1080W	1040W	1050W	1050W	1020W
Line Regulation <sup>2</sup> :										
Voltage	8 mV	20 mV	33 mV	40 mV	50 mV	60 mV	80 mV	150 mV	300 mV	600 mV
Current	125 mA	50 mA	33 mA	25 mA	20 mA	18 mA	13 mA	7 mA	3.5 mA	1.7 mA
Load Regulation <sup>3</sup> :										
Voltage	8 mV	20 mV	33 mV	40 mV	50 mV	60 mV	80 mV	150 mV	300 mV	600 mV
Current	125 mA	50 mA	33 mA	25 mA	20 mA	18 mA	13 mA	7 mA	3.5 mA	1.7 mA
Meter Accuracy:										
Voltage	0.09V	0.3V	0.43V	0.5V	0.6V	0.7V	0.9V	1.6V	4.0V	7.0V
Current	1.35A	0.6A	0.43A	0.35A	0.30A	0.28A	0.23A	0.08A	0.045A	0.018A
OVP Adjustment Range	0.4-8.8V	1.0-22V	1.65-36.3V	2-44V	2.5-55V	3-66V	4-88V	7.5-165V	15-330V	30-660V
Output Noise and Ripple (V)										
rms	10 mV	10 mV	10 mV	10 mV	20 mV	20 mV	20 mV	30 mV	40 mV	100 mV
p-p (20Hz-20MHz)	100 mV <sup>4</sup>	100 mV <sup>4</sup>	100 mV <sup>4</sup>	100 mV <sup>4</sup>	100 mV	100 mV	100 mV	200 mV	200 mV	500 mV

<sup>1</sup> Specifications are warranted over a temperature range of 0-50°C with default local sensing. From 50-70°C, derate output 2% per °C.

<sup>2</sup> For input voltage variation over the AC input voltage range, with constant rated load

<sup>3</sup> For 0-100% load variation, with constant nominal line voltage

<sup>4</sup> Typical P-P noise and ripple is 50 mV

**AC Input:** 200-250 Vac at 10 A rms or 100-130 Vac at 20 A rms, 47-63 Hz

**Maximum Voltage Differential from output to safety ground:** 600 Vdc

### Additional Characteristics

MODELS	8-125	20-50	33-33	40-25	50-20	60-18	80-13	150-7	300-3.5	600-1.7
Stability <sup>1</sup> :										
Voltage	4 mV	10 mV	16.5 mV	20 mV	25 mV	30 mV	40 mV	75 mV	150 mV	300 mV
Current	62.5 mA	25 mA	16.5 mA	12.5 mA	10 mV	9 mA	6.5 mA	3.5 mA	1.75 mA	0.85 mA
Temperature Coefficient <sup>2</sup> :										
Voltage	1.6 mV	4 mV	6.6 mV	8 mV	10 mV	12 mV	16 mV	30 mV	60 mV	120 mV
Current	37.5 mA	15 mA	9.9 mA	7.5 mA	6 mA	5.4 mA	3.9 mA	2.1 mA	1.05 mA	0.51 mA
Maximum Remote Sense Line Drop Compensation /line	0.5V	1V	1V	1V	1V	1V	1V	1V	1V	1V

<sup>1</sup> Maximum drift over 8 hours with constant line, load, and temperature, after 20 minute warm-up

<sup>2</sup> Change in output per °C change in ambient temperature, with constant line and load

**Altitude:** 2000M (6562 Ft.)

**Storage Temperature Range:** -55 to +85°C

**Humidity Range:** 0 to 80% Non-condensing

**Time Delay from power on until output stable:** 3 seconds maximum

**Voltage Mode Transient Response Time:** 1mS recovery to 1% band for 30% step load change from 70% to 100% or 100% to 70%

**Remote Start/Stop and Interlock:** TTL compatible input, Contact Closure, 12-250 Vac or 12-130 Vdc

**Switching Frequency:** Nominal 70 kHz (140 kHz output ripple)

**Analog Programming Linearity:** Typical error is less than 0.5% setting. Maximum error is 1% of rated output.

**Agency Approvals:** CE Pollution Degree 2 (UL pending)

**Remote Analog Programming (Full Scale Input)**

Scales are selectable via an internally-mounted switch.

PARAMETER	RESISTANCE	VOLTAGE	CURRENT
Voltage	5 kΩ	5V, 10V	1 mA
Current	5 kΩ	100 mV, 5V, 10V	1 mA
OVP	5 kΩ	5V, 10V	1 mA

**1.4.2 Mechanical Specifications**

Single Unit	HEIGHT	WIDTH	DEPTH	WEIGHT
	44 mm (1.75 in)	482.6 mm (19 in)	508 mm (20 in)	8.2 kg (18 lbs)

**Output Connector**

- **Models DCS 8-125 through DCS 80-13**

**Connector type:** Nickel plated copper bus bars.

**Approximate dimensions:** 1.365" x 0.8" x 0.125"

**Distance between positive and negative bus bar centers:** 2.2"

**Load wiring mounting holes:** Two 0.257" diameter holes on 0.5" centers (1/4" hardware)  
Two 0.191" diameter holes on 0.4" centers (#10 hardware)

- **Models DCS 150-7 through DCS 600-1.7**

**Connector type:** Six pin Amp Universal Mate-N-Lok connector

**Chassis mounted parts:** Housing: Amp part number 1-480705-0

Pins: Amp part number 350547-1

**Mating connector parts:** Housing: Amp part number 1-480704-0

Socket pins: Amp part number 350550-1

**Note:** Eight Socket pins and one mating connector housing are supplied with each 150V through 600V unit.

**Input Connector**

2 position terminal block plus safety ground screw.

**Note:** Input power cord not supplied.

**SPECIFICATIONS SUBJECT TO CHANGE WITHOUT NOTICE**

**This page intentionally left blank.**

## **SECTION 2. INSTALLATION and OPERATING INSTRUCTIONS**

### **2.1 General**

After unpacking, perform an initial inspection and function test to ensure that the unit is in good working order. If the unit was damaged in shipment, notify the carrier immediately. Direct repair problems to the Service Department, Sorensen Company. Customer Service Inquiries: 1-800-458-4258.

### **2.2 Initial Inspection**

The equipment should be inspected for damage as follows:

- Inspect for obvious signs of physical damage.
- Turn front panel controls from stop to stop. Rotation should be smooth.
- Test the action of the power switch. Switching action should be positive.
- If internal damage is suspected, remove the cover and check for printed circuit board and/or component damage. Reinstall cover.

### **2.3 Installation**



#### **2.3.1 Input Voltage Selection**

Before using the DCS power supply the correct AC input voltage must be selected and an appropriate line cord and plug attached, or hook up wire sized for input current based on NEC or local electrical code. The frequency of the AC input voltage must be maintained between 47 and 63 Hz.

All units are shipped in a configuration requiring a 200-250Vac 10 Amp input. The unit can also be converted for use with a 100-130Vac 20A input. **WARNING: Attempted operation of the DCS power supply with the incorrect input voltage may result in internal damage to the unit.**

For use with a **200-250Vac input**, connect a 250Vac 10Amp plug and cord to the rear panel AC connector and the safety ground screw. (Note that the NEUT. and LINE designations above the AC connector do not apply to 200-250V operation.)

To convert the unit for use with a **100-130Vac 20A input**, perform the following steps:

1. Ensure that the unit is switched off and disconnected from any power source.
2. Remove the Phillips head screws which secure the cover and then remove the cover from the unit.
3. Remove the 230Vac voltage selector jumper located at the front center of the PCB from its mating header (designated P1 on the PCB) and install the attached 115Vac jumper in its place.
4. Remove the adhesive backed 115VAC 20A label from fan and cover the 230VAC 10A input specification above the rear panel AC connector.

5. Reinstall the cover and replace screws.
6. Install a 125Vac 20Amp plug and cord ensuring that the neutral (white) wire and line (black) wire are connected in the correct positions and that the safety ground wire is connected to the ground screw.

**NOTE:**

To provide protection for personnel in the case of unit failure and to ensure proper power supply operation, the safety ground wire of the AC input line cord must **ALWAYS** be connected to the ground screw provided.

### 2.3.2 Input Line Impedance

The maximum input line impedance for operation at full rated output is 1 ohm. Higher source impedances can be tolerated by raising the input line voltage or by reducing the output voltage and/or current.

### 2.3.3 Ventilation Requirements

The DCS power supply may be used in rack mounted or benchtop applications. In either case sufficient space must be allowed for cooling air to reach the ventilation inputs on each side of the unit and for the fan exhaust air to exit from the rear of the unit.

### 2.3.4 Output Voltage Biasing



If the output voltage is to be biased relative to safety ground, the power supply outputs may be biased up to a maximum of 150Vdc with respect to the chassis.

### 2.3.5 Rack Mounting

The DCS power supply is designed to fit in a standard 19" equipment rack. When installing the unit in a rack be sure to provide adequate support for the rear of the unit while not obstructing the ventilation inlet on the sides of the unit. Use adjustable support angles such as Hammond RASA22WH2, or a support bar such as Hammond RASB19WH2.

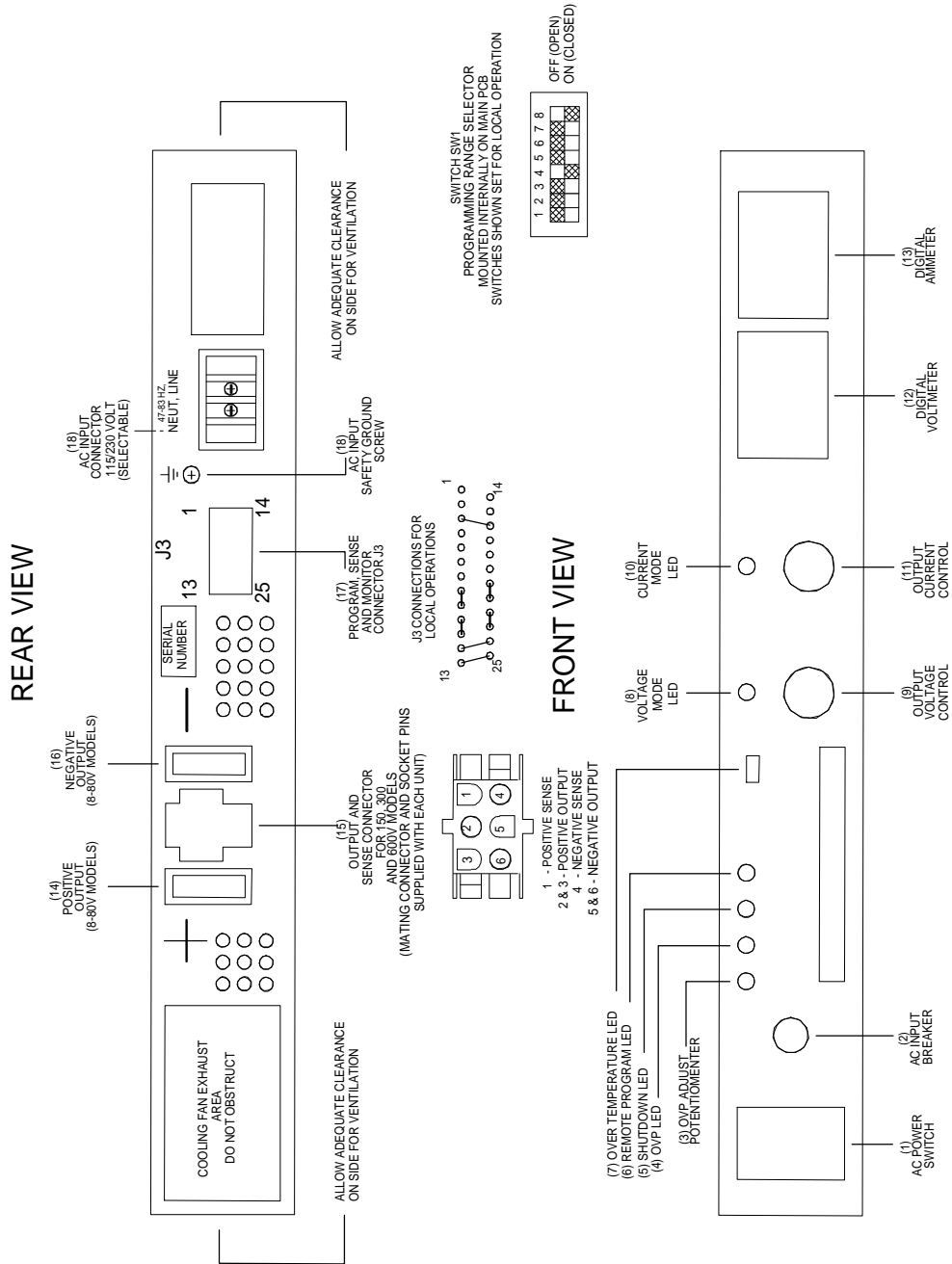
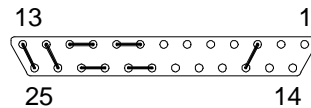

Figure 2-1

## 2.4 Initial Functional Tests

Before connecting the unit to an AC outlet, make sure that the power switch is in the OFF position and that the voltage and current controls are turned fully counter clockwise. Check that the J3 mating connector on the rear of the unit is in place with jumpers connected for local operation as shown below. (This is the default configuration as shipped from the factory). Connect the unit to a 230Vac grounded outlet (115Vac outlet if previously configured for 115Vac operation as per instructions in section 2.3.1) and switch the unit on. After a short power on delay the front panel meters should light up with both displays reading zero.

CONNECTOR J3



Connector J3 Configuration for Local Operation

To check **voltage mode operation**, proceed as follows:

- Connect a DVM, rated better than 0.5% accuracy, to the rear output terminals, observing correct polarity.
- Rotate the CURRENT control 1/2 turn clockwise. Slowly rotate the VOLTAGE control clockwise and observe both the internal and external meters. Minimum control range should be from zero to the maximum rated output. Compare the test meter reading with the front panel voltmeter reading. Check that the green voltage mode indicator led is ON.
- Set the POWER switch to OFF.

To check **current mode operation**, proceed as follows:

- Rotate the VOLTAGE and CURRENT controls fully counterclockwise.
- Rotate the VOLTAGE control 1/2 turn clockwise.
- Connect a high current DC ammeter across the rear output terminals, observing correct polarity. Select leads of sufficient current carrying capacity and an ammeter range compatible with the unit's rated current output. The ammeter should have an accuracy of better than 0.5%.
- Set the POWER switch to ON.
- Rotate the CURRENT control slowly clockwise. The control range should be from zero to the maximum rated output. Compare the test meter reading with the reading on the front panel ammeter. Check that the red current mode indicator led is ON.
- Set the POWER switch to OFF.



## 2.5 Controls, Connectors, and Indicators

Refer to **Figure 2-1** and the descriptions below.

### 2.5.1 Front Panel

1. AC Power Switch
2. AC Input Circuit Breaker
3. OVP Adjust Potentiometer: Manual adjustment for OVP trip level
4. OVP LED: Indicates that the OVP circuit has been activated when illuminated
5. Shutdown LED: Indicates activation of the remote shutdown circuit when illuminated
6. Remote Programming LED: Indicates operation by remote programming when illuminated
7. Over-Temperature LED: Indicates that the power supply is shut down due to an internal over-temperature condition when illuminated
8. Voltage Mode LED: Indicates operation in voltage mode when illuminated
9. Output Voltage Control: Multi-turn potentiometer used to adjust the output voltage in local mode
10. Current Mode LED: Indicates operation in current mode when illuminated
11. Output Current Control: Multi-turn potentiometer used to adjust the output current limit in local mode
12. Digital Voltmeter
13. Digital Ammeter

### 2.5.2 Rear Panel

14. Positive Output for 8, 20, 33, 40, 50, 60, and 80 Volt Models
15. Output and Sense Connector for 150, 300 and 600 Volt Models
16. Negative Output for 8, 20, 33, 40, 50, 60, and 80 Volt Models
17. Programming, Sense and Monitor Connector J3: Input connector for programming signals. Also provides access to sense connections and monitoring points. See **Table 2-1** for individual pin descriptions. **Note:** The positive output and positive sense are not available at connector J3 on 150, 300 and 600 volt models
18. AC Input Safety Ground Screw
19. AC Input Connector

**Table 2-1 J3 Program, Sense and Monitor Connector Description**  
(D-subminiature 25 Pin Female) \*

PIN NUMBER	FUNCTION
1.....	AC/DC Shutdown Input (12-250Vac or 12-130Vdc)
14	TTL Shutdown Input
2.....	Return for Shutdown Input Signals
15	+12Vdc Output (1k ohm source impedance)
3.....	OVP Programming Input (0-5V, 0-10V or 0-1mA)
	Jumpered to pin 16 for local mode operation
16	1mA Current Source for Local OVP Control or Remote Resistive OVP Programming
4.....	Remote Programming Indicator
	High = Remote Programming Low = Local Control
17	OVP Status (High = OVP Circuit Activated)
5.....	Operating Mode Indicator
	High = Voltage Mode Low = Current Mode
18	Thermal Shutdown Indicator (High = Shutdown)
6.....	Ground
19	Output Voltage Monitor (Uncalibrated) 0-5V = 0-100%
7.....	Output Current Monitor (Calibrated) 0-5V = 0-100%
20	Front Panel Voltage Control (Local Mode)
	Jumpered to pin 21 for local operation
8.....	Front Panel Voltage Control (Remote Programming)
	Input for 0-1mA remote programming signal
	Jumpered to pin 9 for local operation and remote current source programming
21	1mA Current Source for Local Operation or Remote Resistive Programming of Output Voltage
	Jumpered to pin 20 for local operation
9.....	Remote Voltage Programming Input (0-5V or 0-10V)
	Jumpered to pin 8 for local operation and remote current source programming
22	1mA Current Source for Local Operation or Remote Resistive Programming of Output Current Limit
	Jumpered to pin 23 for local operation
10.....	Remote Current Programming Input (0-100mV, 0-5V or 0-10V)
	Jumpered to pin 11 for local operation and remote current source programming
23	Front Panel Current Control (Local Mode)
	Jumpered to pin 22 for local operation
11.....	Front Panel Current Control (Remote Programming)
	Input for 0-1mA external programming signal
	Jumpered to pin 10 for local operation and remote current source programming
24	Return (for local sense connections only)
12.....	Return Sense (Return for Remote Programming Inputs)
25	Positive Output (for local sense connections only)
13.....	Positive Sense

**Note:** Pins 25 and 13 not connected on 150, 300 and 600V models.  
\* Mating connector - 25 pin male ITT Cannon DB25P or equivalent.

## 2.6 Standard Operation

Reliable performance of the DCS power supply can be obtained if certain basic precautions are taken when connecting it for use on the lab bench or installing it in a system.

To obtain a stable, low noise output, careful attention should be paid to factors such as conductor ratings, system grounding techniques and the way in which the load and remote sensing connections are made.

### 2.6.1 Load Conductor Ratings

The table below lists the maximum allowable load wiring length (in feet) for a specified wire gauge and power supply model operating at full rated output. The lengths indicated are based on PVC insulated wire with a maximum operating temperature of 105 degrees C. To overcome impedance and coupling effects which can degrade the power supply performance the use of leads of the largest gauge and shortest length possible is recommended.

MODEL	WIRE SIZE (AWG)								
	2	4	6	8	10	12	14	16	18
<b>8-125</b>	19	12	-	-	-	-	-	-	-
<b>20-50</b>	30	30	30	23	-	-	-	-	-
<b>33-33</b>	30	30	30	30	22	14	-	-	-
<b>40-25</b>	30	30	30	30	30	18	-	-	-
<b>50-20</b>	30	30	30	30	30	23	13	-	-
<b>60-18</b>	30	30	30	30	30	26	16	10	-
<b>80-13</b>	30	30	30	30	30	30	22	20	-
<b>150-7</b>	30	30	30	30	30	30	28	26	-
<b>300-3.5</b>	30	30	30	30	30	30	30	30	-
<b>600-1.7</b>	30	30	30	30	30	30	30	30	30

### 2.6.2 Load Connection and Grounding

Proper connection of distributed loads is an important aspect of power supply application. A common mistake is to connect leads from the power supply to one load, from that load to the next load, and so on for each load in the system. In this **parallel power distribution** method, the voltage at each load depends on the current drawn by the other loads and DC ground loops are developed. Except for low current applications, this method should not be used.

The preferred way to distribute power is by the **radial distribution** method in which power is connected to each load individually from a single pair of terminals designated as the positive and negative distribution terminals. The pair of terminals may be the power supply output terminals, the terminals of one of the loads or a distinct set of terminals specially established for distribution. Connecting the sense leads to these terminals will compensate for losses and minimize the effect of one load upon another.

### 2.6.3 Inductive Loads

To prevent damage to the power supply from inductive kickback, connect a diode rated at greater than or equal to the supply's output voltage and current across the output. Connect the cathode to the positive output and the anode to return. Where positive load transients such as back EMF from a motor may occur, connect a transorb or a varistor across the output to protect the power supply.

### 2.6.4 Remote Sensing

The use of remote sensing permits the regulation point of the power supply to be shifted from the output terminals to the load or other distribution terminals thereby automatically compensating for the voltage losses in the leads supplying the load (provided these losses do not exceed 1V/line (0.5V/line for the DCS 8-125 model)). For example, with the voltmeter reading 10.0 volts and the sense lines connected directly to the load, the load voltage will remain regulated at 10.0 volts regardless of the voltage drops in the power leads and variations in the load current.

On 8V, 20V, 33V, 40V, 50V, 60V and 80V models the positive sense connection is available at pin 13 of connector J3 and the return sense connection is available at pin 12. For local sensing (regulation at the power supply output terminals) the sense pins are connected to pins 25 (positive output) and 24 (return) of connector J3. For remote sensing the local operation jumpers are removed and pins 13 and 12 are connected directly to the positive and negative terminals of the load.

On 150, 300 and 600V models the sense connections are available through the output connector (See **Figure 2-1** for the exact pin out). On these models no sense line jumpers are required for local operation.

Sense wires can be any size (24AWG or larger) but in high noise environments or when the lowest possible power supply ripple is required, sense wires must be twisted and/or shielded.



**NOTE:**

On 8-80V models the sense leads must always be connected, either for remote or local sensing. Operation of the supply with the sense leads disconnected will cause the output to fall to zero or to be unregulated.



**NEVER** use the sense connections without the normal power lead connections to the output terminals. Avoid reversing positive and negative sense lead connections.

### 2.6.5 Negative Output Operation

Operation of the unit as a negative output supply may be accomplished by referencing the positive output terminal to the power supply chassis or some other common system ground. This mode of operation is limited to 8-150V models only due to the metal shell 25-pin “D” connector supplied with the unit which mates to J3.



**WARNING!**

**Operation of the 300V or 600V models in the negative output mode is in violation of the European Community’s Low Voltage Directive.**

**NOTE:**

If a -300V or -600V supply is required, please contact the Sorensen Sales Department or Customer Service for availability.

## 2.7 Single Supply Operation (Local Mode)



To operate the DCS power supply in local mode, first install the unit and connect the load following the instructions in **Sections 2.1 to 2.6**. Check that switch SW1 (mounted internally on the main printed circuit board) is set for local operation and that the J3 mating connector on the rear of the unit is in place with jumpers connected for local operation. (**Note:** This is the default configuration as shipped from the factory. See the diagram below.) Set both the current and voltage controls fully counterclockwise.

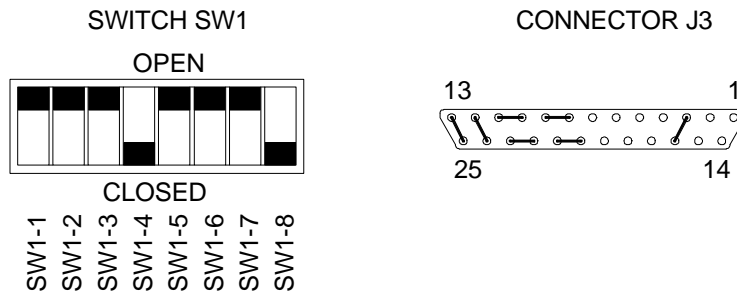

### Switch SW1

SW1-1	Off (Open)
SW1-2	Off (Open)
SW1-3	Off (Open)
SW1-4	On (Closed)
SW1-5	Off (Open)
SW1-6	Off (Open)
SW1-7	Off (Open)
SW1-8	On (Closed)

### Switch SW1 and Connector J3 Configuration for Local Operation (Default factory settings)

For **voltage mode operation**, turn the current control fully clockwise and then adjust the voltage control to obtain the desired output voltage. For **current mode operation**, turn the voltage control 1/2 turn clockwise, the current control fully counterclockwise and connect an appropriately sized shorting jumper across the output terminals. Turn the current control clockwise until the desired output current is obtained. Turn the power supply off, remove the shorting jumper, turn the voltage control fully clockwise and turn the power supply on.

Note that for a short period (less than 2 seconds) after power on, the power supply output is disabled and the current mode LED is illuminated while the main filter capacitors charge through the inrush limiter.

## 2.8 Multiple Supplies

DCS Series power supplies of the SAME MODEL may be operated with outputs in series or parallel to obtain increased load voltage or current. Split supply operation allows two positive or a positive and negative output to be obtained.

### 2.8.1 Series Operation

Series operation is used to obtain a higher voltage single output supply using two or more single units. Connect the negative terminal (-) of one supply to the positive terminal (+) of the next supply of the same model. The total voltage available is the sum of the maximum voltages of each supply (add voltmeter readings).

#### Notes:

1. The maximum allowable sum of the output voltages is 300V. This is limited by the creepage/clearance distances internal to the construction of the metal shell 25-pin 'D' connector mated to J3. If a higher output voltage range is required, contact the Sorensen Sales Department or Customer Service for availability.
2. The maximum allowable current for a series string of power supplies is the rated output current of a single supply in the string.
3. Remote sensing should not be used during series operation.

### 2.8.2 Parallel Operation

Parallel operation is used to obtain a higher current single output supply using two or more single units. Set all of the outputs to the same voltage before connecting the positive terminals (+) and negative terminals (-) in parallel. The total current available is the sum of the maximum currents of each supply.

**Caution:** To prevent internal damage, ensure that the OVP trip level of all supplies is set to maximum.

### 2.8.3 Split Supply Operation

Split supply operation is used to obtain two positive voltages with a common ground, or a positive-negative supply.

To obtain **two positive voltages**, connect the negative terminals of both supplies together. The positive terminals will supply the required voltages with respect to the common connection.

To obtain a **positive-negative supply**, connect the negative terminal of one supply to the positive terminal of the second supply. The positive terminal of the first supply then provides a positive voltage relative to the common connection while the negative terminal of the second supply provides a negative voltage. The current limits can be set independently. The maximum current available in split operation is equal to the rated output of the supplies used.



Refer to paragraph 2.6.4 for additional information pertaining to negative output configured supplies.

## 2.9 Over Voltage Protection (OVP)

The OVP circuit allows for protection of the load in the event of a remote programming error, incorrect voltage control adjustment, or power supply failure. The protection circuit monitors the output and reduces the output voltage and current to zero whenever a preset voltage limit is exceeded. A red LED on the front panel indicates when the OVP circuit has been activated. Resetting the OVP circuit after activation requires removal of the over-voltage condition and powering the unit OFF and back ON or momentarily activating the remote shut down circuit (See **Section 2.10** for information on shut down circuit operation). The OVP trip level can be set using either the front panel potentiometer or by using one of three remote programming methods (voltage, resistance or current) through the J3 connector at the rear of the unit.

### 2.9.1 Front Panel OVP Operation

To set the trip level from the front panel use the following procedure:

1. With the unit off and disconnected from its AC source remove the cover and check that switches SW1-4 and SW1-8 are closed (factory default setting). Also check that the jumper between pins 3 and 16 of connector J3 is in place.
2. Using a small flat bladed screwdriver through the OVP ADJUST hole in the front panel, turn the adjusting screw fully clockwise (until audible clicking is heard or 20 turns maximum).
3. Turn the unit on and adjust the output to the desired trip voltage.
4. Slowly turn the adjusting screw counterclockwise until the red OVP indicator lamp lights and the power supply output shuts off.
5. Turn the POWER switch to OFF.
6. Turn the voltage control knob to minimum.
7. Turn the POWER switch back ON and increase the voltage to check that the power supply shuts off the output at the desired voltage.

### 2.9.2 Remote Programming of OVP With External Voltage Sources

To remotely program the OVP trip level using a 0-5V or 0-10V DC voltage source use the following procedure:

1. With the unit off and disconnected from its AC source, remove the cover and set switch SW1-4 closed (default factory setting) for 0-5V programming or open for 0-10V programming. Also check that switch SW1-8 is closed (default factory setting). Set the front panel OVP adjusting potentiometer fully clockwise (until audible clicking is heard or 20 turns maximum).
2. Remove the default jumper connecting pins 16 and 3 of connector J3 and connect the voltage source between pins 3 (positive) and 12 (negative). Set the programming source voltage to maximum.
3. Turn the unit on and adjust the output to the desired trip voltage.
4. Slowly reduce the programming voltage until the red OVP indicator lamp lights and the power supply shuts down.
5. Turn the POWER switch to OFF.
6. Turn the voltage control knob to minimum.
7. Turn the POWER switch back ON and increase the voltage to check that the power supply shuts off the output at the desired voltage.

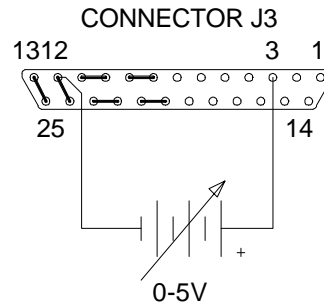
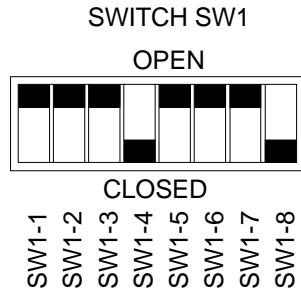

**Switch SW1**

- SW1-1 Off (Open)
- SW1-2 Off (Open)
- SW1-3 Off (Open)
- SW1-4 On (Closed)
- SW1-5 Off (Open)
- SW1-6 Off (Open)
- SW1-7 Off (Open)
- SW1-8 On (Closed)

**Switch SW1 and Connector J3 Configuration  
for 0-5Vdc OVP Programming**

(J3 sense line, voltage control and current control jumpers shown set for local operation)

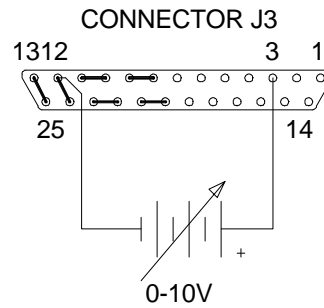
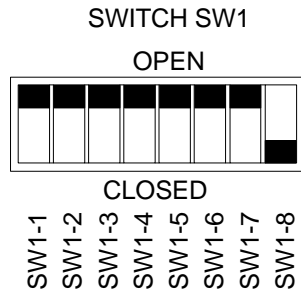

**Switch SW1**

- SW1-1 Off (Open)
- SW1-2 Off (Open)
- SW1-3 Off (Open)
- SW1-4 Off (Open)
- SW1-5 Off (Open)
- SW1-6 Off (Open)
- SW1-7 Off (Open)
- SW1-8 On (Closed)

**Switch SW1 and Connector J3 Configuration  
for 0-10Vdc OVP Programming**

(J3 sense line, voltage control and current control jumpers shown set for local operation)



### 2.9.3 Remote Programming of OVP with an External Resistance

To remotely program the OVP trip level using a 5k ohm external potentiometer use the following procedure.

1. With the unit off and disconnected from its AC source remove the cover, set switch SW1-8 open and check that switch SW1-4 is closed (default factory setting for switch SW1-4).
2. Connect the counterclockwise end of the 5k potentiometer to pins 3 and 16 of connector J3. Connect the tap and the clockwise end of the potentiometer to pin 12. Set the potentiometer fully clockwise.
3. Turn the unit on and adjust the output to the desired trip voltage.
4. Slowly turn the potentiometer counterclockwise until the red OVP indicator lamp lights and the power supply shuts down.
5. Turn the POWER switch to OFF.
6. Turn the voltage control knob to minimum.
7. Turn the POWER switch back ON and increase the voltage to check that the power supply shuts off the output at the desired voltage.

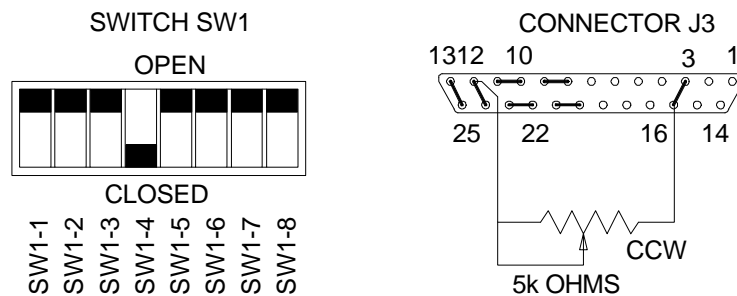

#### Switch SW1

SW1-1	Off (Open)
SW1-2	Off (Open)
SW1-3	Off (Open)
SW1-4	On (Closed)
SW1-5	Off (Open)
SW1-6	Off (Open)
SW1-7	Off (Open)
SW1-8	Off (Open)

#### **Switch SW1 and Connector J3 Configuration for 0-5k OVP Programming**

(J3 sense line, voltage control and current control jumpers shown set for local operation)

### 2.9.4 Remote Programming of OVP with External Current Sources

To remotely program the OVP trip level using a 0-1mA current source use the following procedure.

1. With the unit off and disconnected from its AC source remove the cover and set switches SW1-4 and SW1-8 closed (default factory setting).
2. Using a small flat bladed screwdriver through the OVP ADJUST hole in the front panel, turn the adjusting screw fully clockwise (until audible clicking is heard or 20 turns maximum).
3. Remove the default jumper connecting pins 16 and 3 of connector J3 and connect the current source between pins 3 (positive) and 12 (negative). Set the programming source to 1mA.
4. Turn the unit on and adjust the output to the desired trip voltage.
5. Slowly reduce the programming current until the red OVP indicator lamp lights and the power supply shuts down.
6. Turn the POWER switch to OFF.
7. Turn the voltage control knob to minimum.
8. Turn the POWER switch back ON and increase the voltage to check that the power supply shuts off the output at the desired voltage.

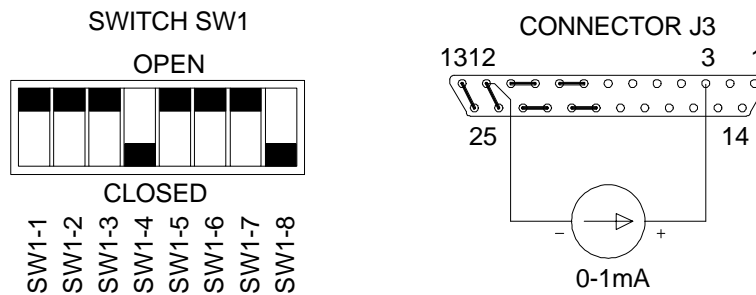

**Switch SW1**

- SW1-1 Off (Open)
- SW1-2 Off (Open)
- SW1-3 Off (Open)
- SW1-4 On (Closed)
- SW1-5 Off (Open)
- SW1-6 Off (Open)
- SW1-7 Off (Open)
- SW1-8 On (Closed)

**Switch SW1 and Connector J3 Configuration for 0-1mA Current Source OVP Programming**

(J3 sense line, voltage control and current control jumpers shown set for local operation)

### 2.9.5 Remote OVP Sensing

The default configuration for the OVP circuit senses the output voltage at the power supply output terminals. For applications using remote sensing where there is a need to accurately monitor the actual load voltage, the following procedure allows the OVP sense point to be shifted from the power supply output to the sense line connection points.

1. Shut the unit off and disconnect it from its power source. Remove the cover from the unit.
2. Using a sharp Exacto knife, cut the component side trace connecting the right hand side of resistor R89 to the via marked OVP-LOC.
3. Install an piece of insulated #22 AWG wire from the via marked C (near the trace cut just made) to the via marked C1 (near capacitor C51).
4. Reinstall the cover and reconnect the unit to its power source.

To return to local OVP sensing, remove the jumper installed in step 3 above and install a jumper across the trace cut made in step 2.

### 2.10 Remote ON/OFF

This feature is useful in test applications requiring remote ON-OFF control of the output. The remote ON-OFF control circuit uses either a TTL compatible or a 12-250Vac (or 12-130Vdc) input to remotely control (disable or enable) the power supply output. For TTL operation, a logic level signal between pins 14 (positive) and 2 (return) of connector J3 determines the output conditions:

TTL LOW = OUTPUT ON  
TTL HIGH = OUTPUT OFF

For AC or DC operation, an input of 12-250Vac (or 12-130Vdc) between pins 1 (positive for DC input) and 2 (return) of connector J3 will disable the output of the supply.

A red LED on the front panel indicates when the shutdown circuit is activated. The input lines are optically isolated and can therefore be accessed by circuits with a voltage differential of up to 600Vdc.

#### 2.10.1 Remote ON/OFF by Contact Closure

An external relay may be used to operate the ON/OFF control circuit as follows. Connect one side of a normally open relay to pin 15 of connector J3 (+12V). Connect the other side of the relay to pin 14 (TTL Shutdown). Also connect J3 pin 2 (Shutdown return) to pin 6 (Ground). Using this configuration, the power supply will be OFF when the relay coil is energized and ON when the relay is de-energized.

If a normally closed relay is substituted for the normally open relay in the configuration described above, the power supply will be ON when the relay coil is energized and OFF when the relay is de-energized.

## 2.11 Remote Programming of Output Voltage and Current Limit

The output voltage and current limit of the power supply can be remotely programmed through the rear panel J3 connector using **external voltage sources, current sources and resistances**. Switch SW1 on the A2 printed circuit board controls the programming as diagrammed below. When the supply is controlled by remote programming, the green REMOTE led on the front panel is illuminated.

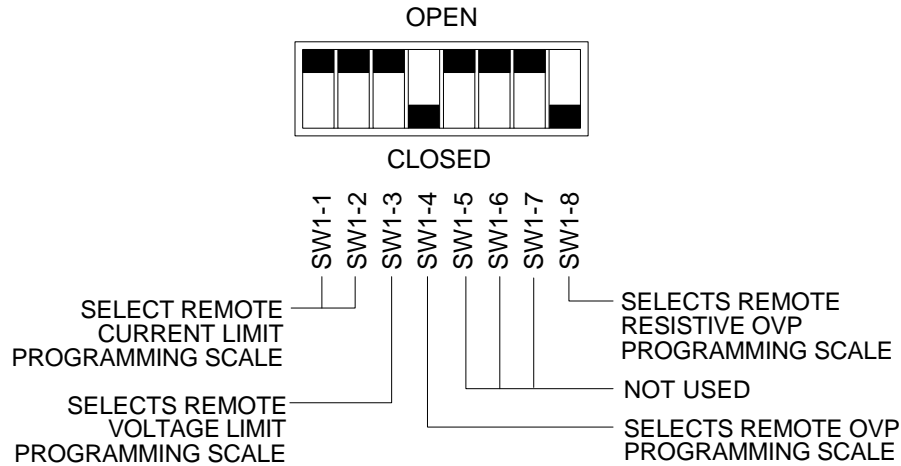

### Switch SW1

- SW1-1 Used to select 5V or 10V programming of remote current limit
- SW1-2 Used to select 100mV programming of remote current limit
- SW1-3 Used to select 5V or 10V programming of remote voltage limit
- SW1-4 Used to select remote OVP programming scale
- SW1-5 Not used
- SW1-6 Not used
- SW1-7 Not used
- SW1-8 Used to select remote resistive OVP programming scale

### Switch SW1 Functions

**Note:** To set switch SW1 shut the unit off, disconnect it from its AC source and remove the cover. Make the appropriate switch settings then reinstall the cover and reconnect the unit to its AC source.

#### 2.11.1 Programming With External Voltage Sources

The **output voltage** can be programmed using either a 0-5Vdc or 0-10Vdc external voltage source. To program the output voltage with a 0-5Vdc source, set switch SW1-3 open (default factory setting) and remove the jumpers connecting pins 8 to 9 and 20 to 21 on connector J3. Connect the external source between pins 9 (positive) and 12 (return). Varying the external voltage from 0-5V will cause the output to vary from 0-100% of rated output.

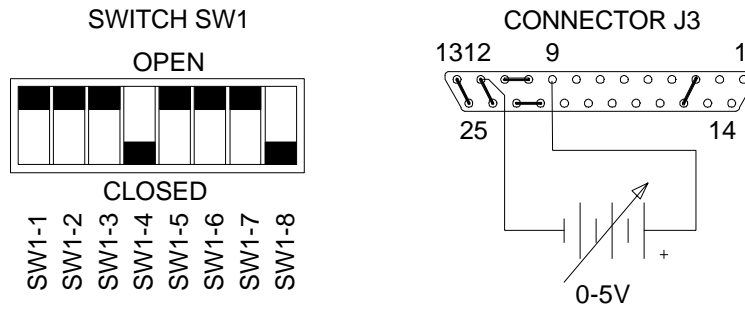

**Switch SW1**

- SW1-1 Off (Open)
- SW1-2 Off (Open)
- SW1-3 Off (Open)
- SW1-4 On (Closed)
- SW1-5 Off (Open)
- SW1-6 Off (Open)
- SW1-7 Off (Open)
- SW1-8 On (Closed)

**Switch SW1 and Connector J3 Configuration for 0-5V Programming of the Output Voltage**

(J3 sense line, OVP and current control jumpers shown set for local operation)

For programming with a 0-10Vdc source, close switch SW1-3 and replace the 0-5V source with a 0-10V source.

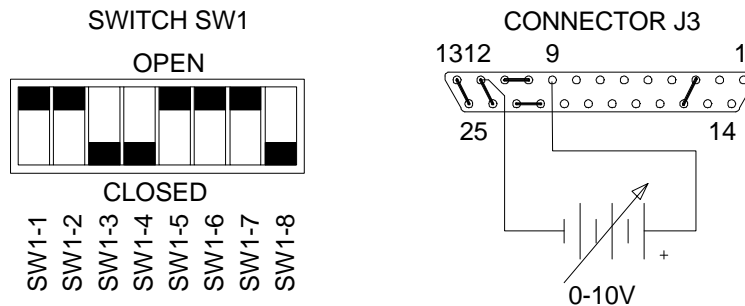

**Switch SW1**

- SW1-1 Off (Open)
- SW1-2 Off (Open)
- SW1-3 On (Closed)
- SW1-4 On (Closed)
- SW1-5 Off (Open)
- SW1-6 Off (Open)
- SW1-7 Off (Open)
- SW1-8 On (Closed)

**Switch SW1 and Connector J3 Configuration for 0-10V Programming of the Output Voltage**

(J3 sense line, OVP and current control jumpers shown set for local operation)

The **output current limit** can be programmed using a 0-5Vdc or 0-10Vdc external voltage source. Selection of the programming voltage is done using switches SW1-1 and SW1-2 as indicated below:

SW1-1	SW1-2	PROGRAMMING VOLTAGE
OPEN	OPEN	0-5Vdc and Local Mode
CLOSED	CLOSED	Not Used
CLOSED	OPEN	0-10Vdc
OPEN	CLOSED	0-100mV

To remotely program the output current limit, set switches SW1-1 and SW1-2 as shown above, remove the jumpers connecting pins 10 to 11 and 22 to 23 of connector J3 and connect the external voltage source between pins 10 (positive) and 12 (return). Varying the voltage source from 0-100% causes the current limit to vary from 0-100% of the rated maximum.

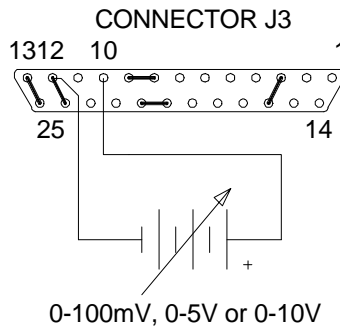

**Connector J3 Configuration  
for Remote Programming of the Output Current Limit**  
(J3 sense line, OVP and voltage control jumpers shown set for local operation)

### 2.11.2 Programming With an External Resistance

The output voltage and current limit can be programmed using a 5k ohm external potentiometer.

To program the **output voltage**, set switch SW1-3 open (default factory setting) and remove the jumpers connecting pins 8 to 9 and 20 to 21 on connector J3. Connect pins 9 and 21 to the counterclockwise end of the 5k potentiometer and connect the tap and clockwise end of the potentiometer to pin 12. Adjusting the tapped resistance from 0-5k will vary the output voltage from 0-100% of the rated output.

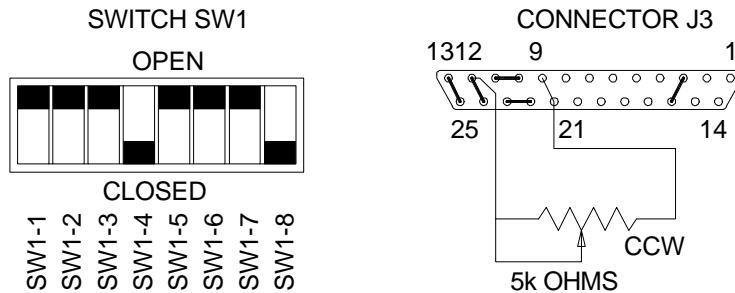

**Switch SW1**

- SW1-1 Off (Open)
- SW1-2 Off (Open)
- SW1-3 Off (Open)
- SW1-4 On (Closed)
- SW1-5 Off (Open)
- SW1-6 Off (Open)
- SW1-7 Off (Open)
- SW1-8 On (Closed)

**Switch SW1 and Connector J3 Configuration  
for Resistive Programming of the Output Voltage**

(J3 sense line, OVP and current control jumpers shown set for local operation)

To program the **output current limit**, set switches SW1-1 and SW1-2 open (default factory setting) and remove the jumpers connecting pins 10 to 11 and 22 to 23 on connector J3. Connect pins 10 and 22 to the counterclockwise end of the 5k potentiometer and connect the tap and clockwise end of the potentiometer to pin 12. Adjusting the tapped resistance from 0-5k will vary the current limit from 0-100% of the rated output.

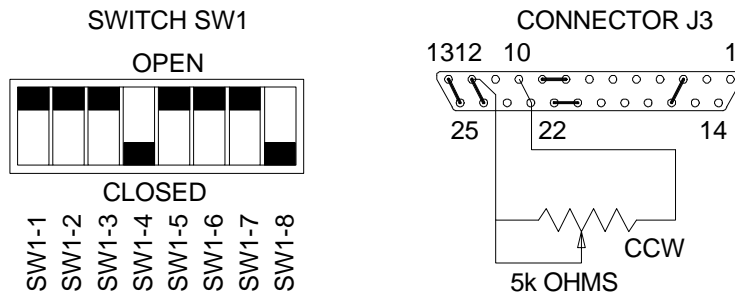

**Switch SW1**

- SW1-1 Off (Open)
- SW1-2 Off (Open)
- SW1-3 Off (Open)
- SW1-4 On (Closed)
- SW1-5 Off (Open)
- SW1-6 Off (Open)
- SW1-7 Off (Open)
- SW1-8 On (Closed)

**Switch SW1 and Connector J3 Configuration  
for Resistive Programming of the Output Current Limit**

(J3 sense line, OVP and voltage control jumpers shown set for local operation)

### 2.11.3 Programming With an External Current Source

The output voltage and current limit can be programmed using an external 0-1mA current source.

To program the **output voltage**, set the front panel voltage control to maximum, set switch SW1-3 open (default factory setting) and remove the jumper between pins 20 and 21 of connector J3. Connect the external current source between pins 8 (positive) and 12 (return) of connector J3. Varying the current source from 0-1mA will vary the output voltage from 0-100% of the rated output.

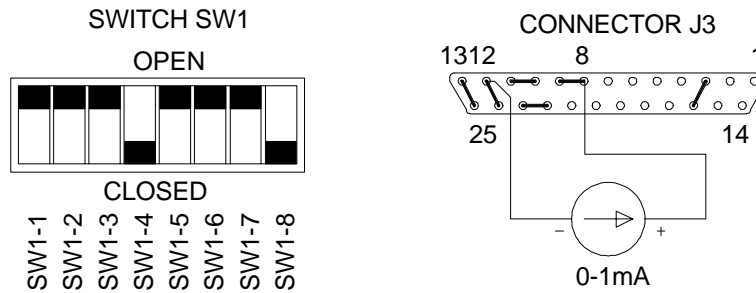

**Switch SW1 and Connector J3 Configuration for 0-1mA Current Programming of the Output Voltage**  
 (J3 sense line, OVP and current control jumpers shown set for local operation)

To program the **output current limit**, set the current control to maximum, set switches SW1-1 and SW1-2 open (factory setting) and remove the jumper between pins 22 and 23 of connector J3. Connect the external current source between pins 11 (positive) and 12 (return). Varying the current source from 0-1mA causes the current limit to vary from 0-100% of rated maximum.

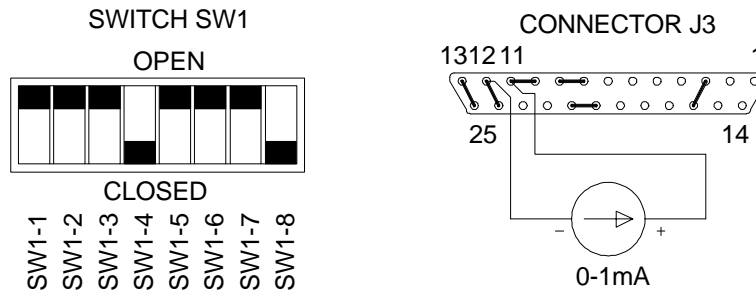

**Switch SW1 and Connector J3 Configuration for 0-1mA Current Programming of the Output Current Limit**  
 (J3 sense line, OVP and voltage control jumpers shown set for local operation)



## 2.12 Remote Monitoring and Status Indicators

Readback signals for remote monitoring of the output voltage and current are available at connector J3 on the rear of the unit. A 0-5V (uncalibrated) signal between pins 19 (positive) and 12 (negative) represents 0-100% of the rated output voltage. A 0-5V (calibrated) signal between pins 7 (positive) and 12 (negative) represents 0-100% of the rated output current. The offset and gain of the current readback signal may be adjusted through holes in the cover of the unit (See **Section 4.4 Calibration** for location of adjusting holes).

Status indicators for thermal shutdown, OVP operation, remote programming and operating mode are also available through the J3 connector. The table below lists the various signals, the J3 connector pins where they are available, the approximate magnitude of the signal (measured with respect to pin 6 of connector J3) and the source impedance through which the signal is fed.

INDICATOR SIGNAL	J3 CONNECTOR PIN	SIGNAL VOLTAGE	SOURCE IMPEDANCE
Thermal Shutdown	18	+10V	750Ω
OVP Circuit Activated	17	+9V	750Ω
Remote Programming	4	+10V	750Ω
Voltage Mode Operation	5	+10V	750Ω
Current Mode Operation	5	-3V	750Ω

**This Page Intentionally Left Blank.**

## **SECTION 3. THEORY OF OPERATION**

### **3.1 Power Circuit (A2 Assembly)**

This section describes the operation of the A2 assembly switching regulator power circuit. Three subsections cover basic switching regulator theory, a simplified description of the Sorensen full bridge converter, and a more detailed circuit description intended for troubleshooting purposes.

#### **3.1.1 Basic Off-Line Switching Regulator Theory**

An off-line switching power supply first converts the AC input line voltage to high voltage DC by diode rectification and then chops the DC at a high frequency. This high frequency waveform is applied to the primary of a power transformer which provides a step-up or step-down in voltage and electrical isolation on its secondary. The secondary waveform is rectified and filtered, giving a smooth DC output voltage. Feedback from the secondary circuit is applied to a pulse width modulator (PWM) control circuit which controls the on-time of the primary circuit switching waveform. This increases or decreases the voltage on the secondary of the power transformer so that output regulation is obtained.

The use of high frequency transformers in switching power supplies has the advantage of requiring less volume, less weight, and dissipating less heat than the lower frequency transformers in conventional linear power supplies.



#### **CAUTION!**

**Potentially LETHAL VOLTAGES exist on the A2 circuit board on the primary side of the isolation barrier. Troubleshoot with care, preferably with power off and recognizing that filter capacitors store potentially LETHAL and DESTRUCTIVE ENERGY even for some time AFTER POWER is REMOVED. Always use an isolation transformer connected ONLY to the power supply input when making test measurements on the primary side circuits.**

#### **3.1.2 Simplified Full Bridge Converter Theory**

See Figure 3-1.

The input AC line voltage is rectified and filtered by CR35, C32(A,B,C), and C72(A,B,C) to a raw DC voltage which is supplied to the power FETs Q13-Q16 on the primary of power transformer T1. Resistor R116 and relay K1 form an input surge current limiter which reduces the inrush current to the filter capacitors C32(A,B,C), and C72(A,B,C) during power-up. The power FETs and the primary winding of T1 form a bridge which is driven at 70 kHz by pulse width modulator (PWM) U6 through FETs Q7-Q12, Q18 and Q19 and drive transformer T2. A current sense transformer T3 in the primary of the power transformer provides a feedback signal to the PWM which is compared to a limited error signal derived from the output current and voltage control circuits. The output of the comparator controls the on time of the PWM output drive waveforms on a cycle by cycle basis thereby controlling the primary current and the output of the power transformer. Diodes CR301 and CR302 (CR301-CR304 on models DCS 150-7 and 300-3.5 and CR300-CR307 on model DCS 600-1.7) rectify the output of power transformer T1 and inductor L3 and capacitors C51, C52 and C53 filter the rectified signal to provide the DC output.

**SIMPLIFIED FULL BRIDGE CONVERTER**

FULL WAVE BRIDGE USED ON 150, 200 AND 600V MODELS  
 (CR301-CR304 USED ON 150 AND 300V MODELS)  
 (CR300-CR307 USED ON 600V MODELS)  
 8V CONFIGURATION SHOWN

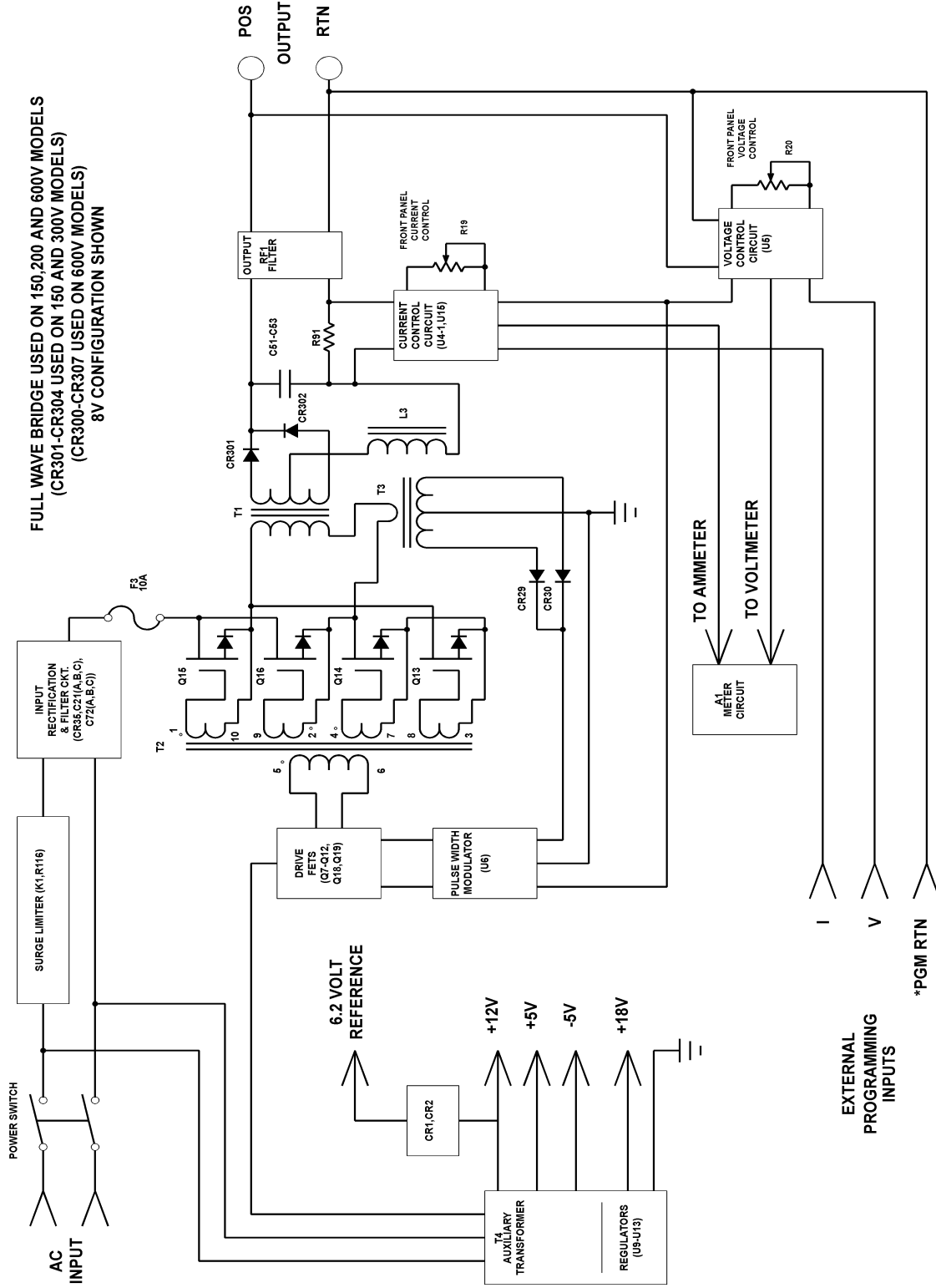

\*NOTE THAT PGM RTN IS TIED TO OUTPUT RETURN VIA THE SENSE CIRCUIT.  
 IN APPLICATIONS REQUIRING PGM RTN CONNECTION TO POSITIVE OUTPUT, AN ISOLATION AMP IS REQUIRED.

Figure 3-1

A current shunt (R91) in the output return line develops a voltage dependent on the output current. This current information is compared to the setting of the front panel current limit control in the current control circuit (U4-1 and U15). The output voltage is also monitored and compared to the front panel voltage control setting in the voltage control circuit (U5). The outputs of the voltage and current control circuits are OR'd and this signal is fed into the PWM error amplifier inverting input providing the negative feedback required to produce a regulated output. The output voltage and current information from the current and voltage control circuits is also fed to the front panel A1 assembly where it is displayed on the digital voltage and current readouts.

Transformer T4, rectifier CR42 and regulators U9-U13 provide the necessary auxiliary supply voltages for the PWM circuit, the voltage and current control circuits, the A1 metering board and the raw DC supply for drive transformer T2. A 6.2 volt reference is also derived from the 12V supply for use in metering circuits by diode CR1 and resistor R2.

Transformers T1, T3 and T4 provide output isolation from the line potentials in the primary circuit, the PWM circuit and the auxiliary supply circuits respectively.

### 3.1.3 Detailed Circuit Description

This section is intended to provide further detail for troubleshooting purposes. Please read the previous section as an overview and then refer to the detailed assembly schematic in **Section 6**.

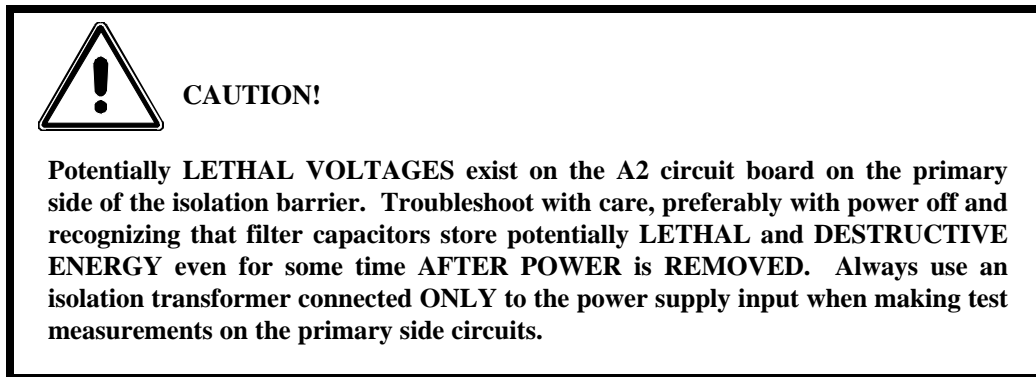

#### Input Rectifier and Inrush Limiting

Input ac power passes from the rear panel ac connector (TB1) through an RFI filter consisting of C1-6, R122, L1, and L2 to the front panel power switch. Both input lines are switched with one line (the neutral line of a 115Vac input) returning to the A2 PCB and the input rectifier CR35 via fuse F1. The other input line (the hot line of a 115Vac input) is connected to the remaining input of rectifier CR35 via front panel circuit breaker CB1, fuse F2 and the inrush limiter formed by resistor R116 and relay K1. Resistor R116 limits the power-on inrush current to the main filter capacitors C32(A,B,C) and C72(A,B,C) until it is shorted by K1 relay contacts. The time delay for K1 contact closure is determined by the time constant formed by capacitor C12, resistor R118 and the gate threshold of FET Q6. Diode CR38 discharges C12 when the 12V auxiliary supply collapses and CR39 provides an inductive kickback path for the relay coil. During the inrush period diode CR33 holds the PWM shutdown line high, disabling the power supply output until Q6 turns on. Resistors R114 and R115 are bleeder resistors for the main filter capacitors. The rectified high voltage dc from CR35 is supplied to the main switching FETs Q13-Q16 on the primary of the power transformer T1 via fuse F3.

For 230Vac operation rectifier CR35 and filter capacitors C32(A,B,C) and C72(A,B,C) are configured as a full wave bridge. For 115Vac operation the input voltage selector P1 is switched so that CR35, C32(A,B,C) and C72(A,B,C) form a voltage doubler. In addition to determining the input rectifier configuration P1 also switches the connections to the primary of auxiliary transformer T4.

### **Pulse Width Modulator**

Pulse width modulator U6 is a current mode controller which drives the main switching FETs Q13-Q16 through drive FETs Q7-Q12, Q18 and Q19 and drive transformer T2. Capacitor C69 and resistors R111-R113 form a snubber on the primary of transformer T1 limiting switching transients. Transformer T3 is used to monitor T1 primary current and provide a feedback signal for the current sense amplifier of U6. Diodes CR29 and CR30 rectify T3 output while resistors R66 and R95-R97 and capacitors C60-C62 and C64A scale and condition the signal before it is input to the PWM. An internal PWM comparator compares the output of the current sense amplifier with a limited error signal derived from the output voltage and current control circuits. The output of the PWM comparator controls the pulse duration of the drive signals from pins 11 and 14 of the PWM thereby controlling the primary current in T1 and the output power. Resistor R100 and capacitor C63 set the internal oscillator of U6 to approximately 140kHz, resulting in a 70kHz output switching frequency. A 5.1V reference developed at pin 2 of the PWM is divided down by resistors R64 and R67 to provide a reference at the non inverting input of the PWM error amplifier (pin 5). The 5.1V reference voltage is also divided by resistors R65 and R68 to provide a reference at pin 1 of the PWM which limits the swing of the error amplifier output placing an upper limit on the primary current in transformer T1.

### **Output Rectifier Circuit and Output Filter**

The DCS series uses two different configurations for the output rectifier. The 8V to 80V models use a full wave center tap configuration while the 150 to 600V models employ a full wave bridge. On 8V and 20V models the output rectifiers are one piece power tap units mounted on the rectifier heatsink with the secondary snubber components connected directly to the rectifier input terminals. The 33V to 600V models have their rectifier and snubber components on a separate printed circuit board which is mounted on a rectifier heatsink. Capacitors C51-C53, power inductor L3 and common mode inductor L4 form the main output filter on all models. On 8V to 80V models the secondary filter capacitors C401-C407 are on a separate PCB which is mounted on the output bus bar assembly. On 150V to 600V models the secondary filter capacitors C50, C50A, C50B, C50C, C48, C48A, C48B, C49, C49A, and C49B are mounted directly on the A2 PCB. Resistor R90 is an output pre-load which allows the unit to operate under no load or light load conditions.

### **Models DCS 8-125 and DCS 20-50**

On these models diodes CR301 and CR302 rectify the output of power transformer T1. Resistors R301-R304 and capacitors C301 and C302 form snubbers on the secondary of T1 to limit switching transients while resistors R305, R305A, R306 and R306A and capacitors C303 and C304 are used to provide additional rectifier snubbing on some models.

### **Models DCS 33-33, DCS 40-25, DCS 50-20, DCS 60-18 and DCS 80-13**

On these models diodes D1 and D2 rectify the output of power transformer T1. Resistors R2 and R3 and capacitors C3 and C4 form snubbers on the secondary of T1 to limit switching transients. Resistors R1 and capacitors C2 and C5 are used to provide additional rectifier snubbing.

**Models DCS 150-7, DCS 300-3.5 and DCS 600-1.7**

On DCS 150-7 and DCS 300-3.5, diodes CR301-CR304 form the rectifier bridge with resistors R301-R304 and capacitors C301-C304 providing snubbing for the diodes. Resistor R305 and capacitor C305 form the snubber on the secondary of transformer T1. Capacitor C306 provides bypassing on the output of the bridge.

On DCS 600-1.7, diodes CR300-CR307 form the rectifier bridge with resistors R302-R305 and capacitors C1,2,4-13 providing snubbing for the diodes. Resistor R300 and R301 and capacitor C303 form the snubber on the secondary of transformer T1. Capacitor C300 provides bypassing on the output of the bridge.

**Voltage Control Circuit**

The output voltage is monitored by the voltage control op amp U5 at pin 3 via the positive sense line (pin 13 of connector J3 on 8V to 80V models) and the resistor divider formed by R21, R22, R53, R85 and R147. This feedback voltage is compared with a 0-5V reference voltage gated from the front panel voltage control to pin 2 of U5 by U7-2 to provide an error signal for the PWM. If the output voltage tries to rise above the selected level the voltage at pin 3 rises and the output of U5 becomes more positive. This increase is applied to the inverting input of the PWM error amplifier through diode CR18 and resistor R69 causing the amplifier output to decrease. This reduces the PWM output drive waveform pulse width, lowering the output voltage and regulating the output at the desired level. Similarly, if the output voltage tries to fall below the selected level the voltage at pin 3 decreases, U5 output decreases, the output from the PWM error amplifier increases and the drive waveform pulse width increases which raises the output voltage to the desired level. During voltage mode operation the output of the current control circuit at U4-1 pin 1 remains low. Resistor R70 and capacitor C54 provide compensation for the op amp and diode CR21A limits saturation. Capacitor C20, resistor R54 and CMOS gate U7-3 provide a soft start for the power supply during initial startup and recovery from shut down conditions by delaying the voltage rise at pin 2 of U5. Resistor R21 supplies the front panel voltmeter with a voltage proportional to the output voltage through pin 6 of the J1 connector while a buffered 0-5V signal (uncalibrated) for remote monitoring of the output voltage is provided at pin 19 of connector J3. Potentiometer R53 is used to adjust the full scale output of the power supply and potentiometer R52 is used to adjust the offset on op amp U5.

**Current Control Circuit**

The output current is monitored by current shunt resistor R91 which develops a voltage across it proportional to the output current. This voltage is amplified and conditioned by the differential op amp U15 and associated components to provide a control ground referenced 0-2V signal at pin 3 of the current control op amp U4-1. This signal is compared to a reference signal gated from the front panel current control to pin 2 of U4-1 by U7-1. As the output current increases the voltage at pin 3 rises until it reaches the reference level set at pin 2 at which time the output of U4-1 goes high and the unit switches from voltage mode to current mode operation. The output current is maintained at the desired level by providing negative feedback to the PWM error amplifier as described in the voltage control circuit description above. Resistor R27 and capacitor C27 provide compensation for U4-1. Op amp U4-2 and related components scale the current feedback signal to provide a calibrated 0-5V output at pin 7 of connector J3 for external monitoring of the output current. The shunt voltage is also fed to the front panel ammeter via pins 8 and 9 of connector J1.

**Operating Mode Indicator Circuit**

Op amp U8-2 takes advantage of the fact that diode CR18 is forward biased during voltage mode and reverse biased during current mode to provide a mode indication signal at pin 7. This output is used to drive the back to back mode LEDs on the front panel through pin 1 of connector J1. In voltage mode U8-2 pin 7 is high and the green voltage mode led is illuminated. In current mode pin 7 is low and the red current mode led is illuminated.

### **Auxiliary Supply and 6.2V Reference Circuit**

Transformer T4, rectifier CR42 and capacitors C9 and C10 provide the raw dc supply voltages from which the +12V and +5V auxiliary supplies are derived by three terminal regulators U10 and U11 respectively. Two additional regulators (U12 and U13) provide the 12V feed to drive FETs Q7-Q12, Q18 and Q19 on the primary of T2, and the 12V feed to PWM U6. Diodes CR40 and CR41 with capacitors C7 and C11 provide the negative input to three terminal regulator U9 which supplies the -5V auxiliary output. Resistor R2 and Zener diode CR1 are used to derive a stable 6.2V reference from the +12V auxiliary supply for use on the front panel meters (via pin 5 of connector J1) and the A2 PCB. Transistor Q5, diode CR32, resistors R60-62 and Zener diode CR20 form a low voltage lock out which disables the power supply output by shutting down the PWM should the auxiliary raw supply fall below the threshold set by CR20.

### **Voltage and Current Control Current Sources**

Op amps U2-1 and U2-2, transistors Q1 and Q2, and related components are used to provide 1mA current sources for the front panel voltage and current controls. These current sources are also used for remote resistive programming of the output voltage and current limit.

### **Over Voltage Protection Circuit**

Op amp U3-1, transistor Q4 and related components provide a 1mA current source which is fed to the front panel OVP adjusting pot via the external jumper connecting pins 3 and 16 of connector J3, switch SW1-8 and pin 17 of connector J1. This current source and the OVP adjusting pot provide a 0-5V reference at pin 6 of U3-2, the OVP control op amp. The power supply output voltage is monitored at pin 5 of U3-2 through the resistor divider formed by R80, R89 and R148. When the output voltage increases such that the voltage at pin 5 becomes higher than that at pin 6 the output of U3-2 goes high activating MOSFET Q17 (via drive FET Q2A) which clamps the power supply output off through resistor R93. Diode CR25 latches U3-2 on while diodes CR23 and CR24 gate the high signal to the shutdown pin of the PWM. The OVP indicator on the front panel is biased on via pin 15 of connector J1 when the OVP is activated. The OVP may be reset by cycling the power switch off and then back on to release the latch provided by CR25 or by momentarily activating the remote shutdown circuit which causes pin 6 to be pulled high through diode CR10.

During remote voltage programming of the OVP trip level the internal 1mA current source is disconnected by removing the jumper connecting pin 3 and 16 of connector J3 and the reference voltage at pin 6 of U3-2 is provided directly by the external voltage source. Switch SW1-4 is used to select the programming range; 0-5V (with the switch closed) or 0-10V (with the switch open). For current programming the internal 1mA current source is replaced with a 0-1mA external source to provide the required 0-5V reference signal. For resistive programming switch SW1-8 is opened to disconnect the front panel adjusting potentiometer and the internal 1mA current source is connected to the external 0-5k ohm potentiometer to provide the 0-5V reference.

### **Remote ON/OFF Circuit**

A TTL high signal applied between pins 14 (positive) and 2 (negative) of connector J3 activates opto coupler U1 which turns on transistor switch Q3 by pulling its base low. This applies 12V through diode CR11 to the shutdown pin of the PWM thereby shutting down the power supply output. A 12-250Vac or 12-130Vdc signal applied between pins 1 (positive) and 2 (negative) of connector J3 will also activate U1 and disable the power supply output. Diode CR14 rectifies ac inputs while resistors R37 and R38 limit the current through the opto coupler. Diode CR13 provides protection against reverse polarity TTL signals.



### **Remote Programming of the Output Voltage**

During remote programming of the output voltage with an external voltage source (0-5V or 0-10V) the local operation jumpers connecting J3 pins 8 to 9 and 20 to 21 are removed and the external source is connected between pins 9 (positive) and 12 (negative) of connector J3. The input signal at J3 pin 9 is buffered via U14-2 to provide noise immunity. When using a 0-5V source the reference at pin 2 of U5 (voltage control op amp) is provided directly by the external source. When using a 0-10V source switch SW1-3 is closed to provide the necessary voltage divider to scale the reference voltage to 0-5V.

For remote programming with an external 5k resistance the jumpers connecting J3 pins 8 to 9 and 20 to 21 are removed, pins 9 and 21 are connected to the counterclockwise end of the external 5k ohm potentiometer and the tap and clockwise end are connected to pin 12. The internal 1mA current source at pin 21 develops a 0-5V potential across the potentiometer, depending on the potentiometer setting, which is fed to pin 2 of U5.

During remote programming of the output voltage with an external 0-1mA current source the jumper connecting J3 pins 20 and 21 is removed, the front panel voltage control is set fully clockwise and the external current source is connected between pins 8 (positive) and 12 (return). Varying the current source from 0-1mA causes 0-5V to develop at the reference pin of the voltage control circuit.

The front panel remote programming indicator is controlled by op amp U8-4. Resistors R55 and R56 form a voltage divider with the 6.2V reference which develops a nominal 0.3V at pin 12 (the non-inverting input) of the op amp. During local operation current flow through diode CR15 and the front panel voltage control provides a higher voltage at pin 13 (the inverting input) keeping U8-4 output low. During remote programming there is no current flow through diode CR15 and the output of U8-4 goes high illuminating the remote programming indicator through diode CR4, resistor R13 and pin 13 of connector J1. The high signal is also provided at pin 4 of connector J3 for remote monitoring purposes.

### **Remote Programming of the Output Current Limit**

During remote programming of the output current limit with an external voltage source the local operation jumpers connecting J3 pins 10 to 11 and 22 to 23 are removed and the external source (0-100mV, 0-5V or 0-10V) is connected between pins 10 (positive) and 12 (negative). The input signal at J3 pin 10 is buffered via U14-1 to provide noise immunity. When using a 0-5V source the reference at pin 2 of U4-1 (current control op amp) is provided by the external source and divided down to a 0-2V reference by R20 and R146. Use of a 0-10V source requires that switch SW1-1 be closed to add R5 to the voltage divider to limit the control circuit reference voltage to 0-2V. For 0-100mV, programming switch SW1-1 is opened and switch SW1-2 is closed, changing U14-1 from a voltage follower to an amplifier by virtue of feedback resistor R150 and voltage divider resistor R50.

For remote programming with an external 5k resistance the jumpers connecting J3 pins 10 to 11 and 22 to 23 are removed, pins 10 and 22 are connected to the counterclockwise end of the external 5k ohm potentiometer and the tap and clockwise end are connected to pin 12. The internal 1mA current source at pin 22 develops a 0-5V potential across the potentiometer, depending on the potentiometer setting, which is fed to pin 6 of U4-2.

During remote programming of the output voltage with an external 0-1mA current source the jumper connecting J3 pins 22 and 23 is removed, the front panel voltage control is set fully clockwise and the external current source is connected between pins 11 (positive) and 12 (return). Varying the current source from 0-1mA causes 0-5V to develop at the reference pin of the current control circuit.

The front panel remote programming indicator is controlled by op amp U8-1 during remote current limit programming. Operation is the same as that described above in the remote voltage programming section except that diode CR15 is replaced by diode CR16.

## 3.2 Meter Circuit (A1 Assembly)

The A1 assembly is comprised of the voltmeter and ammeter displays, the output voltage and current limit controls, the local operation OVP adjusting potentiometer and the indicator LEDs. The operation of the voltage and current controls, the OVP potentiometer and the indicator LEDs is covered in the A2 description in Section 3.1. Refer to the schematic diagram in Section 6 for the following discussion.

### 3.2.1 Voltmeter

U2 is a 3 1/2 digit analog to digital converter which converts the analog input from the A2 board voltage control circuit to a digital display on seven segment displays DS5-DS8 (maximum display is 1999). The 6.2V reference from pin 5 of connector J1 is divided down by resistors R16 and R17 and potentiometer R18 to provide the reference for the converter. The analog input from the voltage control circuit (via pin 6 of connector J1) is filtered by resistor R9 and capacitor C14 before it is input to pin 31 of the converter. Capacitor C12 and resistor R7 set the conversion frequency to approximately 3 times per second. Resistors R8, R11 and R12 are used to select the appropriate decimal point position depending on the model of the power supply.

### 3.2.2 Current Meter

The current meter circuit operates in the same manner as the voltage meter circuit with U1 performing the conversion for display on DS1-DS4. Capacitors C4 and C6 provide additional filtering on the meter analog input. Resistors R2, R5 and R6 are used to select the appropriate decimal point.

## **SECTION 4. MAINTENANCE, TROUBLESHOOTING, AND CALIBRATION**

### **4.1 General**

This section provides periodic maintenance, calibration and troubleshooting information.

### **4.2 Periodic Service**

No routine service except for periodic cleaning is required. Whenever a unit is removed from service, it should be cleaned, using denatured or isopropyl alcohol or an equivalent solvent on the metal surfaces and a weak solution of soap and water for the front panel. Low pressure compressed air may be used to blow dust from in and around components on the printed circuit boards.

### **4.3 Troubleshooting**

Units requiring repair during their warranty period should be returned to Sorensen for service. Unauthorized repairs performed by anyone other than Sorensen Company during the warranty period may void the warranty. Any questions regarding repair should be directed to the Service Department, Sorensen Company, Division of Elgar Company.



**CAUTION!** 

**POTENTIALLY LETHAL VOLTAGES EXIST IN THE POWER CIRCUIT AND THE OUTPUT OF HIGH VOLTAGE MODELS.** Filter capacitors store potentially dangerous energy for some time after power is removed. Repairs should be attempted by experienced technical personnel only. Be sure to isolate the power supply from the input line with an isolation transformer when using grounded test equipment such as an oscilloscope in the power circuit.

#### **4.3.1 Preliminary Checks**

If the power supply displays any unusual or erratic operation shut the power supply off immediately and disconnect it from the AC power source. Check all load, programming and monitoring connections and circuits. Check the AC input for correct voltage and frequency. Correct any problems found and retest the system. If no problems are found or the unit fails to operate correctly upon retesting proceed with internal troubleshooting as described below.

**4.3.2 Internal Troubleshooting** 

After reading the caution in **Section 4.3** and completing the preliminary checks described in **Section 4.3.1**, remove the cover and proceed with internal troubleshooting using the information contained in **Figure 4-1** as a guide to isolate the problem to a specific area of the circuit. Refer to the schematics in **Section 6** and the theory of operation in **Section 3** for additional information.

**4.4 Calibration**

Calibration on both the A1 and A2 assemblies is accomplished using multiturn trim pots. The list below gives the circuit designation of the trim pot and the parameter affected by that part. Calibration is performed at the factory during testing and recalibration should be unnecessary unless major repairs are required. Calibration should be done with the cover on through the access holes in the cover. See **Figure 4-2** below.

<b>CIRCUIT DESIGNATION</b>	<b>ASSEMBLY</b>	<b>PARAMETER AFFECTED</b>
R7	A2	Output Current Monitor Calibration
R46	A2	Output Current Monitor Offset
R47	A2	Current Control Circuit Offset
R48	A2	Output Current Range
R52	A2	Voltage Control Circuit Offset
R53	A2	Output Voltage Range
R18	A1	Front Panel Voltmeter Calibration
R15	A1	Front Panel Ammeter Calibration
R8	M15 Option Board	Program Range Adjust
R11	M15 Option Board	Program Offset Adjust

**NOTE:** Consult the factory for full calibration requirements.

**TROUBLESHOOTING GUIDE**

**CAUTION**  
 READ SECTION 4.3 BEFORE PROCEEDING AND PERFORM THE PRELIMINARY CHECKS IN SECTION 4.3.1

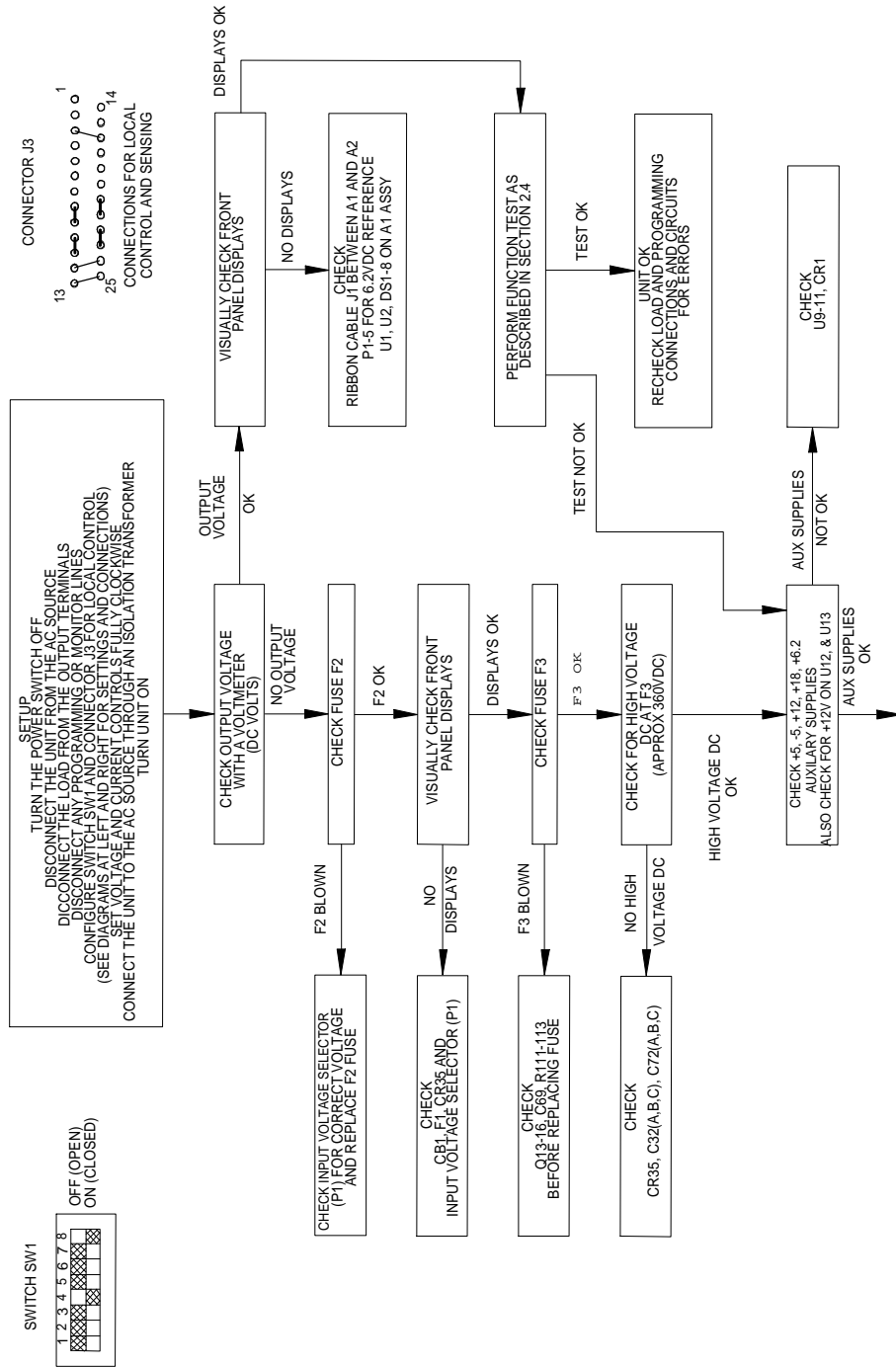

To Figure 4-1B

Figure 4-1A

From Figure 4-1A

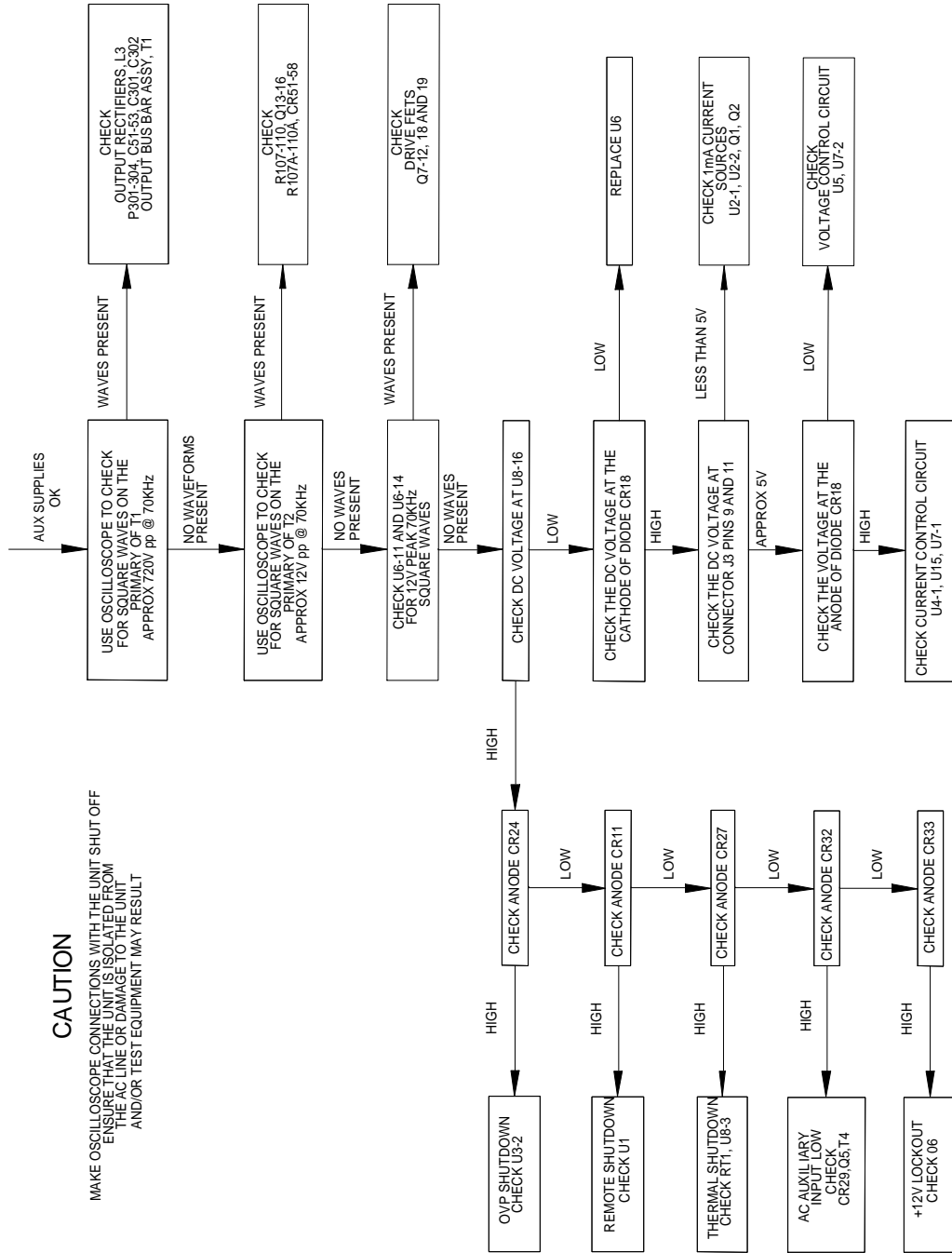

Figure 4-1B

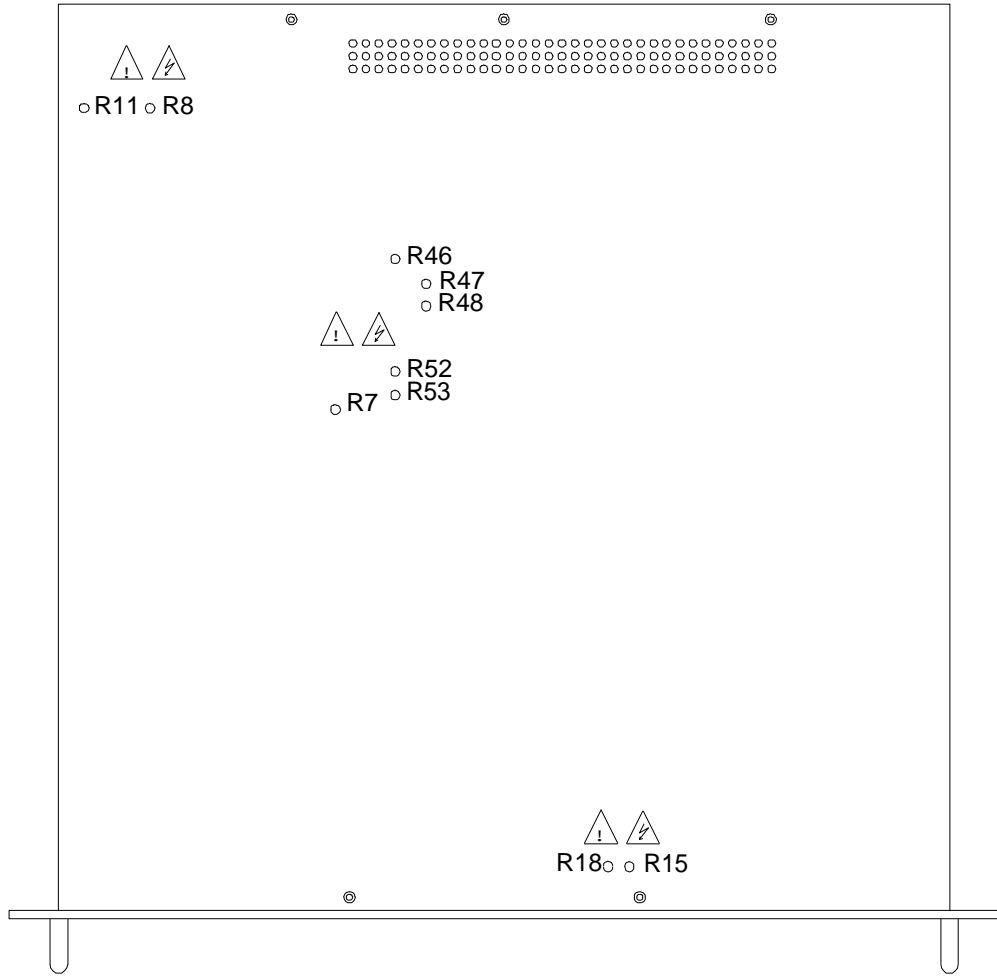

Figure 4-2



Refer to “About This Manual” for an explanation of these symbols.

This Page Intentionally Left Blank



## **SECTION 5. PARTS LISTS**

### **5.1 General**

This section provides parts lists for the following assemblies:

- A1 - Front panel assembly
- A2 - Power assembly
- - Chassis and cover

Most assemblies consist of parts common to all series models as well as parts which are model-specific, or differential.

### **5.2 Parts Ordering**

Do not substitute parts without first checking with Sorensen's Service Department. Parts may be ordered from the factory with the information in the following sections. Order parts from:

SORENSEN  
Division of **ELGAR**  
6255 Ferris Square  
San Diego, CA 92121-2294

Sales  
Tel 1-800-525-2024  
Fax (858) 458-0267

Customer Service  
Tel 1-800-458-4258  
Fax (858) 677-9453

When ordering parts please include the model number and serial number of the unit with your order.

### **5.3 Parts Lists**

Table 5-1 provides a listing of Fuse Ratings, Table 5-2 provides a listing of the Parts Lists included in this section and Table 5-3 provides a Parts List by Model Number matrix.

**Table 5-1. DCS 1kW Fuse Rating**

<b>Reference Designator</b>	<b>Fuse Type</b>	<b>Rating</b>	<b>Size</b>
F1	Fast Acting, 3AB	20A, 250V	1/4" x 1-1/4"
F2	Time Lag, 3AG	0.5A, 250V	1/4" x 1-1/4"
F3	Fast Acting	10A, 250V	13/32" x 1-1/2"

**Table 5-2. DCS 1 kW Parts Lists**

<b>Number</b>	<b>Assembly</b>
1066830-008	Output PCB Assembly
1066830-01	Output PCB Assembly
1066830-020	Output PCB Assembly
1066830-080	Output PCB Assembly
5360726-01	Rectifier PCB Assembly
5360726-02	Rectifier PCB Assembly
5360726-03	Rectifier PCB Assembly
5360726-04	Rectifier PCB Assembly
5360800-01	Final Assembly
5360800-02	Final Assembly
5360800-03	Final Assembly
5360800-04	Final Assembly
5360800-05	Final Assembly
5360800-06	Final Assembly
5360800-07	Final Assembly
5360800-08	Final Assembly
5360800-09	Final Assembly
5360800-10	Final Assembly
5360801-01	Front Panel PCB Assembly
5360801-02	Front Panel PCB Assembly
5360802-01	Mother PCB Assembly
5360802-02	Mother PCB Assembly

**Table 5-3. DCS 1 kW Parts Lists By Model Number**

	<b>Final Assembly</b>	<b>Mother PCB Assembly</b>	<b>Front Panel PCB Assembly</b>	<b>Output PCB Assembly</b>	<b>Rectifier PCB Assembly</b>
<b>Model DCS8-125E</b>	5360800-01	5360802-01	5360801-01	1066830-008	N/A
<b>Model DCS20-50E</b>	5360800-02	5360802-01	5360801-02	1066830-020	N/A
<b>Model DCS33-33E</b>	5360800-03	5360802-01	5360801-02	1066830-01	5360726-01
<b>Model DCS40-25E</b>	5360800-04	5360802-01	5360801-02	1066830-01	5360726-02
<b>Model DCS50-20E</b>	5360800-10	5360802-01	5360801-02	1066830-01	5360726-02
<b>Model DCS60-18E</b>	5360800-05	5360802-01	5360801-02	1066830-01	5360726-03
<b>Model DCS80-13E</b>	5360800-06	5360802-01	5360801-02	1066830-080	5360726-04
<b>Model DCS150-7E</b>	5360800-07	5360802-02	5360801-01	N/A	N/A
<b>Model DCS300-3.5E</b>	5360800-08	5360802-02	5360801-01	N/A	N/A
<b>Model DCS600-1.7E</b>	5360800-09	5360802-02	5360801-01	N/A	N/A

## **SECTION 6. DRAWINGS AND SCHEMATICS**

### **6.1 General**

This section contains drawings and schematic diagrams for the DCS 1 kW power supply. The schematic diagrams should be used to understand the theory of operation and also be used as an aid in troubleshooting the unit.

### **6.2 Drawings and Schematics**

Table 6-1 provides a listing of the Drawings and Schematics included in this section and Table 6-2 provides a Drawings/Schematics by Model Number matrix.

**Table 6-1. DCS 1 kW Drawings/Schematics**

<b>Number</b>	<b>Assembly</b>
1066830	Output PCB Assembly Drawing
1066832	Rectifier PCB Assembly Drawing
1068573	Rectifier PCB Assembly Drawing
5360726	Rectifier PCB Assembly Drawing
5360800	Final Assembly Drawing
5360801	Front Panel PCB Assembly Drawing
5360802	Mother PCB Assembly Drawing
6360726	Rectifier PCB Schematic
6360801	Front Panel PCB Schematic
6360802	Mother PCB Schematic

**Table 6-2. DCS 1 kW Drawings/Schematics By Model Number**

	<b>Final Assembly Drawing</b>	<b>Mother PCB Assembly Drawing</b>	<b>Mother PCB Schematic</b>	<b>Front Panel PCB Assembly Drawing</b>	<b>Front Panel PCB Schematic</b>	<b>Output PCB Assembly Drawing</b>	<b>Rectifier PCB Assembly Drawing</b>	<b>Rectifier PCB Schematic</b>
<b>Model DCS8-125E</b>	5360800	5360802	6360802	5360801	6360801	1066830	N/A	N/A
<b>Model DCS20-50E</b>	5360800	5360802	6360802	5360801	6360801	1066830	N/A	N/A
<b>Model DCS33-33E</b>	5360800	5360802	6360802	5360801	6360801	1066830	5360726	6360726
<b>Model DCS40-25E</b>	5360800	5360802	6360802	5360801	6360801	1066830	5360726	6360726
<b>Model DCS50-20E</b>	5360800	5360802	6360802	5360801	6360801	1066830	5360726	6360726
<b>Model DCS60-18E</b>	5360800	5360802	6360802	5360801	6360801	1066830	5360726	6360726
<b>Model DCS80-13E</b>	5360800	5360802	6360802	5360801	6360801	1066830	5360726	6360726
<b>Model DCS150-7E</b>	5360800	5360802	6360802	5360801	6360801	1066830	1066832	N/A
<b>Model DCS300-3.5E</b>	5360800	5360802	6360802	5360801	6360801	1066830	1066832	N/A
<b>Model DCS600-1.7E</b>	5360800	5360802	6360802	5360801	6360801	1066830	1068573	N/A