



**Advanced Test Equipment Rentals**  
**www.atecorp.com 800-404-ATEC (2832)**

**OPERATING AND SERVICE MANUAL**

# **SIGNAL GENERATOR**

## **8640B**

### **SERIAL NUMBERS**

This manual applies directly to instruments with serial numbers prefixed 1324A.

With changes described in Section VII, this manual also applies to instruments with serial numbers prefixed 1229A, 1244A, 1245A, 1246A, 1249A, 1251A, 1303A, 1310A, 1313A, 1316A, 1322A, and 1323A.

For additional important information about serial numbers see INSTRUMENTS COVERED BY MANUAL in Section I.

Copyright      HEWLETT-PACKARD COMPANY      1974  
1501 PAGE MILL ROAD, PALO ALTO, CALIFORNIA, U.S.A.

MANUAL PART NO. 08640-90017  
Operating Information Supplement Part No. 08640-90018  
Microfiche Part No. 08640-90019

Printed: JANUARY 1974

CONTENTS

Section	Page	Section	Page
<b>I GENERAL INFORMATION . . . . .</b>	<b>1-1</b>	<b>4-16. Frequency Stability Vs Load, Level, and Mode Test . . . . .</b>	<b>4-9</b>
1-1. Introduction . . . . .	1-1	4-17. Harmonics Test . . . . .	4-11
1-7. Instruments Covered by Manual . . . . .	1-1	4-18. Sub-Harmonics and Non-Harmonic Spurious Test . . . . .	4-13
1-12. General Description . . . . .	1-2	4-19. Single Sideband Phase Noise Test . . . . .	4-15
1-17. Performance Characteristics . . . . .	1-2	4-20. Single Sideband Broadband Noise Floor Test . . . . .	4-17
1-18. Spectral Purity . . . . .	1-2	4-21. Residual AM Test . . . . .	4-20
1-24. Frequency Counter . . . . .	1-3	4-22. Residual FM Test . . . . .	4-21
1-29. Phase-Lock Mode . . . . .	1-3	4-23. Output Level Accuracy Test (Abbreviated) . . . . .	4-24
1-35. Amplitude Modulation . . . . .	1-4	4-24. Output Level Accuracy Test (Complete) . . . . .	4-29
1-38. Pulse Modulation . . . . .	1-4	4-25. Output Level Flatness Test . . . . .	4-36
1-41. Frequency Modulation . . . . .	1-4	4-26. Output Impedance Test (In Band) . . . . .	4-37
1-44. Standard and Optional Audio Oscillators . . . . .	1-5	4-27. Output Impedance Test (Out of Band) . . . . .	4-39
1-47. Multi-function Meter and Annunciators . . . . .	1-5	4-28. Auxiliary Output Test . . . . .	4-41
1-53. Output Level . . . . .	1-5	4-49. Output Leakage Test . . . . .	4-42
1-57. Options . . . . .	1-6	4-30. Internal Modulation Oscillator Test . . . . .	4-44
1-62. Accessories Supplied . . . . .	1-6	4-31. Internal Modulation Oscillator Distortion Test (Option 001) . . . . .	4-45
1-66. Equipment Available . . . . .	1-6	4-32. AM 3 dB Bandwidth Test . . . . .	4-47
1-73. Warranty . . . . .	1-7	4-33. AM Distortion Test . . . . .	4-49
1-75. Test Equipment Required . . . . .	1-7	4-34. AM Sensitivity and Accuracy Test . . . . .	4-50
<b>II INSTALLATION . . . . .</b>	<b>2-1</b>	4-35. Peak Incidental Phase Modulation Test . . . . .	4-54
2-1. Introduction . . . . .	2-1	4-36. Pulse Modulation Test . . . . .	4-56
2-3. Initial Inspection . . . . .	2-1	4-37. Pulse On/Off Ratio Test . . . . .	4-60
2-5. Preparation for Use . . . . .	2-1	4-38. FM 3 dB Bandwidth Test . . . . .	4-61
2-6. Power Requirements . . . . .	2-1	4-39. FM Distortion Test . . . . .	4-62
2-8. Line Voltage Selection . . . . .	2-2	4-40. FM Sensitivity and Accuracy Test . . . . .	4-64
2-11. Power Cable . . . . .	2-2	4-41. Incidental AM Test . . . . .	4-68
2-13. Mating Connectors . . . . .	2-3	4-42. Counter External Sensitivity Test . . . . .	4-70
2-15. Operating Environment . . . . .	2-3	4-43. Internal Reference Accuracy Test . . . . .	4-71
2-18. Bench Operation . . . . .	2-3	4-44. Internal Reference Drift Rate (Stability) Test . . . . .	4-72
2-20. Rack Mounting . . . . .	2-3	4-45. Phase Lock Restabilization Time Test . . . . .	4-75
2-22. Storage and Shipment . . . . .	2-3	<b>V ADJUSTMENTS . . . . .</b>	<b>5-1</b>
2-23. Environment . . . . .	2-3	5-1. Introduction . . . . .	5-1
2-25. Packaging . . . . .	2-3	5-3. Safety Considerations . . . . .	5-1
<b>III OPERATION . . . . .</b>	<b>3-1</b>	5-9. Test Equipment Required . . . . .	5-1
3-1. Introduction . . . . .	3-1	5-11. Posidriv Screwdrivers . . . . .	5-1
3-3. Panel Features . . . . .	3-1	5-13. Blade Tuning Tools . . . . .	5-1
3-5. Operator's Checks . . . . .	3-1	5-15. Service Aids . . . . .	5-1
3-7. Operating Instructions . . . . .	3-1	5-19. Factory Selected Components . . . . .	5-2
3-9. Operator's Maintenance . . . . .	3-1	5-22. Post-Repair Test and Adjustments . . . . .	5-3
<b>IV PERFORMANCE TESTS . . . . .</b>	<b>4-1</b>	5-25. Power Supply Adjustments . . . . .	5-8
4-1. Introduction . . . . .	4-1	5-26. Fixed-Frequency Modulation Oscillator Adjustment . . . . .	5-8
4-3. Equipment Required . . . . .	4-1	5-27. Variable-Frequency Modulation Oscillator Adjustment (Option 001). . . . .	5-9
4-5. Test Record . . . . .	4-1	5-28. Meter Adjustments . . . . .	5-12
4-7. Test Procedures . . . . .	4-1	5-29. RF Detector Offset Adjustment . . . . .	5-12
4-11. Frequency Range Test . . . . .	4-2	5-30. Output Level Knob Adjustment . . . . .	5-13
4-12. Frequency Accuracy and Fine Tune Test . . . . .	4-3		
4-13. Frequency Stability Vs Time and Restabilization Time Test . . . . .	4-5		
4-14. Frequency Stability Vs Temperature Test . . . . .	4-7		
4-15. Frequency Stability Vs Line Voltage Test . . . . .	4-8		

## CONTENTS

Section	Page	Section	Page
5-31. Output Level Vernier and Meter Adjustment . . . . .	5-14	7-28. Replacement A7 FM Shaping Assembly (Serial Prefix 1246A and Below) . . . . .	7-22
5-32. AM Sensitivity Adjustment . . . . .	5-17	7-31. Replacement A9 Peak Deviation and Range Switch Assembly (Serial Prefix 1246A and Below) . . . . .	7-22
5-33. Peak Deviation and Range Switch Adjustment . . . . .	5-19	7-34. A10A1 RF Filter Assembly Switch Improvement (Serial Prefix 1246A and Below) . . . . .	7-24
5-34. Range Switch Adjustment . . . . .	5-20	7-36. A8A1 RF Scaler Assembly Improvement (Serial Prefix 1249A) . . . . .	7-24
5-35. $V_T$ Pot (A3R1) Adjustment . . . . .	5-21	7-38. A5 FM Amplifier Assembly Improvement (Serial Prefix 1251A and Below) . . . . .	7-24
5-36. $V_T$ Voltage Adjustment . . . . .	5-22	7-40. A8A2 Counter/Lock Board Assembly Improvement (Serial Prefix 1251A and Below) . . . . .	7-24
5-37. RF Filter Adjustment . . . . .	5-23	7-42. Front Panel Meter M1 Replacement (Serial Prefix 1251A and Below) . . . . .	7-24
5-38. Preliminary FM Adjustments . . . . .	5-27	7-44. A26 AM/AGC and RF Amplifier Assembly Improvement (Serial Prefix 1303A and Below) . . . . .	7-25
5-39. FM Linearity Adjustment . . . . .	5-29	7-46. A26A4 AGC Amplifier Assembly Improvement (Serial Prefix 1310A and Below) . . . . .	7-25
5-40. FM Sensitivity Adjustment . . . . .	5-32	7-48. A10A2 RF Divider Assembly Improvement (Serial Prefix 1313A and Below) . . . . .	7-26
5-41. Internal Reference Frequency Adjustment . . . . .	5-34	7-50. Power Supply Improvement (Serial Prefix 1313A and Below) . . . . .	7-27
<b>VI REPLACEABLE PARTS . . . . .</b>	<b>6-1</b>	7-52. A10A2 RF Divider Assembly Improvement (Serial Numbers 1316A00464 and Below) . . . . .	7-27
6-1. Introduction . . . . .	6-1	7-54. Improved Audio Output Level Flatness (Serial Prefixes 1244A through 1316A) . . . . .	7-27
6-3. Exchange Assemblies . . . . .	6-1	7-56. A8A4 Counter Display Assembly Improvement (Serial Prefixes 1323A and Below) . . . . .	7-27
6-5. Abbreviations . . . . .	6-1	<b>VIII SERVICE . . . . .</b>	<b>8-1</b>
6-7. Replaceable Parts List . . . . .	6-1	8-1. Introduction . . . . .	8-1
6-11. Ordering Information . . . . .	6-1	8-5. Principles of Operation . . . . .	8-1
6-14. Spare Parts Kit . . . . .	6-1	8-8. Troubleshooting . . . . .	8-1
6-16. Illustrated Parts Breakdowns . . . . .	6-2	8-12. Recommended Test Equipment . . . . .	8-1
<b>VII MANUAL CHANGES . . . . .</b>	<b>7-1</b>	8-14. Service Aids . . . . .	8-1
7-1. Introduction . . . . .	7-1	8-23. Repair . . . . .	8-3
7-3. Manual Changes . . . . .	7-1	8-24. Factory Selected Components . . . . .	8-3
7-6. Manual Change Instructions . . . . .	7-4	8-26. Etched Circuits . . . . .	8-3
7-7. Instrument Improvement Modifications . . . . .	7-19	8-28. Etched Conductor Repair . . . . .	8-3
7-9. Improved FM Metering Accuracy (Serial Prefix 1229A) . . . . .	7-19	8-30. Component Replacement . . . . .	8-3
7-11. Elimination of Frequency Shift in Expand X100 Mode (Serial Prefix 1229A) . . . . .	7-19	8-37. Illustrated Parts Breakdowns . . . . .	8-5
7-14. A8A2 Counter/Lock Board Assembly Improvements (Serial Prefix 1229A) . . . . .	7-19	8-39. Basic Circuit Theory . . . . .	8-5
7-16. Improved Audio Output Level Accuracy (Serial Prefix 1229A) . . . . .	7-21		
7-18. A26A1 Power Amplifier and AGC Detector Assembly Improvement (Serial Prefix 1229A) . . . . .	7-21		
7-20. Reduction of RFI Leakage from Front Panel (Serial Prefix 1244A and Below) . . . . .	7-21		
7-23. A26A4 AGC Amplifier Assembly Improvement (Serial Prefix 1245A and Below) . . . . .	7-22		
7-26. Reduction of RFI Leakage from RF Oscillator (Serial Prefix 1246A and Below) . . . . .	7-22		

**CONTENTS**

Section	Page	Section	Page
8-40. Binary Circuits and Symbols . . . . .	8-5	8-57. Binary Shift Register . . . . .	8-8
8-52. Binary Registers . . . . .	8-8	8-61. Decade Counters and Symbols . . . . .	8-9
8-53. Binary Latch . . . . .	8-8	8-69. Linear Integrated Circuits . . . . .	8-11

**TABLES**

Table	Page	Table	Page
1-1. Specifications . . . . .	1-8	7-2. Summary of Changes by Component . . . . .	7-2
1-2. Recommended Test Equipment . . . . .	1-13	8-1. Etched Circuit Soldering Equipment . . . . .	8-4
1-3. Recommended Test Accessories . . . . .	1-20	8-2. Logic Levels . . . . .	8-6
4-1. Performance Test Record . . . . .	4-77	8-3. Assembly Information Index . . . . .	8-14
4-2. Recommended Test Abridgements . . . . .	4-85	8-4. Schematic Diagram Notes . . . . .	8-15
5-1. Factory Selected Components . . . . .	5-2	8-5. Meter Drive Amplifier Data . . . . .	8-52
5-2. Post-Repair Test and Adjustments . . . . .	5-4	8-6. Total Count of Time Base Reference Counters U13, U14, and U15 . . . . .	8-56
5-3. RF Filter Check . . . . .	5-26	8-7. Count Modes of Counters A8A3U13 and U14 . . . . .	8-56
6-1. Part Numbers for Exchange Assemblies . . . . .	6-2	8-8. Count Modes of Counter A8A3U15 . . . . .	8-56
6-2. Reference Designations and Abbreviations . . . . .	6-3	8-9. Data Inputs of Decimal Point Shift Register . . . . .	8-56
6-3. Replaceable Parts . . . . .	6-5		
6-4. Code List of Manufacturers . . . . .	6-42		
7-1. Manual Changes by Serial Number . . . . .	7-1		

**ILLUSTRATIONS**

Figure	Page	Figure	Page
1-1. HP Model 8640B Signal Generator (Option 001) and Accessories Supplied . . . . .	1-0	4-3. Frequency Stability vs Line Voltage Test Setup . . . . .	4-8
1-2. Measured Single Sideband Noise vs Offset from Carrier . . . . .	1-2	4-4. Frequency Stability vs Load, Level, and Mode Test Setup . . . . .	4-10
1-3. Specified Signal-to-Phase Noise Ratio . . . . .	1-3	4-5. Sub-Harmonics and Non-Harmonic Spurious Test Setup . . . . .	4-14
1-4. AM Distortion vs AM Rate . . . . .	1-4	4-6. Single Sideband Phase Noise Test Setup . . . . .	4-15
1-5. Pulsed RF . . . . .	1-4	4-7. Single Sideband Broadband Noise Floor Test Setup . . . . .	4-18
1-6. FM Distortion vs FM Rate . . . . .	1-5	4-8. Residual AM Test Setup . . . . .	4-20
1-7. 520 MHz Notch Filter . . . . .	1-21	4-9. Residual FM Test Setup . . . . .	4-22
1-8. FM Linearity Circuit . . . . .	1-21	4-10. Output Level Accuracy Test Setup (Abbreviated) . . . . .	4-25
1-9. Noise Phase Lock Circuit . . . . .	1-22	4-11. Output Level Accuracy Test Setup (Complete) . . . . .	4-31
2-1. Line Selector . . . . .	2-1	4-12. Output Level Flatness Test Setup . . . . .	4-36
2-2. Power Cables Available . . . . .	2-2	4-13. Output Impedance Test Setup (In Band) . . . . .	4-38
2-3. Preparation for Rack Mounting . . . . .	2-4	4-14. Output Impedance Test Setup (Out of Band) . . . . .	4-40
3-1. Lamp Replacement . . . . .	3-1	4-15. Output Leakage Test Setup . . . . .	4-42
3-2. Front Panel Controls, Indicators, and Connectors . . . . .	3-2	4-16. Internal Modulation Oscillator Test Setup . . . . .	4-44
3-3. Rear Panel Controls and Connectors . . . . .	3-6	4-17. Internal Modulation Oscillator Distortion Test Setup . . . . .	4-46
3-4. Operator's Checks . . . . .	3-7	4-18. AM 3 dB Bandwidth Test Setup . . . . .	4-47
3-5. Setting the Frequency and Amplitude Controls . . . . .	3-12	4-19. AM Distortion Test Setup . . . . .	4-49
3-6. Setting the Modulation Controls . . . . .	3-15	4-20. AM Sensitivity and Accuracy Test Setup . . . . .	4-51
4-1. Frequency Stability vs Time and Restabilization Time Test Setup . . . . .	4-5	4-21. Peak Incidental Phase Modulation Test Setup . . . . .	4-54
4-2. Frequency Stability vs Temperature Test Setup . . . . .	4-7	4-22. Pulse Modulation Test Setup . . . . .	4-57



## ILLUSTRATIONS (Cont'd)

Figure	Page	Figure	Page
4-23. Pulse Measurements . . . . .	4-58	8-4. Triggered Flip-Flop . . . . .	8-7
4-24. FM 3 dB Bandwidth Test Setup . . . . .	4-61	8-5. D Flip-Flop . . . . .	8-7
4-25. FM Distortion Test Setup . . . . .	4-63	8-6. Schmitt Trigger . . . . .	8-7
4-26. FM Sensitivity and Accuracy Test Setup . . . . .	4-65	8-7. J/K Flip-Flop . . . . .	8-8
4-27. Incidental AM Test Setup . . . . .	4-68	8-8. Multiple Input J/K Flip-Flop . . . . .	8-8
4-28. Counter External Sensitivity Test Setup . . . . .	4-70	8-9. Binary Latch . . . . .	8-9
4-29. Internal Reference Accuracy Test Setup . . . . .	4-71	8-10. Binary Shift Register . . . . .	8-9
4-30. Internal Reference Drift Rate (Stability) Test Setup . . . . .	4-73	8-11. Basic Decade Counter (Scaler) . . . . .	8-9
5-1. Output Level Vernier and Meter Adjustment Test Setup . . . . .	5-15	8-12. Programmable Counter . . . . .	8-10
5-2. AM Sensitivity Adjustment Test Setup . . . . .	5-17	8-13. Programmable Up/Down Counter . . . . .	8-12
5-3. $V_T$ Pot Adjustment . . . . .	5-21	8-14. Operational Amplifier . . . . .	8-13
5-4. Filter Terminology . . . . .	5-23	8-15. Comparator . . . . .	8-14
5-5. RF Filter Adjustment Test Setup . . . . .	5-24	8-16. Overall Block Diagram . . . . .	8-19
5-6. 256-512 MHz High Band Capacitor Adjustment Orientation . . . . .	5-27	8-17. FM Circuits and RF Oscillator Block Diagram . . . . .	8-21
5-7. FM Linearity Adjustment Test Setup . . . . .	5-30	8-18. AM/AGC Circuits and Output Amplifier Block Diagram . . . . .	8-23
5-8. FM Linearity Display . . . . .	5-32	8-19. Counter/Lock Circuits Block Diagram . . . . .	8-25
5-9. FM Sensitivity Adjustment Test Setup . . . . .	5-33	8-20. P/O A3A4 Connector Board Assembly Component Locations . . . . .	8-27
5-10. Internal Reference Frequency Adjustment Test Setup . . . . .	5-35	8-21. RF Oscillator Simplified Diagram . . . . .	8-27
6-1. Cabinet Parts . . . . .	6-40	8-22. P/O A3A4 Connector Board Assembly Component Locations . . . . .	8-28
6-2. Type N Connector . . . . .	6-41	8-23. P/O A9 Peak Deviation and Range Switch Assembly Component Locations . . . . .	8-28
7-1. A8A2 Counter/Lock Board Assembly Backdating (Change B) . . . . .	7-6	8-24. A5 FM Amplifier Assembly Component Locations . . . . .	8-29
7-2. A3A4 Connector Board Assembly Backdating (Change C) . . . . .	7-7	8-25. FM Amplifiers Schematic Diagram . . . . .	8-29
7-3. A26A1 Power Amplifier and AGC Detector Assembly Backdating (Change D) . . . . .	7-8	8-26. P/O A7 FM Shaping Assembly Component Locations . . . . .	8-31
7-4. A26A2U1 Backdating (Change E) . . . . .	7-11	8-27. FM Shaping Circuits and Phase Lock Loop Filter Schematic Diagram . . . . .	8-31
7-5. A8A1 RF Scaler Assembly Backdating (Change E) . . . . .	7-12	8-28. P/O A6 Annunciator Assembly Component Locations . . . . .	8-32
7-6. A12 Rectifier Assembly Backdating (Change F) . . . . .	7-13	8-29. P/O A9 Peak Deviation and Range Switch Assembly Component Locations . . . . .	8-32
7-7. A8A1 RF Scaler Assembly Backdating (Change J) . . . . .	7-16	8-30. P/O A7 FM Shaping Assembly Component Locations . . . . .	8-33
7-8. A8A4 Counter Display Assembly Modification . . . . .	7-20	8-31. Over-Deviation Detector and Meter Control Circuits Schematic Diagram . . . . .	8-33
7-9. A7 FM Shaping Assembly Modification . . . . .	7-23	8-32. A11 Fixed-Frequency Modulation Oscillator Assembly Component Locations . . . . .	8-35
7-10. A9 Peak Deviation and Range Switch Modification . . . . .	7-23	8-33. Fixed-Frequency Modulation Oscillator Schematic Diagram . . . . .	8-35
7-11. A10A2 RF Divider Assembly Modification . . . . .	7-26	8-34. A11 Variable-Frequency Modulation Oscillator Assembly (Option 001) Component Locations . . . . .	8-37
8-1. Signal Generator with Circuit Boards on Extenders . . . . .	8-2	8-35. Variable-Frequency Modulation Oscillator (Option 001) Schematic Diagram . . . . .	8-37
8-2. Examples of Diode and Transistor Marking Methods . . . . .	8-4	8-36. A10A1 RF Filter Assembly Component Locations . . . . .	8-38
8-3. Binary Symbols . . . . .	8-6	8-37. RF Filters Schematic Diagram . . . . .	8-39

## ILLUSTRATIONS (Cont'd)

Figure	Page	Figure	Page
8-38. A10A2 RF Divider Assembly		8-63. P/O A8A2 Counter/Lock Board Assembly	
Component Locations . . . . .	8-41	Component Locations . . . . .	8-61
8-39. RF Dividers Schematic Diagram . . . . .	8-41	8-64. Counter Phase Lock Circuits	
8-40. A26A3 Modulator Assembly		Schematic Diagram . . . . .	8-61
Component Locations . . . . .	8-43	8-65. Current Foldback . . . . .	8-62
8-41. A26A4 AGC Amplifier Assembly		8-66. A12 Rectifier Assembly	
Component Locations . . . . .	8-43	Component Locations . . . . .	8-62
8-42. AGC Amplifiers and Amplitude Modulator		8-67. A20 +5.2V and +44.6V Regulator Assembly	
Schematic Diagram . . . . .	8-43	Component Locations . . . . .	8-63
8-43. A26A1 Power Amplifier and AGC Detector		8-68. A22 +20V and -20V Regulator Assembly	
Assembly Component Locations . . . . .	8-45	Component Locations . . . . .	8-63
8-44. P/O A26A2 AM Offset and Pulse Switching		8-69. Power Supply Circuits Schematic Diagram . . . . .	8-63
Assembly Component Locations . . . . .	8-45	8-70. A18 -5.2V Regulator and Fan Driver Assembly	
8-45. RF Amplifier, Pulse Switching, and Step		Component Locations . . . . .	8-65
Attenuator Schematic Diagram . . . . .	8-45	8-71. -5.2V Regulator and Fan Circuits	
8-46. P/O A26A2 AM Offset and Pulse Switching		Schematic Diagram . . . . .	8-65
Assembly Component Locations . . . . .	8-47	8-72. A17 Power Supply Mother Board Assembly	
8-47. AM Preamplifier Schematic Diagram . . . . .	8-47	Component Locations . . . . .	8-67
8-48. AM Interconnections and RF ON/OFF Switch		8-73. Power Supply Mother Board	
Schematic Diagram . . . . .	8-49	Schematic Diagram . . . . .	8-67
8-49. A1A1 RF Vernier Assembly		8-74. A13 Modulation/Metering Mother Board	
Component Locations . . . . .	8-51	Assembly Component Locations . . . . .	8-68
8-50. RF Vernier Schematic Diagram . . . . .	8-51	8-75. Modulation/Metering Mother Board	
8-51. A2 Meter Switch/Detector Assembly		Schematic Diagram . . . . .	8-69
Component Locations . . . . .	8-52	8-76. A1 Output Level Assembly	
8-52. A4 Meter/Annunciator Drive Assembly		Illustrated Parts Breakdown . . . . .	8-71
Component Locations . . . . .	8-53	8-77. A8 Counter/Lock Assembly	
8-53. P/O A6 Annunciator Assembly		Illustrated Parts Breakdown . . . . .	8-73
Component Locations . . . . .	8-53	8-78. A9 Peak Deviation and	
8-54. Meter Circuits Schematic Diagram . . . . .	8-53	Range Switch Assembly	
8-55. A8A1 RF Scaler Assembly		Illustrated Parts Breakdown . . . . .	8-75
Component Locations . . . . .	8-55	8-79. A11 Variable-Frequency	
8-56. P/O A8A3 Time Base Assembly		Modulation Oscillator (Option 001)	
Component Locations . . . . .	8-55	Illustrated Parts Breakdown . . . . .	8-75
8-57. Counter RF Scaler Schematic Diagram . . . . .	8-55	8-80. A10 Divider/Filter	
8-58. P/O A8A3 Time Base Assembly		Assembly Illustrated Parts	
Component Locations . . . . .	8-57	Breakdown . . . . .	8-77
8-59. Counter Time Base Schematic Diagram . . . . .	8-57	8-81. A26 AM/AGC and RF Amplifier	
8-60. A8A4 Counter Display Assembly		Illustrated Parts Breakdown . . . . .	8-79
Component Locations (P/O A8) . . . . .	8-59	8-82. Top Internal Views	
8-61. P/O A8A2 Counter/Lock Board Assembly		(Option 001 shown) . . . . .	8-81
Component Locations . . . . .	8-59	8-83. Rear Panel View . . . . .	8-83
8-62. Up/Down Counter and Display		8-84. Bottom Internal Views	
Schematic Diagram . . . . .	8-59	(Option 001 shown) . . . . .	8-83

## SERVICE SHEETS

Number	Page	Number	Page
1	Overall Block Diagram . . . . .	15	AM Interconnections and RF ON/OFF
2	FM Circuits and RF Oscillator		
	Troubleshooting . . . . .		Switch (A9, A26) . . . . . 8-48
3	AM/AGC Circuits and Output Amplifier	16	RF Vernier (A1A1, A26) . . . . . 8-50
	Troubleshooting . . . . .	17	Meter Circuits (A2, A4, A6) . . . . . 8-52
4	Counter/Lock Circuits Troubleshooting . . . . .	18	Counter RF Scaler (A8A1, A8A3) . . . . . 8-54
5	RF Oscillator (A3) . . . . .	19	Counter Time Base (A8A3, A9) . . . . . 8-56
6	FM Amplifiers (A3, A5, A9, A13) . . . . .	20	Up/Down Counter and Display
7	FM Shaping Circuits and Phase Lock Loop		(A8A2, A8A4) . . . . . 8-58
	Filter (A7, A9) . . . . .	21	Counter Phase Lock Circuits (A8A2) . . . . . 8-60
8	Over-Deviation Detector and Meter Control	22	Power Supply Circuits (A12, A14, A20, A22) . . 8-62
	Circuits (A6, A7, A9) . . . . .	23	-5.2V Regulator and Fan Circuits
9	Fixed-Frequency Modulation Oscillator		(A16, A18) . . . . . 8-64
	(A11, A13) . . . . .	24	Power Supply Mother Board (A17) . . . . . 8-67
9A	Variable-Frequency Modulation Oscillator for	25	Modulation/Metering Mother Board (A13) . . 8-68
	Option 001 (A11, A13) . . . . .	A	A1 Assembly Removal and Disassembly . . . 8-70
10	RF Filters (A10A1) . . . . .	B	A8 Assembly Removal and Disassembly . . . 8-72
11	RF Dividers (A10A2) . . . . .	C	A9 and A11 Assemblies Removal and
12	AGC Amplifiers and Amplitude Modulator		Disassembly . . . . . 8-74
	(A26A3, A26A4) . . . . .	D	A10 Assembly Removal and Disassembly . . . 8-76
13	RF Amplifier, Pulse Switching, and Step	E	A26 Assembly Removal and Disassembly . . . 8-78
	Attenuator (A1, A26A1, A26A2) . . . . .	F	General Removal Procedures and
14	AM Preamplifier (A13, A26A2) . . . . .		Top Internal Views . . . . . 8-80
		G	Rear Panel and Bottom Internal Views . . . 8-83

## WARNINGS

### SAFETY

To avoid the possibility of injury or death, the following precautions must be followed before the instrument is switched on:

a. If this instrument is to be energized via an autotransformer for voltage reduction, make sure that the common terminal is connected to the earthed pole of the power source.

b. The power cable plug shall only be inserted into a socket outlet provided with a protective earth contact. The protective action must not be negated by the use of an extension cord without a protective conductor (grounding).

c. Before switching on the instrument, the protective earth terminal of the instrument must be connected to a protective conductor of the power cord. This is accomplished by ensuring that the instrument's internal earth terminal is correctly connected to the instrument's chassis and that the power cord is wired correctly (see Service Sheet 22).

Whenever it is likely that the protection has been impaired, the instrument must be made inoperative and be secured against any unintended operation.

Any interruption of the protective (grounding) conductor inside or outside the instrument or disconnection of the protective earth terminal is likely to make the instrument dangerous. Intentional interruption is prohibited.

### HIGH VOLTAGE

Any adjustment, maintenance, and repair of the opened instrument under voltage should be avoided as much as possible and, if inevitable, should be carried out only by a skilled person who is aware of the hazard involved.

Capacitors inside the instrument may still be charged even if the instrument has been disconnected from its source of supply.

### FUSES

Make sure that only fuses with the required rated current and of the specified type (normal blow time delay, etc.) are used for replacement. The use of repaired fuses and the short-circuiting of fuse-holders must be avoided.

## CAUTIONS

### GROUNDING

Any interruption of the protective (grounding) conductor inside or outside the instrument is likely to cause damage to the instrument. To avoid damage, this instrument and all line powered devices connected to it must be connected to the same earth ground (see Section II).

### LINE VOLTAGE

Be sure to select the correct fuse rating for the selected line voltage (see LINE VOLTAGE SELECTION in Section II); fuse ratings are listed on the fuse compartment.

To prevent damage to the instrument, make the line voltage selection *before* connecting line-power. Also ensure that the line power cord is connected to a line power socket that is provided with a protective earth contact.

### SAFETY

To avoid the possibility of damage to test equipment, read completely through each test before starting it. Make any preliminary control settings necessary for correct test equipment operation.

### COUNTER INPUT

Do not apply a dc voltage or  $>+15$  dBm to COUNTER INPUT.

### SEMI-RIGID COAX

While working with and around the semi-rigid coaxial cables in the generator, do *not* bend the cables more than necessary. Do *not* torque the RF connectors to more than 2 inch-pounds.



**MODEL 8640B**

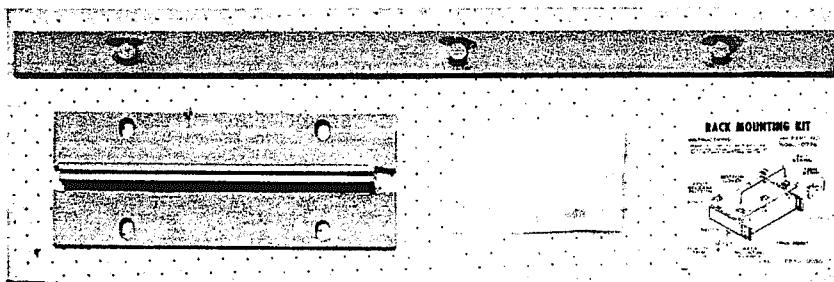

**RACK MOUNTING KIT**

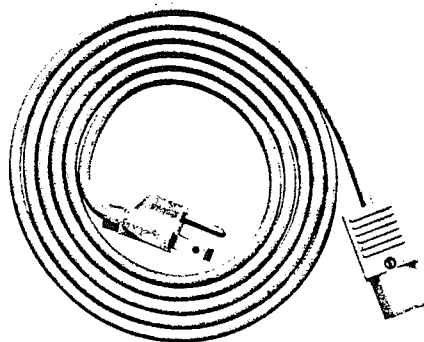

**LINE POWER CABLE**

*Figure 1-1. HP Model 8640B Signal Generator (Option 001) and Accessories Supplied*

## SECTION I GENERAL INFORMATION

### 1-1. INTRODUCTION

1-2. This manual contains the operating and service information for the Hewlett-Packard Model 8640B Signal Generator. The Signal Generator (with variable modulation oscillator Option 001) is shown in Figure 1-1 with all of its externally supplied accessories.

1-3. This section of the manual describes the instruments documented by this manual and covers instrument description, options, accessories, specifications and other basic information. The other sections provide the following information:

**Section II, Installation:** provides information about initial inspection, preparation for use, and storage and shipment.

**Section III, Operation:** provides information about panel features, and provides operating checks, instructions, and maintenance information.

**Section IV, Performance Tests:** provides the information required to verify that the instrument is performing as specified in Table 1-1.

**Section V, Adjustments:** provides the information required to properly adjust and align the instrument.

**Section VI, Replaceable Parts:** provides ordering information for all replaceable parts and assemblies.

**Section VII, Manual Changes:** this section is reserved to provide manual change information in future revisions of this manual.

**Section VIII, Service:** provides the information required to repair the instrument.

1-4. Packaged with this manual is an Operating Information Supplement. This is simply a copy of the first three sections of this manual. This supplement should stay with the instrument for use by the operator. Additional copies can be ordered through your nearest Hewlett-Packard Sales and Service Office; the part number is listed

on the title page of this manual and on the rear cover of the supplement.

1-5. Also listed on the title page of this manual is a "Microfiche" part number. This number can be used to order 4 x 6 inch microfilm transparencies of the manual. Each microfiche contains up to 60 photo duplicates of the manual's pages. The microfiche package also includes the latest Manual Changes supplement as well as all pertinent Service Notes.

1-6. Instrument specifications are listed in Table 1-1. These specifications are the performance standards or limits against which the instrument can be tested. Paragraph 1-17 lists some supplemental performance characteristics. Supplemental characteristics are not specifications but are typical characteristics included as additional information for the user.

### 1-7. INSTRUMENTS COVERED BY MANUAL

1-8. This instrument has a two-part serial number. The first four digits and the letter comprise the serial number prefix. The last five digits form the sequential suffix that is unique to each instrument. The contents of this manual apply directly to instruments having the same serial number prefix(es) as listed under SERIAL NUMBERS on the title page.

1-9. An instrument manufactured after the printing of this manual may have a serial prefix that is not listed on the title page. This unlisted serial prefix indicates that the instrument is different from those documented in this manual. The manual for this instrument is supplied with a yellow Manual Changes supplement that contains "change information" that documents the differences.

1-10. In addition to change information, the supplement may contain information for correcting errors in the manual. To keep this manual as current and accurate as possible, Hewlett-Packard recommends that you periodically request the latest Manual Changes supplement. The supplement for this manual is keyed to this

manual's print date and part number, both of which appear on the title page. Complimentary copies of the supplement are available from Hewlett-Packard.

1-11. For information concerning a serial number prefix not listed on the title page or in the Manual Changes supplement, contact your nearest Hewlett-Packard office.

## 1-12. GENERAL DESCRIPTION

1-13. The Model 8640B Signal Generator covers the frequency range 500 kHz to 512 MHz (450 kHz to 550 MHz with band over-range) and can be extended to 1100 MHz with an external doubler. An optional variable audio oscillator is also available to extend the CW output range of the generator down to 20 Hz. This broad coverage, together with calibrated output and modulation, provides for complete RF and IF performance tests on virtually any type of HF, VHF, or UHF receiver.

1-14. This solid state generator has an output level range of +19 to -145 dBm (2 V to 0.013  $\mu$ V) and is calibrated and metered. The output is leveled to within  $\pm 0.5$  dB across the full frequency range of the instrument.

1-15. The generator also provides AM, FM, and pulse modulation for a wide range of receiver test applications. AM and FM can be performed independently or simultaneously in either the internal or external modes. This modulation is calibrated and metered for direct readout under all operating conditions. External pulse modulation is also available.

1-16. Other significant features are extremely low noise, built-in phase lock and counter, and front panel controls designed for operating convenience and flexibility.

## 1-17. PERFORMANCE CHARACTERISTICS

### 1-18. Spectral Purity

1-19. The basic frequency source of the Signal Generator is a mechanically tuned high-Q cavity oscillator that operates over the frequency range 230 - 550 MHz. This oscillator has an inherent stability of better than 10 ppm/10 min and exceptionally low noise characteristics. The lower 9 frequency ranges are obtained by dividing the basic oscillator frequency and filtering the unwanted

harmonics. Using this technique, sub-harmonic and non harmonic-spurious are virtually eliminated. A band over-range of 7% to 10% is also provided for convenience when operating near the nominal band edges.

1-20. Frequency tuning within the selected band is accomplished with approximately 8 turns of the FREQUENCY TUNE control (see Figure 3-2) for fast selection of the desired output frequency. A mechanical FINE TUNE control has a tuning range of 200 ppm for precision frequency setting.

1-21. Restabilization time is short when tuning the frequency across any one band. The total frequency excursion after any frequency change is typically  $< 20$  ppm and within 15 minutes the output has restabilized to the specified 10 ppm/10 min. When not phase locked, no restabilization time is required when switching frequency bands for a fixed position on the frequency tune control.

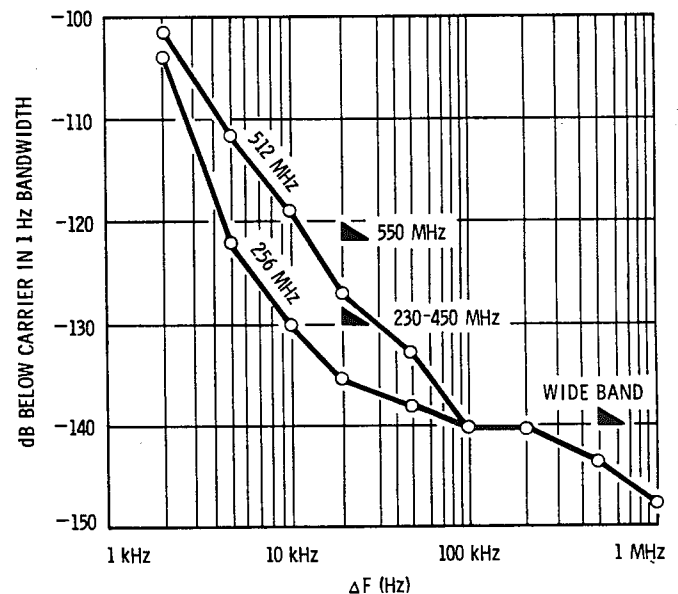

Figure 1-2. Measured Single Sideband Noise vs Offset from Carrier. (Stated in a 1 Hz Bandwidth at 256 and 512 MHz Carrier Frequencies on 256 - 512 MHz Band.) Markers indicate specified limits.

1-22. Noise performance of the generator is state of the art for a solid state generator. The high-Q cavity oscillator has been optimized with use of a low noise microwave transistor for a spectrally pure output signal. Figure 1-2 shows the typical measured single-sideband noise performance in a

1 Hz bandwidth for various offsets from a (256 and 512 MHz) carrier. The low close-in noise characteristic is ideally suited for the stringent adjacent channel tests that are commonly made on a wide variety of communication receivers.

1-23. Figure 1-3 gives a plot of the guaranteed SSB noise performance for a 20 kHz offset from the carrier for the 256 - 512 MHz band. From 230 to 450 MHz, noise is >130 dB/Hz below the carrier level and rises to 122 dB/Hz at 500 MHz. This signal-to-noise ratio decreases by approximately 6 dB for each division of the output frequency down to the broadband noise floor of better than 140 dB/Hz. This exceptional noise performance is also preserved during FM\* and in the phase lock mode.

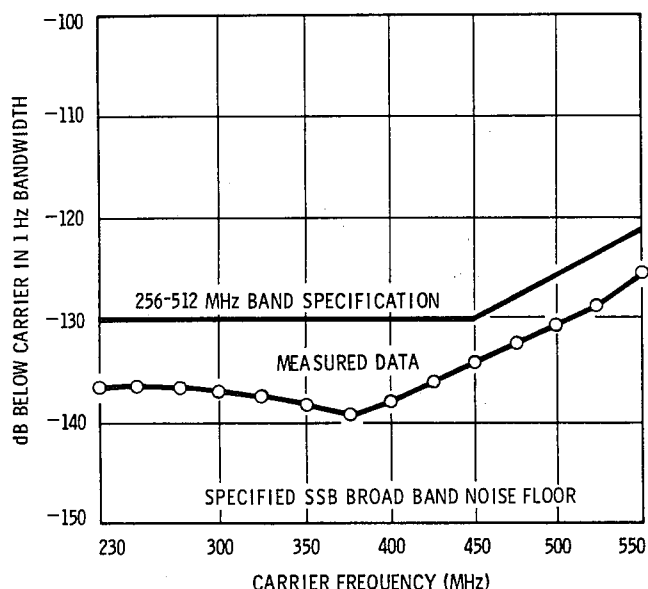

Figure 1-3. Specified Signal-to-Phase Noise Ratio at 20 kHz Offset vs Carrier Frequency (MHz). (Stated in a 1 Hz Bandwidth.) For lower frequencies phase-noise decreases approximately 6 dB per frequency division down to the broadband noise floor.

#### 1-24. Frequency Counter

1-25. The Signal Generator has a built-in 550 MHz frequency counter and phase lock synchronizer. The 6-digit LED display gives a normal resolution of 10 kHz at 500 MHz and 10 Hz at 500 kHz. The resolution can be increased using the X10 or X100 EXPAND buttons near the display. In the X100

\* It is slightly degraded in FM

EXPAND mode, the resolution is 100 Hz at 500 MHz and 0.1 Hz at 500 kHz.

1-26. This resolution, combined with the high stability of the generator, provides precision frequency selection and meaningful measurements on high performance receiver systems. When selecting the external doubler band, the counter displays the doubled output frequency directly.

1-27. When using the expand modes, it is possible for significant digits or the decimal point to be shifted off the display. When this occurs, an OVERFLOW light reminds the operator that the display is not showing the complete output frequency.

1-28. The built-in counter can also be used to count external input signals from 1 Hz to 550 MHz and eliminates the need for a separate frequency counter in many measurement systems. Input sensitivity is <100 mV into 50Ω. Using the EXPAND buttons, it is possible to achieve a resolution of 1 Hz in the 0-10 MHz EXTERNAL count mode or 100 Hz in the 0-550 MHz mode.

#### 1-29. Phase-Lock Mode

1-30. Also included in the Signal Generator is a built-in phase lock synchronizer that locks the RF output frequency to the crystal time base used in the counter. In this locked mode, output stability is better than  $5 \times 10^{-8}$  /h and the spectral purity and FM capability (down to 50 Hz rates) of the unlocked mode are preserved. For higher stability, it is possible to lock to an externally applied 5 MHz standard. Two Model 8640B's can also be locked together for various two-tone measurements.

1-31. Phase locking the generator is simple - just push the front panel LOCK button. The generator is then locked to the frequency shown on the LED display. If lock is broken (for example by tuning to a new output frequency or during warmup), there is an immediate indication: the LED display flashes. The generator can be relocked by releasing the LOCK button and then relocking.

1-32. Lock can be achieved in the normal mode of the counter or in the X10 EXPAND mode if the OVERFLOW light is not on. It is not possible to lock in the X100 EXPAND mode or when counting external inputs. Maximum resolution in the locked mode is 1 kHz at 500 MHz, increasing to 1 Hz at 500 kHz.



1-33. If an output frequency between adjacent counter indications is required, a TIME BASE VERNIER is provided with a range of  $\pm 20$  ppm. This fine tunes the internal crystal time base and sets the output frequency between adjacent counts (i.e., the digits to the right of the display). This gives continuous coverage of all output frequencies even in the phase lock mode. An UNCAL light near the vernier will indicate when this mode has been selected since the counter display is incorrect.

1-34. When phase locked, FM capability is preserved down to modulation rates of  $< 50$  Hz. The narrow bandwidth of the phase lock loop ( $< 5$  Hz) allows FM up to 250 kHz rates and assures no degradation in noise from the unlocked mode. The generator's residual FM is not changed by phase lock.

**1-35. Amplitude Modulation**

1-36. AM is variable from 0 to 100% with the bandwidth, accuracy, and low incidental FM required for the most stringent AM applications. The front panel meter gives a direct readout of AM% in either the internal or external mode and autoranges the 0 - 100% scale at 0 - 30% for improved settability at low modulation depth.

1-37. AM up to bandwidths of 60 kHz is possible depending on carrier frequency and modulation depths. Distortion is specified at 400 Hz and 1000 Hz to be  $< 1\%$  up to 50% AM,  $< 3\%$  to 90% AM. Figure 1-4 shows measured AM distortion characteristics for other modulation frequencies. Note that for 0 - 50% AM, distortion is  $< 1\%$  to approximately 50 kHz for an output frequency of 200 MHz.

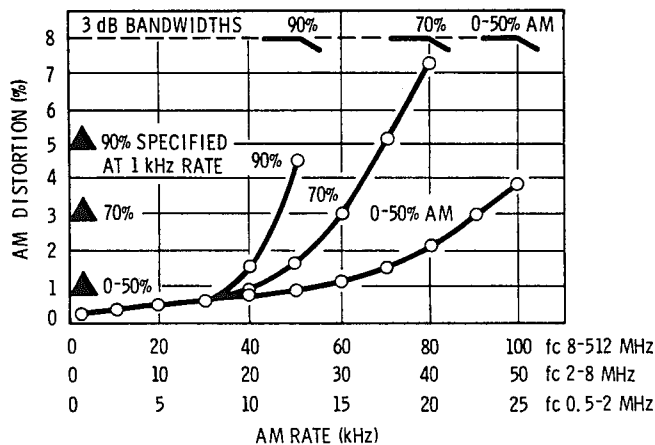

Figure 1-4. AM distortion vs AM rate measured at 200 MHz and +13 dBm, but applies to all bands. (Supplemental information only.)

**1-38. Pulse Modulation**

1-39. Also included on the AM function switch is a position for external PULSE modulation. In this mode, pulse inputs with repetition rates to 500 kHz and widths down to  $2 \mu s$  can be applied to modulate the RF carrier. Rise and fall times vary with output frequency down to  $< 1 \mu s$  from 8 to 512 MHz.

1-40. Pulse inputs turn the RF on. Hence with no pulse input the RF will read approximately zero on the built-in level meter. For pulse inputs within the specified range, the RF output calibration is preserved and the level meter reads the pulse-on power of the RF output. For repetition rates below that specified, the pulsed RF output is still available but the pulse-on level is no longer calibrated or metered.

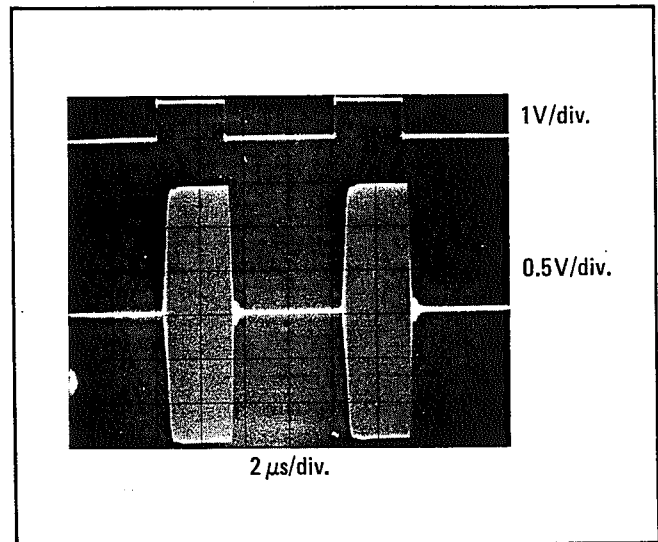

Figure 1-5. Pulsed RF 20 MHz Carrier Frequency at 400 kHz Pulse Rate and  $1 \mu s$  Pulse Width.

**1-41. Frequency Modulation**

1-42. FM is calibrated, metered and constant with frequency and band changes. Peak deviations to at least 0.5% of carrier frequency are available (i.e., 1% of the minimum frequency in each octave band). On the 256 - 512 MHz band, for example, the maximum deviation is 2.56 MHz peak or 5.12 MHz peak-to-peak. With this wide deviation capability, it is possible to sweep the generator, using the dc coupled FM mode and a sawtooth input, to test and align IF filters and discriminators.

1-43. For narrowband FM applications, a minimum full scale deviation of 5 kHz is provided on the meter and the PEAK DEVIATION range switch. When switching from the CW to FM mode, there is negligible shift in carrier frequency and no degradation in spectral purity for these narrow deviations. With the generator in the phase lock mode it is possible to modulate at rates from 50 Hz to 250 kHz with accurate narrowband FM and the carrier drift stability of a crystal oscillator. Using the unlocked mode, it is possible to modulate from dc to 250 kHz with a carrier drift stability of <10 ppm/10 min.

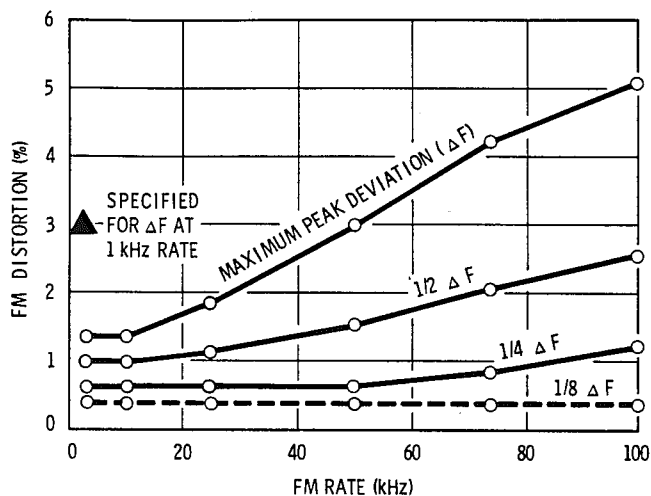

Figure 1-6. FM distortion vs FM rate measured in the 8-16 MHz band, but applies to all bands (supplemental information only).

#### 1-44. Standard and Optional Audio Oscillators

1-45. Standard tones for internal modulation are 400 Hz and 1000 Hz. These tones are also available at the front panel and can be varied in output level from 1 V to 10 mV into 600Ω. Total harmonic distortion is typically <0.25%.

1-46. Optionally available on the Signal Generator is a built-in variable frequency oscillator covering the range 20 Hz to 600 kHz (fixed tones of 400 Hz and 1000 Hz are also provided). This internal oscillator provides a wide range of standard modulation frequencies and can be used for receiver audio bandwidth testing as well. Output from this modulation source is available separately at the front panel and can be varied in level from 3 V to 20 mV into 600Ω. This audio oscillator, Option 001, extends the usable CW range of the generator down to 20 Hz.

#### 1-47. Multi-Function Meter and Annunciators

1-48. The front panel on the Signal Generator monitors the RF output level in dBm and volts, the AM modulation percentage, and the FM peak deviation in kHz or MHz. The accuracy of this meter is usually better than ±3% of reading. Pushbuttons select the meter function, and scale lights indicate the range on which the meter reading should be made. For RF output level and AM%, the scales autorange for better resolution. For FM, the appropriate scale is selected by the PEAK DEVIATION range switch.

1-49. Also provided are three front panel annunciators that indicate when certain settings of RF level and modulation controls exceed specified limits. Besides giving a warning indication, the annunciators instruct the operator how to return the instrument to proper operation.

1-50. For example, the REDUCE PEAK POWER annunciator lights whenever the combined settings of RF output level and AM modulation exceed the maximum specified output level of +19 dBm. Hence for 100% AM, the REDUCE PEAK POWER light will stay on until the RF level is reduced to +13 dBm.

1-51. The REDUCE PEAK DEVIATION annunciator lights whenever the PEAK DEVIATION RANGE switch has been set to exceed the allowable limits for any output FREQUENCY RANGE. The specification allows for a maximum peak deviation of 1% of the minimum frequency in each band (e.g., 2.56 MHz on the 256 - 512 MHz band). When the annunciator lights, the FM is automatically turned off and the FM meter reads zero.

1-52. The REDUCE FM VERNIER annunciator lights whenever the FM input and FM vernier setting combine to exceed the 1 volt drive level required to achieve the maximum deviation indicated on the PEAK DEVIATION range switch. When this occurs, either the FM vernier or the amplitude of the incoming modulation signal should be reduced to obtain specified FM performance.

#### 1-53. Output Level

1-54. The wide output range of the generator is achieved with a 10 dB step attenuator and an 18 dB concentric vernier. Output levels can be read directly on the attenuator dial or (for greater accuracy) on the autoranging meter. The meter

scales are automatically selected to give the maximum indicator resolution for any output level.

1-55. The maximum output level of +19 dBm permits high level tests on receiver IF's, amplifiers, and mixers without additional power amplification. At the same time, extremely low leakage ensures receiver sensitivity measurements down to levels of 0.03  $\mu$ V in a shielded system.

1-56. For improved accuracy at low output levels, the meter, in conjunction with the attenuator, is factory-calibrated against a precision standard to remove much of the error that is accumulated from the attenuator steps. Using a power meter and calibrating the output for one output frequency and vernier setting, it is then possible to make sensitivity measurements to better than  $\pm 1$  dB accuracy down to output levels of -127 dBm.

### 1-57. OPTIONS

1-58. **Option 001.** Option 001 (covered in this manual) provides a modulation oscillator that is continuously settable from 20 Hz to 600 kHz. The oscillator can also be set for 400 Hz or 1 kHz fixed tones.

1-59. **Option 002.** Option 002 (not covered in this manual) provides an internal, active frequency doubler that extends the frequency range of the generator to 1024 MHz (to 1100 MHz with over-range).

1-60. **Option 003.** Option 003 (not covered in this manual) provides reverse power protection to the generator's output attenuator and amplifier. It is particularly useful when using the generator to test transceivers.

1-61. **Option 004.** Option 004 (not covered in this manual) provides a demodulated output and modified AM circuitry that can be used to set very accurate AM depths. It also provides a 1 dB output step attenuator in addition to the standard 10 dB output step attenuator. These features allow the generator to be used to test VOR, ILS, and VHF communications receivers.

### 1-62. ACCESSORIES SUPPLIED

1-63. The Model 8640B is supplied with the following accessories (they are shown in Figure 1-1):

- Rack Mounting Kit (HP 5060-8740)
- Line Power Cable (HP 8120-1378)
- 2 Amp Fuse (HP 2110-0002)
- 1 Amp Fuse (HP 2110-0001)

1-64. The rack mounting kit, the cable, and the fuses are fully described in Section II.

1-65. The following accessories are mounted inside the instrument's chassis and are available for adjustment and repair (for more information, see Sections V and VIII):

- Combination Wrench (HP 08640-00027)
- Spare fuses for power supply circuit boards
- Spare power supply regulator integrated circuit
- 30-Pin Extender Board (HP 08640-60036)

### 1-66. EQUIPMENT AVAILABLE

1-67. **Fuseholder.** The HP Model 11509A Fuseholder attaches to the RF OUTPUT jack and prevents accidental damage to the generator's output attenuator by externally applied RF. It is primarily used when testing transceivers.

#### CAUTION

The fuseholder may not protect the output amplifier against a fast pulse of reverse power on the top two output level ranges.

1-68. **Termination.** The HP Model 11507A Termination maintains the generator's output level calibration when the output is connected to load impedances other than 50 ohms. It can provide source impedances of 25 and 5 ohms, and it can simulate a broadcast-band dummy antenna. The frequency range is 50 kHz to 65 MHz.

1-69. **75 Ohm Adapter.** The HP Model 11687A 50 to 75 Ohm Adapter connects to the generator's output to provide a source impedance of 75 ohms.

1-70. **Doubler.** The HP Model 11690A Doubler extends the usable frequency range of the generator one octave to 1024 MHz (actually to 1100 MHz with 7% frequency over-range). Conversion loss in the doubler is typically <13 dB.

1-71. **Mixer.** The HP Model 10514A Double Balanced Mixer can be used at the generator's output as a nanosecond pulse modulator or as a balanced mixer.

1-72. **Protective Cover.** The HP 5060-8767 Control Panel Cover protects the panel from dust and impact damage.

**1-73. WARRANTY**

1-74. The Model 8640B is warranted and certified as indicated on the inner front cover of this manual. For further information, contact the nearest Hewlett-Packard Sales and Service Office; addresses are provided at the back of this manual.

**1-75. TEST EQUIPMENT REQUIRED**

1-76. Tables 1-2 and 1-3 list the test equipment and accessories required to check, adjust and repair the Model 8640B. If substitute equipment is used, it must meet the listed critical specifications.

**NOTE**

The safety classification of this instrument is Safety Class I. It has been designed and tested according to IEC Publication 348 *Safety Requirements for Electronic Measuring Apparatus* and has been supplied in safe condition. The instruction manual contains information, warnings, and cautions which must be followed by the user to ensure safe operation and to retain the instrument in safe condition.

Table 1-1. Specifications (1 of 5)

(All specifications apply over the nominal Frequency Bands and over the top 10 dB of the output level vernier range unless otherwise specified.)

**FREQUENCY CHARACTERISTICS**

**Range:** 500 kHz to 512 MHz in 10 Octave Bands (to 1024 MHz with External Frequency Doubler).

**Accuracy:** 6-digit LED display with X10 and X100 expand; accuracy depends on internal or external reference used.

**Bands and Band Overlap:** Bands extend 10% below and 7% above the nominal Frequency Bands shown below.

$$\left[ \begin{array}{c} \text{Total} \\ \text{Count} \\ \text{Accuracy} \end{array} \right] = {}^2 \left[ \begin{array}{c} \text{Counter} \\ \text{Resolution} \\ (\pm 1 \text{ count}) \end{array} \right] + \left[ \begin{array}{c} \text{Reference} \\ \text{Error} \\ (\text{INT or EXT}) \end{array} \right]$$

Internal Reference Error <math>\leq \pm 2 \text{ ppm}</math>  
(when calibrated at 25°C every 3 months and operated between 15°C and 35°C)

Frequency Bands (MHz)	Frequency Range (MHz) (with overlap)
0.5 - 1	0.45 - 1.07
1 - 2	0.9 - 2.1
2 - 4	1.8 - 4.2
4 - 8	3.6 - 8.5
8 - 16	7.2 - 17.1
16 - 32	14.4 - 34.3
32 - 64	28.8 - 68.7
64 - 128	57.5 - 137.5
128 - 256	115 - 275
256 - 512	230 - 550
External Doubler Band <sup>1</sup> 512 - 1024	460 - 1100

**Fine Tuning:**

Unlocked: >200 ppm total range.  
Locked mode: >±20 ppm by varying internal time base vernier.

**Stability:**

	Normal	Locked <sup>3</sup>
<b>Time</b> (after 2-hour warm-up)	<10 ppm/10 min	<0.05 ppm/hr
<b>Temperature</b>	<50 ppm/°C	<2 ppm total <sup>4</sup> variation (room ambient 15 to 35°C)
<b>Line Voltage<sup>5</sup></b> (+5% to -10% line voltage change)	<1 ppm	<0.1 ppm
<b>Load</b> (with any passive load change)	<1 ppm	None measurable
<b>Level Change</b> (10 dB on output level vernier)	<1 ppm	
<b>Mode Change</b> (CW to FM)	<1% of selected peak deviation or <200 Hz whichever is greater	

**Internal Counter Resolution:**

Frequency Bands (MHz)	Normal Mode	Expand X10	Expand X100
0.5 - 1	10 Hz	1 Hz	0.1 Hz
1 - 16	100 Hz	10 Hz	1 Hz
16 - 128	1 kHz	100 Hz	10 Hz
128 - 1024	10 kHz	1 kHz	100 Hz

<sup>1</sup> In the External Doubler Band, the 8640B counter displays the actual doubled output frequency, and the FM meter indicates the proper peak deviation.  
<sup>2</sup> When phase locked, Counter Resolution error is eliminated.  
<sup>3</sup> These specifications are given for the 8640B internal reference. When using an external reference, drift in the locked mode will depend on the external reference characteristics.  
<sup>4</sup> Phase lock may break due to temperature change (i.e., during warm-up). Simply relock at desired frequency.  
<sup>5</sup> This specification is for short term, transient line changes.

Table 1-1. Specifications (2 of 5)

**Restabilization Time:**

**FREQUENCY CHARACTERISTICS (Cont'd)**

	Normal	Locked <sup>1</sup>
After frequency change	<15 min	<1 min after relocking to be within 0.1 ppm of steady-state frequency
After band change	None	
After 1 min in RF OFF Mode	<10 min	

**SPECTRAL PURITY**

**Harmonics:** (at 1 volt, +13 dBm, output range and below)

- >35 dB below fundamental of 0.5 to 128 MHz.
- >30 dB below fundamental of 128 to 512 MHz.

**Subharmonics and Nonharmonic Spurious:** (excluding frequencies within 15 kHz of carrier whose effects are specified in Residual AM and FM): >100 dB below carrier.

**Noise:** Averaged rms noise level below carrier stated in a 1 Hz bandwidth.

SSB Phase Noise at 20 kHz offset from carrier. (See Figures 1-2 and 1-3.)

256 MHz to 512 MHz: >130 dB from 230 to 450 MHz increasing linearly to >122 dB down at 550 MHz.

0.5 MHz to 256 MHz: Decreases approximately 6 dB for each divided frequency range until it reaches SSB Broadband Noise Floor of >140 dB.

SSB Broadband Noise Floor at maximum vernier greater than 500 kHz offset from carrier. (See Figures 1-2 and 1-3.)

0.5 to 512 MHz: >140 dB.

**Residual AM:** (Averaged rms)

Post-detection Noise Bandwidth	
300 Hz to 3 kHz	20 Hz to 15 kHz
>85 dB down	>78 dB down

**Residual FM:** (Averaged rms)

	CW and up to 1/8 maximum allowable peak deviation		Up to maximum allowable peak deviation	
Post-detection Noise Bandwidth	300 Hz to 3 kHz	20 Hz to 15 kHz	300 Hz to 3 kHz	20 Hz to 15 kHz
<b>230 to 550 MHz</b>	<5 Hz	<15 Hz	<15 Hz	<30 Hz

Note: Residual FM decreases by approximately 1/2 for each divided frequency range until limited by broadband noise floor. This limit for 300 Hz to 3 kHz is about 1 Hz, and for 20 Hz to 15 kHz is about 4 Hz. These are measured values in the 230 to 550 MHz range and calculated for divided ranges, knowing the noise distribution.

**OUTPUT CHARACTERISTICS**

**Range:** 10 dB steps and 18 dB vernier provide output power settings from +19 to -145 dBm (2V to 0.013 μV) into 50Ω.

**Level Flatness:** <±0.5 dB from 0.5 to 512 MHz referred to output at 50 MHz. (Flatness applies to +13 to -7 dBm and for top 10 dB of vernier range.)

<sup>1</sup> These specifications are given for the 8640B internal reference. When using an external reference, drift in the locked mode will depend on the external reference characteristics.

Table 1-1. Specifications (3 of 5)

**OUTPUT CHARACTERISTICS (Cont'd)**

**Impedance:** 50Ω, ac coupled, 40 Vdc maximum, VSWR <2.0 on 2V and 1V output ranges; <1.3 on all other ranges.

**Reverse Power:** 20 dBm maximum on 2V and 1V output ranges; 30 dBm maximum on all other ranges.

**Auxiliary Output:** Rear panel BNC output is >-5 dBm into 50Ω, source impedance is approximately 500Ω.

**Leakage:** (With all unused outputs terminated properly.) Leakage limits are below those specified in MIL-I-6181D. Furthermore, less than 3 μV is induced in a 2-turn, 1-inch diameter loop 1 inch away from any surface and measured into a 50Ω receiver. This permits receiver sensitivity measurements to at least <0.03 μV in a shielded system.

**Level Accuracy:**

Output Level (dBm)	Using Top 10 dB of Vernier Range			Using Full Vernier Range
	+19 to -7	-7 to -47	-47 to -137	+19 to -145
<b>Total Accuracy as Indicated on Level Meter</b>	±1.5 dB	±2.0 dB	±2.5 dB	Add ±0.5 dB

Note: Level Accuracy error consists of allowances for: meter accuracy, detector linearity, temperature, flatness, attenuator accuracy, and twice the measurement error. All but the attenuator accuracy and the measurement error can be calibrated out with a power meter at a fixed frequency and a fixed vernier setting.

**MODULATION CHARACTERISTICS**

**General**

**Types:** Internal AM and FM.  
External AM, FM, and PULSE.  
Simultaneous AM and FM or PULSE and FM.

**Optional:** (Internal Variable Audio Oscillator Option 001).

Frequency: Variable 20 Hz to 600 kHz, ±10% in 5, decade continuous bands plus fixed 400 Hz and 1 kHz ±2%.

**Internal Modulation Sources:** (independently adjustable output is available at front panel).

Output Level: 20 mV to 3V into 600Ω.

**Standard:**

Frequency: Fixed 400 Hz and 1 kHz, ±2%.  
Output Level: Indicated 10 mV to 1 Vrms into 600Ω.

**Total Harmonic Distortion:**

<0.25% 400 Hz and 1 kHz fixed tones  
<0.5% 20 Hz to 2 kHz  
<1.0% 2 kHz to 600 kHz

**Amplitude Modulation**

(AM specifications apply to the top 10 dB of output vernier range unless otherwise specified.)

**Depth:** 0 to 100% for output level range of +13 dBm and below and for top 10 dB of vernier range.<sup>1</sup>

**AM 3 dB Bandwidth:** (See Figure 1-4).

Frequency Bands	0 to 50% AM	50 to 90% AM
0.5 - 2 MHz	20 kHz	12.5 kHz
2 - 8 MHz	40 kHz	25 kHz
8 - 512 MHz	60 kHz	50 kHz

**AM Rates:** INT and EXT ac; 20 Hz to AM 3 dB bandwidth below. EXT dc; dc to AM 3 dB bandwidth below.

<sup>1</sup> AM is possible above +13 dBm as long as the combination of the AM depth plus carrier output level does not exceed +19 dBm.

Table 1-1. Specifications (4 of 5)

**MODULATION CHARACTERISTICS (Cont'd)**

**Amplitude Modulation (Cont'd)**

**AM Distortion:** (at 400 Hz and 1 kHz rates)

Frequency Bands	0 to 50% AM	50 to 90% AM
0.5 to 512 MHz	<1%	<3%

**Indicated AM Accuracy:** (400 Hz and 1 kHz rates using internal meter)

±8% of reading on 0 - 10 scale.

±9% of reading on 0 - 3 scale (for greater than 10% of full scale).

**Peak Incidental PM** (at 30% AM)

Less than 0.15 radians, 0.5 to 128 MHz.

Less than 0.3 radians, 128 to 512 MHz.

**External AM Sensitivity:** (400 Hz and 1 kHz rates)  
(0.1 ± 0.005)% AM per mV peak into 600Ω with AM vernier at full CW position.

**Peak Incidental Frequency Deviation:** Equals PEAK INCIDENTAL PM x MODULATION RATE.

**Pulse Modulation**

(Specifications apply for top 10 dB of output vernier range.)

Frequency Bands (MHz)	0.5 - 1	1 - 2	2 - 8	8 - 32	32 - 512
Rise and Fall Times	<9 μs	<4 μs	<2 μs	<1 μs	
Pulse Repetition Rate	50 Hz to 50 kHz		50 Hz to 100 kHz	50 Hz to 250 kHz	50 Hz to 500 kHz
Pulse Width Minimum for level accuracy within 1 dB of CW (>0.1% duty cycle)	10 μs		5 μs	2 μs	
Pulse ON/OFF ratio at maximum vernier	>40 dB				
Peak Input Required	Nominally +0.5V (+5V max) waveform, return to zero, into 50Ω Schmitt trigger.				

**Frequency Modulation**

**Deviation:** Maximum allowable deviation equals 1% of lowest frequency in each band as below.

Frequency Band (MHz)	Maximum Peak Deviation (kHz)
0.5 - 1	5
1 - 2	10
2 - 4	20
4 - 8	40
8 - 16	80
16 - 32	160
32 - 64	320
64 - 128	640
128 - 256	1280
256 - 512	2560
512 - 1024	5120

**FM 3 dB Bandwidth:**<sup>1</sup>

Internal and External ac; 20 Hz to 250 kHz.

External dc; dc to 250 kHz.

**FM Distortion:** (at 400 Hz and 1 kHz rates) See Figure 1-6.

<1% for deviations up to 1/8 maximum allowable.

<3% for maximum allowable deviation.

**External FM Sensitivity:** 1 volt peak yields maximum deviation indicated on PEAK DEVIATION switch with FM vernier at full CW position.

**External FM Sensitivity Accuracy:** ±6% from 15 to 35°C for FM excluding maximum peak deviation position. Maximum peak deviation position, ±9% typically.

<sup>1</sup> With 8640B in LOCKED MODE, external FM is possible only for rates greater than 50 Hz.



Table 1-1. Specifications (5 of 5)

**MODULATION CHARACTERISTICS (Cont'd)**

**Frequency Modulation (Cont'd)**

**Indicated FM Accuracy:**

(400 Hz and 1 kHz rates using internal meter)  
 ±10% of meter reading (for greater than 10% of full scale).

**Incidental AM:** (at 400 Hz and 1 kHz rates)

<0.5% AM for FM up to 1/8 maximum allowable deviation.  
 <1% AM for FM at maximum allowable deviation.

**COUNTER CHARACTERISTICS**

**External RF Input:**

**Frequency Range:** 1 Hz to 550 MHz.  
**Sensitivity:** 100 mVrms, ac only, into 50Ω (-7 dBm).  
**Maximum Input:** 1.3 Vrms (+15 dBm).

**Internal Reference Characteristics: (after 2-hr. warm-up)**

**Accuracy:** (after calibration at 25°C)  
 Better than ±1 ppm for 15 to 35°C.  
 Better than ±3 ppm for 0 to 55°C.

**External Count Resolution: 6-digit LED DISPLAY**

Mode	Normal	Expand X10	Expand X100
0 - 10 MHz	100 Hz	10 Hz	1 Hz
0 - 550 MHz	10 kHz	1 kHz	100 Hz

**Drift Rate:**

Time: <0.05 ppm per hr, <2 ppm per year.  
 Temperature: <2 ppm total variation for room ambient 15 to 35°C.  
 Line Voltage: <0.1 ppm.

**Frequency Tuning:**

>±20 ppm using internal time base vernier.

**External Reference Input:** 5 MHz, nominally >0.5 Vp-p (5V maximum) into 1000Ω.

**Rear Output:** nominally >0.5 Vp-p into 500Ω. This will drive another 8640B.

**GENERAL CHARACTERISTICS**

**Operating Temperature Range:** 0 to 55°C.

**Power Requirements:** 100, 120, 220, and 240 volts, +5%, -10%, 48 to 440 Hz; 175 VA maximum. 7½ ft. (2,29 m) power cable furnished with mains plug to match destination requirements.

**Weight:** Net, 45 lb (20,4 kg).

**Dimensions:<sup>1</sup>**

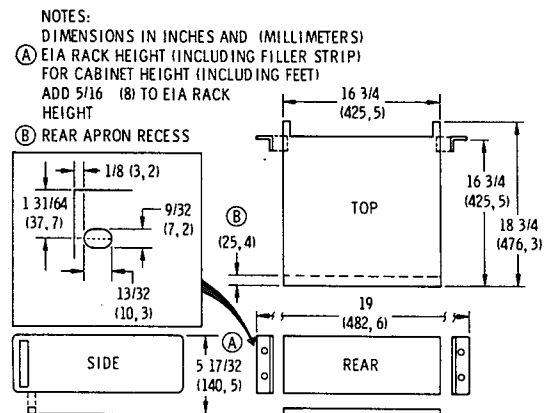

<sup>1</sup> Dimensions are for general information only. If dimensions are required for building special enclosures, contact your HP office.

Table 1-2. Recommended Test Equipment (1 of 7)

Instrument Type	Critical Specifications	Suggested Model	Use*
Adjustable Stub	Length: >50 cm Range: to 550 MHz	GR 874-D50L	P
20 dB Amplifier (3 required)	Range: 0.5 - 520 MHz Gain: 20 to 25 dB Flatness over Range: $\pm 2$ dB Impedance: $50\Omega$ Noise Figure: <5 dB	HP 8447A	P,A
20 dB Amplifier	Range: 400 - 1200 MHz Gain: >20 dB Flatness: $\pm 2$ dB Impedance: $50\Omega$ Noise Figure: <5 dB to 1 GHz	HP 8447B	P
40 dB Amplifier	Range: 5 Hz to 100 kHz Gain: 20 and 40 dB $\pm 1$ dB Input Impedance: >5 k $\Omega$ Output Impedance: $50\Omega$ Noise: <25 $\mu$ Vrms referred to input Output: >1 Vrms into $50\Omega$	HP 465A	P,A
40 dB Amplifier	Range: 20 Hz to 100 kHz Gain: 40 $\pm 1$ dB Input Impedance: $50\Omega$ Noise Figure: <3 dB when driven from $50\Omega$ Output Level: >100 mV in $50\Omega$	HP 08640-60506	P
One-Inch Loop Antenna	To ensure measurement accuracy, no substitution is possible. Fabrication depends upon machining and assembling to very close tolerances.	HP 08640-60501	P
10 dB Step Attenuator	Attenuation: 0 - 120 dB in 10 dB steps Range: 0.45 - 550 MHz Accuracy: $\pm 1.5$ dB to 90 dB $\pm 0.3$ dB to 120 dB (below 1 kHz)	HP 355D	P,A
Calibrated Step Attenuator	Attenuation: 0 - 120 dB in 10 dB steps Accuracy: $\pm (0.02 + 0.015 \text{ dB}/10 \text{ dB step})$ at 3 MHz	HP 355D Option H36	P,A
* P = Performance; A = Adjustment; T = Troubleshooting			

Table 1-2. Recommended Test Equipment (2 of 7)

Instrument Type	Critical Specifications	Suggested Model	Use*
3 dB Attenuator	Accuracy: $\pm 0.5$ dB to 550 MHz	HP 8491A Option 003	P,A
10 dB Attenuator	Accuracy: $\pm 0.5$ dB to 550 MHz	HP 8491A Option 010	P,A
20 dB Attenuator	Accuracy: $\pm 0.5$ dB to 550 MHz	HP 8491A Option 020	P,A
Crystal Detector	Range: 0.45 - 550 MHz Low Level Sensitivity: $> 0.35$ mV/ $\mu$ W No internal dc return	HP 8471A	P
Crystal Detector	Range: 10 - 550 MHz Maximum Sensitivity: at 15 - 17 dBm input With internal dc return	HP 423A	P
Digital Voltmeter	DC Accuracy: $\pm$ (0.01% of reading +0.02% of range) AC (True RMS) Accuracy: $\pm 0.1\%$ of reading Ohms Range: to 1 k $\Omega$	HP 3480B/ 3484A (with Options 042, 043)	P,A,T
Digital to Analog Converter	Accuracy: 1% of full scale Input Code: 1248 with 1 (on) state positive (compatible with Fre- quency Counter) Output: Compatible with Strip Chart Recorder	HP 581A Option 002	P
Directional Coupler	Range: 100 - 550 MHz Coupling Attenuation: 20 dB Directivity: 36 dB VSWR: $< 1.1:1$	HP 778D Option 12	P
Distortion Analyzer	Range: 20 Hz to 600 kHz Distortion Range: $< 0.1\%$ Minimum Input: $< 300$ mVrms	HP 333A	P
FM Discriminator	Ranges: 100 kHz to 10 MHz Linear Analog Output: 1V for full scale	HP 5210A	P,A
* P = Performance; A = Adjustment; T = Troubleshooting			

Table 1-2. Recommended Test Equipment (3 of 7)

Instrument Type	Critical Specifications	Suggested Model	Use*
With Filter Kit	Output Low Pass Filters for FM Discriminator (20 kHz and 1 MHz Butterworth filters)	With HP 10531A	P,A
600 Ohm Feedthrough	Impedance: $600\Omega \pm 1\%$ shunt Connectors: BNC	HP 11095A	P,A
520 MHz Notch Filter	Notch Frequency Accuracy: 500 - 540 MHz Notch Rejection: >60 dB See Figure 1-7	HP 08640-60502	P
4 MHz Low Pass Filter (2 required)	4 MHz low pass (3 pole) Impedance: $50\Omega$ VSWR: <1.5:1 Ripple: $<\pm 0.2$ dB	CIR-Q-TEL FLT/21B-4-3/ 50-3A/3B	P,A
1.5 MHz Low Pass Filter	1.5 MHz low pass (3 pole) Impedance: $50\Omega$ VSWR: <1.5:1 Ripple: $<\pm 0.2$ dB	CIR-Q-TEL FLT/21B- 1500K-3/50- 3A/3B	P,A
15 kHz Low Pass Filter	15 kHz low pass (7 pole) Impedance: $50\Omega$ Ripple: $<\pm 0.2$ dB	CIR-Q-TEL FLT/21B-15K- 7/50-3A/3B	P
3 kHz Low Pass Filter	3 kHz low pass (5 pole) Impedance: $50\Omega$ Ripple: $<\pm 0.2$ dB	CIR-Q-TEL FLT/21B-3K- 5/50-3A/3B	P
Frequency Counter	Range: to 550 MHz Input Sensitivity: <100 mV Inputs: $50\Omega$ and high impedance (1 M $\Omega$ ) Standard Reference Accuracy: < $3 \times 10^{-7}$ /month aging rate < $5 \times 10^{-9}$ /s rms short term stability < $\pm 2.5 \times 10^{-6}$ , 0 - 50°C temper- ature stability	HP 5327C	P,A,T
	Optional Reference Accuracy: < $3 \times 10^{-9}$ /day aging rate < $1 \times 10^{-10}$ /s rms short term stability < $1 \times 10^{-8}$ , 0 - 50°C temper- ature stability	Option H49	P
* P = Performance; A = Adjustments; T = Troubleshooting			

Table 1-2. Recommended Test Equipment (4 of 7)

Instrument Type	Critical Specifications	Suggested Model	Use*
Frequency Counter (Cont'd)	Optional Digital Output: 1248 with 1 (on) state positive (compatible with D/A Converter)	Option 003	P
Function Generator	Range: 0.1 Hz to 1 kHz Output Impedance: 600 $\Omega$ Output Level: >1 Vpk	HP 3300A	P,A
FM Linearity Circuit	See Figure 1-8	HP 08640-60503	A
Mixer (3 required)	Double Balanced Range: 0.45 - 550 MHz	HP 10514A	P,A
Noise Phase Lock Circuit	See Figure 1-9	HP 08640-60504	P
Oscilloscope	50 MHz Real Time Sensitivity: 5 mV/division Internal/External Sweep and Triggering	HP 180A/1801A/ 1820C	P,A,T
Power Meter	Range: 0.45 - 550 MHz Input: -20 to +10 dBm Accuracy: 1%	HP 432A	P,A,T
With Thermistor Mount	VSWR: <1.3:1	With HP 478A Option H63	
Power Meter	Range: 10 - 550 MHz Input Level: -10 to +20 dBm Accuracy: $\pm 1\%$ of reading	HP 435A	P,A
With Power Sensor (Thermocouple)	VSWR: <1.18:1	With HP 8481A	
Pulse Generator	Range: 50 Hz to 500 kHz Output: >1V into 50 $\Omega$ Pulse Width: down to 1 $\mu$ s Transition Time: <50 ns	HP 8003A	P,T
Quartz Oscillator	Output: 1 MHz (level compatible with Frequency Counter) Stability: <5 x 10 <sup>-18</sup> /24 hours <5 x 10 <sup>-12</sup> /s	HP 105B	P
* P = Performance; A = Adjustments; T = Troubleshooting			

Table 1-2. Recommended Test Equipment (5 of 7)

Instrument Type	Critical Specifications	Suggested Model	Use*
RMS Voltmeter	Range: 10 Hz to 100 kHz Reading: True rms (ac only) Voltage Range: 1 mV to 10V full scale Accuracy: 1% of full scale 50 Hz to 50 kHz Scale: Voltage and dB	HP 3400A	P
Signal Generator	Range: 0.45 - 550 MHz Output: >13 dBm into 50 $\Omega$ Drift: <20 ppm/10 min. SSB Phase Noise: >130 dB down from 230 to 450 MHz increasing linearly to >122 dB down at 550 MHz (stated in a 1 Hz bandwidth at 20 kHz offset from carrier) and decreasing approximately 6 dB/octave for each divided down range — but need not be less than 140 dB down Residual FM: <15 Hz rms in 20 Hz to 15 kHz post-detection noise bandwidth; <5 Hz rms in 0.3-3 kHz post detection noise bandwidth Aux RF Out: >-5 dBm Leakage: <3 $\mu$ V induced in a 2-turn, 1-inch diameter loop 1 inch away from any surface and measured into a 50 $\Omega$ receiver. FM: dc coupled; at least 40 kHz deviation for 1V input	HP 8640A	P,A
Audio Spectrum Analyzer	Range: 20 - 200 kHz Amplitude Calibration: Display Accuracy: $\pm 0.25$ dB/dB but not more than 1.5 dB over 70 dB dynamic range Flatness: $\pm 0.2$ dB Vertical Reference Scale: 10 dB/division log, 2 dB/division (or less) log, and linear display calibration Average Noise Level: <-120 dBm (50 $\Omega$ ) with 1 kHz IF bandwidth Spurious Responses: >60 dB down for nominal specified inputs	HP 141T/ 8552B/8556A	P
* P = Performance; A = Adjustments; T = Troubleshooting			

Table 1-2. Recommended Test Equipment (6 of 7)

Instrument Type	Critical Specifications	Suggested Model	Use*
Audio Spectrum Analyzer (Cont'd)	Tracking Generator: Flatness: $\pm 0.25$ dB Level: $> 3$ Vrms into $600\Omega$		
Spectrum Analyzer	Range: 0.5 - 1200 MHz Amplitude Calibration: Display Accuracy: $\pm 0.25$ dB/dB but not more than 1.5 dB over 70 dB dynamic range Flatness: $\pm 1$ dB IF Gain Step Accuracy: $\pm 0.2$ dB Vertical Reference Scale: 10 dB/ division log, 2 dB/division (or less) log, and linear display cali- bration Average Noise Level: $< -102$ dBm with 10 kHz IF bandwidth Spurious Responses: $> 60$ dB down for inputs of $-40$ dBm or less Span Width: 0 - 1 GHz Compatible with Tracking Generator	HP 141T/ 8552B/8554B	P,A
Spectrum Analyzer	Range: 0.45 - 100 MHz IF Bandwidths: down to 10 Hz All other specifications are the same as the HP 141T/8552B/8554B listed above except Span Width which should be 0 - 100 MHz (should be compatible with Tracking Generator).	HP 141T/ 8552B/8553B	P,A
Recorder (Strip Chart)	Compatible with Digital to Analog Converter Accuracy: 0.5% of full scale	HP 680	P
Temperature Controlled Chamber	Range: 0 - $55^{\circ}\text{C}$	Statham Model 325	P
Test Oscillator	Range: 20 Hz to 600 kHz Output Impedance: $600\Omega$ and $50\Omega$ Distortion: $> 40$ dB down Output Level: $> 1$ Vrms	HP 652A	P,A,T
* P = Performance; A = Adjustments; T = Troubleshooting			

Table 1-2. Recommended Test Equipment (7 of 7)

Instrument Type	Critical Specifications	Suggested Model	Use*
Tracking Generator	Output: to 0 dBm (50 $\Omega$ ) Flatness: $\pm 0.5$ dB Compatible with Spectrum Analyzer (HP 141T/8552B/8554B)	HP 8444A	P,A
Tracking Generator	Output: to 0 dBm (50 $\Omega$ ) Compatible with Spectrum Analyzer, (HP 141T/8552B/8553B)	HP 8443B	P,A
Variable Phase Oscillator	Range: 20 Hz to 60 kHz Output Impedance: 600 $\Omega$ Phase Variability: 0 to 360 $^\circ$ Distortion: >64 dB down	HP 203A	P,A
Variable Voltage Transformer	Range: +5% to -10% of nominal line voltage (100, 120, 220 or 240 volts). For 120V, range is 105 - 130 Vrms. Metered Accuracy: $\pm 1$ Vrms	GR W5MT3A	P
Vector Voltmeter	Range: 1 - 550 MHz Sensitivity: <20 $\mu$ V Phase Range: $\pm 18^\circ$ full scale down to $\pm 6^\circ$ full scale Phase Resolution: 0.1 $^\circ$ Phase Accuracy: $\pm 1.5^\circ$ Voltage Ratio Accuracy: 0.2 dB	HP 8405A	P
VSWR Bridge	Range: 0.45 - 550 MHz Directivity: >40 dB Connectors: Type N	Wiltron Model 60N50	P
* P = Performance; A = Adjustments; T = Troubleshooting			



Table 1-3. Recommended Test Accessories

Accessory Type	Suggested Model
Adapter (Type N Male and BNC Female connectors)	HP 1250-0067
Adapter (BNC Male and dual Banana post connectors)	HP 10110A
Adapter (two SMC Male connectors)	HP 1250-0827
Double Shielded Cable (BNC Male connectors, Coaxial)	HP 08708-6033
Nine-Inch Cable (BNC Male connectors, Coaxial)	HP 10502A
Test Cable (48-inch, BNC Male connectors, Coaxial)	HP 10503A
Test Cable (SMC Male and BNC Male connectors)	HP 11592-60001
50 Ohm Load (Male, BNC, Coaxial)	HP 11593A
Coaxial Short (Male Type N)	HP 11512A
Tee (Coaxial, BNC, one Male and two Female connectors)	HP 1250-0781
Voltage Probe (1:1)	HP 10025A
Extender Board (20 pins)	HP 5060-0827
Bumpers (2) for Extender Board	HP 0403-0115
5 $\mu$ F Capacitor	HP 0180-2211
100 $\mu$ F Capacitor	HP 0180-0094
0.001 $\mu$ F Capacitor	HP 0160-0153
0.033 $\mu$ F Capacitor	HP 0160-0163
100 k $\Omega$ Resistor	HP 0757-0465
10 k $\Omega$ Resistor	HP 0757-0442
SPST Switch	HP 3101-0163



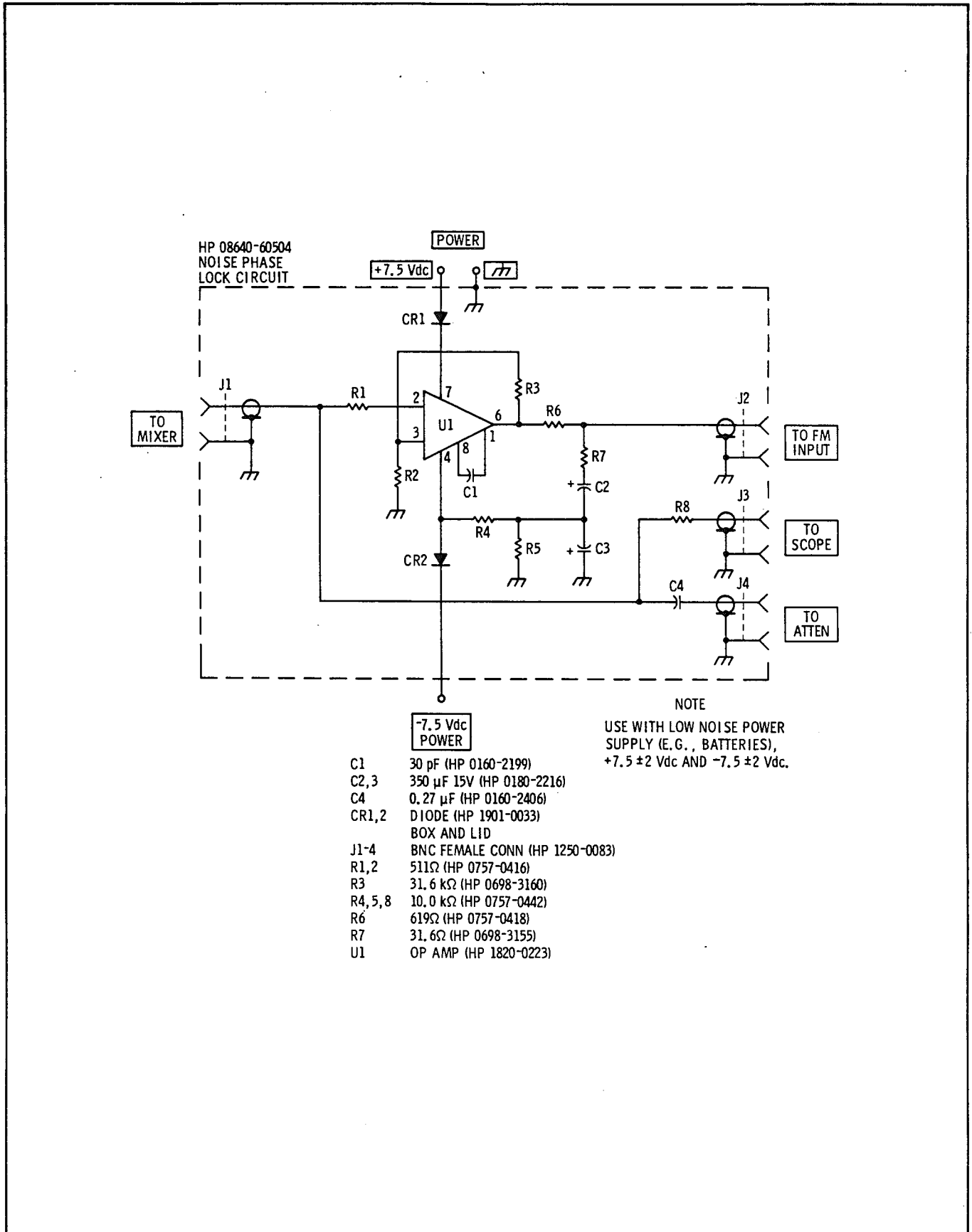

Figure 1-9. Noise Phase Lock Circuit

## SECTION II INSTALLATION

### 2-1. INTRODUCTION

2-2. This section explains how to prepare the Model 8640B Signal Generator for use. It explains how to connect the instrument to accept available line voltage, and it also describes bench operation, rack mounting, storage, and shipment.

### 2-3. INITIAL INSPECTION

2-4. Inspect the shipping container for damage. If the shipping container or cushioning material is damaged it should be kept until the contents of the shipment have been checked for completeness and the instrument has been checked mechanically and electrically. The contents of the shipment should be as shown in Figure 1-1, and procedures for checking electrical performance are given in

Section IV. If the contents are incomplete, if there is mechanical damage or defect, or if the instrument does not pass the electrical performance test, notify the nearest Hewlett-Packard office. If the shipping container is damaged, or the cushioning material shows signs of stress, notify the carrier as well as the Hewlett-Packard office. Keep the shipping materials for carrier's inspection. The HP office will arrange for repair or replacement without waiting for claim settlement.

### 2-5. PREPARATION FOR USE

#### 2-6. Power Requirements

2-7. The Model 8640B requires a power source of 100, 120, 220, or 240 Vac +5-10%, 48 to 440 Hz, single phase. Power consumption is 175 VA maximum.

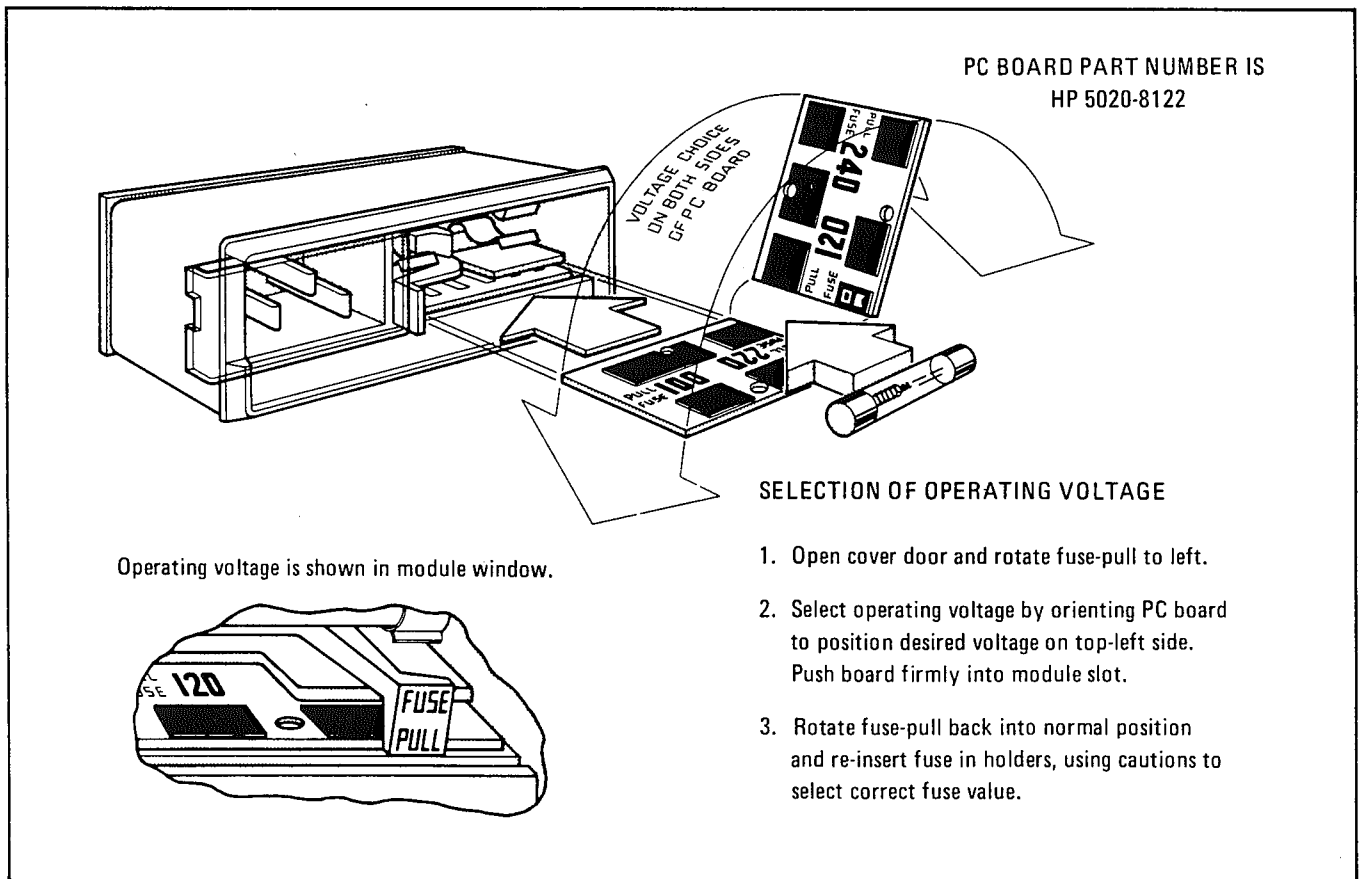

Figure 2-1. Line Selector

2-8. Line Voltage Selection

**CAUTION**

To prevent damage to the instrument, make the line voltage selection *before* connecting line power. Also ensure the the line power cord is connected to a line power socket that is provided with a protective earth contact.

2-9. A rear panel, line power module permits operation from 100, 120, 220, or 240 Vac. The number visible in the window (located on the module) indicates the nominal line voltage to which the instrument must be connected.

2-10. To prepare the instrument for operation, slide the fuse compartment cover to the left (the line power cable should be disconnected). Pull the handle marked FUSE PULL and remove the fuse; rotate the handle to the left. Gently pull the printed circuit voltage selector card from its slot and orient it so that the desired operating voltage appears on the top-left side (see Figure 2-1).

Firmly push the voltage selector card back into its slot. Rotate the FUSE PULL handle to the right, install a fuse of the correct rating, and slide the fuse compartment cover to the right. A complete set of fuses is supplied with the instrument - see ACCESSORIES SUPPLIED in Section I.

**NOTE**

The correct fuse rating for the line voltage selected is listed on the line power module. More information about fuses is given in the table of replaceable parts in Section VI (reference designation is F1).

2-11. Power Cable

2-12. In accordance with international safety standards, this instrument is equipped with a three-wire power cable. When connected to an appropriate power line outlet, this cable grounds the instrument cabinet. The type of power cable plug shipped with each instrument depends on the country of destination. Refer to Figure 2-2 for the part numbers of the power cable plugs available.

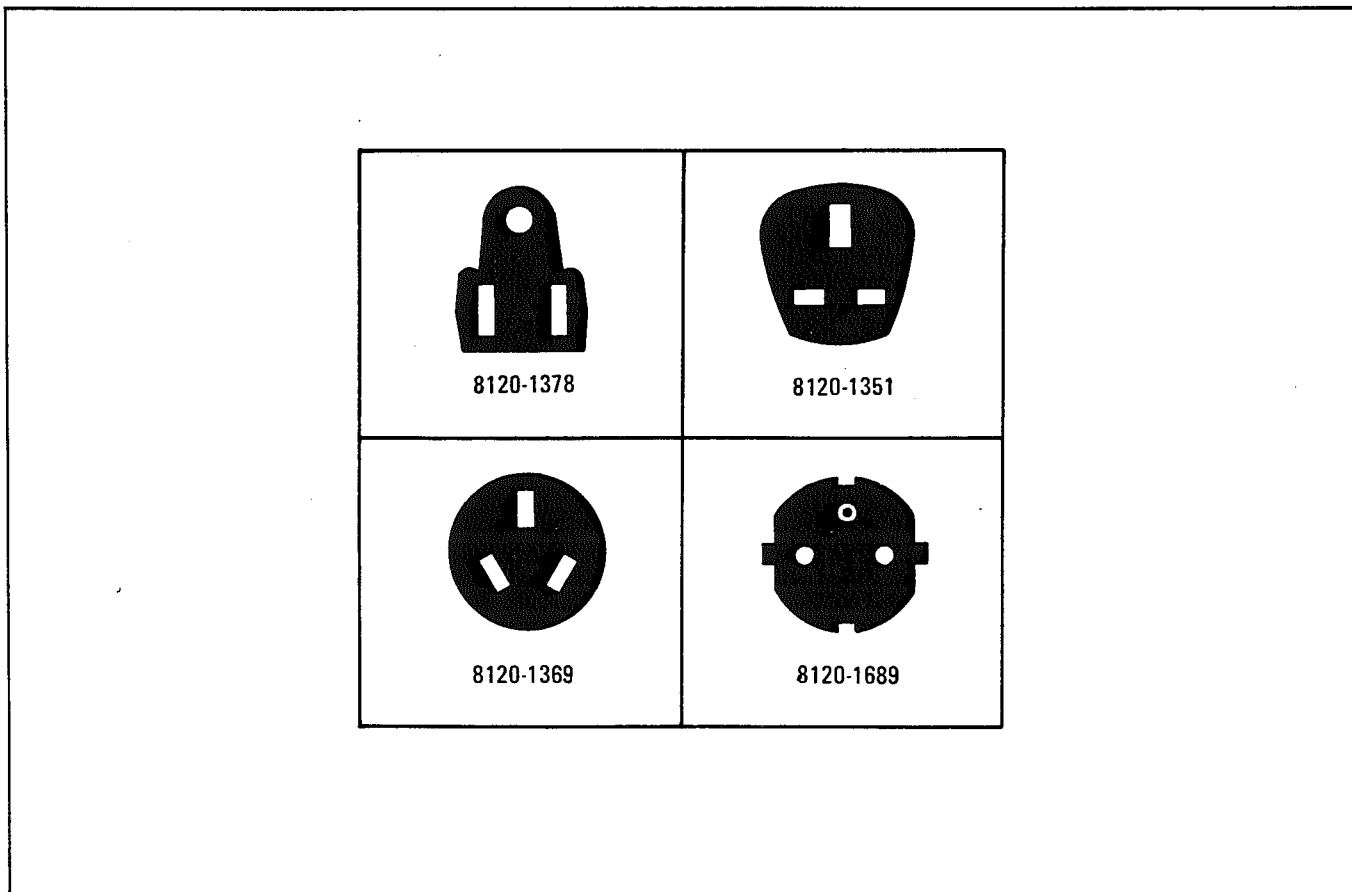

Figure 2-2. Power Cables Available

**WARNING**

To avoid the possibility of injury or death, the following precautions must be followed before the instrument is switched on:

- a. If this instrument is to be energized via an autotransformer for voltage reduction, make sure that the common terminal is connected to the earthed pole of the power source.
- b. The power cable plug shall only be inserted into a socket outlet provided with a protective earth contact. The protective action must not be negated by the use of an extension cord without a protective conductor (grounding).
- c. Before switching on the instrument, the protective earth terminal of the instrument must be connected to a protective conductor of the power cord. This is accomplished by ensuring that the instrument's internal earth terminal is correctly connected to the instrument's chassis and that the power cord is wired correctly (see Service Sheet 22).

**2-13. Mating Connectors**

2-14. Mating connectors used with the Model 8640B should be either 50 ohm-type BNC male or Type N male connectors that are compatible with US MIL-C-39012.

**2-15. Operating Environment**

2-16. The operating environment should be within the following limitations:

Temperature . . . . .	0°C to +55°C
Humidity . . . . .	<95% relative
Altitude . . . . .	<15,000 feet

2-17. A forced-air cooling system is used to maintain the operating temperature required within the instrument. The air intake and filter are located on the rear panel, and warm air is exhausted through perforations in the right-hand side panel. When operating the instrument, choose a location that provides at least three inches of clearance at the rear and two inches clearance at the right side. The clearances provided by the

plastic feet in bench stacking and the filler strips in rack mounting are adequate for the top and bottom cabinet surfaces.

**2-18. Bench Operation**

2-19. The instrument cabinet has plastic feet and a foldaway tilt stand for convenience in bench operation. The tilt stand raises the front of the instrument for easier viewing of the control panel, and the plastic feet are shaped to make full-width modular instruments self-aligning when stacked.

**2-20. Rack Mounting**

2-21. This instrument is supplied with a rack mounting kit. This kit contains all the necessary hardware and installation instructions for mounting the instrument on a rack with 19 inch spacing (see Figure 2-3).

**2-22. STORAGE AND SHIPMENT**

**2-23. Environment**

2-24. The instrument should be stored in a clean, dry environment. The following environmental limitations apply to both storage and shipment:

Temperature . . . . .	-40°C to +75°C
Humidity . . . . .	<95% relative
Altitude . . . . .	<25,000 feet

**2-25. Packaging**

2-26. **Original Packaging.** Containers and materials identical to those used in factory packaging are available through Hewlett-Packard offices. If the instrument is being returned to Hewlett-Packard for servicing, attach a tag indicating the type of service required, return address, model number, and full serial number. Also, mark the container FRAGILE to assure careful handling. In any correspondence, refer to the instrument by model number and full serial number.

2-27. **Other Packaging.** The following general instructions should be used for re-packaging with commercially available materials:

- a. Wrap the instrument in heavy paper or plastic. (If shipping to a Hewlett-Packard office or service center, attach a tag indicating the type of service required, return address, model number, and full serial number.)

b. Use a strong shipping container. A double-wall carton made of 350-pound test material is adequate.

c. Use enough shock-absorbing material (3- to 4-inch layer) around all sides of the instrument to provide a firm cushion and prevent movement

inside the container. Protect the control panel with cardboard.

d. Seal the shipping container securely.

e. Mark the shipping container **FRAGILE** to assure careful handling.

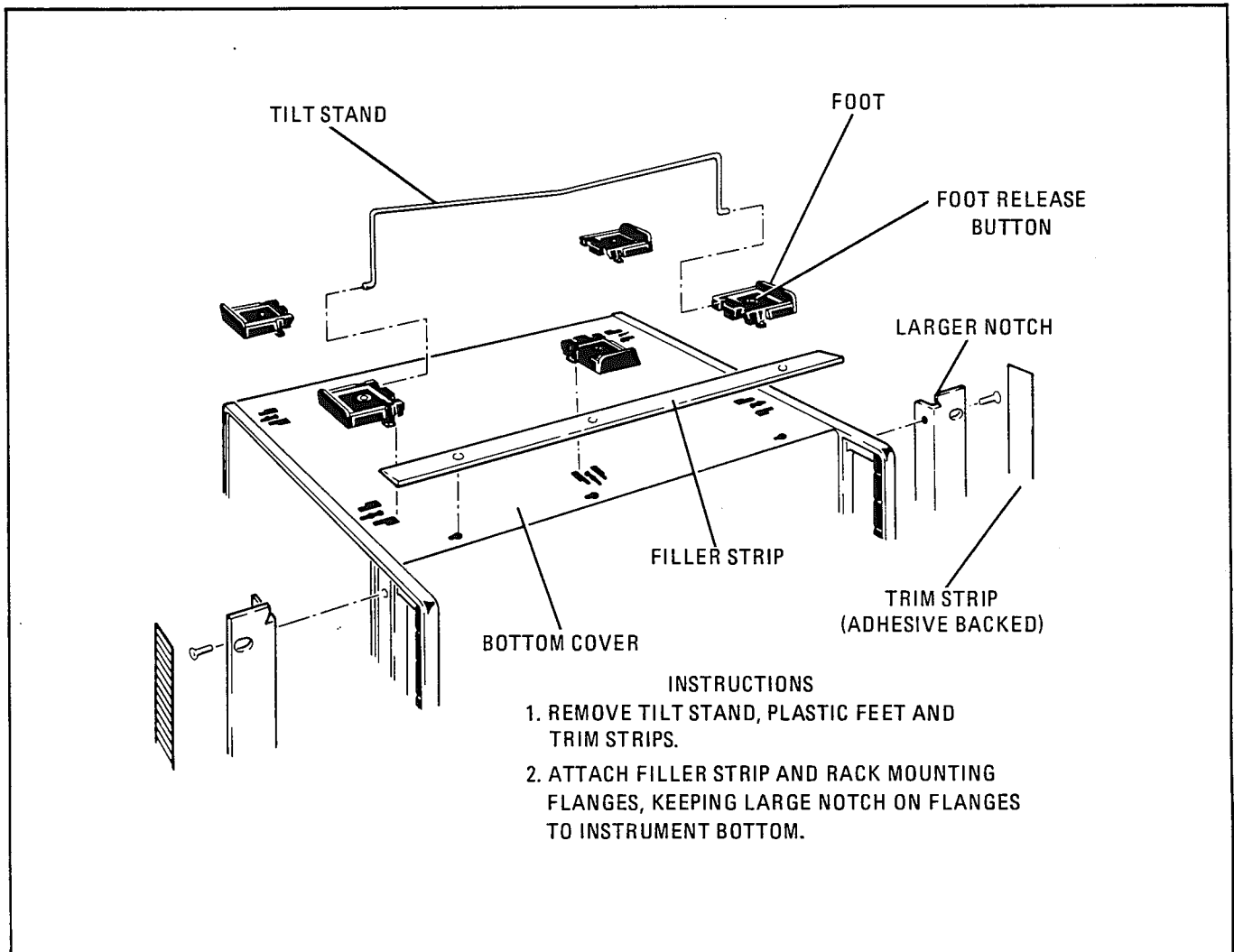

Figure 2-3. Preparation for Rack Mounting

## SECTION III OPERATION

### 3-1. INTRODUCTION

3-2. This section describes the functions of the controls and indicators of the Model 8640B Signal Generator. It explains how to set the frequency, amplitude, and modulation controls, and covers such operator maintenance as fuse and indicator lamp replacement and fan filter cleaning.

### 3-3. PANEL FEATURES

3-4. Front panel controls, indicators, and connectors are shown and described in Figure 3-2. Rear panel controls and connectors are shown and described in Figure 3-3.

### 3-5. OPERATOR'S CHECKS

3-6. Use the operator's checks in Figure 3-4 to verify proper operation of the Signal Generator's main functions.

### 3-7. OPERATING INSTRUCTIONS

3-8. Figures 3-5 and 3-6 explain how to set the frequency, amplitude, and modulation controls. Figure 3-5 also explains how to use the frequency counter and phase lock controls.

### 3-9. OPERATOR'S MAINTENANCE

3-10. **Fuse.** The main ac line fuse is located on the rear panel next to the line power cable jack. To remove the fuse, first remove the line power cable from its jack. Slide the fuse compartment cover to the left, then pull the handle marked FUSE PULL and remove the fuse.

#### CAUTION

Be sure to select the correct fuse rating for the selected line voltage (see **LINE VOLTAGE SELECTION** in Section II); fuse ratings are listed on the fuse compartment.

3-11. **Fan.** The cooling fan's filter is located on the rear panel. To service the filter use a No. 2 Pozidriv screwdriver (HP 8710-0900) to remove the four screws that hold the filter to the rear

panel. Then clean it, using a solution of warm water and soap, or replace it, using the part number listed in the table of replaceable parts in Section VI.

3-12. The fan motor has factory lubricated, sealed bearings and requires no periodic maintenance.

3-13. **Lamp Replacement.** Figure 3-1 explains how to replace the lamp located in the line power switch.

3-14. **Meter Zeroing.** To mechanically zero the front panel meter, set **LINE** switch to **OFF** and place instrument in its normal operating position. Turn adjustment screw cw until indicator indicates zero, then turn adjustment slightly ccw to free mechanism from adjusting peg.

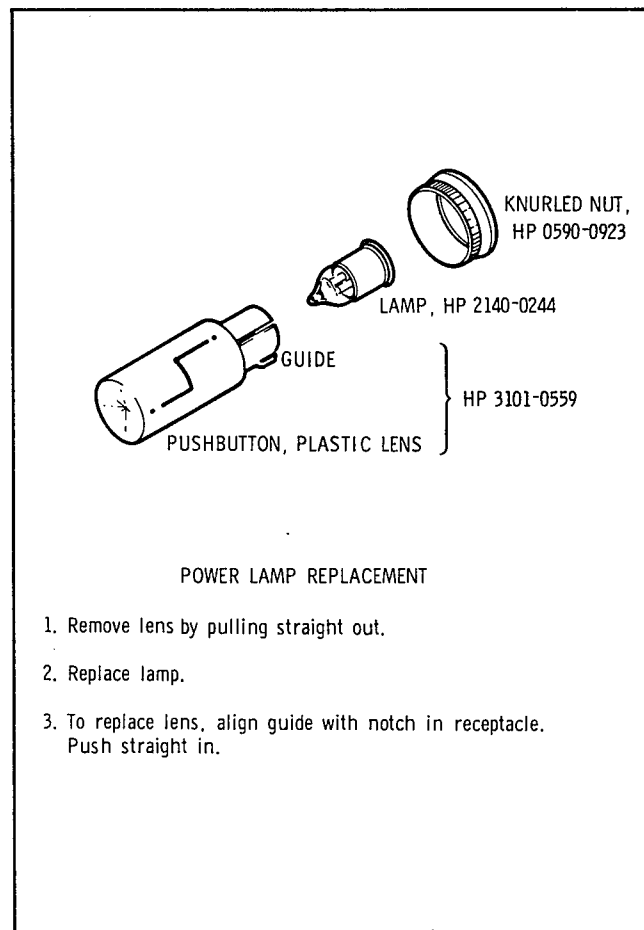
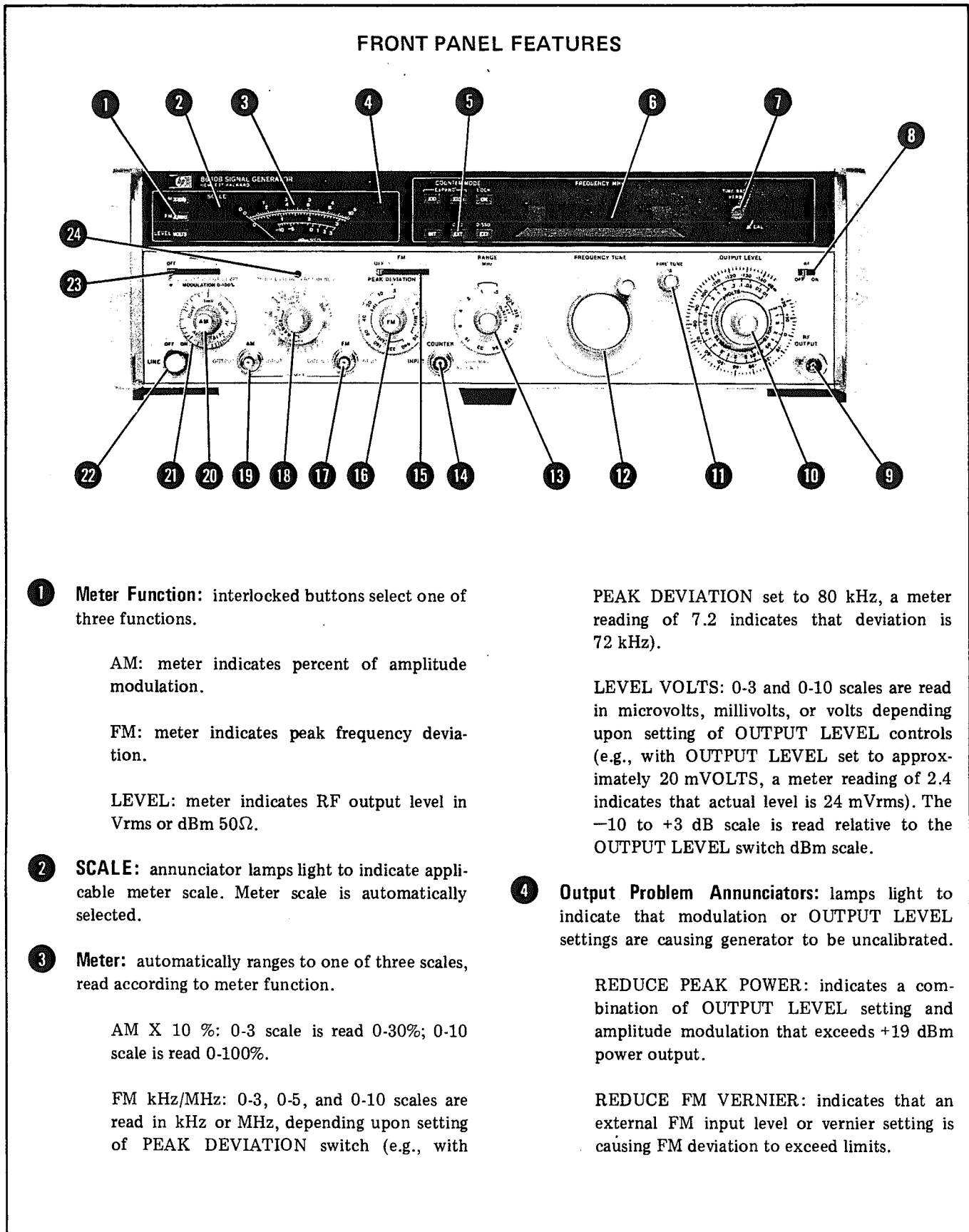

Figure 3-1. Lamp Replacement





**1 Meter Function:** interlocked buttons select one of three functions.

- AM: meter indicates percent of amplitude modulation.
- FM: meter indicates peak frequency deviation.
- LEVEL: meter indicates RF output level in Vrms or dBm 50Ω.

**2 SCALE:** annunciator lamps light to indicate applicable meter scale. Meter scale is automatically selected.

**3 Meter:** automatically ranges to one of three scales, read according to meter function.

- AM X 10 %: 0-3 scale is read 0-30%; 0-10 scale is read 0-100%.
- FM kHz/MHz: 0-3, 0-5, and 0-10 scales are read in kHz or MHz, depending upon setting of PEAK DEVIATION switch (e.g., with

PEAK DEVIATION set to 80 kHz, a meter reading of 7.2 indicates that deviation is 72 kHz).

LEVEL VOLTS: 0-3 and 0-10 scales are read in microvolts, millivolts, or volts depending upon setting of OUTPUT LEVEL controls (e.g., with OUTPUT LEVEL set to approximately 20 mVOLTS, a meter reading of 2.4 indicates that actual level is 24 mVrms). The -10 to +3 dB scale is read relative to the OUTPUT LEVEL switch dBm scale.

**4 Output Problem Annunciators:** lamps light to indicate that modulation or OUTPUT LEVEL settings are causing generator to be uncalibrated.

REDUCE PEAK POWER: indicates a combination of OUTPUT LEVEL setting and amplitude modulation that exceeds +19 dBm power output.

REDUCE FM VERNIER: indicates that an external FM input level or vernier setting is causing FM deviation to exceed limits.

Figure 3-2. Front Panel Controls, Indicators, and Connectors (1 of 4)

## FRONT PANEL FEATURES

**REDUCE PEAK DEVIATION:** indicates PEAK DEVIATION setting is too high for the selected frequency range.

- 5 COUNTER MODE:** Buttons control operation of frequency counter.

**EXPAND:** X10 expands resolution one digit, moving the decimal point one place to the left; X100 expands resolution two digits, moving the decimal point two places to the left.

**NOTE**

EXPAND X10 and EXPAND X100 buttons are interlocked so that only one button can be depressed at a time.

**LOCK:** phase locks Signal Generator to the internal (or to an external) crystal reference. Display indicates lock frequency; loss of lock causes display to flash and indicate actual frequency of Signal Generator.

**INT:** programs counter to count frequency of Signal Generator.

**EXT 0-10, EXT 0-550:** programs counter to count frequency of signal at COUNTER INPUT jack; also selects counter frequency range in MHz.

- 6 FREQUENCY MHz:** counter readout indicates RF frequency in MHz. Flashing display indicates loss of phase lock. The OVERFLOW lamp lights to indicate that significant data is not being displayed.

- 7 TIME BASE VERNIER:** used as a fine frequency tune when in lock mode to give continuous tuning between lock points (the use of the COUNTER MODE EXPAND X10 control is necessary on some ranges to tune over the full range). When control is not in CAL position, the UNCAL lamp lights to indicate that the counter is uncalibrated.

- 8 RF ON/OFF:** enables or disables the RF output.

- 9 RF OUTPUT:** RF output through Type N female connector. (Connector meets US MIL-C-39012.) 50 ohm ac coupled source impedance.

**CAUTION**

Any interruption of the protective (grounding) conductor inside or outside the instrument is likely to cause damage to the instrument. To avoid damage, this instrument and all line powered devices connected to it must be connected to the same earth ground (see Section II).

- 10 OUTPUT LEVEL:** the switch controls a 10 dB step attenuator that sets the output level range. Calibrated concentric vernier sets actual output level within an 18 dB range (the meter gives additional resolution).

**NOTE**

For optimum operation, use the vernier in the top 10 dB of its range.

- 11 FINE TUNE:** fine frequency control.
- 12 FREQUENCY TUNE:** coarse frequency control.
- 13 RANGE:** selects one of ten octave frequency bands. The 512-1024 MHz/Doubler position gives 256-512 MHz at RF OUTPUT, but the FREQUENCY MHz readings and FM meter indications are corrected for use with an RF doubler connected to RF OUTPUT.
- 14 COUNTER INPUT:** external input to frequency counter; impedance is 50 ohms.

**CAUTION**

Do not apply a dc voltage or  $>+15$  dBm to COUNTER INPUT.

Figure 3-2. Front Panel Controls, Indicators, and Connectors (2 of 4)

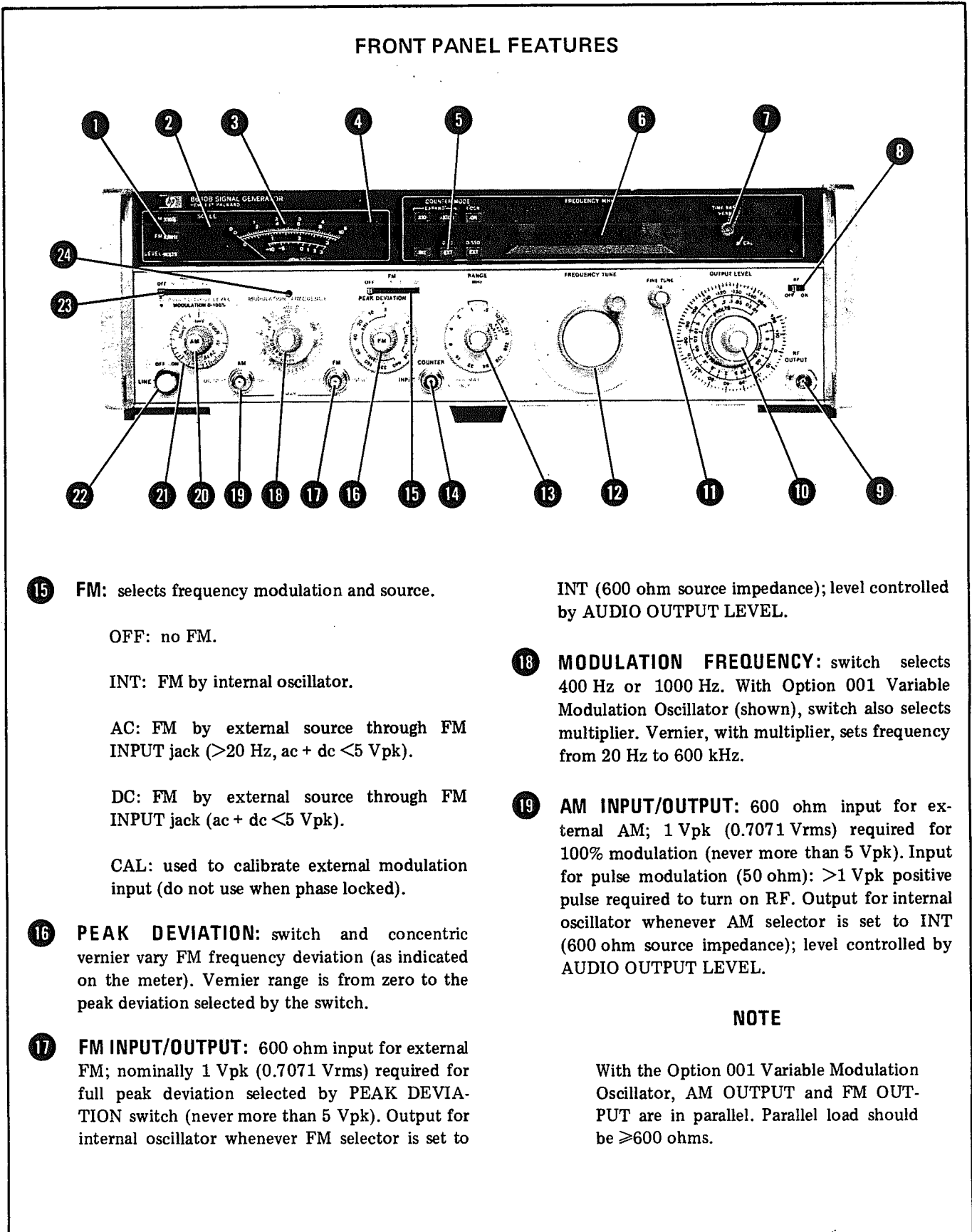

**15** **FM:** selects frequency modulation and source.

OFF: no FM.

INT: FM by internal oscillator.

AC: FM by external source through FM INPUT jack (>20 Hz, ac + dc <5 Vpk).

DC: FM by external source through FM INPUT jack (ac + dc <5 Vpk).

CAL: used to calibrate external modulation input (do not use when phase locked).

**16** **PEAK DEVIATION:** switch and concentric vernier vary FM frequency deviation (as indicated on the meter). Vernier range is from zero to the peak deviation selected by the switch.

**17** **FM INPUT/OUTPUT:** 600 ohm input for external FM; nominally 1 Vpk (0.7071 Vrms) required for full peak deviation selected by PEAK DEVIATION switch (never more than 5 Vpk). Output for internal oscillator whenever FM selector is set to

INT (600 ohm source impedance); level controlled by AUDIO OUTPUT LEVEL.

**18** **MODULATION FREQUENCY:** switch selects 400 Hz or 1000 Hz. With Option 001 Variable Modulation Oscillator (shown), switch also selects multiplier. Vernier, with multiplier, sets frequency from 20 Hz to 600 kHz.

**19** **AM INPUT/OUTPUT:** 600 ohm input for external AM; 1 Vpk (0.7071 Vrms) required for 100% modulation (never more than 5 Vpk). Input for pulse modulation (50 ohm): >1 Vpk positive pulse required to turn on RF. Output for internal oscillator whenever AM selector is set to INT (600 ohm source impedance); level controlled by AUDIO OUTPUT LEVEL.

**NOTE**

With the Option 001 Variable Modulation Oscillator, AM OUTPUT and FM OUTPUT are in parallel. Parallel load should be ≥600 ohms.

Figure 3-2. Front Panel Controls, Indicators, and Connectors (3 of 4)

## FRONT PANEL FEATURES

20 **MODULATION:** vernier varies amplitude modulation from 0 to 100% (as indicated on the meter).

21 **AUDIO OUTPUT LEVEL:** control varies level of signal from AM and/or FM OUTPUT jacks (calibration gives voltage into  $600\Omega$ ).

22 **LINE:** switch applies or removes AC power. The button is lit when ON.

23 **AM:** selects amplitude modulation and source.

OFF: no AM.

INT: AM by internal oscillator.

AC: AM by external source through AM INPUT jack ( $>20$  Hz, ac + dc  $<5$  Vpk).

DC: AM by external source through AM INPUT jack (ac + dc  $<5$  Vpk).

PULSE: when selected with no modulation, it disables the RF output; a positive pulse at AM INPUT pulses on the RF.

24 **Mechanical Meter Zero:** sets meter suspension so that meter indicates zero when power is removed from instrument and instrument is in normal operating position.

Figure 3-2. Front Panel Controls, Indicators, and Connectors (4 of 4)

REAR PANEL FEATURES

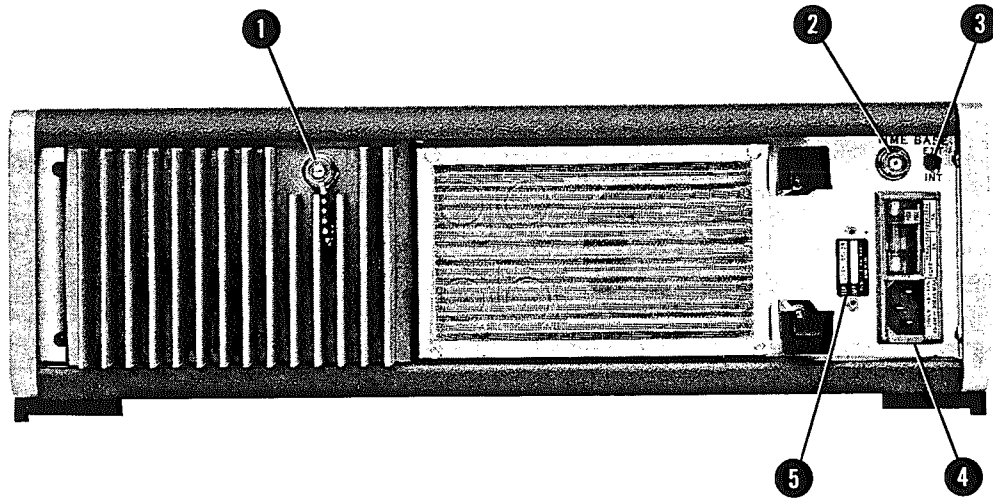

- 1 **AUX RF OUT:** nominal  $-5$  dBm auxiliary RF output; 500 ohm source impedance. Signal does not contain amplitude or pulse modulation (however, it does contain FM). On the 512-1024 MHz/Doubler Band the auxiliary RF output is one-half the frequency of the indicated RF frequency.
- 2 **TIME BASE Reference In/Out:** input for external, 5 MHz time base reference that is  $>100$  mVrms; load impedance is 1 k $\Omega$ . Output for internal, 5 MHz time base reference, level is 3 Vrms into an open circuit; source impedance is 500 ohms.
- 3 **TIME BASE Reference INT/EXT:** switch selects function of IN/OUT jack. INT position applies internal reference to jack. EXT position feeds external reference from jack to time base.

- 4 **Line Power Module:** permits operation from 100, 120, 220 or 240 Vac. The number visible in window indicates nominal line voltage to which instrument must be connected (see Figure 2-1). Center conductor is safety earth ground.

**WARNING**

Any interruption of the protective (grounding) conductor inside or outside the instrument or disconnection of the protective earth terminal is likely to make the instrument dangerous. Intentional interruption is prohibited. (See Section II).

**NOTE**

Since the phase lock reference is the 5 MHz time base, the Model 8640B can be phase locked to an external reference (such as another Model 8640B) by using the TIME BASE Reference jack and switch.

- 5 **Serial Number Plate:** first four digits of serial number comprise the prefix; last five digits form sequential suffix that is unique to each instrument. The plate also indicates any options supplied with instruments.

Figure 3-3. Rear Panel Controls and Connectors

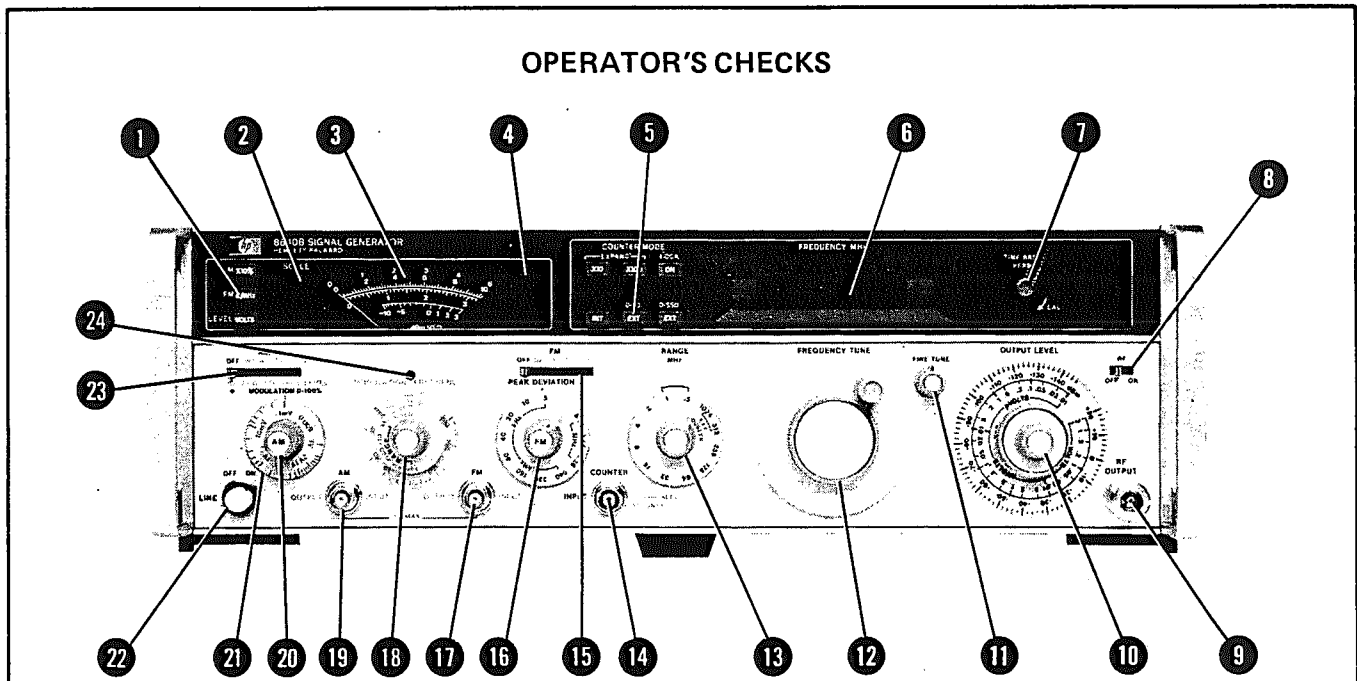

**Initial Control Settings**

- a. Push LINE switch **22** to ON. Set TIME BASE INT/EXT switch (on rear panel) to INT.
- b. Set the controls as follows:

<b>1</b>	Meter Function	.....	LEVEL
<b>5</b>	COUNTER MODE: EXPAND	.....	Off (Out)
	LOCK	.....	Off (Out)
	SOURCE	.....	INT (In)
<b>7</b>	TIME BASE VERNIER	.....	CAL
<b>23</b>	AM	.....	OFF
<b>21</b>	AUDIO OUTPUT LEVEL	.....	ccw
<b>20</b>	MODULATION	.....	ccw
<b>18</b>	MODULATION FREQUENCY	.....	400 Hz
<b>15</b>	FM	.....	OFF
<b>16</b>	PEAK DEVIATION	.....	5 kHz
<b>16</b>	PEAK DEVIATION Vernier	.....	ccw
<b>13</b>	RANGE	.....	0.5-1 MHz
<b>12</b>	FREQUENCY TUNE	.....	Centered (Four turns from stop)
<b>11</b>	FINE TUNE	.....	Centered
<b>10</b>	OUTPUT LEVEL	.....	100 mVOLTS
<b>8</b>	RF ON/OFF	.....	ON

Figure 3-4. Operator's Checks (1 of 5)

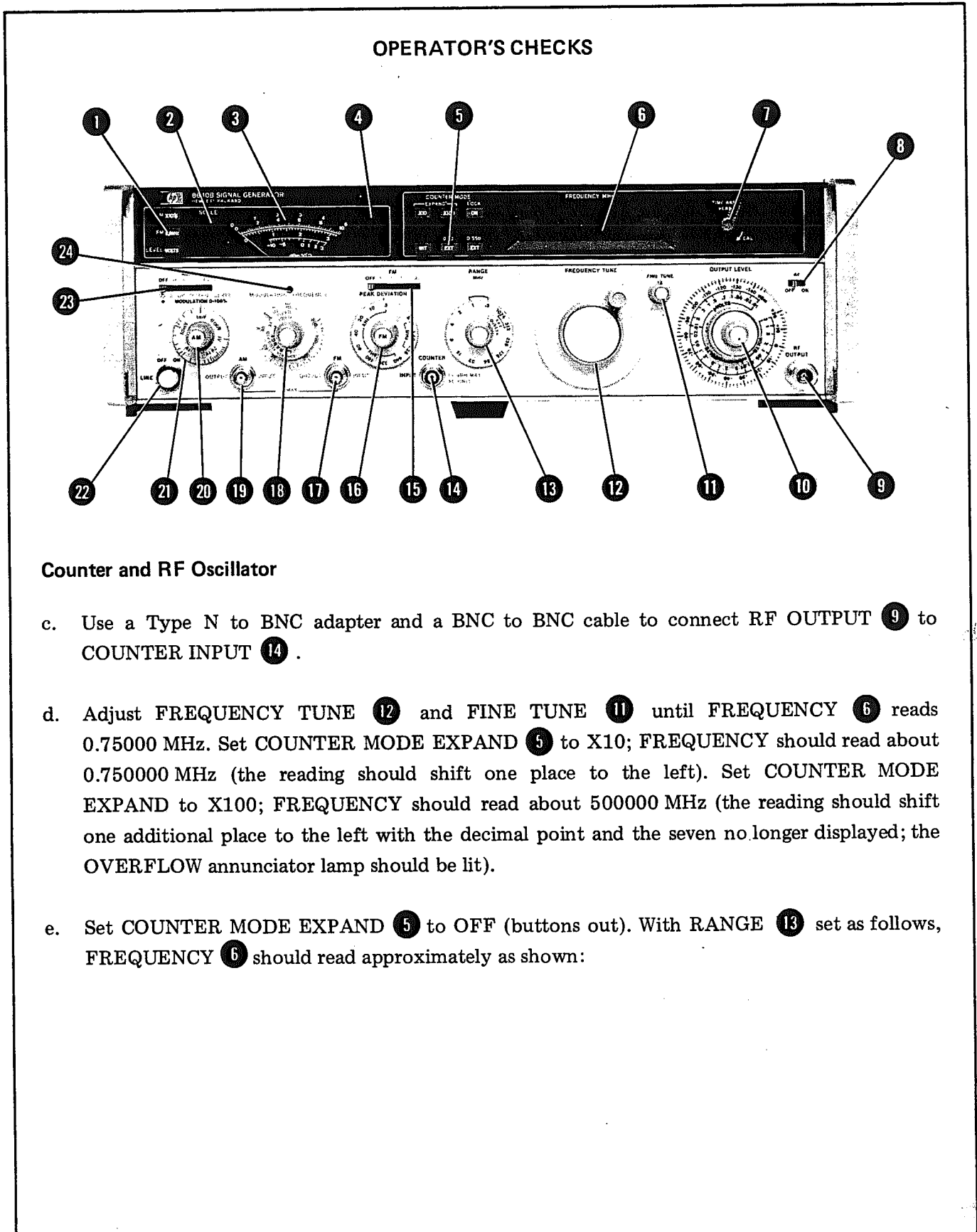

**Counter and RF Oscillator**

- c. Use a Type N to BNC adapter and a BNC to BNC cable to connect RF OUTPUT 9 to COUNTER INPUT 14 .
- d. Adjust FREQUENCY TUNE 12 and FINE TUNE 11 until FREQUENCY 6 reads 0.75000 MHz. Set COUNTER MODE EXPAND 5 to X10; FREQUENCY should read about 0.750000 MHz (the reading should shift one place to the left). Set COUNTER MODE EXPAND to X100; FREQUENCY should read about 500000 MHz (the reading should shift one additional place to the left with the decimal point and the seven no longer displayed; the OVERFLOW annunciator lamp should be lit).
- e. Set COUNTER MODE EXPAND 5 to OFF (buttons out). With RANGE 13 set as follows, FREQUENCY 6 should read approximately as shown:

Figure 3-4. Operator's Checks (2 of 5)

## OPERATOR'S CHECKS

RANGE MHz	FREQUENCY MHz
0.5-1	0.75000
1-2	01.5000
2-4	03.0000
4-8	06.0000
8-16	12.0000
16-32	024.000
32-64	048.000
64-128	096.000
128-256	0192.00
256-512	0384.00
512-1024	0768.00

## Phase Lock

- f. Set RANGE **13** to 256-512 MHz. Note that the right-hand digit on the FREQUENCY display **6** flickers between two digits. Set COUNTER MODE LOCK **5** to ON; the flickering should stop. Slowly adjust FINE TUNE; the FREQUENCY reading should not change. Adjust FREQUENCY TUNE **12**; the FREQUENCY display should flash at about a 2 Hz rate and the reading should change (the reading should follow FREQUENCY TUNE).

## RF Output

- g. Set COUNTER MODE LOCK **5** to OFF and Source **5** to EXT 0-550. Adjust FREQUENCY TUNE **12** until FREQUENCY **6** reads 0384.00 MHz. Step through the ranges as specified in step e, setting the COUNTER MODE EXPAND and Source (EXT) controls **5** to obtain appropriate resolution; FREQUENCY should read approximately as shown in step e.

## NOTE

With RANGE set to 512-1024 MHz, FREQUENCY will read approximately 0384.00 MHz (the actual frequency at RF OUTPUT).

## Meter

- h. Set OUTPUT LEVEL **10** to 500 mVOLTS; the meter **3** should indicate 5 on the 0-10 SCALE (the 0-10 SCALE annunciator **2** should be lit).

Figure 3-4. Operator's Checks (3 of 5)



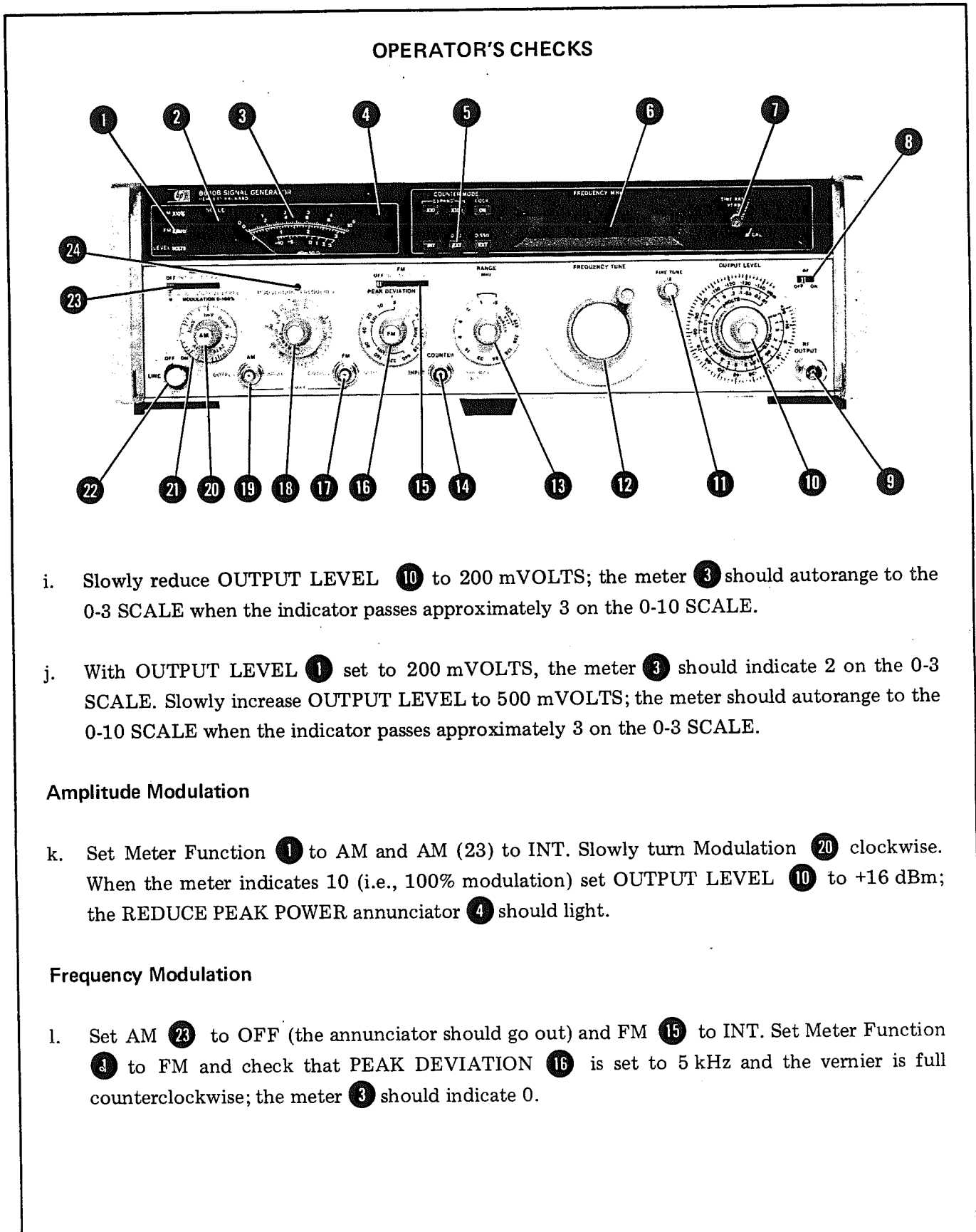

- i. Slowly reduce OUTPUT LEVEL 10 to 200 mVOLTS; the meter 3 should autorange to the 0-3 SCALE when the indicator passes approximately 3 on the 0-10 SCALE.
- j. With OUTPUT LEVEL 1 set to 200 mVOLTS, the meter 3 should indicate 2 on the 0-3 SCALE. Slowly increase OUTPUT LEVEL to 500 mVOLTS; the meter should autorange to the 0-10 SCALE when the indicator passes approximately 3 on the 0-3 SCALE.

**Amplitude Modulation**

- k. Set Meter Function 1 to AM and AM (23) to INT. Slowly turn Modulation 20 clockwise. When the meter indicates 10 (i.e., 100% modulation) set OUTPUT LEVEL 10 to +16 dBm; the REDUCE PEAK POWER annunciator 4 should light.

**Frequency Modulation**

- l. Set AM 23 to OFF (the annunciator should go out) and FM 15 to INT. Set Meter Function 2 to FM and check that PEAK DEVIATION 16 is set to 5 kHz and the vernier is full counterclockwise; the meter 3 should indicate 0.

Figure 3-4. Operator's Checks (4 of 5)

**OPERATOR'S CHECKS**

- m. Turn the PEAK DEVIATION vernier ⑩ full clockwise; the meter ③ should indicate approximately 5 and the REDUCE FM VERNIER annunciator ④ should light.
- n. Reduce FM vernier ⑩ until meter reads 5 kHz (the annunciator should go out). Check that RANGE ⑬ is set to 0.5-1 MHz, and set PEAK DEVIATION ⑩ to 10 kHz; the REDUCE PEAK DEVIATION annunciator ④ should light and the meter should indicate 0.
- o. Set RANGE ⑬ to 1-2 MHz (the annunciator should go out) and turn the PEAK DEVIATION vernier ⑩ full counterclockwise; the meter ③ should indicate 0 on the 0-10 SCALE.

**Modulation Oscillator**

- p. Using the BNC to BNC cable, connect FM OUTPUT ⑰ to COUNTER INPUT ⑭. Set COUNTER MODE EXPAND ⑤ to X100 and Source ⑤ to EXT 0-10. Set AUDIO OUTPUT LEVEL ⑳ to 1 V and MODULATION FREQUENCY ⑱, in turn, to 400 Hz and 1 kHz; the FREQUENCY readout ⑥ should display approximately "0.000400" and "0.001000" MHz.

*Figure 3-4. Operator's Checks (5 of 5)*

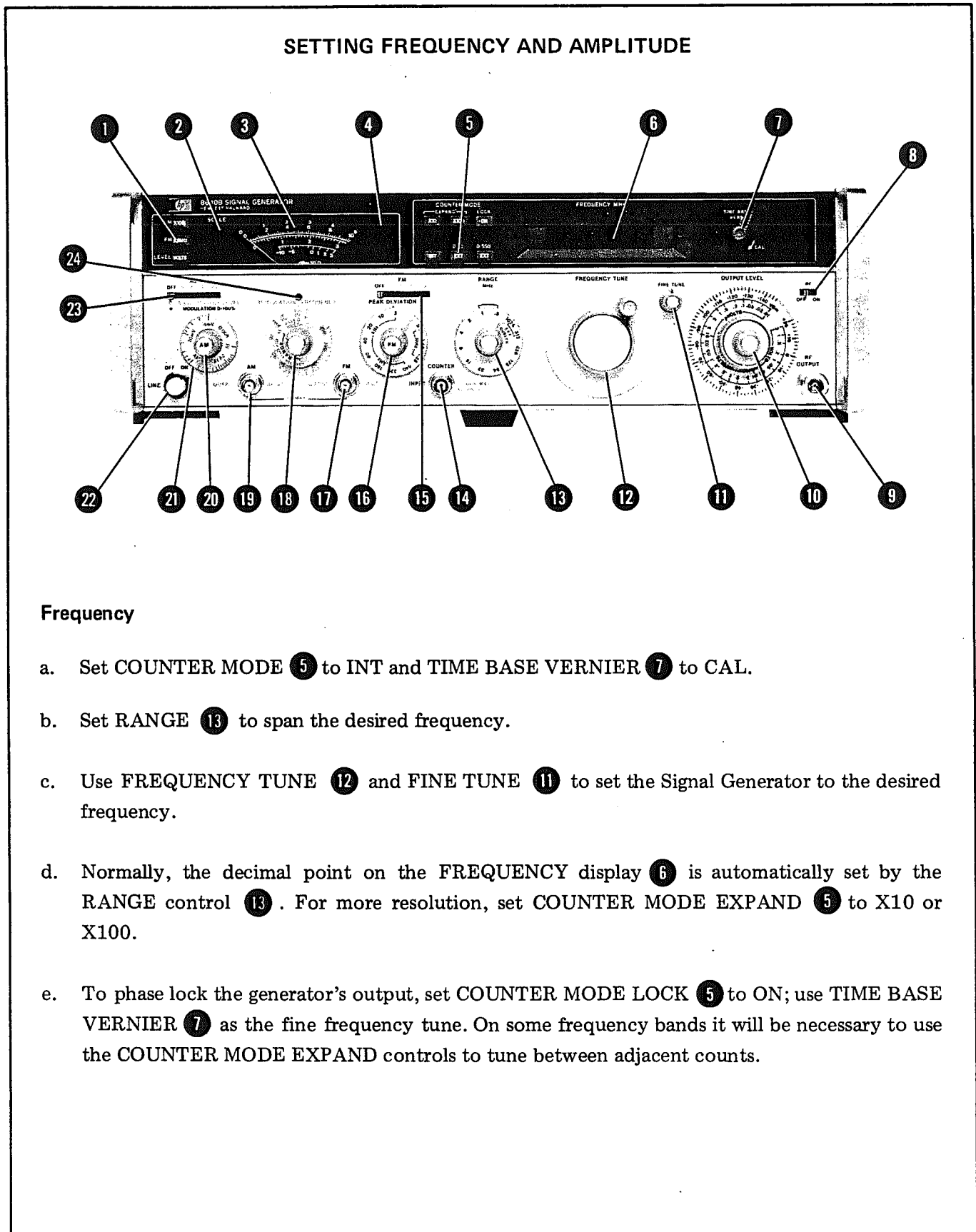

Figure 3-5. Setting the Frequency and Amplitude Controls (1 of 3)

**SETTING FREQUENCY AND AMPLITUDE****NOTE**

If the OVERFLOW annunciator lamp is lit, the generator will not enter phase lock. If the TIME BASE VERN is not in the CAL position, the counter will not be calibrated.

- f. Whenever phase lock is lost, the FREQUENCY display ⑥ will flash. To re-establish phase lock, set COUNTER MODE LOCK ⑤ to OFF; re-tune (if necessary) with FREQUENCY TUNE ⑫ and FINE TUNE ⑪, and set COUNTER MODE LOCK to ON.

**NOTE**

To get an accurate indication of frequency when not phase locked, set TIME BASE VERNIER ⑦ to CAL.

- g. To use an external frequency doubler, connect to RF OUTPUT ⑨ and set RANGE ⑬ to 512-1024 MHz/DOUBLER. The FREQUENCY display ⑤ will indicate the frequency out of doubler (i.e., the FREQUENCY display indicates twice the frequency at RF Output).

**Amplitude**

- a. Use the OUTPUT LEVEL switch and vernier ⑩ to set the desired signal level (there are two scales, rms volts and dBm). For optimum operation, use the vernier in the top 10 dB of its range. To enable the RF signal, set the RF ON/OFF switch ⑧ to ON.

**NOTE**

The RF ON/OFF switch disables the RF signal by turning off the RF oscillator and also by disabling the RF path in the output circuits. If desired, the switching can be connected so that the RF ON/OFF switch turns off only the output circuits (see Service Sheet 5 in Section VIII).

Figure 3-5. Setting the Frequency and Amplitude Controls (2 of 3)

**SETTING FREQUENCY AND AMPLITUDE**

- b. For better voltage and dBm resolution, set Meter Function ① to LEVEL. The meter ③ is read in conjunction with the OUTPUT LEVEL controls ⑩ (e.g., with OUTPUT LEVEL set to approximately 20 mVOLTS, a meter reading of 2.1 indicates that the actual level is 21 mVrms).
- c. If a 50 ohm to 75 ohm adapter (consisting of a 25 ohm series resistor) is connected to RF OUTPUT ⑨, the OUTPUT LEVEL ⑩ voltage scale will be correct if the instrument is used with 75 ohm terminations. However, 1.76 dB must be subtracted from the dB scale for correct readings.

*Figure 3-5. Setting the Frequency and Amplitude Controls (3 of 3)*

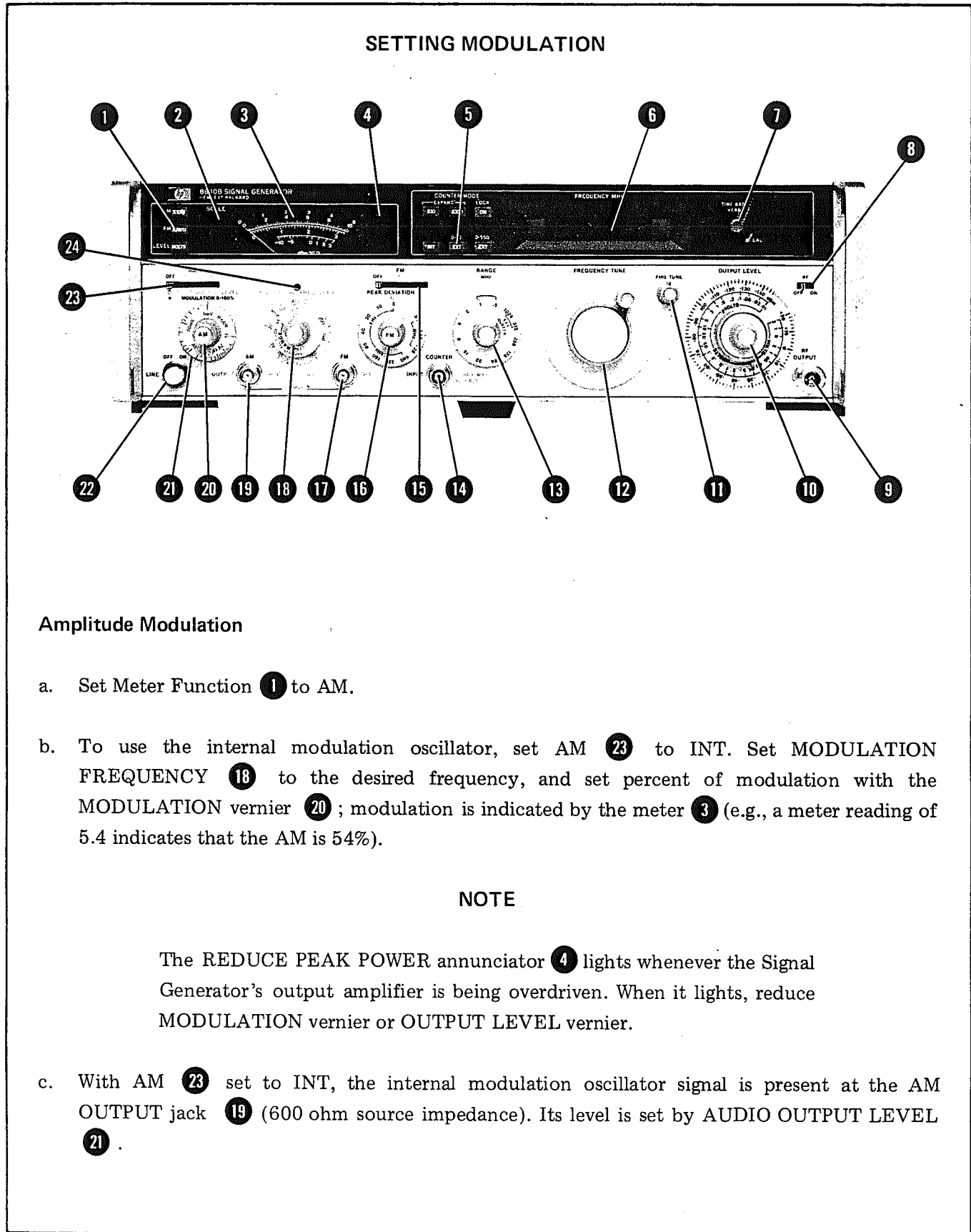
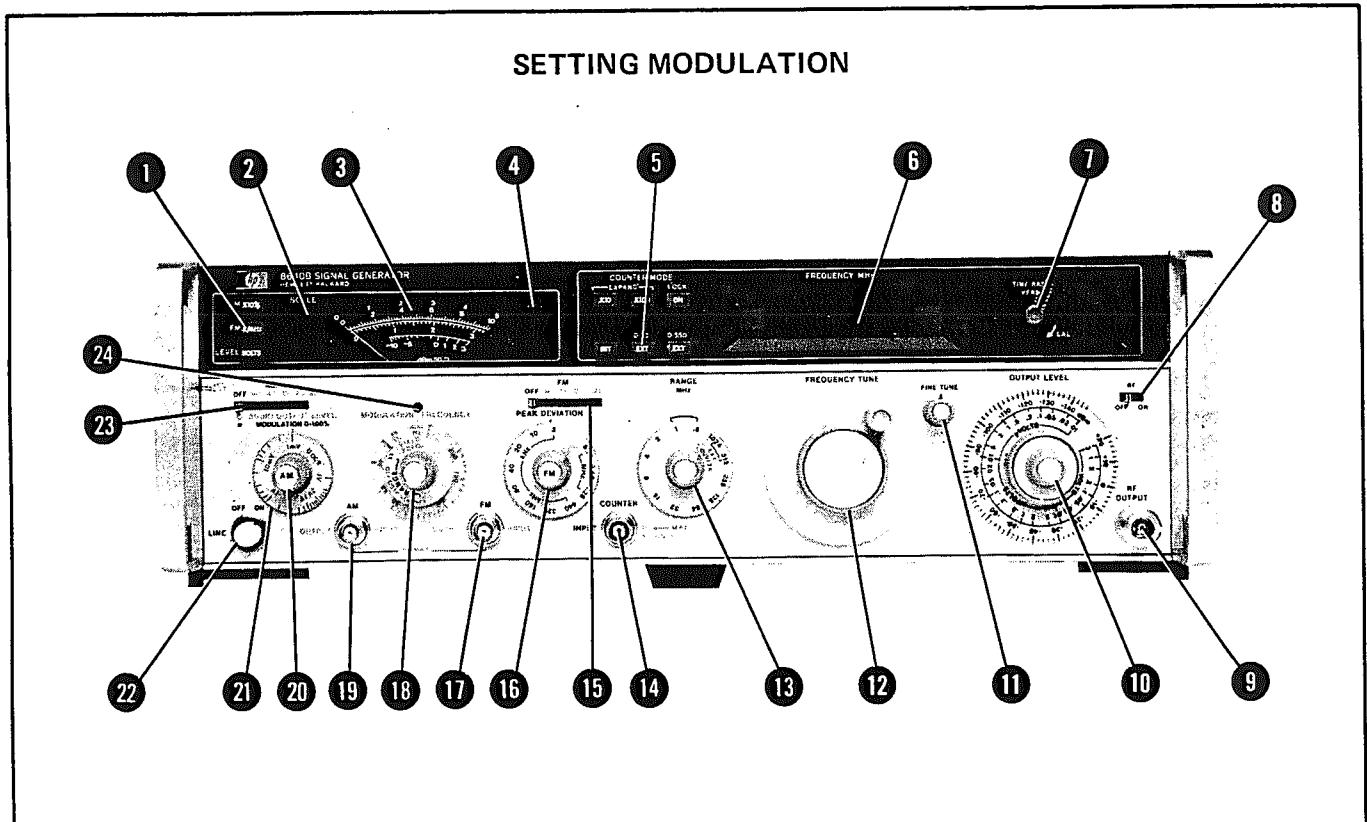

Figure 3-6. Setting the Modulation Controls (1 of 4)



- d. To use an external modulation signal, set AM **23** to AC (or DC if modulation signal is less than 20 Hz). Apply the signal to the AM INPUT jack **19** (600 ohm load impedance). The Signal Generator requires 1 Vpk (0.7071 Vrms) for 100% modulation. Set percent of modulation with the MODULATION vernier **20** ; modulation % is indicated by the meter **3**.

**NOTE**

The meter reading is accurate when AM is set to DC only if no dc offset is applied to the AM INPUT jack. The meter responds to the positive peak of the ac component of the modulating signal.

**Pulse Modulation**

- a. Set Meter Function **1** to LEVEL.
- b. Set AM **23** to PULSE (this disables the RF output). Apply the modulation pulse to the AM INPUT jack **19** (50 ohm load impedance). The signal Generator requires a positive level to produce an RF output.
- c. Set the desired pulse-on level using the OUTPUT LEVEL controls **10** .

Figure 3-6. Setting the Modulation Controls (2 of 4)

**SETTING MODULATION****Frequency Modulation**

- a. Set Meter Function **1** to FM.
- b. To use the internal modulation oscillator, set FM **15** to INT. Set MODULATION FREQUENCY **18** to the desired frequency, and set the peak deviation with the PEAK DEVIATION switch and vernier **16**.

**NOTE**

The REDUCE PEAK DEVIATION annunciator **4** lights whenever the PEAK DEVIATION switch setting is too high for the selected frequency range. When it lights, reduce PEAK DEVIATION.

- c. Peak frequency deviation is indicated by the meter **3**, and the meter is read in conjunction with the PEAK DEVIATION switch **16** (e.g., with PEAK DEVIATION set to 320 kHz, a meter reading of 2.8 indicates that peak frequency deviation is 280 kHz).
- d. With FM **15** set to INT, the internal modulation oscillator signal is present at the FM OUTPUT jack **17** (600 ohm source impedance). Its level is set by AUDIO OUTPUT LEVEL **21**.
- e. To use an external modulation signal, set FM **15** to AC (or DC if modulation signal is less than 20 Hz). Apply the signal to the FM INPUT jack **17** (600 ohm load impedance). The Signal Generator requires 1 Vpk (0.7071 Vrms) for full peak deviation. The PEAK DEVIATION controls **16** and the meter **3** are used the same as when using the internal modulation oscillator signal.
- f. To calibrate the external input, set the FM switch **15** to DC (with no signal applied to FM input) and read the frequency of the RF Output. Set FM to CAL and, using the PEAK DEVIATION switch and vernier **16**, offset the frequency at RF OUTPUT an amount equal to the desired peak deviation. Set FM to DC or AC; a 1 Vpk (0.7071 Vrms) signal applied to FM INPUT will now produce the desired peak deviation. (Do not use FM CAL when phase locked.)

Figure 3-6. Setting the Modulation Controls (3 of 4)



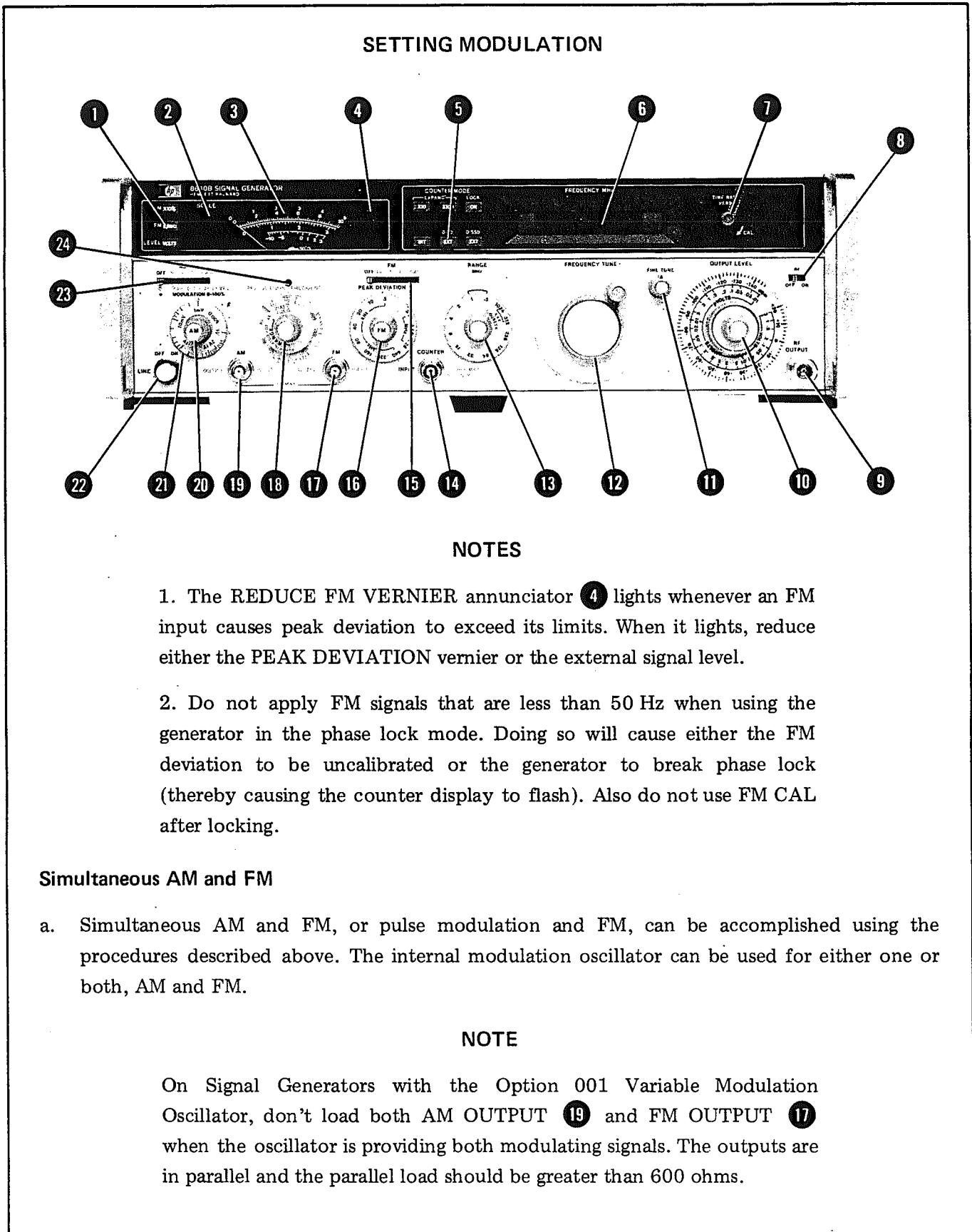

Figure 3-6. Setting the Modulation Controls (4 of 4)

## SECTION IV PERFORMANCE TESTS

### 4-1. INTRODUCTION

4-2. The procedures in this section test the instrument's electrical performance using the specifications of Table 1-1 as the performance standards. A simpler operational test is included in Section III under Operator's Checks.

### 4-3. EQUIPMENT REQUIRED

4-4. Equipment required for the performance tests is listed in the Recommended Test Equipment table in Section I. Any equipment that satisfies the critical specifications given in the table may be substituted for the recommended model(s).

### 4-5. TEST RECORD

4-6. Results of the performance tests may be tabulated on the Test Record at the end of the procedures. The Test Record lists all of the tested specifications and their acceptable limits. Test results recorded at incoming inspection can be used for comparison in periodic maintenance and troubleshooting and after repairs or adjustments.

### 4-7. TEST PROCEDURES

4-8. It is assumed that the person performing the following tests understands how to operate the specified test equipment. Equipment settings,

other than those for the Model 8640B, are stated in general terms. For example, a test might require that a spectrum analyzer's resolution bandwidth be set to 100 Hz; however, the time per division setting would not be specified and the operator would set that control so that the analyzer operates correctly.

4-9. It is also assumed that the person performing the tests will supply whatever cables, connectors, and adapters are necessary. The Test Accessories table in Section I lists the requirements for some of these items.

4-10. Unless otherwise specified, set the following controls as shown:

TIME BASE INT/EXT (on rear panel) . . . INT  
TIME BASE VERNIER . . . . . CAL

Use FINE TUNE in conjunction with FREQUENCY TUNE to set whatever frequency is required. Use the COUNTER MODE EXPAND controls whenever necessary to obtain required counter resolution.

**CAUTION**

To avoid the possibility of damage to test equipment, read completely through each test before starting it. Make any preliminary control settings necessary for correct test equipment operation.

### NOTE

Table 4-2 contains a list of recommended abridgments to the performance tests. The abridgments suggest rapid and relatively inexpensive ways to test the instrument while retaining those tests which are considered of prime importance in characterizing the generator. Where alteration of a test is recommended, a justification (remark) is also given. Should individual needs make the justification invalid, the test should be performed in its entirety. (E.g., the Incidental AM Test, sometimes known as AM on FM, has been omitted as being of secondary importance. Should your application require characterization of this specification, the test should be performed.)

**PERFORMANCE TESTS**

**4-11. FREQUENCY RANGE TEST**

**SPECIFICATION:**

Range: 500 kHz to 512 MHz in 10 octave bands.

Bands and Band Overlap: Bands extend 10% below and 7% above the nominal limits shown below.

Nominal Frequency Bands (MHz)	0.5-1	1-2	2-4	4-8	8-16	16-32	32-64	64-128	128-256	256-512	External Doubler Band 512-1024
Frequency Range (MHz) (with overlap)	0.45 to 1.07	0.9 to 2.1	1.8 to 4.2	3.6 to 8.5	7.2 to 17.1	14.4 to 34.3	28.8 to 68.7	57.5 to 137.5	115 to 275	230 to 550	230 to 550 (without External Doubler)

**DESCRIPTION:**

The frequency range is verified by using a frequency counter to measure the frequency at the high and low end of each band.

**EQUIPMENT:**

Frequency Counter . . . . . HP 5327C

**PROCEDURE:**

1. Connect generator's auxiliary RF output jack (located on rear panel) to frequency counter's 50 ohm input after setting Signal Generator's controls as follows:

COUNTER MODE: EXPAND . . . . . Off  
 LOCK . . . . . Off  
 Source . . . . . INT  
 AM . . . . . OFF  
 FM . . . . . OFF  
 RANGE . . . . . 256 - 512 MHz  
 FREQUENCY TUNE . . . . . Full clockwise  
 FINE TUNE . . . . . Centered  
 RF ON/OFF . . . . . ON

2. Set FREQUENCY TUNE full clockwise. The frequency counter should read 550 MHz or greater.

550.0 MHz \_\_\_\_\_

**PERFORMANCE TESTS**

---

**4-11. FREQUENCY RANGE TEST (Cont'd)**

3. Set FREQUENCY TUNE full counterclockwise. The frequency counter should read 230 MHz or less. \_\_\_\_\_ 230.0 MHz
4. Set RANGE as shown below and check frequency at high and low ends of each band.

Range (MHz)	Low End	High End
512-1024*	_____ <230.0 MHz	>550.0 MHz _____
128-256	_____ <115.0 MHz	>275.0 MHz _____
64-128	_____ <57.50 MHz	>137.5 MHz _____
32-64	_____ <28.80 MHz	>68.70 MHz _____
16-32	_____ <14.40 MHz	>34.30 MHz _____
8-16	_____ <7.200 MHz	>17.10 MHz _____
4-8	_____ <3.600 MHz	>8.500 MHz _____
2-4	_____ <1.800 MHz	>4.200 MHz _____
1-2	_____ <0.900 MHz	>2.100 MHz _____
0.5-1	_____ <0.450 MHz	>1.070 MHz _____

\* No external doubler should be connected.

---

**4-12. FREQUENCY ACCURACY AND FINE TUNE TEST**

SPECIFICATION:

$$\text{Accuracy: } \left[ \begin{array}{c} \text{Total} \\ \text{Count} \\ \text{Accuracy} \end{array} \right] = \left[ \begin{array}{c} \text{Counter} \\ \text{Resolution} \\ (\pm 1 \text{ count}) \end{array} \right] + \left[ \begin{array}{c} \text{Reference} \\ \text{Error} \\ (\text{INT or EXT}) \end{array} \right]$$

Internal Reference Error:  $<\pm 2$  ppm (when calibrated at 25°C every 3 months and operated between 15°C and 35°C).

When phase locked, Counter Resolution error is eliminated.

Fine Tuning: Unlocked,  $>200$  ppm total range. Locked mode,  $>\pm 20$  ppm by varying internal time base vernier.

PERFORMANCE TESTS

4-12. FREQUENCY ACCURACY AND FINE TUNE TEST (Cont'd)

DESCRIPTION:

Frequency accuracy is checked (using the Signal Generator's internal reference) by comparing the generator's counter indication to the frequency reading on an external frequency counter. The fine tune range is also checked with the external counter.

EQUIPMENT:

Frequency Counter . . . . . HP 5327C OPT H49

PROCEDURE:

- 1. Connect generator's auxiliary RF output jack (located on rear panel) to frequency counter's input after setting Signal Generator's controls as follows:

COUNTER MODE: EXPAND . . . . . X100
LOCK . . . . . Off
Source . . . . . INT
AM . . . . . OFF
FM . . . . . OFF
RANGE . . . . . 32 - 64 MHz
FREQUENCY TUNE . . . . . 50 MHz
RF ON/OFF . . . . . ON

- 2. Allow Signal Generator and frequency counter to stabilize for two hours.
3. Set frequency counter time base to give at least one more digit resolution than the generator's counter. The difference in reading between the two counters should be <110 Hz (2 ppm + last digit uncertainty of 10 Hz).

\_\_\_\_\_ 110 Hz

- 4. Set COUNTER MODE EXPAND to X10 and LOCK to ON. Allow one minute to acquire phase lock. Increase the frequency counter resolution by 10. The difference in counter readings should be <100 Hz (2 ppm).

\_\_\_\_\_ 100 Hz

- 5. Note frequency counter reading. Turn TIME BASE VERN control ccw until it just leaves the detent position. The frequency counter should now read >1 kHz (>20 ppm) higher than the reading noted above.

1 kHz \_\_\_\_\_

- 6. Turn TIME BASE VERN fully ccw. The frequency counter should now read >1 kHz (>20 ppm) lower than the reading first noted in step 5.

1 kHz \_\_\_\_\_

**PERFORMANCE TESTS**

---

**4-12. FREQUENCY ACCURACY AND FINE TUNE TEST (Cont'd)**

7. Set TIME BASE VERN to CAL (fully cw). Set COUNTER MODE LOCK to Off.
8. Set FINE TUNE fully cw. Note frequency counter reading, then set FINE TUNE fully ccw. The frequency counter should read >10 kHz (200 ppm) lower than the reading noted above.

10 kHz \_\_\_\_\_

---

**4-13. FREQUENCY STABILITY VS TIME AND RESTABILIZATION TIME TEST**

**SPECIFICATION:**

Stability vs Time (after 2 hour warmup): <10 ppm/10 min. (normal mode).

- Restabilization Time (normal mode):
- After frequency change: <15 min.
  - After band change: none.
  - After 1 min. in RF OFF mode: <10 min.

**NOTE**

Stability specifications for phase lock mode are determined by counter time base reference. See the internal reference tests.

**DESCRIPTION:**

A frequency counter, digital to analog converter, and strip-chart recorder are used to measure the frequency drift after warm-up and the restabilization time.

**NOTE**

For these tests, ambient room temperature and line voltage must not change.

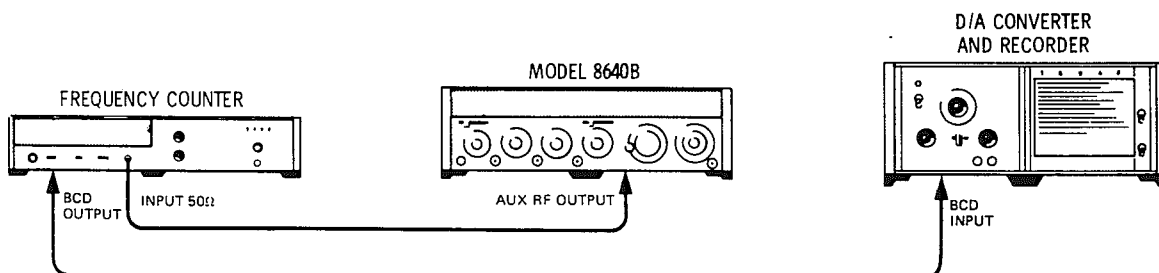

*Figure 4-1. Frequency Stability vs Time and Restabilization Time Test Setup*

PERFORMANCE TESTS

4-13. FREQUENCY STABILITY VS TIME AND RESTABILIZATION TIME TEST (Cont'd)

EQUIPMENT:

Frequency Counter . . . . . HP 5327C OPT 003  
 Digital to Analog Converter . . . . . HP 581A OPT 002  
 Recorder (for D/A Converter) . . . . . HP 680

PROCEDURE:

1. Connect equipment as shown in Figure 4-1 after setting Signal Generator's controls as follows:

COUNTER MODE: EXPAND . . . . . Off  
                           LOCK . . . . . Off  
                           Source . . . . . INT  
 AM . . . . . OFF  
 FM . . . . . OFF  
 RANGE . . . . . 32 - 64 MHz  
 FREQUENCY TUNE . . . . . 50 MHz  
 RF ON/OFF . . . . . ON

2. Set frequency counter to read frequency directly (i.e., not divided down). Use a 1 s gate time so that the last three digits span from 000 to 999 Hz.
3. Calibrate the recorder for a zero to full-scale reading that corresponds to a 000 to 999 Hz reading of the frequency counter's last three digits (i.e., 1 kHz full scale).
4. Warm up the equipment for two hours. Establish a reference on the recorder and record the generator's output frequency for 10 minutes. The frequency change in 10 minutes should be <500 Hz (half of full scale).

\_\_\_\_\_ 500 Hz

5. Set the FREQUENCY TUNE control fully ccw and back again to approximately 50 MHz. After 15 minutes record the frequency for 10 minutes. The frequency change in 10 minutes should be <500 Hz.

\_\_\_\_\_ 500 Hz

6. Set RANGE to 16 - 32 MHz and record the frequency for 10 minutes. The frequency change in 10 minutes should be <250 Hz.

\_\_\_\_\_ 250 Hz

7. Set RANGE to 32 - 64 MHz and set RF ON/OFF to OFF. After one minute set RF ON/OFF to ON. Wait 10 minutes and record the frequency for 10 minutes. The frequency change for the second 10 minutes should be <500 Hz.

\_\_\_\_\_ 500 Hz

PERFORMANCE TESTS

4-14. FREQUENCY STABILITY VS TEMPERATURE TEST

SPECIFICATION:

Stability vs Temperature: <50 ppm/°C (normal mode).

NOTE

Stability specifications for phase lock mode are determined by counter time base reference. See the internal reference tests.

DESCRIPTION:

A frequency counter is used to measure drift as temperature is changed. A temperature controlled chamber is used to vary the temperature.

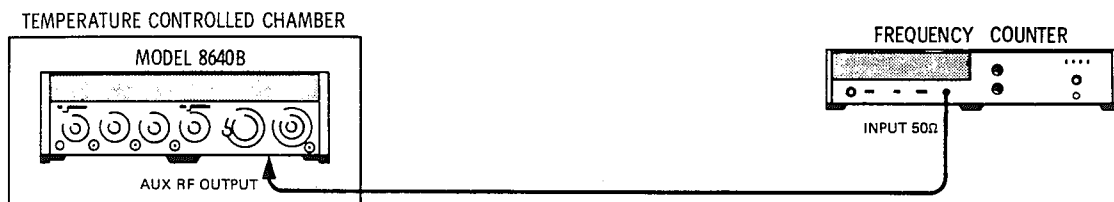

Figure 4-2. Frequency stability vs Temperature Test Setup

EQUIPMENT:

- Frequency Counter . . . . . HP 5327C
- Temperature Controlled Chamber . . . . . Statham Model 325

PROCEDURE:

1. Connect equipment as shown in Figure 4-2 after setting Signal Generator's controls as follows:

- COUNTER MODE: EXPAND . . . . . Off
- LOCK . . . . . Off
- Source . . . . . INT
- AM . . . . . OFF
- FM . . . . . OFF
- RANGE . . . . . 32 - 64 MHz
- FREQUENCY TUNE . . . . . 50 MHz
- RF ON/OFF . . . . . ON

2. Set temperature controlled chamber for 15° C. Allow Signal Generator to stabilize for two hours. Then note frequency counter reading.



PERFORMANCE TESTS

4-14. FREQUENCY STABILITY VS TEMPERATURE TEST (Cont'd)

- 3. Set chamber for 35°C. Again, allow Signal Generator to stabilize for two hours. Frequency change from reading noted in step 2 should be less than 50 kHz.

\_\_\_\_\_ 50 kHz

4-15. FREQUENCY STABILITY VS LINE VOLTAGE TEST

SPECIFICATION:

Stability vs Line Voltage (+5% to -10% line voltage change): <1 ppm (normal mode).

NOTE

Stability specifications for phase lock mode are determined by counter time base reference. See the internal reference tests.

DESCRIPTION:

A frequency counter is used to measure frequency shift as line voltage is changed +5% to -10%.

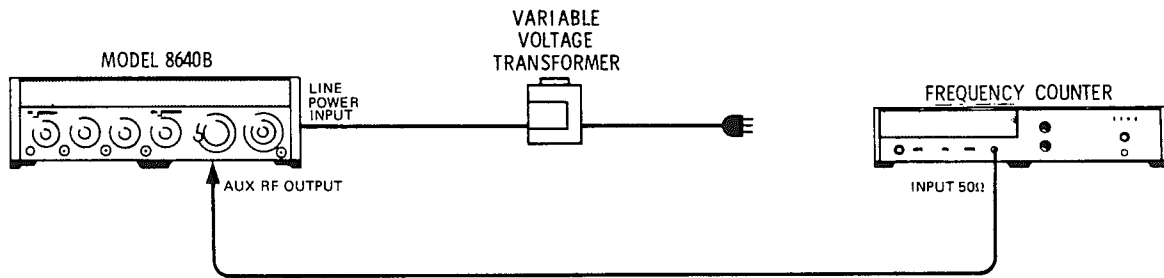

Figure 4-3. Frequency Stability vs Line Voltage Test Setup

EQUIPMENT:

- Frequency Counter . . . . . HP 5327C
- Variable Voltage Transformer . . . . . GR W5MT3A

PERFORMANCE TESTS

4-15. FREQUENCY STABILITY VS LINE VOLTAGE TEST (Cont'd)

PROCEDURE:

1. Connect equipment as shown in Figure 4-3 after setting Signal Generator's controls as follows:

COUNTER MODE: EXPAND . . . . . Off  
 LOCK . . . . . Off  
 Source . . . . . INT  
 AM . . . . . OFF  
 FM . . . . . OFF  
 RANGE . . . . . 32 - 64 MHz  
 FREQUENCY TUNE . . . . . 50 MHz  
 RF ON/OFF . . . . . ON

2. Set variable voltage transformer 5% above the nominal voltage set on generator's line power module (e.g., if nominal line voltage is 120 Vac, set transformer for 126 Vac). Note frequency counter reading.
3. Set variable voltage transformer 10% below nominal line voltage (e.g., for a nominal 120 Vac, set transformer for 108 Vac), then note counter's reading. The frequency change from the reading noted in step 2 should be <50 Hz (i.e., <1 ppm).

\_\_\_\_\_ 50 Hz

4-16. FREQUENCY STABILITY VS LOAD, LEVEL, AND MODE TEST

SPECIFICATION:

Stability vs Load (with any passive load change): <1 ppm (normal mode).  
 Stability vs Level Change (10 dB on OUTPUT LEVEL vernier): <1 ppm (normal mode).  
 Stability vs Modulation Mode Change (CW to FM): <1% of selected peak deviation or <200 Hz, whichever is greater.

NOTE

Stability specifications for phase lock mode are determined by counter time base reference. See the internal reference tests.

DESCRIPTION:

A frequency counter is used to measure frequency shift as the output is changed from an open circuit to a short circuit, as RF OUTPUT LEVEL is changed 10 dB, and as modulation mode is changed from CW to FM. The frequency is monitored at the rear panel auxiliary RF output jack.

PERFORMANCE TESTS

4-16. FREQUENCY STABILITY VS LOAD, LEVEL, AND MODE TEST (Cont'd)

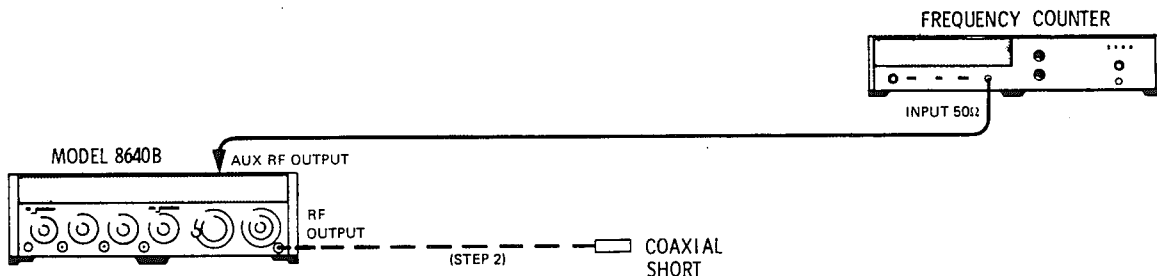

Figure 4-4. Frequency Stability vs Load, Level, and Mode Test Setup

EQUIPMENT:

- Frequency Counter . . . . . HP 5327C
- Type N Male Coaxial Short . . . . . HP 11512A

PROCEDURE:

1. Connect equipment as shown in Figure 4-4 after setting Signal Generator's controls as follows:

- COUNTER MODE: EXPAND . . . . . Off
- LOCK . . . . . Off
- Source . . . . . INT
- AM . . . . . OFF
- FM . . . . . OFF
- RANGE . . . . . 32 - 64 MHz
- FREQUENCY TUNE . . . . . 50 MHz
- OUTPUT LEVEL . . . . . +19 dBm
- RF ON/OFF . . . . . ON

2. Note frequency counter reading. Then connect coaxial short to RF OUTPUT. Again, note frequency counter reading. It should have changed less than 50 Hz.

\_\_\_\_\_ 50 Hz

3. Remove coaxial short, note frequency counter reading, then set OUTPUT LEVEL vernier to +9 dBm. Again, note frequency counter reading. It should have changed less than 50 Hz.

\_\_\_\_\_ 50 Hz

4. Set RANGE to 256 - 512 MHz, and set FREQUENCY TUNE to 500 MHz. With FM switch set to OFF, note the frequency counter reading. Set PEAK DEVIATION switch to 10 kHz and PEAK DEVIATION vernier full clockwise. Set FM to AC and again, note frequency counter reading. It should have changed less than 200 Hz.

\_\_\_\_\_ 200 Hz

**PERFORMANCE TESTS**

---

**4-16. FREQUENCY STABILITY VS LOAD, LEVEL, AND MODE TEST (Cont'd)**

5. Repeat step 4 with PEAK DEVIATION set as shown below. The frequency change should be as specified.

Peak Deviation	Frequency Change
20 kHz	_____ <200 Hz
40 kHz	_____ <400 Hz
80 kHz	_____ <800 Hz
160 kHz	_____ <1.6 kHz
320 kHz	_____ <3.2 kHz
640 kHz	_____ <6.4 kHz
1.28 MHz	_____ <12.8 kHz
2.56 MHz	_____ <25.6 kHz

---

**4-17. HARMONICS TEST**

**SPECIFICATIONS:**

Harmonics: (at 1 volt, +13 dBm output range and below)  
 >35 dB below fundamental of 0.5 to 128 MHz,  
 >30 dB below fundamental of 128 to 512 MHz.

**DESCRIPTION:**

A spectrum analyzer is used to measure harmonics as the Signal Generator is tuned from 0.5 to 512 MHz.

**EQUIPMENT:**

Spectrum Analyzer . . . . . HP 141T/8552B/8554B

**PROCEDURE:**

1. Connect generator's RF OUTPUT to analyzer's input after setting Signal Generator's controls as follows:

Meter Function . . . . . LEVEL  
 COUNTER MODE: EXPAND . . . . . Off  
 LOCK . . . . . Off  
 Source . . . . . INT



**PERFORMANCE TESTS**

**4-17. HARMONICS TEST (Cont'd)**

**NOTE**

On bands 8 - 16 MHz and above, check for harmonics while tuning down in frequency. For frequencies above 500 MHz, tune analyzer to observe second harmonic.

Spectrum Analyzer		Signal Generator	
Resolution Bandwidth	Freq. Span Per Division	Range	Harmonics Down
100 kHz	1 MHz	1-2 MHz	>35 dB _____
100 kHz	2 MHz	2-4 MHz	>35 dB _____
100 kHz	5 MHz	4-8 MHz	>35 dB _____
300 kHz	10 MHz	8-16 MHz	>35 dB _____
300 kHz	20 MHz	16-32 MHz	>35 dB _____
300 kHz	50 MHz	32-64 MHz	>35 dB _____
300 kHz	100 MHz	64-128 MHz	>35 dB _____
300 kHz	100 MHz	128-256 MHz	>30 dB _____
300 kHz	100 MHz	256-512 MHz	>30 dB _____

**4-18. SUB-HARMONICS AND NON-HARMONIC SPURIOUS TEST**

**SPECIFICATION:**

Sub-Harmonics and Non-Harmonic Spurious: (excluding frequencies within 15 kHz of carrier whose effects are specified under Residual AM and FM) >100 dB below carrier.

**DESCRIPTION:**

A notch filter is used to remove the fundamental. All non-harmonic spurious and sub-harmonics are then amplified and measured with a spectrum analyzer.

PERFORMANCE TESTS

4-18. SUB-HARMONICS AND NON-HARMONIC SPURIOUS TEST (Cont'd)

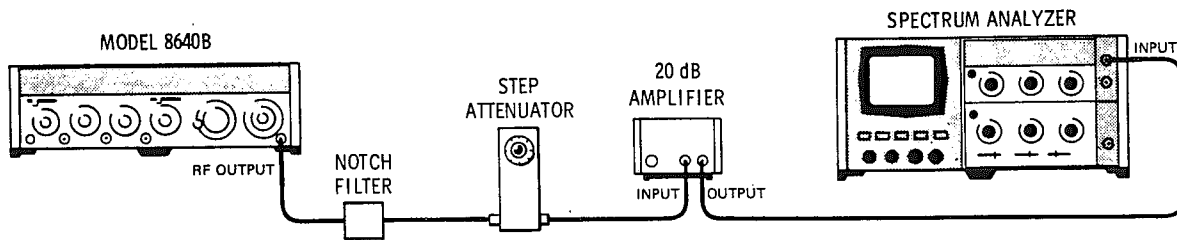

Figure 4-5. Sub-Harmonics and Non-Harmonic Spurious Test Setup

EQUIPMENT:

520 MHz Notch Filter	HP 08640-60502
10 dB Step Attenuator	HP 355D
20 dB Amplifier	HP 8447A
Spectrum Analyzer	HP 141T/8552B/8554B

PROCEDURE:

1. Connect equipment as shown in Figure 4-5 after setting Signal Generator's controls as follows:

Meter Function	LEVEL
COUNTER MODE: EXPAND	Off
LOCK	Off
Source	INT
AM	OFF
FM	OFF
RANGE	128 - 256 MHz
FREQUENCY TUNE	260 MHz
OUTPUT LEVEL	+13 dBm
RF ON/OFF	ON

2. Set step attenuator to 60 dB. Set analyzer's input attenuation to 0 dB, scale switch to log (10 dB/div), and reference level controls to -30 dBm; set resolution bandwidth to 30 kHz, frequency span per division (scan width) to 1 MHz, and tune the frequency controls to set 260 MHz at the center of the display. Adjust reference level vernier to set signal peak to top (reference) graticule line on display.
3. Set generator's RANGE switch to 256 - 512 MHz. Tune analyzer to display the 520 MHz signal (i.e., the second harmonic of 260 MHz).
4. Tune generator's FREQUENCY TUNE for a minimum signal on analyzer's display. Set the step attenuator to 0 dB, and again tune FREQUENCY TUNE for a minimum signal.
5. The signal on the display should be below the top (reference level) graticule line. Tune the spectrum analyzer slowly to 500 kHz. All non-harmonic spurious signals, and sub-harmonics should be below the -50 dB graticule on the display (>100 dB down).

100 dB \_\_\_\_\_

PERFORMANCE TESTS

4-19. SINGLE SIDEBAND PHASE NOISE TEST

SPECIFICATION:

SSB Phase Noise at 20 kHz Offset from carrier:

(Averaged rms noise level below carrier stated in a 1 Hz bandwidth.)

256 MHz to 512 MHz: > 130 dB from 230 to 450 MHz increasing linearly to > 122 dB down at 550 MHz.

0.5 MHz to 256 MHz: Decreases approximately 6 dB for each divided frequency range until it reaches SSB Broadband Noise Floor of > 140 dB.

DESCRIPTION:

Phase noise is measured with a spectrum analyzer. A reference signal generator and a mixer are used to down-convert the test Signal Generator's CW signal to 0 Hz (the two signal generators are phase locked together). Then the spectrum analyzer measures SSB phase noise at a 20 kHz offset from the carrier.

NOTE

This test measures the total SSB phase noise of both generators. Therefore, the reference signal generator must have SSB phase noise that is less than or equal to the specification for the test generator.

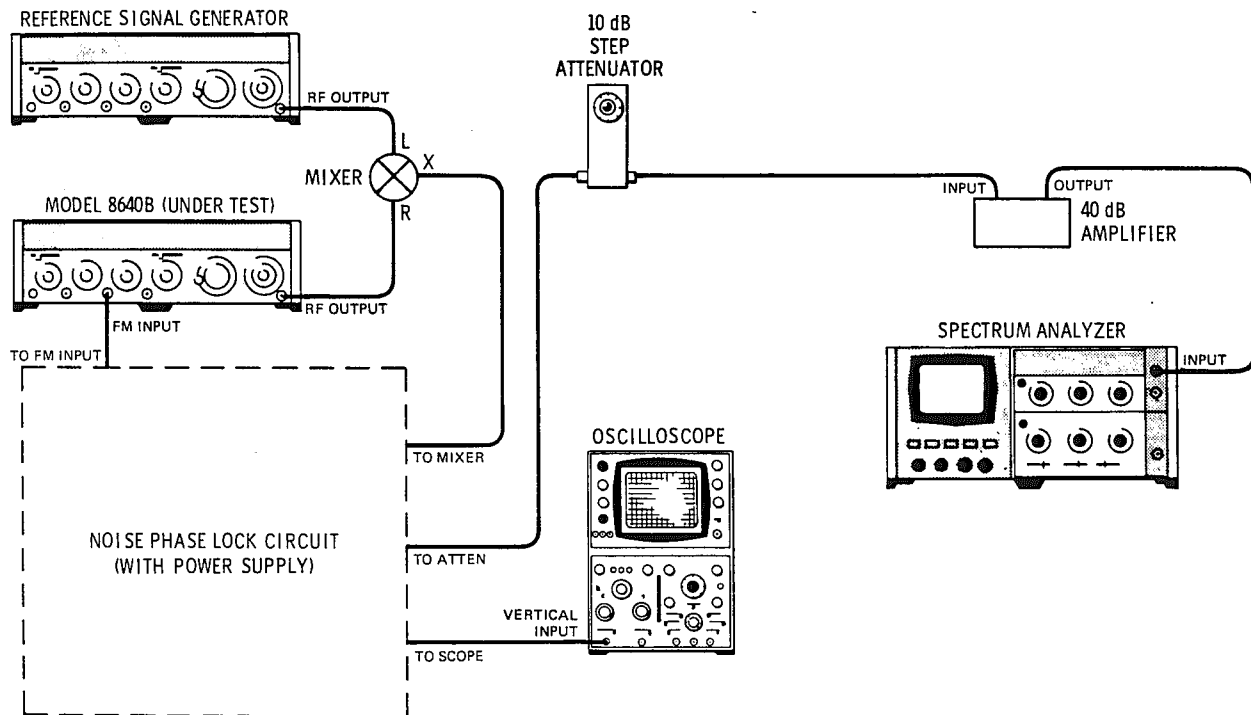

Figure 4-6. Single Sideband Phase Noise Test Setup





---

**PERFORMANCE TESTS**

---

**4-19. SINGLE SIDEBAND PHASE NOISE TEST (Cont'd)****NOTE (Cont'd)**

- b. +2.5 dB because noise is average detected after logging\*.
- c. -0.8 dB. Effective noise BW is  $1.2 \times 3$  dB BW which gives  $-0.8$  dB - 10 log (actual 3 dB BW/nominal 3 dB BW)\*.

Summing the correction factors gives  $-4.3$  dB 10 log (actual 3 dB BW/nominal 3 dB BW) or approximately  $-4.3$  dB  $\pm 1$  dB.

5. Phase lock the generators by setting test generator's FM switch to DC and by tuning reference signal generator to 550 MHz (i.e., for a difference frequency of 0 Hz). Monitor phase lock on oscilloscope, checking that mixer's output is 0 Vdc (if it is not, fine tune reference generator until it is).
6. Set analyzer's display smoothing (video filter) to 10 Hz. Set step attenuator to 0 dB. The top (reference) graticule line on analyzer's display represents 110 dB/Hz below carrier level (the transfer from a 1 kHz BW to a 1 Hz BW is 30 dB). The average noise level on the display should be  $> 12$  dB below top graticule line at 20 kHz (i.e.,  $> 122$  dB below carrier).

12 dB \_\_\_\_\_

**NOTE**

Set oscilloscope to check for possible line-related signals in test setup. They should be  $< 10$  mVp-p.

7. Set test Signal Generator to 450 MHz and FM switch to OFF. Set reference signal generator to 449.98 MHz (i.e., 20 kHz below the test generator's frequency). Repeat steps 2 through 6. The average noise level on the display should be  $> 20$  dB below top graticule line at 20 kHz.

20 dB \_\_\_\_\_

**NOTE**

SSB phase noise can be checked at any other frequency from 230 kHz to 550 MHz by following the procedures given above. Noise decreases approximately 6 dB per each octave band change down to  $-140$  dB below carrier.

**4-20. SINGLE SIDEBAND BROADBAND NOISE FLOOR TEST****SPECIFICATION:**

SSB Broadband Noise Floor at maximum output vernier and greater than 500 kHz offset from carrier: (Averaged rms noise level below carrier stated in a 1 Hz bandwidth.) 0.5 to 512 MHz:  $> 140$  dB.

---

\* See Hewlett-Packard Application Note 150-4, Spectrum Analysis - Noise Measurements.

---

PERFORMANCE TESTS

4-20. SINGLE SIDEBAND BROADBAND NOISE FLOOR (Cont'd)

DESCRIPTION:

A spectrum analyzer is used to measure the broadband noise floor (a reference signal generator and a mixer are used to down-convert the test Signal Generator's RF output and noise to within the range of the spectrum analyzer). A reference level is set on the analyzer with a 5 kHz signal, the signal is changed to 500 kHz and removed from the analyzer with a filter, and the broadband noise floor is measured.

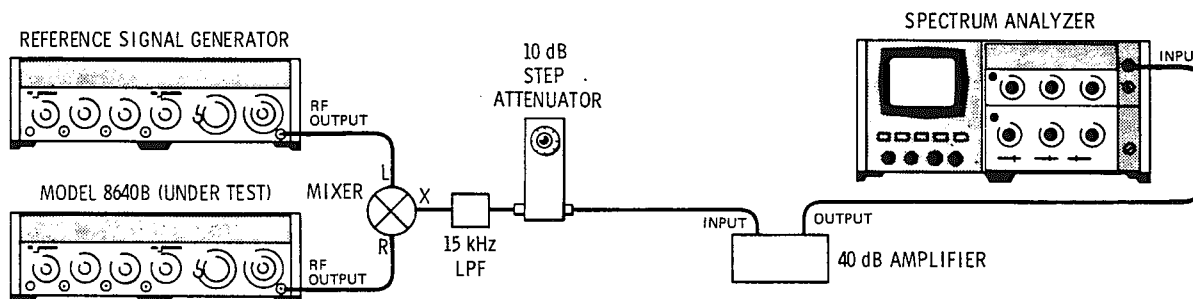

Figure 4-7. Single Sideband Broadband Noise Floor Test Setup

EQUIPMENT:

Reference Signal Generator	HP 8640A
Mixer	HP 10514A
15 kHz Low-Pass Filter	CIR-Q-TEL 7 Pole
10 dB Step Attenuator	HP 355D
40 dB Amplifier	HP 08640-60506
Spectrum Analyzer	HP 141T/8552B/8556A

PROCEDURE:

1. Connect equipment as shown in Figure 4-7 after setting test Signal Generator's controls as follows:

Meter Function	LEVEL
COUNTER MODE: EXPAND	Off
LOCK	Off
Source	INT
AM	OFF
FM	OFF
RANGE	256 - 512 MHz
FREQUENCY TUNE	500.000 MHz
OUTPUT LEVEL	-7 dBm (Vernier max cw)
RF ON/OFF	ON

## PERFORMANCE TESTS

---

### 4-20. SINGLE SIDEBAND BROADBAND NOISE FLOOR (Cont'd)

2. Set 10 dB step attenuator to 80 dB. Set reference signal generator for a 500.005 MHz (i.e., 5 kHz above the test generator's frequency), CW signal at +13 dBm (output vernier maximum cw). Set 40 dB amplifier's input impedance switch to 50 ohms.
3. Set spectrum analyzer's resolution bandwidth to 1 kHz, set input level control to -40 dBm and dBm/dBV to dBm 50 ohm, and adjust frequency controls to set the 5 kHz difference frequency in the center of the display. Set analyzer's display reference level controls for 10 dB per division with the 5 kHz difference signal 1.3 dB from the top (reference) graticule line on the display.

#### NOTE

The correction factors for this measurement are as follows:

- a. The DSB to SSB transfer is -3 dB because the mixing process translates two uncorrelated 1 kHz BW portions of the noise into the 1 kHz BW of the analyzer - giving  $\sqrt{2}$  times the effective noise voltage.
- b. +2.5 dB because noise is average detected after logging.\*
- c. -0.8 dB. Effective noise BW is 1.2 x 3 dB BW which gives -0.8 dB - 10 log (actual 3 dB BW/nominal 3 dB BW).\*

Summing the correction factors gives -1.3 dB - 10 log (actual 3 dB BW/nominal 3 dB BW) or approximately -1.3 dB  $\pm$  1 dB.

4. Change reference signal generator's output frequency to 500.50 MHz. Set 10 dB step attenuator to 0 dB. Set analyzer's display smoothing (video filter) to 10 Hz. The top graticule line on analyzer's display represents -110 dB (the transfer from a 1 kHz BW to a 1 Hz BW is 30 dB). The average noise level on the display should be >30 dB below the top graticule line (i.e., >140 dB below carrier).

30 dB \_\_\_\_\_

#### NOTE

If the test generator appears to be out of specification, check for excessive noise in the test setup by disconnecting the test generator. The noise level on the analyzer's display should decrease at least 10 dB.

---

\* See Hewlett-Packard Application Note 150-4, Spectrum Analysis - Noise Measurements.

PERFORMANCE TESTS

4-21. RESIDUAL AM TEST

SPECIFICATION:

Residual AM: (Averaged rms)

Post-detection Noise Bandwidth	
300 Hz to 3 kHz	20 Hz to 15 kHz
>85 dB down	>78 dB down

DESCRIPTION:

An rms voltmeter is calibrated with a measured amount of amplitude modulation from the Signal Generator. Then the AM is removed and the generator's residual AM is read directly from the voltmeter.

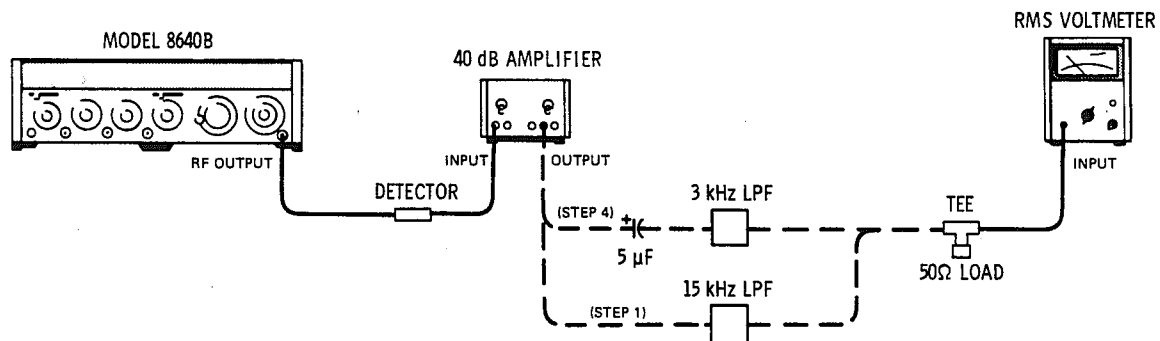

Figure 4-8. Residual AM Test Setup

EQUIPMENT:

RMS Voltmeter	HP 3400A
Detector	HP 8471A
3 kHz Low-Pass Filter (LPF)	CIR-Q-TEL 5 Pole
15 kHz Low-Pass Filter (LPF)	CIR-Q-TEL 7 Pole
40 dB Amplifier	HP 465A
Capacitor 5 μF	HP 0180-2211
50 Ohm Load	HP 11593A

PROCEDURE:

1. Connect equipment as shown in Figure 4-8 (with the generator connected to the rms voltmeter through the detector, amplifier, 15 kHz LPF, and across the 50 ohm load). Set Signal Generator's controls as follows:

PERFORMANCE TESTS

4-21. RESIDUAL AM TEST (Cont'd)

Meter Function	LEVEL
COUNTER MODE: EXPAND	Off
LOCK	Off
Source	INT
AM	INT
MODULATION	Full ccw
MODULATION FREQUENCY	1000 Hz
FM	OFF
RANGE	256 - 512 MHz
FREQUENCY TUNE	500 MHz
OUTPUT LEVEL	+13 dBm (Vernier full cw)
RF ON/OFF	ON

- Set Meter Function to AM and slowly turn Signal Generator's MODULATION control clockwise until its panel meter indicates 10% AM. Note voltmeter reading in dB.
- Set generator's AM switch to OFF. The residual AM should read >58 dB below the reference noted in step 2 (i.e., >78 dB down). (The 10% AM, after detection, is 20 dB below the carrier level. Residual AM is then 20 dB - 78 dB = -58 dB.)

58 dB \_\_\_\_\_

- Replace the 15 kHz LPF with the 3 kHz LPF. Add the capacitor between amplifier and filter and repeat steps 1 through 3. The residual AM should read >65 dB below the reference noted in step 2 (i.e., >85 dB down).

65 dB \_\_\_\_\_

4-22. RESIDUAL FM TEST

SPECIFICATION:

Residual FM: (Averaged rms)

	CW and up to 1/8 maximum allowable peak deviation		Up to maximum allowable peak deviation	
Post-detection Noise Bandwidth	300 Hz to 3 kHz	20 Hz to 15 kHz	300 Hz to 3 kHz	20 Hz to 15 kHz
230 to 550 MHz	<5 Hz	<15 Hz	<15 Hz	<30 Hz

PERFORMANCE TESTS

4-22. RESIDUAL FM TEST (Cont'd)

DESCRIPTION:

An FM discriminator is used to measure FM deviation (a reference signal generator and a mixer are used to down-convert the test Signal Generator's RF output to within the range of the discriminator). The discriminator output is filtered and amplified and then measured with a voltmeter. The voltmeter reading, in mVrms, is proportional to the rms frequency deviation of the residual FM.

NOTE

This test measures the total residual FM of both generators. Therefore, the reference generator must have residual FM that is less than or equal to the specification for the test generator.

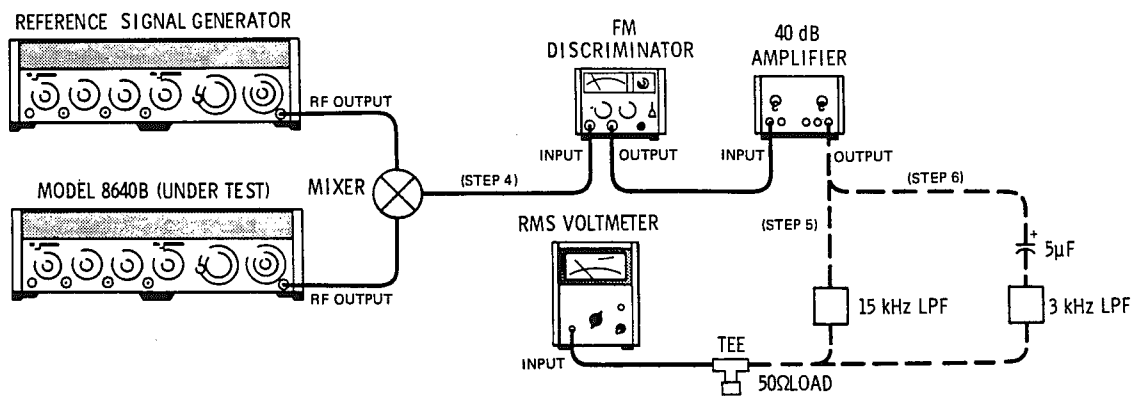

Figure 4-9. Residual FM Test Setup

EQUIPMENT:

FM Discriminator	.....	HP 5210A
Filter Kit	.....	HP 10531A
RMS Voltmeter	.....	HP 3400A
40 dB Amplifier	.....	HP 465A
Capacitor 5 $\mu$ F	.....	HP 0180-2211
Reference Signal Generator	.....	HP 8640A
Mixer	.....	HP 10514A
3 kHz Low-Pass Filter (LPF)	.....	CIR-Q-TEL 5 Pole
15 kHz Low-Pass Filter (LPF)	.....	CIR-Q-TEL 7 Pole
50 Ohm Load	.....	HP 11593A

PERFORMANCE TESTS

4-22. RESIDUAL FM TEST (Cont'd)

PROCEDURE:

1. Connect equipment as shown in Figure 4-9 after setting test Signal Generator's controls as follows:

Meter Function	LEVEL
COUNTER MODE: EXPAND	Off
LOCK	Off
Source	INT
AM	OFF
FM	AC
PEAK DEVIATION	320 kHz
PEAK DEVIATION Vernier	Full cw
RANGE	256 - 512 MHz
FREQUENCY TUNE	500 MHz
OUTPUT LEVEL	-7 dBm
RF ON/OFF	ON

2. Install shorting board in discriminator and calibrate it for 1 Vdc (at the output jack) for a full-scale meter reading. Remove shorting board, prepare a 20 kHz Butterworth low-pass filter (from the filter kit), and install the filter in the discriminator.
3. Set reference signal generator for a 500.10 MHz, CW signal at +13 dBm.
4. Connect discriminator to mixer. Set discriminator's range to 100 kHz and sensitivity to 0.01 Vrms. Fine tune either generator for a full-scale meter reading on the discriminator.
5. Connect amplifier to discriminator output. Connect the voltmeter through the 15 kHz LPF to amplifier's output. The signal out of the amplifier is 0.5 mVrms per 1 Hz (rms) of residual FM deviation, and the average voltmeter reading should be less than 7.5 mVrms (i.e., <15 Hz (rms) residual FM).

\_\_\_\_\_ 7.5 mVrms

NOTE

Test setup calibration can be checked by setting the test generator's FM to INT, PEAK DEVIATION to 5 kHz (vernier full cw), and MODULATION FREQUENCY to 1000 Hz. The voltmeter should read 1.77 Vrms.

6. Connect the capacitor between amplifier and filter. Replace 15 kHz LPF with 3 kHz LPF. The average voltmeter reading should be less than 2.5 mVrms (i.e., <5 Hz (rms) residual FM).

\_\_\_\_\_ 2.5 mVrms

7. Set test Signal Generator's PEAK DEVIATION switch to 2.56 MHz. The average voltmeter reading should be less than 7.5 mVrms (i.e., <15 Hz (rms) residual FM).

\_\_\_\_\_ 7.5 mVrms



---

**PERFORMANCE TESTS**

---

**4-22. RESIDUAL FM TEST (Cont'd)**

8. Remove the capacitor and replace 3 kHz LPF with 15 kHz LPF. The average voltmeter reading should be less than 15 mVrms (i.e., <30 Hz (rms) residual FM).

\_\_\_\_\_ 15 mVrms

**4-23. OUTPUT LEVEL ACCURACY TEST (Abbreviated)****SPECIFICATION:**

Range: 10 dB steps and 18 dB vernier provide output power settings from +19 to -145 dBm (2V to 0.013  $\mu$ V) into 50 $\Omega$ .

**Level Accuracy:**

	Using Top 10 dB of Vernier Range			Using Full Vernier Range
Output Level (dBm)	+19 to -7	-7 to -47	-47 to -137	+19 to -145
Total Accuracy as Indicated on Level Meter	$\pm 1.5$ dB	$\pm 2.0$ dB	$\pm 2.5$ dB	Add $\pm 0.5$ dB

**DESCRIPTION:**

The RF level accuracy for the upper four OUTPUT LEVEL attenuator ranges is measured with a power meter. For the lower ranges, a reference signal is established on a spectrum analyzer display, the Signal Generator's OUTPUT LEVEL switch and the spectrum analyzer's vertical scale log reference level control are stepped together, and any amplitude variations are measured on the analyzer's display. An RF attenuator and amplifier at the RF OUTPUT are adjusted for analyzer compatibility and best sensitivity.

This procedure uses an IF substitution technique in which the spectrum analyzer's IF is the standard. The IF step accuracy should be within  $\pm 0.2$  dB overall. The IF step accuracy can be checked using the above technique by comparing a lab calibrated attenuator (such as HP Model 355D Option H36) with the IF step control at the frequency of attenuator calibration (e.g., 3 MHz for the HP 355D Option H36).

**NOTE**

This procedure checks output level accuracy from +19 dBm to -127 dBm, all of the attenuator sections in the OUTPUT LEVEL step attenuator, and the OUTPUT LEVEL vernier. If, in addition, level accuracy must be verified down to -145 dBm, see paragraph 4-24.

PERFORMANCE TESTS

4-23. OUTPUT LEVEL ACCURACY TEST (Abbreviated) (Cont'd)

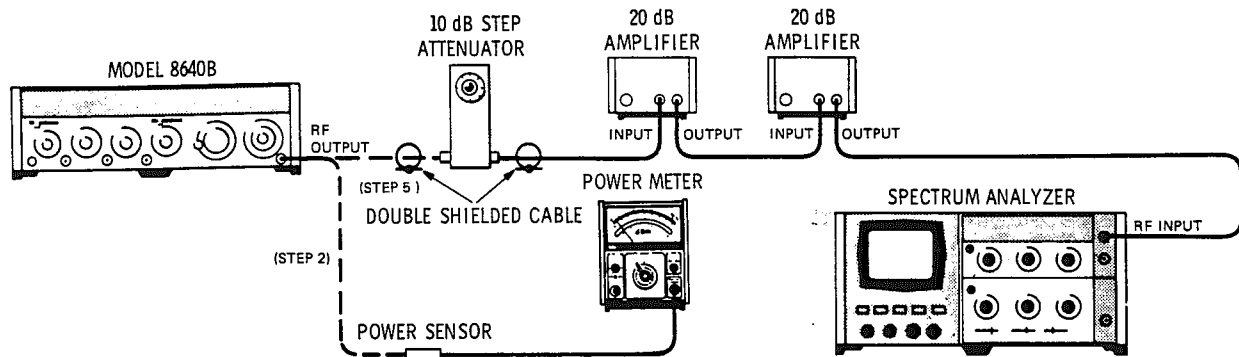

Figure 4-10. Output Level Accuracy Test Setup (Abbreviated)

EQUIPMENT:

Spectrum Analyzer	HP 141T/8552B/8554B
Power Meter	HP 435A
Power Sensor	HP 8481A
20 dB Amplifier (2 required)	HP 8447A
10 dB Step Attenuator	HP 355D
Double Shielded Cable (2 required)	HP 08708-6033

NOTE

An HP Model 432A Power Meter with a Model 478A Thermistor Mount can be used for this test. However, a 10 dB attenuator, such as the Model 8491A OPT 10, must be used with the mount. This will slightly degrade measurement accuracy.

PROCEDURE:

1. Connect equipment as shown in Figure 4-10 after setting Signal Generator's controls as follows:

Meter Function	LEVEL
COUNTER MODE: EXPAND	Off
LOCK	Off
Source	INT
AM	OFF
FM	OFF
RANGE	256 - 512 MHz
FREQUENCY TUNE	512 MHz
OUTPUT LEVEL	+19 dBm
RF ON/OFF	ON

---

**PERFORMANCE TESTS**

---

**4-23. OUTPUT LEVEL ACCURACY TEST. (Abbreviated) (Cont'd)**

2. Set power meter's controls so that it can measure +19 dBm. Connect power sensor to Signal Generator's RF OUTPUT.
3. Set Signal Generator's RF OUTPUT LEVEL controls for levels (set using generator's panel meter) shown in the table below; verify that the level is within the specified tolerance.

Signal Generator		Power Meter Reading (dBm)
OUTPUT LEVEL Switch	RF Level Set (with Panel Meter)	
Full cw	+19 dBm	+17.5 _____ +20.5
	+13 dBm	+11.5 _____ +14.5
	+5 dBm	+3.0 _____ +7.0
1 step ccw from full cw	+13 dBm	+11.5 _____ +14.5
	+8 dBm	+6.5 _____ +9.5
	+3 dBm	+1.5 _____ +4.5
	-5 dBm	-7.0 _____ -3.0
2 steps ccw from full cw	+3 dBm	+1.5 _____ +4.5
3 steps ccw from full cw	-7 dBm	-8.5 _____ -5.5

4. Set step attenuator to 70 dB. Set spectrum analyzer center frequency to 512 MHz, resolution bandwidth to 1 kHz, frequency span per division (scan width) to 0.5 kHz, input attenuation to 0 dB, tuning stabilizer on, display smoothing (video filter) to 100 Hz, 2 dB per division vertical log display with a -20 dBm reference level.
5. Connect attenuator to generator's RF OUTPUT without disturbing generator's controls. Center signal on analyzer's display. Consider the center horizontal graticule line equivalent to -7 dBm (with a panel meter reading of +3 dB), then with the vertical scale reference vernier control set the signal peak to be equal to the last measured level on the power meter.

**NOTE**

If, for example, the last power meter reading was -7.4 dBm, the vertical scale resolution is 2 dB/division, therefore, the signal peak should be 0.4 dB or 0.2 division below the center (reference) graticule line.

PERFORMANCE TESTS

4-23. OUTPUT LEVEL ACCURACY TEST (Abbreviated) (Cont'd)

6. Step Signal Generator's OUTPUT LEVEL switch and analyzer's vertical scale log reference level control as shown in the following table. Verify that the amplitude falls within  $\pm 2.0$  dB (1 division) of the center (reference) graticule line in each case. If necessary, use generator's OUTPUT LEVEL vernier to reset panel meter to +3 dB.

Signal Generator		Spectrum Analyzer	
OUTPUT LEVEL Switch (from full cw)	RF Level Set (with Panel Meter)	Log Reference Level Control (dBm)	Display Amplitude (dB)
3 steps ccw	-7 dBm	-20	Set level
4 steps ccw	-17 dBm	-30	-2.0 _____ +2.0
5 steps ccw	-27 dBm	-40	-2.0 _____ +2.0
6 steps ccw	-37 dBm	-50	-2.0 _____ +2.0

7. Set analyzer's vertical scale log reference level to -10 dBm and reset the 10 dB step attenuator to 30 dB. With the vertical scale log reference vernier, set the signal peak to the same level, with respect to the horizontal center (reference) graticule line, as the last measurement recorded on the preceding table.

NOTE

If generator appears to be out of specification, check accuracy of spectrum analyzer's vertical scale calibration.

8. Step Signal Generator's OUTPUT LEVEL switch and analyzer's vertical scale log reference level control as shown in the following table. Verify that the amplitude is within the specified tolerance. If necessary, use generator's OUTPUT LEVEL vernier to reset panel meter to +3 dB.

Signal Generator		Spectrum Analyzer	
OUTPUT LEVEL Switch (from full cw)	RF Level Set (with Panel Meter)	Log Reference Level Control (dBm)	Display Amplitude (dB)
6 steps ccw	-37 dBm	-10	Set level
7 steps ccw	-47 dBm	-20	-2.5 _____ +2.5
8 steps ccw	-57 dBm	-30	-2.5 _____ +2.5
9 steps ccw	-67 dBm	-40	-2.5 _____ +2.5
10 steps ccw	-77 dBm	-50	-2.5 _____ +2.5

## PERFORMANCE TESTS

## 4-23. OUTPUT LEVEL ACCURACY TEST (Abbreviated) (Cont'd)

9. Set step attenuator to 0 dB; set spectrum analyzer's vertical scale log reference level to  $-20$  dBm. Adjust vertical scale log reference vernier to give the same level, with respect to the center (reference) graticule line, as the last recorded entry on the previous table.
10. Set Signal Generator and analyzer controls as shown in the following table. The amplitude levels should be within the specified tolerances. If necessary, use generator's OUTPUT LEVEL vernier to reset panel meter to  $+3$  dB.

Signal Generator		Spectrum Analyzer	
OUTPUT LEVEL Switch (from full cw)	RF Level Set (with Panel Meter)	Log Reference Level Control (dBm)	Display Amplitude (dB)
10 steps ccw	$-77$ dBm	$-20$	Set level
11 steps ccw	$-87$ dBm	$-30$	$-2.5$ _____ $+2.5$
12 steps ccw	$-97$ dBm	$-40$	$-2.5$ _____ $+2.5$
13 steps ccw	$-107$ dBm	$-50$	$-3.0$ _____ $+3.0$
14 steps ccw	$-117$ dBm	$-60$	$-3.0$ _____ $+3.0$

11. Set analyzer's display to 10 dB/division log. Adjust log reference level vernier to set signal to  $-10$  dB graticule line (one major division from top of display) plus last recorded entry on previous table.

## NOTE

If the following step appears to be out of specification, check the accuracy of the analyzer's display with an external, calibrated attenuator.

12. Set generator's OUTPUT LEVEL switch one step ccw to  $-127$  dBm (adjust vernier for  $+3$  dB indication on panel meter). The amplitude level indicated on analyzer's display should be within 3 dB of the  $-20$  dB graticule line (second major division from top of display).

$-23$  \_\_\_\_\_  $-17$  dB

## NOTE

The noise level on the analyzer's display should be  $>10$  dB below the signal level. The signal should drop into the noise when the OUTPUT LEVEL vernier is turned fully ccw.

**PERFORMANCE TESTS**

**4-24. OUTPUT LEVEL ACCURACY TEST (Complete)**

**SPECIFICATION:**

Range: 10 dB steps and 18 dB vernier provide output power settings from +19 to -145 dBm (2V to 0.013  $\mu$ V) into 50 $\Omega$ .

	Using Top 10 dB of Vernier Range			Using Full Vernier Range
<b>Output Level (dBm)</b>	<b>+19 to -7</b>	<b>-7 to -47</b>	<b>-47 to -137</b>	<b>+19 to -145</b>
<b>Total Accuracy as Indicated on Level Meter</b>	<b><math>\pm 1.5</math> dB</b>	<b><math>\pm 2.0</math> dB</b>	<b><math>\pm 2.5</math> dB</b>	<b>Add <math>\pm 0.5</math> dB</b>

**DESCRIPTION:**

RF output level accuracy above -7 dBm is measured with a power meter; below -7 dBm, cumulative error is measured against a lab calibrated step attenuator using an IF substitution technique. The test Signal Generator's output is down-converted to 3 MHz (the IF) using a mixer and a reference signal generator. The 3 MHz IF is fed through the calibrated step attenuator to a spectrum analyzer. A reference level is established on the analyzer, and the step attenuator and the test generator's OUTPUT LEVEL switch are stepped together. Any amplitude variations are measured with a DVM connected to the analyzer's vertical output.

A spectrum analyzer tracking generator is connected, with the two signal generators, in a phase lock loop that prevents relative drift between the units.

**NOTE**

This procedure allows the output level accuracy to be verified down to -145 dBm. Care must be taken to ensure that leakage signals do not reduce the dynamic range of the test setup (use double-shielded coaxial cable, HP 08707-6033). Keep cables in the phase lock path away from cables in the measurement path.

**EQUIPMENT:**

- Reference Signal Generator . . . . . HP 8640A
- 20 dB Amplifier (3 required) . . . . . HP 8447A
- 10 dB Step Attenuator . . . . . HP 355D
- Calibrated Step Attenuator . . . . . HP 355D OPT H36
- Digital Voltmeter . . . . . HP 3480B/3484A OPT 043
- Spectrum Analyzer . . . . . HP 141T/8552B/8553B
- Tracking Generator . . . . . HP 8443B
- Mixer (3 required) . . . . . HP 10514A
- 4 MHz Low Pass Filter (2 required) . . . . . CIR-Q-TEL 3 Pole

---

**PERFORMANCE TESTS**

---

**4-24. OUTPUT LEVEL ACCURACY TEST (Complete) (Cont'd)**

1.5 MHz Low Pass Filter	.....	CIR-Q-TEL 3 Pole
Oscilloscope	.....	HP 180A/1801A/1820C
20 dB Attenuator	.....	HP 8491A OPT 20
13 dB Attenuator	.....	HP 8491A OPT 10 and OPT 03
Power Meter	.....	HP 435A
Power Sensor	.....	HP 8481A
Double Shielded Cable (17 required)	.....	HP 08708-6033
Noise Filter:		
SPST Switch	.....	HP 3101-0163
100 k $\Omega$ Resistor	.....	HP 0757-0465
100 $\mu$ F Capacitor	.....	HP 0180-0094

**NOTE**

An HP Model 432A Power Meter with a Model 478A Thermistor Mount can be used for this test. However, a 10 dB attenuator, such as the Model 8491A OPT 10, must be used with the mount. This will slightly degrade measurement accuracy.

PERFORMANCE TESTS

4-24. OUTPUT LEVEL ACCURACY TEST (Complete) (Cont'd)

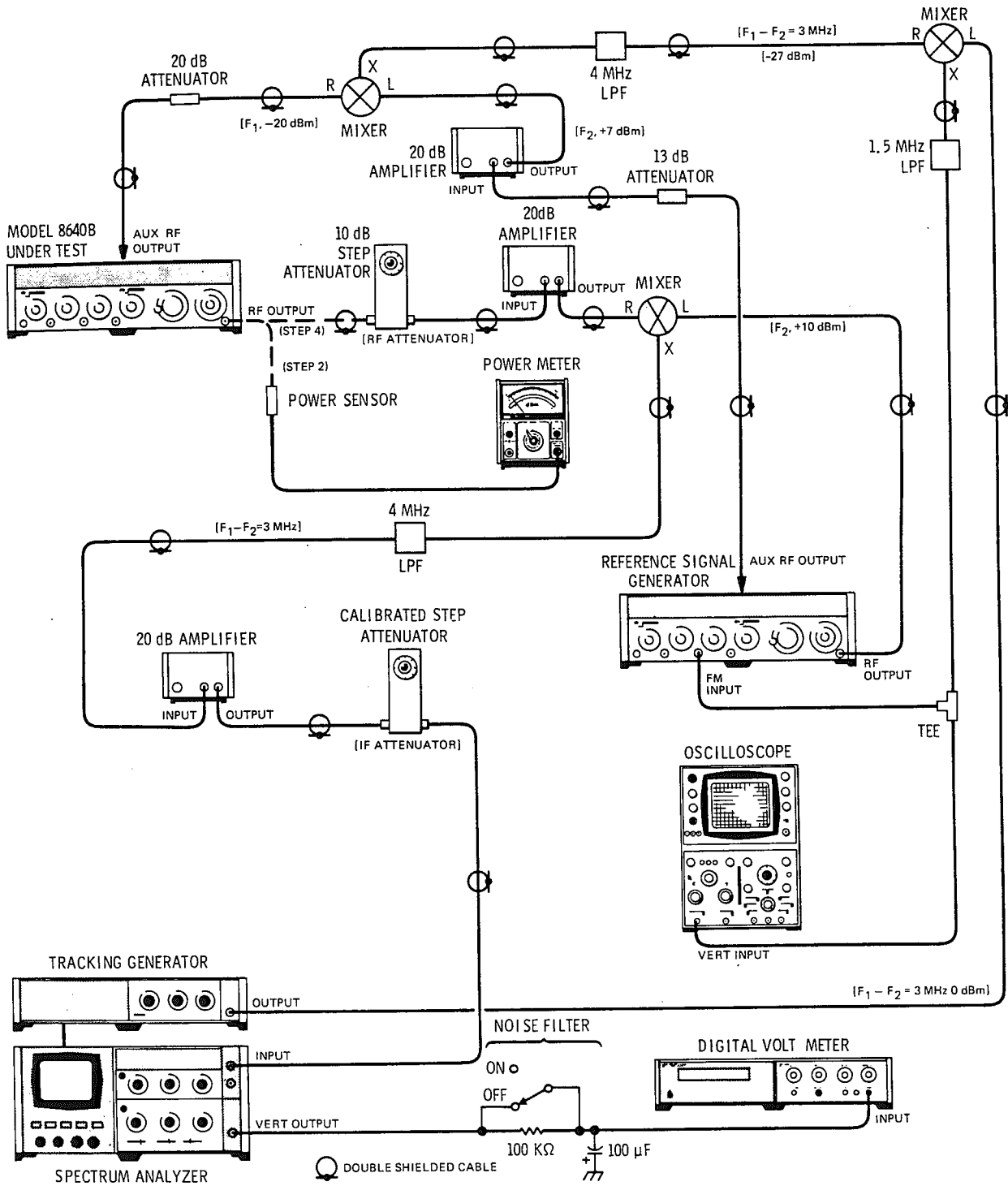

Figure 4-11. Output Level Accuracy Test Setup (Complete)



**PERFORMANCE TESTS**

**4-24. OUTPUT LEVEL ACCURACY TEST (Complete) (Cont'd)**

**PROCEDURE:**

1. Connect power meter and power sensor to the test Signal Generator's RF OUTPUT jack. Set test generator's controls as follows:

Meter Function	.....	LEVEL
COUNTER MODE: EXPAND	.....	Off
LOCK	.....	Off
Source	.....	INT
AM	.....	OFF
FM	.....	OFF
RANGE	.....	256 - 512 MHz
FREQUENCY TUNE	.....	512 MHz
OUTPUT LEVEL	.....	+19 dBm
RF ON/OFF	.....	ON

2. Set power meter's controls so that it can measure +19 dBm. Connect power sensor to test Signal Generator's RF OUTPUT.
3. Set test Signal Generator's RF OUTPUT LEVEL controls for levels (set using generator's panel meter) shown in the table below; verify that the level is within the specified tolerance.

Signal Generator		Power Meter Reading (dBm)
OUTPUT LEVEL Switch	RF Level Set (with Panel Meter)	
Full cw	+19 dBm	+17.5 _____ +20.5
	+13 dBm	+11.5 _____ +14.5
	+5 dBm	+3.0 _____ +7.0
1 step ccw from full cw	+13 dBm	+11.5 _____ +14.5
	+8 dBm	+6.5 _____ +9.5
	+3 dBm	+1.5 _____ +4.5
	-5 dBm	-7.0 _____ -3.0
2 steps ccw from full cw	+3 dBm	+1.5 _____ +4.5
3 steps ccw from full cw	-7 dBm	-8.5 _____ -5.5

---

**PERFORMANCE TESTS**

---

**4-24. OUTPUT LEVEL ACCURACY TEST (Complete) (Cont'd)**

4. Disconnect power meter and sensor from generator. Connect test generator's RF OUTPUT to the step attenuator as shown in Figure 4-11. Do not change any of the test generator's control settings (particularly the OUTPUT LEVEL vernier).
5. Set reference signal generator for 515 MHz signal (with no AM) at +10 dBm. Set its modulation controls for external FM (dc) and 640 kHz peak deviation (FM vernier at maximum).
6. Set the RF attenuator to 50 dB and the IF attenuator to 40 dB.
7. Connect spectrum analyzer to tracking generator. Set analyzer's center frequency controls to 3 MHz with the tuning stabilizer on; set resolution bandwidth to 10 Hz, span width per division (scan width) to 5 kHz, and input attenuation to 10 dB. Set the display controls for a linear display with 0.1 mV/div; set display smoothing (video filter) to 100 Hz and set the tracking generator for 0 dBm output.
8. Set oscilloscope for dc input coupling, vertical to 5 mV/div, and horizontal to 0.5 ms/div.
9. Set digital voltmeter's noise filter to maximum filtering, range to 10V, and function to dc.

**NOTE**

The noise filter between the analyzer and the DVM can be used instead of, or with, the DVM's noise filter whenever the DVM's reading is obscured by noise. To use this filter, switch it off (if it is on) for approximately two seconds to allow the capacitor to charge, then switch it on; wait approximately 30 seconds — to allow the filter to reach the average value of the signal — then take the reading.

10. Phase lock the system by tuning the reference signal generator's frequency to center the 3 MHz IF signal on analyzer's display. Set analyzer's span width per division to zero, then tune reference signal generator to indicate phase lock on the oscilloscope (the signal will peak, then become 0 Vdc when phase lock is reached).

**NOTE**

Care must be taken to ensure that all measurements are taken during phase lock. Also, the tracking generator's tracking adjustment should be periodically checked to ensure that the trace is peaked on the analyzer.

11. Adjust analyzer's display sensitivity controls for a -500 mVdc reading on the DVM. Measure the accuracy of test Signal Generator's output using IF substitution by switching the OUTPUT LEVEL switch in 10 dB steps while switching the IF attenuator (the calibrated 10 dB step attenuator). The DVM should read -500 mVdc  $\pm 0.5$  dB. If necessary, use test generator's OUTPUT LEVEL vernier to reset panel meter to +3 dB.

PERFORMANCE TESTS

4-24. OUTPUT LEVEL ACCURACY TEST (Complete) (Cont'd)

IF Attenuator (dB)	Test Generator OUTPUT LEVEL	DVM Readings (mVdc)
40	-7 dBm	-500 (set)
30	-17 dBm	-472.0 _____ -529.6
20	-27 dBm	-472.0 _____ -529.6
10	-37 dBm	-472.0 _____ -529.6
0	-47 dBm	-472.0 _____ -529.6

12. Set the RF attenuator to 0 dB and the IF attenuator to 50 dB. use analyzer's display sensitivity controls to set the DVM to the reading noted at the -47 dBm step, then continue. The DVM should read -500 mVdc ± 1 dB. If necessary, use test generator's OUTPUT LEVEL vernier to reset panel meter to +3 dB.

IF Attenuator (dB)	Test Generator OUTPUT LEVEL	DVM Readings (mVdc)
50	-47 dBm	Set level
40	-57 dBm	-445.6 _____ -561.0

13. Set the IF attenuator to 30 dB, OUTPUT LEVEL to -67 dBm, and then adjust the OUTPUT LEVEL vernier so that the test Signal Generator's panel meter reads -67 dBm, then continue. The DVM should read -500 mVdc ± 1 dB.

IF Attenuator (dB)	Test Generator OUTPUT LEVEL	DVM Readings (mVdc)
30	-67 dBm	-445.6 _____ -561.0
20	-77 dBm	-445.6 _____ -561.0
10	-87 dBm	-445.6 _____ -561.0

14. Set the IF attenuator to 0 dB, OUTPUT LEVEL to -97 dBm, and then adjust the OUTPUT LEVEL vernier so that the test generator's panel meter reads -97 dBm. The DVM should read -500 mVdc ± 1 dB.

-445.6 \_\_\_\_\_ -561.0 mVdc

PERFORMANCE TESTS

4-24. OUTPUT LEVEL ACCURACY TEST (Complete) (Cont'd)

15. Set the IF attenuator to 30 dB and use analyzer's display sensitivity controls to set the DVM to the reading noted in step 14, then continue. The DVM should read  $-500 \text{ mVdc} \pm 1 \text{ dB}$ . If necessary, use test generator's OUTPUT LEVEL vernier to reset panel meter to +3 dB.

IF Attenuator (dB)	Test Generator OUTPUT LEVEL	DVM Readings (mVdc)
30	-97 dBm	Set level
20	-107 dBm	-445.6 _____ -561.0
10	-117 dBm	-445.6 _____ -561.0
0	-127 dBm	-445.6 _____ -561.0

16. Set the IF attenuator to 20 dB and use analyzer's display sensitivity controls to set the DVM to the reading noted at the -127 dBm step above, then continue. The DVM should read  $-500 \text{ mVdc} \pm 1 \text{ dB}$ . If necessary, use test generator's OUTPUT LEVEL vernier to reset panel meter to +3 dB.

IF Attenuator (dB)	Test Generator OUTPUT LEVEL	DVM Readings (mVdc)
20	-127 dBm	Set level
10	-137 dBm	-445.6 _____ -561.0

17. Set the IF attenuator to 0 dB and adjust the OUTPUT LEVEL vernier so that test Signal Generator's panel meter reads  $0.013 \mu\text{V}$  (-144.75 dBm). The DVM should read  $-650 \text{ mVdc} \pm 1.5 \text{ dB}$ .

-546.9 \_\_\_\_\_ -772.5 mVdc

18. Verify the test accuracy by increasing the RF attenuator by 10 dB. The DVM should drop below -300 mVdc. If it does not, check the test setup for RF leakage paths.
19. Check output level accuracy at other output frequencies by setting the two generators for a 3 MHz difference frequency and repeating steps 1 through 18.

PERFORMANCE TESTS

4-25. OUTPUT LEVEL FLATNESS TEST

SPECIFICATION;

Level Flatness:  $<\pm 0.5$  dB flatness from 0.5 to 512 MHz referred to output at 50 MHz. (Flatness applies to +13 to -7 dBm and for top 10 dB of vernier range.)

DESCRIPTION:

A power meter is used to measure output level flatness across each band.

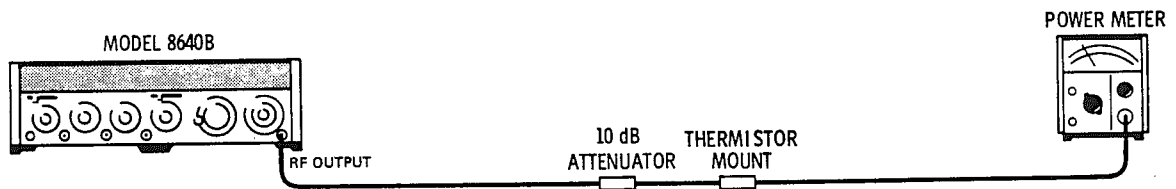

Figure 4-12. Output Level Flatness Test Setup

EQUIPMENT:

Power Meter	.....	HP 432A
Thermistor Mount	.....	HP 478A OPT H63
10 dB Attenuator	.....	HP 8491A OPT 10

NOTE

The mount's VSWR should be 1.1:1 max. The attenuator's VSWR should be 1.06:1 max with flatness  $\pm 0.05$  dB from 0.5 to 512 MHz.

PROCEDURE:

1. Connect equipment as shown in Figure 4-12 after setting Signal Generator's controls as follows:

Meter Function	.....	LEVEL
COUNTER MODE: EXPAND	.....	Off
LOCK	.....	Off
Source	.....	INT
AM	.....	OFF
FM	.....	OFF
RANGE	.....	32 - 64 MHz
FREQUENCY TUNE	.....	50 MHz
OUTPUT LEVEL	.....	+13 dBm (Vernier max cw)
RF ON/OFF	.....	ON

---

**PERFORMANCE TESTS**

---

**4-25. OUTPUT LEVEL FLATNESS TEST (Cont'd)**

2. Adjust OUTPUT LEVEL vernier for a power meter reading of +3 dBm at 50 MHz. Using RANGE and FREQUENCY TUNE controls, slowly tune Signal Generator from 512 MHz to 0.5 MHz. On each range, note maximum and minimum power meter readings in dBm.
3. The overall maximum reading and the overall minimum reading should both be within 0.5 dB of the reading at 50 MHz.

\_\_\_\_\_ 0.5 dB

---

**4-26. OUTPUT IMPEDANCE TEST (In Band)****SPECIFICATION:**

Impedance: 50Ω ac coupled, 40 Vdc maximum, VSWR <2.0 on 2V and 1V output ranges; <1.3 on all other ranges.

**DESCRIPTION:**

The generator's output signal is reflected back into the RF OUTPUT jack by a coaxial short at the end of an adjustable stub (a variable length of air-line). This reflected signal is re-reflected by any mismatch at the jack. The re-reflected signal combines with the output signal according to the relative phase and magnitude of the two signals. The combined signal is monitored by a directional coupler and then measured by a voltmeter. Maximum and minimum power levels are noted as the electrical length of the stub is varied (i.e., the distance from the RF OUTPUT jack to the coaxial short is varied). VSWR is then calculated from the formula

$$\text{VSWR} = \frac{V_{\text{max}}}{V_{\text{min}}}$$

PERFORMANCE TESTS

4-26. OUTPUT IMPEDANCE TEST (In Band) (Cont'd)

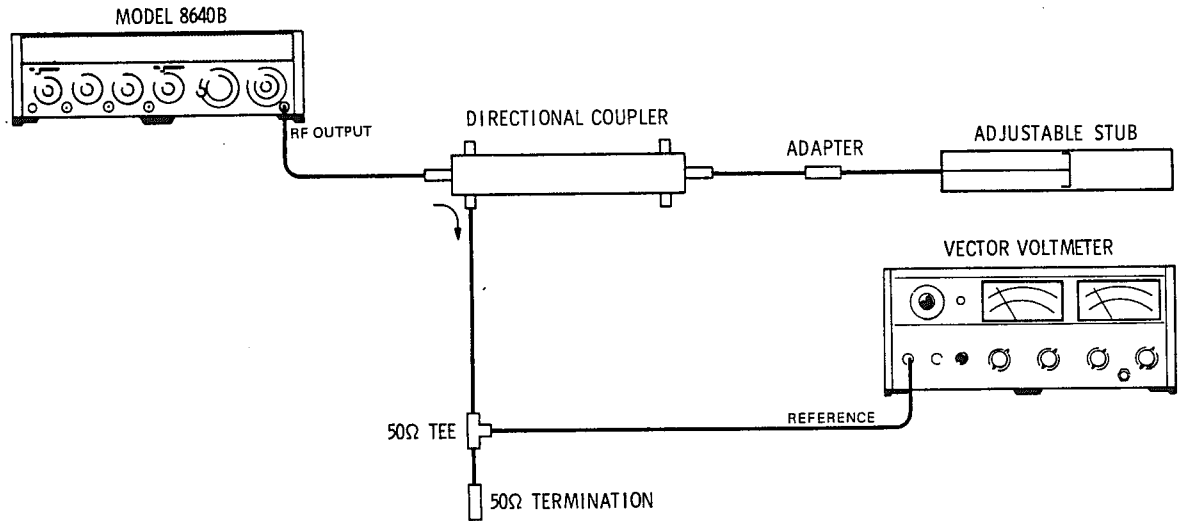

Figure 4-13. Output Impedance Test Setup (In Band)

EQUIPMENT:

Directional Coupler	HP 778D OPT 12
Adapter (Male Type N to GR 874)	HP 1250-0847
Adjustable Stub	General Radio 874-D50L
Vector Voltmeter	HP 8405A
50Ω Tee	HP 11536A
50Ω Termination	HP 908A

PROCEDURE:

1. Connect equipment as shown in Figure 4-13 after setting Signal Generator's controls as follows:

Meter Function	LEVEL
COUNTER MODE: EXPAND	Off
LOCK	Off
Source	INT
AM	OFF
FM	OFF
RANGE	256 - 512 MHz
FREQUENCY TUNE	512 MHz
OUTPUT LEVEL	+10 dBm (Switch 1 step cw from full cw)
RF ON/OFF	ON

---

**PERFORMANCE TESTS**

---

**4-26. OUTPUT IMPEDANCE TEST (In Band) (Cont'd)**

2. Set voltmeter so that it can measure 100 mV. Adjust the stub for a minimum indication on power meter. Adjust generator's OUTPUT LEVEL vernier for a 50 mV indication on voltmeter ( $V_{\min}$ ).
3. Adjust the stub for a maximum indication on voltmeter. The voltmeter should indicate  $<100$  mV ( $V_{\max}$ ).  

\_\_\_\_\_ 100 mV
4. Set generator's OUTPUT LEVEL switch one step ccw to 0 dBm. Set voltmeter so that it can measure 30 mV. Adjust the stub for a minimum indication on voltmeter. Adjust generator's OUTPUT LEVEL vernier for a 10 mV indication on voltmeter ( $V_{\min}$ ).
5. Adjust the stub for a maximum indication on voltmeter. The voltmeter should indicate  $<13$  mV ( $V_{\max}$ ).  

\_\_\_\_\_ 13 mV
6. Set generator's OUTPUT LEVEL switch one step ccw to  $-10$  dBm. Set voltmeter so that it can measure 10 mV. Adjust the stub for a minimum indication on voltmeter. Adjust generator's OUTPUT LEVEL vernier for a 5 mV indication on voltmeter ( $V_{\min}$ ).
7. Adjust the stub for a maximum indication on voltmeter. The voltmeter should indicate  $<6.5$  mV ( $V_{\max}$ ).  

\_\_\_\_\_ 6.5 mV
8. If desired, repeat at other frequencies between 256 and 512 MHz.

**NOTE**

The steps given above effectively check VSWR at all settings of the output attenuator (see Service Sheet 13).

---

**4-27. OUTPUT IMPEDANCE TEST (Out of Band)**
**SPECIFICATION:**

Impedance:  $50\Omega$ , ac coupled, 40 Vdc maximum, VSWR  $<2.0$  on 2V and 1V output ranges;  $<1.3$  on all other ranges.

**DESCRIPTION:**

A tracking generator is used as an external  $50\Omega$  signal source to feed a VSWR bridge. The output port of the bridge is connected to a spectrum analyzer. The through port of the bridge is connected to a short circuit to establish a reference, then to the generator output. Return loss versus frequency is displayed on the spectrum analyzer.

---



PERFORMANCE TESTS

4-27. OUTPUT IMPEDANCE TEST (Out of Band) (Cont'd)

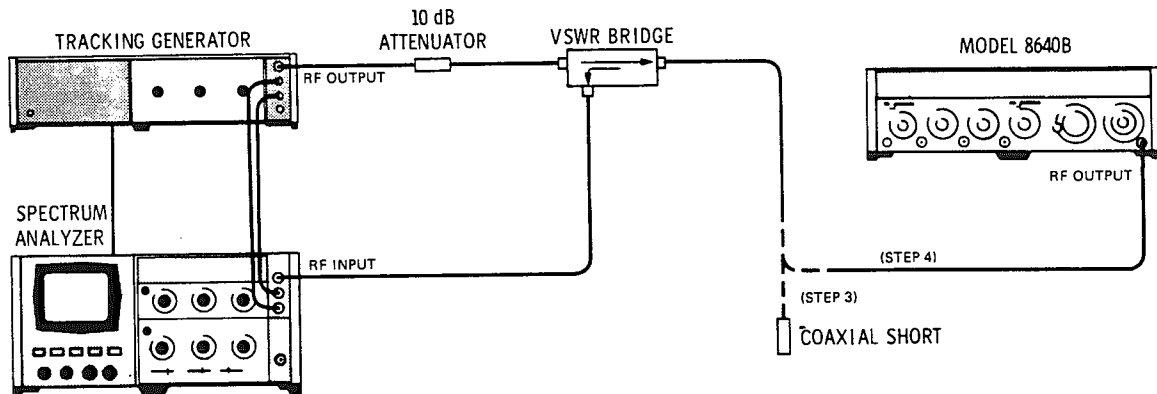

Figure 4-14. Output Impedance Test Setup (Out of Band)

EQUIPMENT:

Tracking Generator	.....	HP 8444A
Spectrum Analyzer	.....	HP 8554B/8552B/141T
VSWR Bridge	.....	Wiltron 60N50
Coaxial Short	.....	HP 11512A
10 dB Attenuator	.....	HP 8491A OPT 10

PROCEDURE:

1. Connect equipment as shown in Figure 4-14 after setting Signal Generator's controls as follows:

AM	.....	OFF
FM	.....	OFF
RANGE	.....	256 - 512 MHz
FREQUENCY TUNE	.....	Full cw
OUTPUT LEVEL	.....	+19 dBm
RF ON/OFF	.....	OFF

2. Set spectrum analyzer for a frequency span of 50 - 550 MHz, 300 kHz resolution bandwidth, and 20 dB input attenuation. Set tracking generator output level to 0 dBm.
3. To establish a reference level, connect coaxial short to bridge output port. Use the spectrum analyzer's vertical scale, logarithmic level controls to set the reference level trace to the top of the analyzer display.
4. Remove coaxial short and couple bridge output port to Signal Generator's RF OUTPUT connector. The difference, in dB, from the reference level established in step 3 to the level now visible on the display is the return loss of the generator's output port. The return loss should be >9.8 dB from 50 to 512 MHz (VSWR <2.0:1).

9.8 dB \_\_\_\_\_

**PERFORMANCE TESTS**

---

**4-27. OUTPUT IMPEDANCE TEST (Out of Band) (Cont'd)**

5. Set generator's FREQUENCY TUNE control fully ccw and repeat steps 3 and 4. Return loss should be >9.8 dB from 50 to 512 MHz.

9.8 dB \_\_\_\_\_

6. Set generator's OUTPUT LEVEL switch two steps ccw to -1 dBm and repeat steps 3 and 4. Return loss should be >18.3 dB from 50 to 512 MHz (VSWR <1.3:1).

18.3 dB \_\_\_\_\_

7. Set generator's FREQUENCY TUNE control fully cw and repeat steps 3 and 4. Return loss should be >18.3 dB from 50 to 512 MHz.

18.3 dB \_\_\_\_\_

---

**4-28. AUXILIARY OUTPUT TEST**

**SPECIFICATION:**

Auxiliary Output: Rear panel BNC output is >-5 dBm into 50Ω, source impedance is approximately 500Ω.

**DESCRIPTION:**

The power level from the generator's rear panel Auxiliary RF Output jack is measured with a power meter as the Signal Generator is tuned from 512 MHz to 500 kHz.

**EQUIPMENT:**

Power Meter . . . . . HP 432A  
 Thermistor Mount . . . . . HP 478A OPT H63

**PROCEDURE:**

1. Connect power meter's thermistor mount to generator's rear panel Auxiliary Output jack after setting Signal Generator's controls as follows:

COUNTER MODE: EXPAND . . . . . Off  
 LOCK . . . . . Off  
 Source . . . . . INT  
 AM . . . . . OFF  
 FM . . . . . OFF  
 RANGE . . . . . 256 - 512 MHz  
 FREQUENCY TUNE . . . . . 512 MHz  
 RF ON/OFF . . . . . ON

---

**PERFORMANCE TESTS**

---

**4-28. AUXILIARY OUTPUT TEST (Cont'd)**

2. Use generator's FREQUENCY TUNE and RANGE controls to tune from 512 to 0.5 MHz. The power meter should read  $> -5$  dBm at all frequencies.

-5 dBm \_\_\_\_\_

---

**4-29. OUTPUT LEAKAGE TEST****SPECIFICATION:**

Leakage: (With all unused outputs terminated properly). Leakage limits are below those specified in MIL-I-6181D. Furthermore, less than  $3 \mu\text{V}$  is induced in a 2-turn, 1-inch diameter loop 1 inch away from any surface and measured into a  $50\Omega$  receiver.

**DESCRIPTION:**

A loop antenna is held one inch from all surfaces of the Signal Generator and any leakage monitored with a spectrum analyzer. The loop antenna is suspended in a molding so that when the molding is in contact with a surface, the loop antenna is one inch from the surface.

**NOTE**

The use of a screen room may be necessary to reduce external radiated interference.

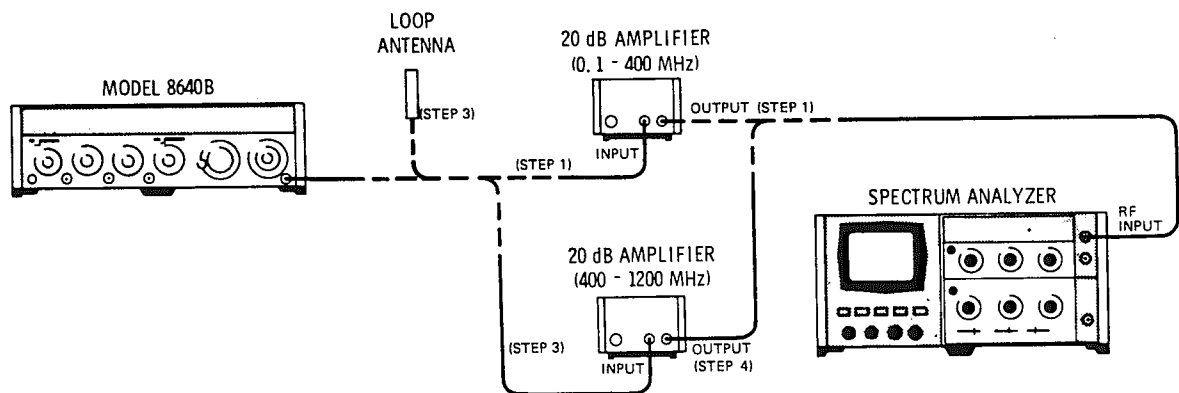

Figure 4-15. Output Leakage Test Setup

**NOTE**

To avoid disturbing antenna's field and causing measurement error, grasp antenna at the end that has the BNC connector.

---



PERFORMANCE TESTS

4-29. OUTPUT LEAKAGE TEST (Cont'd)

5. Set the analyzer's center frequency controls to 700, 900, and 1100 MHz. Hold the end of the loop antenna cylinder in contact with all surfaces of the generator at each frequency setting. All signals and noise should be below the -27 dB graticule line (below -97 dBm) from 600 MHz to 1200 MHz.

-97 dBm \_\_\_\_\_

4-30. INTERNAL MODULATION OSCILLATOR TEST

SPECIFICATION:

Standard:

- Frequency: fixed 400 Hz and 1000 Hz  $\pm 2\%$ .
- Output Level: indicated 10 mVrms to 1 Vrms into 600 ohms.

Option 001:

- Frequency: variable 20 Hz to 600 kHz  $\pm 10\%$  in 5, decade continuous bands plus fixed 400 Hz and 1000 Hz  $\pm 2\%$ .
- Output Level: 20 mVrms to 3 Vrms into 600 ohms.

DESCRIPTION:

The internal modulation oscillator output is measured with a voltmeter and a frequency counter to verify its frequency range and accuracy and its level.

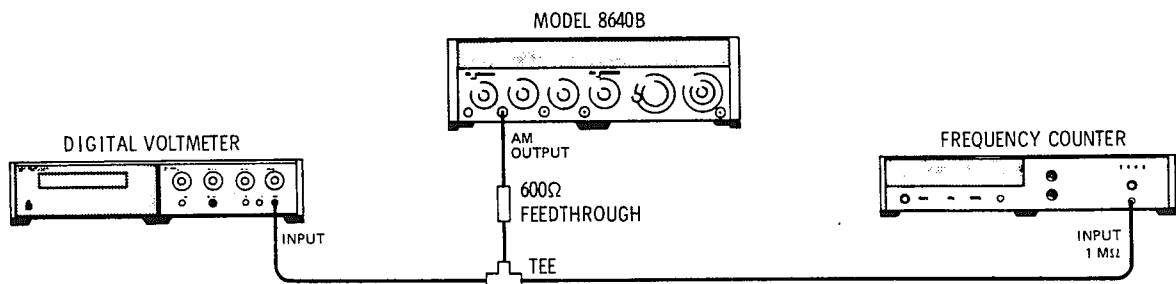

Figure 4-16. Internal Modulation Oscillator Test Setup

EQUIPMENT:

Frequency Counter	.....	HP 5327C
Digital Voltmeter	.....	HP 3480B/3484A
600 Ohm Feedthrough Termination	.....	HP 11095A



PERFORMANCE TESTS

4-31. INTERNAL MODULATION OSCILLATOR DISTORTION TEST (Option 001) (Cont'd)

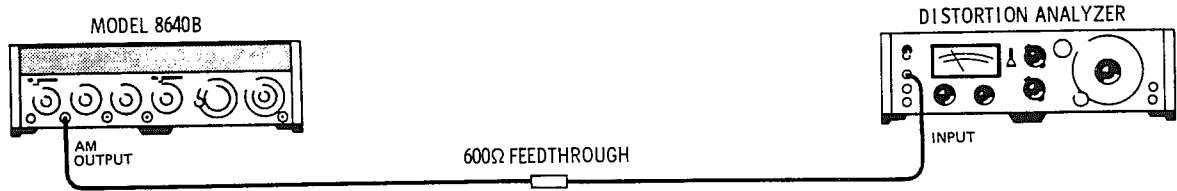

Figure 4-17. Internal Modulation Oscillator Distortion Test Setup

EQUIPMENT:

- Distortion Analyzer . . . . . HP 333A
- 600 Ohm Feedthrough . . . . . HP 11095A

PROCEDURE:

1. Connect equipment as shown in Figure 4-17 after setting Signal Generator's controls as follows:

- AM . . . . . INT
- AUDIO OUTPUT LEVEL . . . . . 3V
- MODULATION FREQUENCY . . . . . As specified
- FM . . . . . OFF

2. Set the MODULATION FREQUENCY controls to various frequencies within the variable ranges shown below. At each frequency tested, calibrate the distortion analyzer and measure the distortion. It should be as shown.

Frequency Range	Distortion
20 Hz to 2 kHz	_____ <0.5%
2 kHz to 600 kHz	_____ <1.0%

3. Set the MODULATION FREQUENCY controls to the 400 Hz and 1 kHz fixed frequencies. Distortion at both frequencies should be below 0.25%.

400 Hz: \_\_\_\_\_ 0.25%  
 1 kHz: \_\_\_\_\_ 0.25%

PERFORMANCE TESTS

4-32. AM 3 dB BANDWIDTH TEST

SPECIFICATION:

AM 3 dB Bandwidth:

Frequency Bands	0 to 50% AM	50 to 90% AM
0.5 - 2 MHz	20 kHz	12.5 kHz
2 - 8 MHz	40 kHz	25 kHz
8 - 512 MHz	60 kHz	50 kHz

DESCRIPTION:

An audio spectrum analyzer is used to measure the 3 dB bandwidth. The analyzer is set to sweep over the specified audio frequency range and its tracking generator output is used to amplitude modulate the Signal Generator. The generator's RF output is detected and fed to the analyzer's input. Amplitude variation is measured on the analyzer's display.

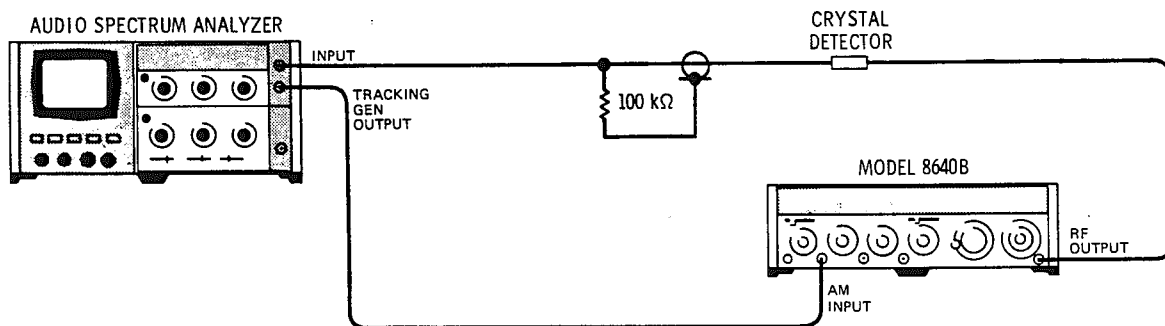

Figure 4-18. AM 3 dB Bandwidth Test Setup

EQUIPMENT:

- Audio Spectrum Analyzer . . . . . HP 141T/8552B/8556A
- Crystal Detector . . . . . HP 8471A
- 100 kΩ Resistor . . . . . HP 0757-0465



**PERFORMANCE TESTS**

**4-32. AM 3 dB BANDWIDTH TEST (Cont'd)**

**PROCEDURE:**

1. Connect equipment as shown in Figure 4-18 after setting Signal Generator's controls as follows:

```

Meter Function . . . . . AM
COUNTER MODE: EXPAND . . . . . Off
                LOCK . . . . . Off
                Source . . . . . INT
AM . . . . . DC
MODULATION . . . . . Full cw
FM . . . . . OFF
RANGE . . . . . 8 - 16 MHz
FREQUENCY TUNE . . . . . 8 MHz
OUTPUT LEVEL . . . . . +3 dBm (Vernier full cw)
RF ON/OFF . . . . . ON
    
```

2. Set analyzer's center frequency controls to 1 kHz, fixed (not scanning) and adjust tracking generator's output level controls for 50% AM as indicated on Signal Generator's panel meter.
3. Now set spectrum analyzer's resolution bandwidth to 1 kHz, and set frequency span (scan width) controls for a zero to 100 kHz span. Set display for 2 dB per division.
4. Set analyzer's display reference level controls to display the detected sweep. Slowly tune Signal Generator from 8 to 16 MHz while noting amplitude variations from 0 - 60 kHz on the display. The variation should be <3 dB referenced to the level at 1 kHz.

\_\_\_\_\_ 3 dB

5. Set analyzer and Signal Generator as shown below. At each RANGE switch setting, repeat the procedure outlined in steps 2 through 4, except set analyzer for the frequency and %AM shown. The amplitude variation should, in each case, be <3 dB.

Signal Generator RANGE	% AM (Tracking Gen. Level)	Frequency Span	Amplitude Variation
8 - 16 MHz	90%	0 to 50 kHz	_____ 3 dB
4 - 8 MHz	50%	0 to 40 kHz	_____ 3 dB
4 - 8 MHz	90%	0 to 25 kHz	_____ 3 dB
1 - 2 MHz	50%	0 to 20 kHz	_____ 3 dB
1 - 2 MHz	90%	0 to 12.5 kHz	_____ 3 dB

PERFORMANCE TESTS

4-33. AM DISTORTION TEST

SPECIFICATION:

AM Distortion: (at 400 Hz and 1 kHz rates)

Frequency Bands	0 - 50% AM	50 - 90% AM
0.5 - 512 MHz	<1%	<3%

DESCRIPTION:

A spectrum analyzer (used to demodulate the AM) is connected to RF OUTPUT, and percent of AM is set; a distortion analyzer is connected to the analyzer's vertical output and used to measure AM distortion.

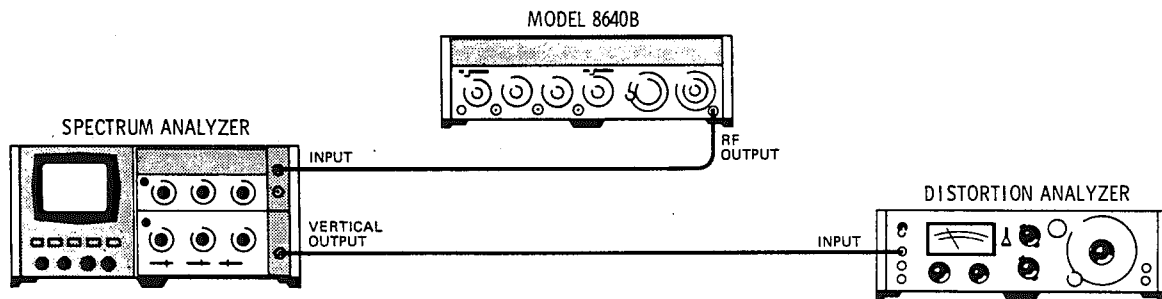

Figure 4-19. AM Distortion Test Setup

EQUIPMENT:

- Spectrum Analyzer . . . . . HP 141T/8552B/8554B
- Distortion Analyzer . . . . . HP 333A

PROCEDURE:

1. Connect equipment as shown in Figure 4-19 after setting Signal Generator's controls as follows:

- Meter Function . . . . . AM
- COUNTER MODE: EXPAND . . . . . Off
- LOCK . . . . . Off
- Source . . . . . INT
- AM . . . . . OFF
- MODULATION . . . . . Full ccw

**PERFORMANCE TESTS**

---

**4-33. AM DISTORTION TEST (Cont'd)**

MODULATION FREQUENCY . . . . . 1000 Hz  
 FM . . . . . OFF  
 RANGE . . . . . 256 - 512 MHz  
 FREQUENCY TUNE . . . . . 512 MHz  
 OUTPUT LEVEL . . . . . -17 dBm (Vernier full cw)  
 RF ON/OFF . . . . . ON

2. Set spectrum analyzer's resolution bandwidth to 300 kHz, input attenuation to 20 dB, frequency span per division (scan width) to 10 MHz, scale to linear, and adjust center frequency and scale reference level controls to center the 512 MHz signal on the display. Set frequency span per division to 0 Hz and display smoothing (video filter) to 10 kHz. Peak trace on display with center frequency controls; set trace to the center of display with reference level controls.
3. Set generator's AM switch to INT and adjust MODULATION control for 50% modulation as read on generator's panel meter.
4. Calibrate the distortion analyzer for 1 kHz. Measure and record distortion; it should be less than 1% with trace peaked on analyzer display.
 

\_\_\_\_\_ 1%
5. Use generator's MODULATION control to set AM percent to 70% and 90%; calibrate the distortion analyzer and measure distortion at each modulation depth. Distortion should be less than 3% with trace peaked on analyzer display.
 

70% AM: \_\_\_\_\_ 3%  
 90% AM: \_\_\_\_\_ 3%
6. Increase generator's RF OUTPUT LEVEL one step cw and reduce the vernier to give -17 dBm. Repeat steps 3 to 5.

---

**4-34. AM SENSITIVITY AND ACCURACY TEST**

**SPECIFICATION:**

External AM Sensitivity: (400 Hz and 1 kHz rates)  
 (0.1 ± 0.005)% AM per mV peak into 600Ω with AM vernier at full CW position.

Indicated AM Accuracy: (400 Hz and 1 kHz rates using internal meter)  
 ±8% of reading on 0 - 10 scale  
 ±9% of reading on 0 - 3 scale (for greater than 10% of full scale).

PERFORMANCE TESTS

4-34. AM SENSITIVITY AND ACCURACY TEST (Cont'd)

DESCRIPTION:

AM sensitivity accuracy and meter accuracy are measured by comparing the actual amount of amplitude modulation to the level of the input modulating signal. A spectrum analyzer is used to demodulate the AM. The analyzer is used with zero frequency span at the carrier frequency. A DVM is used to measure the ac and dc voltages at the analyzer's vertical output, and the dc value of the carrier is set to 282.8 mVdc; the rms value of the modulation is then a very accurate measure of AM percent (% AM is 1/2 the ac voltage in mVrms).

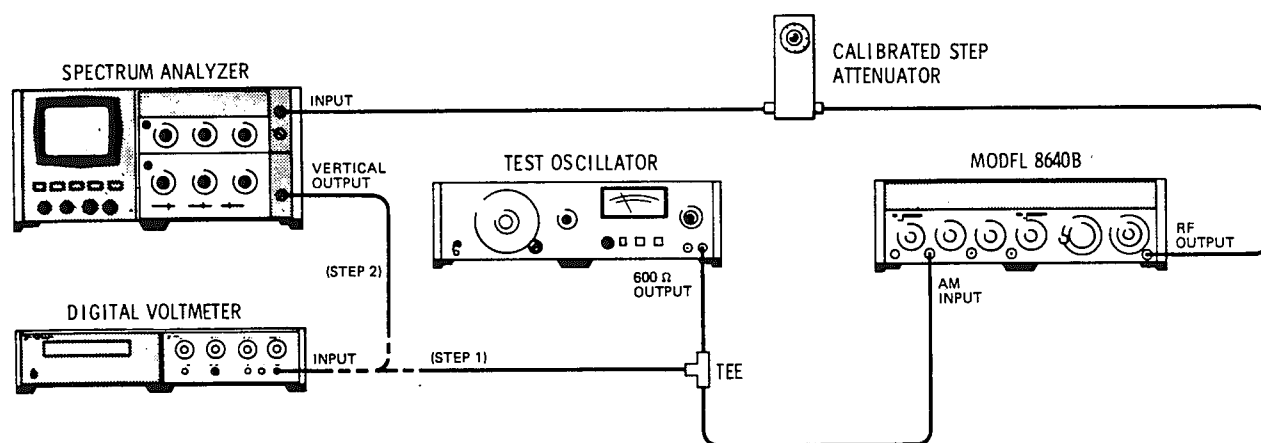

Figure 4-20. AM Sensitivity and Accuracy Test Setup

EQUIPMENT:

Spectrum Analyzer	.....	HP 141T/8552B/8554B
Digital Voltmeter	.....	HP 3480B/3484A
Test Oscillator	.....	HP 652A
Calibrated Step Attenuator	.....	HP 355D OPT H36

PROCEDURE:

1. Connect equipment as shown in Figure 4-20 after setting Signal Generator's controls as follows:

Meter Function	.....	AM
COUNTER MODE: EXPAND	.....	Off
LOCK	.....	Off
Source	.....	INT
AM	.....	AC
MODULATION	.....	Full cw

PERFORMANCE TESTS

4-34. AM SENSITIVITY AND ACCURACY TEST (Cont'd)

FM . . . . . OFF  
 RANGE . . . . . 256 - 512 MHz  
 FREQUENCY TUNE . . . . . 512 MHz  
 OUTPUT LEVEL . . . . . -27 dBm (switch 5 steps ccw from full cw, vernier full cw)  
 RF ON/OFF . . . . . ON

2. Set test oscillator for a 1 kHz, 636.39 mVrms signal as read on DVM (90% AM). Disconnect DVM from test oscillator (leave oscillator connected to generator). Connect DVM to spectrum analyzer's vertical output. Set calibrated step attenuator to 0 dB.
3. Set spectrum analyzer's resolution bandwidth to 300 kHz, input attenuation to 20 dB, frequency span per division (scan width) to 20 kHz (tuning stabilizer on), scale to linear, and adjust center frequency and scale reference level controls to center the 512 MHz signal on the display. Set frequency span per division to 0 Hz and display smoothing (video filter) to 10 kHz. Peak the trace on the display with the center frequency controls; set the trace to the center of the display with the reference controls.

NOTE

Step 4 measures the analyzer's dc offset ( $V_{off}$ ) and must be performed to ensure the accuracy of this test. However if  $V_{off}$  for the analyzer being used has recently been measured and noted, skip step 4 and go on to step 5 (and eliminate the calibrated step attenuator from the test setup).

4. Measure analyzer's dc offset ( $V_{off}$ ) by performing steps "a" through "f".
  - a. Set generator's controls as follows:

Meter Function . . . . . LEVEL  
 AM . . . . . OFF  
 RANGE . . . . . 2 - 4 MHz  
 FREQUENCY TUNE . . . . . 3 MHz

- b. Set analyzer's center frequency controls to 3 MHz.
- c. Adjust analyzer's reference level controls for -500 mVdc indicated on DVM ( $V_{DET 1}$ ).
- d. Set step attenuator to 20 dB. Note DVM reading ( $V_{DET 2}$ ).
- e. Calculate  $V_{off}$  where

$$V_{off} = \frac{V_{DET 2} - \alpha V_{DET 1}}{1 - \alpha}$$

**PERFORMANCE TESTS**

**4-34. AM SENSITIVITY AND ACCURACY TEST (Cont'd)**

and  $\alpha = V_{RF 2}/V_{RF 1}$  (i.e.,  $\alpha$  = attenuation; for 20 dB it is 0.1)

therefore

$$V_{off} = \frac{V_{DET 2} - 50 \text{ mVdc}}{0.9}$$

- f. Reset step attenuator to 0 dB, Signal Generator as specified in step 1, and spectrum analyzer as specified in step 3.
- 5. To calibrate the spectrum analyzer for the percent of AM measurement, use the analyzer's reference level controls to set  $-282.8 \text{ mV} + V_{off}$  at vertical output (as measured on the DVM). For example, if  $V_{off}$  is +50.0 mV, then set  $-282.8 \text{ mV} + (+50.0 \text{ mV})$  or  $-232.8 \text{ mV}$  at vertical output. (Check that trace is peaked on analyzer display.)
- 6. To measure modulation percent, set DVM to measure mVrms (ac only). The DVM should read  $180 \text{ mVrms} \pm 5\%$ . (Check that trace is peaked on analyzer display.)

External Sensitivity Accuracy: 171.0 \_\_\_\_\_ 189.0 mVrms

- 7. To check indicated accuracy, set test oscillator's amplitude controls for a reading of 9 (90% AM) on the 0 - 10 scale of generator's panel meter. The DVM should read  $180 \text{ mVrms} \pm 8\%$ . (Check that trace is peaked on analyzer display.)

165.6 \_\_\_\_\_ 194.4 mVrms

- 8. Set the test oscillator's amplitude controls for the panel meter readings shown below. The DVM should read as specified. (After each reading, check that trace is peaked on analyzer display.)

% AM	Panel Meter		Digital Voltmeter Reading
	Reading (Set)	Scale	
70%	7	0 - 10	128.8 _____ 151.2 mVrms
50%	5	0 - 10	92.0 _____ 108.0 mVrms
30%	either 3	0 - 10	55.2 _____ 64.8 mVrms
	or 3	0 - 3	54.6 _____ 65.4 mVrms
20%	2	0 - 3	36.4 _____ 43.6 mVrms
10%	1	0 - 3	18.2 _____ 21.8 mVrms

**NOTE**

30% AM may be set on either the 0 - 10 scale or the 0 - 3 scale, depending upon whether 30% is approached from above or below.

PERFORMANCE TESTS

4-35. PEAK INCIDENTAL PHASE MODULATION TEST

SPECIFICATION:

Peak Incidental PM (at 30% AM):  
 Less than 0.15 radians, 0.5 to 128 MHz.  
 Less than 0.3 radians, 128 to 512 MHz.

DESCRIPTION:

A vector voltmeter is used to compare the phase of the signal into the generator's modulation amplifier with the phase of the same signal (modulated at a 0.1 Hz rate) at the RF OUTPUT port. The signal is supplied by the generator's own oscillator and divider circuits and has low incidental PM.

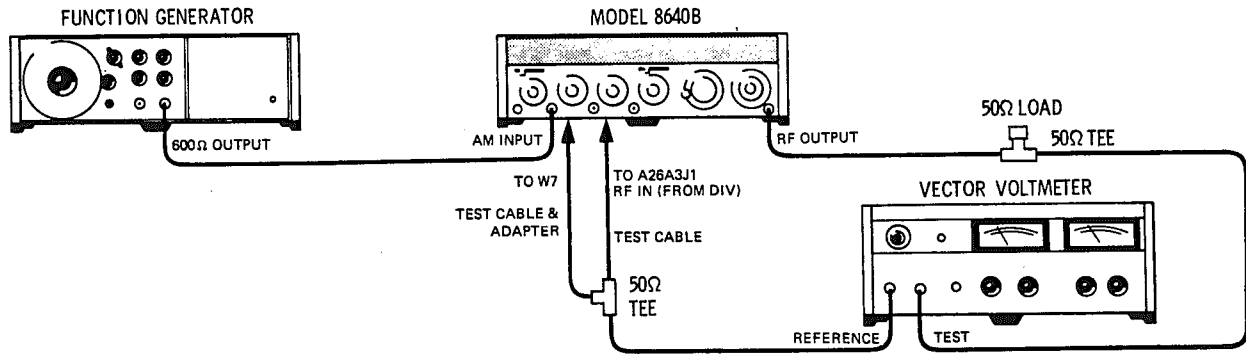

Figure 4-21. Peak Incidental Phase Modulation Test Setup

EQUIPMENT:

Function Generator	.....	HP 3300A
Vector Voltmeter	.....	HP 8405A
50 Ohm Tee (2 required)	.....	HP 11536A
50 Ohm Load	.....	HP 11593A
Test Cable (2 required)	.....	HP 11592-60001
Adapter	.....	HP 1250-0827

PERFORMANCE TESTS

4-35. PEAK INCIDENTAL PHASE MODULATION TEST (Cont'd)

**WARNING**

This test is performed with power supplied to the instrument while protective covers are removed. Be careful when performing this test. Line voltage is always present on terminals including the power input connector, fuse holder, power switch, etc. In addition, when the instrument is on, energy available at many points may result in personal injury or death when contacted.

Capacitors inside the instrument may still be charged even if the instrument has been disconnected from its line power source.

PROCEDURE:

1. Disconnect instrument from the line power source. Remove bottom cover from Signal Generator. Remove semi-rigid coaxial cable W7 from jack A26A3J1 labeled RF IN (FROM DIV). Connect one test cable from the tee to A26A3J1; connect other test cable, with adapter, from the tee to W7. Connect instrument to line power source. Allow one hour warm-up time before continuing with this test.

NOTE

See the last foldout sheet in this manual for component identification.

2. Finish connecting equipment as shown in Figure 4-21 after setting Signal Generator's controls as follows:

Meter Function	AM
COUNTER MODE: EXPAND	Off
LOCK	Off
Source	INT
AM	DC
FM	OFF
RANGE	256 - 512 MHz
FREQUENCY TUNE	512 MHz
OUTPUT LEVEL	-7 dBm (Vernier full cw)
RF ON/OFF	ON

3. Set function generator for 1 kHz at approximately 500 mVrms and adjust Signal Generator's MODULATION control for 30% AM as read on Signal Generator's panel meter. Set function generator for 0.1 Hz. (The % AM remains the same. The low rate is necessary for the vector voltmeter's metering circuitry.)
4. Set Signal Generator's AM switch to OFF. Set vector voltmeter's frequency range to 300 - 600 MHz. Zero the voltmeter's phase meter.
5. Set Signal Generator's AM switch to DC. The vector voltmeter's phase meter should indicate less than  $\pm 17.2^\circ$  of deviation (maximum).

\_\_\_\_\_  $\pm 17.2^\circ$



---

**PERFORMANCE TESTS**

---

**4-35. PEAK INCIDENTAL PHASE MODULATION TEST (Cont'd)**

6. Set Signal Generator's RANGE to 64 - 128 MHz, FREQUENCY TUNE to 128 MHz and repeat steps 3 through 5 (except set vector voltmeter frequency range to 80 - 150 MHz). The voltmeter's phase meter should indicate less than  $\pm 8.6^\circ$  of deviation (maximum).
- \_\_\_\_\_  $\pm 8.6^\circ$
7. Disconnect instrument from the line power source. Remove test cables, reconnect cable W7 to jack A26A3J1, and replace bottom cover. Connect instrument to line power source. Allow one hour warm-up time before continuing with this test.
8. Check Signal Generator for correct RF output on each frequency range.

**WARNING**

Capacitors inside the instrument may still be charged even if the instrument has been disconnected from its line power source.

---

**4-36. PULSE MODULATION TEST****SPECIFICATION:**

**Pulse Modulation** (specifications apply for top 10 dB of output vernier range):

Frequency Bands (MHz)	0.5 - 1	1 - 2	2 - 8	8 - 32	32 - 512
Rise and Fall Times	$< 9 \mu s$	$< 4 \mu s$	$< 2 \mu s$	$< 1 \mu s$	
Pulse Repetition Rate	50 Hz to 50 kHz		50 Hz to 100 kHz	50 Hz to 250 kHz	50 Hz to 500 kHz
Pulse Width Minimum for Level Accuracy within 1 dB of CW ( $> 0.1\%$ duty cycle)	10 $\mu s$		5 $\mu s$	2 $\mu s$	

PERFORMANCE TESTS

4-36. PULSE MODULATION TEST (Cont'd)

DESCRIPTION:

A pulse generator is used to pulse modulate the Signal Generator. The RF pulse output is detected and displayed and measured on an oscilloscope. For RF outputs above 32 MHz, a reference signal generator and a mixer are used to down-convert the signal to within the range of the oscilloscope.

NOTE

If a high frequency oscilloscope is available, such as the HP 183C/1830A/1840A, the above measurement may be made directly to frequencies slightly beyond the oscilloscope's nominal bandwidth. Use the oscilloscope's 50Ω input.

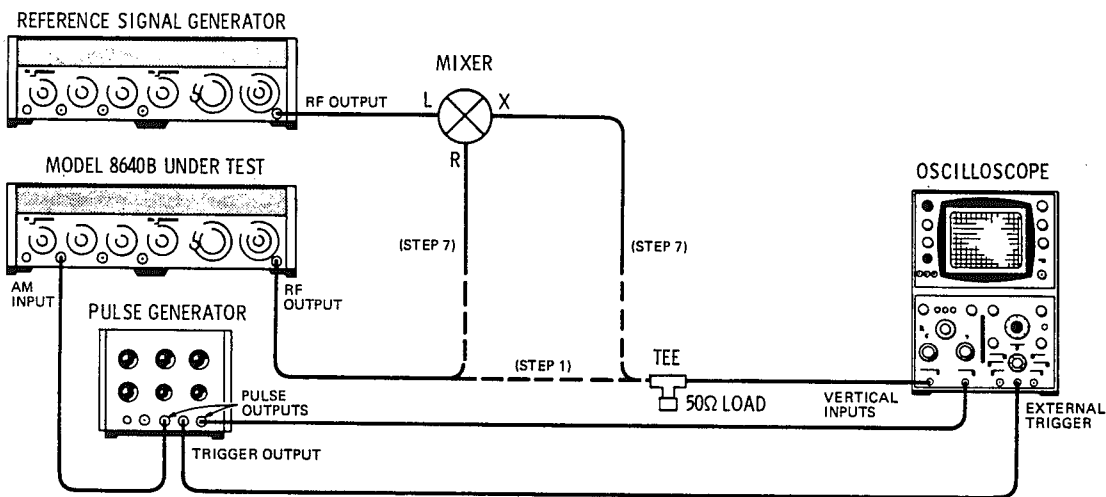

Figure 4-22. Pulse Modulation Test Setup

EQUIPMENT:

Reference Signal Generator	HP 8640A
Mixer	HP 10514A
50 Ohm Load	HP 11593A
Pulse Generator	HP 8003A
Oscilloscope	HP 180A/1801A/1820C
Crystal Detector	HP 8471A

NOTE

The reference signal generator should have a frequency range of 20 - 500 MHz with an output of +7 dBm.

PERFORMANCE TESTS

4-36. PULSE MODULATION TEST (Cont'd)

PROCEDURE:

1. Connect equipment as shown in Figure 4-22, with oscilloscope connected directly to test generator's RF OUTPUT, after setting test Signal Generator's controls as follows:

Meter Function	LEVEL
COUNTER MODE: EXPAND	Off
LOCK	Off
Source	INT
AM	PULSE
FM	OFF
RANGE	0.5 - 1 MHz
FREQUENCY TUNE	1 MHz
OUTPUT LEVEL	-17 dBm (Vernier full cw)
RF ON/OFF	ON

2. Set pulse generator for a repetition rate of 100 Hz, a pulse width of 10  $\mu$ s, and an amplitude of 1V.
3. Adjust oscilloscope to display the RF pulse envelope. Readjust the pulse width for 10  $\mu$ s (measured at 50% amplitude points) and measure the rise and fall times (see Figure 4-23). Both should be less than 9  $\mu$ s (measured between 10% and 90% of the full pulse amplitude).

Rise Time: \_\_\_\_\_ 9  $\mu$ s  
 Fall Time: \_\_\_\_\_ 9  $\mu$ s

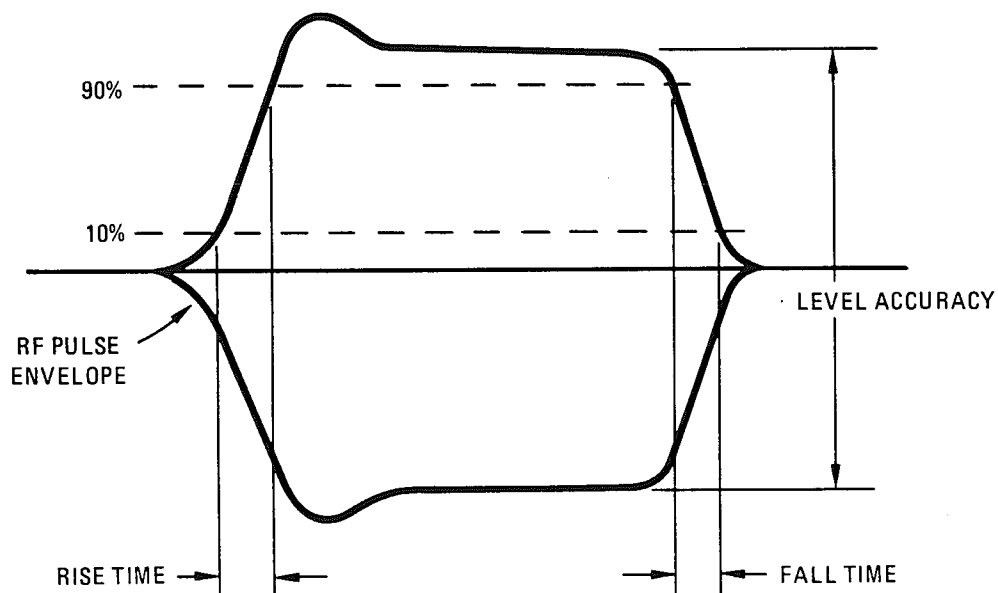

Figure 4-23. Pulse Measurements

**PERFORMANCE TESTS**

**4-36. PULSE MODULATION TEST (Cont'd)**

4. Set test Signal Generator's AM switch to OFF and adjust oscilloscope's vertical controls for 6 divisions of deflection on the display (peak to peak).
5. Set test Signal Generator's AM switch to PULSE. Pulse amplitude (peak to peak) on oscilloscope's display should be 5.4 to 6.7 divisions.

Level Accuracy 5.4 \_\_\_\_\_ 6.7 div

6. Repeat steps 1 through 5 for the frequency ranges shown below. The rise and fall times and level accuracy should be as specified.

Signal Generator Frequency RANGE	Pulse Generator		Rise Time	Fall Time	Level Accuracy
	Pulse Rate	Pulse Width			
1 - 2 MHz	100 Hz	10 $\mu$ s	_____ < 4 $\mu$ s	_____ < 4 $\mu$ s	5.4 _____ 6.7 div
2 - 4 MHz	200 Hz	5 $\mu$ s	_____ < 2 $\mu$ s	_____ < 2 $\mu$ s	5.4 _____ 6.7 div
4 - 8 MHz	200 Hz	5 $\mu$ s	_____ < 2 $\mu$ s	_____ < 2 $\mu$ s	5.4 _____ 6.7 div
8 - 16 MHz	500 Hz	2 $\mu$ s	_____ < 1 $\mu$ s	_____ < 1 $\mu$ s	5.4 _____ 6.7 div
16 - 32 MHz	500 Hz	2 $\mu$ s	_____ < 1 $\mu$ s	_____ < 1 $\mu$ s	5.4 _____ 6.7 div

7. Connect test generator to mixer and mixer to oscilloscope (across 50 ohm load).
8. Repeat steps 2 through 5 for the frequency ranges shown below. At each frequency range, set the pulse generator as specified, and set the reference signal generator for an output frequency 10 MHz below the output frequency of the test generator. The reference generator's output should be at +7 dBm with no modulation.

Signal Generator Frequency RANGE	Pulse Generator		Rise Time	Fall Time	Level Accuracy
	Pulse Rate	Pulse Width			
32 - 64 MHz	500 Hz	2 $\mu$ s	_____ < 1 $\mu$ s	_____ < 1 $\mu$ s	5.4 _____ 6.7 div
64 - 128 MHz	500 Hz	2 $\mu$ s	_____ < 1 $\mu$ s	_____ < 1 $\mu$ s	5.4 _____ 6.7 div
128 - 256 MHz	500 Hz	2 $\mu$ s	_____ < 1 $\mu$ s	_____ < 1 $\mu$ s	5.4 _____ 6.7 div
256 - 512 MHz	500 Hz	2 $\mu$ s	_____ < 1 $\mu$ s	_____ < 1 $\mu$ s	5.4 _____ 6.7 div

9. Increase the test Signal Generator's RF OUTPUT LEVEL one step cw and reduce the vernier to give -17 dBm. Repeat steps 3 to 8.

PERFORMANCE TESTS

4-37. PULSE ON/OFF RATIO TEST

SPECIFICATION:

Pulse ON/OFF ratio at maximum vernier: >40 dB.

DESCRIPTION:

The on/off ratio of the pulse modulation circuits is measured with a spectrum analyzer.

EQUIPMENT:

Spectrum Analyzer . . . . . HP 141T/8552B/8554B

PROCEDURE:

1. Connect generator's RF OUTPUT to analyzer's input after setting Signal Generator's controls as follows:

Meter Function . . . . .	LEVEL
COUNTER MODE: EXPAND . . . . .	Off
LOCK . . . . .	Off
Source . . . . .	INT
AM . . . . .	OFF
FM . . . . .	OFF
RANGE . . . . .	256 - 512 MHz
FREQUENCY TUNE . . . . .	256 MHz
OUTPUT LEVEL . . . . .	-7 dBm (Vernier full cw)
RF ON/OFF . . . . .	ON

2. Set spectrum analyzer's input attenuation to 20 dB. Adjust center frequency controls to center the 256 MHz signal on the display. Adjust scale reference level controls to set the signal to the top (0 dB) graticule line with the scale controls set to display 10 dB per division.

3. Set generator's AM switch to PULSE. The signal on the analyzer's display should decrease more than 40 dB.

40 dB \_\_\_\_\_

4. Repeat steps 1 through 3 with the RANGE switch set to each of its other positions. At each position, the signal on the analyzer's display should decrease more than 40 dB.

40 dB \_\_\_\_\_

PERFORMANCE TESTS

4-38. FM 3 dB BANDWIDTH TEST

SPECIFICATION:

FM 3 dB Bandwidth:  
 Internal and external AC; 20 Hz to 250 kHz.  
 External DC; dc to 250 kHz.

DESCRIPTION:

An audio spectrum analyzer is used to measure the 3 dB bandwidth. The analyzer is set to sweep over the specified audio frequency range and its tracking generator output is used to frequency modulate the Signal Generator. The generator's RF output is demodulated with an FM discriminator. The demodulated signal is fed to the analyzer's input and any amplitude variation is measured on the analyzer's display. Bandwidth is checked at maximum deviation on the 8 - 16 MHz band.

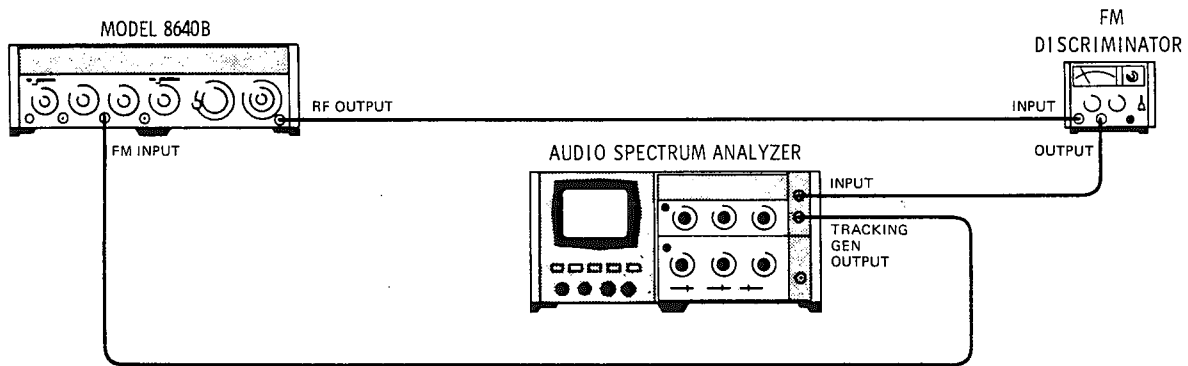

Figure 4-24. FM 3 dB Bandwidth Test Setup

EQUIPMENT:

Audio Spectrum Analyzer . . . . .	HP 141T/8552B/8556A
FM Discriminator . . . . .	HP 5210A
Filter Kit (For Discriminator) . . . . .	HP 10531A

PROCEDURE:

1. Connect equipment as shown in Figure 4-24 after setting Signal Generator's controls as follows:

Meter Function . . . . .	FM
COUNTER MODE: EXPAND . . . . .	Off
LOCK . . . . .	Off
Source . . . . .	INT

PERFORMANCE TESTS

4-38. FM 3 dB BANDWIDTH TEST (Cont'd)

AM	.....	OFF
FM	.....	OFF
PEAK DEVIATION	.....	80 kHz
PEAK DEVIATION Vernier	.....	Full cw
RANGE	.....	8 - 16 MHz
FREQUENCY TUNE	.....	8 MHz
OUTPUT LEVEL	.....	+13 dBm
RF ON/OFF	.....	ON

2. Prepare a 1 MHz Butterworth low-pass filter and install it in the discriminator. Set discriminator's range to 10 MHz and input sensitivity to 1V.
3. Set Signal Generator's FM switch to DC. Set spectrum analyzer's resolution bandwidth to 3 kHz and its center frequency controls to 1 kHz (with no sweep). Set analyzer's tracking generator output level for 80 kHz peak deviation as read on generator's panel meter. Set the analyzer's frequency controls for a 0 to 250 kHz sweep. Set the analyzer's display for 2 dB per division; adjust the display reference level controls to display the demodulated sweep.
4. Measure the sweep on the analyzer's display. Total amplitude variation from 20 Hz to 250 kHz should be <3 dB.

\_\_\_\_\_ 3 dB

NOTE

If the FM discriminator's incidental AM rejection is insufficient, the generator could appear to be out of specification. To check the discriminator, note analyzer's reading (in dBm), set generator's AM switch to AC and connect analyzer's tracking generator output to AM INPUT. Set MODULATION for 10% as read on panel meter. The analyzer should read >30 dB below the reading noted above. If it does not, adjust discriminator sensitivity and trigger level (or generator's OUTPUT LEVEL vernier) until it does. Then repeat steps 2 through 6.

4-39. FM DISTORTION TEST

SPECIFICATION:

- FM Distortion: (at 400 and 1000 Hz rates)
- <1% for deviations up to 1/8 maximum allowable.
  - <3% for maximum allowable deviation.

PERFORMANCE TESTS

4-39. FM DISTORTION TEST (Cont'd)

DESCRIPTION:

The Signal Generator is modulated with a 1 kHz signal. The generator's RF output is then demodulated with an FM discriminator and the distortion on the discriminator output is measured with a spectrum analyzer.

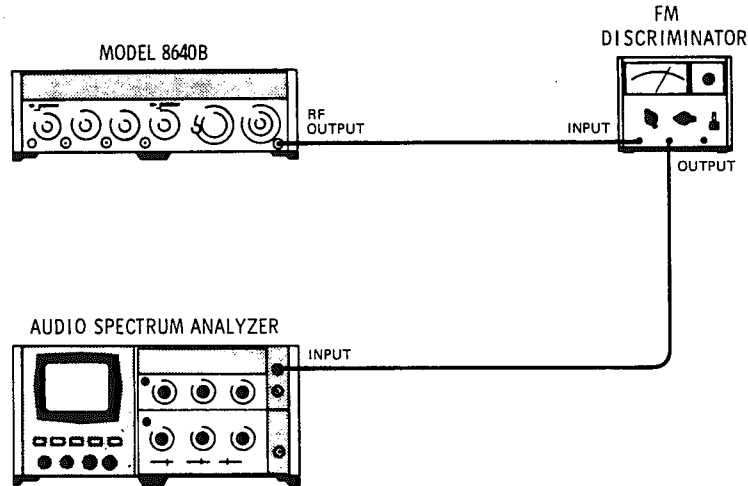

Figure 4-25. FM Distortion Test Setup

EQUIPMENT:

FM Discriminator	.....	HP 5210A
Filter Kit (For Discriminator)	.....	HP 10531A
Audio Spectrum Analyzer	.....	HP 141T/8552B/8556A

PROCEDURE:

1. Connect equipment as shown in Figure 4-25 after setting Signal Generator's controls as follows:

Meter Function	.....	FM
COUNTER MODE: EXPAND	.....	Off
LOCK	.....	Off
Source	.....	INT
AM	.....	OFF
MODULATION FREQUENCY	.....	1 kHz (Fixed)
FM	.....	INT
PEAK DEVIATION	.....	80 kHz
PEAK DEVIATION Vernier	.....	Full cw
RANGE	.....	8 - 16 MHz
FREQUENCY TUNE	.....	8 MHz
OUTPUT LEVEL	.....	+13 dBm (Vernier full cw)
RF ON/OFF	.....	ON



---

**PERFORMANCE TESTS**

---

**4-39. FM DISTORTION TEST (Cont'd)**

2. Using the filter kit, prepare a 1 MHz Butterworth low-pass filter and install it in the discriminator.
3. Set discriminator's range to 10 MHz and sensitivity to 1V.
4. Set spectrum analyzer's resolution bandwidth to 100 Hz and its center frequency controls for a 0 to 5 kHz span. Set the display for 10 dB per division.
5. Use generator's PEAK DEVIATION vernier to set 80 kHz of peak deviation (as read on panel meter). Use analyzer's display reference level controls to set the demodulated 1 kHz signal to the top (reference) graticule line on the display.
6. Note the level of the 1 kHz signal's harmonics (2 kHz, 3 kHz, etc.). For less than 3% distortion, they should be more than 30.5 dB below the reference graticule line.

Maximum Deviation: 30.5 dB \_\_\_\_\_

7. Set generator's PEAK DEVIATION switch to 10 kHz. If necessary, use generator's PEAK DEVIATION vernier to set 10 kHz of peak deviation; use analyzer's display reference level controls to set the demodulated 1 kHz signal to the reference graticule line.
8. For less than 1% distortion, the 1 kHz signal's harmonics should be more than 40 dB below the reference graticule line.

1/8 Maximum Deviation: 40 dB \_\_\_\_\_

---

**4-40. FM SENSITIVITY AND ACCURACY TEST**
**SPECIFICATION:**

External FM Sensitivity: 1 volt peak yields maximum deviation indicated on PEAK DEVIATION switch with FM vernier at full cw position.

External FM Sensitivity Accuracy:  $\pm 6\%$  from  $15^\circ$  to  $35^\circ\text{C}$  for FM excluding max peak deviation position. Maximum peak deviation position,  $\pm 9\%$  typically.

Indicated FM Accuracy: (400 Hz and 1 kHz rates using internal meter)  $\pm 10\%$  of meter reading (for greater than 10% of full scale).

**DESCRIPTION:**

The Signal Generator's FM sensitivity is checked using the carrier (Bessel) null technique. An externally applied 1 Vpk signal is used to FM the generator. The modulation signal's frequency is adjusted for the first order null of the carrier and the frequency is measured to find peak deviation. (For the first order null of the carrier, peak deviation equals 2.405 times the modulation rate.) The panel meter accuracy is found by comparing its reading to the given peak deviation. The reference generator and mixer convert the signal into the range of the spectrum analyzer.

---

PERFORMANCE TESTS

4-40. FM SENSITIVITY AND ACCURACY TEST (Cont'd)

NOTE

The ambient temperature must be within 15° to 35° C for this test.

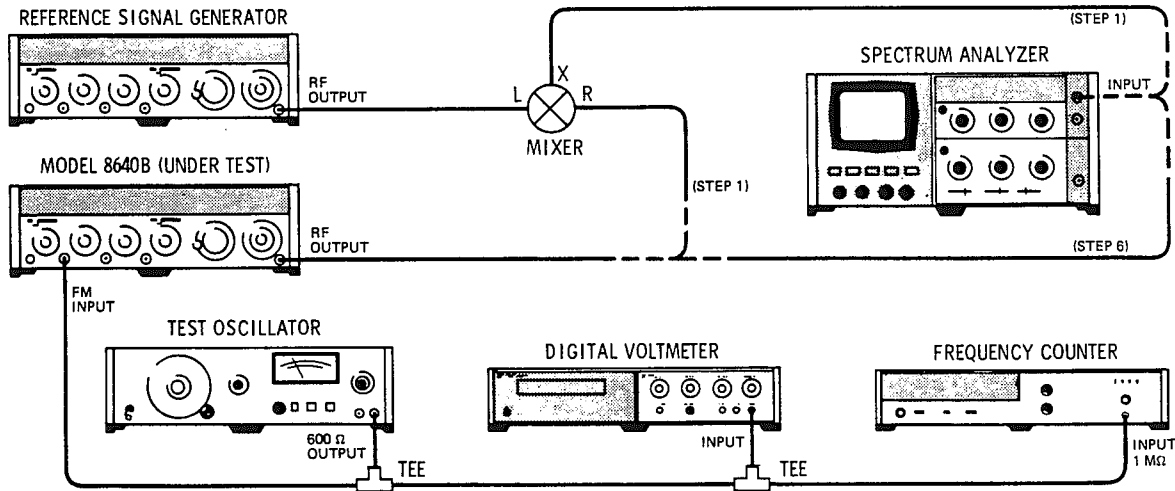

Figure 4-26. FM Sensitivity and Accuracy Test Setup

EQUIPMENT:

Test Oscillator	.....	HP 652A
Digital Voltmeter	.....	HP 3480B/3484A OPT 043
Frequency Counter	.....	HP 5327C
Spectrum Analyzer	.....	HP 141T/8552B/8553B
Reference Signal Generator	.....	HP 8640A
Mixer	.....	HP 10514A

NOTE

The reference signal generator should have frequency drift and residual FM specifications equivalent to the Model 8640A.

PROCEDURE:

1. Connect equipment as shown in Figure 4-26 (with test Signal Generator connected to mixer, and mixer connected to analyzer) after setting test generator's controls as follows:

Meter Function	.....	FM
COUNTER MODE: EXPAND	.....	Off
LOCK	.....	Off
Source	.....	INT

PERFORMANCE TESTS

4-40. FM SENSITIVITY AND ACCURACY TEST (Cont'd)

AM . . . . . OFF  
 FM . . . . . OFF  
 PEAK DEVIATION . . . . . 5 kHz  
 PEAK DEVIATION Vernier . . . . . Full cw  
 RANGE . . . . . 256 - 512 MHz  
 FREQUENCY TUNE . . . . . 512 MHz  
 OUTPUT LEVEL . . . . . -7 dBm  
 RF ON/OFF . . . . . ON

2. Set reference signal generator for a 513 MHz, CW signal at +13 dBm.
3. Set spectrum analyzer's center frequency controls to 1 MHz, input attenuation to 20 dB, resolution bandwidth to 0.1 kHz, span width per division (scan width) to 1 kHz, and set display to 10 dB per division. Set reference level controls to put peak of the signal at top (log reference) graticule line on the display.
4. To check external sensitivity, set test oscillator for a 0.7071 Vrms signal (read on DVM) at approximately 2.079 kHz. Set test generator's FM switch to AC and fine tune test oscillator's frequency for the first carrier null on analyzer's display (at least 50 dB below the top graticule line). With the frequency counter, measure frequency of modulating signal. It should be 2.079 kHz  $\pm$ 6% (i.e., 5 kHz  $\pm$ 6% peak deviation).

1.954 \_\_\_\_\_ 2.204 kHz

5. Use the procedures given above to check the remaining bands by setting the test Signal Generator's RANGE switch as shown below. As shown in steps 1 through 4, on each range set FM to OFF and tune the generators for a 1 MHz difference. Set the reference on the analyzer, set FM to AC (with a 0.7071 Vrms modulating signal at approximately 2.079 kHz) and tune the modulating signal's frequency for the first carrier null. The signal's frequency should be as shown.

RANGE (MHz)	FREQUENCY TUNE	Reference Generator Frequency	Mod. Signal Frequency (kHz)
128-256	256 MHz	257 MHz	1.954 _____ 2.204
64-128	128 MHz	129 MHz	1.954 _____ 2.204
32-64	64 MHz	65 MHz	1.954 _____ 2.204
16-32	32 MHz	33 MHz	1.954 _____ 2.204
8-16	16 MHz	17 MHz	1.954 _____ 2.204
4-8	8 MHz	9 MHz	1.954 _____ 2.204
2-4	4 MHz	5 MHz	1.954 _____ 2.204
1-2	2 MHz	3 MHz	1.954 _____ 2.204

**PERFORMANCE TESTS**

**4-40. FM SENSITIVITY AND ACCURACY TEST (Cont'd)**

6. To check indicated accuracy, set test Signal Generator's RANGE control to 256 - 512 MHz and FREQUENCY TUNE to 500 MHz. Set reference signal generator for a 501 MHz, CW signal at +13 dBm. Set test generator's FM switch to OFF and tune both generators for a 1 MHz signal at the top graticule line on the analyzer's display.
7. Set test signal Generator's FM switch to AC, set test oscillator's frequency for approximately 2.079 kHz, and adjust oscillator's amplitude controls for a reading of 5 (i.e., 5 kHz) on test generator's panel meter (0 - 5 scale). Tune oscillator's frequency for the first carrier null on the analyzer's display (at least 50 dB below the top graticule line). With frequency counter, measure frequency of modulating signal. It should be 2.079 kHz  $\pm$  10%.

1.871 \_\_\_\_\_ 2.287 kHz

8. Use procedures given in steps 6 and 7 to check indicated accuracy on the remaining bands by setting test generator's RANGE switch as shown below. On each range, set FM to OFF and tune generators for a 1 MHz difference. Set reference on analyzer, set FM to AC (with modulating signal's amplitude set for a test generator panel meter reading of 5 and its frequency set to approximately 2.079 kHz). Then tune modulating signal's frequency for first carrier null. The signal's frequency should be as shown.

RANGE (MHz)	FREQUENCY TUNE	Reference Generator Frequency	Mod. Signal Frequency (kHz)
128-256	256 MHz	257 MHz	1.871 _____ 2.287
64-128	128 MHz	129 MHz	1.871 _____ 2.287
32-64	64 MHz	65 MHz	1.871 _____ 2.287
16-32	32 MHz	33 MHz	1.871 _____ 2.287
8-16	16 MHz	17 MHz	1.871 _____ 2.287
4-8	8 MHz	9 MHz	1.871 _____ 2.287
2-4	4 MHz	5 MHz	1.871 _____ 2.287
1-2	2 MHz	3 MHz	1.871 _____ 2.287

9. Disconnect test Signal Generator and analyzer from mixer and connect test generator directly to analyzer. Set RANGE to 0.5 - 1 MHz, FREQUENCY TUNE to 1 MHz, FM to OFF, and reset reference on analyzer's display. Set FM to AC (with modulating signal's amplitude set for a test generator panel meter reading of 5 and its frequency set to approximately 2.079 kHz). Then tune the signal's frequency for the first carrier null. The signal's frequency should be 2.079 kHz  $\pm$  10%.

1.871 \_\_\_\_\_ 2.287 kHz

PERFORMANCE TESTS

4-41. INCIDENTAL AM TEST

SPECIFICATION:

Incidental AM: (at 400 Hz and 1 kHz rates)  
 <0.5% AM for FM up to 1/8 max. allowable deviation.  
 <1% AM for FM at max. allowable deviation.

DESCRIPTION:

An audio signal is used to amplitude modulate the Signal Generator. The resulting modulated RF is detected and used to calibrate an oscilloscope. The generator is then frequency modulated and any incidental AM is measured with the oscilloscope.

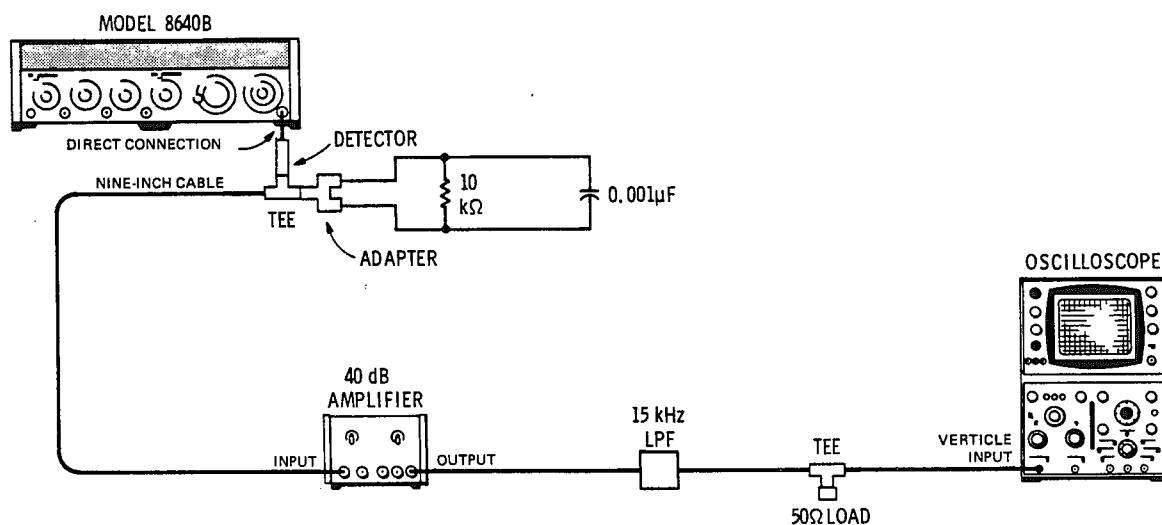

Figure 4-27. Incidental AM Test Setup

EQUIPMENT:

Crystal Detector . . . . .	HP 423A
15 kHz Low Pass Filter (LPF) . . . . .	CIR-Q-TEL 7 Pole
40 dB Amplifier . . . . .	HP 465A
Oscilloscope . . . . .	HP 180A/1801A/1820C
50 Ohm Load . . . . .	HP 11593A
Nine-Inch Cable . . . . .	HP 10502A
Adapter . . . . .	HP 10110A
0.001 μF Capacitor . . . . .	HP 0160-0153
10 kΩ Resistor . . . . .	HP 0757-0442

**PERFORMANCE TESTS**

---

**4-41. INCIDENTAL AM TEST (Cont'd)**

**PROCEDURE:**

1. Connect equipment as shown in Figure 4-27 (with network, adapter, tee, and detector connected as shown) after setting Signal Generator's controls as follows:

Meter Function	AM
COUNTER MODE: EXPAND	Off
LOCK	Off
Source	INT
AM	INT
MODULATION	Full ccw
MODULATION FREQUENCY	1 kHz
FM	OFF
PEAK DEVIATION	2.56 MHz
PEAK DEVIATION Vernier	Full cw
RANGE	256 - 512 MHz
FREQUENCY TUNE	256 MHz
OUTPUT LEVEL	+13 dBm (Vernier full cw)
RF ON/OFF	ON

2. Set MODULATION for 10% AM as read on panel meter.
3. Adjust oscilloscope's vertical gain controls so that the 1 kHz signal has 8 divisions of peak-to-peak deflection (i.e., 1.25% AM per division).
4. Set generator's AM switch to OFF and FM switch to INT. Set Meter Function to FM and set PEAK DEVIATION vernier for 2.56 MHz. Increase oscilloscope sensitivity by 10. Using generator's FREQUENCY TUNE control, tune across the band and record the maximum incidental AM read on the oscilloscope. It should be less than 1% (8 divisions peak-to-peak on the display).

Maximum Deviation: \_\_\_\_\_ 1%

5. Set PEAK DEVIATION switch to 320 kHz. Again, using the generator's FREQUENCY TUNE control, tune across the band. Incidental AM should be less than 0.5% (4 divisions peak-to-peak on the display).

1/8 Maximum Deviation: \_\_\_\_\_ 0.5%

**NOTE**

Incidental AM is usually worse case on the 256 - 512 MHz band. If desired, it can be checked on any other band using this test except that on the 0.5 to 16 MHz bands the capacitor across the resistor at the detector's output must be changed to 0.033  $\mu$ F (HP 0160-0163); on the 16 to 512 MHz bands, the 0.001  $\mu$ F capacitor (shown in the test setup) must be used.

PERFORMANCE TESTS

4-42. COUNTER EXTERNAL SENSITIVITY TEST

SPECIFICATION:

External RF Input:

Frequency Range: 1 Hz to 550 MHz

Sensitivity: 100 mVrms, ac only, into 50Ω (-7 dBm).

DESCRIPTION:

A test oscillator and the Signal Generator's own RF output are used to verify the counter's range and sensitivity.



Figure 4-28. Counter External Sensitivity Test Setup

EQUIPMENT:

Test Oscillator . . . . . HP 652A

PROCEDURE:

1. Connect RF OUTPUT to COUNTER INPUT as shown in Figure 4-28 after setting Signal Generator's controls as follows:

Meter Function . . . . .	LEVEL
COUNTER MODE: EXPAND . . . . .	Off
LOCK . . . . .	Off
Source . . . . .	INT
TIME BASE VERNIER . . . . .	CAL
AM . . . . .	OFF
FM . . . . .	OFF
RANGE . . . . .	256 - 512 MHz
FREQUENCY TUNE . . . . .	550 MHz
OUTPUT LEVEL . . . . .	100 mVOLTS
RF ON/OFF . . . . .	ON

**PERFORMANCE TESTS**

**4-42. COUNTER EXTERNAL SENSITIVITY TEST (Cont'd)**

2. Set COUNTER MODE Source to EXT 0 - 550. Slowly tune Signal Generator to 0.5 MHz using RANGE and FREQUENCY TUNE. The counter should indicate the frequency of the signal at R.F OUTPUT at all frequencies.

0.5 to 550 MHz \_\_\_\_\_ (✓)

3. Disconnect R.F OUTPUT from COUNTER INPUT. Connect the oscillator to COUNTER INPUT and set it for 500 kHz at 100 mVrms into 50 ohms. Slowly tune oscillator to 20 Hz. The counter should indicate the frequency of the signal from the test oscillator at all frequencies.

20 Hz to 500 kHz \_\_\_\_\_ (✓)

4. Set COUNTER MODE Source to EXT 0 - 10 and slowly tune oscillator from 20 Hz to 10 MHz. The counter should indicate the frequency of the signal from the test oscillator at all frequencies.

20 Hz to 10 MHz \_\_\_\_\_ (✓)

**4-43. INTERNAL REFERENCE ACCURACY TEST**

**SPECIFICATION:**

Accuracy: (after calibration at 25° C and 2-hour warm-up)  
 Better than ±1 ppm for 15° to 35° C.  
 Better than ±3 ppm for 0° to 55° C.

**DESCRIPTION:**

A frequency counter is used to measure the Signal Generator's counter accuracy. A temperature controlled chamber is used to set the temperature.

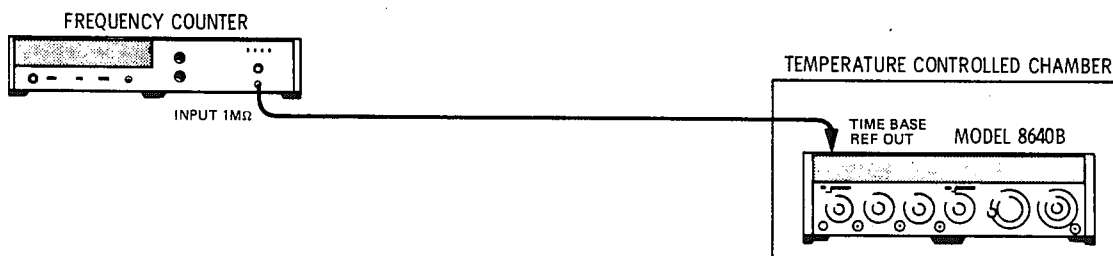

*Figure 4-29. Internal Reference Accuracy Test Setup*



**PERFORMANCE TESTS**

---

**4-43. INTERNAL REFERENCE ACCURACY TEST (Cont'd)**

**EQUIPMENT:**

Frequency Counter . . . . . HP 5327C OPT H49  
 Temperature Controlled Chamber . . . . . Statham Model 325

**PROCEDURE:**

1. Connect equipment as shown in Figure 4-29. Check that TIME BASE REF INT/EXT switch on the rear panel is set to INT.
2. Set chamber for various temperatures between 15° and 35° C. At each temperature, allow generator to stabilize for two hours, then measure the frequency. It should be 5 MHz ± 5 Hz.

4,999,995 \_\_\_\_\_ 5,000,005 Hz

3. Set the chamber for various temperatures between 0° and 55° C. Again, allow the generator to stabilize for two hours at each temperature and measure the frequency. It should be 5 MHz ± 15 Hz.

4,999,985 \_\_\_\_\_ 5,000,015 Hz

---

**4-44. INTERNAL REFERENCE DRIFT RATE (STABILITY) TEST**

**SPECIFICATION:**

Drift Rate: (after 2-hour warm-up)

Time: <0.05 ppm per hr., <2 ppm per yr.

Temperature: <2 ppm total variation for room ambient 15° to 35° C.

Line Voltage: <0.1 ppm.

**NOTE**

Because the phase lock mode references the generator's RF oscillator to the counter's frequency reference, the following frequency specifications are also checked in this test.

Frequency Stability (phase lock mode):

Time: <0.05 ppm/hr.

Temperature: <2 ppm total variation (room ambient 15° to 35° C).

Line Voltage (+5% to -10% change): <0.1 ppm.

Load (with any passive load change): None measurable.

Level Change (10 dB on output level vernier): None measurable.

Mode Change (CW to FM): None measurable.

PERFORMANCE TESTS

4-44. INTERNAL REFERENCE DRIFT RATE (STABILITY) TEST (Cont'd)

DESCRIPTION:

After a two-hour warm-up period, the internal reference is measured with a frequency counter, a digital to analog converter, and a strip-chart recorder; frequency variations are noted as the specified changes are made. A quartz oscillator is used as a time standard when measuring drift as a function of time and line voltage change.

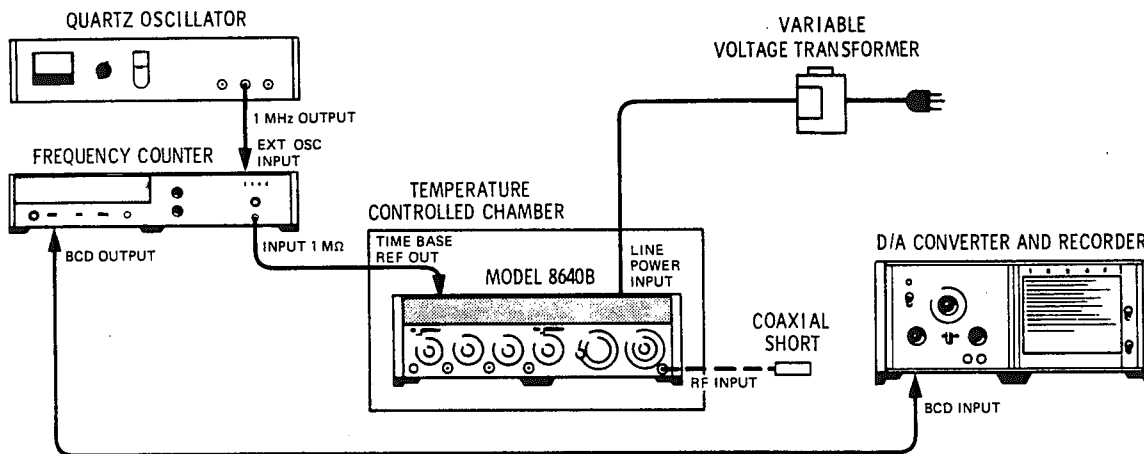

Figure 4-30. Internal Reference Drift Rate (Stability) Test Setup

EQUIPMENT:

Frequency Counter	HP 5327C OPT 003
Temperature Controlled Chamber	Statham Model 325
Variable Voltage Transformer	GR W5MT3A
Coaxial Short (Type N Male)	HP 11512A
Quartz Oscillator	HP 105B
Digital to Analog Converter	HP 581A OPT 002
Recorder (for D/A Converter)	HP 680

PROCEDURE:

1. Connect equipment as shown in Figure 4-30 after setting Signal Generator's controls as follows:

TIME BASE REF INT/EXT (on rear panel)	INT
COUNTER MODE: LOCK	Off
AM	OFF
FM	OFF

PERFORMANCE TESTS

---

4-44. INTERNAL REFERENCE DRIFT RATE (STABILITY) TEST (Cont'd)

PEAK DEVIATION . . . . . 5 kHz  
 PEAK DEVIATION Vernier . . . . . Full cw  
 RANGE . . . . . 0.5 - 1 MHz  
 OUTPUT LEVEL . . . . . +19 dBm  
 RF ON/OFF . . . . . ON

2. Set variable voltage transformer to nominal voltage set on generator's line power module (i.e., 100, 120, 220, or 240 Vac). Set temperature controlled chamber for 25°C. Allow equipment to warm up for two hours.
3. Set frequency counter so that it's using its internal reference oscillator. Set counter to read frequency directly (i.e., not divided down). Use a 1s gate time so that last three digits span from 000 to 999 Hz.
4. Calibrate the recorder for a zero to full-scale reading that corresponds to a 000 to 999 Hz reading of the frequency counter's last three digits.
5. To check drift rate as a function of time and line voltage, now set counter so that it's using the quartz oscillator. Set the counter's time base control for a 10s gate time.

NOTE

The above procedure sets the counter's actual gate time to 100s because the reference being used is 1 MHz instead of the 10 MHz reference the counter normally uses. This means that the counter's reading must be divided by 10 to find the actual frequency of the signal being measured (i.e., the recorder's calibration is 0.00 to 9.99 Hz full scale).

6. Record the generator's internal reference frequency for one hour. The frequency change in one hour should be <0.27 Hz (<0.05 ppm ±1 digit counter ambiguity).

Time: \_\_\_\_\_ 0.27 Hz

NOTE

Any change in line voltage or chamber temperature could make the instrument's drift rate vs time appear to be out of specification.

7. Set variable voltage transformer 5% above the nominal voltage set on generator's line power module (e.g., if nominal line voltage is 120 Vac, set transformer for 126 Vac). Then note the frequency (the counter's indication must be divided by 10).
8. Set variable voltage transformer 10% below nominal line voltage (e.g., for a nominal 120 Vac, set transformer for 108 Vac), then note the reference frequency. The frequency change from the reading noted in step 7 should be <0.52 Hz (< 0.1 ppm ±1 digit counter ambiguity).

Voltage: \_\_\_\_\_ 0.52 Hz

---

**PERFORMANCE TESTS**

---

**4-44. INTERNAL REFERENCE DRIFT RATE (STABILITY) TEST (Cont'd)****NOTE**

Any change in chamber temperature could make the instrument's drift rate vs voltage appear out of specification.

9. Reset transformer to nominal line voltage. Set temperature controlled chamber to 15°C. Wait two hours to allow generator's internal reference to stabilize, then note its frequency.
10. Set temperature controlled chamber to 35°C. Wait two hours, then note the reference frequency. The frequency change from the reading noted in step 9 should be <10.2 Hz (i.e., <2 ppm  $\pm$ 1 digit counter ambiguity).

Temperature: \_\_\_\_\_ 10.2 Hz

11. Note generator's internal reference frequency, connect coaxial short to RF OUTPUT, then again note reference frequency. Except for the  $\pm$ 1 digit count ambiguity, it should not have changed.

Load: \_\_\_\_\_ (✓) No Change

12. Remove coaxial short. Note internal reference frequency, set OUTPUT LEVEL switch one step ccw to +9 dBm, then again note reference frequency. Except for the  $\pm$ 1 digit count ambiguity, it should not have changed.

Level Change: \_\_\_\_\_ (✓) No Change

13. Note internal reference frequency, set FM switch to AC, then again note reference frequency. Except for the  $\pm$ 1 digit count ambiguity, it should not have changed.

Mode Change: \_\_\_\_\_ (✓) No Change

---

**4-45. PHASE LOCK RESTABILIZATION TIME TEST**
**SPECIFICATION:**

Restabilization Time (phase locked mode): After frequency or band change, or after 1 min. in RF OFF mode; <1 min. after relocking to be within 0.1 ppm of steady-state frequency.

**DESCRIPTION:**

A frequency counter, digital to analog converter, and strip-chart recorder are used to measure stability after relocking.

PERFORMANCE TESTS

4-45. PHASE LOCK RESTABILIZATION TIME TEST (Cont'd)

NOTE

For these tests, ambient room temperature and line voltage should not change.

EQUIPMENT:

Frequency Counter . . . . .	HP 5327C OPT 003
Digital to Analog Converter . . . . .	HP 581A OPT 002
Recorder (for D/A Converter) . . . . .	HP 680

PROCEDURE:

1. Connect equipment as shown in Figure 4-1 after setting Signal Generator's control as follows:

COUNTER MODE: EXPAND . . . . .	Off
LOCK . . . . .	Off
Source . . . . .	INT
AM . . . . .	OFF
FM . . . . .	OFF
RANGE . . . . .	32 - 64 MHz
FREQUENCY TUNE . . . . .	50 MHz
RF ON/OFF . . . . .	ON

2. Warm up equipment for two hours. Then set frequency counter to read frequency directly (i.e., not divided down). Use a 1s gate time so that the last two digits span from 00 to 99 Hz.
 

\_\_\_\_\_ 7 Hz
3. Calibrate the recorder for a zero to full-scale reading that corresponds to a 00 to 99 Hz reading of the frequency counter's last two digits (i.e., 100 Hz full scale).
4. Set COUNTER MODE LOCK to ON, wait one minute, then record generator's output frequency for five minutes; the frequency should not vary more than 7 Hz (<0.1 ppm ±1 digit counter ambiguity).
 

\_\_\_\_\_ 7 Hz
5. Set COUNTER MODE LOCK to Off; tune FREQUENCY TUNE control fully ccw and back again to approximately 50 MHz. Repeat step 4; frequency should not vary more than 7 Hz.
 

\_\_\_\_\_ 7 Hz
6. Set COUNTER MODE LOCK to Off; set RANGE switch to 64 - 128 MHz and back again to 32 - 64 MHz. Repeat step 4; frequency should not vary more than 7 Hz.
 

\_\_\_\_\_ 7 Hz
7. Set COUNTER MODE LOCK to Off; set RF ON/OFF switch to OFF. Wait one minute and set RF ON/OFF switch to ON. Repeat step 4; frequency should not vary more than 7 Hz.
 

\_\_\_\_\_ 7 Hz

Table 4-1. Performance Test Record (1 of 8)

Hewlett-Packard Model 8640B Signal Generator Serial No. _____				
Tested By _____ Date _____				
Para No.	Test Description	Results		
		Min	Actual	Max
4-11.	<b>Frequency Range Test</b>			
	High End of Band:	512-1024 MHz	550.0 MHz	_____
		256-512 MHz	550.0 MHz	_____
		128-256 MHz	275.0 MHz	_____
		64-128 MHz	137.5 MHz	_____
		32-64 MHz	68.70 MHz	_____
		16-32 MHz	34.30 MHz	_____
		8-16 MHz	17.10 MHz	_____
		4-8 MHz	8.500 MHz	_____
		2-4 MHz	4.200 MHz	_____
		1-2 MHz	2.100 MHz	_____
		0.5-1MHz	1.070 MHz	_____
	Low End of Band:	512-1024 MHz		230.0 MHz
		256-512 MHz		230.0 MHz
		128-256 MHz		115.0 MHz
		64-128 MHz		57.50 MHz
		32-64 MHz		28.80 MHz
	16-32 MHz		14.40 MHz	
	8-16 MHz		7.200 MHz	
	4-8 MHz		3.600 MHz	
	2-4 MHz		1.800 MHz	
	1-2 MHz		0.900 MHz	
	0.5-1 MHz		0.450 MHz	
4-12.	<b>Frequency Accuracy and Fine Tune Test</b>			
	Counter Readings, Difference:			110 Hz
	X10			110 Hz
	TIME BASE VERN, not-CAL, cw	1 kHz		
	TIME BASE VERN, not-CAL, ccw	1 kHz		
	FINE TUNE	10 kHz		
4-13.	<b>Frequency Stability vs Time and Restabilization Time Test</b>			
	Time			500 Hz
	After frequency change			500 Hz
	After band change			250 Hz
	After RF ON/OFF set to ON			500 Hz

Table 4-1. Performance Test Record (2 of 8)

Para No.	Test Description	Results		
		Min	Actual	Max
4-14.	Frequency Stability vs Temperature Test		_____	50 kHz
4-15.	Frequency Stability vs Line Voltage Test +5% to -10% Line Voltage		_____	50 Hz
4-16.	Frequency Stability Test (Load) (Level) (Mode): 10 kHz 20 kHz 40 kHz 80 kHz 160 kHz 320 kHz 640 kHz 1.28 MHz 2.56 MHz		_____ _____ _____ _____ _____ _____ _____ _____ _____ _____	50 Hz 50 Hz 200 Hz 200 Hz 400 Hz 800 Hz 1.6 kHz 3.2 kHz 6.4 kHz 12.8 kHz 25.6 kHz
4-17.	Harmonics Test Frequency Range: 0.5-1 MHz 1-2 MHz 2-4 MHz 4-8 MHz 8-16 MHz 16-32 MHz 32-64 MHz 64-128 MHz 128-256 MHz 256-512 MHz	35 dB 35 dB 35 dB 35 dB 35 dB 35 dB 35 dB 35 dB 30 dB 30 dB	_____ _____ _____ _____ _____ _____ _____ _____ _____ _____	
4-18.	Sub-Harmonics and Non-Harmonic Spurious Test Below carrier	100 dB	_____	
4-19.	Single Sideband Phase Noise Test At 550 MHz >112 dB down At 450 MHz >120 dB down	12 dB 20 dB	_____ _____	
4-20.	Single Sideband Broadband Noise Floor Test >140 dB down	30 dB	_____	

Table 4-1. Performance Test Record (3 of 8)

Para No.	Test Description	Results																																																																																																																
		Min	Actual	Max																																																																																																														
4-21.	<b>Residual AM Test</b> >78 dB down >85 dB down	58 dB 65 dB	_____ _____																																																																																																															
4-22.	<b>Residual FM Test</b> <7.5 Hz <2.5 Hz <7.5 Hz <15 Hz	7.5 mVrms 2.5 mVrms 7.5 mVrms 15 mVrms	_____ _____ _____ _____																																																																																																															
4-23.	<b>Output Level Accuracy Test (Abbreviated)</b> <table style="width: 100%; border-collapse: collapse;"> <tr> <td style="width: 30%;">Output Level</td> <td style="width: 20%;">Meter Reading</td> <td></td> <td></td> <td></td> </tr> <tr> <td>Full cw</td> <td>+19 dBm</td> <td>+17.5 dBm</td> <td>_____</td> <td>+20.5 dBm</td> </tr> <tr> <td>Full cw</td> <td>+13 dBm</td> <td>+11.5 dBm</td> <td>_____</td> <td>+14.5 dBm</td> </tr> <tr> <td>Full cw</td> <td>+5 dBm</td> <td>+3.0 dBm</td> <td>_____</td> <td>+7.0 dBm</td> </tr> <tr> <td>1 step ccw</td> <td>+13 dBm</td> <td>+11.5 dBm</td> <td>_____</td> <td>+14.5 dBm</td> </tr> <tr> <td>1 step ccw</td> <td>+8 dBm</td> <td>+6.5 dBm</td> <td>_____</td> <td>+9.5 dBm</td> </tr> <tr> <td>1 step ccw</td> <td>+3 dBm</td> <td>+1.5 dBm</td> <td>_____</td> <td>+4.5 dBm</td> </tr> <tr> <td>1 step ccw</td> <td>-5 dBm</td> <td>-7.0 dBm</td> <td>_____</td> <td>-3.0 dBm</td> </tr> <tr> <td>2 steps ccw</td> <td>+3 dBm</td> <td>+1.5 dBm</td> <td>_____</td> <td>+4.5 dBm</td> </tr> <tr> <td>3 steps ccw</td> <td>-7 dBm</td> <td>-8.5 dB</td> <td>_____</td> <td>-5.5 dB</td> </tr> <tr> <td>4 steps ccw</td> <td>-17 dBm</td> <td>-2.0 dB</td> <td>_____</td> <td>+2.0 dB</td> </tr> <tr> <td>5 steps ccw</td> <td>-27 dBm</td> <td>-2.0 dB</td> <td>_____</td> <td>+2.0 dB</td> </tr> <tr> <td>6 steps ccw</td> <td>-37 dBm</td> <td>-2.0 dB</td> <td>_____</td> <td>+2.0 dB</td> </tr> <tr> <td>7 steps ccw</td> <td>-47 dBm</td> <td>-2.5 dB</td> <td>_____</td> <td>+2.5 dB</td> </tr> <tr> <td>8 steps ccw</td> <td>-57 dBm</td> <td>-2.5 dB</td> <td>_____</td> <td>+2.5 dB</td> </tr> <tr> <td>9 steps ccw</td> <td>-67 dBm</td> <td>-2.5 dB</td> <td>_____</td> <td>+2.5 dB</td> </tr> <tr> <td>10 steps ccw</td> <td>-77 dBm</td> <td>-2.5 dB</td> <td>_____</td> <td>+2.5 dB</td> </tr> <tr> <td>11 steps ccw</td> <td>-87 dBm</td> <td>-2.5 dB</td> <td>_____</td> <td>+2.5 dB</td> </tr> <tr> <td>12 steps ccw</td> <td>-97 dBm</td> <td>-2.5 dB</td> <td>_____</td> <td>+2.5 dB</td> </tr> <tr> <td>13 steps ccw</td> <td>-107 dBm</td> <td>-3.0 dB</td> <td>_____</td> <td>+3.0 dB</td> </tr> <tr> <td>14 steps ccw</td> <td>-117 dBm</td> <td>-3.0 dB</td> <td>_____</td> <td>+3.0 dB</td> </tr> <tr> <td></td> <td>-127 dBm</td> <td>-23 dB</td> <td>_____</td> <td>-17 dB</td> </tr> </table>	Output Level	Meter Reading				Full cw	+19 dBm	+17.5 dBm	_____	+20.5 dBm	Full cw	+13 dBm	+11.5 dBm	_____	+14.5 dBm	Full cw	+5 dBm	+3.0 dBm	_____	+7.0 dBm	1 step ccw	+13 dBm	+11.5 dBm	_____	+14.5 dBm	1 step ccw	+8 dBm	+6.5 dBm	_____	+9.5 dBm	1 step ccw	+3 dBm	+1.5 dBm	_____	+4.5 dBm	1 step ccw	-5 dBm	-7.0 dBm	_____	-3.0 dBm	2 steps ccw	+3 dBm	+1.5 dBm	_____	+4.5 dBm	3 steps ccw	-7 dBm	-8.5 dB	_____	-5.5 dB	4 steps ccw	-17 dBm	-2.0 dB	_____	+2.0 dB	5 steps ccw	-27 dBm	-2.0 dB	_____	+2.0 dB	6 steps ccw	-37 dBm	-2.0 dB	_____	+2.0 dB	7 steps ccw	-47 dBm	-2.5 dB	_____	+2.5 dB	8 steps ccw	-57 dBm	-2.5 dB	_____	+2.5 dB	9 steps ccw	-67 dBm	-2.5 dB	_____	+2.5 dB	10 steps ccw	-77 dBm	-2.5 dB	_____	+2.5 dB	11 steps ccw	-87 dBm	-2.5 dB	_____	+2.5 dB	12 steps ccw	-97 dBm	-2.5 dB	_____	+2.5 dB	13 steps ccw	-107 dBm	-3.0 dB	_____	+3.0 dB	14 steps ccw	-117 dBm	-3.0 dB	_____	+3.0 dB		-127 dBm	-23 dB	_____	-17 dB			
Output Level	Meter Reading																																																																																																																	
Full cw	+19 dBm	+17.5 dBm	_____	+20.5 dBm																																																																																																														
Full cw	+13 dBm	+11.5 dBm	_____	+14.5 dBm																																																																																																														
Full cw	+5 dBm	+3.0 dBm	_____	+7.0 dBm																																																																																																														
1 step ccw	+13 dBm	+11.5 dBm	_____	+14.5 dBm																																																																																																														
1 step ccw	+8 dBm	+6.5 dBm	_____	+9.5 dBm																																																																																																														
1 step ccw	+3 dBm	+1.5 dBm	_____	+4.5 dBm																																																																																																														
1 step ccw	-5 dBm	-7.0 dBm	_____	-3.0 dBm																																																																																																														
2 steps ccw	+3 dBm	+1.5 dBm	_____	+4.5 dBm																																																																																																														
3 steps ccw	-7 dBm	-8.5 dB	_____	-5.5 dB																																																																																																														
4 steps ccw	-17 dBm	-2.0 dB	_____	+2.0 dB																																																																																																														
5 steps ccw	-27 dBm	-2.0 dB	_____	+2.0 dB																																																																																																														
6 steps ccw	-37 dBm	-2.0 dB	_____	+2.0 dB																																																																																																														
7 steps ccw	-47 dBm	-2.5 dB	_____	+2.5 dB																																																																																																														
8 steps ccw	-57 dBm	-2.5 dB	_____	+2.5 dB																																																																																																														
9 steps ccw	-67 dBm	-2.5 dB	_____	+2.5 dB																																																																																																														
10 steps ccw	-77 dBm	-2.5 dB	_____	+2.5 dB																																																																																																														
11 steps ccw	-87 dBm	-2.5 dB	_____	+2.5 dB																																																																																																														
12 steps ccw	-97 dBm	-2.5 dB	_____	+2.5 dB																																																																																																														
13 steps ccw	-107 dBm	-3.0 dB	_____	+3.0 dB																																																																																																														
14 steps ccw	-117 dBm	-3.0 dB	_____	+3.0 dB																																																																																																														
	-127 dBm	-23 dB	_____	-17 dB																																																																																																														
4-24.	<b>Output Level Accuracy Test (Complete)</b> <table style="width: 100%; border-collapse: collapse;"> <tr> <td style="width: 30%;">Output Level</td> <td style="width: 20%;">Meter Reading</td> <td></td> <td></td> <td></td> </tr> <tr> <td>Full cw</td> <td>+19 dBm</td> <td>+17.5 dBm</td> <td>_____</td> <td>+20.5 dBm</td> </tr> <tr> <td>Full cw</td> <td>+13 dBm</td> <td>+11.5 dBm</td> <td>_____</td> <td>+14.5 dBm</td> </tr> <tr> <td>Full cw</td> <td>+5 dBm</td> <td>+3.0 dBm</td> <td>_____</td> <td>+7.0 dBm</td> </tr> </table>	Output Level	Meter Reading				Full cw	+19 dBm	+17.5 dBm	_____	+20.5 dBm	Full cw	+13 dBm	+11.5 dBm	_____	+14.5 dBm	Full cw	+5 dBm	+3.0 dBm	_____	+7.0 dBm																																																																																													
Output Level	Meter Reading																																																																																																																	
Full cw	+19 dBm	+17.5 dBm	_____	+20.5 dBm																																																																																																														
Full cw	+13 dBm	+11.5 dBm	_____	+14.5 dBm																																																																																																														
Full cw	+5 dBm	+3.0 dBm	_____	+7.0 dBm																																																																																																														



Table 4-1. Performance Test Record (4 of 8)

Para No.	Test Description	Results			
		Min	Actual	Max	
4-24.	<b>Output Level Accuracy Test (Complete) (Cont'd)</b>				
	Output Level      Meter Reading				
	1 step ccw      +13 dBm	+11.5 dBm	_____	+14.5 dBm	
	1 step ccw      +8 dBm	+6.5 dBm	_____	+9.5 dBm	
	1 step ccw      +3 dBm	+1.5 dBm	_____	+4.5 dBm	
	1 step ccw      -5 dBm	-7.0 dBm	_____	-3.0 dBm	
	2 steps ccw      +3 dBm	+1.5 dBm	_____	+4.5 dBm	
	3 steps ccw      -7 dBm	-8.5 dBm	_____	-5.5 dBm	
		-17 dBm	-472.0 mVdc	_____	-529.6 mVdc
		-27 dBm	-472.0 mVdc	_____	-529.6 mVdc
		-37 dBm	-472.0 mVdc	_____	-529.6 mVdc
		-47 dBm	-472.0 mVdc	_____	-529.6 mVdc
		-57 dBm	-445.6 mVdc	_____	-561.0 mVdc
		-67 dBm	-445.6 mVdc	_____	-561.0 mVdc
		-77 dBm	-445.6 mVdc	_____	-561.0 mVdc
		-87 dBm	-445.6 mVdc	_____	-561.0 mVdc
		-107 dBm	-445.6 mVdc	_____	-561.0 mVdc
		-117 dBm	-445.6 mVdc	_____	-561.0 mVdc
		-127 dBm	-445.6 mVdc	_____	-561.0 mVdc
		-137 dBm	-445.6 mVdc	_____	-561.0 mVdc
	0.013 $\mu$ V (-144.75 dBm)	-546.9 mVdc	_____	-772.5 mVdc	
4-25.	<b>Output Level Flatness Test</b>		_____	0.5 dB	
4-26.	<b>Output Impedance Test (In Band)</b>		_____ _____ _____	100 mV 13 mV 6.5 mV	
4-27.	<b>Output Impedance Test (Out of Band)</b>				
	VSWR <2.0:1	9.8 dB	_____		
	Return Loss	9.8 dB	_____		
	VSWR <1.3:1	18.3 dB	_____		
	Return Loss	18.3 dB	_____		
4-28.	<b>Auxiliary Output Test</b>	-5 dBm	_____		





Table 4-1. Performance Test Record (7 of 8)

Para No.	Test Description	Results		
		Min	Actual	Max
4-38.	FM 3 dB Bandwidth Test		_____	3 dB
4-39.	FM Distortion Test Maximum Deviation 1/8 Maximum Deviation	30.5 dB 40 dB	_____ _____	
4-40.	FM Sensitivity and Accuracy Test Sensitivity: Frequency Range 256-512 MHz 128-256 MHz 64-128 MHz 32-64 MHz 16-32 MHz 8-16 MHz 4-8 MHz 2-4 MHz 1-2 MHz 0.5-1 MHz  Accuracy: Frequency Range 256-512 MHz 128-256 MHz 64-128 MHz 32-64 MHz 16-32 MHz 8-16 MHz 4-8 MHz 2-4 MHz 1-2 MHz 0.5-1 MHz	1.954 kHz 1.954 kHz 1.954 kHz 1.954 kHz 1.954 kHz 1.954 kHz 1.954 kHz 1.954 kHz 1.954 kHz 1.954 kHz 1.954 kHz  1.871 kHz 1.871 kHz 1.871 kHz 1.871 kHz 1.871 kHz 1.871 kHz 1.871 kHz 1.871 kHz 1.871 kHz 1.871 kHz	_____ _____ _____ _____ _____ _____ _____ _____ _____ _____ _____  _____ _____ _____ _____ _____ _____ _____ _____ _____ _____	2.204 kHz 2.204 kHz 2.204 kHz 2.204 kHz 2.204 kHz 2.204 kHz 2.204 kHz 2.204 kHz 2.204 kHz 2.204 kHz 2.204 kHz  2.287 kHz 2.287 kHz 2.287 kHz 2.287 kHz 2.287 kHz 2.287 kHz 2.287 kHz 2.287 kHz 2.287 kHz 2.287 kHz
4-41.	Incidental AM Test Maximum Deviation 1/8 Maximum Deviation		_____ _____	1% 0.5%
4-42.	Counter External Sensitivity Test 0.5 to 550 MHz 20 Hz to 500 kHz 20 Hz to 10 MHz		_____ _____ _____	(√) (√) (√)
4-43.	Internal Reference Accuracy Test 15°C to 35°C 0°C to 55°C	4,999,995 Hz 4,999,985 Hz	_____ _____	5,000,005 Hz 5,000,015 Hz

Table 4-1. Performance Test Record (8 of 8)

Para No.	Test Description	Results		
		Min	Actual	Max
4-44.	<b>Internal Reference Drift Rate (Stability) Test</b>			
	Time		_____	0.27 Hz
	Voltage		_____	0.52 Hz
	Temperature		_____	10.2 Hz
	Load		_____	(√) No Change
	Level Change		_____	(√) No Change
	Mode Change		_____	(√) No Change
4-45.	<b>Phase Lock Restabilization Time Test</b>			
	After two hour warm-up		_____	7 Hz
	After frequency change		_____	7 Hz
	After band change		_____	7 Hz
	After 1 min. in RF OFF mode		_____	7 Hz

Table 4-2. Recommended Test Abridgements (1 of 3)

Para. No.	Performance Test	Alteration	Remark
4-11.	Frequency Range Test	Check only 0.5 - 1 MHz Range.	Ranges obtained by binary division of 230 - 550 MHz RF oscillator. All dividers operate on 0.5 - 1 MHz Range.
4-12.	Frequency Accuracy and Fine Tune Test	Omit steps 5 to 8.	Fine tune of secondary importance.
4-13.	Frequency Stability vs Time and Restabilization Time Test	Omit steps 5 to 7.	Restabilization time of secondary importance.
4-14.	Frequency Stability vs Temperature Test	Omit test.	Drift is small in a normal lab environment.
4-15.	Frequency Stability vs Line Voltage Test	Omit test.	Frequency shifts are small in a normal lab environment.
4-16.	Frequency Stability vs Load, Level, and Mode Test	Omit test.	RF oscillator well buffered from external loading. FM offset null constant under normal lab environment.
4-17.	Harmonics Test	None	
4-18.	Sub-harmonics and Non-harmonic Spurious Test	Omit test.	No mechanism for generation of spurious signals except counter, which is heavily shielded and filtered.
4-19.	Single Sideband Phase Noise Test	None	
4-20.	Single Sideband Broad-band Noise Floor Test	None	
4-21.	Residual AM Test	Omit step 4.	Normally within specification for 300 Hz to 3 kHz bandwidth if within specification for 20 Hz to 20 kHz bandwidth.
4-22.	Residual FM Test	Omit steps 6 and 7.	Normally within specification for 300 Hz to 3 kHz bandwidth if within specification for 20 Hz to 20 kHz bandwidth.
4-23.	Output Level Accuracy Test (Abbreviated)	None	
4-24.	Output Level Accuracy Test (Complete)	Omit test.	Most useful ranges checked by abbreviated test.
4-25.	Output Level Flatness Test	None	
4-26.	Output Impedance Test (In Band)	Omit one test.	A condition that is out of specification will usually show on both tests.
4-27.	Output Impedance Test (Out of Band)		

Table 4-2. Recommended Test Abridgements (2 of 3)

Para. No.	Performance Test	Alteration	Remark
4-28.	Auxiliary Output Test	Omit test.	Auxiliary output a secondary function.
4-29.	Output Leakage Test	Omit step 5, and use 400 MHz amplifier to check to 512 MHz in step 4.	The 400 MHz amplifier bandwidth is adequate to check leakage over the output range of 0.5 to 512 MHz.
4-30.	Internal Modulation Oscillator Test	Omit test.	Exactness of modulation frequency not critical for most applications.
4-31.	Internal Modulation Oscillator Distortion Test (Opt 001)	Omit test.	Excessive distortion will usually manifest itself in AM and FM distortion tests.
4-32.	AM 3 dB Bandwidth Test	Omit test.	Accuracy at most often used frequencies check in AM sensitivity test.
4-33.	AM Distortion Test	None	
4-34.	AM Sensitivity and Accuracy Test	Omit step 8, but check meter in steps 1 to 7.	A spot check of meter accuracy is usually adequate.
4-35.	Peak Incidental Phase Modulation Test	Omit test.	Test requires access to inside of instrument. Specification does not normally degrade with time.
4-36.	Pulse Modulation Test	Omit steps 7 to 9.	Performance usually improves at the higher frequencies.
4-37.	Pulse On/Off Ratio Test	Omit step 4.	Performance usually improves at the lower frequencies.
4-38.	FM 3 dB Bandwidth Test	Omit test.	Accuracy at most often used frequencies checked in FM Sensitivity test.
4-39.	FM Distortion Test	None.	
4-40.	FM Sensitivity and Accuracy Test	Omit steps 6 to 9, but check meter in steps 1 to 5.	A spot check of meter accuracy is usually adequate.
4-41.	Incidental AM Test	Omit test.	Incidental AM usually of secondary importance and FM sensitivity test will usually show conditions that are out of specification (i.e., the first order sidebands will be uneven).

Table 4-2. Recommended Test Abridgements (3 of 3)

Para. No.	Performance Test	Alteration	Remark
4-42.	Counter External Sensitivity Test	Omit steps 3 and 4.	Performance usually improves at lower frequencies.
4-43.	Internal Reference Accuracy Test	None	
4-44.	Internal Reference Drift Rate (Stability) Test	Omit test.	Drift is small in a normal lab environment.
4-45.	Phase Lock Restabilization Time Test	Omit test.	Frequency error during the short lock acquisition time usually not significant.





## SECTION V ADJUSTMENTS

### 5-1. INTRODUCTION

5-2. This section describes adjustments required to return the Model 8640B Signal Generator to peak operating condition when repairs are required. Included in this section are test setups, and check and adjustment procedures. Removal and replacement procedures are given on the alphabetic service sheets (after the schematics in Section VIII). Adjustment location photographs are given on the last foldout in Section VIII.

### 5-3. SAFETY CONSIDERATIONS

5-4. Although this instrument has been designed in accordance with international safety standards, this manual contains information and warnings which must be followed to ensure safe operation and to retain the instrument in a safe condition (see Sections II and III). Service and adjustments should be performed only by qualified service personnel.

<b>WARNING</b>
----------------

Any interruption of the protective (grounding) conductor inside or outside the instrument or disconnection of the protective earth terminal is likely to make the apparatus dangerous. Intentional interruption is prohibited.

5-5. Any adjustment, maintenance, and repair of the opened instrument under voltage should be avoided as much as possible and, when inevitable, should be carried out only by a skilled person who is aware of the hazard involved. The opening of covers or removal of parts, except those to which access can be gained by hand, may expose live parts, and also accessible terminals may be live.

5-6. Capacitors inside the instrument may still be charged even if the instrument has been disconnected from its source of supply.

5-7. Make sure that only fuses with the required rated current and of the specified type (normal blow, time delay, etc.) are used for replacement.

The use of repaired fuses and the short-circuiting of fuseholders must be avoided.

5-8. Whenever it is likely that the protection has been impaired, the instrument must be made inoperative and be secured against any unintended operation.

### 5-9. TEST EQUIPMENT REQUIRED

5-10. Tables 1-2 and 1-3 contain a list of test equipment and test accessories required in the adjustment procedures. In addition, the tables contain the required minimum specifications and a suggested manufacturer's model number.

### 5-11. Posidriv Screwdrivers

5-12. Many screws in the instrument appear to be Phillips, but are not. To avoid damage to the screw slots, Posidriv screwdrivers should be used.

### 5-13. Blade Tuning Tools

5-14. For adjustments requiring a non-metallic metal-blade tuning tool, use the J.F.D. Model No. 5284 (HP 8710-1010). In situations not requiring non-metallic tuning tools, an ordinary small screwdriver or other suitable tool is sufficient. No matter what tool is used, never try to force any adjustment control in the generator. This is especially critical when tuning variable slug-tuned inductors, and variable capacitors.

### 5-15. Service Aids

5-16. **Spare Parts Kit.** The HP 08640-60095 Spare Parts Kit contains miscellaneous mechanical spare parts for the generator - such things as nuts, bolts, screws and washers.

5-17. **Extender Board.** An extender board is supplied with the generator that can be used to extend all circuit plug-in boards (except the A10A2 RF Divider Assembly and the A12 Rectifier Assembly). The RF Divider Assembly is self-extending - just remove the riser board and insert the Divider Assembly into the riser's socket.

**5-18. Wrench.** A wrench is supplied with the generator. One end fits the SMC connectors used on the generator's RF cables, the other end fits another common size SMC connector which may be used in servicing the instrument.

### 5-19. FACTORY SELECTED COMPONENTS

5-20. Table 5-1 contains a list of factory selected components by reference designation, basis of selection, and schematic diagram location. Factory selected components are designated by an asterisk (\*) on the schematic diagrams in Section VIII.

5-21. The following information supplements Table 5-1.

a. **A8A1R4 Selection.** If A8A1U5 has been replaced and counter external sensitivity is not within specification, select A8A1R4 as follows:

1. Set COUNTER MODE to EXT 0 - 10 or EXT 0 - 550.
2. Measure dc voltage at A8A1U5 pins 1 and 14.
3. Select a value of resistance that will bring dc voltage at pin 14 to within 10% of voltage at pin 1.

b. **A10A2R6-8, R12-14, and R18-20 Selection.** If A26U2 (Service Sheet 12) has been replaced, check second harmonic level (at RF output jack) on the following bands: 128 - 256 MHz, 64 - 128 MHz, and 32 - 64 MHz. If second harmonic level is out of specification, increase affected band's divider output attenuation until second harmonic level is within specification. The following table indicates correct values of resistance for 3 to 6 dB of attenuation (change attenuation in 1 dB steps).

Band (RANGE)	Resistors (A10A2)		
	128 - 256 MHz	R7	R6
64 - 128 MHz	R13	R12	R14
32 - 64 MHz	R19	R18	R20
Attenuation	Resistance		
3 dB	17.8Ω	287Ω	287Ω
4 dB	23.7Ω	237Ω	237Ω
5 dB	31.6Ω	178Ω	178Ω
6 dB	38.3Ω	147Ω	147Ω

c. To change attenuation, change all three resistors associated with the band that's out of specification. For example, if 64 - 128 MHz band second harmonic is too high, then R13, R12, and R14 will have to be changed. Change attenuation in 1 dB steps (e.g., to change their attenuation to 5 dB, change R13 to 31.6Ω, R12 to 178Ω, and R14 to 178Ω.)

### NOTE

Attenuation should be no higher than necessary to bring a band's second harmonic within specification. Excessive attenuation may reduce maximum RF output level below +19 dBm.

d. **A26A3C3, C4, C5 and C6 Selection.** Capacitors may or may not be used; their values are always 0.22 pF. Select as follows:

1. Set AM switch to PULSE, FREQUENCY RANGE to 256 - 512 MHz, and RF ON/OFF to ON.
2. Connect a spectrum analyzer to MOD OUTPUT JACK, A26A3J1.
3. Check from 256 to 512 MHz (tune FREQUENCY TUNE across band). Signals should always be below -58 dBm.
4. Add or remove capacitors across diodes as necessary to keep signals below -58 dBm.

Table 5-1. Factory Selected Components†  
(1 of 2)

Component	Service Sheet	Range of Values	Basis of Selection
A8A1R4	18	2-5 kΩ	See paragraph 5-21. Select for an indication on counter with 100 mVrms applied to COUNTER INPUT.
A10A2R6-8, R12-14, and R18-20	11		See paragraph 5-21.

† See backdating, Tables 7-1 and 7-2.

Table 5-1. Factory Selected Components†  
(2 of 2)

Component	Service Sheet	Range of Values	Basis of Selection
A11R28 (Option 001)	9A	215 to 316 ohms	See paragraph 5-27. Select for less than specified distortion with distortion analyzer connected to front panel output jack. (Dis- tortion should not be so low that amplitude stability is poor at 20 Hz.)
A26A3C3, C4, C5, C6	12	0.22 pF	See paragraph 5-21.

† See backdating, Tables 7-1 and 7-2.

## 5-22. POST-REPAIR TEST AND ADJUSTMENTS

5-23. The adjustments in this section should be performed when the troubleshooting information

in Section VIII indicates that an adjustable circuit is not operating correctly. Perform the adjustments *after* repairing or replacing the circuit. The required adjustments are specified in Table 5-2. Allow the instrument to warmup one hour before making any adjustment.

5-24. After making the adjustments, perform the performance tests (found in Section IV) specified in the table. In general, if any casting was opened (or any RF connectors removed) during a repair, the Output Leakage Test should be performed. Performance tests should also be made for any assembly that had a component changed, even if the changed component was not defective. The power supplies should be checked whenever an assembly has been repaired.

### NOTE

Table 5-2 can also be used for troubleshooting. If the generator failed one or more performance tests, cross-referencing to the associated assembly or circuitry will often indicate the source of the failure.

Table 5-2. Post-Repair Test and Adjustments (1 of 4)

Assembly Repaired	Performance Tests	Adjustments
A1 Output Level Assy	Harmonics Test (4-17) Output Level Accuracy Test (4-23 or 4-24) Output Level Flatness Test (4-25) Output Impedance Tests (4-26 and 4-27) Output Leakage Test (4-29)	Check power supply voltages (5-25) Output Level Knob Adjustment (5-30) Output Level Vernier and Meter Adjustment (5-31)
A2 Meter Switch/Detector Assy A4 Meter/Annunciator Drive Assy Panel Meter M1	Output Level Accuracy Test (upper 2 ranges only) (4-24 or 4-25) AM Sensitivity and Accuracy Test (meter only) (4-34) FM Sensitivity and Accuracy Test (meter only) (4-40)	Check power supply voltages (5-25) Meter Adjustments (5-28)
A3 RF Oscillator Assy	Frequency Range Test (256-512 MHz only) (4-11) Frequency Accuracy and Fine Tune Test (fine tune only) (4-12) Frequency Stability Tests (4-13, 4-14, 4-15, and 4-16) Harmonics Test (4-17) Single Sideband Phase Noise Test (4-19) Residual FM Test (4-22) Output Level Flatness Test (256-512 MHz only) (4-25) Output Leakage Test (4-29) FM Distortion Test (4-39) FM Sensitivity and Accuracy Test (4-40) Phase Lock Restabilization Time Test (check only that phase lock operates) (4-45)	Check power supply voltages (5-25) $V_T$ Pot Adjustment (5-35) $V_T$ Voltage Adjustment (5-36) Preliminary FM Adjustments (if necessary) (5-38) FM Linearity Adjustment (if necessary) (5-39) FM Sensitivity Adjustment (if necessary) (5-40)

Table 5-2. Post-Repair Tests and Adjustments (2 of 4)

Assembly Repaired	Performance Tests	Adjustments
A5 FM Amplifier Assy A7 FM Shaping Assy	FM 3 dB Bandwidth Test (4-38) FM Distortion Test (4-39) FM Sensitivity and Accuracy Test (omit meter check) (4-40)	Check power supply voltages (5-25) Preliminary FM Adjustments (5-38) FM Linearity Adjustment (5-39) FM Sensitivity Adjustment (5-40)
A6 Annunciator Assy	None	None
A8 Counter/Lock Assy	Operator's Checks (Figure 3-4) Frequency Accuracy and Fine Tune Test (accuracy only) (4-12) Frequency Stability Tests (4-13, 4-14, 4-15, and 4-16) Sub-Harmonics and Non-Harmonic Spurious Test (4-18) Output Leakage Test (4-29) Counter External Sensitivity Test (4-42) Internal Reference Accuracy Test (4-43) Internal Reference Drift Rate (Stability) Test (4-44) Phase Lock Restabilization Time Test (4-45)	Check power supply voltages (5-25) Internal Reference Frequency Adjustment (if necessary) (5-41)
A9 Peak Deviation and Range Switch Assy	Operator's Checks (Figure 3-4) FM Sensitivity and Accuracy Test (4-40)	Check power supply voltages (5-25) Peak Deviation and Range Switch Adjustment (if necessary) (5-33) Range Switch Adjustment (5-34) Preliminary FM Adjustments (if necessary) (5-38) FM Linearity Adjustment (if necessary) (5-39)

Table 5-2. Post-Repair Tests and Adjustments (3 of 4)

Assembly Repaired	Performance Tests	Adjustments
A9 Peak Deviation and Range Switch Assy (Cont'd)		FM Sensitivity Adjustment (if necessary) (5-40)
A10 Divider/Filter Assy	Frequency Range Test (4-11) Harmonics Test (4-17) Output Level Flatness Test (4-25) Output Leakage Test (4-29)	Check power supply voltages (5-25) Range Switch Adjustment (if necessary) (5-34) $V_T$ Voltage Adjustment (5-36) RF Filter Adjustment (if necessary) (5-37)
A11 Fixed-Frequency Modulation Oscillator Assy or A11 Variable-Frequency Modulation Oscillator Assy (Option 001)	Internal Modulation Oscillator Test (4-30) Internal Modulation Oscillator Distortion Test (Option 001 only) (4-31)	Check power supply voltages (5-25) Fixed Frequency Modulation Oscillator Adjustment (5-26) or Variable-Frequency Modulation Oscillator Adjustment (5-27)
A12 Rectifier Assy A13 Modulation/Metering Mother Board Assy A14 Line Power Module A15 Riser Assy A17 Power Supply Mother Board Assy A20 +5.2V and +44.6V Regulator Assy A22 +20V and -20V Regulator Assy A24 Series Regulator Socket Assy	Frequency Stability vs Time Test (4-13) Frequency Stability vs Line Voltage Test (4-15) Residual FM Test (4-22) Internal Reference Drift Rate (Stability) Test (4-44)	Power Supply Adjustments (5-25)
A16 Fan Motor Assy A18 -5.2V Regulator and Fan Driver Assy	Residual FM Test (4-22)	Power Supply Adjustments (5-25)

Table 5-2. Post-Repair Tests and Adjustments (4 of 4)

Assembly Repaired	Performance Tests	Adjustments
<p>A26 AM/AGC and RF Amplifier Assy</p>	<p>                     Harmonics Test (4-17)                      Residual AM Test (4-21)                      Output Level Accuracy Test (4-23 or 4-24)                      Output Level Flatness Test (4-25)                      Output Impedance Test (4-26 and 4-27)                      Auxiliary Output Test (4-28)                      Output Leakage Test (4-29)                      AM 3 dB Bandwidth Test (4-32)                      AM Distortion Test (4-33)                      AM Sensitivity and Accuracy Test (4-34)                      Peak Incidental Phase Modulation Test (4-35)                      Pulse Modulation Test (4-36)                      Pulse On/Off Ratio Test (4-37)                      Incidental AM Test (4-41)                 </p>	<p>                     Check power supply voltages (5-25)                      RF Detector Offset Adjustment (5-29)                      Output Level Vernier and Meter Adjustment (5-31)                      AM Sensitivity Adjustment (5-32)                 </p>



## ADJUSTMENTS

---

### 5-25. POWER SUPPLY ADJUSTMENTS

#### REFERENCE:

Service Sheets 22 and 23.

#### DESCRIPTION:

A digital voltmeter is used to check the power supply voltages. They are then adjusted for the correct voltage. This procedure should be performed before making any other adjustment.

#### EQUIPMENT:

Digital Voltmeter . . . . . HP 3480B/3484A

#### PROCEDURE:

1. Set LINE switch to ON. The fan should run and five LED's located on power supply boards (A18, A20, and A22) should be lit.
2. Connect DVM to each of the test points listed below. The voltages should be within the tolerances shown; if not, adjust appropriate resistor for a reading within the indicated tolerances.

Test Point	Adjust	Voltage Level
-5.2V A18TP5	A18R2	-5.200V ± 10 mV _____ *
+5.2V A20TP10	A20R16	+5.200V ± 10 mV _____
+20V A22TP4	A22R7	+20.000V ± 10 mV _____ **
-20V A22TP9	A22R19	-20.000V ± 10 mV _____ ***
+44.6V A20TP4	A20R8	+44.600V ± 100 mV _____

\* For ambient temperatures other than 25°C, modify the voltage level setting by -4.2 mV/°C.  
 \*\* Perform FM CAL adjustment (paragraph 5-38, step 5) and time base adjustment (paragraph 5-41).  
 \*\*\* Perform VARACTOR BIAS adjustment (paragraph 5-38, step 12).

---

### 5-26. FIXED-FREQUENCY MODULATION OSCILLATOR ADJUSTMENT

#### REFERENCE:

Service Sheet 9.

#### DESCRIPTION:

A digital voltmeter is used to monitor the audio oscillator's output while setting its level. The AUDIO OUTPUT LEVEL dial is also adjusted.

---

ADJUSTMENTS

5-26. FIXED-FREQUENCY MODULATION OSCILLATOR ADJUSTMENT (Cont'd)

EQUIPMENT:

Digital Voltmeter . . . . .	HP 3480B/3484A
600 Ohm Feedthrough . . . . .	HP 11095A

PROCEDURE:

1. Connect DVM, through 600 ohm feedthrough, to AM OUTPUT. Set Signal Generator's controls as follows:

AM . . . . .	INT
MODULATION FREQUENCY . . . . .	1000 Hz
FM . . . . .	OFF
AUDIO OUTPUT LEVEL . . . . .	Full cw

2. Adjust OSC LEVEL adjustment, A11R6, for a  $1.00 \pm 0.01$  Vrms reading on DVM.
3. Set AUDIO OUTPUT LEVEL to 100 mVrms as read on DVM. The AUDIO OUTPUT LEVEL dial should read 100 mVrms. If it does not, loosen setscrews on knob and align knob so that it does.
4. Set MODULATION FREQUENCY to 400 Hz. Set AUDIO OUTPUT LEVEL fully cw. The DVM should read within 2% of 1 Vrms.

0.98 \_\_\_\_\_ 1.02 Vrms

5-27. VARIABLE-FREQUENCY MODULATION OSCILLATOR ADJUSTMENT (OPTION 001)

REFERENCE:

Service Sheet 9A.

DESCRIPTION:

A digital voltmeter and a frequency counter are used to monitor output voltage and frequency while adjusting the oscillator. The MODULATION FREQUENCY dial and the AUDIO OUTPUT LEVEL dial are adjusted.

EQUIPMENT:

Digital Voltmeter . . . . .	HP 3480B/3484A
Frequency Counter . . . . .	HP 5327C
600 Ohm Feedthrough . . . . .	HP 11095A

ADJUSTMENTS

5-27. VARIABLE-FREQUENCY MODULATION OSCILLATOR ADJUSTMENT (OPTION 001) (Cont'd)

PROCEDURE:

1. Check that modulation oscillator is installed with all of its covers in place.
2. If the knobs have been removed, turn MODULATION FREQUENCY vernier shaft full cw. Install frequency dial on vernier shaft so that the gears mesh and number 200 on the dial is 10 to 20° to the left (ccw) of the cursor. Turn MODULATION FREQUENCY switch shaft full ccw and install range knob on switch shaft so that 400 Hz FIXED FREQUENCY position is at the cursor (top). Install vernier knob. (The knobs should not touch each other.)
3. Turn trim capacitors A11C2 and C3 full cw.

NOTE

Turning C2 ccw decreases the output voltage while raising the frequency.  
 Turning C3 ccw increases the output voltage while raising the frequency.

4. Set Signal Generator's controls as follows:

AM	.....	INT
MODULATION FREQUENCY Switch	.....	X100
MODULATION FREQUENCY Vernier	.....	Full ccw
FM	.....	OFF
AUDIO OUTPUT LEVEL	.....	Full cw

5. Connect DVM to OSC OUT test point, A11TP4. The DVM should read  $1.6 \pm 0.3$  Vrms.

1.3 \_\_\_\_\_ 1.9 Vrms

6. Connect frequency counter to AM OUTPUT jack. The counter should read  $1.8 \pm 0.2$  kHz.

1.6 \_\_\_\_\_ 2.0 kHz

7. Set MODULATION FREQUENCY vernier full cw and adjust trim capacitors, A11C2 and C3, until voltage level at A11TP4 is within 0.1 Vrms of level read in step 5 and frequency at AM OUTPUT is  $21 \pm 1$  kHz.

8. Set MODULATION FREQUENCY vernier for a frequency counter reading of  $2.0 \pm 0.01$  kHz. Loosen setscrews in gear that meshes with frequency dial gear (vernier). Rotate dial gear so that dial reads 20 (at the cursor) and tighten setscrews in gear. The frequency counter should read  $2.0 \pm 0.01$  kHz when dial reads 20 at the cursor. Record voltage level at A11TP4.

\_\_\_\_\_ Vrms

9. Set MODULATION FREQUENCY vernier to 200. Adjust A11C2 and C3 until voltage level at A11TP4 is within 0.01 Vrms of level recorded in step 8 and frequency is  $20.0 \pm 0.1$  kHz.

ADJUSTMENTS

5-27. VARIABLE-FREQUENCY MODULATION OSCILLATOR ADJUSTMENT (OPTION 001) (Cont'd)

10. Set MODULATION FREQUENCY vernier to 20. The counter should read  $2.00 \pm 0.01$  kHz and voltage level at A11TP4 should be within 0.01 Vrms of level recorded in step 8. Repeat steps 8 and 9 until voltage level and frequency are correct.

11. Monitor voltage at A11TP4 while using MODULATION FREQUENCY switch and vernier to tune oscillator from 2 kHz to 20 kHz. The voltage level at 2 kHz (on the X100 range) should be  $1.6 \pm 0.05$  Vrms and level at all other frequencies should be within 0.03 Vrms of level at 2 kHz.

At 2 kHz: 1.55 \_\_\_\_\_ 1.65 Vrms

All frequencies: \_\_\_\_\_  $\pm 0.03$  Vrms

12. If level at A11TP4 is too high, reduce A11R28 by one standard value (10%); if level is too low, increase A11R28 by one standard value. Then repeat steps 8 through 11.

13. Set MODULATION FREQUENCY range switch to X3 K and vernier to 200 and adjust HIGH FREQ capacitor A11C9 for a counter reading of  $600 \pm 3$  kHz.

597 \_\_\_\_\_ 603 kHz

†14. Connect DVM to AM OUT test point, A11TP5. Set MODULATION FREQUENCY range switch to X100 and the vernier to 20. Adjust AM-FM adjustment, A11R35, for  $840 \pm 10$  mVrms at A11TP5.

830 \_\_\_\_\_ 850 mVrms

15. Connect DVM to the FM OUT test point, A11TP3. It should read within 5 mVrms of reading in step 14.

\_\_\_\_\_  $\pm 5$  mVrms

16. Use MODULATION FREQUENCY range switch and vernier to tune oscillator across each range (except 400 and 1000 Hz FIXED FREQ). Monitor voltage level at A11TP3; the DVM should read within 10 mVrms of level noted at 20 on vernier dial from 200 Hz to 100 kHz. It should read within 20 mVrms of level noted at 20 on vernier dial from 20 Hz to 600 kHz.

200 Hz to 100 kHz: \_\_\_\_\_  $\pm 10$  mVrms

20 Hz to 600 kHz: \_\_\_\_\_  $\pm 20$  mVrms

17. Set MODULATION FREQUENCY range switch to X3 K and vernier to 20. Connect DVM to AM OUTPUT jack through 600 ohm feedthrough. Adjust AUDIO LEVEL adjustment, A11R40, for  $3.00 \pm 0.03$  Vrms at the jack.

2.97 \_\_\_\_\_ 3.03 Vrms

18. Set AM to OFF and FM to INT. Connect DVM to FM OUTPUT jack through the 600 ohm feedthrough. The DVM should read  $3.0 \pm 0.06$  Vrms.

19. Check that AUDIO OUTPUT LEVEL control indicates 3V when turned fully cw. If it does not, loosen its setscrews and adjust it so that it does; then tighten setscrews.

† See Tables 7-1 and 7-2 for backdating.

ADJUSTMENTS

5-28. METER ADJUSTMENTS

REFERENCE:

Service Sheet 17.

DESCRIPTION:

The panel meter is mechanically zeroed. The meter circuitry is then adjusted at zero and full scale.

EQUIPMENT:

Digital Voltmeter . . . . . HP 3480B/3484A

PROCEDURE:

1. With LINE switch set to OFF, place Signal Generator in its normal operating position (e.g., if its normal operating position is tilted up with the tilt stand locked down, place it that way).
2. Adjust mechanical zero adjustment screw on panel meter clockwise for a zero meter reading. Then turn screw slightly counterclockwise to free mechanism from adjusting peg.
3. Set generator's controls as follows:

Meter Function . . . . .	FM
FM . . . . .	OFF
MODULATION FREQUENCY . . . . .	1000 Hz
PEAK DEVIATION . . . . .	10 kHz
PEAK DEVIATION Vernier . . . . .	Full ccw
RANGE . . . . .	2 - 4 MHz
LINE . . . . .	ON

4. Connect DVM to DC OUT test point (A2TP2) on A2 Meter Switch/Detector Assembly. Adjust DET OFFSET pot (A2R5) for 0 Vdc ± 1 mVdc at A2TP2.
5. Connect DVM to MTR ADJ test point (A4TP1) on A4 Meter Annunciator Drive Assembly. Adjust DRIVER OFFSET pot (A4R10) for 0 Vdc ± 1 mVdc at A4TP1.
6. Set FM to INT. Adjust PEAK DEVIATION vernier clockwise until DVM reads 9.766 Vdc at A4TP1. Then adjust F.S. METER pot (A4R19) for a full scale reading (10 on the 0-10 scale) on the panel meter.

5-29. RF DETECTOR OFFSET ADJUSTMENT

REFERENCE:

Service Sheets 12 and 13.

ADJUSTMENTS

5-29. RF DETECTOR OFFSET ADJUSTMENT (Cont'd)

DESCRIPTION:

A digital voltmeter is used to set the proper offset voltage out of the RF detector.

EQUIPMENT:

Digital Voltmeter . . . . . HP 3480B/3484A

PROCEDURE:

1. Connect DVM to DET test point, A26A1TP2, and set Signal Generator's controls as follows:

COUNTER MODE: EXPAND	Off
LOCK	Off
Source	INT
AM	OFF
FM	OFF
RANGE	32 - 64 MHz
FREQUENCY TUNE	50 MHz
RF ON/OFF	OFF

2. Set AGC Switch, A26A4S1, to off. Adjust AM offset pot, A26A1R11, for  $-61 \pm 2$  mVdc at DET test point.
3. Set AGC switch to on and set front panel RF ON/OFF switch to ON.
4. Perform Output Level Vernier and Meter Adjustment, paragraph 5-31.

5-30. OUTPUT LEVEL KNOB ADJUSTMENT

REFERENCE:

Service Sheets 13 and 16.

DESCRIPTION:

The RF attenuator knob is set, and the vernier voltage is monitored with a digital voltmeter and the vernier pot is adjusted. Then the vernier cursor is set. This procedure should be performed whenever the OUTPUT LEVEL knobs have been removed.

EQUIPMENT:

Digital Voltmeter . . . . . HP 3480B/3484A

## ADJUSTMENTS

---

### 5-30. OUTPUT LEVEL KNOB ADJUSTMENT (Cont'd)

#### PROCEDURE:

1. Set Signal Generator's controls as follows:

Meter Function	LEVEL
COUNTER MODE: EXPAND	Off
LOCK	Off
Source	INT
AM	OFF
FM	OFF
RANGE	32 - 64 MHz
FREQUENCY TUNE	50 MHz
OUTPUT LEVEL	As specified
RF ON/OFF	ON

2. Set OUTPUT LEVEL RF attenuator knob one position ccw from full cw so that +13 dBm is in line with top edge of white cursor range on front panel. If it does not line up, loosen knob's setscrews and align it. (The attenuator and vernier knobs should not touch each other.)
3. Loosen setscrew in brass gear at rear of A1 Output Level Assembly.
4. Set OUTPUT LEVEL vernier full cw. Using DVM, note voltage at VERN test point, A1A1TP1, on A1A1 RF Vernier Assembly. It should be approximately 2 volts.
5. Adjust OUTPUT LEVEL vernier for half the voltage (at the VERN test point) noted in step 4  $\pm 20$  mV.
6. Without moving vernier, turn brass gear shaft until cursor points to +7.5 dBm on dial. Tighten setscrew in brass gear.
7. Perform the Output Level Vernier and Meter Adjustment, paragraph 5-31.

---

### 5-31. OUTPUT LEVEL VERNIER AND METER ADJUSTMENT

#### REFERENCE:

Service Sheets 12 and 16.

#### DESCRIPTION:

The RF level accuracy for the upper OUTPUT LEVEL attenuator ranges is measured with a power meter and the generator's output level and panel meter are adjusted at +13 dBm. For the lower ranges, a reference signal is established on a spectrum analyzer display, the Signal Generator's OUTPUT LEVEL switch and the spectrum analyzer's vertical scale log reference level control are stepped together, and any amplitude variations at -67 and -97 dBm are measured on the analyzer's display. An RF attenuator and amplifier at the RF OUTPUT are adjusted for analyzer compatibility and best sensitivity.

ADJUSTMENTS

5-31. OUTPUT LEVEL VERNIER AND METER ADJUSTMENT (Cont'd)

This procedure uses an IF substitution technique in which the spectrum analyzer's IF is the standard. The IF step accuracy should be within  $\pm 0.2$  dB overall. The IF step accuracy can be checked using the above technique by comparing a lab calibrated attenuator (such as HP Model 355D Option H36) with the IF step control at the frequency of attenuator calibration (e.g., 3 MHz for the HP 355D Option H36).

NOTE

1. Check that the Output Level Knob Adjustment (5-30), the RF Detector Offset Adjustment (5-29), and the Meter Adjustments (5-28) are correct before performing this adjustment.
2. After making meter adjustments which are accessible only from the bottom of the instrument, check the adjustment with the instrument in its normal operating position.

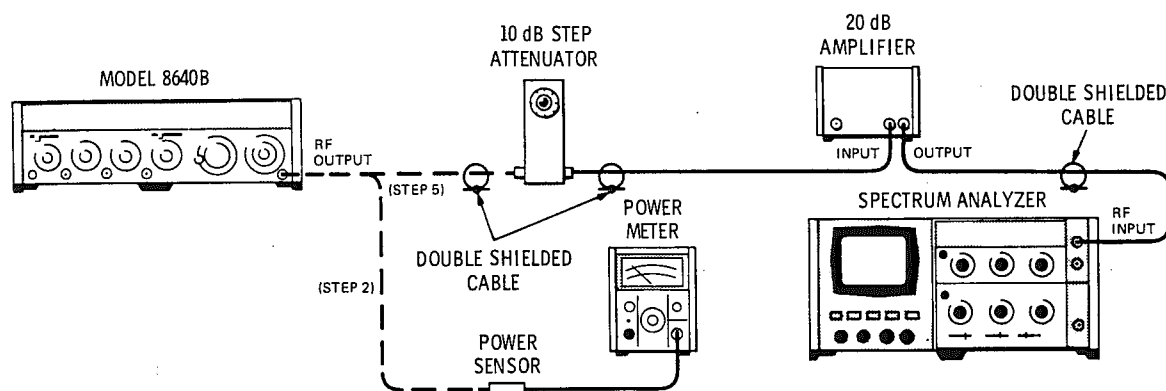

Figure 5-1. Output Level Vernier and Meter Adjustment Test Setup

EQUIPMENT:

Spectrum Analyzer	.....	HP 141T/8552B/8553B
Power Meter	.....	HP 435A
Power Sensor	.....	HP 8481A
20 dB Amplifier	.....	HP 8447A
Double Shielded Cable (3 required)	.....	HP 08708-6033

NOTE

An HP Model 432A Power Meter with a Model 478A Thermistor Mount can be used for this test. However, a 10 dB attenuator, such as the Model 8491A OPT 10, must be used with the mount. This will slightly degrade measurement accuracy.



## ADJUSTMENTS

## 5-31. OUTPUT LEVEL VERNIER AND METER ADJUSTMENT (Cont'd)

## PROCEDURE:

1. Connect equipment as shown in Figure 5-1 after setting Signal Generator's controls as follows:

Meter Function	LEVEL
COUNTER MODE: EXPAND	Off
LOCK	Off
Source	INT
AM	OFF
FM	OFF
RANGE	32 - 64 MHz
FREQUENCY TUNE	50 MHz
OUTPUT LEVEL	As specified
RF ON/OFF	ON

2. Set OUTPUT LEVEL switch one step ccw from full cw; turn OUTPUT LEVEL vernier until the cursor lines up with the top edge of the white cursor range (i.e., for +13 dBm read on OUTPUT LEVEL switch cursor).
3. Adjust LVL adjustment, A26A4R1, for a +13 dBm reading on power meter. Adjust MET adjustment, A26A4R12, for a +13 dBm indication on generator's panel meter (+3 dB reading on meter).
4. Set OUTPUT LEVEL switch three steps ccw to -17 dBm. Adjust vernier for a -17 dBm reading on power meter.
5. Disconnect power meter from generator and connect step attenuator, amplifier, and spectrum analyzer to RF OUTPUT.
6. Set step attenuator to 30 dB. Set spectrum analyzer's center frequency controls to 50 MHz (stabilizer on), resolution bandwidth to 10 kHz, frequency span per division (scan width to 5 kHz, input attenuation to 0 dB), display smoothing (video filter) to 100 Hz, and log/linear display switch to 2 dB log. Set the reference level switch for a -10 dBm reference level at the top graticule line on the display; adjust the reference level vernier to place the signal to the display's fifth horizontal graticule line.
7. Set generator's OUTPUT LEVEL switch to -47 dBm (i.e., 3 steps ccw). Set analyzer's reference level switch to -40 dBm and note signal level on display (i.e., the difference between the signal level and the fifth horizontal graticule line).
8. Set step attenuator to 0 dB; reset analyzer's reference level switch to -10 dBm and adjust analyzer's reference level vernier for the same signal level noted in step 7.
9. Set generator's OUTPUT LEVEL switch to -67 dBm; set analyzer's reference level switch to -30 dBm and adjust generator's OUTPUT LEVEL vernier to set signal on analyzer's display to the fifth horizontal graticule line (to the same place it was set in step 6).
10. Adjust the 10  $\mu$ V adjustment, A1A1R5, for a -67 dBm indication on generator's panel meter (+3 dB reading on meter).

ADJUSTMENTS

5-31. OUTPUT LEVEL VERNIER AND METER ADJUSTMENT (Cont'd)

11. Set generator's OUTPUT LEVEL switch to -97 dBm. Set analyzer's reference level control to -60 dBm. Adjust OUTPUT LEVEL vernier to set signal on analyzer's display to the fifth horizontal graticule line (to the same place it was set in step 6). Adjust the 1 μV adjustment, A1A1R6, for a -97 dBm indication on generator's panel meter (+3 dB reading on meter).
12. Perform AM Sensitivity Adjustment, paragraph 5-32, if repairs have been made to the A26 AM/AGC and RF Amplifier Assembly.

5-32. AM SENSITIVITY ADJUSTMENT

REFERENCE:

Service Sheet 14.

DESCRIPTION:

AM sensitivity is adjusted while comparing the actual amount of amplitude modulation to the level of the input modulating signal. A spectrum analyzer is used to measure the actual modulation. The analyzer is used with zero frequency span at the carrier frequency. A DVM is used to measure the ac and dc voltages at the analyzer's vertical output, and the dc value of the carrier is set to 282.8 mVdc; the rms value of the modulation is then a very accurate measure of AM percent (% AM is 1/2 the ac voltage in mVrms).

EQUIPMENT:

Spectrum Analyzer	.....	HP 141T/8552B/8554B
Digital Voltmeter	.....	HP 3480B/3484A
Test Oscillator	.....	HP 652A
Calibrated Step Attenuator	.....	HP 355D OPT H36

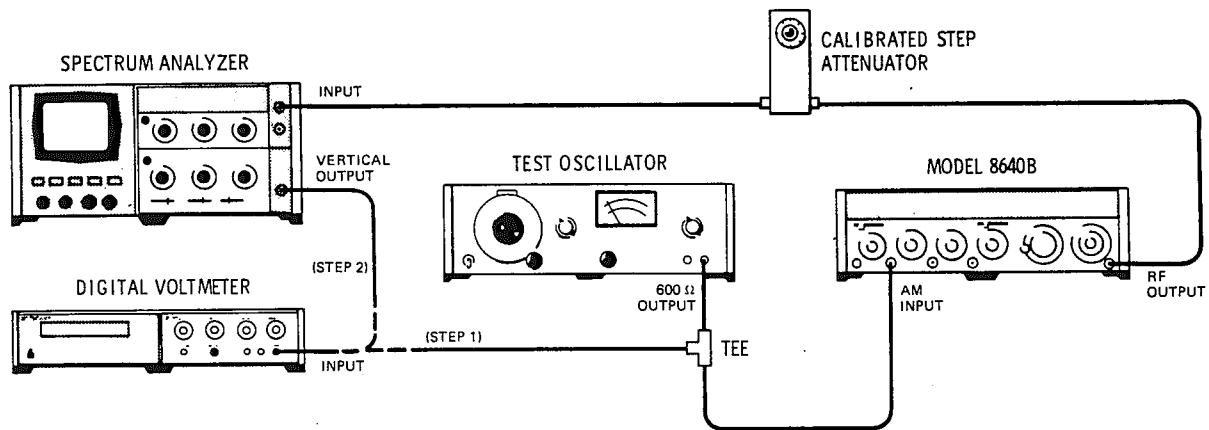

Figure 5-2. AM Sensitivity Adjustment Test Setup

## ADJUSTMENTS

---

### 5-32. AM SENSITIVITY ADJUSTMENT (Cont'd)

#### PROCEDURE:

1. Connect equipment as shown in Figure 5-2 after setting Signal Generator's controls as follows:

Meter Function	AM
COUNTER MODE: EXPAND	Off
LOCK	Off
Source	INT
AM	AC
MODULATION	Full cw
FM	OFF
RANGE	256 - 512 MHz
FREQUENCY TUNE	512 MHz
OUTPUT LEVEL	-27 dBm
	(switch 5 steps ccw from full cw, vernier full cw)
RF ON/OFF	ON

2. Set test oscillator for a 1 kHz, 353.6 mVrms signal as read on DVM (50% AM). Disconnect DVM from test oscillator (leave oscillator connected to generator). Connect the DVM to spectrum analyzer's vertical output. Set calibrated step attenuator to 0 dB.
3. Set spectrum analyzer's resolution bandwidth to 300 kHz, input attenuation to 20 dB, frequency span per division (scan width) to 20 kHz (tuning stabilizer on), scale to linear, and adjust center frequency and scale reference level controls to center the 512 MHz signal on the display. Set frequency span per division to 0 Hz and display smoothing (video filter) to 10 kHz. Peak the trace on the display with center frequency controls; set trace to center of display with reference controls.

#### NOTE

Step 4 measures the analyzer's dc offset ( $V_{\text{off}}$ ) and must be performed to ensure the accuracy of this test. However if  $V_{\text{off}}$  for the analyzer being used has recently been measured and noted, skip step 4 and go on to step 5 (and eliminate the calibrated step attenuator from the test setup).

4. Measure analyzer's dc offset ( $V_{\text{off}}$ ) by performing steps "a" through "f".

- a. Set generator's controls as follows:

Meter Function	LEVEL
AM	OFF
RANGE	2 - 4 MHz
FREQUENCY TUNE	3 MHz

- b. Set analyzer's center frequency controls to 3 MHz.
- c. Adjust analyzer's reference level controls for -500 mVdc indicated on DVM ( $V_{\text{DET 1}}$ ).
- d. Set step attenuator to 20 dB. Note DVM reading ( $V_{\text{DET 2}}$ ).

---

**ADJUSTMENTS**

---

**5-32. AM SENSITIVITY ADJUSTMENT (Cont'd)**

e. Calculate  $V_{\text{off}}$  where

$$V_{\text{off}} = \frac{V_{\text{DET 2}} - \alpha V_{\text{DET 1}}}{1 - \alpha}$$

and  $\alpha = V_{\text{RF 2}}/V_{\text{RF 1}}$  (i.e.,  $\alpha$  = attenuation; for 20 dB it is 0.1).

therefore

$$V_{\text{off}} = \frac{V_{\text{DET 2}} + 50 \text{ mVdc}}{0.9}$$

- f. Reset step attenuator to 0 dB, Signal Generator as specified in step 1, and spectrum analyzer as specified in step 3.
5. To calibrate spectrum analyzer for percent of AM measurement, use analyzer's reference level controls to set  $-282.8 \text{ mV} + V_{\text{off}}$  at vertical output (as measured on the DVM). For example, if  $V_{\text{off}}$  is  $+50.0 \text{ mV}$ , then set  $-282.8 \text{ mV} + (+50.0 \text{ mV})$  or  $-232.8 \text{ mV}$  at vertical output. (Check that trace is peaked on analyzer display.)
6. Set DVM to measure  $\text{mV}_{\text{rms}}$  (ac only). Adjust % AM adjustment, A26A2R19, for a DVM indication of  $100 \text{ mV}_{\text{rms}}$ .

---

**5-33. PEAK DEVIATION AND RANGE SWITCH ADJUSTMENT**
**REFERENCE:**

Service Sheets 6, 7, and 8.

**DESCRIPTION:**

The switches are adjusted so that the FM gain switch (i.e., A9S3, the switch that is controlled by both the peak deviation and the frequency range switch) is correctly positioned. This procedure should be performed whenever the A9 assembly has been disassembled.

**PROCEDURE:**

1. Set RANGE and PEAK DEVIATION switches full cw. Loosen setscrews in the knobs and position RANGE switch knob so that 512 - 1024 MHz is under the cursor on front panel. Position PEAK DEVIATION switch knob so that 5.12 MHz is under the cursor on front panel. Tighten setscrews.
-

**ADJUSTMENTS**

---

**5-33. PEAK DEVIATION AND RANGE SWITCH ADJUSTMENT (Cont'd)**

2. Loosen locking screw on gain switch (A9S3) shaft (see exploded view in Section VIII). Rotate shaft until rotor tang on the front of the front wafer (A9S3AF-3½) is centered under clip with 94 wire (white-yellow). Tighten locking screw.
3. Rotate RANGE and PEAK DEVIATION switches through all of their positions (one at a time). Check that tang is adequately centered under all of the clips when they are approached from either direction (there is some backlash). If not, readjust the shaft until it is.
4. Perform Range Switch Adjustment, paragraph 5-34.

---

**5-34. RANGE SWITCH ADJUSTMENT**

**REFERENCE:**

Service Sheet 10.

**DESCRIPTION:**

The frequency at RF OUTPUT is monitored with a frequency counter. The divider/filter cams are positioned so that the frequency at RF OUTPUT agrees with the frequency indicated on the generator's readout. The RANGE switch knob is then set to the correct range. This procedure should be performed whenever the A9 assembly or the A10 assembly has been removed or replaced.

**EQUIPMENT:**

Frequency Counter . . . . . HP 5327C

**PROCEDURE:**

1. Connect frequency counter high frequency input to RF OUTPUT. Set Signal Generator's controls as follows:

COUNTER MODE: EXPAND	Off
LOCK	Off
Source	INT
AM	OFF
FM	OFF
RANGE	Full ccw
FREQUENCY TUNE	0.5 MHz
OUTPUT LEVEL	+13 dBm
RF ON/OFF	ON

2. Monitor output frequency with frequency counter. Loosen shaft coupling between RANGE switch and divider/filter cams. Rotate cam side of shaft until frequency counter reading agrees with frequency indicated on generator's output frequency display (i.e., to approximately 500 kHz); tighten shaft coupling.

## ADJUSTMENTS

---

### 5-34. RANGE SWITCH ADJUSTMENT (Cont'd)

3. Loosen RANGE switch knob, position it so that it indicates that the range is 0.5 - 1 MHz, and tighten it.
4. Set RANGE switch to each of its other positions (from both directions). The frequency counter should display readings that agree approximately with generator's readout (the correct frequency counter reading for the EXT DOUBLER 512 - 1024 MHz position is approximately 256 MHz).

---

### 5-35. $V_T$ POT (A3R1) ADJUSTMENT

#### REFERENCE:

Service Sheet 5.

#### DESCRIPTION:

The  $V_T$  pot is aligned so that it will not hit either end-stop as the FREQUENCY TUNE control is tuned through its full range. This adjustment should be performed whenever the pot has been replaced.

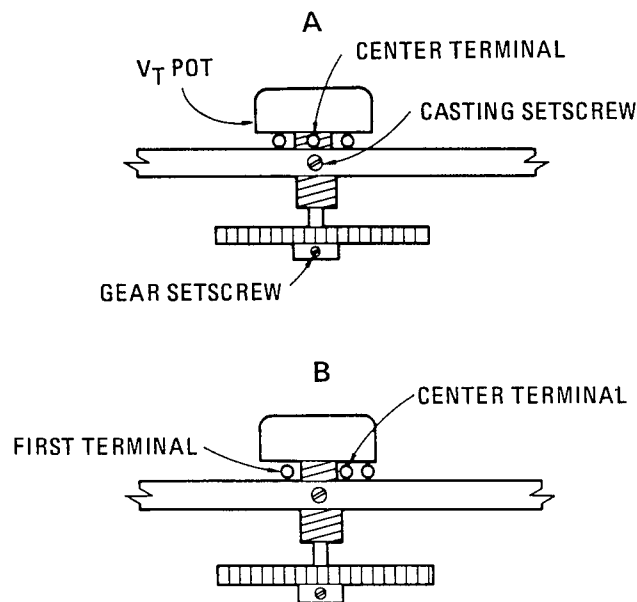

Figure 5-3.  $V_T$  Pot Adjustment

## ADJUSTMENTS

---

### 5-35. $V_T$ POT (A3R1) ADJUSTMENT (Cont'd)

1. Set FREQUENCY TUNE full clockwise.
2. Tighten the bushing and set  $V_T$  pot shaft full cw.
3. Install pot with gear in casting so that center terminal (934 wire) is in line with casting setscrew (see Figure 5-3,A).
4. Tighten setscrews in gear (not casting setscrew).
5. Rotate the pot cw so that casting setscrew lies between first and center terminals of pot (see Figure 5-2,B).
6. Tighten casting setscrew.
7. Perform the  $V_T$  Voltage Adjustment, paragraph 5-36.

---

### 5-36. $V_T$ VOLTAGE ADJUSTMENT

#### REFERENCE:

Service Sheets 5, 10, and 11.

#### DESCRIPTION:

This procedure should be performed whenever either the  $V_T$  pot, the A3 assembly, or the A10A2 assembly has been replaced.

#### PROCEDURE:

1. Set Signal Generator's controls as follows:

Meter Function	LEVEL
COUNTER MODE: EXPAND	Off
LOCK	Off
Source	INT
AM	OFF
FM	OFF
RANGE	256 - 512 MHz
FREQUENCY TUNE	As specified
FINE TUNE	Centered
OUTPUT LEVEL	0 dBm
RF ON/OFF	ON

## ADJUSTMENTS

5-36.  $V_T$  VOLTAGE ADJUSTMENT (Cont'd)

2. Set FREQUENCY TUNE to 356 MHz approached from low frequency band end (256 MHz); adjust  $V_T$  adjustment, A3A4R2 until the relays in the A10 assembly just actuate. When the relays actuate, they make an audible clicking.
3. Tune FREQUENCY TUNE one turn ccw and then cw until relays actuate. The frequency at actuation should be 355 - 357 MHz.
4. Tune FREQUENCY TUNE from 256 to 512 MHz. The generator's panel meter should read 0 dBm through the entire frequency range.

## 5-37. RF FILTER ADJUSTMENT

## REFERENCE:

Service Sheet 10.

## DESCRIPTION:

A spectrum analyzer and a tracking generator are used to measure the insertion loss and frequency response of each of the RF filters. Those filters that are adjustable are adjusted if necessary. A frequency counter, connected to the tracking generator's auxiliary output, is used to accurately set the analyzer's frequency. This procedure should be performed whenever the RF filters have been repaired or are suspect.

The filters must meet specified pass band and stop band characteristics. Figure 5-4 illustrates the terms used in the procedure.

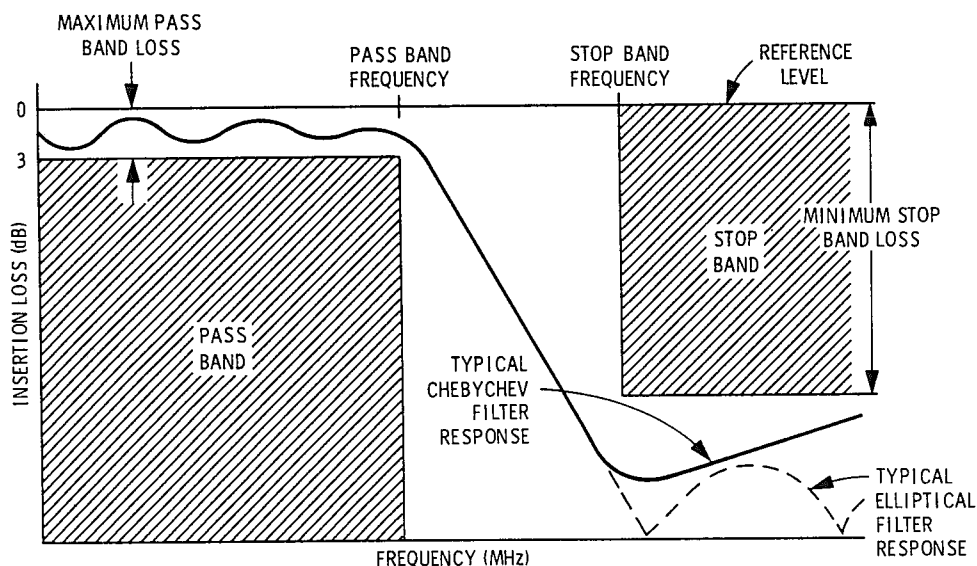

Figure 5-4. Filter Terminology



ADJUSTMENTS

5-37. RF FILTER ADJUSTMENT (Cont'd)

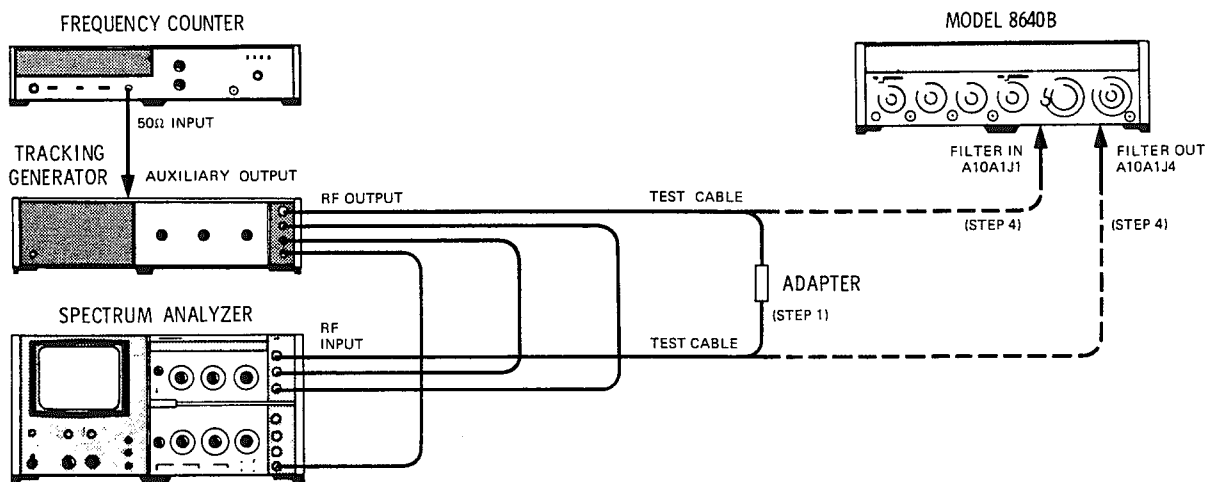

Figure 5-5. RF Filter Adjustment Test Setup

EQUIPMENT:

Spectrum Analyzer	.....	HP 141T/8552B/8554B
Tracking Generator	.....	HP 8444A
Frequency Counter	.....	HP 5327C
Test Cable (2 required)	.....	HP 11592-60001
Adapter	.....	HP 1250-0827

PROCEDURE:

1. Connect equipment as shown in Figure 5-5 after setting Signal Generator's controls as follows:

RANGE	.....	256 - 512 MHz
FREQUENCY TUNE	.....	Fully cw
RF ON/OFF	.....	OFF

2. Set spectrum analyzer center frequency to 550 MHz, frequency span (scan width) to 100 MHz per division, resolution bandwidth to 10 kHz, and input attenuation to 20 dB.
3. Set tracking generator's output level to 0 dBm. Adjust the tracking for maximum response in a 10 kHz resolution bandwidth. (Tracking should be checked periodically during this test.) Set analyzer's resolution bandwidth to 300 kHz.

---

**ADJUSTMENTS**

---

**5-37. RF FILTER ADJUSTMENT (Cont'd)**

4. For each of the frequency range bands listed in Table 5-3, perform the following:
  - a. Connect spectrum analyzer's RF input to tracking generator's RF output (use test cables and adapter as shown in test setup). Set Signal Generator's RANGE and FREQUENCY TUNE controls as listed in the table. Set spectrum analyzer's frequency span (scan width) controls to zero Hz.

**NOTE**

Geometric mean switching (on the 8 to 512 MHz bands) occurs near the middle of the frequency range. Switching is controlled by the position of the FREQUENCY TUNE control and switches between the high and low band filters for the frequency range. It can be noted either by listening for actuation of the RF relays or by observing a change in the spectrum analyzer's display when connected to the RF filters.

- b. Adjust analyzer's center frequency controls for a frequency counter indication of the pass band frequency listed in table. Adjust analyzer's vertical sensitivity controls to set trace to top (reference) graticule line on display (use 2 dB log per division); this sets the reference level for the filter check.
- c. Set analyzer's frequency span controls as listed in the table. Connect test cables to RF filter input and output as shown in the test setup. Check maximum loss at pass band frequency (center vertical graticule line) and below; it should be as specified.
- d. Set analyzer's frequency span controls to zero Hz. Adjust analyzer's center frequency controls for a frequency counter indication of the stop band frequency listed in the table. Then reset frequency span controls as listed in the table and set analyzer's display for 10 dB log per division.

**NOTE**

To measure the stop band frequency on the highest band it is necessary to set a frequency of 492 MHz at the second vertical graticule line to the left of center. This puts 692 MHz at the center (the counter will only read to 550 MHz).

- e. Check minimum loss at stop band frequency (center vertical graticule line) and above; it should be as specified.
- f. If necessary, on the 64 - 512 MHz bands, adjust the appropriate filter components to set pass band and stop band insertion loss within the specified limits. Use a non-metallic tuning tool.

**NOTE**

The 256 - 512 MHz high band is the most difficult to adjust and usually takes many iterations. Start with the adjustment capacitors oriented as in Figure 5-6. Stop band minimum loss should be >30 dB from 692 - 1000 MHz.

## ADJUSTMENTS

## 5-37. RF FILTER ADJUSTMENT (Cont'd)

Table 5-3. RF Filter Check

Signal Generator			Spectrum Analyzer Frequency Span Per Division	Pass Band		Stop Band		Adjustment (A10A1)
RANGE (Band)	FREQUENCY TUNE*	Filter*		Frequency	Maximum Loss	Frequency	Minimum Loss	
256-512 MHz	Full cw	High	100 MHz	550 MHz	<3 dB	692 MHz	>30 dB	C81-84
	Full ccw	Low	50 MHz	356 MHz	<3 dB	460 MHz	>30 dB	L43-45
128-256 MHz	Full cw	High	50 MHz	275 MHz	<3 dB	346 MHz	>30 dB	L40-42
	Full ccw	Low	20 MHz	128 MHz	<3 dB	230 MHz	>30 dB	L37-39
64-128 MHz	Full cw	High	20 MHz	137 MHz	<3 dB	173 MHz	>30 dB	L31-33
	Full ccw	Low	10 MHz	89 MHz	<3 dB	115 MHz	>25 dB	None
32-64 MHz	Full cw	High	10 MHz	69 MHz	<3 dB	86.5 MHz	>25 dB	None
	Full ccw	Low	5 MHz	45 MHz	<3 dB	58 MHz	>25 dB	None
16-32 MHz	Full cw	High	5 MHz	34 MHz	<3 dB	43.2 MHz	>20 dB	None
	Full ccw	Low	2 MHz	22 MHz	<3 dB	28.7 MHz	>20 dB	None
8-16 MHz	Full cw	High	2 MHz	17.0 MHz	<3 dB	21.6 MHz	>15 dB	None
	Full ccw	Low	2 MHz	11.0 MHz	<3 dB	14.3 MHz	>15 dB	None
4-8 MHz			1 MHz	8.6 MHz	<3 dB	10.7 MHz	>38 dB	None
2-4 MHz			1 MHz	4.3 MHz	<3 dB	5.40 MHz	>40 dB	None
1-2 MHz			1 MHz	2.2 MHz	<3 dB	2.70 MHz	>30 dB	None
0.5-1 MHz			1 MHz	1.1 MHz	<3 dB	1.30 MHz	>30 dB	None

\* The 0.5 to 8 MHz bands have a single filter for each band. Geometric mean switching does not take place and the FREQUENCY TUNE control can be left at any position.

ADJUSTMENTS

5-37. RF FILTER ADJUSTMENT (Cont'd)

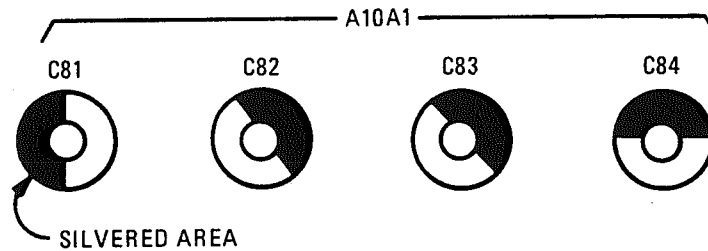

Figure 5-6. 256-512 MHz High Band Capacitor Adjustment Orientation

5-38. PRELIMINARY FM ADJUSTMENTS †

REFERENCE:

Service Sheets 6 and 7.

DESCRIPTION:

A digital voltmeter is used to correctly set the mechanical position of the FM compensation pot on the RF oscillator (this is necessary only if either the oscillator or the pot has been changed). Then the DVM is used to adjust the FM calibration voltage and the offset (balance) voltages in the FM amplifiers.

EQUIPMENT:

Digital Voltmeter . . . . . HP 3480B/3484A

PROCEDURE:

1. Set Signal Generator's controls as follows:

Meter Function . . . . .	FM
COUNTER MODE: EXPAND . . . . .	Off
LOCK . . . . .	Off
Source . . . . .	INT
AM . . . . .	OFF
FM . . . . .	OFF
PEAK DEVIATION . . . . .	2.56 MHz

† See backdating, Tables 7-1 and 7-2.

## ADJUSTMENTS

## 5-38. PRELIMINARY FM ADJUSTMENTS (Cont'd)

PEAK DEVIATION Vernier . . . . . Full cw  
 RANGE . . . . . 256 - 512 MHz  
 FREQUENCY TUNE . . . . . Full ccw  
 RF ON/OFF . . . . . ON

2. To set the compensation pot, A3R2, turn generator's LINE switch to OFF. Loosen setscrews in the gear on pot's shaft. Set DVM to measure ohms and connect it between 936 and 938 wires on the pot.
3. Without changing position of FREQUENCY TUNE knob, rotate compensation pot's shaft until DVM indicates between 0 and 9 ohms across the two wires.
4. Remove DVM, tighten setscrews, and set LINE to ON.
5. To adjust calibration voltage, set FM switch to CAL, set DVM to measure dc voltage, and connect DVM to FM BUFFER IN test point, A5TP5. Adjust FM CAL POT, A13R3, for  $1.000 \pm 0.001$  Vdc at A5TP5.
6. To adjust amplifier offset voltages, set FM switch to DC, and set FREQUENCY TUNE to 300 MHz. Connect DVM to BUFFER OUT test point, A5TP6, and adjust BUFFER OFFSET adjustment, A5R23, for  $0 \pm 0.5$  mVdc at A5TP6.
7. Connect DVM to A3A4TP2 and adjust OFFSET adjustment, A3A4R5, for  $0 \pm 0.5$  mVdc at A3A4TP2.
8. Connect DVM to OUTPUT test point, A5TP2, and adjust AMPLIFIER OFFSET adjustment, A5R8, for  $0 \pm 1.0$  mVdc at A5TP2.
9. Connect DVM to VARACTOR CATHODE test point, A7TP3, and set PEAK DEVIATION switch as shown below. The DVM should read as specified.

PEAK DEVIATION	DVM Reading at A7TP3
2.56 MHz	_____ $< \pm 1.5$ mVdc
1.28 MHz	_____ $< \pm 1.0$ mVdc
640 kHz	_____ $< \pm 0.75$ mVdc
320 kHz	_____ $< \pm 0.50$ mVdc
160 kHz	_____ $< \pm 0.50$ mVdc
80 kHz	_____ $< \pm 0.50$ mVdc
40 kHz	_____ $< \pm 0.50$ mVdc
20 kHz	_____ $< \pm 0.50$ mVdc
10 kHz	_____ $< \pm 0.50$ mVdc
5 kHz	_____ $< \pm 0.50$ mVdc

---

**ADJUSTMENTS**

---

**5-38. PRELIMINARY FM ADJUSTMENTS (Cont'd)**

10. Reset PEAK DEVIATION switch to 2.56 MHz. Turn PEAK DEVIATION vernier and FREQUENCY TUNE control through their ranges. The voltage at A7TP3 should remain less than 1.5 mVdc.

\_\_\_\_\_ 1.5 mVdc

11. Set FM switch to OFF and note frequency displayed on generator's counter. Set FM to DC; the frequency should change less than 800 Hz.

\_\_\_\_\_ 800 Hz

12. To set VAR pot (VARACTOR BIAS), A7R19, connect DVM to VARACTOR ANODE test point, A7TP2, and check that voltage is  $-14.70 \pm 0.01$  Vdc. If it is not, adjust A7R19 until it is.

13. Perform the FM Linearity Adjustment, paragraph 5-39.

---

**5-39. FM LINEARITY ADJUSTMENT****REFERENCE:**

Service Sheet 7.

**DESCRIPTION:**

The positive and negative shaping circuits are adjusted to match the characteristics of the varactors in the RF oscillator. The reference output of a variable-phase generator is used to drive the Signal Generator's FM circuits; its variable phase output is used to drive an oscilloscope's horizontal circuits and the FM linearity circuit. A discriminator is used to demodulate the FM and the demodulated signal is subtracted (i.e., summed  $180^\circ$  out of phase) from the modulation signal in the FM linearity circuit and fed to the oscilloscope's vertical circuits. The shaping circuits are then adjusted for the flattest trace possible on the oscilloscope's display. A reference signal generator and a mixer are used to down-convert the test generator's output to within the range of the discriminator.

**NOTE**

The Preliminary FM Adjustment (5-38) should be made before performing this adjustment.

## ADJUSTMENTS

## 5-39. FM LINEARITY ADJUSTMENT (Cont'd)

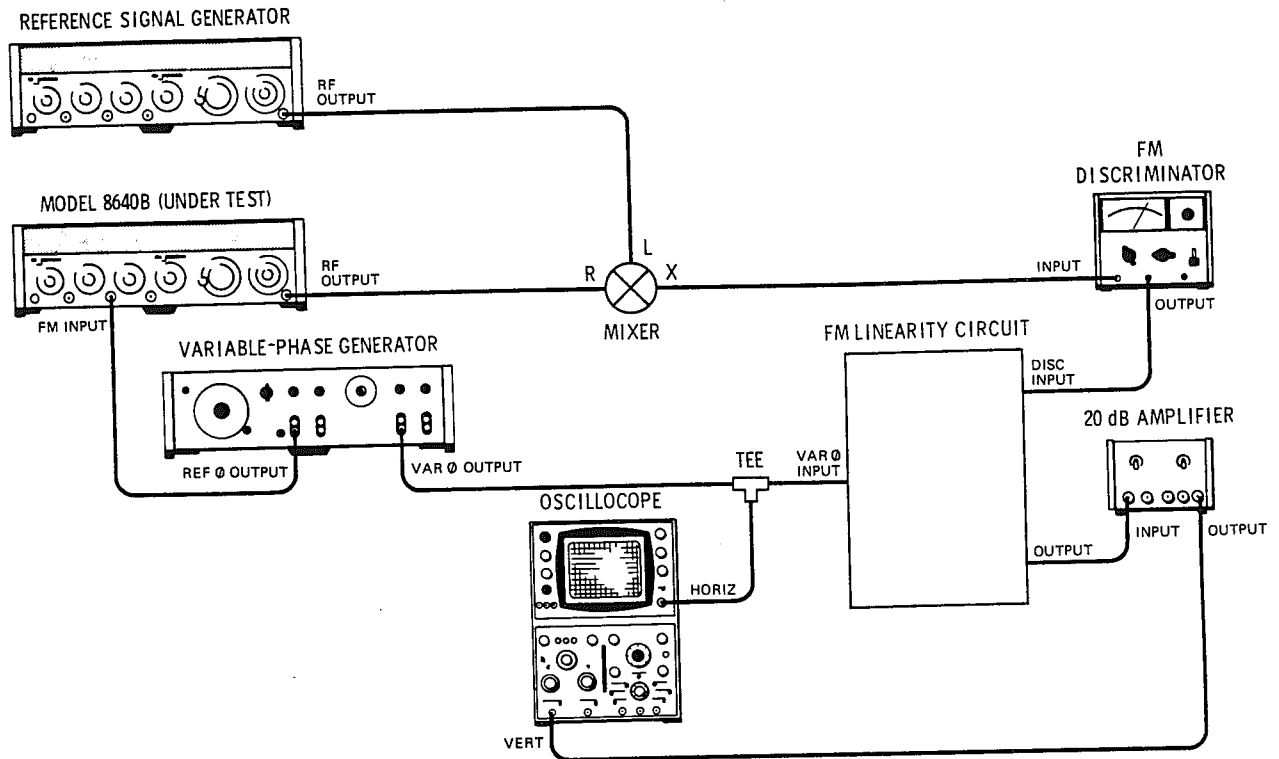

Figure 5-7. FM Linearity Adjustment Test Setup

## EQUIPMENT:

Reference Signal Generator	HP 8640A
Mixer	HP 10514A
FM Discriminator	HP 5210A
Filter Kit (for Discriminator)	HP 10531A
Variable-Phase Generator	HP 203A
Oscilloscope	HP 180A/1801A/1820C
FM Linearity Circuit	HP 08640-60503
20 dB Amplifier	HP 465A

## NOTE

The reference signal generator should have low RF drift, low residual FM (performance approximately equal to the Model 8640A) and be capable of producing 355 MHz at +7 dBm.

ADJUSTMENTS

5-39. FM LINEARITY ADJUSTMENT (Cont'd)

PROCEDURE:

1. Connect equipment as shown in Figure 5-7 after setting Signal Generator's controls as follows:

Meter Function	.....	FM
COUNTER MODE: EXPAND	.....	Off
LOCK	.....	Off
Source	.....	INT
AM	.....	OFF
FM	.....	AC
PEAK DEVIATION	.....	2.56 kHz
PEAK DEVIATION Vernier	.....	Full cw
RANGE	.....	256 - 512 MHz
FREQUENCY TUNE	.....	360 MHz
OUTPUT LEVEL	.....	-7 dBm
RF ON/OFF	.....	ON

NOTE

If it is desired to optimize FM linearity at a frequency other than mid-band, proceed as follows:

- a. Set RANGE and FREQUENCY TUNE to the desired frequency.
  - b. Set RANGE to 256 - 512 MHz.
  - c. Set the reference signal generator 5 MHz below the test generator's output frequency.
2. Set reference signal generator for a 355 MHz, CW signal at +7 dBm.
  3. Calibrate the discriminator; prepare a 25 kHz filter (from the filter kit) and install it in the discriminator. Set FM linearity circuit's var  $\phi$  on/off switch to off. Adjust variable-phase generator's variable phase output's amplitude and the oscilloscope's horizontal gain for full screen deflection on the display. Adjust reference signal generator for 5 MHz on the discriminator.
  4. Set variable-phase generator's reference phase output for a 1 kHz signal at an amplitude that gives a 2.56 MHz peak deviation indication on the Signal Generator's panel meter. Set linearity circuit's voltage divider switch to 100. Adjust generator's variable phase output's phase for a straight line on the display as shown in Figure 5-8. Adjust oscilloscope's vertical gain for  $\pm 1$  division at edge of display.



## ADJUSTMENTS

## 5-39. FM LINEARITY ADJUSTMENT (Cont'd)

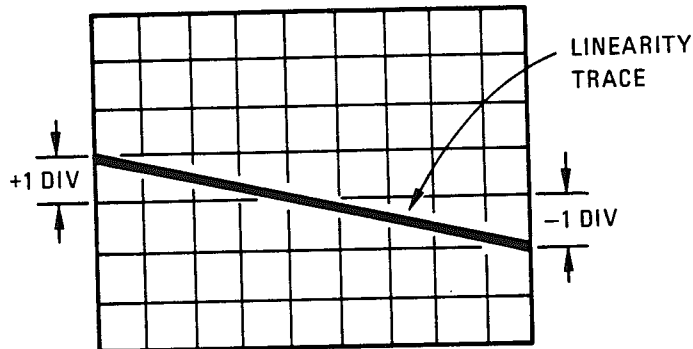

Figure 5-8. FM Linearity Display

5. Set linearity circuit's var  $\phi$  on/off switch to on and the voltage divider switch to 1. This calibrates the display for 1% error in linearity per division.
6. Adjust variable-phase generator's variable phase output's phase and linearity circuit's var  $\phi$  gain control for the best possible horizontal straight line over *center* portion of trace.
7. Adjust POS SHAPING and NEG SHAPING adjustments, A7R12 and A7R41, for the best possible horizontal straight line at both ends of the trace (but within  $\pm$  one major division or  $\pm 1\%$ ).
8. Perform the FM Sensitivity Adjustment, paragraph 5-40.

## 5-40. FM SENSITIVITY ADJUSTMENT

## REFERENCE:

Service Sheets 6 and 7.

## DESCRIPTION:

The Signal Generator is frequency modulated with an accurate, 1 Vpk, 16.63 kHz signal. The modulated RF output is monitored on a spectrum analyzer and FM sensitivity is adjusted for the first carrier (Bessel) null. The adjustments are made at mid-band and at both band ends. (Peak deviation =  $2.405 \times f_{\text{mod}}$  at first carrier null.)

## NOTE

The FM Linearity Adjustment (5-39) should be made before performing this adjustment.

ADJUSTMENTS

5-40. FM SENSITIVITY ADJUSTMENT (Cont'd)

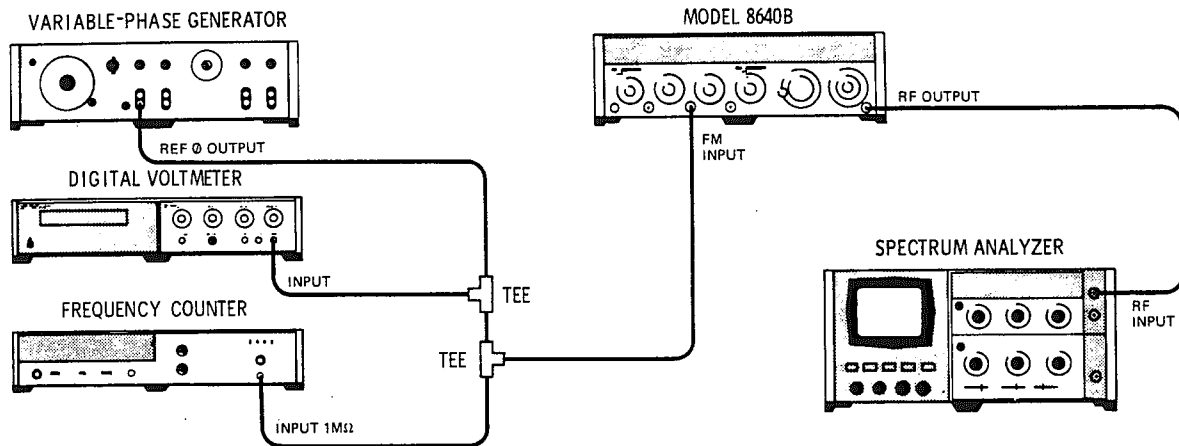

Figure 5-9. FM Sensitivity Adjustment Test Setup

EQUIPMENT:

Variable-Phase Generator	.....	HP 203A
Digital Voltmeter	.....	HP 3480B/3484A
Frequency Counter	.....	HP 5327C
Spectrum Analyzer	.....	HP 141T/8552B/8553B

PROCEDURE:

1. Connect equipment as shown in Figure 5-9 after setting Signal Generator's controls as follows:

Meter Function	.....	FM
COUNTER MODE: EXPAND	.....	Off
LOCK	.....	Off
Source	.....	INT
AM	.....	OFF
FM	.....	OFF
PEAK DEVIATION	.....	40 kHz
PEAK DEVIATION Vernier	.....	Full cw
RANGE	.....	16 - 32 MHz
FREQUENCY TUNE	.....	24 MHz
OUTPUT LEVEL	.....	-37 dBm
RF ON/OFF	.....	ON

2. Set spectrum analyzer's center frequency to 24 MHz, resolution bandwidth to 3 kHz frequency span (scan width) per division to 20 kHz, and input attenuation to 0 dB. Center signal on display and use reference level controls (set for 10 dB/division) to set signal peak to top (0 dB reference) graticule line on display.

---

**ADJUSTMENTS**

---

**5-40. FM SENSITIVITY ADJUSTMENT (Cont'd)**

3. Set Signal Generator's FM switch to AC. Adjust variable-phase generator for a frequency counter reading of 16.63 kHz at 707 mVrms as read on DVM.
4. Adjust MID FM SENS adjustment, A3A4R3, for at least 50 dB of carrier null.

**NOTE**

The carrier is the center spectrum line on the display. A 50 dB null is when it drops 50 dB below its CW amplitude (set in step 2).

5. Set Signal Generator's FREQUENCY TUNE to 16 MHz. Adjust analyzer to center the carrier on the display. Adjust LOW FM SENS adjustment, A3A4R2 for at least 50 dB of carrier null.
6. Set Signal Generator's FREQUENCY TUNE to 32 MHz. Adjust analyzer to center the carrier on the display. Adjust HI FM SENS adjustment, A3A4R4, for at least 50 dB of carrier null.
7. Repeat steps 4 through 6 until carrier null is  $\geq 50$  dB at 16, 24, and 32 MHz.
8. Perform the FM distortion and FM sensitivity and accuracy tests in Section IV.

---

**5-41. INTERNAL REFERENCE FREQUENCY ADJUSTMENT****REFERENCE:**

Service Sheet 19.

**DESCRIPTION:**

An oscilloscope is used to display a Lissajous figure (2:1) to set the internal reference frequency. The Lissajous figure is derived from the 10 MHz reference of a frequency counter and the Signal Generator's 5 MHz internal reference. This procedure should be performed whenever the internal reference is found to be out of specification.

ADJUSTMENTS

5-41. INTERNAL REFERENCE FREQUENCY ADJUSTMENT (Cont'd)

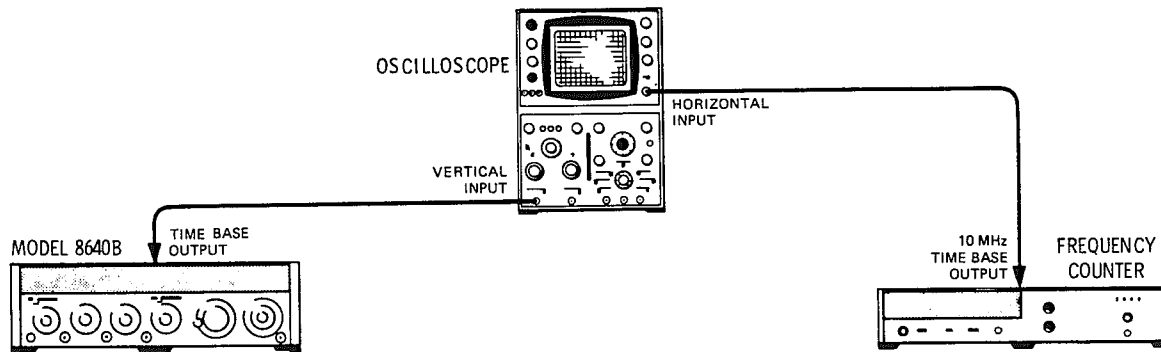

Figure 5-10. Internal Reference Frequency Adjustment Test Setup

EQUIPMENT:

Frequency Counter . . . . . HP 5327C OPT H49  
 Oscilloscope . . . . . HP 180A/1801A/1820C

PROCEDURE:

1. Remove trim strip that holds front panel window in place. Gently pull window up and out and remove it. Allow generator to warm up for 2 hours.
2. Connect equipment as shown in Figure 5-10 after setting Signal Generator's controls as follows:

TIME BASE REF INT/EXT (on rear panel) . . . . . INT  
 TIME BASE VERNIER . . . . . CAL

3. Set oscilloscope's vertical sensitivity to 0.05 V/div (ac) and horizontal scale for external ac. Set magnifier for X 10 and adjust oscilloscope's controls for a Lissajous figure.
4. Adjust time base adjustment pot (available through the hole in the front of the counter casting) for a stable 2:1 Lissajous figure (it will look approximately like a figure eight on its side).
5. Replace front panel window and trim strip.



## SECTION VI

### REPLACEABLE PARTS

#### 6-1. INTRODUCTION

6-2. This section contains information for ordering parts. Table 6-2 lists abbreviations used in the parts list and throughout the manual. Table 6-3 lists all replaceable parts in reference designator order. Table 6-4 contains the names and addresses that correspond to the manufacturer's code numbers.

#### 6-3. EXCHANGE ASSEMBLIES

6-4. Table 6-1 lists assemblies within the instrument that may be replaced on an exchange basis, thus affording a considerable cost saving. Exchange, factory-repaired and tested assemblies are available only on a trade-in basis; therefore, the defective assemblies must be returned for credit. For this reason, assemblies required for spare parts stock must be ordered by the new assembly part number.

#### 6-5. ABBREVIATIONS

6-6. Table 6-2 lists abbreviations used in the parts list, schematics and throughout the manual. In some cases, two forms of the abbreviation are used, one all in capital letters, and one partial or no capitals. This occurs because the abbreviations in the parts list are always all capitals. However, in the schematics and other parts of the manual, other abbreviation forms are used with both lower case and upper case letters.

#### 6-7. REPLACEABLE PARTS LIST

6-8. Table 6-3 is the list of replaceable parts and is organized as follows:

- a. Electrical assemblies and their components in alpha-numerical order by reference designation.
- b. Chassis-mounted parts in alpha-numerical order by reference designation.
- c. Miscellaneous parts.

6-9. The information given for each part consist of the following:

- a. The Hewlett-Packard part number.
- b. The total quantity (Qty) in the instrument.
- c. The description of the part.
- d. A typical manufacturer of the part in a five-digit code.
- e. The manufacturer's number for the part.

6-10. The total quantity for each part is given only once - at the first appearance of the part number in the list.

#### NOTE

Total quantities for optional assemblies are totaled by assembly and not integrated into the standard list.

#### 6-11. ORDERING INFORMATION

6-12. To order a part listed in the replaceable parts table, quote the Hewlett-Packard part number, indicate the quantity required, and address the order to the nearest Hewlett-Packard office.

6-13. To order a part that is not listed in the replaceable parts table, include the instrument model number, instrument serial number, the description and function of the part, and the number of parts required. Address the order to the nearest Hewlett-Packard office.

#### 6-14. SPARE PARTS KIT

6-15. Stocking spare parts for an instrument is often done to insure quick return to service after a malfunction occurs. Hewlett-Packard has a "Spare Parts Kit" available for this purpose. The kit consists of selected replaceable assemblies and components for this instrument. The contents of the kit and the "Recommended Spares" list are based on failure reports and repair data, and parts

support for one year. A complimentary "Recommended Spares" list for this instrument may be obtained on request and the "Spare Parts Kit" may be ordered through your nearest Hewlett-Packard office.

**6-16. ILLUSTRATED PARTS BREAKDOWNS**

6-17. Illustrated Parts Breakdowns for the following assemblies are given on the alphabetic foldout pages in this manual (located after the numbered, schematic foldouts):

- A1 Output Level Assembly
- A8 Counter/Lock Assembly
- A9 Peak Deviation and Range Switch Assembly
- A10 Divider/Filter Assembly
- A11 Variable-Frequency Modulation Oscillator Assembly (Option 001)
- A26 AM/AGC and RF Amplifier Assembly

6-18. Figures 6-1 and 6-2 are breakdowns of the generator's cabinet parts and the parts that comprise the Type N connector, J1.

*Table 6-1. Part Numbers for Exchange Assemblies*

Reference Designation	Description	Part Number	
		Exchange Assy	New Assy
A1	Output Level Assy	08640-60081	08640-60113
A3	RF Oscillator Assy	08640-60079	08640-60100
A5	FM Amplifier Assy	08640-60085	08640-60029
A7	FM Shaping Assy	08640-60084	08640-60046†
A8A1	RF Scaler Assy	08640-60083	08640-60168†
A8A2	Counter/Lock Board Assy	08640-60087	08640-60027
A8A3	Time Base Assy	08640-60090	08640-60026
A9	Peak Deviation and Range Switch Assy	08640-60082	08640-60117
A10A1	RF Filter Assy	08640-60091	08640-60021
A10A2	RF Divider Assy	08640-60092	08640-60023
A11	Variable-Frequency Modulation Oscillator Assy (Option 001)	08640-60089	08640-60019
A26A1	Power Amplifier and AGC Detector Assy	08640-60088	08640-60017
A26A4	AGC Amplifier Assy	08640-60086	08640-60015

† See Tables 7-1 and 7-2 for backdating.

Table 6-2. Reference Designations and Abbreviations (1 of 2)

REFERENCE DESIGNATIONS

A . . . . . assembly	E . . . . . miscellaneous electrical part	P . . . . . electrical connector (movable portion); plug	U . . . . . integrated circuit; microcircuit
AT . . . . . attenuator; isolator; termination	F . . . . . fuse	Q . . . . . transistor: SCR; triode thyristor	V . . . . . electron tube
B . . . . . fan; motor	FL . . . . . filter	R . . . . . resistor	VR . . . . . voltage regulator; breakdown diode
BT . . . . . battery	H . . . . . hardware	RT . . . . . thermistor	W . . . . . cable; transmission path; wire
C . . . . . capacitor	HY . . . . . circulator	S . . . . . switch	X . . . . . socket
CP . . . . . coupler	J . . . . . electrical connector (stationary portion); jack	T . . . . . transformer	Y . . . . . crystal unit (piezo-electric or quartz)
CR . . . . . diode; diode thyristor; varactor	K . . . . . relay	TB . . . . . terminal board	Z . . . . . tuned cavity; tuned circuit
DC . . . . . directional coupler	L . . . . . coil; inductor	TC . . . . . thermocouple	
DL . . . . . delay line	M . . . . . meter	TP . . . . . test point	
DS . . . . . annunciator; signaling device (audible or visual); lamp; LED	MP . . . . . miscellaneous mechanical part		

ABBREVIATIONS

A . . . . . ampere	COEF . . . . . coefficient	EDP . . . . . electronic data processing	INT . . . . . internal
ac . . . . . alternating current	COM . . . . . common	ELECT . . . . . electrolytic	kg . . . . . kilogram
ACCESS . . . . . accessory	COMP . . . . . composition	ENCAP . . . . . encapsulated	kHz . . . . . kilohertz
ADJ . . . . . adjustment	COMPL . . . . . complete	EXT . . . . . external	kΩ . . . . . kilohm
A/D . . . . . analog-to-digital	CONN . . . . . connector	F . . . . . farad	kV . . . . . kilovolt
AF . . . . . audio frequency	CP . . . . . cadmium plate	FET . . . . . field-effect transistor	lb . . . . . pound
AFC . . . . . automatic frequency control	CRT . . . . . cathode-ray tube	F/F . . . . . flip-flop	LC . . . . . inductance-capacitance
AGC . . . . . automatic gain control	CTL . . . . . complementary transistor logic	FH . . . . . flat head	LED . . . . . light-emitting diode
AL . . . . . aluminum	CW . . . . . continuous wave	FIL H . . . . . fillister head	LF . . . . . low frequency
ALC . . . . . automatic level control	cw . . . . . clockwise	FM . . . . . frequency modulation	LG . . . . . long
AM . . . . . amplitude modulation	cm . . . . . centimeter	FP . . . . . front panel	LH . . . . . left hand
AMPL . . . . . amplifier	D/A . . . . . digital-to-analog	FREQ . . . . . frequency	LIM . . . . . limit
APC . . . . . automatic phase control	dB . . . . . decibel	FXD . . . . . fixed	LIN . . . . . linear taper (used in parts list)
ASSY . . . . . assembly	dBm . . . . . decibel referred to 1 mW	g . . . . . gram	lin . . . . . linear
AUX . . . . . auxiliary	dc . . . . . direct current	GE . . . . . germanium	LK WASH . . . . . lock washer
avg . . . . . average	deg . . . . . degree (temperature interval or difference)	GHz . . . . . gigahertz	LO . . . . . low; local oscillator
AWG . . . . . American wire gauge	° . . . . . degree (plane angle)	GL . . . . . glass	LOG . . . . . logarithmic taper (used in parts list)
BAL . . . . . balance	°C . . . . . degree Celsius (centigrade)	GRD . . . . . ground(ed)	log . . . . . logarithm(ic)
BCD . . . . . binary coded decimal	°F . . . . . degree Fahrenheit	H . . . . . henry	LPF . . . . . low pass filter
BD . . . . . board	°K . . . . . degree Kelvin	h . . . . . hour	LV . . . . . low voltage
BE CU . . . . . beryllium copper	DEPC . . . . . deposited carbon	HET . . . . . heterodyne	m . . . . . meter (distance)
BFO . . . . . beat frequency oscillator	DET . . . . . detector	HEX . . . . . hexagonal	mA . . . . . milliamperes
BH . . . . . binder head	diam . . . . . diameter	HD . . . . . head	MAX . . . . . maximum
BKDN . . . . . breakdown	DIA . . . . . diameter (used in parts list)	HDW . . . . . hardware	MΩ . . . . . megohm
BP . . . . . bandpass	DIFF AMPL . . . . . differential amplifier	HF . . . . . high frequency	MEG . . . . . meg (10 <sup>6</sup> ) (used in parts list)
BPF . . . . . bandpass filter	div . . . . . division	HG . . . . . mercury	MET FLM . . . . . metal film
BRS . . . . . brass	DPDT . . . . . double-pole, double-throw	HI . . . . . high	MET OX . . . . . metallic oxide
BWO . . . . . backward-wave oscillator	DR . . . . . drive	HP . . . . . Hewlett-Packard	MF . . . . . medium frequency; microfarad (used in parts list)
CAL . . . . . calibrate	DSB . . . . . double sideband	HPF . . . . . high pass filter	MFR . . . . . manufacturer
ccw . . . . . counter-clockwise	DTL . . . . . diode transistor logic	HR . . . . . hour (used in parts list)	mg . . . . . milligram
CER . . . . . ceramic	DVM . . . . . digital voltmeter	HV . . . . . high voltage	MHz . . . . . megahertz
CHAN . . . . . channel	ECL . . . . . emitter coupled logic	Hz . . . . . Hertz	mH . . . . . millihenry
cm . . . . . centimeter	EMF . . . . . electromotive force	IC . . . . . integrated circuit	mho . . . . . mho
CMO . . . . . cabinet mount only		ID . . . . . inside diameter	MIN . . . . . minimum
COAX . . . . . coaxial		IF . . . . . intermediate frequency	min . . . . . minute (time)
		IMPG . . . . . impregnated	' . . . . . minute (plane angle)
		in . . . . . inch	MINAT . . . . . miniature
		INCD . . . . . incandescent	mm . . . . . millimeter
		INCL . . . . . include(s)	
		INP . . . . . input	
		INS . . . . . insulation	

NOTE

All abbreviations in the parts list will be in upper-case.



Table 6-2. Reference Designations and Abbreviations (2 of 2)

MOD . . . . . modulator	OD . . . . . outside diameter	PWV . . . . . peak working voltage	TD . . . . . time delay
MOM . . . . . momentary	OH . . . . . oval head	RC . . . . . resistance-capacitance	TERM . . . . . terminal
MOS . . . . . metal-oxide semiconductor	OP AMPL . . . . . operational amplifier	RECT . . . . . rectifier	TFT . . . . . thin-film transistor
ms . . . . . millisecond	OPT . . . . . option	REF . . . . . reference	TGL . . . . . toggle
MTG . . . . . mounting	OSC . . . . . oscillator	REG . . . . . regulated	THD . . . . . thread
MTR . . . . . meter (indicating device)	OX . . . . . oxide	REPL . . . . . replaceable	THRU . . . . . through
mV . . . . . millivolt	oz . . . . . ounce	RF . . . . . radio frequency	TI . . . . . titanium
mVac . . . . . millivolt, ac	$\Omega$ . . . . . ohm	RFI . . . . . radio frequency interference	TOL . . . . . tolerance
mVdc . . . . . millivolt, dc	P . . . . . peak (used in parts list)	RH . . . . . round head; right hand	TRIM . . . . . trimmer
mVpk . . . . . millivolt, peak	PAM . . . . . pulse-amplitude modulation	RLC . . . . . resistance-inductance-capacitance	TSTR . . . . . transistor
mVp-p . . . . . millivolt, peak-to-peak	PC . . . . . printed circuit	RMO . . . . . rack mount only	TTL . . . . . transistor-transistor logic
mVrms . . . . . millivolt, rms	PCM . . . . . pulse-code modulation; pulse-count modulation	rms . . . . . root-mean-square	TV . . . . . television
mW . . . . . milliwatt	PDM . . . . . pulse-duration modulation	RND . . . . . round	TVI . . . . . television interference
MUX . . . . . multiplex	pF . . . . . picofarad	ROM . . . . . read-only memory	TWT . . . . . traveling wave tube
MY . . . . . mylar	PH BRZ . . . . . phosphor bronze	R&P . . . . . rack and panel	U . . . . . micro ( $10^6$ ) (used in parts list)
$\mu$ A . . . . . microampere	PHL . . . . . Phillips	RWV . . . . . reverse working voltage	UF . . . . . microfarad (used in parts list)
$\mu$ F . . . . . microfarad	PIN . . . . . positive-intrinsic-negative	S . . . . . scattering parameter	UHF . . . . . ultrahigh frequency
$\mu$ H . . . . . microhenry	PIV . . . . . peak inverse voltage	s . . . . . second (time)	UNREG . . . . . unregulated
$\mu$ mho . . . . . micromho	pk . . . . . peak	" . . . . . second (plane angle)	V . . . . . volt
$\mu$ s . . . . . microsecond	PL . . . . . phase lock	S-B . . . . . slow-blow (fuse) (used in parts list)	VA . . . . . voltampere
$\mu$ V . . . . . microvolt	PLO . . . . . phase lock oscillator	SCR . . . . . silicon controlled rectifier; screw	Vac . . . . . volts, ac
$\mu$ Vac . . . . . microvolt, ac	PM . . . . . phase modulation	SE . . . . . selenium	VAR . . . . . variable
$\mu$ Vdc . . . . . microvolt, dc	PNP . . . . . positive-negative-positive	SECT . . . . . sections	VCO . . . . . voltage-controlled oscillator
$\mu$ Vpk . . . . . microvolt, peak	P/O . . . . . part of	SEMICON . . . . . semiconductor	Vdc . . . . . volts, dc
$\mu$ Vp-p . . . . . microvolt, peak-to-peak	POLY . . . . . polystyrene	SHF . . . . . superhigh frequency	VDCW . . . . . volts, dc, working (used in parts list)
$\mu$ Vrms . . . . . microvolt, rms	PORC . . . . . porcelain	SI . . . . . silicon	V(F) . . . . . volts, filtered
$\mu$ W . . . . . microwatt	POS . . . . . positive; position(s) (used in parts list)	SIL . . . . . silver	VFO . . . . . variable-frequency oscillator
nA . . . . . nanoampere	POSN . . . . . position	SL . . . . . slide	VHF . . . . . very-high frequency
NC . . . . . no connection	POT . . . . . potentiometer	SNR . . . . . signal-to-noise ratio	Vpk . . . . . volts, peak
NE . . . . . neon	p-p . . . . . peak-to-peak	SPDT . . . . . single-pole, double-throw	Vp-p . . . . . volts, peak-to-peak
NEG . . . . . negative	PP . . . . . peak-to-peak (used in parts list)	SPG . . . . . spring	Vrms . . . . . volts, rms
nF . . . . . nanofarad	PPM . . . . . pulse-position modulation	SR . . . . . split ring	VSWR . . . . . voltage standing wave ratio
NI PL . . . . . nickel plate	PREAMPL . . . . . preamplifier	SPST . . . . . single-pole, single-throw	VTO . . . . . voltage-tuned oscillator
N/O . . . . . normally open	PRF . . . . . pulse-repetition frequency	SSB . . . . . single sideband	VTVM . . . . . vacuum-tube voltmeter
NOM . . . . . nominal	PRR . . . . . pulse repetition rate	SST . . . . . stainless steel	V(X) . . . . . volts, switched
NORM . . . . . normal	ps . . . . . picosecond	STL . . . . . steel	W . . . . . watt
NPN . . . . . negative-positive-negative	PT . . . . . point	SQ . . . . . square	W/ . . . . . with
NPO . . . . . negative-positive zero (zero temperature coefficient)	PTM . . . . . pulse-time modulation	SWR . . . . . standing-wave ratio	WIV . . . . . working inverse voltage
NRFR . . . . . not recommended for field replacement	PWM . . . . . pulse-width modulation	SYNC . . . . . synchronize	WW . . . . . wirewound
NSR . . . . . not separately replaceable		T . . . . . timed (slow-blow fuse)	W/O . . . . . without
ns . . . . . nanosecond		TA . . . . . tantalum	YIG . . . . . yttrium-iron-garnet
nW . . . . . nanowatt		TC . . . . . temperature compensating	Z <sub>0</sub> . . . . . characteristic impedance
OBD . . . . . order by description			

NOTE

All abbreviations in the parts list will be in upper-case.

MULTIPLIERS

Abbreviation	Prefix	Multiple
T	tera	10 <sup>12</sup>
G	giga	10 <sup>9</sup>
M	mega	10 <sup>6</sup>
k	kilo	10 <sup>3</sup>
da	deka	10
d	deci	10 <sup>-1</sup>
c	centi	10 <sup>-2</sup>
m	milli	10 <sup>-3</sup>
$\mu$	micro	10 <sup>-6</sup>
n	nano	10 <sup>-9</sup>
p	pico	10 <sup>-12</sup>
f	femto	10 <sup>-15</sup>
a	atto	10 <sup>-18</sup>

Table 6-3. Replaceable Parts

Reference Designation	HP Part Number	Qty	Description	Mfr Code	Mfr Part Number
A1	08640-60113	1	OUTPUT LEVEL ASSY	28480	08640-60113
A1	08640-60081		REBUILT 08640-60113, REQUIRES EXCHANGE	28480	08640-60081
A1MP1	0380-0021	4	SPACER, ROUND, .312 L	76854	3457-420
A1MP2	0380-0029	2	SPACER, POST TYPE STL 1.000" LG	00000	0BD
A1MP3	0510-1176	2	SCREW: THREADED STRUTT	00000	0BD
A1MP4	0540-0002	2	NUT: HEX 5-40 .094 X .188" LG	76854	22041-255
A1MP5	1430-0760	2	GEAR SPUR	28480	1430-0760
A1MP6			NOT ASSIGNED		
A1MP7	2190-0020	2	WASHER; LOCK; HELICAL; 5 .128 ID .239	28480	2190-0020
A1MP8	3130-0445	1	SWITCH, SGL SECT	28480	3130-0445
A1MP9	3130-0446	1	SWITCH, SGL SECT	28480	3130-0446
A1MP10	3130-0455	1	SHAFT ASSY: INNER 0.125" DIA	76854	A-3130-9008
A1MP11	5040-0218	2	COUPLER: SWITCH SHAFT	28480	5040-0218
A1MP12	08640-00020	1	SUPPORT: PC BOARD	28480	08640-00020
A1MP13	08640-00023	1	SUPPORT: GEAR ASSY: ATTENUATOR	28480	08640-00023
A1MP14	08640-20087	1	SUPPORT: ATTENUATOR	28480	08640-20087
A1MP15	08640-20205	3	GEAR SPUR	28480	08640-20205
A1MP16	08640-20208	1	SHAFT GEAR	28480	08640-20208
A1MP17			NOT ASSIGNED		
A1MP18			NOT ASSIGNED		
A1MP19	1480-0082	1	PIN: SPIROL	00287	TYPE 302
A1MP20	2190-0016	2	WASHER; LOCK; INT .377 ID .507 OD	78189	1920-02
A1MP21	2190-0019	16	WASHER; LOCK; HELICAL; 4 .115 ID .226	28480	2190-0019
A1MP22	2200-0109	4	SCREW; MACHINE; 4-40 UNC-2A .438 IN PAN	28480	2200-0109
A1MP23	2200-0141	2	SCREW; MACHINE; 4-40 UNC-2A .312 IN PAN	28480	2200-0141
A1MP24	2200-0167	4	SCREW; MACHINE; 4-40 UNC-2A .375 IN 82	28480	2200-0167
A1MP25	2950-0001	2	NUT, HEX 3/8-32 .094 X .5, BRS, NI PL	12697	
A1MP26	3030-0007	16	SCREW; SET; 4-40 UNC-3A .125 IN	28480	3030-0007
A1MP27	3050-0105	2	WASHER; FLAT; 4 .125 ID .281 OD	28480	3050-0105
A1R1A	2100-3292	1	R: VAR CERMET 1K OHM (INCLUDES A1R1B, NSR)	28480	2100-3292
A1R1B			(PART OF A1R1A, NSR)		
A1A1	08640-60010	1	RF VERNIER ASSY	28480	08640-60010
A1A1R1	0698-7532	1	RESISTOR; FXD; 100 OHM .25% .125W F	30983	MF4C1/8-T0-100R-C
A1A1R2	0698-7794	1	RESISTOR; FXD; 10K .25% .125W F TUBULAR	30983	MF4C1/8-T0-1002-C
A1A1R3	0698-3449	3	RESISTOR; FXD; 28.7K1% .125W F TUBULAR	16299	C4-1/8-T0-2872-F
A1A1R4	0757-0280	26	RESISTOR; FXD; 1K1% .125W F TUBULAR	24546	C4-1/8-T0-1001-F
A1A1R5	2100-2521	7	RESISTOR, VAR, TRMR, 2KOHM 10% C	19701	ET50X202
A1A1R6	2100-2521	7	RESISTOR, VAR, TRMR, 2KOHM 10% C	19701	ET50X202
A1A2	08640-60144	1	OUTPUT ATTENUATOR ASSY	28480	08640-60144
A2	08640-60031	1	METER SWITCH/DETECTOR ASSY	28480	08640-60031
A2C1	0160-0128	1	CAPACITOR; FXD; 2.2UF+-20% 25WVDC	28480	0160-0128
A2C2	0180-1746	4	CAPACITOR; FXD; 15UF+-10% 20VDC TA-SOLID	56289	150D156X902082
A2C3	0160-2199	5	CAPACITOR; FXD; 30PF+-5% 300WVDC	28480	0160-2199
A2C4	0180-1746		CAPACITOR; FXD; 15UF+-10% 20VDC TA-SOLID	56289	150D156X902082
A2C5	0180-2207	3	CAPACITOR; FXD; 100UF+-10% 10VDC TA	56289	150D107X9010R2
A2CR1	1901-0040	39	DIGDE; SWITCHING; S1; 30V MAX VRM 50MA	28480	1901-0040
A2MP1	4040-0749	4	EXTRACTOR: PC BOARD, BROWN	28480	4040-0749
	1480-0073	16	PIN: DRIVE 0.250" LG	00000	0BD
A2R1	0698-7095	1	RESISTOR; FXD; 11K .25% .125W F TUBULAR	19701	MF4C1/8-T2-1102-C
A2R2	0698-3160	5	RESISTOR; FXD; 31.6K1% .125W F TUBULAR	16299	C4-1/8-T0-3162-F
A2R3	0698-3160		RESISTOR; FXD; 31.6K1% .125W F TUBULAR	16299	C4-1/8-T0-3162-F
A2R4	0757-0442	42	RESISTOR; FXD; 10K1% .125W F TUBULAR	24546	C4-1/8-T0-1002-F
A2R5	2100-2633	1	RESISTOR, VAR, TRMR, 1KOHM 10% C	19701	ET50X102
A2R6	0698-3440	7	RESISTOR; FXD; 196 OHM1% .125W F	16299	C4-1/8-T0-196R-F
A2R7	0698-3460	1	RESISTOR; FXD; 422K1% .125W F TUBULAR	19701	MF4C1/8-T0-4223-F
A2R8	0757-0279	8	RESISTOR; FXD; 3.16K1% .125W F TUBULAR	24546	C4-1/8-T0-3161-F
A2R9	0757-0420	7	RESISTOR; FXD; 750 OHM1% .125W F	24546	C4-1/8-T0-751-F
A2R10	0698-3157	2	RESISTOR; FXD; 19.6K1% .125W F TUBULAR	16299	C4-1/8-T0-1962-F
A2R11	0757-0398	4	RESISTOR; FXD; 75 OHM1% .125W F TUBULAR	24546	C4-1/8-T0-75R0-F
A2S1A	3101-1728	3	SWITCH, PB -STA DPDT (INCLUDES A2S1B, C, NSR)	28480	3101-1728
A2S1B			SWITCH, PB -STA DPDT (PART OF A2S1A, NSR)	28480	3101-1728
A2S1C			SWITCH, PB -STA DPDT (PART OF A2S1A, NSR)		

See introduction to this section for ordering information

Table 6-3. Replaceable Parts

Reference Designation	HP Part Number	Qty	Description	Mfr Code	Mfr Part Number
A2TP1	0360-1514	88	TERMINAL, SLDR STUD	28480	0360-1514
A2TP2	0360-1514		TERMINAL, SLDR STUD	28480	0360-1514
A2TP3	0360-1514		TERMINAL, SLDR STUD	28480	0360-1514
A2TP4	0360-1514	3	TERMINAL, SLDR STUD	28480	0360-1514
A2TP5	0360-1514		TERMINAL, SLDR STUD	28480	0360-1514
A2U1	1820-0158		IC;LIN;MISCELLANEOUS (LINEAR)	27014	LM302H
A2U2	1820-0476		IC;LIN;OPERATIONAL AMPLIFIER	07263	715HC
A2VR1	1902-0025		DIODE; ZENER; 10V VZ; .4W MAX PD	04713	SZ 10939-182
A2VR2	1902-3104		DIODE; ZENER; 5.62V VZ; .4W MAX PD	04713	SZ 10939-110
A3	08640-60100	1	RF OSCILLATOR ASSY	28480	08640-60100
A3	08640-60079		REBUILT 08640-60100, REQUIRES EXCHANGE	28480	08640-60079
A3MP1	3030-0007	2	SCREW;SET; 4-40 UNC-3A .125 IN	28480	3030-0007
A3MP2	3030-0007		SCREW;SET; 4-40 UNC-3A .125 IN	28480	3030-0007
A3MP3	3030-0007		SCREW;SET; 4-40 UNC-3A .125 IN	28480	3030-0007
A3MP4	3030-0007		SCREW;SET; 4-40 UNC-3A .125 IN	28480	3030-0007
A3MP5	3030-0007		SCREW;SET; 4-40 UNC-3A .125 IN	28480	3030-0007
A3MP6	3030-0007		SCREW;SET; 4-40 UNC-3A .125 IN	28480	3030-0007
A3MP7	0510-0005		RETAINER, RING, .25 DIA, CAD PLT STL	79136	5100-25-5-MD
A3MP8	0510-0005		RETAINER, RING, .25 DIA, CAD PLT STL	79136	5100-25-5-MD
A3MP9	1430-0759	3	GEAR SPUR	28480	1430-0759
A3MP10	1430-0759		GEAR SPUR	28480	1430-0759
A3MP11	08640-20106	2	BUSHING;PDT	28480	08640-20106
A3MP12	08640-20106		BUSHING;PDT	28480	08640-20106
A3MP13	08640-40036	1	FINE TUNE SHAFT	28480	08640-40036
A3MP14	08640-20118	1	CAP;TRANSISTOR	28480	08640-20118
A3MP15	1400-0024	1	CLAMP, CABLE, .25 DIA .5 W NYL	95987	WC46NA
A3MP16	08640-00036	1	SUPPRT;P.C. BOARD	28480	08640-00036
A3R1	2100-3265	1	RESISTOR, VAR, CONT, 10K 20% C	28480	2100-3265
A3R2 †	2100-0541	1	RESISTOR, VAR, CONT, PREC, 1K 3% NOTE: WHEN REPLACING A3R1,R2, ALSO REPLACE BUSHING A3MP11 OR MP12 AND WASHER (2190-0016).	28480	2100-0541
A3A4 †	08640-60040	1	CONNECTOR BOARD ASSY	28480	08640-60040
A3A4C1	0160-2055	38	CAPACITOR,FXD, .01UF+80-20% 100WVDC	28480	0160-2055
A3A4C2	0160-2055		CAPACITOR,FXD, .01UF+80-20% 100WVDC	28480	0160-2055
A3A4R1	2100-3161		RESISTOR,VAR,TRMR 20K OHM 10% C	32997	3006P-1-203
A3A4R2 †	2100-3109	4	RESISTOR,VAR,TRMR 2K OHM 10% C	32997	3006P-1-202
A3A4R3	2100-3109		RESISTOR,VAR,TRMR 2K OHM 10% C	32997	3006P-1-202
A3A4R4	2100-3154	4	RESISTOR,VAR,TRMR 1K OHM 10% C	32997	3006P-1-102
A3A4R5	2100-3154		RESISTOR,VAR,TRMR 1K OHM 10% C	32997	3006P-1-102
A3A4R6	0757-0442	3	RESISTOR; FXD; 10K1% .125W F TUBULAR	24546	C4-1/8-T0-1002-F
A3A4R7	0757-0420		RESISTOR; FXD; 750 OHM1% .125W F	24546	C4-1/8-T0-751-F
A3A4R8	0698-0084		RESISTOR; FXD; 2.15K1% .125W F TUBULAR	16299	C4-1/8-T0-2151-F
A3A4R9	0757-0416		RESISTOR; FXD; 511 OHM1% .125W F	24546	C4-1/8-T0-511R-F
A3A4U1	1820-0158	17	IC;LIN;MISCELLANEOUS (LINEAR)	27014	LM302H
A4	08640-60032	1	METER/ANNUNCIATOR DRIVE ASSY	28480	08640-60032
A4C1	0160-2199	5	CAPACITOR;FXD; 30PF+-5% 300WVDC	28480	0160-2199
A4C2	0180-0228		CAPACITOR-FXD, 22UF+-10% 15VDC TA-SOLID	56289	150D226X9015B2
A4C3	0160-2055		CAPACITOR,FXD, .01UF+80-20% 100WVDC	28480	0160-2055
A4C4	0160-2055	21	CAPACITOR,FXD, .01UF+80-20% 100WVDC	28480	0160-2055
A4C5	0160-2199		CAPACITOR;FXD; 30PF+-5% 300WVDC	28480	0160-2199
A4CR1	1901-0040		DIODE; SWITCHING; SI ; 30V MAX VRM 50MA	28480	1901-0040
A4CR2	1901-0025		DIODE; GEN PRP; SI ; 100V MAX VRM 200MA	28480	1901-0025
A4MP1	4040-0750		2	EXTRACTOR;PC BOARD, RED	28480
A4Q1	1854-0071	29	PIN;DRIVE 0-.250" LG	00000	08D
A4Q2	1854-0019		TRANSISTOR NPN SI PD=300MW FT=200MHZ	28480	1854-0071
A4Q3	1854-0019	4	TRANSISTOR NPN SI PD=360MW FT=500MHZ	28480	1854-0019
A4R1	0757-0442	8	TRANSISTOR NPN SI PD=360MW FT=500MHZ	28480	1854-0019
A4R2	0757-0442		RESISTOR; FXD; 10K1% .125W F TUBULAR	24546	C4-1/8-T0-1002-F
A4R3	0757-0199		RESISTOR; FXD; 10K1% .125W F TUBULAR	24546	C4-1/8-T0-1002-F
A4R4	0698-3444		RESISTOR; FXD; 21.5K1% .125W F TUBULAR	24546	C4-1/8-T0-2152-F
		3	RESISTOR; FXD; 316 OHM1% .125W F	16299	C4-1/8-T0-316R-F

See introduction to this section for ordering information  
 †SEE TABLES 7-1 AND 7-2, FOR BACKDATING.

Table 6-3. Replaceable Parts

Reference Designation	HP Part Number	Qty	Description	Mfr Code	Mfr Part Number
A4R5	0757-0460	3	RESISTOR; FXD; 61.9K1% .125W F TUBULAR	24546	C4-1/8-T0-6192-F
A4R6	0757-0280		RESISTOR; FXD; 1K1% .125W F TUBULAR	24546	C4-1/8-T0-1001-F
A4R7	0757-0442		RESISTOR; FXD; 10K1% .125W F TUBULAR	24546	C4-1/8-T0-1002-F
A4R8	0757-0466	1	RESISTOR; FXD; 110K1% .125W F TUBULAR	24546	C4-1/8-T0-1103-F
A4R9	0698-3193	2	RESISTOR; FXD; 10K.25% .125W F TUBULAR	19701	MF4C1/8-C-1002-C
A4R10	2100-2514	2	RESISTOR, VAR, TRMR, 20KOHM 10% C	19701	ET50X203
A4R11	0698-3193		RESISTOR; FXD; 10K.25% .125W F TUBULAR	19701	MF4C1/8-C-1002-C
A4R12	0757-0279		RESISTOR; FXD; 3.16K1% .125W F TUBULAR	24546	C4-1/8-T0-3161-F
A4R13	0757-0280		RESISTOR; FXD; 1K1% .125W F TUBULAR	24546	C4-1/8-T0-1001-F
A4R14	0757-0280		RESISTOR; FXD; 1K1% .125W F TUBULAR	24546	C4-1/8-T0-1001-F
A4R15	0757-0346	20	RESISTOR; FXD; 10 DHM1% .125W F TUBULAR	24546	C4-1/8-T0-10R0-F
A4R16	0757-0346		RESISTOR; FXD; 10 DHM1% .125W F TUBULAR	24546	C4-1/8-T0-10R0-F
A4R17	0698-7340	1	RESISTOR; FXD; 79.95K.25% .125W F	30983	MF4C1/8-T2-79951-C
A4R18	0698-8307	1	RESISTOR; FXD; 7.4K.25% .125W F TUBULAR	30983	MF52C1/4-T2-7401-C
A4R19	2100-2521		RESISTOR, VAR, TRMR, 2KOHM 10% C	19701	ET50X202
A4R20	0757-0288	2	RESISTOR; FXD; 9.09K1% .125W F TUBULAR	30983	MF4C1/8-T0-9091-F
A4R21	0683-1065	1	RESISTOR; FXD; 10M5% .25W CC TUBULAR	01121	CB1065
A4R22	0698-5094	1	RESISTOR; FXD; 5.1M5% .25W CC TUBULAR	01121	CB5155
A4TP1	0360-1514		TERMINAL, SLDR STUD	28480	0360-1514
A4TP2	0360-1514		TERMINAL, SLDR STUD	28480	0360-1514
A4TP3	0360-1514		TERMINAL, SLDR STUD	28480	0360-1514
A4TP4	0360-1514		TERMINAL, SLDR STUD	28480	0360-1514
A4TP5	0360-1514		TERMINAL, SLDR STUD	28480	0360-1514
A4TP6	0360-1514		TERMINAL, SLDR STUD	28480	0360-1514
A4TP7	0360-1514		TERMINAL, SLDR STUD	28480	0360-1514
A4U1	1820-0223	2	IC;LIN;OPERATIONAL AMPLIFIER	27014	LM301AH
A4U2	1820-0223		IC;LIN;OPERATIONAL AMPLIFIER	27014	LM301AH
A4U3	1820-0054	8	IC;DGTL;GATE	01295	SN7400N
A4U4	1820-0511	5	IC;DGTL;GATE	01295	SN7408N
A4VR1	1902-0025		DIODE; ZENER; 10V VZ; .4W MAX PD	04713	SZ 10939-182
A4VR2	1902-0025		DIODE; ZENER; 10V VZ; .4W MAX PD	04713	SZ 10939-182
A5	08640-60029	1	FM AMPLIFIER ASSY	28480	08640-60029
A5	08640-60085		REBUILT 08640-60029, REQUIRES EXCHANGE	28480	08640-60085
A5C1	0160-2228	2	CAPACITOR;FXD; .0027UF+-5% 300WVDC	28480	0160-2228
A5C2	0160-2228		CAPACITOR;FXD; .0027UF+-5% 300WVDC	28480	0160-2228
A5C3	0180-0116	7	CAPACITOR-FXD; 6.8UF+-10% 35VDC TA	56289	150D685X9035B2
A5C4	0180-1715	3	CAPACITOR-FXD; 150UF+-10% 6VDC TA-SOLID	56289	150D157X9006R2
A5C5	0180-0269	1	CAPACITOR-FXD; 1UF+75-10% 150VDC AL	56289	30D105G150BA2
A5C6	0180-0197	24	CAPACITOR-FXD; 2.2UF+-10% 20VDC TA	56289	150D225X9020A2
A5C7	0180-0116		CAPACITOR-FXD; 6.8UF+-10% 35VDC TA	56289	150D685X9035B2
A5C8	0180-2211	1	CAPACITOR-FXD; 5UF+50-10% 150VDC AL	56289	30D505F150CC2
A5C9 †	0160-0939	3	CAPACITOR;FXD; 430PF+-5% 300WVDC	28480	0160-0939
A5CR1-4			NOT ASSIGNED		
A5CR5	1901-0025		DIODE; GEN PRP; SI ; 100V MAX VRM 200MA	28480	1901-0025
A5CR6	1901-0025		DIODE; GEN PRP; SI ; 100V MAX VRM 200MA	28480	1901-0025
A5CR7	1901-0025		DIODE; GEN PRP; SI ; 100V MAX VRM 200MA	28480	1901-0025
A5CR8	1901-0025		DIODE; GEN PRP; SI ; 100V MAX VRM 200MA	28480	1901-0025
A5CR9	1901-0025		DIODE; GEN PRP; SI ; 100V MAX VRM 200MA	28480	1901-0025
A5CR10	1901-0050	12	DIODE; SWITCHING; SI ; 80V MAX VRM 200MA	28480	1901-0050
A5CR11	1901-0050		DIODE; SWITCHING; SI ; 80V MAX VRM 200MA	28480	1901-0050
A5CR12	1901-0050		DIODE; SWITCHING; SI ; 80V MAX VRM 200MA	28480	1901-0050
A5CR13	1901-0025		DIODE; GEN PRP; SI ; 100V MAX VRM 200MA	28480	1901-0025
A5K1	0490-1078	1	RELAY, REED, 1A .5A 200V CONT, 5V COIL	32255	SX20-1A05-0S
A5MP1	4040-0750 1480-0073		EXTRACTOR:PC BOARD, RED PIN:DRIVE 0.250" LG	28480 00000	4040-0750 0BD
A5MP2	4040-0756 1480-0073	1	EXTRACTOR:PC BOARD, WHITE PIN:DRIVE 0.250" LG	28480 00000	4040-0756 0BD
A5Q1	1854-0221	5	TRANSISTOR, BIPOL, SI, NPN DUAL	28480	1854-0221
A5Q2	1854-0221		TRANSISTOR, BIPOL, SI, NPN DUAL	28480	1854-0221
A5Q3	1854-0404	8	TRANSISTOR NPN SI PD=360MW FT=200MHZ	28480	1854-0404
A5Q4	1854-0404		TRANSISTOR NPN SI PD=360MW FT=200MHZ	28480	1854-0404
A5Q5 †	1853-0038	5	TRANSISTOR PNP SI PD=1W FT=100MHZ	28480	1853-0038
	1205-0011	3	HEAT-DISSIPATOR, SGL, TO-5 PKG	28480	1205-0011
	1200-0173	25	INSULATOR, XSTR, TO- 5, .075 THK	28480	1200-0173
A5Q6 †	1853-0038		TRANSISTOR PNP SI PD=1W FT=100MHZ	28480	1853-0038
	1200-0173		INSULATOR, XSTR, TO- 5, .075 THK	28480	1200-0173
	1205-0011		HEAT-DISSIPATOR, SGL, TO-5 PKG	28480	1205-0011

See introduction to this section for ordering information  
 † SEE TABLES 7-1 AND 7-2, FOR BACKDATING.

Table 6-3. Replaceable Parts

Reference Designation	HP Part Number	Qty	Description	Mfr Code	Mfr Part Number	
A5Q7†	1853-0038	5	TRANSISTOR PNP SI PD=1W FT=100MHZ	28480	1853-0038	
A5Q8†	1200-0173		INSULATOR, XSTR, TO- 5, .075 THK	28480	1200-0173	
	1854-0039		TRANSISTOR NPN 2N3053 SI PD=1W	04713	2N3053	
	1200-0173		INSULATOR, XSTR, TO- 5, .075 THK	28480	1200-0173	
	1205-0011		HEAT DISSIPATOR, SGL, TO-5 PKG	28480	1205-0011	
A5Q9†	1854-0022	3	TRANSISTOR NPN SI PD=700MW FT=50MHZ	07263	S17843	
	1200-0173		INSULATOR, XSTR, TO- 5, .075 THK	28480	1200-0173	
A5Q10	1854-0237	2	TRANSISTOR,NPN 2N3738 SI PD=20W	04713	2N3738	
	0510-0002	4	PRESS-IN NUT, 6-32, .062 LG,.056 MIN	28480	0510-0002	
	1205-0085	2	HEAT-DISSIPATOR, SGL, TO-49 PKG	28480	1205-0085	
	2360-0199	4	SCREW;MACHINE; 6-32 UNC-2A .438 IN PAN	28480	2360-0199	
	2420-0003	4	NUT, HEX 6-32 .094 X .25, SST, PSVT	80120		
	2190-0018	5	WASHER; LOCK; HELICAL; 6 .141 ID .269	28480	2190-0018	
	2190-0007	4	WASHER; LOCK; INT; 6 .141 ID .288 OD	78189	1906-00	
A5Q11†	1853-0012	1	TRANSISTOR PNP 2N2904A SI PD=600MW	01295	2N2904A	
	1200-0173		INSULATOR, XSTR, TO- 5, .075 THK	28480	1200-0173	
A5Q12	1854-0237	6	TRANSISTOR,NPN 2N3738 SI PD=20W	04713	2N3738	
	0510-0002		PRESS-IN NUT, 6-32, .062 LG,.056 MIN	28480	0510-0002	
	1205-0085		HEAT-DISSIPATOR, SGL, TO-49 PKG	28480	1205-0085	
	2360-0199		SCREW;MACHINE; 6-32 UNC-2A .438 IN PAN	28480	2360-0199	
	2420-0003		NUT, HEX 6-32 .094 X .25, SST, PSVT	80120		
	2190-0018		WASHER; LOCK; HELICAL; 6 .141 ID .269	28480	2190-0018	
	2190-0007		WASHER; LOCK; INT; 6 .141 ID .288 OD	78189	1906-00	
A5R1	0698-3162	6	RESISTOR; FXD; 46.4K1% .125W F TUBULAR	16299	C4-1/8-T0-4642-F	
A5R2	0757-0180	3	RESISTOR; FXD; 31.6 OHM1% .125W F	24546	C5-1/4-T0-31R6-F	
A5R3	0757-0403	2	RESISTOR; FXD; 121 OHM1% .125W F	24546	C4-1/8-T0-121R-F	
A5R4	0757-0290	8	RESISTOR; FXD; 6.19K1% .125W F TUBULAR	30983	MF4C1/8-T0-6191-F	
A5R5	0757-0317	5	RESISTOR; FXD; 1.33K1% .125W F TUBULAR	24546	C4-1/8-T0-1331-F	
A5R6	0698-3132	7	RESISTOR; FXD; 261 OHM1% .125W F	16299	C4-1/8-T0-2610-F	
A5R7	0698-3410	1	RESISTOR; FXD; 3.16K1% .5W F TUBULAR	19701	MF7C1/2-T0-3161-F	
A5R8	2100-3164		RESISTOR,VAR,TRMR 10 OHM 20% C	32997	3006P-1-100	
A5R9	0698-0085	10	RESISTOR; FXD; 2.61K1% .125W F TUBULAR	16299	C4-1/8-T0-2611-F	
A5R10	0757-0317		RESISTOR; FXD; 1.33K1% .125W F TUBULAR	24546	C4-1/8-T0-1331-F	
A5R11	0698-3132		RESISTOR; FXD; 261 OHM1% .125W F	16299	C4-1/8-T0-2610-F	
A5R12	0757-0290		RESISTOR; FXD; 6.19K1% .125W F TUBULAR	30983	MF4C1/8-T0-6191-F	
A5R13	0757-0180	27	RESISTOR; FXD; 31.6 OHM1% .125W F	24546	C5-1/4-T0-31R6-F	
A5R14	0757-0403		RESISTOR; FXD; 121 OHM1% .125W F	24546	C4-1/8-T0-121R-F	
A5R15	0698-3162		RESISTOR; FXD; 46.4K1% .125W F TUBULAR	16299	C4-1/8-T0-4642-F	
A5R16	0757-0401		RESISTOR; FXD; 100 OHM1% .125W F	24546	C4-1/8-T0-100R-F	
A5R17	0698-3446		2	RESISTOR; FXD; 383 OHM1% .125W F	16299	C4-1/8-T0-383R-F
A5R18	0698-3132			RESISTOR; FXD; 261 OHM1% .125W F	16299	C4-1/8-T0-2610-F
A5R19	0757-0401	RESISTOR; FXD; 100 OHM1% .125W F		24546	C4-1/8-T0-101-F	
A5R20	0757-0346	RESISTOR; FXD; 10 OHM1% .125W F TUBULAR		24546	C4-1/8-T0-10R0-F	
A5R21		NOT ASSIGNED				
A5R22	0698-3430	1	RESISTOR; FXD; 21.5 OHM1% .125W F	03888	PME55-1/8-T0-21R5-F	
A5R23	2100-3154		RESISTOR,VAR,TRMR 1K OHM 10% C	32997	3006P-1-102	
A5R24	0757-0280		RESISTOR; FXD; 1K1% .125W F TUBULAR	24546	C4-1/8-T0-1001-F	
A5R25	0757-0280		RESISTOR; FXD; 1K1% .125W F TUBULAR	24546	C4-1/8-T0-1001-F	
A5R26	0757-0346		RESISTOR; FXD; 10 OHM1% .125W F TUBULAR	24546	C4-1/8-T0-10R0-F	
A5R27	0757-0441		6	RESISTOR; FXD; 8.25K1% .125W F TUBULAR	24546	C4-1/8-T0-8251-F
A5R28	0757-0440	7	RESISTOR; FXD; 7.5K1% .125W F TUBULAR	24546	C4-1/8-T0-7501-F	
A5R29	0698-3158	1	RESISTOR; FXD; 23.7K1% .125W F TUBULAR	16299	C4-1/8-T0-2372-F	
A5R30	0757-0443	4	RESISTOR; FXD; 11K1% .125W F TUBULAR	24546	C4-1/8-T0-1102-F	
A5R31	0757-0442		RESISTOR; FXD; 10K1% .125W F TUBULAR	24546	C4-1/8-T0-1002-F	
A5R32	0757-0438	37	RESISTOR; FXD; 5.11K1% .125W F TUBULAR	24546	C4-1/8-T0-5111-F	
A5R33	0698-0085		RESISTOR; FXD; 2.61K1% .125W F TUBULAR	16299	C4-1/8-T0-2611-F	
A5R34	0698-0085		RESISTOR; FXD; 2.61K1% .125W F TUBULAR	16299	C4-1/8-T0-2611-F	
A5R35	0757-0399		RESISTOR; FXD; 82.5 OHM1% .125W F	24546	C4-1/8-T0-82R5-F	
A5R36	0757-0399		RESISTOR; FXD; 82.5 OHM1% .125W F	24546	C4-1/8-T0-82R5-F	
A5R37	0698-3391	1	RESISTOR; FXD; 21.5 OHM1% .5W F TUBULAR	19701	MF7C1/2-T0-21R5-F	
A5R38	0757-0198	1	RESISTOR; FXD; 100 OHM1% .5W F TUBULAR	30983	MF7C1/2-T0-101-F	
A5R39	0698-5839	2	RESISTOR; FXD; 9.1 OHM5% .25W CC	01121	CB91G5	
A5R40	0698-5839		RESISTOR; FXD; 9.1 OHM5% .25W CC	01121	CB91G5	
A5R41	0698-3260	2	RESISTOR; FXD; 464K1% .125W F TUBULAR	19701	MF4C1/8-T0-4643-F	
A5TP1	0360-1514		TERMINAL, SLDR STUD	28480	0360-1514	
A5TP2	0360-1514		TERMINAL, SLDR STUD	28480	0360-1514	
A5TP3	0360-1514		TERMINAL, SLDR STUD	28480	0360-1514	
A5TP4	0360-1514		TERMINAL, SLDR STUD	28480	0360-1514	
A5TP5	0360-1514		TERMINAL, SLDR STUD	28480	0360-1514	
A5TP6	0360-1514		TERMINAL, SLDR STUD	28480	0360-1514	
ASU1	1820-0158		IC;LIN;MISCELLANEOUS (LINEAR)	27014	LM302H	

See introduction to this section for ordering information  
 † SEE TABLES 7-1 AND 7-2, FOR BACKDATING.

Table 6-3. Replaceable Parts

Reference Designation	HP Part Number	Qty	Description	Mfr Code	Mfr Part Number
A6	08640-60033	1	ANNUNCIATOR ASSY	28480	08640-60033
A6DS1	2140-0356	7	LAMP; INCAND; BULB T1; 5V	71744	CM7-7683
A6DS2	2140-0356		LAMP; INCAND; BULB T1; 5V	71744	CM7-7683
A6DS3	2140-0356		LAMP; INCAND; BULB T1; 5V	71744	CM7-7683
A6DS4	2140-0356		LAMP; INCAND; BULB T1; 5V	71744	CM7-7683
A6DS5	2140-0356		LAMP; INCAND; BULB T1; 5V	71744	CM7-7683
A6DS6	2140-0356		LAMP; INCAND; BULB T1; 5V	71744	CM7-7683
A6P1	1251-3054	2	CONNECTOR STRIP:9 OPEN POSITION	74868	221-68
	1251-1249	2	CONNECTOR-POLARIZING KEY, FOR SER	13511	143-953
	1251-1313	15	CONTACT, CONN, U/W MICRO SER, FEM	13511	220-502
A6R1	0757-0346		RESISTOR; FXD; 10 OHM1% .125W F TUBULAR	24546	C4-1/8-T0-10R0-F
A7 †	08640-60046	1	FM SHAPING BOARD ASSY	28480	08640-60046
A7 †	08640-60084		REBUILT 08640-60046, REQUIRES EXCHANGE	28480	08640-60084
A7C1	0180-1735	3	CAPACITOR-FXD, .22UF+-10% 35VDC TA	56289	1500224X9035A2
A7C2	0180-1735		CAPACITOR-FXD, .22UF+-10% 35VDC TA	56289	1500224X9035A2
A7C3	0180-0373	1	CAPACITOR-FXD, .68UF+-10% 35VDC TA	56289	1500684X9035A2
A7C4	0180-2141	1	CAPACITOR-FXD, 3.3UF+-10% 50VDC TA	56289	1500335X9050B2
A7C5	0180-0141	2	CAPACITOR-FXD; 50UF+75-10% 50VDC AL	56289	30D506G050DD2
A7C6	0180-1715		CAPACITOR-FXD, 150UF+-10% 6VDC TA-SOLID	56289	150D157X9006R2
A7C7	0160-2453	1	CAPACITOR-FXD; .22UF+-10% 80WVDC	84411	HEW-238T
A7C8	0180-1846	1	CAPACITOR-FXD, 2.2UF+-10% 35VDC TA	56289	150D225X9035B2
A7C9	0160-2204	7	CAPACITOR-FXD; 100PF+-5% 300WVDC	28480	0160-2204
A7C10	0180-0141		CAPACITOR-FXD; 50UF+75-10% 50VDC AL	56289	30D506G050DD2
A7C11	0180-1715		CAPACITOR-FXD, 150UF+-10% 6VDC TA-SOLID	56289	150D157X9006R2
A7C12	0160-2204		CAPACITOR-FXD; 100PF+-5% 300WVDC	28480	0160-2204
A7C13	0180-2206	2	CAPACITOR-FXD, 60UF+-10% 6VDC TA-SOLID	56289	150D606X9006B2
A7CR1	1901-0033	20	DIODE; GEN PRP; SI ; 180V MAX VRM 200MA	28480	1901-0033
A7CR2	1901-0033		DIODE; GEN PRP; SI ; 180V MAX VRM 200MA	28480	1901-0033
A7CR3	1901-0033		DIODE; GEN PRP; SI ; 180V MAX VRM 200MA	28480	1901-0033
A7CR4	1901-0033		DIODE; GEN PRP; SI ; 180V MAX VRM 200MA	28480	1901-0033
A7CR5	1901-0033		DIODE; GEN PRP; SI ; 180V MAX VRM 200MA	28480	1901-0033
A7CR6	1901-0033		DIODE; GEN PRP; SI ; 180V MAX VRM 200MA	28480	1901-0033
A7CR7	1901-0033		DIODE; GEN PRP; SI ; 180V MAX VRM 200MA	28480	1901-0033
A7CR8	1901-0033		DIODE; GEN PRP; SI ; 180V MAX VRM 200MA	28480	1901-0033
A7CR9	1901-0033		DIODE; GEN PRP; SI ; 180V MAX VRM 200MA	28480	1901-0033
A7CR10	1901-0025		DIODE; GEN PRP; SI ; 100V MAX VRM 200MA	28480	1901-0025
A7CR11	1901-0033		DIODE; GEN PRP; SI ; 180V MAX VRM 200MA	28480	1901-0033
A7CR12	1901-0033		DIODE; GEN PRP; SI ; 180V MAX VRM 200MA	28480	1901-0033
A7CR13	1901-0033		DIODE; GEN PRP; SI ; 180V MAX VRM 200MA	28480	1901-0033
A7CR14	1901-0033		DIODE; GEN PRP; SI ; 180V MAX VRM 200MA	28480	1901-0033
A7CR15	1901-0033		DIODE; GEN PRP; SI ; 180V MAX VRM 200MA	28480	1901-0033
A7CR16	1901-0033		DIODE; GEN PRP; SI ; 180V MAX VRM 200MA	28480	1901-0033
A7CR17	1901-0033		DIODE; GEN PRP; SI ; 180V MAX VRM 200MA	28480	1901-0033
A7CR18	1901-0033		DIODE; GEN PRP; SI ; 180V MAX VRM 200MA	28480	1901-0033
A7CR19	1901-0033		DIODE; GEN PRP; SI ; 180V MAX VRM 200MA	28480	1901-0033
A7CR20	1901-0033		DIODE; GEN PRP; SI ; 180V MAX VRM 200MA	28480	1901-0033
A7CR21	1901-0033		DIODE; GEN PRP; SI ; 180V MAX VRM 200MA	28480	1901-0033
A7J1 †	1250-0835	1	CONNECTOR-COAX, SMC, 50 OHM MALE	24931	37JR104-2
A7K1	0490-1080	3	RELAY, REED, 1C .25A 150V CONT, 5V COIL	32255	SX30-014
A7MP1	4040-0751 1480-0073	1	GUIDE; PC BOARD EXTRACTOR LEXAN, ORANGE PIN:DRIVE 0.250" LG	28480 00000	4040-0751 0B0
A7MP2	4040-0748 1480-0073	3	EXTRACTOR:PC BOARD, BLACK PIN:DRIVE 0.250" LG	28480 00000	4040-0748 0B0
A7Q1	1854-0071		TRANSISTOR NPN SI PD=300MW FT=200MHZ	28480	1854-0071
A7Q2	1854-0071		TRANSISTOR NPN SI PD=300MW FT=200MHZ	28480	1854-0071
A7Q3 †	1854-0022 1200-0173		TRANSISTOR NPN SI PD=700MW FT=50MHZ INSULATOR, XSTR, T0-5, .075 THK	07263 28480	S17843 1200-0173
A7Q4	1853-0020	13	TRANSISTOR PNP SI PD=300MW FT=150MHZ	28480	1853-0020
A7Q5	1854-0071		TRANSISTOR NPN SI PD=300MW FT=200MHZ	28480	1854-0071
A7Q6 †	1853-0038 1200-0173		TRANSISTOR PNP SI PD=1W FT=100MHZ INSULATOR, XSTR, T0-5, .075 THK	28480 28480	1853-0038 1200-0173
A7Q7	1853-0020		TRANSISTOR PNP SI PD=300MW FT=150MHZ	28480	1853-0020
A7Q8	1853-0020		TRANSISTOR PNP SI PD=300MW FT=150MHZ	28480	1853-0020
A7R1	0698-3162		RESISTOR; FXD; 46.4K1% .125W F TUBULAR	16299	C4-1/8-T0-4642-F
A7R2	0698-3450	7	RESISTOR; FXD; 42.2K1% .125W F TUBULAR	16299	C4-1/8-T0-4222-F
A7R3	0698-3153	3	RESISTOR; FXD; 3.83K1% .125W F TUBULAR	16299	C4-1/8-T0-3831-F

See introduction to this section for ordering information  
 † SEE TABLES 7-1 AND 7-2, FOR BACKDATING.

Table 6-3. Replaceable Parts

Reference Designation	HP Part Number	Qty	Description	Mfr Code	Mfr Part Number
ATR4	0757-0199		RESISTOR; FXD; 21.5K1% .125W F TUBULAR	24546	C4-1/8-T0-2152-F
ATR5	0757-0440		RESISTOR; FXD; 7.5K1% .125W F TUBULAR	24546	C4-1/8-T0-7501-F
ATR6	0698-3243	1	RESISTOR; FXD; 178K1% .125W F TUBULAR	16299	C4-1/8-T0-1783-F
ATR7	0698-3454	3	RESISTOR; FXD; 215K1% .125W F TUBULAR	16299	C4-1/8-T0-2153-F
ATR8	0757-0289	3	RESISTOR; FXD; 13.3K1% .125W F TUBULAR	30983	MF4C1/8-T0-1332-F
ATR9	0698-3161	2	RESISTOR; FXD; 38.3K1% .125W F TUBULAR	16299	C4-1/8-T0-3832-F
ATR10	0698-3154	8	RESISTOR; FXD; 4.22K1% .125W F TUBULAR	16299	C4-1/8-T0-4221-F
ATR11	0757-0288		RESISTOR; FXD; 9.39K1% .125W F TUBULAR	30983	MF4C1/8-T0-9091-F
ATR12	2100-3109		RESISTOR;VAR,TRMR 2K OHM 10% C	32997	3006P-1-202
ATR13	0698-3155	6	RESISTOR; FXD; 4.64K1% .125W F TUBULAR	16299	C4-1/8-T0-4641-F
ATR14	0698-3260		RESISTOR; FXD; 464K1% .125W F TUBULAR	19701	MF4C1/8-T0-4643-F
ATR15	0757-0458	5	RESISTOR; FXD; 51.1K1% .125W F TUBULAR	24546	C4-1/8-T0-5112-F
ATR16	0757-0443		RESISTOR; FXD; 11K1% .125W F TUBULAR	24546	C4-1/8-T0-1102-F
ATR17	0698-3155		RESISTOR; FXD; 4.64K1% .125W F TUBULAR	16299	C4-1/8-T0-4641-F
ATR18	0757-0123	1	RESISTOR; FXD; 34.8K1% .125W F TUBULAR	24546	C5-1/4-T0-3482-F
ATR19	2100-3103	1	RESISTOR;VAR,TRMR 10K OHM 10% C	32997	3006P-1-103
ATR20	0698-3152	2	RESISTOR; FXD; 3.48K1% .125W F TUBULAR	16299	C4-1/8-T0-3481-F
ATR21	0698-3437	5	RESISTOR; FXD; 133 OHM1% .125W F	16299	C4-1/8-T0-133R-F
ATR22	0757-0417	1	RESISTOR; FXD; 562 OHM1% .125W F	24546	C4-1/8-T0-562R-F
ATR23	0698-0083	10	RESISTOR; FXD; 1.96K1% .125W F TUBULAR	16299	C4-1/8-T0-1961-F
ATR24	0757-0279		RESISTOR; FXD; 3.16K1% .125W F TUBULAR	24546	C4-1/8-T0-3161-F
ATR25	0698-3154		RESISTOR; FXD; 4.22K1% .125W F TUBULAR	16299	C4-1/8-T0-4221-F
ATR26	0757-0438		RESISTOR; FXD; 5.11K1% .125W F TUBULAR	24546	C4-1/8-T0-5111-F
ATR27	0757-0290		RESISTOR; FXD; 6.19K1% .125W F TUBULAR	30983	MF4C1/8-T0-6191-F
ATR28	0757-0439	5	RESISTOR; FXD; 6.81K1% .125W F TUBULAR	24546	C4-1/8-T0-6811-F
ATR29	0757-0401		RESISTOR; FXD; 100 OHM1% .125W F	24546	C4-1/8-T0-101-F
ATR30	0698-4037	7	RESISTOR; FXD; 46.4 OHM1% .125W F	16299	C4-1/8-T0-46R4-F
ATR31	0698-4037		RESISTOR; FXD; 46.4 OHM1% .125W F	16299	C4-1/8-T0-46R4-F
ATR32	0698-4037		RESISTOR; FXD; 46.4 OHM1% .125W F	16299	C4-1/8-T0-46R4-F
ATR33	0698-4037		RESISTOR; FXD; 46.4 OHM1% .125W F	16299	C4-1/8-T0-46R4-F
ATR34	0698-4037		RESISTOR; FXD; 46.4 OHM1% .125W F	16299	C4-1/8-T0-46R4-F
ATR35	0698-4037		RESISTOR; FXD; 46.4 OHM1% .125W F	16299	C4-1/8-T0-46R4-F
ATR36	0698-4037		RESISTOR; FXD; 46.4 OHM1% .125W F	16299	C4-1/8-T0-46R4-F
ATR37	0757-0180		RESISTOR; FXD; 31.6 OHM1% .125W F	24546	C5-1/4-T0-31R6-F
ATR38	0757-0401		RESISTOR; FXD; 100 OHM1% .125W F	24546	C4-1/8-T0-101-F
ATR39	0757-0280		RESISTOR; FXD; 1K1% .125W F TUBULAR	24546	C4-1/8-T0-1001-F
ATR40	0757-0439		RESISTOR; FXD; 6.81K1% .125W F TUBULAR	24546	C4-1/8-T0-6811-F
ATR41	2100-3109		RESISTOR;VAR,TRMR 2K OHM 10% C	32997	3006P-1-202
ATR42	0757-0442		RESISTOR; FXD; 10K1% .125W F TUBULAR	24546	C4-1/8-T0-1002-F
ATR43	0698-3155		RESISTOR; FXD; 4.64K1% .125W F TUBULAR	16299	C4-1/8-T0-4641-F
ATR44	0757-0443		RESISTOR; FXD; 11K1% .125W F TUBULAR	24546	C4-1/8-T0-1102-F
ATR45	0698-3156	5	RESISTOR; FXD; 14.7K1% .125W F TUBULAR	16299	C4-1/8-T0-1472-F
ATR46	0757-0441		RESISTOR; FXD; 8.25K1% .125W F TUBULAR	24546	C4-1/8-T0-8251-F
ATR47	0757-0440		RESISTOR; FXD; 7.5K1% .125W F TUBULAR	24546	C4-1/8-T0-7501-F
ATR48	0757-0439		RESISTOR; FXD; 6.81K1% .125W F TUBULAR	24546	C4-1/8-T0-6811-F
ATR49	0757-0290		RESISTOR; FXD; 6.19K1% .125W F TUBULAR	30983	MF4C1/8-T0-6191-F
ATR50	0757-0200	4	RESISTOR; FXD; 5.62K1% .125W F TUBULAR	24546	C4-1/8-T0-5621-F
ATR51	0757-0438		RESISTOR; FXD; 5.11K1% .125W F TUBULAR	24546	C4-1/8-T0-5111-F
ATR52	0698-3155		RESISTOR; FXD; 4.64K1% .125W F TUBULAR	16299	C4-1/8-T0-4641-F
ATR53	0757-0200		RESISTOR; FXD; 5.62K1% .125W F TUBULAR	24546	C4-1/8-T0-5621-F
ATR54	0757-0439		RESISTOR; FXD; 6.81K1% .125W F TUBULAR	24546	C4-1/8-T0-6811-F
ATR55	0757-0401		RESISTOR; FXD; 100 OHM1% .125W F	24546	C4-1/8-T0-101-F
ATR56	0698-3432	1	RESISTOR; FXD; 26.1 OHM1% .125W F	03888	PME55-1/8-T0-26R1-F
ATR57	0757-0402	1	RESISTOR; FXD; 110 OHM1% .125W F	24546	C4-1/8-T0-111-F
ATR58	0757-0401		RESISTOR; FXD; 100 OHM1% .125W F	24546	C4-1/8-T0-101-F
ATR59	0757-0400	3	RESISTOR; FXD; 90.9 OHM1% .125W F	24546	C4-1/8-T0-90R9-F
ATR60	0757-0399		RESISTOR; FXD; 82.5 OHM1% .125W F	24546	C4-1/8-T0-82R5-F
ATR61	0757-0398		RESISTOR; FXD; 75 OHM1% .125W F TUBULAR	24546	C4-1/8-T0-75R0-F
ATR62	0757-0397	6	RESISTOR; FXD; 68.1 OHM1% .125W F	24546	C4-1/8-T0-68R1-F
ATR63	0757-0276	1	RESISTOR; FXD; 61.9 OHM1% .125W F	24546	C4-1/8-T0-6192-F
ATR64	0757-0395	6	RESISTOR; FXD; 56.2 OHM1% .125W F	24546	C4-1/8-T0-56R2-F
ATR65	0757-0394	9	RESISTOR; FXD; 51.1 OHM1% .125W F	24546	C4-1/8-T0-51R1-F
ATR66	0757-0401		RESISTOR; FXD; 100 OHM1% .125W F	24546	C4-1/8-T0-101-F
ATR67-69			NOT ASSIGNED		
ATR70	0698-3150	6	RESISTOR; FXD; 2.37K1% .125W F TUBULAR	16299	C4-1/8-T0-2371-F
ATR71	0757-0424	1	RESISTOR; FXD; 1.1K1% .125W F TUBULAR	24546	C4-1/8-T0-1101-F
ATR72	0698-3450		RESISTOR; FXD; 42.2K1% .125W F TUBULAR	16299	C4-1/8-T0-4222-F
ATR73	0698-3450		RESISTOR; FXD; 42.2K1% .125W F TUBULAR	16299	C4-1/8-T0-4222-F
ATR74	0698-3150		RESISTOR; FXD; 2.37K1% .125W F TUBULAR	16299	C4-1/8-T0-2371-F
ATR75	0757-0420		RESISTOR; FXD; 750 OHM1% .125W F	24546	C4-1/8-T0-751-F
ATR76	0757-0441		RESISTOR; FXD; 8.25K1% .125W F TUBULAR	24546	C4-1/8-T0-8251-F
ATR77	0757-0438		RESISTOR; FXD; 5.11K1% .125W F TUBULAR	24546	C4-1/8-T0-5111-F
ATR78	0757-0346		RESISTOR; FXD; 10 OHM1% .125W F TUBULAR	24546	C4-1/8-T0-10R0-F
ATR79	0757-0416		RESISTOR; FXD; 511 OHM1% .125W F	24546	C4-1/8-T0-511R-F

See introduction to this section for ordering information

Table 6-3. Replaceable Parts

Reference Designation	HP Part Number	Qty	Description	Mfr Code	Mfr Part Number
A7TP1	0360-1514		TERMINAL, SLDR STUD	28480	0360-1514
A7TP2	0360-1514		TERMINAL, SLDR STUD	28480	0360-1514
A7TP3	0360-1514		TERMINAL, SLDR STUD	28480	0360-1514
A7TP4	0360-1514		TERMINAL, SLDR STUD	28480	0360-1514
A7U1	1826-0013	2	IC;LIN;OPERATIONAL AMPLIFIER	28480	1826-0013
A7U2	1820-0125	1	IC;DGTL;COMPARATOR (ANALOG)	07263	711HC
A7U3	1820-0175	1	IC;DGTL;INVERTER	01295	SN7405N
A7VF1	1902-0049	5	DIODE; ZENER; 6.19V VZ; .4W MAX PD	28480	1902-0049
A7VR2	1902-3182	2	DIODE; ZENER; 12.1V VZ; .4W MAX PD	04713	SZ 10939-206
A8	08640-60115	1	COUNTER/LOCK ASSY	28480	08640-60115
A8C1	0160-2049	16	CAPACITOR;FXD; .005UF+80-20% 500WVDC	28480	0160-2049
A8C2	0160-2049		CAPACITOR;FXD; .005UF+80-20% 500WVDC	28480	0160-2049
A8C3	0160-2049		CAPACITOR;FXD; .005UF+80-20% 500WVDC	28480	0160-2049
A8C4	0160-2049		CAPACITOR;FXD; .005UF+80-20% 500WVDC	28480	0160-2049
A8C5	0160-2357	2	CAPACITOR;FXD; .001UF+80-20% 500WVDC	28480	0160-2357
A8C6	0160-2357		CAPACITOR;FXD; .001UF+80-20% 500WVDC	28480	0160-2357
A8FL1	0160-0204	7	CAPACITOR;FXD; .0055UF+-0% 200WVDC	01121	SMFB-A2
A8FL2	0160-0204		CAPACITOR;FXD; .0055UF+-0% 200WVDC	01121	SMFB-A2
A8FL3	0160-0204		CAPACITOR;FXD; .0055UF+-0% 200WVDC	01121	SMFB-A2
A8FL4	0160-0204		CAPACITOR;FXD; .0055UF+-0% 200WVDC	01121	SMFB-A2
A8L1 †	9100-2232	5	COIL, FXD, MOLDED RF CHOKE, .56UH 10%	24226	15/560
A8L2 †	9100-2232		COIL, FXD, MOLDED RF CHOKE, .56UH 10%	24226	15/560
A8L3 †	9100-2232		COIL, FXD, MOLDED RF CHOKE, .56UH 10%	24226	15/560
A8L4	9100-2232		COIL, FXD, MOLDED RF CHOKE, .56UH 10%	24226	15/560
A8L5	9100-2232		COIL, FXD, MOLDED RF CHOKE, .56UH 10%	24226	15/560
A8MP1	1200-0081	2	INSULATOR, BSHG;FLG, .115 ID	26365	974-307
A8MP2	2190-0027	1	WASHER; LOCK; INT; 1/4 .256 ID .478 OD	78189	1914-00
A8MP3	3050-0443	2	WASHER; FLAT; 8 .176 ID .375 OD	86928	5624-16-10
A8MP4	8160-0219	1	GASKET MATL;RFI; FL STRP/SH NICKEL	28480	8160-0219
A8MP5	8160-0220	1	GASKET MATL;RFI; FL STRP/SH NICKEL	28480	8160-0220
A8MP6	08640-00001	1	SHIELD;LED TAPE	28480	08640-00001
A8MP7	08640-00009	1	COVER;CENTER FILTER	28480	08640-00009
A8MP8	08640-00051	1	FRAME C SHIELD, LARGE	28480	08640-00051
A8MP9	08640-00052	1	FRAME C SHIELD, SMALL	28480	08640-00052
A8MP10	08640-20059	1	COVER;CONTROL INPUT	28480	08640-20059
A8MP11	08640-20060	1	HEAT SINK	28480	08640-20060
A8MP12	08640-20063	1	WINDOW COUNTER	28480	08640-20063
A8MP13	08640-20089	2	SUPPORT;PC BOARD, CENTER	28480	08640-20089
A8MP14	08640-20092	1	SHIELD;BUTTON	28480	08640-20092
A8MP15	08640-20202	1	CASTING;TOP	28480	08640-20202
A8MP16	08640-20203	1	CASTING;BOTTOM	28480	08640-20203
A8MP17	08640-40003	1	PIPE LIGHT	28480	08640-40003
A8MP18	08640-40041	1	PIPE LIGHT, OFLOW	28480	08640-40041
A8MP19	5040-0391	1	BUTTON;X10	28480	5040-0391
A8MP20	5040-0392	1	BUTTON;X100	28480	5040-0392
A8MP21	5040-0393	1	BUTTON-ON	28480	5040-0393
A8MP22	5040-0394	1	BUTTON-INT	28480	5040-0394
A8MP23	5040-0395	2	BUTTON-EXT	28480	5040-0395
A8MP24	2190-0368	2	WASHER; FLAT; 5 .13 ID .235 OD	28480	2190-0368
A8MP25	2190-0019	2	WASHER; LOCK; HELICAL; 4 .115 ID .226	28480	2190-0019
A8MP26	2200-0147	14	SCREW;MACHINE; 4-40 UNC-2A .5 IN PAN	28480	2200-0147
A8MP27	2200-0107	8	SCREW;MACHINE; 4-40 UNC-2A .375 IN PAN	28480	2200-0107
A8MP28	2200-0151	2	SCREW;MACHINE; 4-40 UNC-2A .75 IN PAN	28480	2200-0151
A8MP29	2190-0005	2	WASHER; LOCK; EXT; 4 .116 ID .285 OD	78189	1804-01
A8MP30	2950-0006	1	NUT, HEX 1/4-32 .094 X .375, BRS, NI PL	73734	9000
A8MP31	2200-0140	7	SCREW;MACHINE; 4-40 UNC-2A .25 IN 100	28480	2200-0140
A8MP32	08640-00058	2	INSULATOR;COUNTER	28480	08640-00058
A8MP33	2200-0105	33	SCREW;MACHINE; 4-40 UNC-2A .312 IN PAN	28480	2200-0105
A8MP34	0520-0127	4	SCREW;MACHINE; 2-56 UNC-2A .188 IN PAN	28480	0520-0127
A8MP35	2190-0014	4	WASHER; LOCK; INT; 2 .089 ID .185 OD	78189	1902-00
A8MP36	0516-0005	2	SCREW;MACHINE; 0-80 UNF-2A .188 IN PAN	28480	0516-0005
A8MP37	2200-0103	7	SCREW;MACHINE; 4-40 UNC-2A .25 IN PAN	28480	2200-0103
A8MP38	2200-0155	5	SCREW;MACHINE; 4-40 UNC-2A 1 IN PAN	28480	2200-0155
A8MP39	0361-0207	3	RIVET;BLIND, BLACK NYLON 0.125" DIA	00000	0BD
A8MP40	2200-0504	4	SCREW;MACHINE; 4-40 UNC-2A 1.062 IN PAN	28480	2200-0504
A8MP41	08640-40007	1	KNOB;TIME BASE	28480	08640-40007
A8MP42	2190-0012	2	WASHER; LOCK; EXT; 10 .195 ID .406 OD	78189	1810-00
A8MP43	2190-0057	4	WASHER; LOCK; INT; 12 .218 ID .383 OD	78189	1912-03
A8MP44	2680-0128	1	SCREW;MACHINE; 10-32 UNF-2A .25 IN PAN	28480	2680-0128
A8MP45	08640-20088	3	HEAT SINK NUT	28480	08640-20088

See introduction to this section for ordering information  
† SEE TABLES 7-1 AND 7-2, FOR BACKDATING.



Table 6-3. Replaceable Parts

Reference Designation	HP Part Number	Qty	Description	Mfr Code	Mfr Part Number
A8U1	1990-0330		PHOTO-DEVICE, DSPL NUM 990MW PD	28480	1990-0330
A8U2	1990-0330		PHOTO-DEVICE, DSPL NUM 990MW PD	28480	1990-0330
A8U3	1990-0330		PHOTO-DEVICE, DSPL NUM 990MW PD	28480	1990-0330
A8U4	1990-0330		PHOTO-DEVICE, DSPL NUM 990MW PD	28480	1990-0330
A8U5	1990-0330		PHOTO-DEVICE, DSPL NUM 990MW PD	28480	1990-0330
A8U6	1990-0330		PHOTO-DEVICE, DSPL NUM 990MW PD	28480	1990-0330
A8A1 †	08640-60168	1	RF SCALER ASSY	28480	08640-60168
A8A1	08640-60083		REBUILT 08640-60168, REQUIRES EXCHANGE	28480	08640-60083
A8A1C1	0180-0197		CAPACITOR-FXD, 2.2UF+-10% 20VDC TA	56289	150D225X9020A2
A8A1C2	0180-0197		CAPACITOR-FXD, 2.2UF+-10% 20VDC TA	56289	150D225X9020A2
A8A1C3	0160-3879	9	CAPACITOR;FXD; .01UF+-20% 100WVDC	28480	0160-3879
A8A1C4	0160-3879		CAPACITOR;FXD; .01UF+-20% 100WVDC	28480	0160-3879
A8A1C5	0160-3879		CAPACITOR;FXD; .01UF+-20% 100WVDC	28480	0160-3879
A8A1C6	0160-3879		CAPACITOR;FXD; .01UF+-20% 100WVDC	28480	0160-3879
A8A1C7	0160-2204		CAPACITOR;FXD; 100PF+-5% 300WVDC	28480	0160-2204
A8A1CR1	1901-0050		DIODE; SWITCHING;SI ; 80V MAX VRM 200MA	28480	1901-0050
A8A1CR2	1901-0050		DIODE; SWITCHING;SI ; 80V MAX VRM 200MA	28480	1901-0050
A8A1CR3	1901-0050		DIODE; SWITCHING;SI ; 80V MAX VRM 200MA	28480	1901-0050
A8A1J1	1250-1220	6	CONNECTOR-COAX, SMC, 50 OHM MALE	98291	50-051-0109
A8A1J2	1250-1220		CONNECTOR-COAX, SMC, 50 OHM MALE	98291	50-051-0109
A8A1K1	0490-1073	6	RELAY; REED; 1A .25A 120V CONT; 4.5V	28480	0490-1073
A8A1K2	0490-1073		RELAY; REED; 1A .25A 120V CONT; 4.5V	28480	0490-1073
A8A1MP1	08640-20088		HEAT SINK NUT	28480	08640-20088
A8A1MP2	0360-0124	2	TERMINAL:SOLDER LUG	28480	0360-0124
A8A1MP3	0360-0124		TERMINAL:SOLDER LUG	28480	0360-0124
A8A1MP4	0361-0036	1	RIVET;SEMITUBULAR 0.89" BODY DIA	00000	0BD
A8A1Q1	1854-0404		TRANSISTOR NPN SI PD=360MW FT=200MHZ	28480	1854-0404
A8A1Q2	1854-0404		TRANSISTOR NPN SI PD=360MW FT=200MHZ	28480	1854-0404
A8A1R1	0698-7236	2	RESISTOR; FXD; 1K2% .05W F TUBULAR	24546	C3-1/8-T0-1001-G
A8A1R2,3			NOT ASSIGNED		
A8A1R4	0698-7248	4	RESISTOR; FXD; 3.16K2% .05W F TUBULAR	24546	C3-1/8-T0-3161-G
A8A1R5	0698-7248		RESISTOR; FXD; 3.16K2% .05W F TUBULAR	24546	C3-1/8-T0-3161-G
A8A1R6	0698-7212	1	RESISTOR; FXD; 100 OHM2% .05W F TUBULAR	24546	C3-1/8-T0-100R-G
A8A1R7	0757-0394		RESISTOR; FXD; 51.1 OHM1% .125W F	24546	C4-1/8-T0-51R1-F
A8A1R8	0757-0416		RESISTOR; FXD; 511 OHM1% .125W F	24546	C4-1/8-T0-511R-F
A8A1R9	0757-0416		RESISTOR; FXD; 511 OHM1% .125W F	24546	C4-1/8-T0-511R-F
A8A1R10	0757-1094	2	RESISTOR; FXD; 1.47K1% .125W F TUBULAR	24546	C4-1/8-T0-1471-F
A8A1R11	0757-0416		RESISTOR; FXD; 511 OHM1% .125W F	24546	C4-1/8-T0-511R-F
A8A1U1	1820-0736	3	IC;DGTL;COUNTER	28480	1820-0736
A8A1U2	1820-1003	1	IC;DGTL;COUNTER	28480	1820-1003
A8A1U3	1820-0145	6	INTEGRATED CIRCUIT, DGTL, ECL QUAD 2	04713	MC1010P
A8A1U4	1820-0102	6	INTEGRATED CIRCUIT, DGTL, ECL J-K FLIP	04713	MC1013P
A8A1U5	5086-7089	1	TRIGGER AMPLIFIER	28480	5086-7089
A8A2	08640-60027	1	COUNTER/LOCK BOARD ASSY	28480	08640-60027
A8A2	08640-60087		REBUILT 08640-60027, REQUIRES EXCHANGE	28480	08640-60087
A8A2C1	0160-3456	30	CAPACITOR;FXD; .001UF+-10% 1000WVDC	28480	0160-3456
A8A2C2	0160-3094	19	CAPACITOR;FXD; .1UF+-10% 100WVDC	28480	0160-3094
A8A2C3	0160-3094		CAPACITOR;FXD; .1UF+-10% 100WVDC	28480	0160-3094
A8A2C4	0180-0049	1	CAPACITOR-FXD; 20UF+75-10% 50VDC AL	56289	30D206G050CC2
A8A2C5	0180-1735		CAPACITOR-FXD, .22UF+-10% 35VDC TA	56289	150D224X9035A2
A8A2C6	0180-0197		CAPACITOR-FXD, 2.2UF+-10% 20VDC TA	56289	150D225X9020A2
A8A2C7	0160-3456		CAPACITOR;FXD; .001UF+-10% 1000WVDC	28480	0160-3456
A8A2C8	0180-0228		CAPACITOR-FXD, 22UF+-10% 15VDC TA-SOLID	56289	150D226X9015B2
A8A2C9	0180-0228		CAPACITOR-FXD, 22UF+-10% 15VDC TA-SOLID	56289	150D226X9015B2
A8A2C10	0160-3455	3	CAPACITOR;FXD; 470PF+-10% 1000WVDC	28480	0160-3455
A8A2C11	0160-3455		CAPACITOR;FXD; 470PF+-10% 1000WVDC	28480	0160-3455
A8A2C12 †	0160-3456	1	CAPACITOR;FXD; 100PF+-10% 250WVDC	28480	0160-3456
A8A2C13	0160-2207	1	CAPACITOR;FXD; 300PF+-5% 300WVDC	28480	0160-2207
A8A2C14	0160-3877	3	CAPACITOR;FXD; 100PF+-20% 200WVDC	28480	0160-3877
A8A2C15	0160-3879		CAPACITOR;FXD; .01UF+-20% 100WVDC	28480	0160-3879
A8A2C16	0160-3879		CAPACITOR;FXD; .01UF+-20% 100WVDC	28480	0160-3879
A8A2C17	0160-0174	4	CAPACITOR;FXD; .47UF+80-20% 25WVDC	28480	0160-0174
A8A2C18	0160-3094		CAPACITOR;FXD; .1UF+-10% 100WVDC	28480	0160-3094
A8A2C19 †	0160-2201	4	CAPACITOR;FXD; 51PF+-5% 300WVDC	28480	0160-2201
A8A2C20	0180-0291	11	CAPACITOR-FXD, 1UF+-10% 35VDC TA-SOLID	56289	150D105X9035A2
A8A2C21	0180-0197		CAPACITOR-FXD, 2.2UF+-10% 20VDC TA	56289	150D225X9020A2
A8A2C22	0160-3879		CAPACITOR;FXD; .01UF+-20% 100WVDC	28480	0160-3879
A8A2C23	0180-0197		CAPACITOR-FXD, 2.2UF+-10% 20VDC TA	56289	150D225X9020A2
A8A2C24	0160-2055		CAPACITOR;FXD, .01UF+80-20% 100WVDC	28480	0160-2055

See introduction to this section for ordering information  
 † SEE TABLES 7-1 AND 7-2, FOR BACKDATING.

Table 6-3. Replaceable Parts

Reference Designation	HP Part Number	Qty	Description	Mfr Code	Mfr Part Number	
ABA2C25	0160-2055	3	CAPACITOR;FXD; .01UF+80-20% 100WVDC	28480	0160-2055	
ABA2C26	0160-2055		CAPACITOR;FXD; .01UF+80-20% 100WVDC	28480	0160-2055	
ABA2C27 †	0160-2204		CAPACITOR;FXD; 100PF+-5% 300WVDC	28480	0160-2204	
ABA2C28 †	0160-3876		CAPACITOR;FXD; 47PF+-20% 200WVDC	28480	0160-3876	
ABA2C29	0160-3876		CAPACITOR;FXD; 47PF+-20% 200WVDC	28480	0160-3876	
ABA2C30	0160-3876	1	CAPACITOR;FXD; 47PF+-20% 200WVDC	28480	0160-3876	
ABA2CR1	1901-0040		DIODE; SWITCHING;SI ; 30V MAX VRM 50MA	28480	1901-0040	
ABA2CR2 †	1901-0040		DIODE; SWITCHING;SI ; 30V MAX VRM 50MA	28480	1901-0040	
ABA2L1 †	9100-1622		COIL; FXD; MOLDED RF CHOKE; 24UH 5%	24226	15/242	
ABA2L2 †	9100-1620		COIL; FXD; MOLDED RF CHOKE; 15UH 10%	24226	15/152	
ABA2Q1	1854-0071	15	TRANSISTOR NPN SI PD=300MW FT=200MHZ	28480	1854-0071	
ABA2Q2	1853-0020		TRANSISTOR PNP SI PD=300MW FT=150MHZ	28480	1853-0020	
ABA2Q3	1853-0020		TRANSISTOR PNP SI PD=300MW FT=150MHZ	28480	1853-0020	
ABA2Q4	1854-0071		TRANSISTOR NPN SI PD=300MW FT=200MHZ	28480	1854-0071	
ABA2Q5	1854-0071		TRANSISTOR NPN SI PD=300MW FT=200MHZ	28480	1854-0071	
ABA2Q6	1855-0062	2	TRANSISTOR, JFET N-CHAN D-MODE SI	28480	1855-0062	
ABA2Q7	1853-0020		TRANSISTOR PNP SI PD=300MW FT=150MHZ	28480	1853-0020	
ABA2Q8	1854-0071		TRANSISTOR NPN SI PD=300MW FT=200MHZ	28480	1854-0071	
ABA2Q9	1854-0071		TRANSISTOR NPN SI PD=300MW FT=200MHZ	28480	1854-0071	
ABA2Q10	1854-0071		TRANSISTOR NPN SI PD=300MW FT=200MHZ	28480	1854-0071	
ABA2Q11	1854-0071	1	TRANSISTOR NPN SI PD=300MW FT=200MHZ	28480	1854-0071	
ABA2Q12	1854-0071		TRANSISTOR NPN SI PD=300MW FT=200MHZ	28480	1854-0071	
ABA2Q13	1853-0020		TRANSISTOR PNP SI PD=300MW FT=150MHZ	28480	1853-0020	
ABA2Q14	1854-0071		TRANSISTOR NPN SI PD=300MW FT=200MHZ	28480	1854-0071	
ABA2Q15	1854-0071		TRANSISTOR NPN SI PD=300MW FT=200MHZ	28480	1854-0071	
ABA2Q16	1853-0020	1	TRANSISTOR PNP SI PD=300MW FT=150MHZ	28480	1853-0020	
ABA2Q17	1853-0020		TRANSISTOR PNP SI PD=300MW FT=150MHZ	28480	1853-0020	
ABA2Q18	1854-0071		TRANSISTOR NPN SI PD=300MW FT=200MHZ	28480	1854-0071	
ABA2R1	0698-3440		RESISTOR; FXD; 196 OHM1% .125W F	16299	C4-1/8-T0-196R-F	
ABA2R2	0757-0438		RESISTOR; FXD; 5.11K1% .125W F TUBULAR	24546	C4-1/8-T0-5111-F	
ABA2R3	0698-7253	6	RESISTOR; FXD; 5.11K2% .05W F TUBULAR	24546	C3-1/8-T0-5111-G	
ABA2R4	0698-7253		RESISTOR; FXD; 5.11K2% .05W F TUBULAR	24546	C3-1/8-T0-5111-G	
ABA2R5	0698-7239	2	RESISTOR; FXD; 1.33K2% .05W F TUBULAR	24546	C3-1/8-T0-1331-G	
ABA2R6	0698-7239		RESISTOR; FXD; 1.33K2% .05W F TUBULAR	24546	C3-1/8-T0-1331-G	
ABA2R7	0698-7246	4	RESISTOR; FXD; 2.61K2% .05W F TUBULAR	24546	C3-1/8-T0-2611-G	
ABA2R8	0698-7246	5	RESISTOR; FXD; 2.61K2% .05W F TUBULAR	24546	C3-1/8-T0-2611-G	
ABA2R9	0698-7277		RESISTOR; FXD; 51.1K2% .05W F TUBULAR	24546	C3-1/8-T0-5112-G	
ABA2R10	0698-7277		RESISTOR; FXD; 51.1K2% .05W F TUBULAR	24546	C3-1/8-T0-5112-G	
ABA2R11	0683-8245		2	RESISTOR; FXD; 820K5% .25W CC TUBULAR	01121	C88245
ABA2R12	0683-8245			RESISTOR; FXD; 820K5% .25W CC TUBULAR	01121	C88245
ABA2R13	0698-7267	2	RESISTOR; FXD; 19.6K2% .05W F TUBULAR	24546	C3-1/8-T0-1962-G	
ABA2R14	0698-7272		RESISTOR; FXD; 31.6K2% .05W F TUBULAR	24546	C3-1/8-T0-3162-G	
ABA2R15	0698-7277	1	RESISTOR; FXD; 51.1K2% .05W F TUBULAR	24546	C3-1/8-T0-5112-G	
ABA2R16	0698-7267		RESISTOR; FXD; 19.6K2% .05W F TUBULAR	24546	C3-1/8-T0-1962-G	
ABA2R17	0698-7284		3	RESISTOR; FXD; 100K2% .05W F TUBULAR	24546	C3-1/8-T0-1003-G
ABA2R18	0698-7284		1	RESISTOR; FXD; 100K2% .05W F TUBULAR	24546	C3-1/8-T0-1003-G
ABA2R19	0698-7277			RESISTOR; FXD; 51.1K2% .05W F TUBULAR	24546	C3-1/8-T0-5112-G
ABA2R20	0698-7288	RESISTOR; FXD; 147K2% .05W F TUBULAR		24546	C3-1/8-T0-1473-G	
ABA2R21	0698-7253	RESISTOR; FXD; 5.11K2% .05W F TUBULAR		24546	C3-1/8-T0-5111-G	
ABA2R22	0698-7253	RESISTOR; FXD; 5.11K2% .05W F TUBULAR		24546	C3-1/8-T0-5111-G	
ABA2R23	0698-7277	7	RESISTOR; FXD; 51.1K2% .05W F TUBULAR	24546	C3-1/8-T0-5112-G	
ABA2R24	0698-7260		RESISTOR; FXD; 10K2% .05W F TUBULAR	24546	C3-1/8-T0-1002-G	
ABA2R25	0698-7284		RESISTOR; FXD; 100K2% .05W F TUBULAR	24546	C3-1/8-T0-1003-G	
ABA2R26	0698-3453	6	RESISTOR; FXD; 196K1% .125W F TUBULAR	16299	C4-1/8-T0-1963-F	
ABA2R27	0698-7260		RESISTOR; FXD; 10K2% .05W F TUBULAR	24546	C3-1/8-T0-1002-G	
ABA2R28	0698-7260	1	RESISTOR; FXD; 10K2% .05W F TUBULAR	24546	C3-1/8-T0-1002-G	
ABA2R29	0698-7256		RESISTOR; FXD; 6.81K2% .05W F TUBULAR	24546	C3-1/8-T0-6811-G	
ABA2R30	0698-7258		RESISTOR; FXD; 8.25K2% .05W F TUBULAR	24546	C3-1/8-T0-8251-G	
ABA2R31	0698-7260		RESISTOR; FXD; 10K2% .05W F TUBULAR	24546	C3-1/8-T0-1002-G	
ABA2R32	0698-7260		RESISTOR; FXD; 10K2% .05W F TUBULAR	24546	C3-1/8-T0-1002-G	
ABA2R33	0698-7264	1	RESISTOR; FXD; 14.7K2% .05W F TUBULAR	24546	C3-1/8-T0-1472-G	
ABA2R34	0698-7243		RESISTOR; FXD; 1.96K2% .05W F TUBULAR	24546	C3-1/8-T0-1961-G	
ABA2R35	0698-7229		RESISTOR; FXD; 511 OHM2% .05W F TUBULAR	24546	C3-1/8-T0-511R-G	
ABA2R36	0757-0442		RESISTOR; FXD; 10K1% .125W F TUBULAR	24546	C4-1/8-T0-1002-F	
ABA2R37	0757-0416		RESISTOR; FXD; 511 OHM1% .125W F	24546	C4-1/8-T0-511R-F	
ABA2R38	0698-3442		1	RESISTOR; FXD; 237 OHM1% .125W F	16299	C4-1/8-T0-237R-F
ABA2R39	0757-0442	RESISTOR; FXD; 10K1% .125W F TUBULAR		24546	C4-1/8-T0-1002-F	
ABA2R40	0757-0279	RESISTOR; FXD; 3.16K1% .125W F TUBULAR		24546	C4-1/8-T0-3161-F	
ABA2R41	0757-0442	RESISTOR; FXD; 10K1% .125W F TUBULAR		24546	C4-1/8-T0-1002-F	
ABA2R42	0698-0083	RESISTOR; FXD; 1.96K1% .125W F TUBULAR		16299	C4-1/8-T0-1961-F	
ABA2R43	0698-0083	1		RESISTOR; FXD; 1.96K1% .125W F TUBULAR	16299	C4-1/8-T0-1961-F
ABA2R44	0698-0083		RESISTOR; FXD; 1.96K1% .125W F TUBULAR	16299	C4-1/8-T0-1961-F	
ABA2R45	0757-0416		RESISTOR; FXD; 511 OHM1% .125W F	24546	C4-1/8-T0-511R-F	
ABA2R46 †	0757-0416		NOT ASSIGNED			
ABA2R47 †			RESISTOR; FXD; 511 OHM1% .125W F	24546	C4-1/8-T0-511R-F	

See introduction to this section for ordering information  
 † SEE TABLES 7-1 AND 7-2, FOR BACKDATING.

Table 6-3. Replaceable Parts

Reference Designation	HP Part Number	Qty	Description	Mfr Code	Mfr Part Number
ABA2R48 †			NOT ASSIGNED		
ABA2R49	0698-7229		RESISTOR; FXD; 511 OHM2% .05W F TUBULAR	24546	C3-1/8-T0-511R-G
ABA2R50	0757-0280		RESISTOR; FXD; 1K1% .125W F TUBULAR	24546	C4-1/8-T0-1001-F
ABA2R51	0698-7248		RESISTOR; FXD; 3.16K2% .05W F TUBULAR	24546	C3-1/8-T0-3161-G
ABA2R52	0698-7248		RESISTOR; FXD; 3.16K2% .05W F TUBULAR	24546	C3-1/8-T0-3161-G
ABA2R53	0698-7229		RESISTOR; FXD; 511 OHM2% .05W F TUBULAR	24546	C3-1/8-T0-511R-G
ABA2R54	0698-7229		RESISTOR; FXD; 511 OHM2% .05W F TUBULAR	24546	C3-1/8-T0-511R-G
ABA2R55 †	0698-7236		RESISTOR; FXD; 1K2% .05W F TUBULAR	24546	C3-1/8-T0-1001-G
ABA2R56 †	0811-1662	1	RESISTOR; FXD; .47 OHM5% 2W PW TUBULAR	75042	BWH2-47/100-J
ABA2R57 †	0698-7219	3	RESISTOR; FXD; 196 OHM2% .05W F TUBULAR	24546	C3-1/8-T0-196R-G
ABA2S1A	3101-1729	1	SWITCH, PB -STA DPDT(INCL ABA2S1A,B,C)	28480	3101-1729
ABA2S1B			N.S.R PART OF ABA2S1A		
ABA2S1C			N.S.R PART OF ABA2S1A		
ABA2TP1	0360-1514		TERMINAL, SLDR STUD	28480	0360-1514
ABA2TP2	0360-1514		TERMINAL, SLDR STUD	28480	0360-1514
ABA2TP3	0360-1514		TERMINAL, SLDR STUD	28480	0360-1514
ABA2TP4	0360-1514		TERMINAL, SLDR STUD	28480	0360-1514
ABA2TP5	0360-1514		TERMINAL, SLDR STUD	28480	0360-1514
ABA2TP6	0360-1514		TERMINAL, SLDR STUD	28480	0360-1514
ABA2U1	1820-0077	4	IC;DGTL;FLIP-FLOP	01295	SN7474N
ABA2U2	1820-0054		IC;DGTL;GATE	01295	SN7400N
ABA2U3	1820-0054		IC;DGTL;GATE	01295	SN7400N
ABA2U4	1820-0174	2	IC;DGTL;INVERTER	01295	SN7404N
ABA2U5	1820-0077		IC;DGTL;FLIP-FLOP	01295	SN7474N
ABA2U6	1820-0328	3	IC;DGTL;GATE	01295	SN7402N
ABA2U7	1820-0701	6	IC;DGTL;LATCH	07263	93L14DC
ABA2U8	1820-0701		IC;DGTL;LATCH	07263	93L14DC
ABA2U9	1820-0701		IC;DGTL;LATCH	07263	93L14DC
ABA2U10	1820-0701		IC;DGTL;LATCH	07263	93L14DC
ABA2U11	1820-0701		IC;DGTL;LATCH	07263	93L14DC
ABA2U12	1820-0701		IC;DGTL;LATCH	07263	93L14DC
ABA2U13	1820-0511	3	IC;DGTL;GATE	01295	SN7408N
ABA2U14	1820-0661		IC;DGTL;GATE	01295	SN7432N
ABA2U15	1820-0054		IC;DGTL;GATE	01295	SN7400N
ABA2U16	1820-0054		IC;DGTL;GATE	01295	SN7400N
ABA2U17	1820-0511		IC;DGTL;GATE	01295	SN7408N
ABA2U18	1820-0511		IC;DGTL;GATE	01295	SN7408N
ABA2U19	1820-0546	7	IC;DGTL;COUNTER	01295	SN74192N
ABA2U20	1820-0546		IC;DGTL;COUNTER	01295	SN74192N
ABA2U21	1820-0546		IC;DGTL;COUNTER	01295	SN74192N
ABA2U22	1820-0546		IC;DGTL;COUNTER	01295	SN74192N
ABA2U23	1820-0546		IC;DGTL;COUNTER	01295	SN74192N
ABA2U24	1820-0546		IC;DGTL;COUNTER	01295	SN74192N
ABA2U25	1820-0328		IC;DGTL;GATE	01295	SN7402N
ABA2U26	1820-0077		IC;DGTL;FLIP-FLOP	01295	SN7474N
ABA2U27	1820-0205	1	INTEGRATED CIRCUIT, DGTL, TTL QUAD 2	04713	MC3003P
ABA2U28	1820-0546		IC;DGTL;COUNTER	01295	SN74192N
ABA2U29	1826-0092	2	IC;LIN;OPERATIONAL AMPLIFIER	02735	CA3458T
ABA2VR1	1902-3070	1	DIODE; ZENER; 4.22V VZ; .4W MAX PD	04713	SZ 10939-74
ABA2VR2	1902-3182	1	DIODE; ZENER; 12.1V VZ; .4W MAX PD	04713	SZ 10939-206
ABA3	08640-60026	1	TIME BASE ASSY	28480	08640-60026
ABA3	08640-60090		REBUILT 08640-60026, REQUIRES EXCHANGE	28480	08640-60090
ABA3C1	0160-3094		CAPACITOR;FXD; .1UF+-10% 100WVDC	28480	0160-3094
ABA3C2	0160-3094		CAPACITOR;FXD; .1UF+-10% 100WVDC	28480	0160-3094
ABA3C3	0160-3094		CAPACITOR;FXD; .1UF+-10% 100WVDC	28480	0160-3094
ABA3C4	0160-3094		CAPACITOR;FXD; .1UF+-10% 100WVDC	28480	0160-3094
ABA3C5	0160-3094		CAPACITOR;FXD; .1UF+-10% 100WVDC	28480	0160-3094
ABA3C6	0160-3094		CAPACITOR;FXD; .1UF+-10% 100WVDC	28480	0160-3094
ABA3C7			NOT ASSIGNED		
ABA3C8	0160-2055		CAPACITOR,FXD, .01UF+80-20% 100WVDC	28480	0160-2055
ABA3C9	0160-2055		CAPACITOR,FXD, .01UF+80-20% 100WVDC	28480	0160-2055
ABA3C10	0160-2055		CAPACITOR,FXD, .01UF+80-20% 100WVDC	28480	0160-2055
ABA3C11	0160-2055		CAPACITOR,FXD, .01UF+80-20% 100WVDC	28480	0160-2055
ABA3C12	0160-2055		CAPACITOR,FXD, .01UF+80-20% 100WVDC	28480	0160-2055
ABA3C13	0160-2055		CAPACITOR,FXD, .01UF+80-20% 100WVDC	28480	0160-2055
ABA3C14	0160-3094		CAPACITOR;FXD; .1UF+-10% 100WVDC	28480	0160-3094
ABA3C15	0160-3879		CAPACITOR;FXD; .01UF+-20% 100WVDC	28480	0160-3879
ABA3C16	0160-2055		CAPACITOR,FXD, .01UF+80-20% 100WVDC	28480	0160-2055
ABA3C17	0160-3094		CAPACITOR;FXD; .1UF+-10% 100WVDC	28480	0160-3094
ABA3C18	0160-2055		CAPACITOR,FXD, .01UF+80-20% 100WVDC	28480	0160-2055
ABA3C19	0160-3879		CAPACITOR;FXD; .01UF+-20% 100WVDC	28480	0160-3879
ABA3C20	0160-3879		CAPACITOR;FXD; .01UF+-20% 100WVDC	28480	0160-3879

See introduction to this section for ordering information  
 † SEE TABLES 7-1 AND 7-2, FOR BACKDATING.

Table 6-3. Replaceable Parts

Reference Designation	HP Part Number	Qty	Description	Mfr Code	Mfr Part Number
ABA3C21	0160-3877	1	CAPACITOR;FXD; 100PF+-20% 200WVDC	28480	0160-3877
ABA3C22	0160-3877		CAPACITOR;FXD; 100PF+-20% 200WVDC	28480	0160-3877
ABA3C23	0160-3457		CAPACITOR;FXD, .002UF+-10% 250WVDC	28480	0160-3457
ABA3C24	0160-3456		CAPACITOR;FXD; .001UF+-10% 1000WVDC	28480	0160-3456
ABA3C25	0160-3094		CAPACITOR;FXD; .1UF+-10% 100WVDC	28480	0160-3094
ABA3C26	0160-2055	1	CAPACITOR;FXD, .01UF+80-20% 100WVDC	28480	0160-2055
ABA3C27	0180-0197		CAPACITOR-FXD, 2.2UF+-10% 20VDC TA	56289	150D225X9020A2
ABA3C28	0180-0197		CAPACITOR-FXD, 2.2UF+-10% 20VDC TA	56289	150D225X9020A2
ABA3C29	0180-0197		CAPACITOR-FXD, 2.2UF+-10% 20VDC TA	56289	150D225X9020A2
ABA3C30	0180-0197		CAPACITOR-FXD, 2.2UF+-10% 20VDC TA	56289	150D225X9020A2
ABA3C31	0180-0197	1	CAPACITOR-FXD, 2.2UF+-10% 20VDC TA	56289	150D225X9020A2
ABA3C32	0160-3094		CAPACITOR;FXD; .1UF+-10% 100WVDC	28480	0160-3094
ABA3C33	0160-2055		CAPACITOR;FXD, .01UF+80-20% 100WVDC	28480	0160-2055
ABA3C34	0180-0197		CAPACITOR-FXD, 2.2UF+-10% 20VDC TA	56289	150D225X9020A2
ABA3C35	0180-0197		CAPACITOR-FXD, 2.2UF+-10% 20VDC TA	56289	150D225X9020A2
ABA3C36	0180-0197	1	CAPACITOR-FXD, 2.2UF+-10% 20VDC TA	56289	150D225X9020A2
ABA3C37	0180-0197		CAPACITOR-FXD, 2.2UF+-10% 20VDC TA	56289	150D225X9020A2
ABA3C38	0160-2055		CAPACITOR;FXD, .01UF+80-20% 100WVDC	28480	0160-2055
ABA3C39	0180-0197		CAPACITOR-FXD, 2.2UF+-10% 20VDC TA	56289	150D225X9020A2
ABA3C40	0160-3456		1	CAPACITOR;FXD; .001UF+-10% 1000WVDC	28480
ABA3CR1	1901-0040	DIODE; SWITCHING; SI; 30V MAX VRM 50MA		28480	1901-0040
ABA3J1	1250-1383	CONNECTOR-COAX, 5M SNP, 50 OHM MALE		28480	1250-1383
ABA3L1	9140-0137	11	COIL; FXD; MOLDED RF CHOKE; 1MH 5%	24226	19/104
ABA3L2	9140-0137	11	COIL; FXD; MOLDED RF CHOKE; 1MH 5%	24226	19/104
ABA3L3	9140-0137		COIL; FXD; MOLDED RF CHOKE; 1MH 5%	24226	19/104
ABA3L4	9140-0137		COIL; FXD; MOLDED RF CHOKE; 1MH 5%	24226	19/104
ABA3L5	9140-0137		COIL; FXD; MOLDED RF CHOKE; 1MH 5%	24226	19/104
ABA3L6	9140-0137		COIL; FXD; MOLDED RF CHOKE; 1MH 5%	24226	19/104
ABA3L7	9140-0137		COIL; FXD; MOLDED RF CHOKE; 1MH 5%	24226	19/104
ABA3L8	9140-0137	8	COIL; FXD; MOLDED RF CHOKE; 1MH 5%	24226	19/104
ABA3L9	9140-0137		COIL; FXD; MOLDED RF CHOKE; 1MH 5%	24226	19/104
ABA3L10	08640-80001		TORRID FILTER	28480	08640-80001
ABA3L11	9140-0137		COIL; FXD; MOLDED RF CHOKE; 1MH 5%	24226	19/104
ABA3L12	08640-80001		TORRID FILTER	28480	08640-80001
ABA3L13	08640-80001	23	TORRID FILTER	28480	08640-80001
ABA3L14	08640-80001		TORRID FILTER	28480	08640-80001
ABA3MP1	2190-0003		WASHER; LOCK; HELICAL; 4 .115 ID .253	28480	2190-0003
ABA3MP2	2200-0155	1	SCREW;MACHINE; 4-40 UNC-2A 1 IN PAN	28480	2200-0155
ABA3MP3	2260-0001		NUT, HEX 4-40 .094 X .25, SST, PSVT	80120	
ABA3MP4	08640-20211	3	GUIDE+CONNECTOR	28480	08640-20211
ABA3MP5	08640-40040	1	INSULATOR SWITCH	28480	08640-40040
ABA3Q1	1854-0019	1	TRANSISTOR NPN SI PD=360MW FT=500MHZ	28480	1854-0019
ABA3Q2	1854-0019		TRANSISTOR NPN SI PD=360MW FT=500MHZ	28480	1854-0019
ABA3R1		2	NOT ASSIGNED		
ABA3R2	0757-0274		RESISTOR; FXD; 1.21K1% .125W F TUBULAR	24546	C4-1/8-T0-1213-F
ABA3R3	0757-0442		RESISTOR; FXD; 10K1% .125W F TUBULAR	24546	C4-1/8-T0-1002-F
ABA3R4	0757-0438		RESISTOR; FXD; 5.11K1% .125W F TUBULAR	24546	C4-1/8-T0-5111-F
ABA3R5	0698-7229		RESISTOR; FXD; 5.11 OHM2% .05W F TUBULAR	24546	C3-1/8-T0-511R-G
ABA3R6	0757-0416	1	RESISTOR; FXD; 511 OHM1% .125W F	24546	C4-1/8-T0-511R-F
ABA3R7	0757-0442		RESISTOR; FXD; 10K1% .125W F TUBULAR	24546	C4-1/8-T0-1002-F
ABA3R8	0757-0442		RESISTOR; FXD; 10K1% .125W F TUBULAR	24546	C4-1/8-T0-1002-F
ABA3R9	0698-0085		RESISTOR; FXD; 2.61K1% .125W F TUBULAR	16299	C4-1/8-T0-2611-F
ABA3R10	0757-0279		RESISTOR; FXD; 3.16K1% .125W F TUBULAR	24546	C4-1/8-T0-3161-F
ABA3R11	0757-0416	1	RESISTOR; FXD; 511 OHM1% .125W F	24546	C4-1/8-T0-511R-F
ABA3R12	0757-0416		RESISTOR; FXD; 511 OHM1% .125W F	24546	C4-1/8-T0-511R-F
ABA3R13	0757-0438		RESISTOR; FXD; 5.11K1% .125W F TUBULAR	24546	C4-1/8-T0-5111-F
ABA3R14	0757-0438		RESISTOR; FXD; 5.11K1% .125W F TUBULAR	24546	C4-1/8-T0-5111-F
ABA3R15	0757-0438		RESISTOR; FXD; 5.11K1% .125W F TUBULAR	24546	C4-1/8-T0-5111-F
ABA3R16	0757-0438	1	RESISTOR; FXD; 5.11K1% .125W F TUBULAR	24546	C4-1/8-T0-5111-F
ABA3R17	0757-0279		RESISTOR; FXD; 3.16K1% .125W F TUBULAR	24546	C4-1/8-T0-3161-F
ABA3R18	0757-0399		RESISTOR; FXD; 82.5 OHM1% .125W F	24546	C4-1/8-T0-82R5-F
ABA3R19	0698-3437		RESISTOR; FXD; 133 OHM1% .125W F	16299	C4-1/8-T0-133R-F
ABA3R20	0698-3160		RESISTOR; FXD; 31.6K1% .125W F TUBULAR	16299	C4-1/8-T0-3162-F
ABA3R21	0698-3444	1	RESISTOR; FXD; 316 OHM1% .125W F	16299	C4-1/8-T0-316R-F
ABA3R22	0757-0280		RESISTOR; FXD; 1K1% .125W F TUBULAR	24546	C4-1/8-T0-1001-F
ABA3R23	0698-3440		RESISTOR; FXD; 196 OHM1% .125W F	16299	C4-1/8-T0-196R-F
ABA3S1A	3101-1730		SWITCH, PB -STA DPDT(INCL A8A3S1A,B,C)	28480	3101-1730
ABA3S1B			N.S.R. PART OF A8A3S1A		
ABA3S1C		1	N.S.R. PART OF A8A3S1A		
ABA3TP1	0360-1514		TERMINAL, SLDR STUD	28480	0360-1514
ABA3U1	1820-0054		IC;DGTL;GATE	01295	SN7400N
ABA3U2	1820-0077		IC;DGTL;FLIP-FLOP	01295	SN7474N
ABA3U3	1820-0268		IC;DGTL;SHIFT REGISTER	01295	SN7496N

See introduction to this section for ordering information

Table 6-3. Replaceable Parts

Reference Designation	HP Part Number	Qty	Description	Mfr Code	Mfr Part Number
ABA3U4	1820-0511		IC;DGTL;GATE	01295	SN7408N
ABA3U5	1820-0661		IC;DGTL;GATE	01295	SN7432N
ABA3U6	1820-0661		IC;DGTL;GATE	01295	SN7432N
ABA3U7	1820-0174		IC;DGTL;INVERTER	01295	SN7404N
ABA3U8	1820-0054		IC;DGTL;GATE	01295	SN7400N
ABA3U9	1820-0054		IC;DGTL;GATE	01295	SN7400N
ABA3U10	1820-0600	4	INTEGRATED CIRCUIT, DGTL, TTL DECADE	27014	DM74L90N
ABA3U11	1820-0600		INTEGRATED CIRCUIT, DGTL, TTL DECADE	27014	DM74L90N
ABA3U12	1820-0055	1	IC;DGTL;COUNTER	01295	SN7490N
ABA3U13	1820-0986	3	INTEGRATED CIRCUIT, DGTL, TTL LP DECADE	27014	DM86L75N
ABA3U14	1820-0986		INTEGRATED CIRCUIT, DGTL, TTL LP DECADE	27014	DM86L75N
ABA3U15	1820-0986		INTEGRATED CIRCUIT, DGTL, TTL LP DECADE	27014	DM86L75N
ABA3U16	1820-0600		INTEGRATED CIRCUIT, DGTL, TTL DECADE	27014	DM74L90N
ABA3U17	1820-0600		INTEGRATED CIRCUIT, DGTL, TTL DECADE	27014	DM74L90N
ABA3VR1	1902-3203	2	DIODE; ZENER; 14.7V VZ; .4W MAX PD	04713	SZ 10939-230
ABA3XA5	1251-2035	5	CONNECTOR, PC EDGE, 15-CONT, DIP SOLDER	71785	252-15-30-300
ABA3Y1	1813-0006	1	CRYSTAL OSCILLATOR	28480	1813-0006
ABA4	08640-60025	1	COUNTER/DISPLAY ASSY	28480	08640-60025
ABA4DS1	2140-0356		LAMP; INCAND; BULB T1; 5V	71744	CM7-7683
ABA4DS2	2140-0016	1	LAMP, INCAND, BULB T-1, 5V	71744	683
ABA4MP1	03431-01201	3	BRACKET;MOUNTING	50443	03431-01201
ABA4MP2	03431-01201		BRACKET;MOUNTING	50443	03431-01201
ABA4MP3	03431-01201		BRACKET;MOUNTING	50443	03431-01201
ABA4P1A	1260-0363	1	CONNECTOR;11 PIN	28480	1260-0363
ABA4P1B	1260-0364	1	CONNECTOR;25 PIN	28480	1260-0364
ABA4Q1	1854-0071		TRANSISTOR NPN SI PD=300MW FT=200MHZ	28480	1854-0071
ABA4R1	2100-3299	1	RESISTOR, VAR, 5K 20% MC SPST SW	28480	2100-3299
ABA4R2	2100-1738	1	RESISTOR; VAR; TRMR; 10KOHM 10% C	19701	ET50W103
ABA4R3	0698-7277	1	RESISTOR; FXD; 51.1K2% .125W F TUBULAR	24546	C4-1/8-T0-5112-F
ABA4R4			NOT ASSIGNED		
ABA4R5	0698-7276	1	RESISTOR, FXD, 46.4K2% .125W F TUBULAR	24546	C4-1/8-T0-4642-F
ABA4XDS1A, 1B†	1251-2194	2	CONNECTOR, 1 CONT SKT 0.021" DIA	28480	1251-2194
ABA5	08640-60028	1	RISER ASSY	28480	08640-60028
ABA5XAB A2	1251-2035		CONNECTOR, PC EDGE, 15-CONT, DIP SOLDER	71785	252-15-30-300
A9	08640-60117	1	PEAK DEVIATION AND RANGE SWITCH ASSY	28480	08640-60117
A9	08640-60082		REBUILT 08640-60117, REQUIRES EXCHANGE	28480	08640-60082
A9C1	0140-0191	6	CAPACITOR;FXD; 56PF+-5% 300WVDC	72136	DM15E560J0300WV1CR
A9C2	0140-0191		CAPACITOR;FXD; 56PF+-5% 300WVDC	72136	DM15E560J0300WV1CR
A9C3	0140-0191		CAPACITOR;FXD; 56PF+-5% 300WVDC	72136	DM15E560J0300WV1CR
A9C4	0140-0191		CAPACITOR;FXD; 56PF+-5% 300WVDC	72136	DM15E560J0300WV1CR
A9C5	0140-0191		CAPACITOR;FXD; 56PF+-5% 300WVDC	72136	DM15E560J0300WV1CR
A9MP1	0510-0052	14	RETAINER, RING	79136	5133-12-S-MD-R
A9MP2	1430-0759		GEAR SPUR	28480	1430-0759
A9MP3	1430-0772	2	GEAR;PLANET	28480	1430-0772
A9MP4	1430-0773	1	GEAR;COMBINATION	28480	1430-0773
A9MP5	1430-0774	1	GEAR;COMBINATION	28480	1430-0774
A9MP6	3050-0099	2	WASHER; FLAT .25 ID .5 OD	28480	3050-0099
A9MP7	5040-0218		COUPLER;SWITCH SHAFT	28480	5040-0218
A9MP8	08640-00019	1	SUPPORT;SWITCH	28480	08640-00019
A9MP9	08640-40039	1	SHAFT;ADJUSTABLE	28480	08640-40039
A9MP10	08640-40045	1	SHAFT;SWITCH AF BAND	28480	08640-40045
A9P1	1251-2799	1	CONNECTOR, PC EDGE, 15-CONT, SOLDER EYE	71785	251-15-30-400
A9R1	2100-3262	1	RESISTOR, VAR, CONT, 2.5K 10% C	28480	2100-3262
A9R2	0698-4014	1	RESISTOR; FXD; 787 OHM1% .125W F	16299	C4-1/8-T0-787R-F
A9R3			NOT ASSIGNED		
A9R4	0757-0280		RESISTOR; FXD; 1K1% .125W F TUBULAR	24546	C4-1/8-T0-1001-F
A9R5	0757-0278	5	RESISTOR; FXD; 1.78K1% .125W F TUBULAR	24546	C4-1/8-T0-1781-F
A9R6	0757-0274		RESISTOR; FXD; 1.21K1% .125W F TUBULAR	24546	C4-1/8-T0-1213-F
A9R7	0757-0416		RESISTOR; FXD; 511 OHM1% .125W F	24546	C4-1/8-T0-511R-F
A9R8	0698-0082	4	RESISTOR; FXD; 464 OHM1% .125W F	16299	C4-1/8-T0-4640-F
A9R9	0757-0280		RESISTOR; FXD; 1K1% .125W F TUBULAR	24546	C4-1/8-T0-1001-F
A9R10	0698-8211	1	R;FXD FLM 2K OHM 0.25, 1/4W	30983	MF52C1/4-T9-2001-C
A9R11	0757-0280		RESISTOR; FXD; 1K1% .125W F TUBULAR	24546	C4-1/8-T0-1001-F
A9R12	0698-8212	1	RESISTOR; FXD; 6K.25% .125W F TUBULAR	30983	MF4C1/4-T9-6091-C
A9R13	0698-5669	6	RESISTOR; FXD; 1.5K.25% .125W F TUBULAR	19701	MF4C1/8-T9-1501-C
A9R14	0698-8213	4	RESISTOR; FXD; 3K.25% .125W F TUBULAR	30983	MF4C1/4-T9-3091-C
A9R15	0698-5669		RESISTOR; FXD; 1.5K.25% .125W F TUBULAR	19701	MF4C1/8-T9-1501-C

See introduction to this section for ordering information  
 † SEE TABLES 7-1 AND 7-2, FOR BACKDATING.

Table 6-3. Replaceable Parts

Reference Designation	HP Part Number	Qty	Description	Mfr Code	Mfr Part Number
A9R16	0698-8213		RESISTOR; FXD; 3K.25% .125W F TUBULAR	30983	MF4C1/4-T9-3001-C
A9R17	0698-5669		RESISTOR; FXD; 1.5K.25% .125W F TUBULAR	19701	MF4C1/8-T9-1501-C
A9R18	0698-8213		RESISTOR; FXD; 3K.25% .125W F TUBULAR	30983	MF4C1/4-T9-3001-C
A9R19	0698-5669		RESISTOR; FXD; 1.5K.25% .125W F TUBULAR	19701	MF4C1/8-T9-1501-C
A9R20	0698-8213		RESISTOR; FXD; 3K.25% .125W F TUBULAR	30983	MF4C1/4-T9-3001-C
A9R21	0698-5669		RESISTOR; FXD; 1.5K.25% .125W F TUBULAR	19701	MF4C1/8-T9-1501-C
A9R22	0698-5669		RESISTOR; FXD; 1.5K.25% .125W F TUBULAR	19701	MF4C1/8-T9-1501-C
A9R23	0698-8299	1	RESISTOR; FXD; 4.259K.25% .125W F	30983	MF4C1/8-T9-4259F-C
A9R24	0698-8298	1	RESISTOR; FXD; 1.071K.25% .125W F	30983	MF4C1/8-T9-1071R-C
A9R25	0698-8297	1	RESISTOR; FXD; 1.284K.25% .125W F	30983	MF4C1/8-T9-1284R-C
A9R26	0757-0398		RESISTOR; FXD; 75 OHM1% .125W F TUBULAR	24546	C4-1/8-T0-75R0-F
A9R27	0698-8296	1	RESISTOR; FXD; 1.493K.25% .125W F	30983	MF4C1/8-T9-1493R-C
A9R28	0757-0399		RESISTOR; FXD; 82.5 OHM1% .125W F	24546	C4-1/8-T0-82R5-F
A9R29	0698-8295	1	RESISTOR; FXD; 1.556K.25% .125W F	30983	MF4C1/8-T9-1556R-C
A9R30	0757-0400		RESISTOR; FXD; 90.9 OHM1% .125W F	24546	C4-1/8-T0-90R9-F
A9R31	0757-0400		RESISTOR; FXD; 90.9 OHM1% .125W F	24546	C4-1/8-T0-90R9-F
A9W1 †	08640-60107	1	CABLE ASSY:PEAK DEVIATION	28480	08640-60107
A10	08640-60105	1	DIVIDER/FILTER ASSY	28480	08640-60105
A10MP1	0403-0156	2	GUIDE, PC BOARD, 1 L .25 W LEXAN, YELLOW	28480	0403-0156
A10MP2	0403-0157	2	GUIDE, PC BOARD, 1 L .25 W LEXAN, GREEN	28480	0403-0157
A10MP3	0403-0158	1	GUIDE, PC BOARD, 1 L .25 W LEXAN, BLUE	28480	0403-0158
A10MP4	8160-0226		GASKET MATL,RFI, RND SECT NICKEL ALLOY	28480	8160-0226
A1JMP5	08640-00047	1	SHIELD:SPRING #1	28480	08640-00047
A10MP6	08640-00048	1	SHIELD:SPRING #2	28480	08640-00048
A10MP7	08640-00049	1	SHIELD:SPRING #3	28480	08640-00049
A10MP8	08640-00050	1	SHIELD:SPRING #4	28480	08640-00050
A10MP9	08640-20098	1	CAST COVER:TOP D/F	28480	08640-20098
A10MP10	08640-20099	1	CAST:CENTER D/F	28480	08640-20099
A10MP11	2190-0003		WASHER; LOCK; HELICAL; 4 .115 ID .253	28480	2190-0003
A10MP12	2200-0101	13	SCREW;MACHINE; 4-40 UNC-2A .188 IN PAN	28480	2200-0101
A10MP13	2200-0121	4	SCREW;MACHINE; 4-40 UNC-2A 1.125 IN PAN	28480	2200-0121
A10MP14	2200-0147		SCREW;MACHINE; 4-40 UNC-2A .5 IN PAN	28480	2200-0147
A10MP15	2200-0127	8	SCREW;MACHINE; 4-40 UNC-2A 1.75 IN PAN	28480	2200-0127
A10MP16	2190-0124	3	WASHER; LOCK; INT; 10 .195 ID .311 OD	24931	LW101-30
A10MP17	2950-0078	5	NUT, HEX 10-32 .067 X .25, BRS, AU PL	24931	HN100-11
A10MP18	2200-0129	2	SCREW;MACHINE; 4-40 UNC-2A 2 IN PAN	28480	2200-0129
A10MP19	0361-1071	4	RIVET,BLIND, DOME HD 0.125" DIA	11815	AAP-4-3
A10A1	08640-60021	1	RF FILTER ASSY	28480	08640-60021
A10A1	08640-60091		REBUILT 08640-60021, REQUIRES EXCHANGE	28480	08640-60091
A10A1C1	0160-2055		CAPACITOR;FXD, .01UF+80-20% 100WVDC	28480	0160-2055
A10A1C2	0160-2055		CAPACITOR;FXD, .01UF+80-20% 100WVDC	28480	0160-2055
A10A1C3	0160-2055		CAPACITOR;FXD, .01UF+80-20% 100WVDC	28480	0160-2055
A10A1C4	0160-2055		CAPACITOR;FXD, .01UF+80-20% 100WVDC	28480	0160-2055
A10A1C5	0160-2055		CAPACITOR;FXD, .01UF+80-20% 100WVDC	28480	0160-2055
A10A1C6	0160-2055		CAPACITOR;FXD, .01UF+80-20% 100WVDC	28480	0160-2055
A10A1C7	0160-2055		CAPACITOR;FXD, .01UF+80-20% 100WVDC	28480	0160-2055
A10A1C8	0160-2055		CAPACITOR;FXD, .01UF+80-20% 100WVDC	28480	0160-2055
A10A1C9	0140-0219	2	CAPACITOR;FXD; 180PF+-2% 300WVDC	72136	DM15F181G0300WV1CR
A10A1C10	0140-0226	2	CAPACITOR;FXD; 320PF+-1% 300WVDC	72136	DM15F321F0300WV1CR
A10A1C11	0140-0226		CAPACITOR;FXD; 320PF+-1% 300WVDC	72136	DM15F321F0300WV1CR
A10A1C12	0140-0220	3	CAPACITOR;FXD; 200PF+-1% 300WVDC	72136	DM15F201F0300WV1CR
A10A1C13	0140-0195	2	CAPACITOR;FXD; 130PF+-5% 300WVDC	72136	DM15F131J0300WV1CR
A10A1C14	0140-0220		CAPACITOR;FXD; 200PF+-1% 300WVDC	72136	DM15F201F0300WV1CR
A10A1C15	0140-0220		CAPACITOR;FXD; 200PF+-1% 300WVDC	72136	DM15F201F0300WV1CR
A10A1C16	0140-0195		CAPACITOR;FXD; 130PF+-5% 300WVDC	72136	DM15F131J0300WV1CR
A10A1C17	0140-0150	1	CAPACITOR;FXD; 731.5PF+-1% 300WVDC	72136	DM15F731R5F0300WV1CR
A10A1C18	0160-3940	1	CAPACITOR;FXD; .0032UF+-1% 100WVDC	28480	0160-3940
A10A1C19	0160-2587	1	CAPACITOR;FXD; .004UF+-1% 100WVDC	28480	0160-2587
A10A1C20	0160-2675	1	CAPACITOR;FXD; .0039UF+-1% 300WVDC	28480	0160-2675
A10A1C21	0160-2276	1	CAPACITOR;FXD; .00278UF+-2% 300WVDC	28480	0160-2276
A10A1C22	0140-0172	1	CAPACITOR;FXD; .003UF+-1% 100WVDC	72136	DM19F302F0100WV1CR
A10A1C23	0160-2585	2	CAPACITOR;FXD; .002UF+-1% 100WVDC	28480	0160-2585
A10A1C24	0160-2537	1	CAPACITOR;FXD; 360PF+-1% 300WVDC	28480	0160-2537
A10A1C25	0160-0341	2	CAPACITOR;FXD; 640PF+-1% 300WVDC	28480	0160-0341
A10A1C26	0160-0341		CAPACITOR;FXD; 640PF+-1% 300WVDC	28480	0160-0341
A10A1C27	0140-0200	1	CAPACITOR;FXD; 390PF+-5% 300WVDC	72136	DM15F391J0300WV1CR

See introduction to this section for ordering information

† SEE TABLES 7-1 AND 7-2, FOR BACKDATING.

Table 6-3. Replaceable Parts

Reference Designation	HP Part Number	Qty	Description	Mfr Code	Mfr Part Number
A10A1C28	0140-0199	2	CAPACITOR;FXD; 240PF+-5% 300WVDC	72136	DM15F241J0300WV1CR
A10A1C29	0160-0939		CAPACITOR;FXD; 430PF+-5% 300WVDC	28480	0160-0939
A10A1C30	0160-0939		CAPACITOR;FXD; 430PF+-5% 300WVDC	28480	0160-0939
A10A1C31	0140-0199		CAPACITOR;FXD; 240PF+-5% 300WVDC	72136	DM15F241J0300WV1CR
A10A1C32	0160-2537		CAPACITOR;FXD; 360PF+-1% 300WVDC	72136	DM15F361F0300WV1C
A10A1C33	0160-3092	1	CAPACITOR;FXD; .0016UF+-1% 100WVDC	28480	0160-3092
A10A1C34	0160-2585		CAPACITOR;FXD; .002UF+-1% 100WVDC	28480	0160-2585
A10A1C35	0160-3937	1	CAPACITOR;FXD; .001916UF+-1% 100WVDC	28480	0160-3937
A10A1C36	0160-3939	1	CAPACITOR;FXD; .0014UF+-1% 100WVDC	28480	0160-3939
A10A1C37	0160-3938	1	CAPACITOR;FXD; .00147UF+-1% 100WVDC	28480	0160-3938
A10A1C38	0160-2387	2	CAPACITOR;FXD; .001UF+-1% 500WVDC	28480	0160-2387
A10A1C39	0160-0335	2	CAPACITOR;FXD; 91PF+-1% 300WVDC	28480	0160-0335
A10A1C40	0160-2206	2	CAPACITOR;FXD; 160PF+-5% 300WVDC	28480	0160-2206
A10A1C41	0160-2206		CAPACITOR;FXD; 160PF+-5% 300WVDC	28480	0160-2206
A10A1C42	0160-2204		CAPACITOR;FXD; 100PF+-5% 300WVDC	28480	0160-2204
A10A1C43	0140-0205	2	CAPACITOR;FXD; 62PF+-5% 300WVDC	72136	DM15E620J0300WV1CR
A10A1C44	0160-0839	2	CAPACITOR;FXD; 110PF+-1% 300WVDC	28480	0160-0839
A10A1C45	0160-0839		CAPACITOR;FXD; 110PF+-1% 300WVDC	28480	0160-0839
A10A1C46	0140-0205		CAPACITOR;FXD; 62PF+-5% 300WVDC	72136	DM15E620J0300WV1CR
A10A1C47	0140-0219		CAPACITOR;FXD; 180PF+-2% 300WVDC	72136	DM15F181G0300WV1CR
A10A1C48	0160-0342	1	CAPACITOR;FXD; 800PF+-1% 300WVDC	28480	0160-0342
A10A1C49	0160-2387		CAPACITOR;FXD; .001UF+-1% 500WVDC	28480	0160-2387
A10A1C50	0160-3935	1	CAPACITOR;FXD; 958PF+-1% 100WVDC	28480	0160-3935
A10A1C51	0160-3936	1	CAPACITOR;FXD; 700PF+-1% 100WVDC	28480	0160-3936
A10A1C52	0140-0150		CAPACITOR;FXD; 731.5PF+-1% 300WVDC	28480	0160-3162
A10A1C53	0140-0234	2	CAPACITOR;FXD; 500PF+-1% 300WVDC	72136	DM15F501F0300WV1C
A10A1C54	0160-2307	3	CAPACITOR;FXD; 47PF+-5% 300WVDC	28480	0160-2307
A10A1C55	0160-0974	2	CAPACITOR;FXD; 80PF+-2% 300WVDC	72136	DM15E800G0300WV1CR
A10A1C56	0160-0974		CAPACITOR;FXD; 80PF+-2% 300WVDC	72136	DM15E800G0300WV1CR
A10A1C57	0160-2201		CAPACITOR;FXD; 51PF+-5% 300WVDC	28480	0160-2201
A10A1C58	0160-2306	1	CAPACITOR;FXD; 27PF+-5% 300WVDC	28480	0160-2306
A10A1C59	0160-2201		CAPACITOR;FXD; 51PF+-5% 300WVDC	28480	0160-2201
A10A1C60	0160-2201		CAPACITOR;FXD; 51PF+-5% 300WVDC	28480	0160-2201
A10A1C61	0160-2199		CAPACITOR;FXD; 30PF+-5% 300WVDC	28480	0160-2199
A10A1C62	0160-0335		CAPACITOR;FXD; 91PF+-1% 300WVDC	28480	0160-0335
A10A1C63	0140-0177	1	CAPACITOR;FXD; 400PF+-1% 300WVDC	72136	DM15F401F0300WV1CR
A10A1C64	0140-0234		CAPACITOR;FXD; 500PF+-1% 300WVDC	72136	DM15F501F0300WV1C
A10A1C65	0140-0233	1	CAPACITOR;FXD; 480PF+-1% 300WVDC	72136	DM15F481F0300WV1C
A10A1C66	0160-3934	1	CAPACITOR;FXD; 340PF+-1% 130WVDC	28480	0160-3934
A10A1C67	0160-2537		CAPACITOR;FXD; 360PF+-1% 300WVDC	72136	DM15F361F0300WV1C
A10A1C68	0160-3046	1	CAPACITOR;FXD; 250PF+-1% 100WVDC	28480	0160-3046
A10A1C69	0160-2265	1	CAPACITOR;FXD; 22PF+-5% 500WVDC	28480	0160-2265
A10A1C70	0140-0190	2	CAPACITOR;FXD; 39PF+-5% 300WVDC	72136	DM15E390J0300WV1CR
A10A1C71	0140-0190		CAPACITOR;FXD; 39PF+-5% 300WVDC	72136	DM15E390J0300WV1CR
A10A1C72	0160-2266	4	CAPACITOR;FXD; 24PF+-5% 500WVDC	28480	0160-2266
A10A1C73	0160-2260	1	CAPACITOR;FXD; 13PF+-5% 500WVDC	28480	0160-2260
A10A1C74	0160-2266		CAPACITOR;FXD; 24PF+-5% 500WVDC	28480	0160-2266
A10A1C75	0160-2266		CAPACITOR;FXD; 24PF+-5% 500WVDC	28480	0160-2266
A10A1C76	0160-2262	1	CAPACITOR;FXD; 16PF+-5% 500WVDC	28480	0160-2262
A10A1C77	0160-2257	3	CAPACITOR;FXD; 10PF+-5% 500WVDC	28480	0160-2257
A10A1C78	0160-2263	2	CAPACITOR;FXD; 18PF+-5% 500WVDC	28480	0160-2263
A10A1C79	0160-2263		CAPACITOR;FXD; 18PF+-5% 500WVDC	28480	0160-2263
A10A1C80	0160-2257		CAPACITOR;FXD; 10PF+-5% 500WVDC	28480	0160-2257
A10A1C81	0121-0060	2	CAPACITOR, VAR, TRMR, CER, 2/8PF	73899	DV11PS8A
A10A1C82	0121-0061	2	CAPACITOR, VAR, TRMR, CER, 5.5/18PF	73899	DV11PS18A
A10A1C83	0121-0061		CAPACITOR, VAR, TRMR, CER, 5.5/18PF	73899	DV11PS18A
A10A1C84	0121-0060		CAPACITOR, VAR, TRMR, CER, 2/8PF	73899	DV11PS8A
A10A1C85	0160-0174		CAPACITOR;FXD; .47UF+-80-20% 25WVDC	28480	0160-0174
A10A1C86	0180-0197		CAPACITOR;FXD; 2.2UF+-10% 20VDC TA	56289	150D225X9020A2
A10A1C87	0160-0174		CAPACITOR;FXD; .47UF+-80-20% 25WVDC	28480	0160-0174
A10A1C88	0180-0197		CAPACITOR;FXD; 2.2UF+-10% 20VDC TA	56289	150D225X9020A2
A10A1C89	0160-0174		CAPACITOR;FXD; .47UF+-80-20% 25WVDC	28480	0160-0174
A10A1C90	0180-0197		CAPACITOR;FXD; 2.2UF+-10% 20VDC TA	56289	150D225X9020A2
A10A1C91	0160-2055		CAPACITOR;FXD; .01UF+-80-20% 100WVDC	28480	0160-2055
A10A1FL1	0160-0204		CAPACITOR;FXD; .0055UF+-0% 200WVDC	01121	SMFB-A2
A10A1FL2	0160-0204		CAPACITOR;FXD; .0055UF+-0% 200WVDC	01121	SMFB-A2
A10A1FL3	0160-0204		CAPACITOR;FXD; .0055UF+-0% 200WVDC	01121	SMFB-A2
A10A1J1	1250-1220		CONNECTOR-COAX, SMC, 50 OHM MALE	98291	50-051-0109
A10A1J2	1250-1220		CONNECTOR-COAX, SMC, 50 OHM MALE	98291	50-051-0109
A10A1J3	1250-1220		CONNECTOR-COAX, SMC, 50 OHM MALE	98291	50-051-0109
A10A1J4	1250-1220		CONNECTOR-COAX, SMC, 50 OHM MALE	98291	50-051-0109
A10A1K1	0490-1073		RELAY; REED; 1A .25A 120V CONT; 4.5V	28480	0490-1073
A10A1K2	0490-1073		RELAY; REED; 1A .25A 120V CONT; 4.5V	28480	0490-1073
A10A1K3	0490-1073		RELAY; REED; 1A .25A 120V CONT; 4.5V	28480	0490-1073
A10A1K4	0490-1073		RELAY; REED; 1A .25A 120V CONT; 4.5V	28480	0490-1073

See introduction to this section for ordering information

Table 6-3. Replaceable Parts

Reference Designation	HP Part Number	Qty	Description	Mfr Code	Mfr Part Number
A10A1L1	9100-3375	2	COIL; FXD; MOLDED RF CHOKE; .462UH 5%	28480	9100-3375
A10A1L2	9100-3365	2	COIL; FXD MOLDED 0.500UH 5%	24226	9303
A10A1L3	9100-3375		COIL; FXD; MOLDED RF CHOKE; .462UH 5%	28480	9100-3375
A10A1L4	9100-3361	2	COIL; FXD; MOLDED RF CHOKE; .3UH 5%	0004A	AE-.300J-P
A10A1L5	9100-3362	1	COIL; FXD; MOLDED RF CHOKE; .32UH 5%	0004A	AD-.323J-P
A10A1L6	9100-3361	1	COIL; FXD; MOLDED RF CHOKE; .3UH 5%	0004A	AD-.300J-P
A10A1L7	9100-3364	1	COIL; FXD; MOLDED RF CHOKE; 8UH 5%	0004A	AH-8.00J-I
A10A1L8	9100-3374	2	COIL; FXD; MOLDED RF CHOKE; 4.00UH 5%	28480	9100-3374
A10A1L9	9100-3363	1	COIL; FXD; MOLDED RF CHOKE; 4.74UH 5%	0004A	AK-4.74J-P
A10A1L10	9100-3369	2	COIL; FXD; MOLDED RF CHOKE; .924UH 5%	28480	9100-3369
A10A1L11	9100-3370	3	COIL; FXD; MOLDED RF CHOKE; 1.00UH 5%	28480	9100-3370
A10A1L12	9100-3369		COIL; FXD; MOLDED RF CHOKE; .924UH 5%	28480	9100-3369
A10A1L13	9100-3368	2	COIL; FXD; MOLDED RF CHOKE; .6UH 5%	28480	9100-3368
A10A1L14	9100-3367	1	COIL; FXD; MOLDED RF CHOKE; .646UH 5%	0004A	AE-.646J-P
A10A1L15	9100-3368		COIL; FXD; MOLDED RF CHOKE; .6UH 5%	28480	9100-3368
A10A1L16	9100-3374		COIL; FXD; MOLDED RF CHOKE; 4.00UH 5%	28480	9100-3374
A10A1L17	9100-3372	2	COIL; FXD; MOLDED RF CHOKE; 2.00UH 5%	28480	9100-3372
A10A1L18	9100-3373	1	COIL; FXD; MOLDED RF CHOKE; 2.37UH 5%	28480	9100-3373
A10A1L19	9100-3359	2	COIL; FXD; MOLDED RF CHOKE; .231UH 5%	0004A	AC-.231J-P
A10A1L20	9100-3360	1	COIL; FXD; MOLDED RF CHOKE; .25UH 5%	0004A	AC-.250J-P
A10A1L21	9100-3359		COIL; FXD; MOLDED RF CHOKE; .231UH 5%	0004A	AC-.231J-P
A10A1L22	9100-3357	2	COIL; FXD; MOLDED RF CHOKE; .15UH 5%	0004A	AC-.150J-P
A10A1L23	9100-3358	1	COIL; FXD; MOLDED RF CHOKE; .162UH 5%	0004A	AC-.162J-P
A10A1L24	9100-3357		COIL; FXD; MOLDED RF CHOKE; .15UH 5%	0004A	AC-.150J-P
A10A1L25	9100-3372		COIL; FXD; MOLDED RF CHOKE; 2.00UH 5%	28480	9100-3372
A10A1L26	9100-3370		COIL; FXD; MOLDED RF CHOKE; 1.00UH 5%	28480	9100-3370
A10A1L27	9100-3371	1	COIL; FXD; MOLDED RF CHOKE; 1.18UH 5%	28480	9100-3371
A10A1L28	9100-3355	2	COIL; FXD; MOLDED RF CHOKE; .12UH 5%	0004A	AC-.115J-P
A10A1L29	9100-3356	1	COIL; FXD; MOLDED RF CHOKE; .125UH 5%	0004A	AC-.125J-P
A10A1L30	9100-3355		COIL; FXD; MOLDED RF CHOKE; .12UH 5%	0004A	AC-.115J-P
A10A1L31	9100-3377	3	COIL:3-1/2 TURN	28480	9100-3377
A10A1L32	9100-3377		COIL:3-1/2 TURN	28480	9100-3377
	9150-0037		COIL FORM; PC TYPE, FIBERGLASS	24226	DEL 7-434
A10A1L33	9100-3377		COIL:3-1/2 TURN	28480	9100-3377
	9150-0037		COIL FORM:PC TYPE, FIBERGLASS	24226	DEL 7-434
A10A1L34	9100-3370		COIL; FXD; MOLDED RF CHOKE; 1.00UH 5%	28480	9100-3370
A10A1L35	9100-3365		COIL; FXD; MOLDED RF CHOKE; .5UH 5%	0004A	AE-.500J-P
A10A1L36	9100-3366	1	COIL, FXD, MOLDED RF CHOKE, .592UH 5%	24226	9304
A10A1L37	9100-3376	3	COIL:2-1/2 TURN	28480	9100-3376
	9150-0037		COIL FORM:PC TYPE, FIBERGLASS	24226	DEL 7-434
A10A1L38	9100-3376		COIL:2-1/2 TURN	28480	9100-3376
	9150-0037		COIL FORM:PC TYPE, FIBERGLASS	24226	DEL 7-434
A10A1L39	9100-3376		COIL:2-1/2 TURN	28480	9100-3376
	9150-0037		COIL FORM:PC TYPE, FIBERGLASS	24226	DEL 7-434
A10A1L40	9100-3378	6	COIL:1-1/2 TURN	28480	9100-3378
	9150-0037		COIL FORM:PC TYPE, FIBERGLASS	24226	DEL 7-434
A10A1L41	9100-3378		COIL:1-1/2 TURN	28480	9100-3378
	9150-0037		COIL FORM;PC TYPE, FIBERGLASS	24226	DEL 7-434
A10A1L42	9100-3378		COIL:1-1/2 TURN	28480	9100-3378
	9150-0037		COIL FORM:PC TYPE, FIBERGLASS	24226	DEL 7-434
A10A1L43	9100-3378		COIL:1-1/2 TURN	28480	9100-3378
	9150-0037		COIL FORM:PC TYPE, FIBERGLASS	24226	DEL 7-434
A10A1L44	9100-3378		COIL:1-1/2 TURN	28480	9100-3378
	9150-0037		COIL FORM:PC TYPE, FIBERGLASS	24226	DEL 7-434
A10A1L45	9100-3378		COIL:1-1/2 TURN	28480	9100-3378
	9150-0037		COIL FORM:PC TYPE, FIBERGLASS	24226	DEL 7-434
A10A1L46			PART OF ETCHED CIRCUIT BOARD		
A10A1L47			PART OF ETCHED CIRCUIT BOARD		
A10A1L48			PART OF ETCHED CIRCUIT BOARD		
A10A1L49	9140-0144	2	COIL, FXD, MOLDED RF CHOKE, 4.7UH 10%	24226	10/471
A10A1L50	9140-0144		COIL, FXD, MOLDED RF CHOKE, 4.7UH 10%	24226	10/471
A10A1L51	08640-80001		TORRID FILTER	28480	08640-80001
A10A1L52	08640-80001		TORRID FILTER	28480	08640-80001
A10A1L53	08640-80001		TORRID FILTER	28480	08640-80001
A10A1L54	08640-80001		TORRID FILTER	28480	08640-80001
A10A1MP1	1480-0352	1	PIN:DETENT 0.055 X 0.750" DIA	00000	1480-0352
A10A1MP2	08443-20003	1	ROLLER:DETENT	28480	08443-20003
A10A1MP3	08640-00029	1	SPRING:DETENT	28480	08640-00029
A10A1MP4	08640-20082	1	SHAFT:CAM	28480	08640-20082
A10A1MP5	08640-20083	1	SHAFT:CAM FOLL	28480	08640-20083
A10A1MP6	08640-20200	1	CAST COVER:BOTTOM D/F	28480	08640-20200
A10A1MP7	08640-20214	2	BUSHING:CAM HOUSING	28480	08640-20214
A10A1MP8	08640-20219	1	COVER:CAM	28480	08640-20219
A10A1MP9	08640-40004	6	FOLLOWER:CAM	28480	08640-40004

See introduction to this section for ordering information



Table 6-3. Replaceable Parts

Reference Designation	HP Part Number	Qty	Description	Mfr Code	Mfr Part Number
A10A1MP10 †	08640-20064	1	CAM:SLIDER	28480	08640-20064
A10A1MP11	2200-0105		SCREW;MACHINE; 4-40 UNC-2A .312 IN PAN	28480	2200-0105
A10A1MP12 †	08640-20133	2	SUPPORT:CLAMP	28480	08640-20133
A10A1MP13	3030-0007		SCREW;SET; 4-40 UNC-3A .125 IN	28480	3030-0007
A10A1MP14	2200-0145	2	SCREW;MACHINE; 4-40 UNC-2A .438 IN PAN	28480	2200-0145
A10A1MP15	08640-20206	12	RETAINER:SLIDER	28480	08640-20206
A10A1MP16	0510-0015		RETAINER, RING, .125 DIA, CAD PLT STL	79136	5135-12-5-MD-R
A10AIR1	0757-0346		RESISTOR; FXD; 10 OHM1% .125W F TUBULAR	24546	C4-1/8-T0-10R0-F
A10AIR2	0757-0346		RESISTOR; FXD; 10 OHM1% .125W F TUBULAR	24546	C4-1/8-T0-10R0-F
A10AIR3	0757-0346		RESISTOR; FXD; 10 OHM1% .125W F TUBULAR	24546	C4-1/8-T0-10R0-F
A10AIR4	0757-0346		RESISTOR; FXD; 10 OHM1% .125W F TUBULAR	24546	C4-1/8-T0-10R0-F
A10AIR5	0757-0346		RESISTOR; FXD; 10 OHM1% .125W F TUBULAR	24546	C4-1/8-T0-10R0-F
A10AIR6	0757-0346		RESISTOR; FXD; 10 OHM1% .125W F TUBULAR	24546	C4-1/8-T0-10R0-F
A10AIR7	0757-0346		RESISTOR; FXD; 10 OHM1% .125W F TUBULAR	24546	C4-1/8-T0-10R0-F
A10AIR8	0757-0346		RESISTOR; FXD; 10 OHM1% .125W F TUBULAR	24546	C4-1/8-T0-10R0-F
A10AIR9	0757-0346		RESISTOR; FXD; 10 OHM1% .125W F TUBULAR	24546	C4-1/8-T0-10R0-F
A10AIS1	08640-60106	6	SWITCH:SLIDE D/F	28480	08640-60106
	3130-0480	6	CONTACT:SWITCH	28480	3130-0480
A10AIS2	08640-60106		SWITCH:SLIDE D/F	28480	08640-60106
	3130-0480		CONTACT:SWITCH	28480	3130-0480
A10AIS3	08640-60106		SWITCH:SLIDE D/F	28480	08640-60106
	3130-0480		CONTACT:SWITCH	28480	3130-0480
A10AIS4	08640-60106		SWITCH:SLIDE D/F	28480	08640-60106
	3130-0480		CONTACT:SWITCH	28480	3130-0480
A10AIS5	08640-60106		SWITCH:SLIDE D/F	28480	08640-60106
	3130-0480		CONTACT:SWITCH	28480	3130-0480
A10AIS6	08640-60106		SWITCH:SLIDE D/F	28480	08640-60106
	3130-0480		CONTACT:SWITCH	28480	3130-0480
A10AIW1	8120-1830	1	CABLE ASSY:2-557	28480	8120-1830
A10AIW2	8120-1832	1	CABLE ASSY:0-950	28480	8120-1832
A10AIW3	8120-1831	1	CABLE ASSY:1.290	28480	8120-1831
A10A1XA10A3A	1251-2035		CONNECTOR, PC EDGE, 15-CONT, DIP SOLDER	71785	252-15-30-300
A10A1XA10A3B	1251-2026	2	CONNECTOR, PC EDGE, 18-CONT, DIP SOLDER	71785	252-18-30-300
A10A2	08640-60023	1	RF DIVIDER ASSY	28480	08640-60023
A10A2	08640-60092		REBUILT 08640-60023, REQUIRES EXCHANGE	28480	08640-60092
A10A2C1	0160-3456		CAPACITOR;FXD; .001UF+-10% 1000WVDC	28480	0160-3456
A10A2C2	0160-3456		CAPACITOR;FXD; .001UF+-10% 1000WVDC	28480	0160-3456
A10A2C3	0160-3456		CAPACITOR;FXD; .001UF+-10% 1000WVDC	28480	0160-3456
A10A2C4	0160-3456		CAPACITOR;FXD; .001UF+-10% 1000WVDC	28480	0160-3456
A10A2C5			NOT ASSIGNED	28480	0160-3456
A10A2C6	0160-3456		CAPACITOR;FXD; .001UF+-10% 1000WVDC	28480	0160-3456
A10A2C7	0160-3456		CAPACITOR;FXD; .001UF+-10% 1000WVDC	28480	0160-3456
A10A2C8	0160-3456		CAPACITOR;FXD; .001UF+-10% 1000WVDC	28480	0160-3456
A10A2C9	0160-2055		CAPACITOR;FXD; .01UF+80-20% 100WVDC	28480	0160-2055
A10A2C10	0160-2055		CAPACITOR;FXD; .01UF+80-20% 100WVDC	28480	0160-2055
A10A2C11	0160-3456		CAPACITOR;FXD; .001UF+-10% 1000WVDC	28480	0160-3456
A10A2C12	0160-2055		CAPACITOR;FXD; .01UF+80-20% 100WVDC	28480	0160-2055
A10A2C13	0160-3456		CAPACITOR;FXD; .001UF+-10% 1000WVDC	28480	0160-3456
A10A2C14	0160-3456		CAPACITOR;FXD; .001UF+-10% 1000WVDC	28480	0160-3456
A10A2C15	0160-3456		CAPACITOR;FXD; .001UF+-10% 1000WVDC	28480	0160-3456
A10A2C16	0180-0100	3	CAPACITOR-FXD, 4-.7UF+-10% 35VDC TA	56289	1500475X9035B2
A10A2C17	0160-3456		CAPACITOR;FXD; .001UF+-10% 1000WVDC	28480	0160-3456
A10A2C18	0180-0100		CAPACITOR-FXD, 4-.7UF+-10% 35VDC TA	56289	1500475X9035B2
A10A2C19	0180-0197		CAPACITOR-FXD, 2-.2UF+-10% 20VDC TA	56289	1500225X9020A2
A10A2C20	0180-0374	3	CAPACITOR-FXD, 10UF+-10% 20VDC TA-SOLID	56289	1500106X9020B2
A10A2C21			NOT ASSIGNED	56289	1500104X9035A2
A10A2C22	0180-1743	11	CAPACITOR-FXD, .1UF+-10% 35VDC TA-SOLID	56289	1500106X9020B2
A10A2C23	0180-0374		CAPACITOR-FXD, 10UF+-10% 20VDC TA-SOLID	28480	0160-3456
A10A2C24	0160-3456		CAPACITOR;FXD; .001UF+-10% 1000WVDC	28480	0160-3456
A10A2C25	0160-3456		CAPACITOR;FXD; .001UF+-10% 1000WVDC	28480	0160-3456
A10A2C26	0160-3456		CAPACITOR;FXD; .001UF+-10% 1000WVDC	28480	0160-3456
A10A2C27	0160-3456		CAPACITOR;FXD; .001UF+-10% 1000WVDC	28480	0160-3456
A10A2C28	0160-3456		CAPACITOR;FXD; .001UF+-10% 1000WVDC	28480	0160-3456
A10A2C29	0160-3456		CAPACITOR;FXD; .001UF+-10% 1000WVDC	28480	0160-3456
A10A2C30	0160-3456		CAPACITOR;FXD; .001UF+-10% 1000WVDC	28480	0160-3456
A10A2C31	0160-3456		CAPACITOR;FXD; .001UF+-10% 1000WVDC	28480	0160-3456
A10A2C32	0160-3456		CAPACITOR;FXD; .001UF+-10% 1000WVDC	28480	0160-3456
A10A2C33	0160-3456		CAPACITOR;FXD; .001UF+-10% 1000WVDC	28480	0160-3456
A10A2C34	0160-3456		CAPACITOR;FXD; .001UF+-10% 1000WVDC	28480	0160-3456
A10A2C35	0160-3456		CAPACITOR;FXD; .001UF+-10% 1000WVDC	28480	0160-3456
A10A2C36	0160-2055		CAPACITOR,FXD, .01UF+80-20% 100WVDC	28480	0160-2055
A10A2C37	0160-2055		CAPACITOR,FXD, .01UF+80-20% 100WVDC	28480	0160-2055
A10A2C38	0160-2055		CAPACITOR,FXD, .01UF+80-20% 100WVDC	28480	0160-2055
A10A2C39	0160-2055		CAPACITOR,FXD, .01UF+80-20% 100WVDC	28480	0160-2055

See introduction to this section for ordering information  
 † SEE TABLES 7-1 AND 7-2, FOR BACKDATING.

Table 6-3. Replaceable Parts

Reference Designation	HP Part Number	Qty	Description	Mfr Code	Mfr Part Number
A10A2C40	0160-2055		CAPACITOR,FXD, .01UF+80-20% 100WVDC	28480	0160-2055
A10A2C41	0160-2055		CAPACITOR,FXD, .01UF+80-20% 100WVDC	28480	0160-2055
A10A2C42	0180-1743		CAPACITOR-FXD, .1UF+-10% 35VDC TA-SOLID	56289	150D104X9035A2
A10A2C43	0180-1743		CAPACITOR-FXD, .1UF+-10% 35VDC TA-SOLID	56289	150D104X9035A2
A10A2C44	0180-1743		CAPACITOR-FXD, .1UF+-10% 35VDC TA-SOLID	56289	150D104X9035A2
A10A2C45	0180-1743		CAPACITOR-FXD, .1UF+-10% 35VDC TA-SOLID	56289	150D104X9035A2
A10A2C46	0180-1743		CAPACITOR-FXD, .1UF+-10% 35VDC TA-SOLID	56289	150D104X9035A2
A10A2C47	0180-1743		CAPACITOR-FXD, .1UF+-10% 35VDC TA-SOLID	56289	150D104X9035A2
A10A2C48	0180-1743		CAPACITOR-FXD, .1UF+-10% 35VDC TA-SOLID	56289	150D104X9035A2
A10A2C49	0180-1743		CAPACITOR-FXD, .1UF+-10% 35VDC TA-SOLID	56289	150D104X9035A2
A10A2C50	0180-1743		CAPACITOR-FXD, .1UF+-10% 35VDC TA-SOLID	56289	150D104X9035A2
A10A2C51	0160-3456		CAPACITOR;FXD;.001UF+-10% 1000WVDC	28480	0160-3456
A10A2C52	0180-0197		CAPACITOR-FXD, 2.2UF+-10% 20VDC TA	56289	150D225X9020A2
A10A2CR1	1901-0025		DIODE; GEN PRP; SI; 100V MAX VRM 200MA	28480	1901-0025
A10A2CR2	1901-0025		DIODE; GEN PRP; SI; 100V MAX VRM 200MA	28480	1901-0025
A10A2CR3	1901-0025		DIODE; GEN PRP; SI; 100V MAX VRM 200MA	28480	1901-0025
A10A2CR4	1901-0025		DIODE; GEN PRP; SI; 100V MAX VRM 200MA	28480	1901-0025
A10A2CR5	1901-0025		DIODE; GEN PRP; SI; 100V MAX VRM 200MA	28480	1901-0025
A10A2CR6	1901-0025		DIODE; GEN PRP; SI; 100V MAX VRM 200MA	28480	1901-0025
A10A2CR7	1901-0025		DIODE; GEN PRP; SI; 100V MAX VRM 200MA	28480	1901-0025
A10A2CR8	1901-0025		DIODE; GEN PRP; SI; 100V MAX VRM 200MA	28480	1901-0025
A10A2CR9	1901-0025		DIODE; GEN PRP; SI; 100V MAX VRM 200MA	28480	1901-0025
A10A2L1			PART OF ETCHED CIRCUIT BOARD		
A10A2L2			NOT ASSIGNED		
A10A2L3	9100-1620		COIL, FXD, MOLDED RF CHOKE, 15UH 10%	24226	15/152
A10A2L4	9140-0096	1	COIL, FXD, MOLDED RF CHOKE, 1UH 10%	24226	15/101
A10A2L5	9100-1612	1	COIL, FXD, MOLDED RF CHOKE, .33UH 20%	24226	15/330
A10A2L6	9140-0094	1	COIL, FXD, MOLDED RF CHOKE, .68UH 10%	24226	15/680
A10A2L7	9100-1615	1	COIL, FXD, MOLDED RF CHOKE, 1.2UH 10%	24226	15/121
A10A2L8	9140-0098	1	COIL, FXD, MOLDED RF CHOKE, 2.2UH 10%	24226	15/221
A10A2L9	9100-1618	1	COIL, FXD, MOLDED RF CHOKE, 5.6UH 10%	24226	15/561
A10A2L10	9140-0114	1	COIL, FXD, MOLDED RF CHOKE, 10UH 10%	24226	15/102
A10A2L11	9100-1620		COIL, FXD, MOLDED RF CHOKE, 15UH 10%	24226	15/152
A10A2L12	9100-1620		COIL, FXD, MOLDED RF CHOKE, 15UH 10%	24226	15/152
A10A2L13	9100-1628	2	COIL; FXD; MOLDED RF CHOKE; 43UH 5%	24226	15/432
A10A2L14	9100-1620		COIL, FXD, MOLDED RF CHOKE, 15UH 10%	24226	15/152
A10A2L15	9100-1620		COIL, FXD, MOLDED RF CHOKE, 15UH 10%	24226	15/152
A10A2L16	9100-1628		COIL; FXD; MOLDED RF CHOKE; 43UH 5%	24226	15/432
A10A201	1854-0071		TRANSISTOR NPN SI PD=300MW FT=200MHZ	28480	1854-0071
A10A202	1853-0034	9	TRANSISTOR PNP SI PD=360MW FT=400MHZ	28480	1853-0034
A10A203	1853-0034		TRANSISTOR PNP SI PD=360MW FT=400MHZ	28480	1853-0034
A10A204	1853-0034		TRANSISTOR PNP SI PD=360MW FT=400MHZ	28480	1853-0034
A10A205	1854-0345	1	TRANSISTOR NPN 2N5179 SI PD=200MW	04713	2N5179
A10A2R1	0757-0394		RESISTOR; FXD; 51.1 OHM1% .125W F	24546	C4-1/8-T0-51R1-F
A10A2R2	0757-0394		RESISTOR; FXD; 51.1 OHM1% .125W F	24546	C4-1/8-T0-51R1-F
A10A2R3	0757-0394		RESISTOR; FXD; 51.1 OHM1% .125W F	24546	C4-1/8-T0-51R1-F
A10A2R4	0757-0984	9	RESISTOR; FXD; 10 OHM1% .5W F TUBULAR	30983	MF7C1/2-T0-10R0-F
A10A2R5	0757-0438		RESISTOR; FXD; 5.11K1% .125W F TUBULAR	24546	C4-1/8-T0-5111-F
A10A2R6	0698-7194	3	RESISTOR; FXD; 17.8 OHM2% .05W F	24546	C3-1/8-T00-17R8-G
A10A2R7	0698-7223	6	RESISTOR; FXD; 287 OHM2% .05W F TUBULAR	24546	C3-1/8-T0-287R-G
A10A2R8	0698-7223		RESISTOR; FXD; 287 OHM2% .05W F TUBULAR	24546	C3-1/8-T0-287R-G
A10A2R9	0757-0394		RESISTOR; FXD; 51.1 OHM1% .125W F	24546	C4-1/8-T0-51R1-F
A10A2R10	0757-0984		RESISTOR; FXD; 10 OHM1% .5W F TUBULAR	30983	MF7C1/2-T0-10R0-F
A10A2R11	0757-0438		RESISTOR; FXD; 5.11K1% .125W F TUBULAR	24546	C4-1/8-T0-5111-F
A10A2R12	0698-7194		RESISTOR; FXD; 17.8 OHM2% .05W F	24546	C3-1/8-T00-17R8-G
A10A2R13	0698-7223		RESISTOR; FXD; 287 OHM2% .05W F TUBULAR	24546	C3-1/8-T0-287R-G
A10A2R14	0698-7223		RESISTOR; FXD; 287 OHM2% .05W F TUBULAR	24546	C3-1/8-T0-287R-G
A10A2R15	0757-0394		RESISTOR; FXD; 51.1 OHM1% .125W F	24546	C4-1/8-T0-51R1-F
A10A2R16	0757-0438		RESISTOR; FXD; 5.11K1% .125W F TUBULAR	24546	C4-1/8-T0-5111-F
A10A2R17	0757-0984		RESISTOR; FXD; 10 OHM1% .5W F TUBULAR	30983	MF7C1/2-T0-10R0-F
A10A2R18	0698-7194		RESISTOR; FXD; 17.8 OHM2% .05W F	24546	C3-1/8-T00-17R8-G
A10A2R19	0698-7223		RESISTOR; FXD; 287 OHM2% .05W F TUBULAR	24546	C3-1/8-T0-287R-G
A10A2R20	0698-7223		RESISTOR; FXD; 287 OHM2% .05W F TUBULAR	24546	C3-1/8-T0-287R-G
A10A2R21	0757-0398		RESISTOR; FXD; 75 OHM1% .125W F TUBULAR	24546	C4-1/8-T0-75R0-F
A10A2R22	0757-0984		RESISTOR; FXD; 10 OHM1% .5W F TUBULAR	30983	MF7C1/2-T0-10R0-F
A10A2R23	0757-0438		RESISTOR; FXD; 5.11K1% .125W F TUBULAR	24546	C4-1/8-T0-5111-F
A10A2R24	0698-7224	2	RESISTOR; FXD; 316 OHM2% .05W F TUBULAR	24546	C3-1/8-T0-316R-G
A10A2R25	0698-7219		RESISTOR; FXD; 196 OHM2% .05W F TUBULAR	24546	C3-1/8-T0-196R-G
A10A2R26	0698-7190	2	RESISTOR; FXD; 12.1 OHM2% .05W F	24546	C3-1/8-T00-12R1-G
A10A2R27	0698-7227	4	RESISTOR; FXD; 422 OHM2% .05W F TUBULAR	24546	C3-1/8-T0-422R-G
A10A2R28	0698-7227		RESISTOR; FXD; 422 OHM2% .05W F TUBULAR	24546	C3-1/8-T0-422R-G
A10A2R29	0698-3437		RESISTOR; FXD; 133 OHM1% .125W F	16299	C4-1/8-T0-133R-F
A10A2R30	0757-0399		RESISTOR; FXD; 82.5 OHM1% .125W F	24546	C4-1/8-T0-82R5-F
A10A2R31	0757-0984		RESISTOR; FXD; 10 OHM1% .5W F TUBULAR	30983	MF7C1/2-T0-10R0-F
A10A2R32	0757-0438		RESISTOR; FXD; 5.11K1% .125W F TUBULAR	24546	C4-1/8-T0-5111-F

See introduction to this section for ordering information

Table 6-3. Replaceable Parts

Reference Designation	HP Part Number	Qty	Description	Mfr Code	Mfr Part Number
A10A2R33	0698-7224		RESISTOR; FXD; 316 OHM2% .05W F TUBULAR	24546	C3-1/8-T0-316R-G
A10A2R34	0698-7219		RESISTOR; FXD; 196 OHM2% .05W F TUBULAR	24546	C3-1/8-T0-196R-G
A10A2R35	0698-7190		RESISTOR; FXD; 12.1 OHM2% .05W F	24546	C3-1/8-T00-12R1-G
A10A2R36	0698-7227		RESISTOR; FXD; 422 OHM2% .05W F TUBULAR	24546	C3-1/8-T0-422R-G
A10A2R37	0698-7227		RESISTOR; FXD; 422 OHM2% .05W F TUBULAR	24546	C3-1/8-T0-422R-G
A10A2R38	0757-0399		RESISTOR; FXD; 82.5 OHM1% .125W F	24546	C4-1/8-T0-82R5-F
A10A2R39	0698-3437		RESISTOR; FXD; 133 OHM1% .125W F	16299	C4-1/8-T0-133R-F
A10A2R40	0757-0984		RESISTOR; FXD; 10 OHM1% .5W F TUBULAR	30983	MF7C1/2-T0-10R0-F
A10A2R41	0757-0438		RESISTOR; FXD; 5.11K1% .125W F TUBULAR	24546	C4-1/8-T0-5111-F
A10A2R42	0757-0984		RESISTOR; FXD; 10 OHM1% .5W F TUBULAR	30983	MF7C1/2-T0-10R0-F
A10A2R43	0757-0438		RESISTOR; FXD; 5.11K1% .125W F TUBULAR	24546	C4-1/8-T0-5111-F
A10A2R44	0757-0984		RESISTOR; FXD; 10 OHM1% .5W F TUBULAR	30983	MF7C1/2-T0-10R0-F
A10A2R45	0698-7253		RESISTOR; FXD; 5.11K2% .05W F TUBULAR	24546	C3-1/8-T0-5111-G
A10A2R46	0698-7253		RESISTOR; FXD; 5.11K2% .05W F TUBULAR	24546	C3-1/8-T0-5111-G
A10A2R47	0698-3440		RESISTOR; FXD; 196 OHM1% .125W F	16299	C4-1/8-T0-196R-F
A10A2R48	0698-3444		RESISTOR; FXD; 316 OHM1% .125W F	16299	C4-1/8-T0-316R-F
A10A2R49	0757-0379	1	RESISTOR; FXD; 12.1 OHM1% .125W F	30983	MF4C1/8-T0-12R1-F
A10A2R50	0698-3447	8	RESISTOR; FXD; 422 OHM1% .125W F	16299	C4-1/8-T0-422R-F
A10A2R51	0698-3447		RESISTOR; FXD; 422 OHM1% .125W F	16299	C4-1/8-T0-422R-F
A10A2R52	0757-0442		RESISTOR; FXD; 10K1% .125W F TUBULAR	24546	C4-1/8-T0-10K2-F
A10A2R53	0757-0984		RESISTOR; FXD; 10 OHM1% .5W F TUBULAR	30983	MF7C1/2-T0-10R0-F
A10A2R54	0757-0442	2	RESISTOR; FXD; 10K1% .125W F TUBULAR	24546	C4-1/8-T0-10K2-F
A10A2R55	0698-3151	1	RESISTOR; FXD; 2.87K1% .125W F TUBULAR	16299	C4-1/8-T0-2871-F
A10A2R56	0757-0461		RESISTOR; FXD; 68.1K1% .125W F TUBULAR	24546	C4-1/8-T0-6812-F
A10A2R57	0757-1094		RESISTOR; FXD; 1.47K1% .125W F TUBULAR	24546	C4-1/8-T0-1471-F
A10A2R58	0757-0458		RESISTOR; FXD; 51.1K1% .125W F TUBULAR	24546	C4-1/8-T0-5112-F
A10A2R59	0757-0442		RESISTOR; FXD; 10K1% .125W F TUBULAR	24546	C4-1/8-T0-10K2-F
A10A2R60	0757-0280		RESISTOR; FXD; 1K1% .125W F TUBULAR	24546	C4-1/8-T0-1001-F
A10A2R61	0757-0280		RESISTOR; FXD; 1K1% .125W F TUBULAR	24546	C4-1/8-T0-1001-F
A10A2R62	0757-0416		RESISTOR; FXD; 511 OHM1% .125W F	24546	C4-1/8-T0-511R-F
A10A2T1	08553-6012	5	TRANSFORMER; RF (CODE=BLUE)	28480	08553-6012
A10A2T2	08553-6012		TRANSFORMER; RF (CODE=BLUE)	28480	08553-6012
A10A2T3	08553-6012		TRANSFORMER; RF (CODE=BLUE)	28480	08553-6012
A10A2T4	08553-6012		TRANSFORMER; RF (CODE=BLUE)	28480	08553-6012
A10A2T5	08553-6012		TRANSFORMER; RF (CODE=BLUE)	28480	08553-6012
A10A2T6	08640-80002	1	TRANSFORMER; RF 12-TURN	28480	08640-80002
A10A2TP1	0360-1514		TERMINAL, SLDR STUD	28480	0360-1514
A10A2TP2	0360-1514		TERMINAL, SLDR STUD	28480	0360-1514
A10A2TP3	0360-1514		TERMINAL, SLDR STUD	28480	0360-1514
A10A2TP4	0360-1514		TERMINAL, SLDR STUD	28480	0360-1514
A10A2U1	1826-0013		IC; LIN; OPERATIONAL AMPLIFIER	28480	1826-0013
A10A2U2	1820-0102		INTEGRATED CIRCUIT, DGTL, ECL J-K FLIP	04713	MC1013P
A10A2U3	1820-0102		INTEGRATED CIRCUIT, DGTL, ECL J-K FLIP	04713	MC1013P
A10A2U4	1820-0102		INTEGRATED CIRCUIT, DGTL, ECL J-K FLIP	04713	MC1013P
A10A2U5	1820-0102		INTEGRATED CIRCUIT, DGTL, ECL J-K FLIP	04713	MC1013P
A10A2U6	1820-0535	1	IC; DGTL; BUFFER/DRIVER/LINE DRIVER	01295	SN754518P
A10A2U7	1820-0145		INTEGRATED CIRCUIT, DGTL, ECL QUAD 2	04713	MC1010P
A10A2U8	1820-0145		INTEGRATED CIRCUIT, DGTL, ECL QUAD 2	04713	MC1010P
A10A2U9	1820-0145		INTEGRATED CIRCUIT, DGTL, ECL QUAD 2	04713	MC1010P
A10A2U10	1820-0753	3	INTEGRATED CIRCUIT, DGTL, ECL DUAL 3	28480	1820-0753
A10A2U11	1820-0982	1	IC; LIN; DIFFERENTIAL AMPLIFIER	28480	1820-0982
A10A2U12	1820-0736		IC; DGTL; COUNTER	28480	1820-0736
A10A2U13	1820-0753		INTEGRATED CIRCUIT, DGTL, ECL DUAL 3	28480	1820-0753
A10A2U14	1820-0736		IC; DGTL; COUNTER	28480	1820-0736
A10A2U15	1820-0753		INTEGRATED CIRCUIT, DGTL, ECL DUAL 3	28480	1820-0753
A10A2U16	1820-0557	1	IC; DIGITAL	28480	1820-0557
A10A2U17	1820-0145		INTEGRATED CIRCUIT, DGTL, ECL QUAD 2	04713	MC1010P
A10A2U18	1820-0143	1	INTEGRATED CIRCUIT, DGTL, ECL J-K FLIP	04713	MC1027P
A10A2U19	1820-0145		INTEGRATED CIRCUIT, DGTL, ECL QUAD 2	04713	MC1010P
A10A2U20	1820-0102		INTEGRATED CIRCUIT, DGTL, ECL J-K FLIP	04713	MC1013P
A10A2VR1	1902-3002	1	DIODE; ZENER; 2.37V VZ; .4W MAX PD	04713	SZ 10939-2
A10A2W1	8120-1823	1	CABLE ASSY: 1.850	28480	8120-1823
A10A2W2	8120-1824	1	CABLE ASSY: 2.482	28480	8120-1824
A10A2W3	8120-1825	1	CABLE ASSY: 4.839	28480	8120-1825
A10A2W4	8120-1826	1	CABLE ASSY: 6.600	28480	8120-1826
A10A2W5	8120-1828	1	CABLE ASSY: 4.950	28480	8120-1828
A10A2W6	8120-1827	1	CABLE ASSY: 8.742	28480	8120-1827
A10A2W7	8120-1829	1	CABLE ASSY: 7.878	28480	8120-1829
A10A2XA10A2U1	1200-0474	2	SOCKET, ELEC, 1C 14-CONT DIP SLDR TERM	06776	ICN-143-S3
A10A2XA10A2U2	1200-0474		SOCKET, ELEC, 1C 14-CONT DIP SLDR TERM	06776	ICN-143-S3
A10A3	08640-60022	1	RISER ASSY	28480	08640-60022
A10A3 XA10A2A	1251-2035		CONNECTOR, PC EDGE, 15-CONT, DIP SOLDER	71785	252-15-30-300
A10A3 XA10A2B	1251-2026		CONNECTOR, PC EDGE, 18-CONT, DIP SOLDER	71785	252-18-30-300

See introduction to this section for ordering information

Table 6-3. Replaceable Parts

Reference Designation	HP Part Number	Qty	Description	Mfr Code	Mfr Part Number
A11 A11	08640-60020	1	FIXED-FREQUENCY MODULATION OSCILLATOR (STANDARD MODULE)	28480	08640-60020
A11C1	0160-3548	1	CAPACITOR;FXD; .01UF+-1% 100WVDC	28480	0160-3548
A11C2	0160-0336	1	CAPACITOR;FXD; 100PF+-1% 30WVDC	28480	0160-0336
A11C3	0180-0094	2	CAPACITOR-FXD; 100UF+75-10% 25VDC AL	56289	30D107G0250D2
A11C4	0180-0094		CAPACITOR-FXD; 100UF+75-10% 25VDC AL	56289	30D107G0250D2
A11C5	0180-2206		CAPACITOR-FXD, 60UF+-10% 6VDC TA-SOLID	56289	150D606X900682
A11C6	0180-1746		CAPACITOR-FXD, 15UF+-10% 20VDC TA-SOLID	56289	150D156X902082
A11C7	0180-1746		CAPACITOR-FXD, 15UF+-10% 20VDC TA-SOLID	56289	150D156X902082
A11CR1	1901-0040		DIODE; SWITCHING;SI ; 30V MAX VRM 50MA	28480	1901-0040
A11CR2	1901-0040		DIODE; SWITCHING;SI ; 30V MAX VRM 50MA	28480	1901-0040
A11CR3	1901-0040		DIODE; SWITCHING;SI ; 30V MAX VRM 50MA	28480	1901-0040
A1101 †	1854-0003	7	TRANSISTOR NPN SI PD=800MW FT=50MHZ	28480	1854-0003
	1200-0173		INSULATOR, XSTR, TO- 5, .075 THK	28480	1200-0173
A1102 †	1854-0003		TRANSISTOR NPN SI PD=800MW FT=50MHZ	28480	1854-0003
	1200-0173		INSULATOR, XSTR, TO- 5, .075 THK	28480	1200-0173
A1103	1854-0071		TRANSISTOR NPN SI PD=300MW FT=200MHZ	28480	1854-0071
A1104 †	1854-0003		TRANSISTOR NPN SI PD=800MW FT=50MHZ	28480	1854-0003
	1200-0173		INSULATOR, XSTR, TO- 5, .075 THK	28480	1200-0173
A1105 †	1854-0003		TRANSISTOR NPN SI PD=800MW FT=50MHZ	28480	1854-0003
	1200-0173		INSULATOR, XSTR, TO- 5, .075 THK	28480	1200-0173
A1106	1854-0071		TRANSISTOR NPN SI PD=300MW FT=200MHZ	28480	1854-0071
A11R1			NOT ASSIGNED		
A11R2	0757-0346		RESISTOR; FXD; 10 OHM1% .125W F TUBULAR	24546	C4-1/8-T0-10R0-F
A11R3	0757-0438		RESISTOR; FXD; 5.11K1% .125W F TUBULAR	24546	C4-1/8-T0-5111-F
A11R4	0698-3457	1	RESISTOR; FXD; 316K1% .125W F TUBULAR	19701	MF4C1/8-T0-3163-F
A11R5	0698-0085		RESISTOR; FXD; 2.61K1% .125W F TUBULAR	16299	C4-1/8-T0-2611-F
A11R6	2100-1758	1	RESISTOR, VAR, TRMR, 1KOHM 5% HW	28480	2100-1758
A11R7 †	0698-3151		RESISTOR; FXD; 2.87K1% .125W F TUBULAR	16299	C4-1/8-T0-2871-F
A11R8	0757-0280		RESISTOR; FXD; 1K1% .125W F TUBULAR	24546	C4-1/8-T0-1001-F
A11R9	0698-3453		RESISTOR; FXD; 196K1% .125W F TUBULAR	16299	C4-1/8-T0-1963-F
A11R10	0757-0280		RESISTOR; FXD; 1K1% .125W F TUBULAR	24546	C4-1/8-T0-1001-F
A11R11 †	0757-0438		RESISTOR; FXD; 5.11K1% .125W F TUBULAR	24546	C4-1/8-T0-5111-F
A11R12	0757-0438		RESISTOR; FXD; 5.11K1% .125W F TUBULAR	24546	C4-1/8-T0-5111-F
A11R13	0757-0438		RESISTOR; FXD; 5.11K1% .125W F TUBULAR	24546	C4-1/8-T0-5111-F
A11R14	0698-0085		RESISTOR; FXD; 2.61K1% .125W F TUBULAR	16299	C4-1/8-T0-2611-F
A11R15	0757-0401		RESISTOR; FXD; 100 OHM1% .125W F	24546	C4-1/8-T0-101-F
A11R16	0757-0401		RESISTOR; FXD; 100 OHM1% .125W F	24546	C4-1/8-T0-101-F
A11R17	0757-0401		RESISTOR; FXD; 100 OHM1% .125W F	24546	C4-1/8-T0-101-F
A11R18	0757-0401		RESISTOR; FXD; 100 OHM1% .125W F	24546	C4-1/8-T0-101-F
A11R19	0698-0024	6	RESISTOR; FXD; 2.61K1% .5W F TUBULAR	03888	PME65-1/2-T0-2611-F
A11R20	0698-0024		RESISTOR; FXD; 2.61K1% .5W F TUBULAR	03888	PME65-1/2-T0-2611-F
A11R21	0698-0024		RESISTOR; FXD; 2.61K1% .5W F TUBULAR	03888	PME65-1/2-T0-2611-F
A11R22	0698-0024		RESISTOR; FXD; 2.61K1% .5W F TUBULAR	03888	PME65-1/2-T0-2611-F
A11P23	0757-1100	4	RESISTOR; FXD; 600 OHM1% .125W F	24546	C4-1/8-T0-601-F
A11R24	0757-1100		RESISTOR; FXD; 600 OHM1% .125W F	24546	C4-1/8-T0-601-F
A11R25	0757-0442		RESISTOR; FXD; 10K1% .125W F TUBULAR	24546	C4-1/8-T0-1002-F
A11P26	0757-0442		RESISTOR; FXD; 10K1% .125W F TUBULAR	24546	C4-1/8-T0-1002-F
A11TP1	0360-1514		TERMINAL, SLDR STUD	28480	0360-1514
A11TP2	0360-1514		TERMINAL, SLDR STUD	28480	0360-1514
A11TP3	0360-1514		TERMINAL, SLDR STUD	28480	0360-1514
A11TP4	0360-1514		TERMINAL, SLDR STUD	28480	0360-1514
A11TP5	0360-1514		TERMINAL, SLDR STUD	28480	0360-1514
A11TP6	0360-1514		TERMINAL, SLDR STUD	28480	0360-1514
A11U1	1826-0007	1	IC;LIN;OPERATIONAL AMPLIFIER	28480	1826-0007
A11VR1	1902-0049		DIODE; ZENER; 6.19V VZ; .4W MAX PD	28480	1902-0049
A11VR2	1902-0049		DIODE; ZENER; 6.19V VZ; .4W MAX PD	28480	1902-0049
A11A1	08640-60116	1	FREQUENCY SELECT SWITCH ASSY	28480	08640-60116
A11AMP1	08640-20218		HOUSING;GEAR SPROCKET, AUDIO	28480	08640-20218
A11AIR1	0698-8272	2	RESISTOR; FXD; 157K1% .125W F TUBULAR	30983	MF4C1/8-T0-1573-F
A11AIR2	0757-0479	2	RESISTOR; FXD; 392K1% .125W F TUBULAR	30983	MF4C1/8-T0-3923-F
A11AIR3	0698-8272		RESISTOR; FXD; 157K1% .125W F TUBULAR	30983	MF4C1/8-T0-1573-F
A11AIR4	0757-0479		RESISTOR; FXD; 392K1% .125W F TUBULAR	30983	MF4C1/8-T0-3923-F
A11AIS1	3100-3091	1	SWITCH;ROTARY	28480	3100-3091

See introduction to this section for ordering information  
 † SEE TABLES 7-1 AND 7-2, FOR BACKDATING.

Table 6-3. Replaceable Parts

Reference Designation	HP Part Number	Qty	Description	Mfr Code	Mfr Part Number
A11	08640-60019	1	VARIABLE-FREQUENCY MODULATION OSC. ASSY (OPTION 001)	28480	08640-60019
A11	08640-60089		REBUILT 08640-60019, REQUIRES EXCHANGE	28480	08640-60089
A11C1	0121-0477	1	CAPACITOR, VAR, 11HORIZ (INCLUDES C2, C3)	80486	2112 MODIFIED
A11C2			(PART OF A11C1)		
A11C3	0160-2257	2	(PART OF A11C1)	28480	0160-2257
A11C4	0160-2261		CAPACITOR;FXD; 10PF+-5% 500WVDC	28480	0160-2261
A11C5			CAPACITOR;FXD; 15PF+-5% 500WVDC		
A11C6	0140-0213	2	CAPACITOR;FXD; .002UF+-1% 300WVDC	72136	DM19F202F0300WVICR
A11C7	0140-0213		CAPACITOR;FXD; .002UF+-1% 300WVDC	72136	DM19F202F0300WVICR
A11C8	0160-2055		CAPACITOR;FXD; .01UF+-80-20% 100WVDC	28480	0160-2055
A11C9	0121-0036	7	CAPACITOR, VAR, TRMR, CER, 5.5/18PF	73899	DV11PR18A
A11C10	0180-0374		CAPACITOR-FXD, 10UF+-10% 20VDC TA-SOLID	56289	150D106X9020B2
A11C11	0160-2204		CAPACITOR;FXD; 100PF+-5% 300WVDC	28480	0160-2204
A11C12	0160-2199		CAPACITOR;FXD; 30PF+-5% 300WVDC	28480	0160-2199
A11C13	0180-0116		CAPACITOR-FXD, 6.8UF+-10% 35VDC TA	56289	150D685X9035B2
A11C14	0180-0116		CAPACITOR-FXD, 6.8UF+-10% 35VDC TA	56289	150D685X9035B2
A11C15	0180-1714	2	CAPACITOR-FXD, 330UF+-10% 6VDC TA-SOLID	56289	150D337X9006S2
A11C16	0180-1714		CAPACITOR-FXD, 330UF+-10% 6VDC TA-SOLID	56289	150D337X9006S2
A11C17	0180-0116		CAPACITOR-FXD, 6.8UF+-10% 35VDC TA	56289	150D685X9035B2
A11C18	0180-0116		CAPACITOR-FXD, 6.8UF+-10% 35VDC TA	56289	150D685X9035B2
A11C19	0180-0228		CAPACITOR-FXD, 22UF+-10% 15VDC TA-SOLID	56289	150D226X9015B2
A11C20	0160-2261		CAPACITOR;FXD; 15PF+-5% 500WVDC	28480	0160-2261
A11C21	0160-2236	1	CAPACITOR;FXD; 1PF+-25PF 500WVDC	28480	0160-2236
A11C22	0180-2207		CAPACITOR-FXD, 100UF+-10% 10VDC TA	56289	150D107X9010R2
A11C23	0180-2207		CAPACITOR-FXD, 100UF+-10% 10VDC TA	56289	150D107X9010R2
A11CR1	1901-0040		DIODE; SWITCHING; SI; 30V MAX VRM 50MA	28480	1901-0040
A11CR2	1901-0040		DIODE; SWITCHING; SI; 30V MAX VRM 50MA	28480	1901-0040
A11CR3	1901-0040		DIODE; SWITCHING; SI; 30V MAX VRM 50MA	28480	1901-0040
A11CR4	1901-0040		DIODE; SWITCHING; SI; 30V MAX VRM 50MA	28480	1901-0040
A11CR5	1901-0040		DIODE; SWITCHING; SI; 30V MAX VRM 50MA	28480	1901-0040
A11CR6	1901-0040		DIODE; SWITCHING; SI; 30V MAX VRM 50MA	28480	1901-0040
A11CR7	1901-0040		DIODE; SWITCHING; SI; 30V MAX VRM 50MA	28480	1901-0040
A11CR8	1901-0040		DIODE; SWITCHING; SI; 30V MAX VRM 50MA	28480	1901-0040
A11CR9	1901-0040		DIODE; SWITCHING; SI; 30V MAX VRM 50MA	28480	1901-0040
A11CR10	1901-0040		DIODE; SWITCHING; SI; 30V MAX VRM 50MA	28480	1901-0040
A11MP1	0340-0037	2	TERMINAL, SLDR STUD, .098 SHK DIA	28480	0340-0037
A11MP2	0340-0039	2	TERMINAL BUSHING - TEFLON; MOUNTS IN	28480	0340-0039
A11MP3	1430-0764	1	GEAR SPUR	28480	1430-0764
A11MP4	08640-00006	1	COVER: AUDIO OSCILLATOR	28480	08640-00006
A11MP5	08640-20090	4	SUPPORT: COVER AUDIO OSCILLATOR	28480	08640-20090
A11MP6	08640-00008	1	COVER: BACK A OSCILLATOR	28480	08640-00008
A11MP7	08640-20062	3	SPACER: BUSHING	28480	08640-20062
A11MP8	2200-0103		SCREW: MACHINE; 4-40 UNC-2A .25 IN PAN	28480	2200-0103
A11MP9	0570-0111	3	SCREW: MACHINE; 6-32 UNC-2A .375 IN	95987	N-632-3/8
A11MP10	2190-0004	4	WASHER; LOCK; INT; 4 .115 ID .27 OD	78189	SF 1904-00
A11MP11	2260-0009	2	NUT, HEX 4-40 .094 X .25, STL, NI PL	78189	
A11MP12	0403-0026	7	GLIDE: NYLON	28480	0403-0026
A11MP13	4040-0749		EXTRACTOR: PC BOARD, BROWN	28480	4040-0749
	1480-0073		PIN: DRIVE 0.250" LG	00000	0BD
A11Q1	1853-0020		TRANSISTOR PNP SI PD=300MW FT=150MHZ	28480	1853-0020
A11Q2	1854-0071		TRANSISTOR NPN SI PD=300MW FT=200MHZ	28480	1854-0071
A11Q3 †	1853-0276	2	TRANSISTOR PNP SI PD=360MW FT=250MHZ	28480	1853-0276
	1200-0173		INSULATOR, XSTR, TO-5, .075 THK	28480	1200-0173
A11Q4	1854-0351	2	TRANSISTOR NPN SI PD=360MW FT=300MHZ	28480	1854-0351
A11Q5	1854-0003		TRANSISTOR NPN SI PD=800MW FT=50MHZ	28480	1854-0003
A11Q6 †	1854-0003		TRANSISTOR NPN SI PD=800MW FT=50MHZ	28480	1854-0003
	1200-0173		INSULATOR, XSTR TO-5, .075 THK	28480	1200-0173
A11Q7	1854-0351		TRANSISTOR NPN SI PD=360MW FT=300MHZ	28480	1854-0351
A11Q8	1853-0276		TRANSISTOR PNP SI PD=360MW FT=250MHZ	28480	1853-0276
A11Q9	1854-0071		TRANSISTOR NPN SI PD=300MW FT=200MHZ	28480	1854-0071
A11Q10	1853-0020		TRANSISTOR PNP SI PD=300MW FT=150MHZ	28480	1853-0020
A11Q11	1855-0062		TRANSISTOR, JFET N-CHAN D-MODE SI	28480	1855-0062
A11Q12	1854-0071		TRANSISTOR NPN SI PD=300MW FT=200MHZ	28480	1854-0071
A11R1	0698-8294	2	RESISTOR; FXD; .0215 OHM1% .5W F	28480	0698-8294
A11R2	0698-3453		RESISTOR; FXD; 196K1% .125W F TUBULAR	16299	C4-1/8-T0-1963-F
A11R3	0698-4508	1	RESISTOR; FXD; 78.7K1% .125W F TUBULAR	24546	C4-1/8-T0-7872-F
A11R4	0698-8294		RESISTOR; FXD; .0215 OHM1% .5W F	28480	0698-8294
A11R5	0698-3451	2	RESISTOR; FXD; 133K1% .125W F TUBULAR	16299	C4-1/8-T0-1333-F
A11R6	0698-3453		RESISTOR; FXD; 196K1% .125W F TUBULAR	16299	C4-1/8-T0-1963-F
A11R7	0757-0401		RESISTOR; FXD; 100 OHM1% .125W F	24546	C4-1/8-T0-101-F
A11R8	0757-0401		RESISTOR; FXD; 100 OHM1% .125W F	24546	C4-1/8-T0-101-F

See introduction to this section for ordering information  
 † SEE TABLES 7-1 AND 7-2, FOR BACKDATING.

Table 6-3. Replaceable Parts

Reference Designation	HP Part Number	Qty	Description	Mfr Code	Mfr Part Number
A11R9	0757-0441	1	RESISTOR; FXD; 8.25K1% .125W F TUBULAR	24546	C4-1/8-T0-8251-F
A11R10	0757-0447		RESISTOR; FXD; 16.2K1% .125W F TUBULAR	24546	C4-1/8-T0-1622-F
A11R11	0757-0199		RESISTOR; FXD; 21.5K1% .125W F TUBULAR	24546	C4-1/8-T0-2152-F
A11R12	0757-0442		RESISTOR; FXD; 10K1% .125W F TUBULAR	24546	C4-1/8-T0-1002-F
A11R13	0757-0279		RESISTOR; FXD; 3.16K1% .125W F TUBULAR	24546	C4-1/8-T0-3161-F
A11R14	0757-0199		RESISTOR; FXD; 21.5K1% .125W F TUBULAR	24546	C4-1/8-T0-2152-F
A11P15	0698-0082		RESISTOR; FXD; 464 OHM1% .125W F	16299	C4-1/8-T0-4640-F
A11R16	0757-0200		RESISTOR; FXD; 5.62K1% .125W F TUBULAR	24546	C4-1/8-T0-5621-F
A11R17	0757-0442		RESISTOR; FXD; 10K1% .125W F TUBULAR	24546	C4-1/8-T0-1002-F
A11R18	0757-0401		RESISTOR; FXD; 100 OHM1% .125W F	24546	C4-1/8-T0-101-F
A11R19	0757-0395		RESISTOR; FXD; 56.2 OHM1% .125W F	24546	C4-1/8-T0-56R2-F
A11R20	0757-0401		RESISTOR; FXD; 100 OHM1% .125W F	24546	C4-1/8-T0-101-F
A11R21	0757-0395		RESISTOR; FXD; 56.2 OHM1% .125W F	24546	C4-1/8-T0-56R2-F
A11R22	0757-0395		RESISTOR; FXD; 56.2 OHM1% .125W F	24546	C4-1/8-T0-56R2-F
A11R23	0757-0346		RESISTOR; FXD; 10 OHM1% .125W F TUBULAR	24546	C4-1/8-T0-10R0-F
A11R24	0757-0346	RESISTOR; FXD; 10 OHM1% .125W F TUBULAR	24546	C4-1/8-T0-10R0-F	
A11R25	0757-0442	RESISTOR; FXD; 10K1% .125W F TUBULAR	24546	C4-1/8-T0-1002-F	
A11R26	0698-3156	RESISTOR; FXD; 14.7K1% .125W F TUBULAR	16299	C4-1/8-T0-1472-F	
A11R27	0757-0280	RESISTOR; FXD; 1K1% .125W F TUBULAR	24546	C4-1/8-T0-1001-F	
A11R28	0698-3132	RESISTOR; FXD; 261 OHM1% .125W F	16299	C4-1/8-T0-2610-F	
A11R29		NOT ASSIGNED			
A11R30	0757-0346	RESISTOR; FXD; 10 OHM1% .125W F TUBULAR	24546	C4-1/8-T0-10R0-F	
A11R31	0757-0346	RESISTOR; FXD; 10 OHM1% .125W F TUBULAR	24546	C4-1/8-T0-10R0-F	
A11R32	0757-0280	RESISTOR; FXD; 1K1% .125W F TUBULAR	24546	C4-1/8-T0-1001-F	
A11R33	0698-3453	RESISTOR; FXD; 196K1% .125W F TUBULAR	16299	C4-1/8-T0-1963-F	
A11R34†	0698-3152	RESISTOR; FXD; 3.48K1% .125W F TUBULAR	16299	C4-1/8-T0-3481-F	
A11R35†	2100-2521	RESISTOR, VAR, TRMR, 2KOHM 10% C	19701	ET50X202	
A11R36†	0757-0290	RESISTOR; FXD; 6.19K1% .125W F TUBULAR	30983	MF4C1/8-T0-6191-F	
A11R37	0757-0279	RESISTOR; FXD; 3.16K1% .125W F TUBULAR	24546	C4-1/8-T0-3161-F	
A11R38	0757-0199	RESISTOR; FXD; 21.5K1% .125W F TUBULAR	24546	C4-1/8-T0-2152-F	
A11R39†	0698-3150	RESISTOR; FXD; 2.37K1% .125W F TUBULAR	16299	C4-1/8-T0-2371-F	
A11R40	2100-2521	RESISTOR, VAR, TRMR, 2KOHM 10% C	19701	ET50X202	
A11R41	0698-0082	RESISTOR; FXD; 464 OHM1% .125W F	16299	C4-1/8-T0-4640-F	
A11R42	0757-0200	RESISTOR; FXD; 5.62K1% .125W F TUBULAR	24546	C4-1/8-T0-5621-F	
A11R43	0757-0401	RESISTOR; FXD; 100 OHM1% .125W F	24546	C4-1/8-T0-101-F	
A11R44	0757-0401	RESISTOR; FXD; 100 OHM1% .125W F	24546	C4-1/8-T0-101-F	
A11R45	0757-0442	RESISTOR; FXD; 10K1% .125W F TUBULAR	24546	C4-1/8-T0-1002-F	
A11R46	0757-0401	RESISTOR; FXD; 100 OHM1% .125W F	24546	C4-1/8-T0-101-F	
A11R47	0757-0401	RESISTOR; FXD; 100 OHM1% .125W F	24546	C4-1/8-T0-101-F	
A11R48	0698-3156	RESISTOR; FXD; 14.7K1% .125W F TUBULAR	16299	C4-1/8-T0-1472-F	
A11R49	0698-0024	RESISTOR; FXD; 2.61K1% .5W F TUBULAR	03888	PME65-1/2-T0-2611-F	
A11R50	0698-0024	RESISTOR; FXD; 2.61K1% .5W F TUBULAR	03888	PME65-1/2-T0-2611-F	
A11R51	0757-0395	RESISTOR; FXD; 56.2 OHM1% .125W F	24546	C4-1/8-T0-56R2-F	
A11R52	0757-0395	RESISTOR; FXD; 56.2 OHM1% .125W F	24546	C4-1/8-T0-56R2-F	
A11R53	0757-1100	RESISTOR; FXD; 600 OHM1% .125W F	24546	C4-1/8-T0-601-F	
A11R54	0757-1100	RESISTOR; FXD; 600 OHM1% .125W F	24546	C4-1/8-T0-601-F	
A11R55	0757-0442	RESISTOR; FXD; 10K1% .125W F TUBULAR	24546	C4-1/8-T0-1002-F	
A11R56	0757-0442	RESISTOR; FXD; 10K1% .125W F TUBULAR	24546	C4-1/8-T0-1002-F	
A11RT1	5080-1718	1	THERMISTOR	28480	5080-1718
A11TP1	0360-1514		TERMINAL, SLDR STUD	28480	0360-1514
A11TP2	0360-1514		TERMINAL, SLDR STUD	28480	0360-1514
A11TP3	0360-1514		TERMINAL, SLDR STUD	28480	0360-1514
A11TP4	0360-1514		TERMINAL, SLDR STUD	28480	0360-1514
A11TP5	0360-1514		TERMINAL, SLDR STUD	28480	0360-1514
A11TP6	0360-1514		TERMINAL, SLDR STUD	28480	0360-1514
A11VR1	1902-3059	2	DIODE; ZENER; 3.83V VZ; .4W MAX PD	04713	SZ 10939-62
A11VR2	1902-3059		DIODE; ZENER; 3.83V VZ; .4W MAX PD	04713	SZ 10939-62
A11A1	08640-60149	1	FREQUENCY SELECT SWITCH ASSY	28480	08640-60149
A11A1MP1	08640-20218	2	HOUSING; GEAR SPROCKET, AUDIO	28480	08640-20218
A11A1MP2	08640-20205		GEAR SPUR	28480	08640-20205
A11A1MP3	1430-0763	2	GEAR SPUR	28480	1430-0763
A11A1MP4	08640-20084	1	SHAFT; AUDIO OSCILLATOR	28480	08640-20084
A11A1MP5	3030-0196	6	SCREW; SET; 4-40 UNC-3A .188 IN	28480	3030-0196
A11A1MP6	3030-0007		SCREW; SET; 4-40 UNC-3A .125 IN	28480	3030-0007
A11A1R1	0698-4471	2	RESISTOR; FXD; 7.15K1% .125W F TUBULAR	24546	C4-1/8-T0-7151-F
A11A1R2	0757-0199		RESISTOR; FXD; 21.5K1% .125W F TUBULAR	24546	C4-1/8-T0-2152-F

See introduction to this section for ordering information  
† SEE TABLES 7-1 AND 7-2, FOR BACKDATING.

Table 6-3. Replaceable Parts

Reference Designation	HP Part Number	Qty	Description	Mfr Code	Mfr Part Number
A11A1R3 A11A1R4 A11A1R5 A11A1R6 A11A1R7	0698-3454 0698-5903 0698-4471 0757-0199 0698-3454	2	RESISTOR; FXD; 215K1% .125W F TUBULAR RESISTOR; FXD; 2.4M1% .5W F TUBULAR RESISTOR; FXD; 7.15K1% .125W F TUBULAR RESISTOR; FXD; 21.5K1% .125W F TUBULAR RESISTOR; FXD; 215K1% .125W F TUBULAR	16299 19701 24546 24546 16299	C4-1/8-T0-2153-F MF7C1/2-T0-2404-F C4-1/8-T0-7151-F C4-1/8-T0-2152-F C4-1/8-T0-2153-F
A11A1R8 A11A1S1	0698-5903 08640-60108 3100-3081	1 1	RESISTOR; FXD; 2.4M1% .5W F TUBULAR SWITCH ASSY: AUDIO OSCILLATOR SWITCH: ROTARY	19701 28480 28480	MF7C1/2-T0-2404-F 08640-60108 3100-3081

See introduction to this section for ordering information

Table 6-3. Replaceable Parts

Reference Designation	HP Part Number	Qty	Description	Mfr Code	Mfr Part Number
A12	08640-60003	1	RECTIFIER ASSY	28480	08640-60003
A12C1	0160-0168	5	CAPACITOR;FXD; .1UF+-10% 200WVDC	56289	292P10492
A12C2	0160-0168		CAPACITOR;FXD; .1UF+-10% 200WVDC	56289	292P10492
A12C3	0160-0168		CAPACITOR;FXD; .1UF+-10% 200WVDC	56289	292P10492
A12C4	0160-0168		CAPACITOR;FXD; .1UF+-10% 200WVDC	56289	292P10492
A12C5	0160-0168		CAPACITOR;FXD; .1UF+-10% 200WVDC	56289	292P10492
A12CR1	1901-0418	20	DIODE; PWR RECT; SI; 400V MAX VRM 1.5A	04713	SR1846-12
A12CP2	1901-0418		DIODE; PWR RECT; SI; 400V MAX VRM 1.5A	04713	SR1846-12
A12CP3	1901-0418		DIODE; PWR RECT; SI; 400V MAX VRM 1.5A	04713	SR1846-12
A12CR4	1901-0418		DIODE; PWR RECT; SI; 400V MAX VRM 1.5A	04713	SR1846-12
A12CR5	1901-0418		DIODE; PWR RECT; SI; 400V MAX VRM 1.5A	04713	SR1846-12
A12CR6	1901-0418		DIODE; PWR RECT; SI; 400V MAX VRM 1.5A	04713	SR1846-12
A12CR7	1901-0418		DIODE; PWR RECT; SI; 400V MAX VRM 1.5A	04713	SR1846-12
A12CR8	1901-0418		DIODE; PWR RECT; SI; 400V MAX VRM 1.5A	04713	SR1846-12
A12CR9	1901-0418		DIODE; PWR RECT; SI; 400V MAX VRM 1.5A	04713	SR1846-12
A12CR10	1901-0418		DIODE; PWR RECT; SI; 400V MAX VRM 1.5A	04713	SR1846-12
A12CR11	1901-0418		DIODE; PWR RECT; SI; 400V MAX VRM 1.5A	04713	SR1846-12
A12CP12	1901-0418		DIODE; PWR RECT; SI; 400V MAX VRM 1.5A	04713	SR1846-12
A12CR13	1901-0418		DIODE; PWR RECT; SI; 400V MAX VRM 1.5A	04713	SR1846-12
A12CR14	1901-0418		DIODE; PWR RECT; SI; 400V MAX VRM 1.5A	04713	SR1846-12
A12CR15	1901-0418		DIODE; PWR RECT; SI; 400V MAX VRM 1.5A	04713	SR1846-12
A12CR16	1901-0418		DIODE; PWR RECT; SI; 400V MAX VRM 1.5A	04713	SR1846-12
A12CR17	1901-0418		DIODE; PWR RECT; SI; 400V MAX VRM 1.5A	04713	SR1846-12
A12CP18	1901-0418		DIODE; PWR RECT; SI; 400V MAX VRM 1.5A	04713	SR1846-12
A12CR19	1901-0418		DIODE; PWR RECT; SI; 400V MAX VRM 1.5A	04713	SR1846-12
A12CR20	1901-0418		DIODE; PWR RECT; SI; 400V MAX VRM 1.5A	04713	SR1846-12
A12MP1	0403-0026		GLIDE:NYLON	28480	0403-0026
A1201	1884-0012	6	THYRISTOR, SCR, JEDEC 2N3528	02735	2N3528
A12R1	0757-0401		RESISTOR; FXD; 100 OHM1% .125W F	24546	C4-1/8-T0-101-F
A12R2	0698-3447		RESISTOR; FXD; 422 OHM1% .125W F	16299	C4-1/8-T0-422R-F
A12R3	0757-0199		RESISTOR; FXD; 21.5K1% .125W F TUBULAR	24546	C4-1/8-T0-2152-F
A12R4	0757-0442		RESISTOR; FXD; 10K1% .125W F TUBULAR	24546	C4-1/8-T0-1002-F
A12P5	0757-0442		RESISTOR; FXD; 10K1% .125W F TUBULAR	24546	C4-1/8-T0-1002-F
A12P6	0757-0442		RESISTOR; FXD; 10K1% .125W F TUBULAR	24546	C4-1/8-T0-1002-F
A12P7	0757-0442		RESISTOR; FXD; 10K1% .125W F TUBULAR	24546	C4-1/8-T0-1002-F
A12VR1	1902-3393	1	DIODE; ZENER; 75V VZ; .4W MAX PD	04713	SZ 10939-434
A13	08640-60002	1	MODULATION/METERING MOTHER BOARD ASSY	28480	08640-60002
A13C1	0180-2208	5	CAPACITOR-FXD, 220UF+-10% 10VDC TA	56289	150D227X9010S2
A13C2	0180-2208		CAPACITOR-FXD, 220UF+-10% 10VDC TA	56289	150D227X9010S2
A13C3	0180-2208		CAPACITOR-FXD, 220UF+-10% 10VDC TA	56289	150D227X9010S2
A13C4	0180-2208		CAPACITOR-FXD, 220UF+-10% 10VDC TA	56289	150D227X9010S2
A13J1	1250-0257	3	CONNECTOR-COAX, SMB, 50 OHM MALE	28480	1250-0257
A13J2	1251-3055	2	CONNECTOR STRIP:8 MALE CONTACT	74868	221-70
A13J3	1250-0257		CONNECTOR-COAX, SMB, 50 OHM MALE	28480	1250-0257
A13J4	1250-0257		CONNECTOR-COAX, SMB, 50 OHM MALE	28480	1250-0257
A13J5	1251-3055		CONNECTOR STRIP:8 MALE CONTACT	74868	221-70
A13MP1	0403-0026		GLIDE:NYLON	28480	0403-0026
A13MP2	08640-20211		GUIDE:CONNECTOR	28480	08640-20211
A13MP3	08640-40063	4	GUIDE:SLIDE SWITCH	28480	08640-40063
A13R1	0757-0004	1	RESISTOR; FXD; 860 OHM1% .5W F TUBULAR	30983	MF7C1/2-T0-861-F
A13R2	0757-0443		RESISTOR; FXD; 11K1% .125W F TUBULAR	24546	C4-1/8-T0-1102-F
A13R3	2100-1986	1	RESISTOR, VAR, TRMR, 1KOHM 10% C	28480	2100-1986
A13R4	0757-0460		RESISTOR; FXD; 61.9K1% .125W F TUBULAR	24546	C4-1/8-T0-6192-F
A13R5	0757-0460		RESISTOR; FXD; 61.9K1% .125W F TUBULAR	24546	C4-1/8-T0-6192-F
A13S1	08640-60152	1	SWITCH:PC SLIDE 4R	28480	08640-60152
	1460-1174	7	SPRING, LEAF	28480	1460-1174
	5020-3440	2	SPRING:DETENT	28480	5020-3440
	5040-0320	1	SLIDE:4 ROW, 16 POSITION	28480	5040-0320
	5040-0335	2	LEVER-SWITCH-GRAY	28480	5040-0335
A13S2	08640-60153	1	SWITCH:PC SLIDE 3R	28480	08640-60153
	1460-1174		SPRING, LEAF	28480	1460-1174
	5020-3440		SPRING:DETENT	28480	5020-3440
	5040-0319	1	SLIDE:3 ROW, 12 POSITION	28480	5040-0319
	5040-0335		LEVER-SWITCH-GRAY	28480	5040-0335
A13XA2	1251-2571	8	CONNECTOR, PC EDGE, 15-CONT, DIP SOLDER	26742	91-6915-0702-00
A13XA3A4	1251-0472	1	CONNECTOR, PC EDGE, 6-CONT, DIP SOLDER	71785	252-06-30-300
A13XA4	1251-2571		CONNECTOR, PC EDGE, 15-CONT, DIP SOLDER	26742	91-6915-0702-00
A13XA5	1251-2571		CONNECTOR, PC EDGE, 15-CONT, DIP SOLDER	26742	91-6915-0702-00
A13XA7	1251-2571		CONNECTOR, PC EDGE, 15-CONT, DIP SOLDER	26742	91-6915-0702-00
A13XA8A3	5060-0109	2	CONNECTOR:15 CONTACTS	28480	5060-0109

See introduction to this section for ordering information



Table 6-3. Replaceable Parts

Reference Designation	HP Part Number	Qty	Description	Mfr Code	Mfr Part Number
A13XA11 A13XA15	1251-2571 1251-2035		CONNECTOR, PC EDGE, 15-CONT, DIP SOLDER CONNECTOR, PC EDGE, 15-CONT, DIP SOLDER	26742 71785	91-6915-0702-00 252-15-30-300
A14	5060-9409	1	LINE MODULE WITH FILTER, JADE GRAY	28480	5060-9409
A14P1	5020-8122	1	LINE VOLTAGE SELECTION CARD	28480	5020-8122
A15	08640-60018	1	RISER ASSY	28480	08640-60018
A15MP1	0403-0153	1	GUIDE, PC BOARD, 1 L .25 W LEXAN, BROWN	28480	0403-0153
A15MP2	0403-0154	1	GUIDE, PC BOARD, 1 L .25 W LEXAN, RED	28480	0403-0154
A15MP3	0403-0155	1	GUIDE, PC BOARD, 1 L .25 W LEXAN, ORANGE	28480	0403-0155
A15XA17	1251-3308	1	CONNECTOR, PC EDGE, 15-CONT, DIP SOLDER	71785	252-12-30-032
A16	08640-60119	1	FAN MOTOR ASSY	28480	08640-60119
A16B1	3140-0490	1	MOTOR, ELEC, BRUSHLESS 10VDC 2550 RPM	28480	3140-0490
A16P1	1251-0198 5040-0327	2 2	CONNECTOR, PC EDGE, 6-CONT, SOLDER EYE HOOD:CONNECTOR	71785 28480	251-06-30-261 5040-0327
A17	08640-60001	1	POWER SUPPLY MOTHER BOARD ASSY	28480	08640-60001
A17XA12	1251-2034	3	CONNECTOR, PC EDGE, 10-CONT, DIP SOLDER	71785	252-10-30-300
A17XA18	1251-2571		CONNECTOR, PC EDGE, 15-CONT, DIP SOLDER	26742	91-6915-0702-00
A17XA20	1251-2571		CONNECTOR, PC EDGE, 15-CONT, DIP SOLDER	26742	91-6915-0702-00
A17XA22	1251-2571		CONNECTOR, PC EDGE, 15-CONT, DIP SOLDER	26742	91-6915-0702-00
A17XA24	1251-2034		CONNECTOR, PC EDGE, 10-CONT, DIP SOLDER	71785	252-10-30-300
A17XA26	1251-2034		CONNECTOR, PC EDGE, 10-CONT, DIP SOLDER	71785	252-10-30-300
A18	08640-60004	1	-5.2V REGULATOR & FAN DRIVER ASSY	28480	08640-60004
A18C1	0180-0229	5	CAPACITOR-FXD, 33UF+-10% 10VDC TA-SOLID	56289	150D336X9010B2
A18C2	0160-3534	4	CAPACITOR-FXD; 510PF+-5% 100WVDC	28480	0160-3534
A18C3	0180-2214	1	CAPACITOR-FXD, 90UF+75-10% 16VDC AL	56289	30D906G016CC2
A18C4	0180-0197		CAPACITOR-FXD, 2.2UF+-10% 20VDC TA	56289	150D225X9020A2
A18C5	0160-2055		CAPACITOR, FXD, .01UF+80-20% 100WVDC	28480	0160-2055
A18CR1	1901-0040		DIODE; SWITCHING; SI ; 30V MAX VRM 50MA	28480	1901-0040
A18CR2	1901-0025		DIODE; GEN PRP; SI ; 100V MAX VRM 200MA	28480	1901-0025
A18CR3	1901-0025		DIODE; GEN PRP; SI ; 100V MAX VRM 200MA	28480	1901-0025
A18CR4	1901-0040		DIODE; SWITCHING; SI ; 30V MAX VRM 50MA	28480	1901-0040
A18CR5	1901-0040		DIODE; SWITCHING; SI ; 30V MAX VRM 50MA	28480	1901-0040
A18CR6	1901-0159	5	DIODE; PMR RECT; SI ; 400V MAX VRM 750MA	04713	SR1358-4
A18CR7	1901-0040		DIODE; SWITCHING; SI ; 30V MAX VRM 50MA	28480	1901-0040
A18CR8	1901-0040		DIODE; SWITCHING; SI ; 30V MAX VRM 50MA	28480	1901-0040
A18CR9	1901-0049	2	DIODE; PMR RECT; SI ; 50V MAX VRM 750MA	28480	1901-0049
A18CR10	1901-0049		DIODE; PMR RECT; SI ; 50V MAX VRM 750MA	28480	1901-0049
A18CR11	1901-0040		DIODE; SWITCHING; SI ; 30V MAX VRM 50MA	28480	1901-0040
A18CR12	1901-0050		DIODE; SWITCHING; SI ; 80V MAX VRM 200MA	28480	1901-0050
A18DS1	1990-0326	5	PHOTO-DEVICE, DID VSBL LT EMTR 200MW PD	28480	1990-0326
A18F1	2110-0425	1	FUSE:2 AMP	28480	2110-0425
A18MP1	4040-0752 1480-0073	2	EXTRACTOR:PC BOARD, YELLOW PIN:DRIVE 0.250" LG	28480 00000	4040-0752 08D
A18Q1	1853-0020		TRANSISTOR PNP SI PD=300MW FT=150MHZ	28480	1853-0020
A18Q2 †	1854-0039 1200-0173		TRANSISTOR NPN 2N3053 SI PD=1W INSULATOR, XSTR, TO- 5, .075 THK	04713 28480	2N3053 1200-0173
A18Q3	1884-0012		THYRISTOR, SCR, JEDEC 2N3528	02735	2N3528
A18Q4	1854-0003		TRANSISTOR NPN SI PD=800MW FT=50MHZ	28480	1854-0003
A18Q5 †	1853-0027 1200-0173	4	TRANSISTOR PNP SI PD=1W FT=100MHZ INSULATOR, XSTR, TO- 5, .075 THK	28480 28480	1853-0027 1200-0173
A18Q6	1853-0050	4	TRANSISTOR PNP SI PD=360MW FT=100MHZ	28480	1853-0050
A18Q7 †	1853-0027 1200-0173		TRANSISTOR PNP SI PD=1W FT=100MHZ INSULATOR, XSTR, TO- 5, .075 THK	28480 28480	1853-0027 1200-0173
A18Q8	1853-0050		TRANSISTOR PNP SI PD=360MW FT=100MHZ	28480	1853-0050
A18Q9	1853-0050		TRANSISTOR PNP SI PD=360MW FT=100MHZ	28480	1853-0050

See introduction to this section for ordering information  
 † SEE TABLES 7-1 AND 7-2, FOR BACKDATING.

Table 6-3. Replaceable Parts

Reference Designation	HP Part Number	Qty	Description	Mfr Code	Mfr Part Number
A18010†	1853-0027		TRANSISTOR PNP SI PD=1W FT=100MHZ	28480	1853-0027
	1200-0173		INSULATOR, XSTR, TO- 5, .075 THK	28480	1200-0173
A18011	1853-0050		TRANSISTOR PNP SI PD=360MW FT=100MHZ	28480	1853-0050
A18012†	1853-0027		TRANSISTOR PNP SI PD=1W FT=100MHZ	28480	1853-0027
	1200-0173		INSULATOR, XSTR, TO- 5, .075 THK	28480	1200-0173
A18R1	0757-0317		RESISTOR; FXD; 1.33K1% .125W F TUBULAR	24546	C4-1/8-T0-1331-F
A18R2	2100-3123	4	RESISTOR,VAR,TRMR 500 OHM 10% C	32997	3006P-1-501
A18R3	0757-0278		RESISTOR; FXD; 1.78K1% .125W F TUBULAR	24546	C4-1/8-T0-1781-F
A18R4	0683-0475	1	RESISTOR; FXD; 4.7 OHM5% .25W CC	01121	CB47G5
A18R5	0757-0420		RESISTOR; FXD; 750 OHM1% .125W F	24546	C4-1/8-T0-751-F
A18R6	0698-3440		RESISTOR; FXD; 196 OHM1% .125W F	16299	C4-1/8-T0-196R-F
A18R7	0757-0420		RESISTOR; FXD; 750 OHM1% .125W F	24546	C4-1/8-T0-751-F
A18R8	0698-3161		RESISTOR; FXD; 38.3K1% .125W F TUBULAR	16299	C4-1/8-T0-3832-F
A18R9	0811-2813	3	RESISTOR; FXD; 1 OHM5% .5W PPW TUBULAR	91637	RS1/2-T2-1R0-J
A18R10	0757-0316	2	RESISTOR; FXD; 42.2 OHM1% .125W F	24546	C4-1/8-T0-42R2-F
A18R11	0757-0317		RESISTOR; FXD; 1.33K1% .125W F TUBULAR	24546	C4-1/8-T0-1331-F
A18R12	0757-0397		RESISTOR; FXD; 68.1 OHM1% .125W F	24546	C4-1/8-T0-68R1-F
A18R13	0698-3447		RESISTOR; FXD; 422 OHM1% .125W F	16299	C4-1/8-T0-422R-F
A18R14	0757-0290		RESISTOR; FXD; 6.19K1% .125W F TUBULAR	30983	MF4C1/8-T0-6191-F
A18R15	0757-0442		RESISTOR; FXD; 10K1% .125W F TUBULAR	24546	C4-1/8-T0-1002-F
A18R16	0811-1553	1	RESISTOR; FXD; .68 OHM5% 2W PW TUBULAR	75042	BWH2-11/16-J
A18R17	0698-3438	4	RESISTOR; FXD; 147 OHM1% .125W F	16299	C4-1/8-T0-147R-F
A18R18	0698-3438		RESISTOR; FXD; 147 OHM1% .125W F	16299	C4-1/8-T0-147R-F
A18R19†	0698-7246		RESISTOR; FXD; 2.61K2% .05W F TUBULAR	24546	C3-1/8-T0-2611-G
A18TP1	0360-1514		TERMINAL, SLDR STUD	28480	0360-1514
A18TP2	0360-1514		TERMINAL, SLDR STUD	28480	0360-1514
A18TP3	0360-1514		TERMINAL, SLDR STUD	28480	0360-1514
A18TP4	0360-1514		TERMINAL, SLDR STUD	28480	0360-1514
A18TP5	0360-1514		TERMINAL, SLDR STUD	28480	0360-1514
A18TP6	0360-1514		TERMINAL, SLDR STUD	28480	0360-1514
A18U1	1826-0010	5	IC;LIN;VOLTAGE REGULATOR	07263	723HM
A18VR1	1902-3005	2	DIODE; ZENER; 2.43V VZ; .4W MAX PD	04713	SZ 10939-5
A18VR2	1902-3094	1	DIODE; ZENER; 5.11V VZ; .4W MAX PD	04713	SZ 10939-99
A18VR3	1902-0049		DIODE; ZENER; 6.19V VZ; .4W MAX PD	28480	1902-0049
A18XF1A	1251-2313	10	CONNECTOR,1-CONT SKT .04 DIA	24995	3-332070-5
A18XF1B	1251-2313		CONNECTOR,1-CONT SKT .04 DIA	24995	3-332070-5
A19			NOT ASSIGNED		
A20	08640-60005	1	+5.2V & +44.6V REGULATOR ASSY	28480	08640-60005
A20C1	0160-0153	1	CAPACITOR;FXD; .001UF+-10% 200WVDC	56289	292P10292
A20C2	0180-0229		CAPACITOR-FXD, 33UF+-10% 10VDC TA-SOLID	56289	1500336X901082
A20C3	0180-0234	1	CAPACITOR-FXD; 33UF+-20% 75VDC TA-WET	56289	109D336X0075F2
A20C4	0180-0228		CAPACITOR-FXD, 22UF+-10% 15VDC TA-SOLID	56289	1500226X901582
A20C5	0160-0300	1	CAPACITOR;FXD; .0027UF+-10% 200WVDC	56289	292P27292
A20C6	0180-2208		CAPACITOR-FXD, 220UF+-10% 10VDC TA	56289	1500227X901052
A20C7	0180-0229		CAPACITOR-FXD, 33UF+-10% 10VDC TA-SOLID	56289	1500336X901082
A20C8	0160-3094		CAPACITOR;FXD; .1UF+-10% 100WVDC	28480	0160-3094
A20CR1	1901-0159		DIODE; PMR RECT;SI ; 400V MAX VRM 750MA	04713	SR1358-4
A20CR2	1901-0050		DIODE; SWITCHING;SI ; 80V MAX VRM 200MA	28480	1901-0050
A20CR3	1901-0159		DIODE; PMR RECT;SI ; 400V MAX VRM 750MA	04713	SR1358-4
A20CR4	1901-0050		DIODE; SWITCHING;SI ; 80V MAX VRM 200MA	28480	1901-0050
A20CR5	1901-0050		DIODE; SWITCHING;SI ; 80V MAX VRM 200MA	28480	1901-0050
A20DS1	1990-0326		PHOTO-DEVICE, DIO VSBL LT EMTR 200MW PD	28480	1990-0326
A20DS2	1990-0326		PHOTO-DEVICE, DIO VSBL LT EMTR 200MW PD	28480	1990-0326
A20F1	2110-0332	1	FUSE, 3A 125V	71400	GMW 3
A20F2	2110-0047	1	FUSE, 1A 125V	71400	GMW-1
A20MP1	4040-0748		EXTRACTOR:PC BOARD, BLACK	28480	4040-0748
	1480-0073		PIN:DRIVE 0.250" LG	00000	0BD
A20MP2	4040-0753	2	EXTRACTOR:PC BOARD, GREEN	28480	4040-0753
	1480-0073		PIN:DRIVE 0.250" LG	00000	0BD
A20Q1	1884-0012		THYRISTOR, SCR, JEDEC 2N3528	02735	2N3528
A20Q2†	1854-0039		TRANSISTOR NPN 2N3053 SI PD=1W	04713	2N3053
	1200-0173		INSULATOR, XSTR, TO- 5, .075 THK	28480	1200-0173
A20Q3†	1854-0022		TRANSISTOR NPN SI PD=700MW FT=50MHZ	07263	S17843
	1200-0173		INSULATOR, XSTR, TO-5, .075 THK	28480	1200-0173
A20Q4†	1853-0038		TRANSISTOR PNP SI PD=1W FT=100MHZ	28480	1853-0038
	1200-0173		INSULATOR, XSTR, TO- 5, .075 THK	28480	1200-0173
A20Q5	1853-0020		TRANSISTOR PNP SI PD=300MW FT=150MHZ	28480	1853-0020
A20Q6	1854-0023	1	TRANSISTOR NPN SI PD=360MW FT=15MHZ	28480	1854-0023

See introduction to this section for ordering information  
 † SEE TABLES 7-1 AND 7-2, FOR BACKDATING.

Table 6-3. Replaceable Parts

Reference Designation	HP Part Number	Qty	Description	Mfr Code	Mfr Part Number
A2007	1884-0012		THYRISTOR, SCR, JEDEC 2N3528	02735	2N3528
A20R1	0698-3160		RESISTOR; FXD; 31.6K1% .125W F TUBULAR	16299	C4-1/8-T0-3162-F
A20R2	0698-3438		RESISTOR; FXD; 147 OHM1% .125W F	16299	C4-1/8-T0-147R-F
A20R3	0757-0462	1	RESISTOR; FXD; 75K1% .125W F TUBULAR	24546	C4-1/8-T0-7502-F
A20R4	0698-0083		RESISTOR; FXD; 1.96K1% .125W F TUBULAR	16299	C4-1/8-T0-1961-F
A20R5	0698-3407	1	RESISTOR; FXD; 1.96K1% .5W F TUBULAR	19701	MF7C1/2-T0-1961-F
A20R6	0698-3155		RESISTOR; FXD; 4.64K1% .125W F TUBULAR	16299	C4-1/8-T0-4641-F
A20R7	0698-3449		RESISTOR; FXD; 28.7K1% .125W F TUBULAR	16299	C4-1/8-T0-2872-F
A20R8	2100-3154		RESISTOR;VAR,TRMR 1K OHM 10% C	32997	3006P-1-102
A20R9	0757-0438		RESISTOR; FXD; 5.11K1% .125W F TUBULAR	24546	C4-1/8-T0-5111-F
A20R10	0811-2813		RESISTOR; FXD; 1 OHM5% .5W PPW TUBULAR	91637	RS1/2-T2-1R0-J
A20R11	0757-0158		RESISTOR; FXD; 619 OHM1% .5W F TUBULAR	30983	MF7C1/2-T0-619R-F
A20R12	0757-0397	1	RESISTOR; FXD; 68.1 OHM1% .125W F	24546	C4-1/8-T0-68R1-F
A20R13	0698-3447		RESISTOR; FXD; 422 OHM1% .125W F	16299	C4-1/8-T0-422R-F
A20R14	0811-1666	3	RESISTOR; FXD; 1 OHM5% 2W PW TUBULAR	75042	BWH2-1R0-J
A20R15	0757-0420		RESISTOR; FXD; 750 OHM1% .125W F	24546	C4-1/8-T0-751-F
A20R16	2100-3123		RESISTOR;VAR,TRMR 500 OHM 10% C	32997	3006P-1-501
A20R17	0698-3150		RESISTOR; FXD; 2.37K1% .125W F TUBULAR	16299	C4-1/8-T0-2371-F
A20R18	0757-0416		RESISTOR; FXD; 511 OHM1% .125W F	24546	C4-1/8-T0-511R-F
A20R19	0698-3440		RESISTOR; FXD; 196 OHM1% .125W F	16299	C4-1/8-T0-196R-F
A20R20	0757-0420		RESISTOR; FXD; 750 OHM1% .125W F	24546	C4-1/8-T0-751-F
A20R21	0811-2813		RESISTOR; FXD; 1 OHM5% .5W PPW TUBULAR	91637	RS1/2-T2-1R0-J
A20R22	0757-0316		RESISTOR; FXD; 42.2 OHM1% .125W F	24546	C4-1/8-T0-42R2-F
A20R23	0757-0397		RESISTOR; FXD; 68.1 OHM1% .125W F	24546	C4-1/8-T0-68R1-F
A20R24	0698-3447		RESISTOR; FXD; 422 OHM1% .125W F	16299	C4-1/8-T0-422R-F
A20R25	0811-1666		RESISTOR; FXD; 1 OHM5% 2W PW TUBULAR	75042	BWH2-1R0-J
A20R26	0811-1666		RESISTOR; FXD; 1 OHM5% 2W PW TUBULAR	75042	BWH2-1R0-J
A20R27 †	0698-7246		RESISTOR; FXD; 2.61K2% .05W F TUBULAR	24546	C3-1/8-T0-2611-G
A20TP1	0360-1514		TERMINAL, SLDR STUD	28480	0360-1514
A20TP2	0360-1514		TERMINAL, SLDR STUD	28480	0360-1514
A20TP3	0360-1514		TERMINAL, SLDR STUD	28480	0360-1514
A20TP4	0360-1514		TERMINAL, SLDR STUD	28480	0360-1514
A20TP5	0360-1514		TERMINAL, SLDR STUD	28480	0360-1514
A20TP6	0360-1514		TERMINAL, SLDR STUD	28480	0360-1514
A20TP7	0360-1514		TERMINAL, SLDR STUD	28480	0360-1514
A20TP8	0360-1514		TERMINAL, SLDR STUD	28480	0360-1514
A20TP9	0360-1514		TERMINAL, SLDR STUD	28480	0360-1514
A20TP10	0360-1514		TERMINAL, SLDR STUD	28480	0360-1514
A20U1	1826-0010		IC;LIN;VOLTAGE REGULATOR	07263	723HM
A20U2	1826-0010		IC;LIN;VOLTAGE REGULATOR	07263	723HM
A20VR1	1902-0025	1	DIODE; ZENER; 10V VZ; .4W MAX PD	04713	SZ 10939-182
A20VR2	1902-3234	1	DIODE; ZENER; 19.6V VZ; .4W MAX PD	04713	SZ 10939-266
A20VR3	1902-0244	1	DIODE; ZENER; 30.1V VZ; 1W MAX PD	04713	SZ11213-278
A20VR4	1902-3345	1	DIODE; ZENER; 51.1V VZ; .4W MAX PD	04713	SZ 10939-386
A20VR5	1902-3005	1	DIODE; ZENER; 2.43V VZ; .4W MAX PD	04713	SZ 10939-5
A20VR6	1902-0049		DIODE; ZENER; 6.19V VZ; .4W MAX PD	28480	1902-0049
A20XF1A	1251-2313		CONNECTOR,1-CONT SKT .04 DIA	24995	3-332070-5
A20XF1B	1251-2313		CONNECTOR,1-CONT SKT .04 DIA	24995	3-332070-5
A20XF2A	1251-2313		CONNECTOR,1-CONT SKT .04 DIA	24995	3-332070-5
A20XF2B	1251-2313		CONNECTOR,1-CONT SKT .04 DIA	24995	3-332070-5
A21			NOT ASSIGNED		
A22	08640-60006	1	+20V & -20V REGULATOR ASSY	28480	08640-60006
A22C1	0180-0229		CAPACITOR-FXD, 33UF+-10% 10VDC TA-SOLID	56289	150D336X901082
A22C2	0160-3534		CAPACITOR;FXD; 510PF+-5% 100WVDC	28480	0160-3534
A22C3	0160-0158	2	CAPACITOR;FXD; .0056UF+-10% 200WVDC	56289	292P56292
A22C4	0180-0058	2	CAPACITOR-FXD; 50UF+75-10% 25VDC AL	56289	30D506G025CC2
A22C5	0180-0229		CAPACITOR-FXD, 33UF+-10% 10VDC TA-SOLID	56289	150D336X901082
A22C6	0160-3534		CAPACITOR;FXD; 510PF+-5% 100WVDC	28480	0160-3534
A22C7	0160-0158		CAPACITOR;FXD; .0056UF+-10% 200WVDC	56289	292P56292
A22C8	0180-0058		CAPACITOR-FXD; 50UF+75-10% 25VDC AL	56289	30D506G025CC2
A22CR1	1901-0025		DIODE; GEN PRP; SI; 100V MAX VRM 200MA	28480	1901-0025
A22CR2	1901-0159		DIODE; PWR RECT; SI; 400V MAX VRM 750MA	04713	SR1358-4
A22CR3	1901-0050		DIODE; SWITCHING; SI; 80V MAX VRM 200MA	28480	1901-0050
A22CR4	1901-0025		DIODE; GEN PRP; SI; 100V MAX VRM 200MA	28480	1901-0025
A22CR5	1901-0050		DIODE; SWITCHING;SI; 80V MAX VRM 200MA	28480	1901-0050
A22CR6	1901-0159		DIODE; PWR RECT; SI; 400V MAX VRM 750MA	04713	SR1358-4
A22DS1	1990-0326		PHOTO-DEVICE, DIO VSBL LT EMTR 200MW PD	28480	1990-0326
A22DS2	1990-0326		PHOTO-DEVICE, DIO VSBL LT EMTR 200MW PD	28480	1990-0326
A22F1	2110-0424	2	FUSE;MINIATURE BI-PIN 3/4A	71400	GMW3/4A

See introduction to this section for ordering information  
 † SEE TABLES 7-1 AND 7-2, FOR BACKDATING.

Table 6-3. Replaceable Parts

Reference Designation	HP Part Number	Qty	Description	Mfr Code	Mfr Part Number
A22F2	2110-0424		FUSE:MINIATURE BI-PIN 3/4A	71400	GMW3/4A
A22MP1	4040-0748 1480-0073		EXTRACTOR:PC BOARD, BLACK PIN:DRIVE 0.250" LG	28480 90000	4040-0748 0BD
A22MP2	4040-0754 1480-0073	1	EXTRACTOR:PC BOARD, BLUE PIN:DRIVE 0.250" LG	28480 00000	4040-0754 0BD
A22Q1	1884-0012		THYRISTOR, SCR, JEDEC 2N3528	02735	2N3528
A22Q2 †	1854-0039		TRANSISTOR NPN 2N3053 SI PD=1W	04713	2N3053
	1200-0173		INSULATOR, XSTR, TO-5, .075 THK	28480	1200-0173
A22Q3 †	1854-0039		TRANSISTOR NPN 2N3053 SI PD=1W	04713	2N3053
	1200-0173		INSULATOR, XSTR, TO-5, .075 THK	28480	1200-0173
A22Q4	1884-0012		THYRISTOR, SCR, JEDEC 2N3528	02735	2N3528
A22R1	0698-0085		RESISTOR; FXD; 2.61K1% .125W F TUBULAR	16299	C4-1/8-T0-2611-F
A22R2	0757-0280		RESISTOR; FXD; 1K1% .125W F TUBULAR	24546	C4-1/8-T0-1001-F
A22R3	0698-3154		RESISTOR; FXD; 4.22K1% .125W F TUBULAR	16299	C4-1/8-T0-4221-F
A22R4	0757-0401		RESISTOR; FXD; 100 OHM1% .125W F	24546	C4-1/8-T0-101-F
A22R5	0698-0084		RESISTOR; FXD; 2.15K1% .125W F TUBULAR	16299	C4-1/8-T0-2151-F
A22R6	0698-3154		RESISTOR; FXD; 4.22K1% .125W F TUBULAR	16299	C4-1/8-T0-4221-F
A22R7	2100-3123		RESISTOR,VAR,TRMR 500 OHM 10% C	32997	3006P-1-501
A22R8	0683-0275	2	RESISTOR; FXD; 2.7 OHM5% .25W CC	01121	CB27G5
A22R9	0698-3439	2	RESISTOR; FXD; 178 OHM1% .125W F	16299	C4-1/8-T0-178R-F
A22R10	0757-0397		RESISTOR; FXD; 68.1 OHM1% .125W F	24546	C4-1/8-T0-68R1-F
A22R11	0698-3447		RESISTOR; FXD; 422 OHM1% .125W F	16299	C4-1/8-T0-422R-F
A22R12	0811-1668	2	RESISTOR; FXD; 1.5 OHM5% 2W PW TUBULAR	75042	BWH2-1R5-J
A22R13	0757-0278		RESISTOR; FXD; 1.78K1% .125W F TUBULAR	24546	C4-1/8-T0-1781-F
A22R14	0698-0085		RESISTOR; FXD; 2.61K1% .125W F TUBULAR	16299	C4-1/8-T0-2611-F
A22R15	0757-0280		RESISTOR; FXD; 1K1% .125W F TUBULAR	24546	C4-1/8-T0-1001-F
A22R16	0698-3154		RESISTOR; FXD; 4.22K1% .125W F TUBULAR	16299	C4-1/8-T0-4221-F
A22R17	0757-0401		RESISTOR; FXD; 100 OHM1% .125W F	24546	C4-1/8-T0-101-F
A22R18	0757-0438		RESISTOR; FXD; 5.11K1% .125W F TUBULAR	24546	C4-1/8-T0-5111-F
A22R19	2100-3123		RESISTOR,VAR,TRMR 500 OHM 10% C	32997	3006P-1-501
A22R20	0698-0084		RESISTOR; FXD; 2.15K1% .125W F TUBULAR	16299	C4-1/8-T0-2151-F
A22R21	0683-0275		RESISTOR; FXD; 2.7 OHM5% .25W CC	01121	CB27G5
A22R22	0698-3439		RESISTOR; FXD; 178 OHM1% .125W F	16299	C4-1/8-T0-178R-F
A22R23	0757-0397		RESISTOR; FXD; 68.1 OHM1% .125W F	24546	C4-1/8-T0-68R1-F
A22R24	0698-3447		RESISTOR; FXD; 422 OHM1% .125W F	16299	C4-1/8-T0-422R-F
A22R25 †	0811-1668		RESISTOR; FXD; 1.5 OHM5% 2W PW TUBULAR	75042	BWH2-1R5-J
A22R26 †	0698-7260		RESISTOR; FXD; 10K2% .05W F TUBULAR	24546	C3-1/8-T0-1002-G
A22R27 †	0698-7260		RESISTOR; FXD; 10K2% .05W F TUBULAR	24546	C3-1/8-T0-1002-G
A22TP1	0360-1514		TERMINAL, SLDR STUD	28480	0360-1514
A22TP2	0360-1514		TERMINAL, SLDR STUD	28480	0360-1514
A22TP3	0360-1514		TERMINAL, SLDR STUD	28480	0360-1514
A22TP4	0360-1514		TERMINAL, SLDR STUD	28480	0360-1514
A22TP5	0360-1514		TERMINAL, SLDR STUD	28480	0360-1514
A22TP6	0360-1514		TERMINAL, SLDR STUD	28480	0360-1514
A22TP7	0360-1514		TERMINAL, SLDR STUD	28480	0360-1514
A22TP8	0360-1514		TERMINAL, SLDR STUD	28480	0360-1514
A22TP9	0360-1514		TERMINAL, SLDR STUD	28480	0360-1514
A22TP10	0360-1514		TERMINAL, SLDR STUD	28480	0360-1514
A22U1	1826-0010		IC:LIN;VOLTAGE REGULATOR	07263	723HM
A22U2	1826-0010		IC:LIN;VOLTAGE REGULATOR	07263	723HM
A22VR1	1902-0202	2	DIODE; ZENER; 15V VZ; 1W MAX PD	04713	SZ11213-191
A22VR2	1902-3256	2	DIODE; ZENER; 23.7V VZ; .4W MAX PD	04713	SZ 10939-290
A22VR3	1902-0761	1	DIODE; ZENER; 6.2V VZ; .25W MAX PD	04713	1N821
A22VR4	1902-0202		DIODE; ZENER; 15V VZ; 1W MAX PD	04713	SZ11213-191
A22VR5	1902-3256		DIODE; ZENER; 23.7V VZ; .4W MAX PD	04713	SZ 10939-290
A22XF1 A	1251-2313		CONNECTOR,1-CONT SKT .04 DIA	24995	3-332070-5
A22XF1 B	1251-2313		CONNECTOR,1-CONT SKT .04 DIA	24995	3-332070-5
A22XF2 A	1251-2313		CONNECTOR,1-CONT SKT .04 DIA	24995	3-332070-5
A22XF2 B	1251-2313		CONNECTOR,1-CONT SKT .04 DIA	24995	3-332070-5
A23			NOT ASSIGNED		
A24	08640-60007	1	SERIES REGULATOR SOCKET ASSY	28480	08640-60007
A24MP1	0361-0009	3	RIVET:SEM TUBULAR 1/8 X 3/16" LG	00000	0BD
A24MP2	0403-0152	3	GUIDE, PC BOARD, 1 L, 25 W, LEXAN, BLACK	28480	0403-0152
A24XQ1	1200-0041		SOCKET, ELEC, XSTR 2-CONT TO-3 PKG SLDR	00014	PTS-1
A24XQ2	1200-0041		SOCKET, ELEC, XSTR 2-CONT TO-3 PKG SLDR	00014	PTS-1
A24XQ3	1200-0041		SOCKET, ELEC, XSTR 2-CONT TO-3 PKG SLDR	00014	PTS-1
A24XQ4	1200-0041		SOCKET, ELEC, XSTR 2-CONT TO-3 PKG SLDR	00014	PTS-1

See introduction to this section for ordering information  
 † SEE TABLES 7-1 AND 7-2, FOR BACKDATING.

Table 6-3. Replaceable Parts

Reference Designation	HP Part Number	Qty	Description	Mfr Code	Mfr Part Number
A25			NOT ASSIGNED		
A26	08640-60110	1	AM/AGC AND RF AMPLIFIER ASSY	28480	08640-60110
A26C1	0160-2049	3	CAPACITOR;FXD; .005UF+80-20% 500WVDC	28480	0160-2049
A26C2	0160-2049		CAPACITOR;FXD; .005UF+80-20% 500WVDC	28480	0160-2049
A26C3	0160-3219		CAPACITOR;FXD; 100PF+-20% 500WVDC	28480	0160-3219
A26C4	0160-3219		CAPACITOR;FXD; 100PF+-20% 500WVDC	28480	0160-3219
A26C5	0160-2049		CAPACITOR;FXD; .005UF+80-20% 500WVDC	28480	0160-2049
A26C6	0160-2049		CAPACITOR;FXD; .005UF+80-20% 500WVDC	28480	0160-2049
A26C7	0160-2049		CAPACITOR;FXD; .005UF+80-20% 500WVDC	28480	0160-2049
A26C8	0160-2049		CAPACITOR;FXD; .005UF+80-20% 500WVDC	28480	0160-2049
A26C9	0160-2049		CAPACITOR;FXD; .005UF+80-20% 500WVDC	28480	0160-2049
A26C10	0160-2049		CAPACITOR;FXD; .005UF+80-20% 500WVDC	28480	0160-2049
A26C11	0160-2049		CAPACITOR;FXD; .005UF+80-20% 500WVDC	28480	0160-2049
A26C12	0160-2049	1	CAPACITOR;FXD; .005UF+80-20% 500WVDC	28480	0160-2049
A26C13	0160-3961		CAPACITOR;FXD; 56PF+-20% 500WVDC	28480	0160-3961
A26C14	0160-3219	2	CAPACITOR;FXD; 100PF+-20% 500WVDC	28480	0160-3219
A26C15	0160-2049		CAPACITOR;FXD; .005UF+80-20% 500WVDC	28480	0160-2049
A26C16	0160-2049		CAPACITOR;FXD; .005UF+80-20% 500WVDC	28480	0160-2049
A26C17	0160-2152		CAPACITOR;FXD; 10PF+-20% 500WVDC	28480	0160-2152
A26C18	0160-2152		CAPACITOR;FXD; 10PF+-20% 500WVDC	28480	0160-2152
A26J1	1250-0829		1	CONNECTOR-COAX, SMC, 50 OHM MALE	98291
A26J2	1250-1423	1	CAP:COAXIAL	28480	1250-1423
A26J3	1251-2613	11	CONNECTOR,1-CONT SKT .033 DIA	24995	50864-3
A26L1	9100-1620	1	COIL, FXD, MOLDED RF CHOKE, 15UH 10%	24226	15/152
A26L2	9100-1621		COIL, FXD, MOLDED RF CHOKE, 18UH 10%	24226	15/182
A26L3	9100-1620	1	COIL, FXD, MOLDED RF CHOKE, 15UH 10%	24226	15/152
A26L4	9100-1620		COIL, FXD, MOLDED RF CHOKE, 15UH 10%	24226	15/152
A26L5	9100-1620		COIL, FXD, MOLDED RF CHOKE, 15UH 10%	24226	15/152
A26L6	9100-1620		COIL, FXD, MOLDED RF CHOKE, 15UH 10%	24226	15/152
A26L7	9140-0178		COIL, FXD, MOLDED RF CHOKE, 12UH 10%	24226	15/122
A26L8	9100-1620		COIL, FXD, MOLDED RF CHOKE, 15UH 10%	24226	15/152
A26MP1	8160-0218		1	GASKET MATL;RFI; FL STRP/SH NICKEL	28480
A26MP2	8160-0222	1	GASKET MATL;RFI; FL STRP/SH NICKEL	28480	8160-0222
A26MP3	8160-0223	1	GASKET MATL;RFI; FL STRP/SH NICKEL	28480	8160-0223
A26MP4	8160-0224	1	GASKET;MOD BOTTOM COVER	28480	8160-0224
A26MP5	08640-00012	1	COVER:ACCESS	28480	08640-00012
A26MP6	08640-00018	1	COVER:FILTER MODULE	28480	08640-00018
A26MP7	08640-20076	1	COVER:TOP MODULE	28480	08640-20076
A26MP8	08640-20077	1	CASTING:MODULE	28480	08640-20077
A26MP9	08640-20081	1	COVER:BOTTOM MODULE	28480	08640-20081
A26MP10	08640-00013	1	COVER:FILTER AMPLIFIER	28480	08640-00013
A26MP11	0403-0153	1	GUIDE, PC BOARD, 1 L .25 W LEXAN,BROWN	28480	0403-0153
A26MP12	0403-0156		GUIDE, PC BOARD, 1 L .25 W LEXAN,YELLOW	28480	0403-0156
A26MP13	0403-0157		GUIDE, PC BOARD, 1 L .25 W LEXAN,GREEN	28480	0403-0157
A26MP14	2200-0107		SCREW;MACHINE; 4-40 UNC-2A .375 IN PAN	28480	2200-0107
A26MP15	0520-0127	1	SCREW;MACHINE; 2-56 UNC-2A .188 IN PAN	28480	0520-0127
A26MP16	2360-0201		SCREW;MACHINE; 6-32 UNC-2A .5 IN PAN	28480	2360-0201
A26MP17	2950-0078		NUT, HEX 10-32 .067 X .25, BRS, AU PL	24931	HN100-11
A26MP18	2190-0124		WASHER; LOCK; INT; 10 .195 ID .311 OD	24931	LW101-30
A26MP19	2190-0012		WASHER; LOCK; EXT; 10 .195 ID .406 OD	78189	1810-00
A26MP20	2190-0014		WASHER; LOCK; INT; 2 .089 ID .185 OD	78189	1902-00
A26MP21	2190-0018		WASHER; LOCK; HELICAL; 6 .141 ID .269	28480	2190-0018
A26MP22	3050-0228		WASHER; FLAT .156 ID .312 OD	80120	MS15795-305
A26MP23	2950-0035		NUT, HEX 15/32-32 .078 X .562, BRS, NI	73076	
A26MP24	2190-0068	WASHER; LOCK; INT .505 ID .63 OD	78189	1924-02	
A26MP25	0361-1071	1	RIVET,BLIND, DOME HD 0.125" DIA	11815	AAP-4-3
A26R1	0757-0159		RESISTOR; FXD; 1K1% .5W F TUBULAR	30983	MF7C1/2-T0-1R0-F
A26U1	5086-7068	1	OUTPUT AMPLIFIER	28480	5086-7068
A26U2	08640-00002	2	HEAT SINK;TRANSISTOR	28480	08640-00002
	5086-7079	1	MODULATOR PREAMPLIFIER	28480	5086-7079
A26W1	08640-00002	1	HEAT SINK;TRANSISTOR	28480	08640-00002
	8120-1889		CABLE ASSY(I9562)	28480	8120-1889
	8120-1887		CABLE ASSY(O9285)	28480	8120-1887
	8120-1905		CABLE ASSY(2.953)	28480	8120-1905
A26W4	8120-1892	1	CABLE:COAX ASSY(3.479)	94142	A-8120-1892-1
A26A1	08640-60017	1	POWER AMPLIFIER & AGC DETECTOR ASSY	28480	08640-60017
A26A1	08640-60088		REBUILT 08640-60017, REQUIRES EXCHANGE	28480	08640-60088

See introduction to this section for ordering information

Table 6-3. Replaceable Parts

Reference Designation	HP Part Number	Qty	Description	Mfr Code	Mfr Part Number
A26A1C1	0160-3094		CAPACITOR;FXD; .1UF+-10% 100WVDC	28480	0160-3094
A26A1C2			NOT ASSIGNED		
A26A1C3	0160-3094		CAPACITOR;FXD; .1UF+-10% 100WVDC	28480	0160-3094
A26A1C4	0160-3094		CAPACITOR;FXD; .1UF+-10% 100WVDC	28480	0160-3094
A26A1C5	0180-0197		CAPACITOR-FXD; 2.2UF+-10% 20VDC TA	56289	150D225X9020A2
A26A1C6	0140-0198	1	CAPACITOR;FXD; 200PF+-5% 300WVDC	72136	DM15F201J0300WVICR
A26A1C7	0160-2204		CAPACITOR;FXD; 100PF+-5% 300WVDC	28480	0160-2204
A26A1CR1	1910-0022	8	DIODE; SWITCHING;GE ; 5V MAX VRM 60MA	28480	1910-0022
A26A1CR2	1901-0040		DIODE; SWITCHING;SI ; 30V MAX VRM 50MA	28480	1901-0040
A26A1CR3	1901-0539	2	DIODE; SCHOTTKY; HOT CARRIER	28480	1901-0539
A26A1CR4	1901-0040		DIODE; SWITCHING;SI ; 30V MAX VRM 50MA	28480	1901-0040
A26A1L1	9100-1620		COIL, FXD, MOLDED RF CHOKE, 15UH 10%	24226	15/152
A26A1L2	9140-0180	1	COIL, FXD, MOLDED RF CHOKE, 2.7UH 10%	24226	15/271
A26A1MP1	0340-0044	2	TERMINAL, SLDR STUD, .148 SHK DIA	83330	92-1500
A26A1MP2	0340-0044		TERMINAL, SLDR STUD, .148 SHK DIA	83330	92-1500
A26A1Q1 †	1853-0015	1	TRANSISTOR PNP SI PD=200MW FT=500MHZ	28480	1853-0015
A26A1Q2	1854-0071		TRANSISTOR NPN SI PD=300MW FT=200MHZ	28480	1854-0071
A26A1Q3	1854-0071		TRANSISTOR NPN SI PD=300MW FT=200MHZ	28480	1854-0071
A26A1Q4	1854-0071		TRANSISTOR NPN SI PD=300MW FT=200MHZ	28480	1854-0071
A26A1Q5	1855-0049	1	TRANSISTOR, JFET,DUAL, N-CHAN D-MODE SI	28480	1855-0049
A26A1Q6	1853-0007	2	TRANSISTOR PNP 2N3251 SI PD=360MW	04713	2N3251
A26A1R1	0757-0441		RESISTOR; FXD; 8.25K1% .125W F TUBULAR	24546	C4-1/8-T0-8251-F
A26A1R2	0698-3443	1	RESISTOR; FXD; 287 OHM1% .125W F	16299	C4-1/8-T0-287R-F
A26A1R3	0698-3160		RESISTOR; FXD; 31.6K1% .125W F TUBULAR	16299	C4-1/8-T0-3162-F
A26A1R4	0698-3446		RESISTOR; FXD; 383 OHM1% .125W F	16299	C4-1/8-T0-383R-F
A26A1R5	0698-3445	1	RESISTOR; FXD; 348 OHM1% .125W F	16299	C4-1/8-T0-348R-F
A26A1R6	0757-0280		RESISTOR; FXD; 1K1% .125W F TUBULAR	24546	C4-1/8-T0-1001-F
A26A1R7	0683-1055	1	RESISTOR; FXD; 1M5% .25W CC TUBULAR	01121	CB1055
A26A1R8	0698-3450		RESISTOR; FXD; 42.2K1% .125W F TUBULAR	16299	C4-1/8-T0-4222-F
A26A1R9	0757-0438		RESISTOR; FXD; 5.11K1% .125W F TUBULAR	24546	C4-1/8-T0-5111-F
A26A1R10	0757-0442		RESISTOR; FXD; 10K1% .125W F TUBULAR	24546	C4-1/8-T0-1002-F
A26A1R11	2100-2061	1	RESISTOR, VAR, TRMR, 200 OHM 10% C	28480	2100-2061
A26A1R12	0757-0401		RESISTOR; FXD; 100 OHM1% .125W F	24546	C4-1/8-T0-101-F
A26A1R13	0757-0401		RESISTOR; FXD; 100 OHM1% .125W F	24546	C4-1/8-T0-101-F
A26A1R14	0698-3450		RESISTOR; FXD; 42.2K1% .125W F TUBULAR	16299	C4-1/8-T0-4222-F
A26A1R15	0757-0280		RESISTOR; FXD; 1K1% .125W F TUBULAR	24546	C4-1/8-T0-1001-F
A26A1R16 †	0698-3438		RESISTOR; FXD; 147 OHM1% .125W F	16299	C4-1/8-T0-147R-F
A26A1R17 †	0698-3132		RESISTOR; FXD; 261 OHM1% .125W F	16299	C4-1/8-T0-2610-F
A26A1TP1	0360-1514		TERMINAL, SLDR STUD	28480	0360-1514
A26A1VR1	1902-0184	1	DIODE; ZENER; 16.2V VZ; .4W MAX PD	28480	1902-0184
A26A1VR2	1902-0048	1	DIODE; ZENER; 6.81V VZ; .4W MAX PD	28480	1902-0048
A26A1XU1A -E	1251-2613		CONNECTOR,1-CONT SKT .033 DIA	24995	50864-3
A26A2	08640-60014	1	AM OFFSET & PULSE SWITCHING ASSY	28480	08640-60014
A26A2C1	0180-0291		CAPACITOR-FXD, 1UF+-10% 35VDC TA-SOLID	56289	150D105X9035A2
A26A2C2	0180-0291		CAPACITOR-FXD, 1UF+-10% 35VDC TA-SOLID	56289	150D105X9035A2
A26A2C3	0180-0291		CAPACITOR-FXD, 1UF+-10% 35VDC TA-SOLID	56289	150D105X9035A2
A26A2C4	0180-0291		CAPACITOR-FXD, 1UF+-10% 35VDC TA-SOLID	56289	150D105X9035A2
A26A2C5	0160-3450	2	CAPACITOR,FXD, .005UF+-10% 250WVDC	28480	0160-3450
A26A2C6	0160-0161		CAPACITOR;FXD; .01UF+-10% 200WVDC	56289	292P10392
A26A2C7	0160-3450	2	CAPACITOR,FXD, .005UF+-10% 250WVDC	28480	0160-3450
A26A2C8	0180-1743		CAPACITOR-FXD, .1UF+-10% 35VDC TA-SOLID	56289	150D104X9035A2
A26A2C9			NOT ASSIGNED		
A26A2C10	0180-0100		CAPACITOR-FXD, 4.7UF+-10% 35VDC TA	56289	150D475X9035B2
A26A2C11	0180-0116		CAPACITOR-FXD, 6.8UF+-10% 35VDC TA	56289	150D685X9035B2
A26A2C12	0180-0291		CAPACITOR-FXD, 1UF+-10% 35VDC TA-SOLID	56289	150D105X9035A2
A26A2CR1	1910-0022		DIODE; SWITCHING; GE ; 5V MAX VRM 60MA	28480	1910-0022
A26A2CR2	1901-0022	7	DIODE; STABISTOR; SI ; 10V MAX VRM 250MA	28480	1901-0022
A26A2CR3	1901-0022		DIODE; STABISTOR; SI ; 10V MAX VRM 250MA	28480	1901-0022
A26A2CR4	1901-0022		DIODE; STABISTOR; SI ; 10V MAX VRM 250MA	28480	1901-0022
A26A2CR5	1901-0040		DIODE; SWITCHING; SI ; 30V MAX VRM 50MA	28480	1901-0040
A26A2CR6	1901-0040		DIODE; SWITCHING; SI ; 30V MAX VRM 50MA	28480	1901-0040
A26A2CR7	1901-0040		DIODE; SWITCHING; SI ; 30V MAX VRM 50MA	28480	1901-0040
A26A2CR8			NOT ASSIGNED		
A26A2CR9 †	1910-0022		DIODE; SWITCHING;GE ; 5V MAX VRM 60MA	28480	1910-0022
A26A2CR10	1901-0040		DIODE; SWITCHING; SI ; 30V MAX VRM 50MA	28480	1901-0040
A26A2CR11	1901-0040		DIODE; SWITCHING; SI ; 30V MAX VRM 50MA	28480	1901-0040
A26A2CR12	1901-0040		DIODE; SWITCHING; SI ; 30V MAX VRM 50MA	28480	1901-0040

See introduction to this section for ordering information  
 † SEE TABLES 7-1 AND 7-2, FOR BACKDATING.

Table 6-3. Replaceable Parts

Reference Designation	HP Part Number	Qty	Description	Mfr Code	Mfr Part Number
A26A2CR13	1910-0022		DIODE; SWITCHING;GE ; 5V MAX VRM 60MA	28480	1910-0022
A26A2CR14	1910-0022		DIODE; SWITCHING;GE ; 5V MAX VRM 60MA	28480	1910-0022
A26A2CR15	1910-0022		DIODE; SWITCHING;GE ; 5V MAX VRM 60MA	28480	1910-0022
A26A2CR16	1910-0022		DIODE; SWITCHING;GE ; 5V MAX VRM 60MA	28480	1910-0022
A26A2CR17	1901-0040		DIODE; SWITCHING;SI ; 30V MAX VRM 50MA	28480	1901-0040
A26A2CR18	1910-0022		DIODE; SWITCHING;GE ; 5V MAX VRM 60MA	28480	1910-0022
A26A2K1	0490-1080		RELAY, REED, 1C .25A 150V CONT, 5V COIL	32255	SX30-014
A26A2L1	9100-1641	4	COIL; FXD; MOLDED RF CHOKE; 240UH 5%	24226	15/243
A26A2L2	9100-1641		COIL; FXD; MOLDED RF CHOKE; 240UH 5%	24226	15/243
A26A2L3	9100-1620		COIL, FXD, MOLDED RF CHOKE, 15UH 10%	24226	15/152
A26A2MP1	4040-0749		EXTRACTOR;PC BOARD, BROWN	28480	4040-0749
	1480-0073		PIN;DRIVE 0.250" LG	00000	0BD
A26A2MP2	4040-0752		EXTRACTOR;PC BOARD, YELLOW	28480	4040-0752
	1480-0073		PIN;DRIVE 0.250" LG	00000	0BD
A26A2Q1	1854-0221		TRANSISTOR, BIPOL, SI, NPN DUAL	28480	1854-0221
A26A2Q2 †	1854-0404		TRANSISTOR NPN SI PD=360MW FT=200MHZ	28480	1854-0404
A26A2Q3 †	1853-0034		TRANSISTOR PNP SI PD=360MW FT=400MHZ	28480	1853-0034
A26A2Q4 †	1853-0034		TRANSISTOR PNP SI PD=360MW FT=400MHZ	28480	1853-0034
A26A2Q5 †	1854-0404		TRANSISTOR NPN SI PD=360MW FT=200MHZ	28480	1854-0404
A26A2Q6 †	1854-0404		TRANSISTOR NPN SI PD=360MW FT=200MHZ	28480	1854-0404
A26A2Q7 †	1854-0404		TRANSISTOR NPN SI PD=360MW FT=200MHZ	28480	1854-0404
A26A2Q8 †	1853-0034		TRANSISTOR PNP SI PD=360MW FT=400MHZ	28480	1853-0034
A26A2Q9 †	1853-0034		TRANSISTOR PNP SI PD=360MW FT=400MHZ	28480	1853-0034
A26A2R1	0757-0465	6	RESISTOR; FXD; 100K1% .125W F TUBULAR	24546	C4-1/8-T0-1003-F
A26A2R2	0757-0440		RESISTOR; FXD; 7.5K1% .125W F TUBULAR	24546	C4-1/8-T0-7501-F
A26A2R3	0757-0442		RESISTOR; FXD; 10K1% .125W F TUBULAR	24546	C4-1/8-T0-1002-F
A26A2R4	0757-0442		RESISTOR; FXD; 10K1% .125W F TUBULAR	24546	C4-1/8-T0-1002-F
A26A2R5	0698-3155		RESISTOR; FXD; 4.64K1% .125W F TUBULAR	16299	C4-1/8-T0-4641-F
A26A2R6	0757-0442		RESISTOR; FXD; 10K1% .125W F TUBULAR	24546	C4-1/8-T0-1002-F
A26A2R7	0757-0440		RESISTOR; FXD; 7.5K1% .125W F TUBULAR	24546	C4-1/8-T0-7501-F
A26A2R8	0757-0422	1	RESISTOR; FXD; 909 OHM1% .125W F	24546	C4-1/8-T0-909R-F
A26A2R9	0757-0421	3	RESISTOR; FXD; 825 OHM1% .125W F	24546	C4-1/8-T0-825R-F
A26A2R10	0757-0439		RESISTOR; FXD; 6.81K1% .125W F TUBULAR	24546	C4-1/8-T0-6811-F
A26A2R11	0757-0442		RESISTOR; FXD; 10K1% .125W F TUBULAR	24546	C4-1/8-T0-1002-F
A26A2R12	0757-0442		RESISTOR; FXD; 10K1% .125W F TUBULAR	24546	C4-1/8-T0-1002-F
A26A2R13	0757-0401		RESISTOR; FXD; 100 OHM1% .125W F	24546	C4-1/8-T0-101-F
A26A2R14	0757-0421		RESISTOR; FXD; 825 OHM1% .125W F	24546	C4-1/8-T0-825R-F
A26A2R15	0757-0438		RESISTOR; FXD; 5.11K1% .125W F TUBULAR	24546	C4-1/8-T0-5111-F
A26A2R16	0757-0280		RESISTOR; FXD; 1K1% .125W F TUBULAR	24546	C4-1/8-T0-1001-F
A26A2R17	0698-3440		RESISTOR; FXD; 196 OHM1% .125W F	16299	C4-1/8-T0-196R-F
A26A2R18	0757-0438		RESISTOR; FXD; 5.11K1% .125W F TUBULAR	24546	C4-1/8-T0-5111-F
A26A2R19	2100-2413	1	RESISTOR, VAR, TRMR, 200 OHM 10% C	19701	ET50X201
A26A2R20	0698-3157		RESISTOR; FXD; 19.6K1% .125W F TUBULAR	16299	C4-1/8-T0-1962-F
A26A2R21	0757-0416		RESISTOR; FXD; 511 OHM1% .125W F	24546	C4-1/8-T0-511R-F
A26A2R22	0757-0394		RESISTOR; FXD; 51.1 OHM1% .125W F	24546	C4-1/8-T0-51R1-F
A26A2R23	0698-3162		RESISTOR; FXD; 46.4K1% .125W F TUBULAR	16299	C4-1/8-T0-4642-F
A26A2R24	0757-0438		RESISTOR; FXD; 5.11K1% .125W F TUBULAR	24546	C4-1/8-T0-5111-F
A26A2R25	0698-3162		RESISTOR; FXD; 46.4K1% .125W F TUBULAR	16299	C4-1/8-T0-4642-F
A26A2R26	0757-0438		RESISTOR; FXD; 5.11K1% .125W F TUBULAR	24546	C4-1/8-T0-5111-F
A26A2R27	0698-0085		RESISTOR; FXD; 2.61K1% .125W F TUBULAR	16299	C4-1/8-T0-2611-F
A26A2R28	0698-3162		RESISTOR; FXD; 46.4K1% .125W F TUBULAR	16299	C4-1/8-T0-4642-F
A26A2R29	0698-3150		RESISTOR; FXD; 2.37K1% .125W F TUBULAR	16299	C4-1/8-T0-2371-F
A26A2R30	0757-0438		RESISTOR; FXD; 5.11K1% .125W F TUBULAR	24546	C4-1/8-T0-5111-F
A26A2R31	0698-3154		RESISTOR; FXD; 4.22K1% .125W F TUBULAR	16299	C4-1/8-T0-4221-F
A26A2R32	0757-0438		RESISTOR; FXD; 5.11K1% .125W F TUBULAR	24546	C4-1/8-T0-5111-F
A26A2R33	0698-3450		RESISTOR; FXD; 42.2K1% .125W F TUBULAR	16299	C4-1/8-T0-4222-F
A26A2R34	0757-0289		RESISTOR; FXD; 13.3K1% .125W F TUBULAR	30983	MF4C1/8-T0-1332-F
A26A2R35	0698-0082		RESISTOR; FXD; 464 OHM1% .125W F	16299	C4-1/8-T0-4640-F
A26A2R36	0698-0083		RESISTOR; FXD; 1.96K1% .125W F TUBULAR	16299	C4-1/8-T0-1961-F
A26A2R37	0757-0442		RESISTOR; FXD; 10K1% .125W F TUBULAR	24546	C4-1/8-T0-1002-F
A26A2R38	0757-0438		RESISTOR; FXD; 5.11K1% .125W F TUBULAR	24546	C4-1/8-T0-5111-F
A26A2R39	0698-0083		RESISTOR; FXD; 1.96K1% .125W F TUBULAR	16299	C4-1/8-T0-1961-F
A26A2TP1	0360-1514		TERMINAL, SLDR STUD	28480	0360-1514
A26A2TP2	0360-1514		TERMINAL, SLDR STUD	28480	0360-1514
A26A2TP3	0360-1514		TERMINAL, SLDR STUD	28480	0360-1514
A26A2TP4	0360-1514		TERMINAL, SLDR STUD	28480	0360-1514
A26A2TP5	0360-1514		TERMINAL, SLDR STUD	28480	0360-1514
A26A2TP6	0360-1514		TERMINAL, SLDR STUD	28480	0360-1514
A26A2TP7	0360-1514		TERMINAL, SLDR STUD	28480	0360-1514
A26A2TP8	0360-1514		TERMINAL, SLDR STUD	28480	0360-1514
A26A2U1 †	1826-0114	1	IC;DGTL;COMPARATOR (ANALOG)	07263	710HM
A26A2U2 †	1820-0448	1	IC;DGTL;GATE	01295	SN5400N
A26A2U3	1820-0579	1	IC;DGTL;MULTIVIBRATOR	01295	SN74123N
A26A2VR1	1902-3139	1	DIODE; ZENER; 8.25V VZ; .4W MAX PD	04713	SZ 10939-158

See introduction to this section for ordering information  
 † SEE TABLES 7-1 AND 7-2, FOR BACKDATING.

Table 6-3. Replaceable Parts

Reference Designation	HP Part Number	Qty	Description	Mfr Code	Mfr Part Number
A26A3	08640-60016	1	MODULATOR ASSY	28480	08640-60016
A26A3C1	0160-3094		CAPACITOR;FXD; .1UF+-10% 100WVDC	28480	0160-3094
A26A3C2	0160-3094		CAPACITOR;FXD; .1UF+-10% 100WVDC	28480	0160-3094
A26A3C3	0150-0048	4	CAPACITOR;FXD; .22PF+-5% 500WVDC	95121	TYPE QC
A26A3C4	0150-0048		CAPACITOR;FXD; .22PF+-5% 500WVDC	95121	TYPE QC
A26A3C5	0150-0048		CAPACITOR;FXD; .22PF+-5% 500WVDC	95121	TYPE QC
A26A3C6	0150-0048		CAPACITOR;FXD; .22PF+-5% 500WVDC	95121	TYPE QC
A26A3CR1	08640-60163	1	MATCHED DIODE SET(INCL A26A3CR2-8,NSR)	28480	08640-60163
A26A3CR2			PART OF A26A3CR1.NSR		
A26A3CR3			PART OF A26A3CR1.NSR		
A26A3CR4			PART OF A26A3CR1.NSR		
A26A3CR5			PART OF A26A3CR1.NSR		
A26A3CR6			PART OF A26A3CR1.NSR		
A26A3CR7			PART OF A26A3CR1.NSR		
A26A3CR8			PART OF A26A3CR1.NSR		
A26A3J1	1250-1425	1	CONNECTOR-COAX, SMC, 50 OHM MALE	28480	1250-1425
A26A3J2	1251-2194	1	CONNECTOR,1-CONT SKT .021 DIA	24995	3-331272-0
A26A3L1	9100-1620		COIL, FXD, MOLDED RF CHOKE, 15UH 10%	24226	15/152
A26A3L2	9140-0112	1	COIL, FXD, MOLDED RF CHOKE, 4.7UH 10%	24226	15/471
A26A3R1	0698-7229		RESISTOR; FXD; 511 OHM2% .05W F TUBULAR	24546	C3-1/8-T0-511R-G
A26A3R2	0698-3132		RESISTOR; FXD; 261 OHM1% .125W F	16299	C4-1/8-T0-2610-F
A26A3R3	0698-3132		RESISTOR; FXD; 261 OHM1% .125W F	16299	C4-1/8-T0-2610-F
A26A3R4	0757-0416		RESISTOR; FXD; 511 OHM1% .125W F	24546	C4-1/8-T0-511R-F
A26A3R5	0757-0416		RESISTOR; FXD; 511 OHM1% .125W F	24546	C4-1/8-T0-511R-F
A26A3T1	08640-80003	2	BALUN ASSY	28480	08640-80003
A26A3T2	08640-80003		BALUN ASSY	28480	08640-80003
A26A3XU2A-E	1251-2613		CONNECTOR,1-CONT SKT .033 DIA	24995	50864-3
A26A4	08640-60015	1	AGC AMPLIFIER ASSY	28480	08640-60015
A26A4	08640-60086		REBUILT 08640-60015, REQUIRES EXCHANGE	28480	08640-60086
A26A4C1	0180-0291		CAPACITOR-FXD, 1UF+-10% 35VDC TA-SOLID	56289	150D105X9035A2
A26A4C2	0180-0291		CAPACITOR-FXD, 1UF+-10% 35VDC TA-SOLID	56289	150D105X9035A2
A26A4C3	0180-0291		CAPACITOR-FXD, 1UF+-10% 35VDC TA-SOLID	56289	150D105X9035A2
A26A4C4	0160-2307		CAPACITOR;FXD; 47PF+-5% 300WVDC	28480	0160-2307
A26A4C5	0160-2307		CAPACITOR;FXD; 47PF+-5% 300WVDC	28480	0160-2307
A26A4C6	0160-3458	1	CAPACITOR;FXD, .005UF+-10% 250WVDC	28480	0160-3458
A26A4C7	0180-0291		CAPACITOR-FXD, 1UF+-10% 35VDC TA-SOLID	56289	150D105X9035A2
A26A4C8	0180-0197		CAPACITOR-FXD, 2.2UF+-10% 20VDC TA	56289	150D225X9020A2
A26A4C9	0160-0161		CAPACITOR;FXD; .01UF+-10% 200WVDC	56289	292P10392
A26A4C10†	0160-0302	1	CAPACITOR;FXD; .018UF+-10% 200WVDC	56289	292P18392
A26A4C11	0160-0159	1	CAPACITOR;FXD; .0068UF+-10% 200WVDC	56289	292P68292
A26A4C12	0140-0191		CAPACITOR;FXD; 56PF+-5% 300WVDC	72136	DM15E560J0300WVICR
A26A4C13	0180-0291		CAPACITOR-FXD, 1UF+-10% 35VDC TA-SOLID	56289	150D105X9035A2
A26A4C14†	0160-0576	1	CAPACITOR;FXD; .1UF+-20% 50WVDC	28480	0160-0576
A26A4C15	0160-0297	1	CAPACITOR;FXD; .0012UF+-10% 200WVDC	56289	292P12292
A26A4C16	0160-3534		CAPACITOR;FXD; 510PF+-5% 100WVDC	28480	0160-3534
A26A4C17	0160-3459	1	CAPACITOR,FXD, .02UF+-20% 100WVDC	28480	0160-3459
A26A4CR1	1901-0040		DIODE; SWITCHING;SI 30V MAX VRM 50MA	28480	1901-0040
A26A4CR2	1901-0040		DIODE; SWITCHING;SI 30V MAX VRM 50MA	28480	1901-0040
A26A4CR3	1901-0040		DIODE; SWITCHING;SI 30V MAX VRM 50MA	28480	1901-0040
A26A4CR4	1901-0040		DIODE; SWITCHING;SI 30V MAX VRM 50MA	28480	1901-0040
A26A4CR5	1901-0022		DIODE; STABISTOR;SI 10V MAX VRM 250MA	28480	1901-0022
A26A4CR6	1901-0022		DIODE; STABISTOR;SI 10V MAX VRM 250MA	28480	1901-0022
A26A4CR7	1910-0016	3	DIODE; SWITCHING;GE 60V MAX VRM 60MA	28480	1910-0016
A26A4CR8	1910-0016		DIODE; SWITCHING;GE 60V MAX VRM 60MA	28480	1910-0016
A26A4CR9	1910-0016		DIODE; SWITCHING;GE 60V MAX VRM 60MA	28480	1910-0016
A26A4CR10	1901-0022		DIODE; STABISTOR;SI 10V MAX VRM 250MA	28480	1901-0022
A26A4CR11	1901-0040		DIODE; SWITCHING;SI 30V MAX VRM 50MA	28480	1901-0040
A26A4CR12	1901-0022		DIODE; STABISTOR;SI 10V MAX VRM 250MA	28480	1901-0022
A26A4CR13	1901-0539		DIODE; SCHOTTKY HOT CARRIER	28480	1901-0539
A26A4CR14	1901-0518	1	DIODE; SCHOTTKY HOT CARRIER	28480	1901-0518
A26A4CR15	1901-0040		DIODE; SWITCHING; SI 30V MAX VRM 50MA	28480	1901-0040
A26A4K1	0490-1080		RELAY, REED, 1C .25A 150V CONT, 5V COIL	32255	SX30-014
A26A4L1	9100-1641		COIL; FXD; MOLDED RF CHOKE; 240UH 5%	24226	15/243
A26A4L2	9100-1641		COIL; FXD; MOLDED RF CHOKE; 240UH 5%	24226	15/243
A26A4MP1	4040-0749		EXTRACTOR;PC BOARD, BROWN	28480	4040-0749
	1480-0073		PIN;DRIVE 0.250" LG	00000	08D

See introduction to this section for ordering information  
 † SEE TABLES 7-1 AND 7-2, FOR BACKDATING.



Table 6-3. Replaceable Parts

Reference Designation	HP Part Number	Qty	Description	Mfr Code	Mfr Part Number
A26A4MP2	4040-0753 1480-0073		EXTRACTOR:PC BOARD, GREEN PIN:DRIVE 0.250" LG	28480 09090	4040-0753 0BD
A26A4Q1	1854-0221		TRANSISTOR, BIPOL, SI, NPN DUAL	28480	1854-0221
A26A4Q2	1854-0071		TRANSISTOR NPN SI PD=300MW FT=200MHZ	28480	1854-0071
A26A4Q3	1853-0007		TRANSISTOR PNP 2N3251 SI PD=360MW	04713	2N3251
A26A4Q4	1854-0221		TRANSISTOR, BIPOL, SI, NPN DUAL	28480	1854-0221
A26A4Q5	1853-0034		TRANSISTOR PNP SI PD=360MW FT=400MHZ	28480	1853-0034
A26A4Q6	1854-0071		TRANSISTOR NPN SI PD=300MW FT=200MHZ	28480	1854-0071
A26A4Q7	1853-0034		TRANSISTOR PNP SI PD=360MW FT=400MHZ	28480	1853-0034
A26A4Q8	1854-0071		TRANSISTOR NPN SI PD=300MW FT=200MHZ	28480	1854-0071
A26A4Q9	1854-0071		TRANSISTOR NPN SI PD=300MW FT=200MHZ	28480	1854-0071
A26A4R1	2100-2521		RESISTOR, VAR, TRMR, 2KOHM 10% C	19701	ET50X202
A26A4R2	2100-2521		RESISTOR, VAR, TRMR, 2KOHM 10% C	19701	ET50X202
A26A4R3	0757-0401		RESISTOR; FXD; 100 OHM1% .125W F	24546	C4-1/8-T0-101-F
A26A4R4	0757-0290		RESISTOR; FXD; 6.19K1% .125W F TUBULAR	30983	MF4C1/8-T0-6191-F
A26A4R5	0757-0280		RESISTOR; FXD; 1K1% .125W F TUBULAR	24546	C4-1/8-T0-1001-F
A26A4R6	0757-0440		RESISTOR; FXD; 7.5K1% .125W F TUBULAR	24546	C4-1/8-T0-7501-F
A26A4R7	0698-3154		RESISTOR; FXD; 4.22K1% .125W F TUBULAR	16299	C4-1/8-T0-4221-F
A26A4R8	0757-0440		RESISTOR; FXD; 7.5K1% .125W F TUBULAR	24546	C4-1/8-T0-7501-F
A26A4R9	0757-0465		RESISTOR; FXD; 100K1% .125W F TUBULAR	24546	C4-1/8-T0-1003-F
A26A4R10	0757-0442		RESISTOR; FXD; 10K1% .125W F TUBULAR	24546	C4-1/8-T0-1002-F
A26A4R11	0757-0442		RESISTOR; FXD; 10K1% .125W F TUBULAR	24546	C4-1/8-T0-1002-F
A26A4R12	2100-2514		RESISTOR, VAR, TRMR, 20KOHM 10% C	19701	ET50X203
A26A4R13†	0698-3156		RESISTOR; FXD; 14.7K1% .125W F TUBULAR	16299	C4-1/8-T0-1472-F
A26A4R14	0757-0442		RESISTOR; FXD; 10K1% .125W F TUBULAR	24546	C4-1/8-T0-1002-F
A26A4R15†	0698-3156		RESISTOR; FXD; 14.7K1% .125W F TUBULAR	16299	C4-1/8-T0-1472-F
A26A4R16	0757-0438		RESISTOR; FXD; 5.11K1% .125W F TUBULAR	24546	C4-1/8-T0-5111-F
A26A4R17	0698-3453		RESISTOR; FXD; 196K1% .125W F TUBULAR	16299	C4-1/8-T0-1963-F
A26A4R18	0698-3153		RESISTOR; FXD; 3.83K1% .125W F TUBULAR	16299	C4-1/8-T0-3831-F
A26A4R19	0757-0464	1	RESISTOR; FXD; 90.9K1% .125W F TUBULAR	24546	C4-1/8-T0-9092-F
A26A4R20	0757-0438		RESISTOR; FXD; 5.11K1% .125W F TUBULAR	24546	C4-1/8-T0-5111-F
A26A4R21	0757-0438		RESISTOR; FXD; 5.11K1% .125W F TUBULAR	24546	C4-1/8-T0-5111-F
A26A4R22†	0757-0278		RESISTOR; FXD; 1.78K1% .125W F TUBULAR	24546	C4-1/8-T0-1781-F
A26A4R23	0757-0290		RESISTOR; FXD; 6.19K1% .125W F TUBULAR	30983	MF4C1/8-T0-6191-F
A26A4R24	0698-0083		RESISTOR; FXD; 1.96K1% .125W F TUBULAR	16299	C4-1/8-T0-1961-F
A26A4R25	0757-0458		RESISTOR; FXD; 51.1K1% .125W F TUBULAR	24546	C4-1/8-T0-5112-F
A26A4R26	0757-0438		RESISTOR; FXD; 5.11K1% .125W F TUBULAR	24546	C4-1/8-T0-5111-F
A26A4R27	0757-0458		RESISTOR; FXD; 51.1K1% .125W F TUBULAR	24546	C4-1/8-T0-5112-F
A26A4R28	0757-0438		RESISTOR; FXD; 5.11K1% .125W F TUBULAR	24546	C4-1/8-T0-5111-F
A26A4R29	0757-0442		RESISTOR; FXD; 10K1% .125W F TUBULAR	24546	C4-1/8-T0-1002-F
A26A4R30	0757-0441		RESISTOR; FXD; 8.25K1% .125W F TUBULAR	24546	C4-1/8-T0-8251-F
A26A4R31	0757-0317		RESISTOR; FXD; 1.33K1% .125W F TUBULAR	24546	C4-1/8-T0-1331-F
A26A4R32	0757-0442		RESISTOR; FXD; 10K1% .125W F TUBULAR	24546	C4-1/8-T0-1002-F
A26A4R33	0757-0438		RESISTOR; FXD; 5.11K1% .125W F TUBULAR	24546	C4-1/8-T0-5111-F
A26A4R34	0757-0465		RESISTOR; FXD; 100K1% .125W F TUBULAR	24546	C4-1/8-T0-1003-F
A26A4R35	0757-0465		RESISTOR; FXD; 100K1% .125W F TUBULAR	24546	C4-1/8-T0-1003-F
A26A4R36	0698-0083		RESISTOR; FXD; 1.96K1% .125W F TUBULAR	16299	C4-1/8-T0-1961-F
A26A4R37	0757-0394		RESISTOR; FXD; 51.1 OHM1% .125W F	24546	C4-1/8-T0-511R1-F
A26A4R38	0698-3153		RESISTOR; FXD; 3.83K1% .125W F TUBULAR	16299	C4-1/8-T0-3831-F
A26A4R39	0757-0280		RESISTOR; FXD; 1K1% .125W F TUBULAR	24546	C4-1/8-T0-1001-F
A26A4R40	0698-3437		RESISTOR; FXD; 133 OHM1% .125W F	16299	C4-1/8-T0-133R-F
A26A4R41†	0757-0465		RESISTOR; FXD; 100K1% .125W F TUBULAR	24546	C4-1/8-T0-1003-F
A26A4R42	0757-0465		RESISTOR; FXD; 190K1% .125W F TUBULAR	24546	C4-1/8-T0-1003-F
A26A4R43	0698-0083		RESISTOR; FXD; 1.96K1% .125W F TUBULAR	16299	C4-1/8-T0-1961-F
A26A4R44	0698-3450		RESISTOR; FXD; 42.2K1% .125W F TUBULAR	16299	C4-1/8-T0-4222-F
A26A4R45	0757-0442		RESISTOR; FXD; 10K1% .125W F TUBULAR	24546	C4-1/8-T0-1002-F
A26A4R46	0698-3154		RESISTOR; FXD; 4.22K1% .125W F TUBULAR	16299	C4-1/8-T0-4221-F
A26A4R47	0757-0401		RESISTOR; FXD; 100 OHM1% .125W F	24546	C4-1/8-T0-101-F
A26A4R48	0757-0289		RESISTOR; FXD; 13.3K1% .125W F TUBULAR	30983	MF4C1/8-T0-1332-F
A26A4R49	0698-3150		RESISTOR; FXD; 2.37K1% .125W F TUBULAR	16299	C4-1/8-T0-2371-F
A26A4R50	0698-3451		RESISTOR; FXD; 133K1% .125W F TUBULAR	16299	C4-1/8-T0-1333-F
A26A4R51			NOT ASSIGNED		
A26A4R52	0757-0280		RESISTOR; FXD; 1K1% .125W F TUBULAR	24546	C4-1/8-T0-1001-F
A26A4R53	0757-0278		RESISTOR; FXD; 1.78K1% .125W F TUBULAR	24546	C4-1/8-T0-1781-F
A26A4R54†	0757-0421	1	RESISTOR; FXD; 825 OHM1% .125W F	24546	C4-1/8-T0-825R-F
A26A4S1	3101-0973		SWITCH, SL, DPDT NS, .5A 125VAC/DC	28480	3101-0973
A26A4TP1	0360-1514		TERMINAL, SLDR STUD	28480	0360-1514
A26A4TP2	0360-1514		TERMINAL, SLDR STUD	28480	0360-1514
A26A4TP3	0360-1514		TERMINAL, SLDR STUD	28480	0360-1514
A26A4TP4	0360-1514		TERMINAL, SLDR STUD	28480	0360-1514
A26A4TP5	0360-1514		TERMINAL, SLDR STUD	28480	0360-1514
A26A4TP6	0360-1514		TERMINAL, SLDR STUD	28480	0360-1514
A26A4TP7	0360-1514		TERMINAL, SLDR STUD	28480	0360-1514
A26A4TP8	0360-1514		TERMINAL, SLDR STUD	28480	0360-1514

See introduction to this section for ordering information  
 † SEE TABLES 7-1 AND 7-2, FOR BACKDATING.

Table 6-3. Replaceable Parts

Reference Designation	HP Part Number	Qty	Description	Mfr Code	Mfr Part Number
A26A4U1	1826-0092	1	IC;LIN;OPERATIONAL AMPLIFIER	02735	CA3458T
A26A4U2	1826-0026	1	INTEGRATED CIRCUIT, DGTL, VOLTAGE	27014	LM311H
A26A4U3	1820-0328	1	IC;DGTL;GATE	01295	SN7402N
A26A4U4	1820-0471	1	IC;DGTL;INVERTER	01295	SN7406N
A26A4VR1	1902-0025	1	DIODE; ZENER; 10V VZ; .4W MAX PD	04713	SZ 10939-182
A26A4VR2	1902-3203	1	DIODE; ZENER; 14.7V VZ; .4W MAX PD	04713	SZ 10939-230
A26A5	08640-60009	1	RISER ASSY	28480	08640-60009
A26A5XA26A6	1251-3231	1	CONNECTOR, PC EDGE, 15-CONT, WIRE WRAP	28480	1251-3231
A26A6	08640-60011	1	AM MOTHER BOARD ASSY	28480	08640-60011
A26A6XA26A2	1251-1886	1	CONNECTOR, PC EDGE, 15-CONT, DIP SOLDER	71785	252-15-30-340

See introduction to this section for ordering information

Table 6-3. Replaceable Parts

Reference Designation	HP Part Number	Qty	Description	Mfr Code	Mfr Part Number
C1	0180-2530	2	CAPACITOR-FXD; 3900UF+75-10% 50VDC AL	56289	3603926050AC2B
C2	0180-2530		CAPACITOR-FXD; 3900UF+75-10% 50VDC AL	56289	3603926050AC2B
C3	0180-2334	1	CAPACITOR-FXD; 3900UF+75-10% 75VDC AL	56289	360392F075BB2B
C4	0180-2277	2	CAPACITOR-FXD; 8200UF+75-10% 25VDC AL	56289	3608226025AC2A
C5	0180-2277		CAPACITOR-FXD; 8200UF+75-10% 25VDC AL	56289	3608226025AC2A
C6 †	0160-4048	1	CAPACITOR-FXD; .022UF+-20% 250WVDC	28480	0160-4048
DS1	2140-0244	1	LAMP, GLOW, BULB T-2, 105V	87034	A1H
F1	2110-0002	1	FUSE, 2A 250V	71400	AGC-2
F1	2110-0001	1	(FOR 100/120V OPERATION) FUSE, 1A 250V (FOR 220/240V OPERATION)	71400	AGC-1
M1 †	1120-0539	1	METER	28480	1120-0539
	0360-0053	2	TERMINAL, SLDR LUG, 10 SCR, .204/.094	78189	2101-10-00
MP1	0340-0486	1	INSULATOR COVER, TO- 3, .33 THK	28480	0340-0486
MP2	0370-2376	1	KNOB:BAR, SKIRTED 0.250" DIA SHAFT FREQUENCY RANGE	28480	0370-2376
MP3	0370-2378	1	KNOB:RND, CONCENTRIC 0.125" DIA SHAFT FM	28480	0370-2378
MP4	0370-2379	1	KNOB:RND, CONCENTRIC 0.125" DIA SHAFT AM	28480	0370-2379
MP5	0370-2380	1	KNOB:BAR BASE 0.250" DIA SHAFT PEAK DEVIATION RANGE	28480	0370-2380
MP6 †	0370-2381	1	KNOB; BASE-CONC SKT; .5 IN; JGK (OPTION 001) AUD OUT 3V	28480	0370-2381
MP7	0370-2382	1	KNOB:RND, SKIRTED 0.250" DIA SHAFT (STANDARD) MOD FREQ.	28480	0370-2382
MP8	0370-2383	1	KNOB, BASE, PTR, .375 IN, JGK, MGP FINE TUNE	28480	0370-2383
MP9 †	0370-2387	1	KNOB; BASE-CONC SKT; .5 IN; JGK (STANDARD) AUD OUT 1V	28480	0370-2387
MP10	0370-2445	1	KNOB, BASE, RND, .5 IN, JGK, MGP DECAL OUTPUT LEVEL VERNIER	28480	0370-2445
MP11	0370-2446	1	KNOB, CONC, RND, .5 IN, JGK, MGP DECAL (OPTION 001) MOD FREQ. VERNIER	28480	0370-2446
MP12	0403-0026		GLIDE:NYLON	28480	0403-0026
MP13	0590-1011	3	NUT; KNRLD R 15/32-32 .12 X .61; BRS;	28480	0590-1011
MP14	1400-0825	1	INSULATOR, MISC, CLIP PANEL, .201 ID	28480	1400-0825
MP15	1540-0034	1	CONTAINER-CS, PLSTC, W/HINGED LID	28307	1CAK
MP16	4040-0976	1	CLAMP:CAP	00000	0BD
MP17	3150-0203	1	FILTER, EXPANDED ALUMINUM	28480	3150-0203
MP18	5001-0135	1	WRENCH:COMBINATION	28480	5001-0135
MP19	5060-0109		CONNECTOR:15 CONTACTS	28480	5060-0109
MP20 †	08640-00063	1	PANEL:FRONT	28480	08640-00063
MP21	08640-00021	1	SHIELD:FM AMPLIFIER	28480	08640-00021
MP22 †	08640-4044	1	SCREW:METER ZERO	28480	08640-4044
MP23	08640-00022	1	SUPPORT:PC BOARD	28480	08640-00022
MP24	08640-00030	1	SUPPORT:MODULE	28480	08640-00030
MP25	08640-00058		INSULATOR:COUNTER	28480	08640-00058
MP26	08640-00059	1	INSULATOR:CONNECTOR	28480	08640-00059
MP27	08640-20078	1	EXTRUSION:TOP	28480	08640-20078
MP28	08640-20079	1	EXTRUSION:BOTTOM	28480	08640-20079
MP29	08640-20085	1	COUPLER:SHAFT	28480	08640-20085
MP30	08640-20204		FRONT CASTING:5H FM	28480	08640-20204
MP31	08640-40016	1	CLAMP:METER	28480	08640-40016
MP32	08640-40026	1	KNOB/DIAL ASSY:OUTPUT LEVEL	28480	08640-40026
MP33	08640-40046	3	LENS:DIFFUSING	28480	08640-40046
MP34	08640-40047	1	KNOB/DIAL ASSY (OPTION 001) MOD FREQ. RANGE	28480	08640-40047
MP35	08640-40049	1	WINDOW:FRONT	28480	08640-40049
MP36	08640-40051	1	DIAL AND GEAR ASSY (OPTION 001) MOD FREQ. VERNIER SKIRT	28480	08640-40051
MP37	08640-40055	1	KNOB AND SKIRT:FREQUENCY TUNE	28480	08640-40055
MP38	08640-40056	1	SKIRT: OUTPUT LEVEL CURSOR	28480	08640-40056
MP39	08640-60036	1	BOARD ASSY:EXTENDER	28480	08640-60036
MP40	5040-0388	1	BUTTON:X10%	28480	5040-0388
MP41	5040-0389	1	BUTTON:K/MHZ	28480	5040-0389
MP42	5040-0390	1	BUTTON:VOLTS	28480	5040-0390
MP43	3030-0007		SCREW;SET; 4-40 UNC-3A .125 IN (FRONT PANEL KNOBS)	28480	3030-0007
MP44	0624-0267	8	SCREW:TAPPING; 6-20 ASA TYPE B .625 IN	28480	0624-0267
MP45	0626-0002	2	SCREW:TAPPING; 6-20 ASA TYPE AB .5 IN	28480	0626-0002
MP46	1200-0043	5	INSULATOR, XSTR, TO- 3, .02 THK	76530	322047
MP47	3160-0217	1	FAN-BLADE, AXL, 3 OD .079D	28480	3160-0217
MP48	5040-0170	2	GUIDE:PLUG-IN PC BOARD	28480	5040-0170
MP49	3030-0007		SCREW;SET; 4-40 UNC-3A .125 IN	28480	3030-0007

See introduction to this section for ordering information  
† SEE TABLES 7-1 AND 7-2, FOR BACKDATING.

Table 6-3. Replaceable Parts

Reference Designation	HP Part Number	Qty	Description	Mfr Code	Mfr Part Number
MP50	5040-0447	2	FOOT:REAR(LONG)	28480	5040-0447
MP51	08620-00019	2	BRACKET:FAN	28480	08620-00019
MP52	08620-20016	1	HEAT SINK:TRANSISTOR	28480	08620-20016
MP53	08640-00014	1	DECK:TRANSFORMER	28480	08640-00014
MP54	08640-00015	1	DECK:MAIN	28480	08640-00015
MP55 †	08640-00065	1	SHIELD:ATTENUATOR	28480	08640-00065
MP56 †	0400-0005	1	GROMMET:RUBBER FOR 0.562" DIA HOLE	73734	#1660
MP57 †	0403-0026	1	GLIDE:NYLON	28480	0403-0026
MP58	8160-0238	1	GASKET MATL;RFI; RING MONEL (MAIN TUNE)	28480	8160-0238
MP59 †	8160-0239	1	GASKET MATL;RFI; RING MONEL (FINE TUNE)	28480	8160-0239
MP60	08640-20228	1	COLLAR:RETAINING (FINE TUNE SHAFT)	28480	08640-20228
MP61	08640-40052	1	LEVER SLIDE SWITCH	28480	08640-40052
P1	1251-3294	1	CONNECTOR, PC EDGE, 10-CONT, SOLDER EYE	05574	3VH10/1JN12
P2	1251-0198	1	CONNECTOR, PC EDGE, 6-CONT, SOLDER EYE	71785	251-06-30-261
	5040-0327	1	HOOD:CONNECTOR	28480	5040-0327
P3	1251-1249	1	CONNECTOR-POLARIZING KEY, FOR SER	13511	143-953
	1251-1313	1	CONTACT, CONN, U/W MICRO SER, FEM	13511	220-502
	1251-3054	1	CONNECTOR STRIP:9 OPEN POSITION	74868	221-68
Q1	1854-0063	4	TRANSISTOR NPN 2N3055 SI PD=115W	28480	1854-0063
Q2	1854-0063	1	TRANSISTOR NPN 2N3055 SI PD=115W	28480	1854-0063
Q3	1854-0250	1	TRANSISTOR NPN SI PD=115W	28480	1854-0250
Q4	1854-0063	1	TRANSISTOR NPN 2N3055 SI PD=115W	28480	1854-0063
Q5	1854-0063	1	TRANSISTOR NPN 2N3055 SI PD=115W	28480	1854-0063
R1 †	2100-3344	1	R:VAR DUAL 2K/20K OHM 20/10% LIN (PART OF R1)	28480	2100-3344
R2	0698-3449	1	RESISTOR; FXD; 28.7K1% .125W F TUBULAR	16299	C4-1/8-T0-2872-F
R3 †	3101-1395	1	SWITCH; PB 1-STA RECT DPDT	87034	53-67280-121/A1H
S1	3101-0070	1	SWITCH, SL, DPDT NS, .5A 125VAC/DC	28480	3101-0070
S2	3101-0163	1	SWITCH, TGL, SPDT 5A/115VAC ON-NONE-ON	09353	7101
S3	08640-20057	1	INSULATOR:TRANSISTOR SCREW	28480	08640-20057
T1	8120-1378	1	CABLE, UNSHLD 3-COND 18AWG	70903	KH-7081
W1	8120-1886	1	CABLE:COAX ASSY(9.579)	94142	C-8120-1886-1
W2	8120-1890	1	CABLE:COAX ASSY(11.764)	94142	C-8120-1890-1
W3	08640-60127	1	CABLE ASSY:FM INPUT/OUTPUT	28480	08640-60127
W4	8120-1928	2	CABLE, SHLD 2-COND 24AWG	28480	8120-1928
W5	8120-1881	1	CABLE:COAX ASSY(2.737)	94142	B-8120-1881-1
W6	8120-1882	1	CABLE:COAX ASSY(.789)	94142	A-8120-1882-1
W7	8120-0580	1	CABLE:COAX ASSY(3.224)	94142	A-8120-0580-1
W8	8120-1928	1	CABLE, SHLD 2-COND 24AWG	28480	8120-1928
W9	8120-0581	1	CABLE:COAX ASSY(5.409)	94142	C-8120-0581-1
W10	8120-1885	1	CABLE:COAX ASSY(2.864)	94142	A-8120-1885-1
W11	08640-60128	1	CABLE ASSY:AM INPUT/OUTPUT	28480	08640-60128
W12	8120-1182	1	CABLE, SHLD 2-COND 24AWG	83501	DBD
W13	8120-1891	1	CABLE:COAX ASSY(12.104)	94142	A-8120-1891-1
W14	08640-60124	1	CABLE ASSY:EXTERNAL TIME BASE	28480	08640-60124
W15					

See introduction to this section for ordering information

† SEE TABLES 7-1 AND 7-2, FOR BACKDATING.

Table 6-3. Replaceable Parts

Reference Designation	HP Part Number	Qty	Description	Mfr Code	Mfr Part Number
FIGURE 6-1. CABINET PARTS					
1	08640-20075	2	FRAME ASSY:5 X 16	28480	08640-20075
2	08640-20204	3	FRONT CASTING:5H FM	28480	08640-20204
3	08640-00026	1	PANEL:REAR	28480	08640-00026
4	5000-8705	2	COVER, SIDE:PERFORATED	28480	5000-8705
5	5000-8707	2	COVER:FRONT SIDE	28480	5000-8707
6	08640-00003	1	COVER:TOP	28480	08640-00003
7	08640-00004	1	COVER:BOTTOM	28480	08640-00004
8	5060-0222	2	HANDLE ASSY:5H SIDE	28480	5060-0222
9	5060-8737	2	HANDLE:RETAINER	28480	5060-8737
10	5060-0767	5	FOOT ASSY:FM	28480	5060-0767
11	1490-0030	1	WIREFORM	28480	1490-0030
12	5000-0051	2	TRIM STRIP	28480	5000-0051
13	5060-8740	1	KIT:RACK MOUNT, 5H(MINT GRAY)	28480	5060-8740
14	5000-8711	1	COVER:FRONT SIDE PLATE(MINT GRAY)	28480	5000-8711

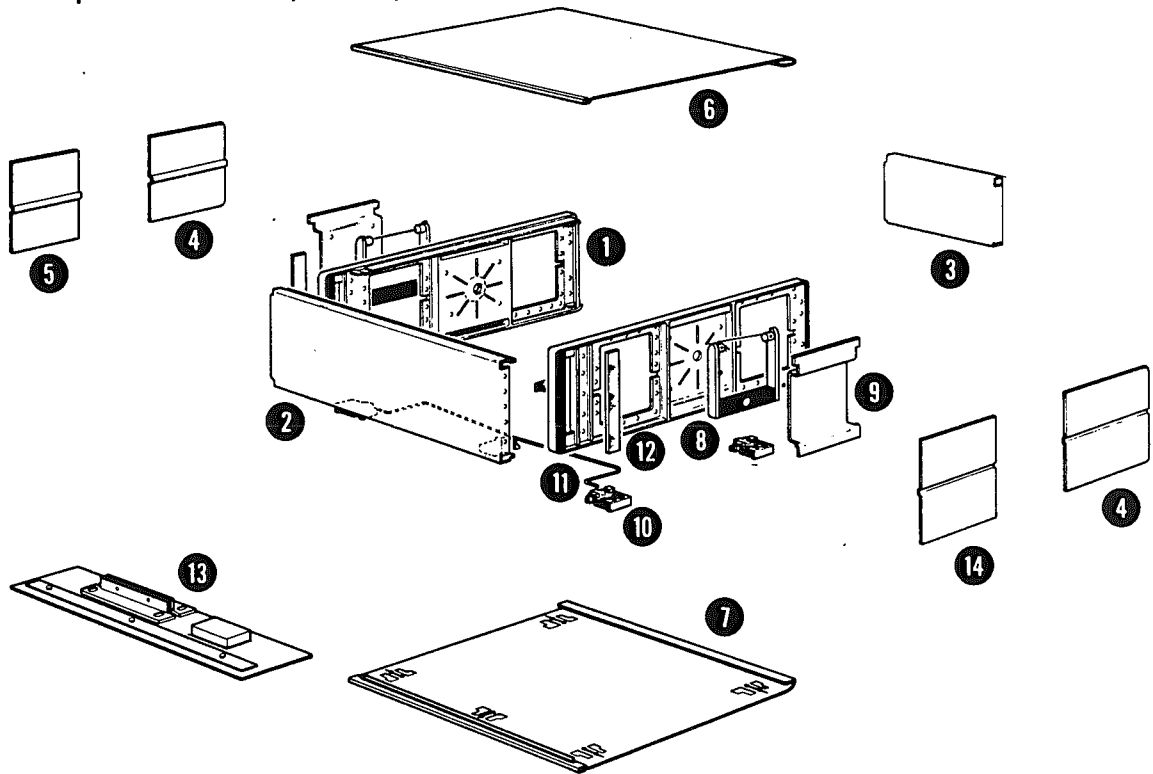

See introduction to this section for ordering information

Table 6-3. Replaceable Parts

Reference Designation	HP Part Number	Qty	Description	Mfr Code	Mfr Part Number
J1MP1	1250-0914	1	FIGURE 6-2. TYPE N CONNECTOR CONNECTOR-COAX, APC-N, 50 OHM FEMALE CONTACT: RF CONNECTOR WASHER: LOCK 0.439" ID NUT: HEX 7/16-28	28480	1250-0914
J1MP2	1250-0915	1		28480	1250-0915
J1MP3	2190-0104	1		00000	OBD
J1MP4	2950-0132	1		00000	OBD
J1MP5	5040-0306	1	INSULATOR	28480	5040-0306
J1MP6	08555-20093	2	CENTER CONDUCTOR	28480	08555-20093
J1MP7	08555-20094	1	BODY+BULKHEAD	28480	08555-20094
J1MP8	08761-2027	1	INSULATOR	28480	08761-2027

See introduction to this section for ordering information

Table 6-4. Code List of Manufacturers

MFR NO.	MANUFACTURER NAME	ADDRESS	ZIP CODE
00000	U.S.A.COMMON		
00014	U.I.D. ELECTRONICS CORP.	HOLLYWOOD, FL	33021
0004A	ARIZONA COIL INC	NOGALES AZ	85621
00287	C E M CO INC	DANIELSON CT	06239
01121	ALLEN BRADLEY CO	MILWAUKEE WI	53212
01295	TEXAS INSTR INC SEMICOND CMPNT DIV	DALLAS TX	75231
02735	RCA CORP SOLID STATE DIV	SOMMERVILLE NJ	08876
03888	PYROFILM CORP	WHIPPANY NJ	07981
04713	MOTOROLA SEMICONDUCTOR PRODUCTS	PHOENIX AZ	85008
05574	VIKING INDUSTRIES INC	CHATSWORTH CA	91311
07263	FAIRCHILD SEMICONDUCTOR DIV	MOUNTAIN VIEW CA	94040
09353	C AND K COMPONENTS INC	WATERTOWN MA	02172
12697	CLAROSTAT MFG CO INC	DOVER NH	03820
13511	CINCH MFG. CO.	SHELBYVILLE, IN.	46176
16299	CORNING GL WK ELEC CMPNT DIV	RALEIGH NC	27604
19701	MEPCO/ELECTRA CORP (MF RES)	MINERAL WELLS TX	76067
24226	GOWANDA ELECTRONICS CORP	GOWANDA NY	14070
24546	CORNING GLASS WORKS (C STYLE RES)	BRADFORD PA	16701
24931	SPECIALTY CONNECTOR CO INC	INDIANAPOLIS IN	46227
24995	ENVIRONMENTAL CNTNR SYS(CRATE-RITE)	PALO ALTO CA	94304
26365	GRIES REPRODUCER CORP	NEW ROCHELLE NY	10892
26742	METHODE ELECTRONICS INC	CHICAGO IL	60656
27014	NATIONAL SEMICONDUCTOR CORP	SANTA CLARA CA	95051
28307	BRADLEY INDUSTRIES INC	FRANKLIN PARK IL	60131
28480	HEWLETT-PACKARD CO CORPORATE HQ	PALO ALTO CA	94304
30983	MEPCO/ELECTRA CORP (VAR RES)	SAN DIEGO CA	92121
32255	DATRON SYSTEM INC	CHATSWORTH CA	91211
32997	BOURNS INC TRIMPOT PROD DIV	RIVERSIDE CA	92507
50443	HEWLETT-PACKARD COMPANY	SANTA CLARA, CA	95050
56289	SPRAGUE ELECTRIC CO	NORTH ADAMS MA	01247
70903	BELDEN CORP	CHICAGO IL	60644
71400	BUSSMAN MFG DIV OF MCGRAW-EDISON CO	ST LOUIS MO	63017
71744	CHICAGO MINIATURE LAMP WORKS	CHICAGO IL	60640
71785	TRW ELEK COMPONENTS CINCH DIV	ELK GROVE VILLAGE IL	60007
72136	ELECTRO.MOTIVE MFG CO INC	WILLIMANTIC CT	06226
73076	ITT HARPER INC	CHICAGO IL	60606
73734	FEDERAL SCREW PRODUCTS CO	CHICAGO IL	60618
73899	J F D ELECTRONICS CORP	BROOKLYN NY	11219
74868	BUNKER-RAMO CORP, AMPHENOL CADRE DIV	ENDICOTT, N.Y.	13760
75042	TRW INC PHILADELPHIA DIV	PHILADELPHIA PA	19108
76530	TRW ELEK CMPNT CINCH-MONADNOCK DIV	CITY OF INDUSTRY CA	91747
76854	DAK IND INC SM DIV	CRYSTAL LAKE IL	60014
78189	ILLINOIS TOOL WORKS INC SHAKEPROOF	ELGIN IL	60126
79136	WALDES-KOHINOOR INC	LONG ISLAND CITY NY	11101
80120	SCHNITZER ALLOY PRODUCTS CO	ELIZABETH NJ	07206
80486	ALL STAR PROD INC	DEFIANCE OH	43512
83330	SMITH HERMAN H INC	BROOKLYN NY	11207
83501	GAVITT WIRE & CABLE	BROOKFIELD MA	01506
84411	TRW CAPACITOR DIV	OGALLALA NE	69153
86928	SEASTROM MFG CO	GLENDALE CA	91201
87034	MARCO-DAK DIV DAK IND INC	ANAHEIM CA	92803
91637	DALE ELECTRONICS INC	COLUMBUS NE	68601
94142	PHHELPS-DODGE CORP.	NEW YORK, N.Y.	10022
95121	QUALITY COMPONENTS INC	ST MARYS PA	15857
95987	WECKESSER CO INC	CHICAGO IL	60641
98291	SEAELECTRO CORP	MAMARONECK NY	10544

See introduction to this section for ordering information

## SECTION VII MANUAL CHANGES

### 7-1. INTRODUCTION

7-2. This section contains manual change instructions for backdating this manual for HP Model 8640B Signal Generators that have serial number prefixes that are lower than the prefix listed on the title page. This section also contains instrument modification suggestions and procedures that are recommended to improve the performance and reliability of your generator.

### 7-3. MANUAL CHANGES

7-4. To adapt this manual to your instrument, refer to Table 7-1 and make all of the manual

changes listed opposite your instrument's serial number or prefix. The manual changes are listed in serial number sequence and should be made in the sequence listed. For example, Change A should be made after Change B; Change B should be made after Change C; etc. Table 7-2 is a summary of changes by component.

7-5. If your instrument's serial number or prefix is not listed on the title page of this manual or in Table 7-1, it may be documented in a yellow MANUAL CHANGES supplement. For additional important information about serial number coverage, refer to INSTRUMENTS COVERED BY MANUAL in Section I.

*Table 7-1. Manual Changes By Serial Number*

Serial Prefix or Number	Make Manual Changes	Serial Prefix or Number	Make Manual Changes
1229A00120 and below	N, M, L, K, J, I, H, G, F, E, D, C, B, A	1303A	N, M, L, K, J, I, H
1229A00121 to 00140	N, M, L, K, J, I, H, G, F, E, D, C, B	1310A	N, M, L, K, J, I
1244A	N, M, L, K, J, I, H, G, F, E, D, C	1313A	N, M, L, K, J
1245A	N, M, L, K, J, I, H, G, F, E, D	1316A00385 to 00464	N, M, L, K
1246A	N, M, L, K, J, I, H, G, F, E	1316A00465 and above	N, M, L
1249A	N, M, L, K, J, I, H, G, F	1322A	N, M
1251A	N, M, L, K, J, I, H, G	1323A	N



Table 7-2. Summary of Changes by Component (1 of 2)

Change	A1	A2	A3	A4	A5	A6	A7	A8	A9	A10
A					Insulators for Q5-9 and Q11		Insulators for Q3 and Q6			
B		VR3*,4*						A2C11,12, 19,27* A2L1* A2R46*, 56,57* A4R4*		
C			MP15,16 R2 A4(entire sub-assy)							
D										
E			A4R2				J1* A7 Assy Part No.	L1-3 A1(entire sub-assy)	C6-8* W1*	A10A1MP10, 12*
F							A1C7*			
G			C9*					A2C12* A2L2* A2R48*		
H										
I										
J								A1 Part No. A1C7, CR1-6, MP2-4 A1Q3,R1-3 A2C27-30		
K									A2C5*	
L										
M							R13,21-28, 37,40, 45-54, 57-65			
N								A4R3*, 5 A4XDS1A, B		A2R6-8, 12-14, 18-20

\*Instrument modification recommended, see paragraph 7-7.

Table 7-2. Summary of Changes by Component (2 of 2)

Change	A11	A12	A13	A14	A17	A18	A20	A22	A26	No Prefix
A	Insulators for Q1, Q2, Q4, and Q5 (STD) and Q3 and Q6 (Opt. 001)					Insulators for Q2, Q5, Q7, Q10, and Q12	Insulators for Q2-4	Insulators for Q2 and Q3		
B	R7*, 14* (STD) R36*, 39* (Opt. 001)								A1Q1*	R4,5
C										
D			R1						A1R16,17 A4C10* A4R54*	MP59* MP60*
E									A2Q2-9 A2U1,2	MP56 MP57
F		CR5-8 CR13-16 R4, R6								
G										M1* MP20*,22*
H									A2CR9* A4R13*,15* 22*,41*,42*	
I									A4C14*	
J						R19*	R27*	R26*,27*		
K										
L										R1* MP6*,9*
M	R34, 35									
N										C6

\*Instrument modification recommended, see paragraph 7-7.

---

**MANUAL CHANGES**

---

**7-6. MANUAL CHANGE INSTRUCTIONS****CHANGE A**

Pages 6-7 and 6-8, Table 6-3:

Delete 1200-0173, INSULATOR, XSTR from A5Q5-9 and Q11.

Page 6-9, Table 6-3:

Delete 1200-0173, INSULATOR, XSTR from A7Q3 and Q6.

Page 6-23, Table 6-3:

Delete 1200-0173, INSULATOR, XSTR from A11Q1, Q2, Q4, and Q5.

Page 6-24, Table 6-3:

Delete 1200-0173, INSULATOR, XSTR from A11Q3 and Q6.

Pages 6-28 and 6-19, Table 6-3:

Delete 1200-0173, INSULATOR, XSTR from A18Q2, Q5, Q7, Q10, Q12 and A20Q2-4.

Page 6-31, Table 6-3:

Delete 1200-0173, INSULATOR, XSTR from A22Q2 and Q3.

**CHANGE B****NOTE**

See paragraphs 7-9 through 7-19 for recommended instrument modifications.

Page 5-11, paragraph 5-40:

Change third sentence to read, "... for  $750 \pm 10$  mVrms at A11TP5  
740 \_\_\_\_\_ 760 mVrms."

Pages 6-12 through 6-14, Table 6-3:

Change A8A2C11 and C12 to 0160-3466; CAPACITOR; FXD; 100 PF  $\pm 10\%$ .

Change A8A2C19 to 0140-0193; CAPACITOR; FXD; 82 PF  $\pm 5\%$ .

Delete A8A2C27.

Delete A8A2L1.

Add A8A2R46 0757-0416; RESISTOR; FXD; 511 OHM 1% .05W.

Change A8A2R56 to 0811-1665; RESISTOR; FXD; 0.82 OHM 5% 2W.

Delete A8A2R57.

Page 6-16, Table 6-3:

Add A8A4R4 0698-3628 RESISTOR; FXD; 220 OHM 5% 2W.

Page 6-33, Table 6-3:

Change A26A1Q1 to 1853-0007.

Page 6-39, Table 6-3:

Add R4 0757-0458 RESISTOR; FXD; 51.1K, 1/8W F.

Add R5 0757-0462 RESISTOR; FXD; 75.0K 1/8W F.

Delete MP55.

---

---

**MANUAL CHANGES**

---

**CHANGE B (cont'd)****Service Sheet 9 (schematic):**

Change A11R7 to 1470 ohms and A11R14 to 3160 ohms.

Add R4, 51.1K between 958 and 956 wires.

Add R5, 75K between 956 and 0 wires.

**NOTE**

If R1, AUDIO OUTPUT LEVEL vernier is changed, remove R4 and R5 from instrument.

Change voltage at A11TP3 and TP5 to  $2.1 \pm 0.1$  V p-p.

**Service Sheet 9A (schematic):**

Change A11R36 to 4640 ohms and A11R39 to 3160 ohms.

Add R4, 51.1K between 958 and 956 wires.

Add R5, 75K between 956 and 0 wires.

**NOTE**

If R1, AUDIO OUTPUT LEVEL vernier is changed, remove R4 and R5 from instrument.

Change voltage at A11TP3 and TP5 to  $2.1 \pm 0.1$  V p-p.

**Service Sheet 13 (schematic):**

Change A26A1Q1 to 1853-0007.

**Service Sheet 17 (schematic):**

Add A2VR3 and A2VR4 (in series with each other) in parallel with A2R3.

**NOTE**

See paragraph 7-9. A2VR3 and VR4 should be removed from instrument.

**Service Sheet 20 (schematic):**

Replace appropriate portion of schematic with attached partial schematic (Figure 7-1).

Change A8A2C11 to 100 pF.

Delete A8A2C27.

Delete A8A2L1 and in its place add A8A2R46, 511 ohms.

Add A8A4R4 between pin 2 and A8A4DS2.

Change A8A2R56 to 0.82 ohm. Change +4.5V at other side of A8A4DS2 to +20V.

## MANUAL CHANGES

## CHANGE B (cont'd)

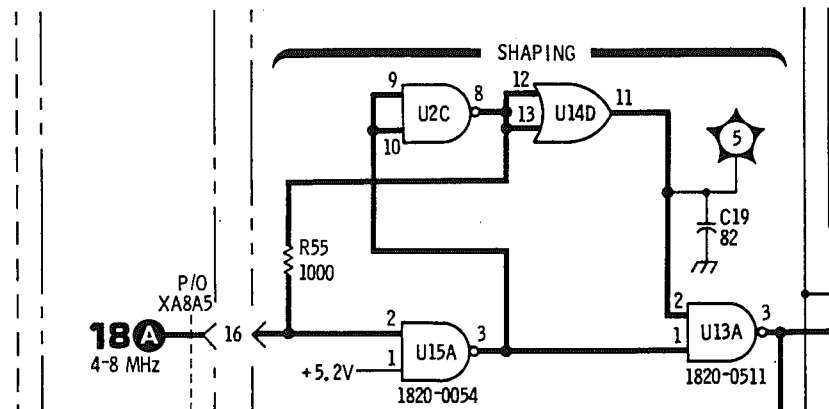

Figure 7-1. A8A2 Counter/Lock Board Assembly Backdating (Change B)

## CHANGE C

## NOTE

See paragraph 7-20 for recommended instrument modification.

Page 5-28, paragraph 5-38:  
Delete step 7.

Pages 5-33 and 5-34, paragraph 5-40:

- Step 1: Change "FREQUENCY TUNE . . . 24 MHz" to "FREQUENCY TUNE . . . 16 MHz."
- Step 2: Change "24 MHz" to "16 MHz."
- Step 4: Delete entire step.
- Step 5: Change reference designator A3A4R2 to A3A4R3.
- Step 6: Change reference designator A3A4 R4 to A3A4R5.
- Step 7: Delete "24".

Page 6-6, Table 6-3:

Change A3R2 to 2100-3266 RESISTOR; VAR; CONT, RREC, 1K 5%.

Delete A3MP15 and MP16.

Delete A3A4 (entire sub-assembly list) and add the following:

A3A4R1	0757-0442	RESISTOR; FXD; 10.0K 1% 1/8W.
A3A4R2	2100-3161	RESISTOR; VAR; 20K 10% TYPE P 3/4W.
A3A4R3	2100-3123	RESISTOR; VAR; 500 OHM 10% TYPE P 3/4W.
A3A4R4	0757-0280	RESISTOR; FXD; 1K 1% 1/8W.
A3A4R5	2100-3154	RESISTOR; VAR; 1000 OHM 10% TYPE P 3/4W.
A3A4TP1	0360-1514	TERMINAL PIN: SQUARE.
	1400-0024	CLAMP, CABLE NYLON 1/4 DIA.

Service Sheet 5 (schematic):

Change Reference Designators "A3A4R6" to "A3A4R1" and "A3A4R1" to "A3A4R2".

---

**MANUAL CHANGES**

---

**CHANGE C (cont'd)**

Service Sheet 6 (schematic):

Replace A3A4 with attached partial schematic (Figure 7-2):

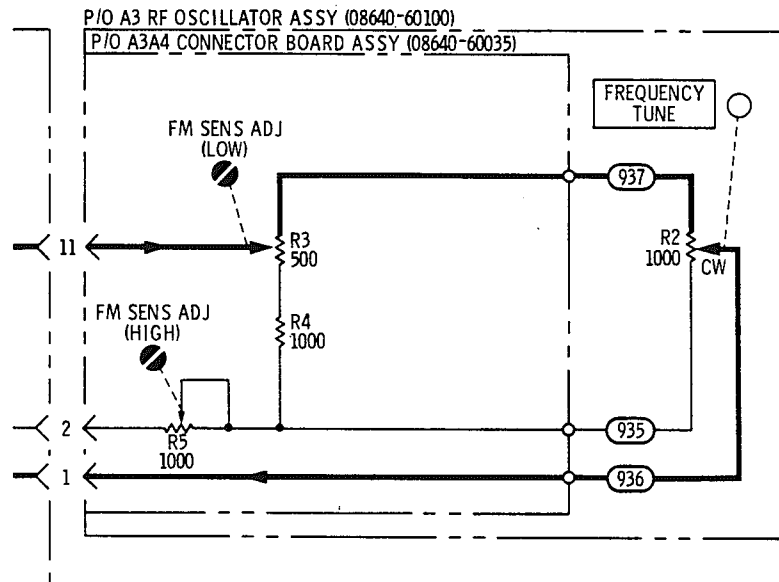

Figure 7-2. A3A4 Connector Board Assembly Backdating (Change C)

**CHANGE D****NOTE**

See paragraph 7-23 for recommended instrument modification.

Page 6-33, Table 6-3:

Delete A26A1R16 and R17.

Page 6-35, Table 6-3:

Change A26A4C10 to 0170-0066 CAPACITOR; FXD; 0.027 UF ±10% 200 WVDC.

Page 6-36, Table 6-3:

Delete A26A4R54.

Page 6-39, Table 6-3:

Delete MP59 and MP60.

Service Sheet 12 (schematic):

Delete A26A4R54.

Change A26A4C10 to 0.027 UF.

Service Sheet 13 (schematic):

Replace appropriate portion of schematic with attached partial schematic (Figure 7-3).

Service Sheet 14 (schematic):

Add a ground symbol at the junction of A13R1 and A13S2BF.

## MANUAL CHANGES

## CHANGE D (cont'd)

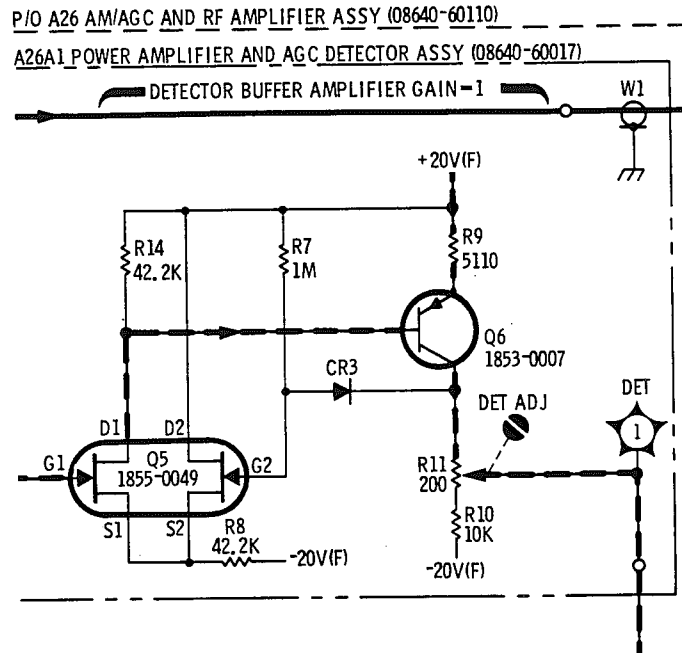

Figure 7-3. A26A1 Power Amplifier and AGC Detector Assembly Backdating (Change D)

## CHANGE E

## NOTE

See paragraphs 7-26 through 7-35 for recommended instrument modifications.

Page 5-2, paragraph 5-21.

Delete section a. **A8A1R4 Selection.**

Add the following:

- a. **A8A1R1 Selection.** A8A1R1 is always 620 ohms in parallel with a resistor selected as follows:
1. Set COUNTER MODE to EXT 0-10 MHz.
  2. Connect RF OUTPUT (-10 dBm at 8 MHz) to COUNTER INPUT.
  3. Connect a 10-ohm linear pot across A8A1R1 (two test points beside U5).
  4. Counter should hold a stable count. Decrease OUTPUT LEVEL vernier until counter just goes into random counting.
  5. Adjust pot for a stable count.
  6. Repeat steps 4 and 5 until the minimum input for stable counting is reached.

**MANUAL CHANGES**

---

**CHANGE E (cont'd)**

Page 5-2, paragraph 5-21 (cont'd):

- 7. Without changing pot resistance, remove pot and measure its resistance. It should typically be 4500 ohms.
- 8. Solder nearest standard value resistor in parallel with A8A1R1 (across test points).

Page 5-2, Table 5-1:

Delete A8A1R4.

Add the following:

A8A1R1	18	620 ohms	See Paragraph 5-21.
--------	----	----------	---------------------

Page 6-6, Table 6-3:

Change A3A4R2 to 2100-3161 RESISTOR; VAR; 20K 10% TYPE P 3/4W.

Page 6-9, Table 6-3:

Change assembly part number for A7 to read as follows:

- A7 08640-60030 FM SHAPING ASSY.
- A7 08640-60084 REBUILT 08640-60030, REQUIRES EXCHANGE.

Delete A7J1.

Page 6-11, Table 6-3:

Change A8L1, L2 and L3 to 9140-0210 COIL, FXD, CHOKE, 100 UH 5%.

Page 6-12, Table 6-3:

Delete A8A1 (entire sub-assembly) and add the following:

A8A1	08640-60038	COUNTER/LOCK ASSY
A8A1	08640-60083	REBUILT 08640-60038, REQUIRES EXCHANGE
A8A1C1	0180-0197	C: FXD ELECT 2.2 UF 10% 20VDCW
A8A1C2	0180-0197	C: FXD ELECT 2.2 UF 10% 20 VDCW
A8A1C3	0160-3879	C: FXD CER 0.01 UF 20% 100 VDCW
A8A1C4	0160-3879	C: FXD CER 0.01 UF 20% 100 VDCW
A8A1CR1	1901-0050	DIODE: SI 200 MA AT 1V
A8A1CR2	1901-0050	DIODE: SI 200 MA AT 1V
A8A1CR3	1901-0050	DIODE: SI 200 MA AT 1V
A8A1CR4	1901-0050	DIODE: SI 200 MA AT 1V
A8A1CR5	1901-0050	DIODE: SI 200 MA AT 1V
A8A1CR6	1901-0050	DIODE: SI 200 MA AT 1V
A8A1J1	1250-1220	CONNECTOR: RF 50 OHM SCREW ON TYPE
A8A1J2	1250-1220	CONNECTOR: RF 50 OHM SCREW ON TYPE
A8A1K1	0490-1073	RELAY
A8A1K2	0490-1073	RELAY
A8A1Q1	1854-0404	TSTR: SI NPN
A8A1Q2	1854-0404	TSTR: SI NPN



---

**MANUAL CHANGES**

---

**CHANGE E (cont'd)**

Page 6-12, Table 6-3 (cont'd):

A8A1R1	0698-6648	R: FXD COMP 620 OHM 5% 1/8W
A8A1R2	0698-6648	R: FXD COMP 620 OHM 5% 1/8W
A8A1R3	0757-0416	R: FXD MET FLM 511 OHM 1% 1/8W
A8A1R4	0757-0394	R: FXD MET FLM 51.1 OHM 1% 1/8W
A8A1R5	0757-0416	R: FXD MET FLM 511 OHM 1% 1/8W
A8A1R6	0757-0416	R: FXD MET FLM 511 OHM 1% 1/8W
A8A1R7	0757-1094	R: FXD MET FLM 1.47K OHM 1% 1/8W
A8A1R8	0757-0279	R: FXD MET FLM 3.16K OHM 1% 1/8W
A8A1U1	1820-0736	IC: DIGITAL
A8A1U2	1820-1003	IC: ECL HEX CONVERTER
A8A1U3	1820-0145	IC: DIGITAL QUAD 2-INPUT NOR GATE
A8A1U4	1820-0102	INTEGRATED CIRCUIT: J-K FLIP FLOP
A8A1U5	5088-7001	IC: AMP AND TRIG
	1251-1556	CONNECTOR: SINGLE CONTACT

Page 6-16, Table 6-3:

Add A9C6 CAPACITOR; FXD; 150 PF 5%.  
 Add A9C7 CAPACITOR: FXD; 750 PF 5%.  
 Add A9C8 CAPACITOR; FXD; 1500 PF 5%.

Page 6-17, Table 6-3:

Delete A9W1.

Page 6-20, Table 6-3:

Change A10A1MP10 to 08640-40050.  
 Delete A10A1MP12.

Page 6-34, Table 6-3:

Change A26A2Q2, Q5 and Q6 to 1854-0071 TRANSISTOR NPN SI PD=300 MW FT=200 MHZ.  
 Change A26A2Q7 to 1854-0023 TRANSISTOR NPN SI PD=360 MW FT=15 MHZ.  
 Change A26A2Q3, Q4, Q8 and Q9 to 1853-0020 TRANSISTOR PNP SI PD=300 MW FT=150 MHZ.  
 Change A26A2U1 to 1820-0398 IC: DIFF COMPARATOR AVOL = 1K MIN.  
 Change A26A2U2 to 1820-0370 IC: TTL HS QUAD 2 INPUT NAND GATE.

Page 6-39, Table 6-3:

Delete MP56 and MP57.

Service Sheet 6 (schematic):

Add A9C6, 150 pF in parallel with A9R18.  
 Add A9C7, 750 pF in parallel with R20.  
 Add A9C8, 1500 pF in parallel with R22.  
 Delete shielded cable A9W1 and in its place add 948 wire (white-yellow-gray).  
 Change A3A4R2 to 20K.

---

---

**MANUAL CHANGES**

---

**CHANGE E (cont'd)****Service Sheet 7 (schematic):**

Delete shielded cable A9W1 and in its place add 948 wire (white-yellow-gray).

Delete Reference Designator A7J1.

Change part number of A7 assembly to 08640-60030.

**Service Sheet 8 (schematic):**

Change part number of A7 assembly to 08640-60030.

**Service Sheet 13 (schematic):**

Change A26A2Q7 to 1854-0023.

Change A26A2Q8 and Q9 to 1853-0020.

Change A26A2U1 to 1820-0398.

Change A26A2U2 to 1820-0370.

Change the pin configuration on the symbol and drawing for A26A2U1 shown in Figure 7-4.

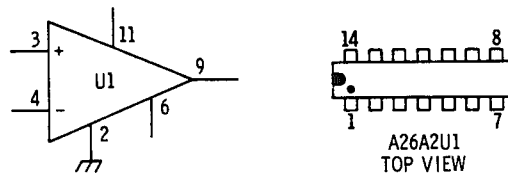

*Figure 7-4. A26A2U1 Backdating (Change E)*

**Service Sheet 14 (schematic):**

Change A26A2Q2, Q5 and Q6 to 1854-0071.

Change A26A2Q3 to 1853-0020.

**Service Sheet 18 (schematic):**

Delete A8A1C3.

Change the following reference designators:

A8A1R8 to A8A1R3.

A8A1R9 to A8A1R5.

A8A1R10 to A8A1R7.

A8A1R11 to A8A1R6.

Change U5 to 5080-7001.

Replace appropriate portion of schematic with attached partial schematic (Figure 7-5).

MANUAL CHANGES

CHANGE E (cont'd)

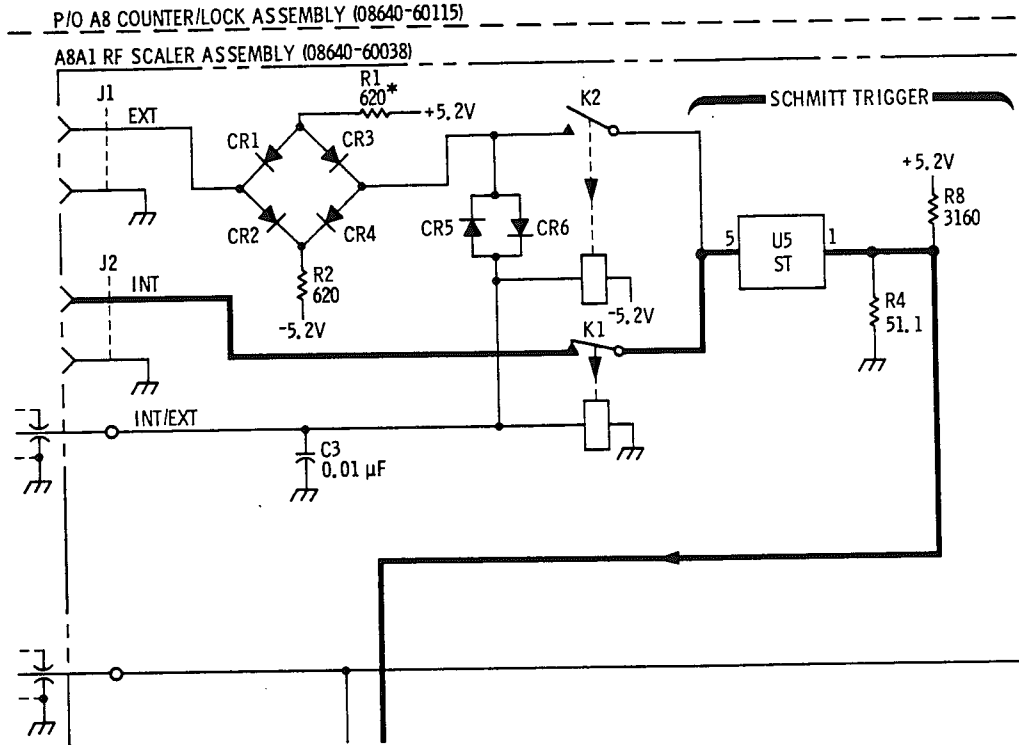

Figure 7-5. A8A1 RF Scaler Assembly Backdating (Change E)

CHANGE F

Page 6-12, Table 6-3:  
Delete A8A1C7.

Service Sheet 18 (schematic):  
Delete A8A1C7.

Service Sheet 22 (schematic):  
Replace appropriate portion of schematic with attached partial schematic (Figure 7-6).

MANUAL CHANGES

CHANGE F (cont'd)

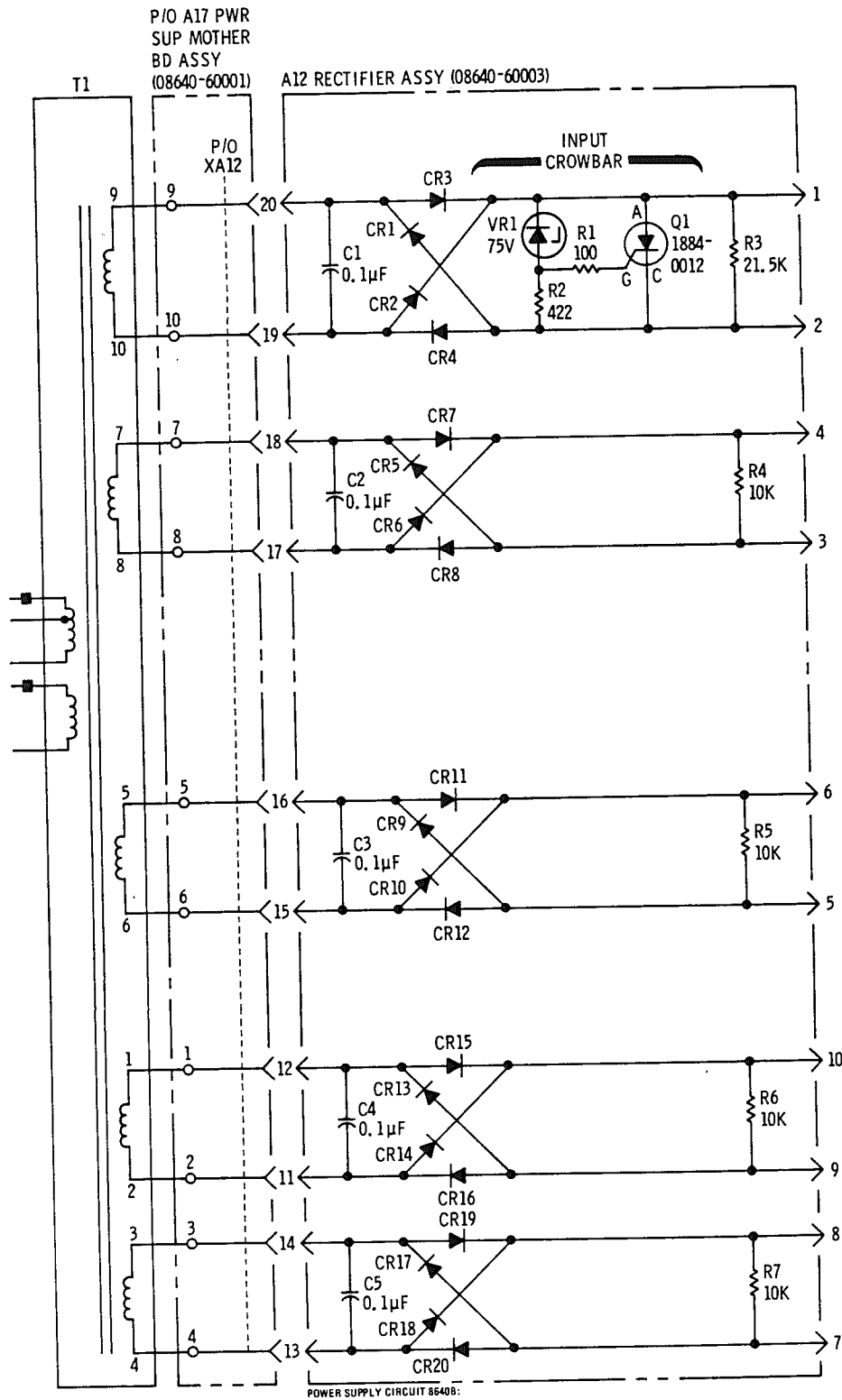

Figure 7-6. A12 Rectifier Assembly Backdating (Change F)

---

**MANUAL CHANGES**

---

**CHANGE G****NOTE**

See paragraphs 7-38 through 7-43 for recommended instrument modifications.

Page 6-7, Table 6-3:

Delete A5C9.

Page 6-12, Table 6-3:

Change A8A2C12 to 0160-3455 CAPACITOR; FXD; 470 PF  $\pm 10\%$  1000 WVDC.

Page 6-13, Table 6-3:

Delete A8A2L2.

Page 6-14, Table 6-3:

Add A8A2R48, 0698-7219 RESISTOR; FXD; 196 OHM 2% 1/8W.

Page 6-38, Table 6-3:

M1, MP20 changed. See paragraph 7-42 for recommended instrument modification.

Service Sheet 6 (schematic):

Delete A5C9.

Service Sheet 20 (schematic):

Change A8A2C12 to 470 pF.

Delete A8A2L2 and in its place add A8A2R48 196 ohms.

**CHANGE H****NOTE**

See paragraph 7-44 for recommended instrument modification.

Page 6-33, Table 6-3:

Change A26A2CR9 to 1910-0022 DIODE; GE; 5W1V.

Page 6-36, Table 6-3:

Change A26A4R13 and R15 to 0757-0199 RESISTOR; FXD; 21.5K 1% 1/8W.

Change A26A4R22 to 0757-1093 RESISTOR; FXD; 3K 1% 1/8W.

Change A26A4R41 and R42 to 0698-3156 RESISTOR; FXD; 14.7K 1% 1/8W.

Service Sheet 12 (schematic):

Change A26A4R13 and R15 to 21.5K.

Change A26A4R22 to 3K.

Change A26A4R41 and R42 to 14.7K.

---

**MANUAL CHANGES**

---

**CHANGE I****NOTE**

See paragraph 7-46 for recommended instrument modification.

Page 6-35, Table 6-3:

Change A26A4C14 to 0160-0134 CAPACITOR; FXD; 220 PF  $\pm$ 5% 300 WVDC.

Service Sheet 12 (schematic):

Change A26A4C14 to 220 pF.

**CHANGE J****NOTE**

See paragraphs 7-48 through 7-51 for recommended instrument modification.

Page 6-12, Table 6-3:

Change A8A1 to 08640-60041 RF SCALER ASSY.

Delete A8A1C7.

Delete A8A1CR1-3.

Add A8A1CR1-4 1901-0518 DIODE: HOT CARRIER.

Add A8A1CR5, 6 1901-0050 DIODE: SI 200 mA at 1V.

Delete A8A1MP2-4.

Add A8A1Q3 1854-0071 TRANSISTOR NPN SI PD=300 MW FT=200 MHZ.

Change A8A1R1 to 0698-6648 RESISTOR; FXD; 620 OHM 5% 1/8W.

Add A8A1R2 0698-5103 RESISTOR; FXD; 430 OHM 5% 1/8W.

Add A8A1R3 0698-7248 RESISTOR; FXD; 3.16K 2% 1/8W.

Page 6-13, Table 6-3:

Change A8A2C27 to 0160-3877 CAPACITOR; FXD; 100 PF 20% 200 WVDC.

Delete A8A2C28, C29 and C30.

Page 6-29, Table 6-3:

Delete A18R19.

Page 6-30, Table 6-3:

Delete A20R27.

Page 6-31, Table 6-3:

Delete A22R26 and R27.

Service Sheet 18 (schematic):

Replace appropriate part of schematic with attached partial schematic (Figure 7-7).

Service Sheet 20 (schematic):

Delete A8A2 C28, C29 and C30.

## MANUAL CHANGES

## CHANGE J (cont'd)

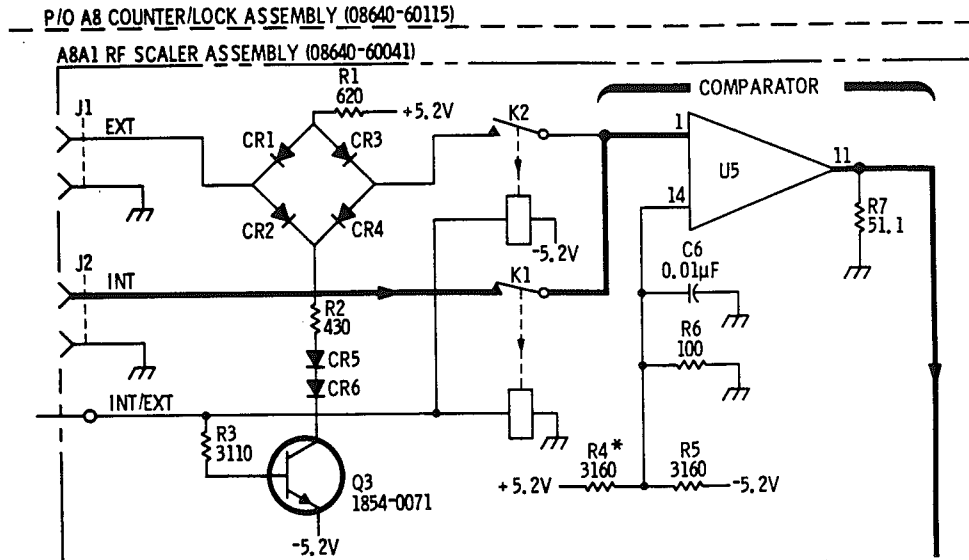

Figure 7-7. A8A1 RF Scaler Assembly Backdating (Change J)

Service Sheet 22 (schematic):

Delete A20R27, A22R26 and R27.

Service Sheet 23 (schematic):

Delete A18R19.

## CHANGE K

## NOTE

See paragraph 7-52 for recommended instrument modification.

Page 6-20, Table 6-3:

Add A10A2C5 0160-3456 CAPACITOR; FXD; 1000 PF 10% 250 WVDC.

Service Sheet 11 (schematic):

Add A10A2C5 between the collector of A10A2Q3 and ground.

## CHANGE L

Page 6-39, Table 6-3:

R1 and AUDIO OUTPUT LEVEL knob changed. See paragraph 7-54 for recommended instrument modification.

---

 MANUAL CHANGES
 

---

## CHANGE M

Page 6-10, Table 6-3:

Change to read as follows:

A7R13	0698-3155	R: FXD MET FLM 4.64K OHM 1% 1/8W
A7R21	0698-3437	R: FXD MET FLM 133 OHM 1% 1/8W
A7R22	0757-0417	R: FXD MET FLM 562 OHM 1% 1/8W
A7R23	0698-0083	R: FXD MET FLM 1.96K OHM 1% 1/8W
A7R24	0757-0279	R: FXD MET FLM 3.16K OHM 1% 1/8W
A7R25	0698-3154	R: FXD MET FLM 4.22K OHM 1% 1/8W
A7R26	0757-0438	R: FXD MET FLM 5.11K OHM 1% 1/8W
A7R27	0757-0290	R: FXD MET FLM 6.19K OHM 1% 1/8W
A7R28	0757-0439	R: FXD MET FLM 6.81K OHM 1% 1/8W
A7R30	0698-4037	R: FXD MET FLM 46.4 OHM 1% 1/8W
A7R31	0698-4037	R: FXD MET FLM 46.4 OHM 1% 1/8W
A7R32	0698-4037	R: FXD MET FLM 46.4 OHM 1% 1/8W
A7R33	0698-4037	R: FXD MET FLM 46.4 OHM 1% 1/8W
A7R34	0698-4037	R: FXD MET FLM 46.4 OHM 1% 1/8W
A7R35	0698-4037	R: FXD MET FLM 46.4 OHM 1% 1/8W
A7R36	0698-4037	R: FXD MET FLM 46.4 OHM 1% 1/8W
A7R37	0757-0180	R: FXD MET FLM 31.6 OHM 1% 1/8W
A7R40	0757-0439	R: FXD MET FLM 6.81K OHM 1% 1/8W
A7R45	0698-3156	R: FXD MET FLM 14.7K OHM 1% 1/8W
A7R46	0757-0441	R: FXD MET FLM 8.25K OHM 1% 1/8W
A7R47	0757-0440	R: FXD MET FLM 7.50K OHM 1% 1/8W
A7R48	0757-0439	R: FXD MET FLM 6.81K OHM 1% 1/8W
A7R49	0757-0290	R: FXD MET FLM 6.19K OHM 1% 1/8W
A7R50	0757-0200	R: FXD MET FLM 5.62K OHM 1% 1/8W
A7R51	0757-0438	R: FXD MET FLM 5.11K OHM 1% 1/8W
A7R52	0698-3155	R: FXD MET FLM 4.64K OHM 1% 1/8W
A7R53	0757-0200	R: FXD MET FLM 5.62K OHM 1% 1/8W
A7R54	0757-0439	R: FXD MET FLM 6.81K OHM 1% 1/8W
A7R57	0757-0402	R: FXD MET FLM 110 OHM 1% 1/8W
A7R58	0757-0401	R: FXD MET FLM 100 OHM 1% 1/8W
A7R59	0757-0400	R: FXD MET FLM 90.9 OHM 1% 1/8W
A7R60	0757-0399	R: FXD MET FLM 82.5 OHM 1% 1/8W
A7R61	0757-0398	R: FXD MET FLM 75 OHM 1% 1/8W
A7R62	0757-0397	R: FXD MET FLM 68.1 OHM 1% 1/8W
A7R63	0757-0276	R: FXD MET FLM 61.9 OHM 1% 1/8W
A7R64	0757-0395	R: FXD MET FLM 56.2 OHM 1% 1/8W
A7R65	0757-0394	R: FXD MET FLM 51.1 OHM 1% 1/8W

Page 6-25, Table 6-3:

Change A11R34 to 0757-0438 RESISTOR; FXD; 5.11K 1% 1/8W.

Change A11R35 to 2100-2633 RESISTOR; VAR; 1K 10% 1/2W LIN.



---

**MANUAL CHANGES**

---

**CHANGE M (cont'd)**

Service Sheet 7 (schematic)

Change to read as follows:

A7R13	4640Ω	A7R30	46.4Ω	A7R45	14.7K	A7R54	6810Ω
A7R21	133Ω	A7R31	46.4Ω	A7R46	8250Ω	A7R57	110Ω
A7R22	562Ω	A7R32	46.4Ω	A7R47	7500Ω	A7R58	100Ω
A7R23	1960Ω	A7R33	46.4Ω	A7R48	6810Ω	A7R59	90.9Ω
A7R24	3160Ω	A7R34	46.4Ω	A7R49	6190Ω	A7R60	82.5Ω
A7R25	4220Ω	A7R35	46.4Ω	A7R50	5620Ω	A7R61	75.0Ω
A7R26	5110Ω	A7R36	46.4Ω	A7R51	5110Ω	A7R62	68.1Ω
A7R27	6190Ω	A7R37	31.6Ω	A7R52	4640Ω	A7R63	61.9Ω
A7R28	6810Ω	A7R40	6810Ω	A7R53	5620Ω	A7R64	56.2Ω
						A7R65	51.1Ω

Service Sheet 9A (schematic):

Change A11R34 to 5110Ω.

Change A11R35 to 1000Ω.

**CHANGE N****NOTE**

See paragraph 7-56 for recommended instrument modification.

Page 5-2, Table 5-1:

Delete A10A2R6-8, R12-14, and R18-20.

Pages 5-2 and 5-3, paragraph 5-21:

Delete sections b. and c. A10A2R6-8, R12-14, and R18-20.

Page 6-16, Table 6-3:

Change A8A4R3 to 0757-0458 RESISTOR; FXD; 51.1K OHM ±1% 1/8W.

Delete A8A4R5.

Delete A8A4XDS1A/B.

Page 6-38, Table 6-3:

Change C6 to 0160-0586 CAPACITOR; FXD; 0.022 UF ± 20% 100 WVDC.

Service Sheet 20 (schematic):

Delete A8A4R5.

---

**INSTRUMENT MODIFICATIONS**

---

**7-7. INSTRUMENT IMPROVEMENT MODIFICATIONS**

7-8. Hewlett-Packard has developed certain recommended instrument modifications that can be used to improve the performance and reliability of earlier versions of the instrument. In some cases, replacing certain parts requires a modification to make these instruments compatible with parts now in use (if the original part is no longer available). These modifications are outlined in the following procedures and are keyed to instruments by serial number or serial number prefix.

**7-9. Improved FM Metering Accuracy (Serial Prefix 1229A)**

7-10. On instruments with serial number prefix 1229A, and with an A2 Meter/Switch Detector Assembly that has a 08640-60031 part number, FM metering accuracy can be improved at high modulation rates by removing the two 2.37V zener diodes, A2VR3 and A2VR4 (see Service Sheet 17). The diodes are in series with each other and in parallel with A2R3 (at the input to A2U1).

**7-11. Elimination of Frequency Shift in Expand X100 Mode (Serial Prefix 1229A)**

7-12. On instruments with serial number prefix 1229A, the frequency counter OVER FLOW lamp must be rewired to prevent RF Oscillator frequency shift when switching to the EXPAND X100 counter mode. The overflow lamp causes the +20 volt power supply voltage to drop, thus changing the RF Oscillator frequency. The modification rewires the overflow lamp to the +5.2 volt power supply and removes current limiting resistor A8A4R4, 220 ohms.

7-13. Perform the following steps and refer to Figure 7-8 and Service Sheet 20.

1. Remove instrument top cover (see Service Sheet F for procedure) and disassemble A8 Counter/Lock Assembly to gain access to the A8A2 and A8A4 Assemblies (see Service Sheet B for procedures).
2. Replace A8A2R57 (on A8A2 Counter/Lock Board Assembly with part number 08640-60027) with a 0.47 ohm resistor (HP 0811-1662). The existing value is 0.82 ohms. R57 is the current limiting resistor for the display LED's from the +5.2 volt supply.
3. On A8A4 Counter Display Assembly (with part number 08640-60025), unsolder and discard A8A4R4, a 220 ohm, 2 watt resistor.
4. Solder a length of insulated wire from top resistor pad of A8A4R4 (nearest overflow lamp) to narrow trace running down center of ground plane.
5. Reassemble counter and test OVER FLOW lamp operation as shown in Operator's Checks in Section III.

**7-14. A8A2 Counter/Lock Board Assembly Improvements (Serial Prefix 1229A)**

7-15. On instruments with serial number prefix 1229A and an A8A2 Assembly with part number 08640-60027, the following modifications will improve reliability (refer to Service Sheets 20 and 21):

1. In the phase lock mode, the pulse width into U4A and U28 may be insufficient to clear the stall counter, and the instrument will not lock. If the problem occurs, replace R48 with a 15  $\mu$ H inductor (L2, HP 9100-1620) and check that C12 is 100 pF.
  2. In the count mode, the pulse width from the output of U17C may be insufficient to clear the counters (U19 to U24), and the count will be incorrect, usually all zeros. Should the problem occur, replace R46 with a 24  $\mu$ H inductor (L1, HP 9100-1622). Change C11 to 470 pF (HP 0160-3455).
  3. In the phase lock mode, a low borrow output of U24 ripples through gates U13C and D to NOR gate U25B. The next clock pulse from U25A clocks the borrow into the countdown input of U23 (which clocks on a positive going pulse). If the borrow from U24B is removed too quickly from U25B, then U23 will not be clocked and the instrument will not phase lock. Should the problem occur, add a 100  $\mu$ F
-

INSTRUMENT MODIFICATIONS

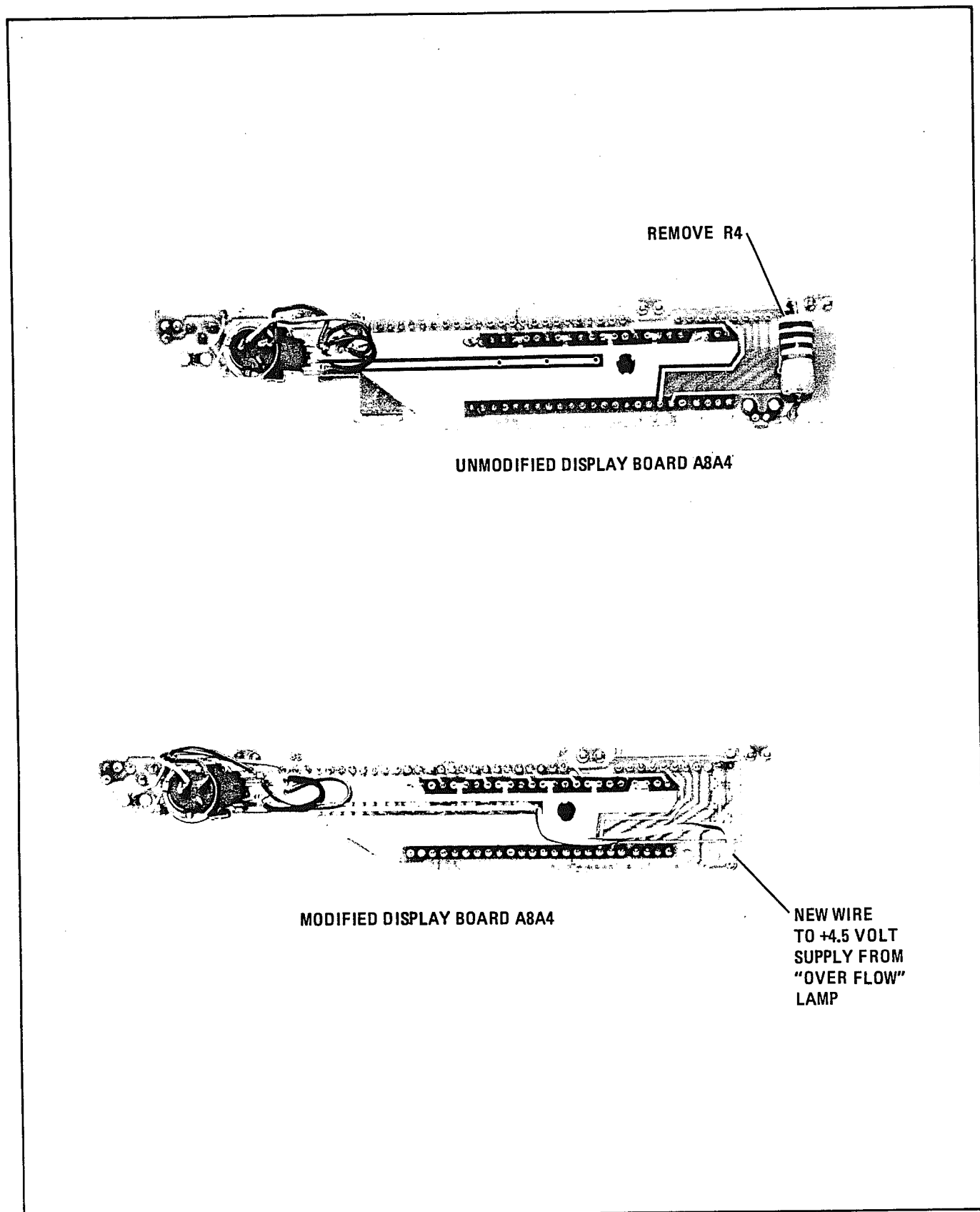

**INSTRUMENT MODIFICATIONS**

capacitor (C27, HP 0160-3877) from the output of U13D (pin 11) to ground.

**7-16. Improved Audio Output Level Accuracy (Serial Prefix 1229A)**

7-17. On instruments with serial number prefix 1229A, the level of the internal modulation oscillator into the FM system can be increased so that it can turn on the REDUCE FM VERNIER annunciator (to verify its operation) as follows:

1. For A11 Fixed-Frequency Modulation Oscillator Assembly (with part number 08640-60020) refer to Service Sheet 9. Change A11R7 to 2870 ohms (HP 0698-3151) and change A11R14 to 2610 ohms (HP 0698-0085). Perform Fixed-Frequency Modulation Oscillator Adjustment in Section V.
2. For A11 Variable-Frequency Modulation Oscillator Assembly (Option 001) (with part number 08640-60019) refer to Service Sheet 9A. Change A11R36 to 6190 ohms (HP 0757-0290) and change A11R39 to 2370 ohms (HP 0698-3150). Perform Variable-Frequency Modulation Oscillator Adjustment in Section V.

**7-18. A26A1 Power Amplifier and AGC Detector Assembly Improvement (Serial Prefix 1229A)**

7-19. On instruments with serial number prefix 1229A and an A26A1 Assembly with part number 08640-60017, level accuracy for narrow pulse widths in AM PULSE mode can be improved by changing Q1 to HP 1853-0015; refer to Service Sheet 13.

**7-20. Reduction of RFI Leakage from Front Panel (Serial Prefix 1244A and Below)**

7-21. On instruments with serial number prefix 1244A and below, RFI leakage from the front panel can be reduced by adding RFI barriers to the main and fine tune shafts and the output attenuator shaft. The following parts are required:

Qty	Description	HP Part No.
2	4-40x1/8 Setscrew	3030-0007
1*	Braid Ring (Main Tune)	8160-0238
1	Braid Ring (Fine Tune)	8160-0239
1	Retaining Collar	08640-20228
1*	Attenuator Shield	08640-00065

\*Order only for serial prefixes 1229A and below

7-22. Remove A3 RF Oscillator Assembly (see Service Sheet F for procedure) and A1 Output Level Assembly (see Service Sheet A for procedure). Modify and re-install as follows:

*A1 Output Level Assembly*

1. Install gold Attenuator Shield on output attenuator's cursor drive gear bushing. The shield should be cupped toward front panel, and the locating tabs should seat in the cursor locating slots.
2. Before re-installing attenuator, apply a small amount of grease (such as PLM grease) to portion of subpanel where Attenuator Shield will rub. This will smooth rotation of vernier and prevent squeaking.
3. Re-install attenuator. If cursor drive gear has disengaged, follow the Output Level Knob Adjustment procedure in Section V.

*A3 RF Oscillator Assembly*

1. Install Main Tune Braid Ring on oscillator's FREQUENCY TUNE shaft. If braid appears to be unraveling, apply solder to braid end. With the braid on the shaft, make braid thinner by pinching with pliers; this will ease installation of oscillator.
2. Slip Retaining Collar and Fine Tune RFI Braid Ring on FINE TUNE shaft. The braid may also need soldering.
3. Re-install RF Oscillator. Check that the green counter time base cable is not pinched under the Oscillator.

---

**INSTRUMENT MODIFICATIONS**

---

4. Press Fine Tune RFI Braid Ring against the subpanel with the Retaining Collar and secure collar with Setscrews. Verify operation of the Oscillator as shown in Operator's Checks in Section III.

**7-23. A26A4 AGC Amplifier Assembly Improvement (Serial Prefix 1245A and Below)**

7-24. On instruments with serial number prefix 1245A and below, the AM bandwidth in the 0.5 to 2 MHz ranges can be improved by modifying the A26A4 AGC Amplifier Assembly (part number 08640-60015). Change C10 (see Service Sheet 12) from 0.027  $\mu$ F to 0.018  $\mu$ F (HP 0160-0302).

7-25. On the same instruments, adding R54 825 ohms (HP 0757-0421) between the collector of Q8 and +5.2V will improve the transistor's reliability. Unsolder and lift the collector lead from the board and add the resistor between the collector lead and the circuit board hole.

**7-26. Reduction of RFI Leakage From RF Oscillator (Serial Prefix 1246A and Below)**

7-27. On instruments with serial number prefix 1246A and below that have excessive RFI leakage from the A3 RF Oscillator Assembly, RFI leakage can be reduced by replacing the RF Oscillator Transistor cap. The new cap is shorter and includes two RFI braid gaskets. The old transistor cap should be replaced with the following parts:

Qty	Description	HP Part No.
1	Cap Transistor	08640-20224
1	Braid Plug	8160-0203
1	Gasket Plug	8160-0233

**NOTE**

The cap is located on the bottom side of the cylindrical part of the oscillator.

**7-28. Replacement A7 FM Shaping Assembly (Serial Prefix 1246A and Below)**

7-29. On instruments with serial number prefix 1246A and below, a new (replacement) A7 Assembly will require modification to be compatible with

an A9 Peak Deviation and Range Switch Assembly that does not have coaxial cable A9W1 (see paragraph 7-32). The new A7 Assembly will have coaxial jack A7J1 (see Service Sheets 6 and 7), the original assembly does not.

7-30. Refer to Figure 7-9 and Service Sheet 7. Modify the board as follows:

1. Add a wire jumper between the two pads above pins 12 and 13 on board. Coaxial jack A7J1 will not be used.
2. The A7 FM Shaping Assembly characteristics must be matched to the RF Oscillator. Perform the Preliminary FM, FM Sensitivity and FM Linearity Adjustments in Section V.

**7-31. Replacement A9 Peak Deviation and Range Switch Assembly (Serial Prefix 1246A and Below)**

7-32. On instruments with serial number prefix 1246A and below, a new (replacement) A9 Assembly will require modification to be compatible with an A7 FM Shaping Assembly with a 08640-60030 part number (see paragraph 7-28). The new A9 Assembly will have coaxial cable A9W1 (see Service Sheets 6 and 7), the original assembly does not. The modification consists of replacing A9W1 with an insulated wire and adding three capacitors. The following parts are required:

Qty	Description	HP Part No.
1	A9C6 150 pF	0140-0196
1	A9C7 750 pF	0160-3538
1	A9C8 1500 pF	0160-2222

7-33. Refer to Figure 7-10 and Service Sheet 6. Modify the switch as follows:

1. Remove the coaxial cable leads from switch wafer S3C rear and S3B front lug 11. Strip the ends of a 8½-inch length of insulated wire, #24 AWG, color code white-yellow-gray (948), and connect it between wafer S3B front lug 11 and pin 24 of connector A9P1. Solder both ends of wire.

### INSTRUMENT MODIFICATIONS

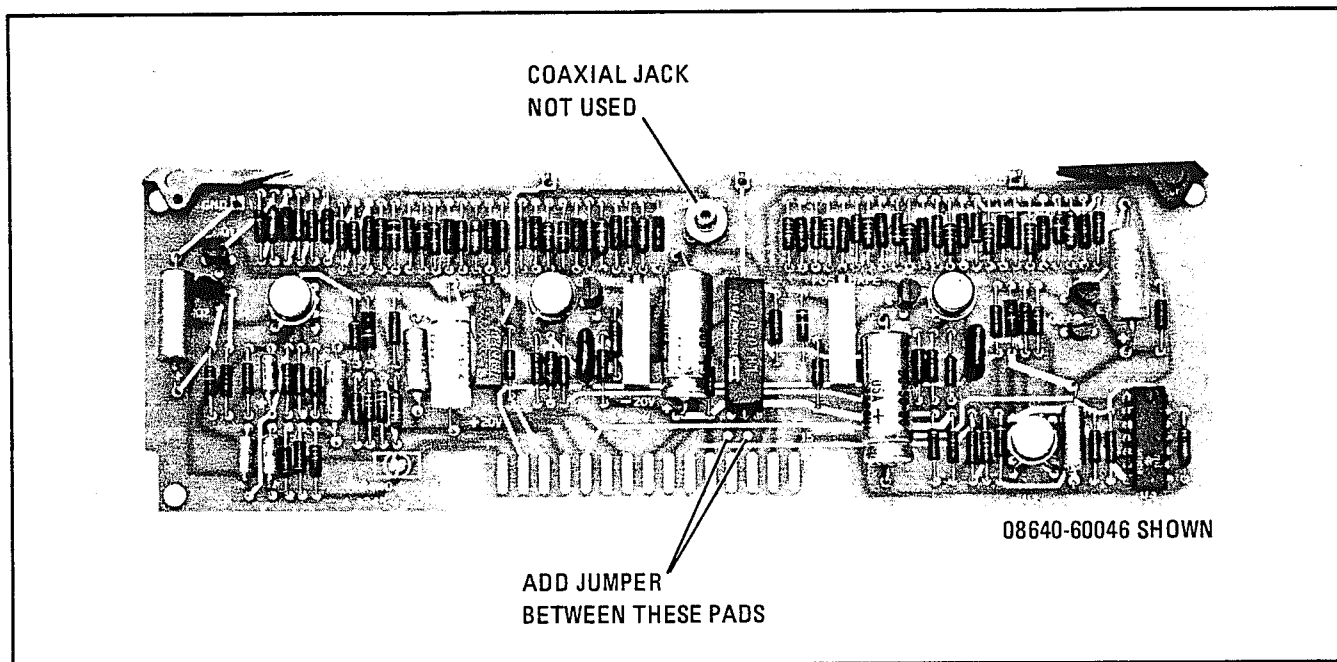

Figure 7-9. A7 FM Shaping Assembly Modification

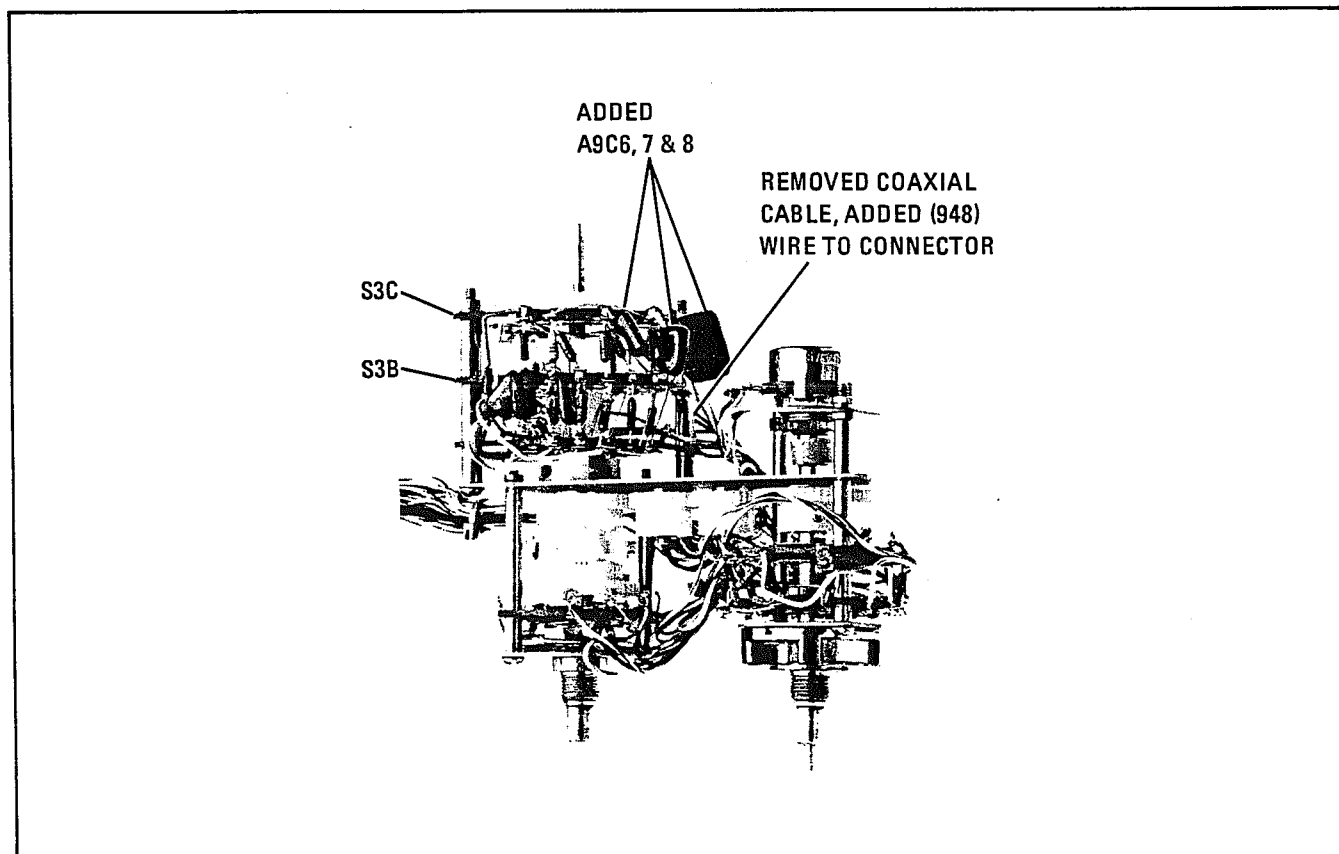

Figure 7-10. A9 Peak Deviation and Range Switch Modification

---

**INSTRUMENT MODIFICATIONS**

---

2. Connect A9C8, 1500 pF, between switch wafer S3B front lug 10½ and wafer S3C front/rear lug with the white-yellow (94) wire, bare wire, a 1500-ohm and a 300-ohm resistor. Solder the end of C8 at wafer S3B front lug 10½.
3. Connect A9C7, 750 pF, across switch wafer S3B front/rear lug 10 and wafer S3C at the same lug as A9C8. Solder both ends of A9C7.
4. Connect A9C6, 150 pF, across switch wafer S3B front/rear lug 9½ and wafer S3C front/rear lug with two 3000-ohm resistors and a bare wire to the lug on either side. Solder both ends of A9C7.
5. Perform the Peak Deviation and Range Switch Adjustment and the Range Switch Adjustment in Section V.

**7-34. A10A1 RF Filter Assembly Switch Improvement (Serial Prefix 1246A and Below)**

7-35. On instruments with serial number prefix 1246A and below, the reliability of the slide-bar switches can be improved by modifying the A10A1 Assembly. The modification consists of replacing the plastic slide-bar switch clamp with one made of aluminum. Replacement requires the use of special fixtures and tools and should be performed by Hewlett-Packard. Contact your local HP office for more information.

**NOTE**

The plastic slide-bar switch clamp is not available for replacement. If found to be defective, it must be replaced by an aluminum clamp.

**7-36. A8A1 RF Scaler Assembly Improvement (Serial Prefix 1249A)**

7-37. On instruments with serial number prefix 1249A and an A8A1 Assembly with an 08640-60041 part number, low level triggering in EXT mode can be improved by increasing isolation between the internal and external signal paths. Refer to Service Sheet 18 and Figure 7-7 and add C7 0.01  $\mu$ F (HP 0160-3879) from the junction of R2 and CR5 to circuit board ground.

**7-38. A5 FM Amplifier Assembly Improvement (Serial Prefix 1251A and Below)**

7-39. On instruments with serial number prefix 1251A and below and an A5 Assembly with an 08640-60029 part number, spurious oscillations may occur in the FM system in the FM OFF mode. To prevent this, refer to Service Sheet 6 and add C9 430 pF (HP 0160-0939) from pin 7 on the circuit board connector to circuit board ground.

**7-40. A8A2 Counter/Lock Board Assembly Improvement (Serial Prefix 1251A and Below)**

7-41. On instruments with serial number prefix 1251A and below and an A8A2 Assembly with an 08640-60027 part number, the pulse width into the Stall Counter may be wide enough to overlap the clock input. The Stall Counter will then count for 10 clock pulses instead of 9 and the instrument will phase lock to a frequency that is one count higher than the indicated count. To prevent this, refer to Service Sheet 20, change C12 to 100 pF (HP 0160-3466) and remove R48 (196 ohms) and in its place add L2, 15  $\mu$ H (HP 9100-1620).

**7-42. Front Panel Meter M1 Replacement (Serial Prefix 1251A and Below)**

7-43. When replacing the panel meter for instruments with serial number prefix 1251A and below, the front panel will also have to be changed to one with a hole which accommodates the front panel zeroing. The hole already exists in the sub-panel.

To replace the meter and front panel, order a current panel meter (HP 1120-0539) and front panel (HP 08640-00063) and proceed as follows:

1. Remove top and bottom covers, top trim strip, front window, and all knobs, nuts, and washers that secure lower half of front panel. The RF OUTPUT connector is most easily removed from behind the sub-panel. Avoid forcing modulation oscillator's frequency dial cursor disk (Option 001 only); gently work it along the shaft.
2. Replace front panel with new one. Replace the nuts and washers that secure the connectors and switches. Replace the FINE TUNE, FREQUENCY TUNE, RANGE, PEAK DEVIA

---

**INSTRUMENT MODIFICATIONS**

---

- TION, and MODULATION FREQUENCY (except Option 001) knobs.
3. Remove A4 Meter/Annunciator Drive Assembly.
  4. Remove A8 Counter/Lock Assembly by removing four corner screws and three RF connectors on bottom of assembly. Use the special wrench provided with instrument to remove the two screw-on connectors.
  5. Remove A6 Annunciator Assembly by unplugging miniature 8-pin connector A6P1 and removing two screws on front of meter support molding.
  6. Remove meter by gently pressing frontward on support molding and lifting meter up and out. Remove the two meter leads.
  7. Connect the meter leads to new meter. (The white lead goes to the "+" terminal.) Insert meter, taking care not to scratch meter face. Check that the solder lugs on the meter terminals do not short to each other or to the chassis.
  8. Replace A6 Annunciator Assembly, A8 Counter/Lock Assembly, and A4 Meter/Annunciator Drive Assembly.
  9. For the Option 001 modulation oscillator, carefully install the dial and check the oscillator's output with a counter to make sure that the dial cursor disk gear is meshed in the correct cogs. Install the modulation oscillator RANGE and vernier knobs; tighten the vernier knob first.
  10. Install the AUDIO OUTPUT LEVEL knob and check its scale accuracy with an external meter by comparing the AM OUTPUT level at 1 kHz into 600  $\Omega$  with the scale indication. Adjust the knob position until the scale is accurate to within  $\pm 20\%$  for all markings.
  11. Perform the Meter Adjustment procedure in Section V. The offset adjustments may be omitted.
  12. Perform the Output Level Knob Adjustment procedure in Section V; the gears, however, should not need adjustment.
  13. Install the covers, trim strip, and front window.
- 7-44. A26 AM/AGC and RF Amplifier Assembly Improvement (Serial Prefix 1303A and Below)**
- 7-45. On instruments with serial number prefix 1303A and below, operation of the AM and pulse modulation circuits can be improved by making the following changes. The changes are recommended at time of service or repair. Refer to Service Sheets 12 and 13.
1. To improve AM bandwidth on an A26A4 AGC Amplifier Assembly with part number 08640-60014), change R13 and R15 to 14.7 k $\Omega$  (HP 0698-3156) and change R22 to 1.78 k $\Omega$  (HP 0757-0278).
  2. To improve RF pulse shape (specifically, to reduce the 90-100% rise time) on an A26A4 AGC Amplifier Assembly with part number 08640-60014, change R41 and R42 to 100 k $\Omega$  (HP 0757-0465).
  3. To improve general circuit reliability on an A26A2 AM Offset and Pulse Switching Assembly with part number 08640-60015, change CR9 to HP 1901-0539.
- 7-46. A26A4 AGC Amplifier Assembly Improvement (Serial Prefix 1310A and Below)**
- 7-47. On instruments with serial number prefix 1310A and below, and with an A26A4 Assembly that has an 08640-60014 or 08640-60015 part number, AM noise performance will be improved by changing C14 from 220 pF to 0.1  $\mu$ F (see Service Sheet 12). The correct part to install is HP 0160-0576. The new capacitor has 0.1-inch lead separation, and the leads should be carefully formed to fit into the present 0.2-inch spacing of the printed circuit board. This change is recommended at time of service or repair.
-



## INSTRUMENT MODIFICATIONS

**7-48. A10A2 RF Divider Assembly Improvement  
(Serial Prefix 1313A and Below)**

7-49. On instruments with serial number prefix 1313A and below, subharmonic rejection can be improved if the fourth RF divider is wired so that it is off when the RF output is taken from the third divider. Refer to Figure 7-11 and Service Sheet 11 and proceed as follows:

1. Remove top cover of instrument (see Service Sheet F for procedure).
2. Remove 14 4-40 pan-head screws that secure cover of A10 Divider/Filter Assembly casting (screws are marked "\*" on cover). Note that the two center screws are longer than the others.
3. Remove cover from casting.
4. Remove 12 4-40 pan-head screws that secure A10A2 RF Divider Assembly. Remove A10A2 and riser board (A10A3) by lifting at the riser.
5. Solder a 1/2-inch length of insulated wire between pin 3 of U18 and the end of R16 (5.11 k $\Omega$ ) that is nearest U18. Refer to Figure 7-11.
6. Replace A10A2 and A10A3 and check that there is no output from U18 (pin 1 or 13) when in the 32 to 64 MHz range. Use a high impedance 50 MHz oscilloscope.
7. Continue reassembly of the instrument and check for proper operation on all frequency ranges.

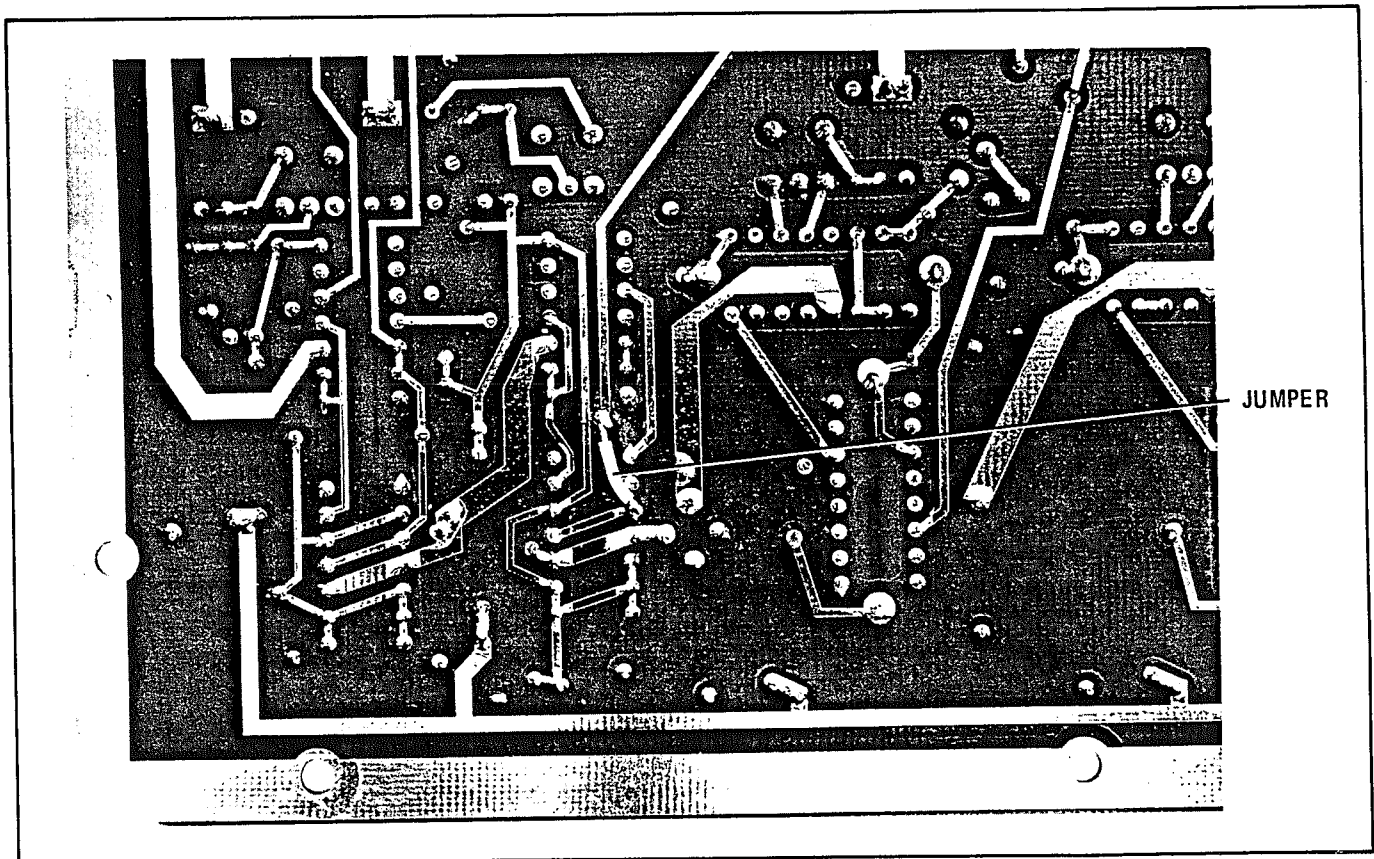

Figure 7-11. A10A2 RF Divider Assembly Modification

---

**INSTRUMENT MODIFICATIONS**

---

**7-50. Power Supply Improvement (Serial Prefix 1313A and Below)**

7-51. On instruments with serial number prefix 1313A and below, the reliability of the voltage regulators in the power supply can be improved by adding pre-loading resistors as follows (refer to Service Sheets 22 and 23):

1. On A18 -5.2V Regulator and Fan Driver Assembly (with part number 08640-60004), add R19 2610 ohms (HP 0698-7246) between pins 5 and 6 of U1.
2. On A20 +5.2V and +44.6V Regulator Assembly (with part number 08640-60005), add R27 2610 ohms (HP 0698-7246) between pins 5 and 6 of U1.
3. On A22 +20V and -20V Regulator Assembly (with part number 08640-60006), add R26 10 k $\Omega$  and R27 to 10 k $\Omega$  (HP 0698-7260), between pins 5 and 6 of U2 and U1 respectively.

**NOTE**

The resistors are most easily installed by carefully lifting the leads (pins 5 and 6) of the integrated circuits out of the holes, inserting a wire or test-point type of pin in the holes, and then soldering both the resistor and integrated circuit leads to the pins.

**7-52. A10A2 RF Divider Assembly Improvement (Serial Numbers 1316A00464 and Below)**

7-53. On instruments with serial numbers 1316A00464 and below and an A10A2 Assembly with an 08640-60023 part number, C5 1000 pF (from collector of Q3 to ground) can cause spurious signals from 500-1000 MHz. To prevent this, remove C5 (see Service Sheet 11).

**7-54. Improved Audio Output Level Flatness (Serial Prefixes 1244A through 1316A)**

7-55. On instruments with serial number prefixes 1244A through 1316A, changing R1 (see Service Sheet 9 or 9A) requires that the AUDIO OUTPUT LEVEL knob be changed; order part number HP 0370-2387 (1V knob for standard oscillator) or HP 0370-2381 (3V knob for Option 001 oscillator). Perform the modulation oscillator adjustment in Section V.

**7-56. A8A4 Counter Display Assembly Improvement (Serial Prefixes 1323A and Below)**

7-57. On instruments with serial number prefix 1323A and below, and an A8A4 Assembly with an 08640-60025 part number, if the time base UNCAL lamp burns out, the time base will not be calibrated. To prevent this, refer to Service Sheet 20 and add R5 46.4 k $\Omega$  (HP 0698-7276) across the leads of UNCAL lamp DS1. To accommodate R5, change R3 to a smaller size 51.1 k $\Omega$  resistor (HP 0698-7277).