



Megger

SMRT410D

Megger multi-phase relay test system

SMRT410D **Megger Multi-phase Relay Test System**



- **Integrated Smart Touch View Interface™**
- **Multi-colored graphics with intuitive navigation**
- **Stand-alone operation, no PC required to operate**
- **High current output - 60 Amps at 300 VA per phase**
- **Flexible output design provides up to 10 currents**
- **Dynamic, Transient and GPS Satellite Synchronized End-to-End Testing Capability**
- **IEC 61850 Testing Capability**

DESCRIPTION

The SMRT410D is a multipurpose, light-weight, field portable test set capable of testing a wide variety of electro-mechanical, solid-state and microprocessor-based protective relays, motor overload relays, and similar protective devices.

The unit can be operated either manually via the built-in touch-screen user interface, or placed under full computer control via the AVTS, Advanced Visual Testing Software, or the RTMS software running on a PC. In addition, with the open communication architecture, the unit can also be used with third-party software programs such as National Instruments LabVIEW™.

The built-in user interface, called the Smart Touch-View Interface™ (STVI), is Megger's second generation of automatic / semi-automatic manual user interface software. It incorporates a large, easy to read Full Color high resolution, high definition, TFT LCD touch-screen display, which displays metered values such as AC and DC Amperes, AC and DC Volts, and Time in both seconds and cycles. Depending on the type of test selected, other values may be displayed, such as Phase Angle, Frequency, Ohms, Watts, VA, or Power Factor.

APPLICATION

The test system may be customized by adding the number of Voltage-Current, "VIGEN", modules needed for specific test applications, with a maximum of 5 channels. For example, the SMRT410D with three VIGEN Modules provides complete three-phase testing of three-phase impedance, directional power, negative sequence overcurrent and other devices that require a three-phase four-wire wye connected source.

Each current channel is rated for 32 Amps @ 200 VA continuous, and up to 60 Amps @ 300 VA for short durations. For testing relay panels or electromechanical relays, it has a unique flat power curve from 4 to 32 Amps that insures maximum compliance voltage to the load at all times.

With a maximum compliance voltage of 50 Volts per phase, two channels in series provide 100 Volts to test high impedance relays. Five currents in parallel provides test currents up to 20 Amperes (1000 VA) for testing ground overcurrent relays at high multiples of tap rating.

With only three currents in parallel it can provide up to 180 Amps at 900 VA for testing all instantaneous overcurrent relays.

Each voltage channel can provide variable outputs of 0- 30/150/ 300 Volts at 150 VA of output power. Automatic range changing is done on-the-fly and under load. For testing a panel of relays, or older electromechanical impedance relays, it has a unique flat power curve from 30 to 150 Volts insuring maximum output power to the load at all times.

With the voltage channels converted to currents, a three channel unit can provide 6 currents for testing three phase current differential relays, including harmonic restraint transformer differential relays. With 5 channels the unit can provide up to 10 currents for testing bus differential, or 9 currents for three-winding transformers, without having to move test leads.

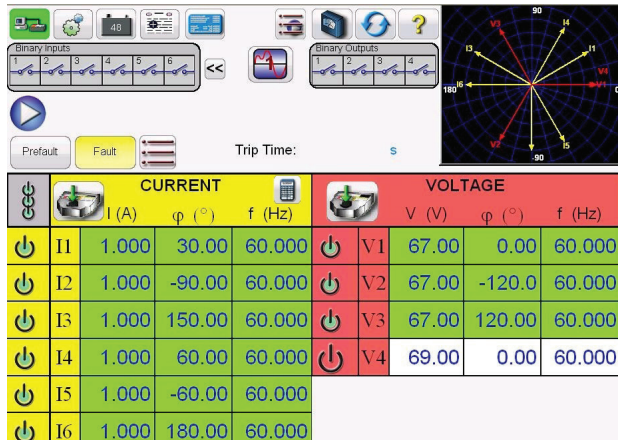

Figure 1 Advanced Manual Test Screen for a 5 Channel, 4 Voltages / 6 Currents Unit

MANUAL OPERATION

The Smart Touch View Interface™ (STVI) touch screen allows the user to perform manual, steady-state and dynamic testing quickly and easily using the Manual or Sequencer test screens, as well as using built-in preset test routines for most popular relays. Ergonomically designed with the control knob, and the touch screen, the powerful RTMS software is extremely easy to use.

DESCRIPTION

The most significant feature of the RTMS software is its ability to provide the user with a very simple way to manually test, for both commissioning and maintenance, from the simple overcurrent relay to the most complex relays manufactured today. Manual operation is simplified through the use of a built-in computer operating system and the touch screen. The STVI eliminates the need for a computer when testing virtually all types of relays. Enhanced graphics, intuitive menu screens, and touch screen icon buttons are provided to quickly and easily select the desired test function. For more details on the RTMS software test capability, see the RTMS data sheet.

FEATURES AND BENEFITS

Large Color TFT LCD touch-screen display - Easy to use and read (even in direct sunlight) display provides manual control of the test set. Color contrasts accentuate vital information. This reduces human error and time in testing relays.

Constant Power Output –The current amplifier delivers maximum compliance voltage to the load constantly during the test, and range changing is done automatically under load. This insures better test results, and saves time by not having to turn the outputs off to change ranges. Constant power output in many cases eliminates the need to parallel and/or series current channels together to test high burden relays, which also saves time.

High Output Current – The SMRT410D provides up to 32 Amps at 200 VA per phase continuous, or up to 60 Amperes at 300 VA with a 1.5 second duty cycle. With only three current amplifiers in parallel it can provide a 180 Amperes at 900 VA for testing all instantaneous overcurrent relays.

New PowerV™ Voltage Amplifier High Power Output-

The SMRT410D provides a new higher VA output on the voltage channel at the lower critical test voltages (from 30 to 150 Volts). Users, who want to test a panel of relays at one time, or certain older electromechanical impedance relays, find it impossible using lower VA rated voltage.

STVI Displays high resolution and accuracy – Metered outputs and timer provides extremely high accuracy. With metered outputs, what you see is what you get.

Steady-State and Dynamic test capability –The SMRT410D provides, either through manual control or computer control, both steady-state and dynamic testing of protective relays. This includes programmable waveforms with dc offset and harmonics.

STVI graphics and intuitive navigation – New test graphics and easier screen navigation saves test time and reduces human error.

Internal memory – Provides storage of test set-up screens and test reports, which reduces testing time and paper work.

Display screen provides four different languages - The display screen prompts the user in English, Spanish, French, or German.

Digital inputs and outputs - 10 programmable inputs, and 6 programmable outputs provide timing and logic operations in real-time with the output voltage and currents. Binary Inputs can be programmed, using Boolean logic, for more complex power system simulations. This provides a low cost, closed loop, power system simulator.

Circuit breaker simulator – Binary outputs provide programmable normally closed and normally open contacts to simulate circuit breaker operation for testing reclosing relays. Sequence of operation, timing, and lockout are easily tested.

Performs transient tests – The SMRT410D can perform acceptance or troubleshooting tests by replaying digitally recorded faults, or EMT/ATP simulations, in the IEEE- C37.111, COMTRADE Standard format.

Perform End-to-End tests – Using AVTS™ software Dynamic Control, or the STVI Sequencer Test; with a portable GPS satellite receiver (or suitable IRIG-B time code source input into Binary Input #1), the SMRT410D performs satellite-synchronized end-to-end dynamic or transient tests. This provides precisely synchronized testing of remotely located complex protection schemes.

Perform Multi-Phase Tests - The SMRT410D can be interconnected with a SMRT36, or SMRT410, or a SMRT1 single phase unit to increase the total number of test currents for testing multi-phase bus differential protection schemes. For example, a 5 channel SMRT410D, interconnected with a 3 channel SMRT36 unit provides a maximum of 16 current channels. The RTMS software supports up to 30 currents for testing bus differential protection schemes.

Three Ethernet Ports - The Ethernet port provides a high-speed computer interface, IEC-61850 test capability, and an interface for interconnecting other SMRT units for multi-phase test applications. There is one dedicated isolated Ethernet port which provides secure isolation when testing IEC 61850 devices (for customers who require secure isolation from their IEC 61850 substation bus).

USB 2.0 interface port – The USB port provides a PC interface for automated control of the SMRT410D unit. Also provides secure isolation when testing IEC 61850 devices (for customers who require secure isolation from their IEC 61850 substation bus).

Immediate error indication – Audible and visual alarms indicate when amplitude or waveforms of the outputs are in error due to short circuit, open circuit, or thermal overload.

Open communication architecture – Use with third party software for more flexible automated control.

SPECIFICATIONS

Input

90 to 264 Volts AC, 1Ø, 50/60 Hz, 1800 VA.

Outputs

All outputs are independent from sudden changes in line voltage and frequency. All outputs are regulated so changes in load impedance do not affect the output. Each output (VIGEN) module consists of one voltage amplifier, and a current amplifier. The voltage amplifier may be converted to a current source. Therefore, one amplifier module may be used to test single phase current differential relays, including harmonic restraint.

Output current sources

Output Current Sources

The SMRT410D with four VIGEN and one DIGEN (Double Current) modules can provide up to ten current sources; six high current/high power, four convertible voltage channels providing lower current/high power. The per channel output current and power ratings are specified in AC rms values and peak power ratings.

Per channel output

Output Current	Power	Max V
1 Ampere	15 VA	15.0 Vrms
4 Amperes	200 VA (282 peak)	50.0 Vrms
15 Amperes	200 VA (282 peak)	13.4 Vrms
32 Amperes	200 VA (282 peak)	6.67 Vrms
60 Amperes	300 VA (424 peak)	5.00 Vrms

DC 200 Watts

Duty Cycle: 32 Amps Continuous, 60 Amps 1.5 seconds

Three currents in parallel

Output Current	Power	Max V
12 Amperes	600 VA (848 peak)	50.0 Vrms
50 Amperes	600 VA (848 peak)	13.4 Vrms
96 Amperes	600 VA (848 peak)	6.67 Vrms
180 Amperes	900 VA (1272 peak)	5.00 Vrms

Four currents in parallel

Output Current	Power	Max V
16 Amperes	800 VA (1132 peak)	50.0 Vrms
60 Amperes	800 VA (1132 peak)	13.4 Vrms
128 Amperes	800 VA (1132 peak)	6.67 Vrms
240 Amperes	1200 VA (1697 peak)	5.00 Vrms

Two currents in series

With two currents in series, the compliance voltage doubles to provide 4.0 Amperes at 100 Volts up to 32A at 13 Vrms.

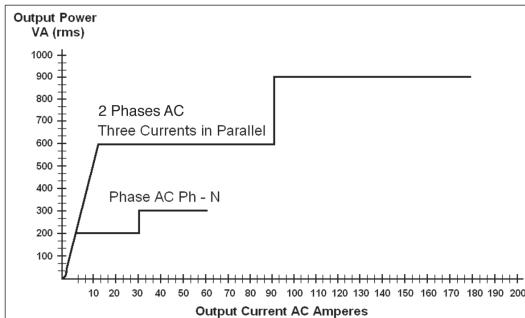

Figure 13 Current Output Power Curve

Current Amplifier-Extended Power Range

The SMRT410D current amplifier provides a unique flat power curve from 4 to 32 Amperes per phase to permit testing of electromechanical high impedance relays, and other high burden applications, with an extended operating range up to 60 Amperes at 300 VA rms for short durations.

AC voltage output

Outputs are rated with the following Ranges:

Output Volts	Power	Max I
30 Volts	150 VA	5 Amps
150 Volts	150 VA	Variable
300 Volts	150 VA	0.5 Amps

DC 150 Watts

Duty Cycle: Continuous

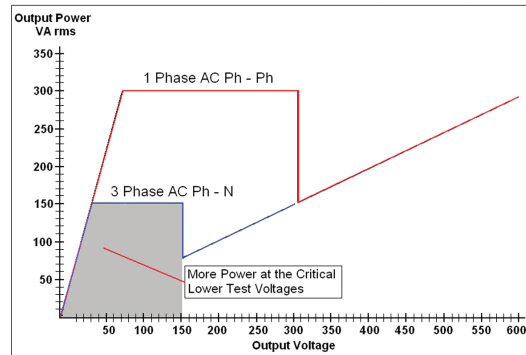

Figure 14 Voltage Output Power Curve

“PowerV” Voltage Amplifier-Extended Power Range

The SMRT410D voltage amplifier provides a flat power curve from 30 to 150 Volts in the 150V range to permit testing of high current applications such as panel testing, and older electromechanical distance relays which demand a higher power voltage source to properly test.

Voltage amplifier in current mode

The voltage amplifier is convertible to a current source with the following output capability. Output power ratings are specified in AC rms values and peak power ratings.

Output Current	Power	Max V
5 Amperes	150 VA (212 peak)	30.0 Vrms
15 Amperes	120 VA	8.0 Vrms

Duty Cycle: 5 Amps Continuous, 15 Amps 1.5 seconds

Battery simulator

The battery simulator provides a continuously variable DC output voltage ranging from 5 to 250 Volts at 100 Watts, 4 Amps max, providing capability to power up relays with redundant power supplies. Voltage output is controlled via the front panel control knob, or through AVTS software.

Metering

Measured output quantities such as AC Amperes, AC Volts, DC Volts or DC Amperes, and Time may be simultaneously displayed on the touch screen. Other values that may be displayed, depending on which test screen is in view, are phase angle, frequency, Ohms, Watts, VA, and Power Factor. All Accuracies stated are from 10 to 100% of the range at 50/60 Hz.

AC voltage amplitude

Accuracy: ±0.05 % reading + 0.02 % range typical, ±0.15 % reading + 0.05 % range maximum

Resolution: .01

Measurements: AC RMS

Ranges: 30, 150, 300V

AC current amplitude

Accuracy: ±0.05 % reading + 0.02 % range typical, ±0.15 % reading + 0.05 % range maximum

Resolution: .001/.01

Measurements: AC RMS

Ranges: 32, 50A

DC Voltage Amplitude

Accuracy: 0.1% range typical,
0.25% range maximum
Resolution: .01
Measurements: RMS
Ranges: 30, 150, 300V

DC Current Amplitude

Accuracy: ± 0.05 % reading + 0.02 % range typical,
 ± 0.15 % reading + 0.05 % range maximum
Resolution: .001/.01
Measurements: RMS
Ranges: 32A

Convertible Source in AC Current Mode

Accuracy: ± 0.05 % reading + 0.02 % range typical,
 ± 0.15 % reading + 0.05 % range or ± 12.5 mA whichever is greater
Resolution: .001
Measurements: AC RMS
Ranges: 5, 15A

DC IN Inputs (Optional Transducer Feature)

DC IN Volts
Range: 0 to ± 10 V DC
Accuracy: ± 0.001 % reading + 0.005% range Typical
 ± 0.003 % reading + 0.02% range Max
Resolution: .001
Measurements: Average

DC IN Amperes

Range: 0 to ± 1 mA DC
4 to ± 20 mA DC
Accuracy: ± 0.001 % reading + 0.005% range Typical
 ± 0.003 % reading + 0.02% range Max
Resolution: .001
Measurements: Average

Total Harmonic Distortion

Less than 0.1% typical, 2% maximum at 50/60 Hz

Timer

The Timer-Monitor Input is designed to monitor and time-tag inputs, like a sequence of events recorder. In addition, the binary input controls enable the user to perform logic AND/OR functions, and conditionally control the binary output relay to simulate circuit breaker, trip, reclose and carrier control operation in real-time. The Timer function displays in Seconds or Cycles, with the following range and resolution:

Seconds: 0.0001 to 99999.9 (Auto Ranging)
Cycles: 0.01 to 99999.9 (Auto Ranging)
Accuracy: ± 0.001 % of reading, typical. ± 2 least significant digit,
 ± 0.005 % of reading from 0 to 50° C maximum

Binary Input – Start/Stop/Monitor Gate

10 inputs monitor operation of relay contacts or trip SCR, continuity light is provided for the input gate. Upon sensing continuity the lamp will glow. In addition to serving as wet/dry contacts the Binary Inputs may be programmed to trigger binary output sequence(s). Input Rating: up to 300 V AC/DC

Binary Output Relays

SMRT410D has 6 independent, galvanically isolated, output relay contacts to accurately simulate relay or power system inputs to completely test relays removed from the power system. The binary output simulates normally open, or normally closed, contacts for testing breaker failure schemes. The binary output can be configured to change state based on binary input logic.

High Current Output Relays 1 to 4:

AC Rating: 400 V max., I_{max}: 8 amps, 2000 VA max.
DC Rating: 300 V max., I_{max}: 8 amps, 80 W
Response Time: <10ms
High Speed Output Relays 5 and 6:
AC/DC Rating: 400 V peak, I_{max}: 1 amp
Response Time: <1ms typical

Waveform Storage

Each output channel can store waveforms for playback on command. End-to-end playback of stored waveforms is possible, when triggered externally by a GPS receiver. Each channel can store up to 256,000 samples.

Protection

Voltage outputs are protected from short circuits and prolonged overloads. Current outputs are protected against open circuits and overloads.

Conformance Standards

Safety: EN 61010-1
Shock: EN/IEC 60068-2-27
Vibration: EN/IEC 68-2-6
Transit Drop: ISTA 1A
Free Fall: EN/IEC 60068-2-32
Drop / Topple: EN/IEC 60068-2-31
Electromagnetic Compatibility
Emissions: EN 61326-2-1, EN 61000-3-2/3, FCC Subpart B of Part 15 Class A
Immunity: EN 61000-4-2/3/4/5/6/8/11

Environmental

Operating Temperature: 32 to 122° F (0 to 50° C)
Storage Temperature: -13 to 158° F (-25 to 70° C)
Relative Humidity: 5 - 90% RH, Non-condensing

Dimensions

13.25 W x 6.75 H x 15 D in.
337 W x 172 H x 381 D mm

Weight

Weight varies depending on the number of output modules in the system. The weight below is for a complete full multi-phase test system.
42.65 lb. (19.2 kg)

Enclosure and Transit Cases

The unit comes mounted in a rugged enclosure for field portability. An optional hard-sided transit case is available. The robust design of the optional hard-sided transit case provides protection when transporting the unit over rugged terrain and long distances. An optional soft-sided carry case protects the unit from light rain and dust. The padded sides provide moderate protection while in transit.

Model SMRT410D Ordering Information

Style Number Identification

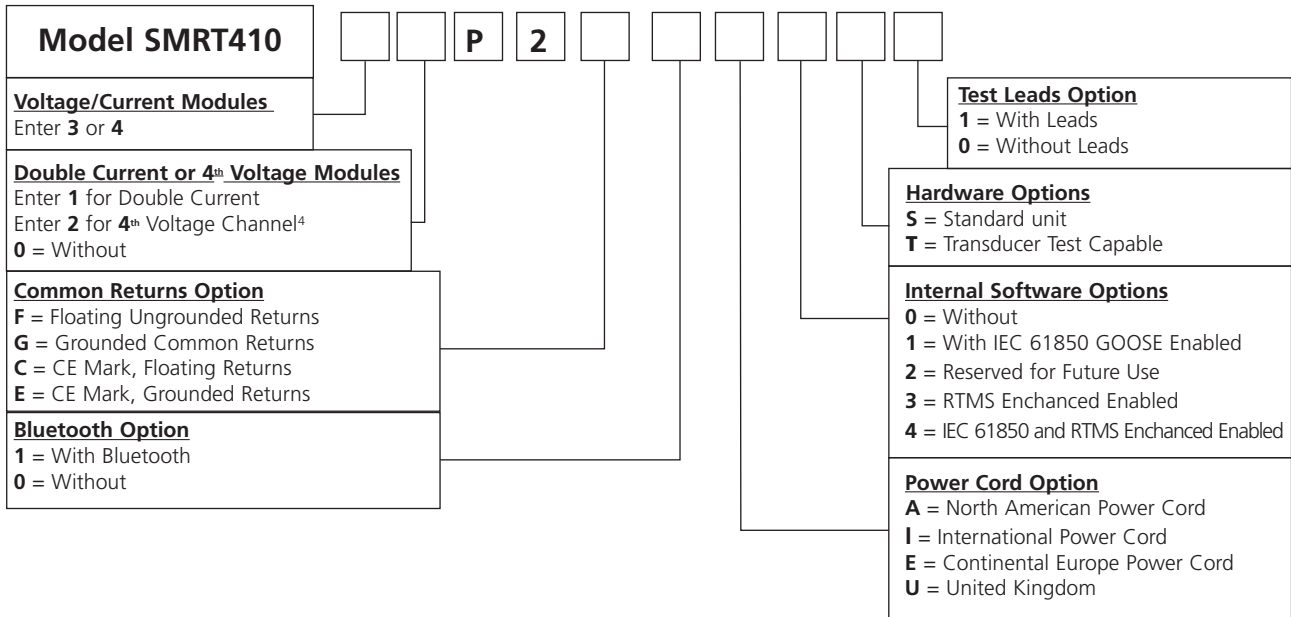

DESCRIPTIONS OF HARDWARE OPTIONS

This modular system lets you select the testing capabilities you need now and expand as testing requirements change. Customize the system by adding the number of Voltage-Current amplifier (VIGEN) modules (3 or 4), with optional Double-Current (DIGEN), or Voltage-Only (VGEN) modules. For 4 Voltages and 3 currents order the unit with 3 VIGENs and 1 VGEN. For more demanding tests; order with 4 VIGENs, and a DIGEN, to provide 4 Voltages, 6 Currents simultaneously, and with convertible voltage channels it will provide up to 10 Currents.

Voltage/Current Modules: The SMRT410D unit can have 3 or 4 voltage/current modules. Enter the number of desired modules 3 or 4.

Double Current, or 4th Voltage¹ Module: The SMRT410D **5th slot** can be a Double Current (DIGEN) Module. Enter the number **1** for the unit to come with the DIGEN. The **4th slot** can host a single Voltage Channel (VGEN) for those who want a 4th voltage channel in addition to 3 Voltage/Current modules. Enter the number **2** for this option. Enter 0 for neither optional module.

Common Returns Option: The floating returns option provides independent isolated return terminals for each output channel. The grounded common returns option, the return terminals are interconnected internally and connected to chassis ground. The CE Mark, C and E units have been certified to the IEC standards for EMC for both the grounded and floating options. The F and G units are designed to operate in countries which do not require the CE mark.

Bluetooth Option: For customers, who wish to have a wireless control of the SMRT unit enter the number **1** for the unit to come with the Bluetooth option, or enter **0** for without Bluetooth option.

Power Cord Option Customers can choose which type of power cord they want the unit to come with.

- **A** option – NEMA 5-15 to IEC60320 C13 connectors, UL & CSA approved for countries with NEMA outlets.
- **I** option - International color coded wires (light blue, brown and green with yellow stripe) insulation jacket stripped ready for male connector with IEC 60320 C13 connector. CE marked.
- **E** option - CEE 7/7 “Schuko” plug to IEC 60320 C13 connector is CE marked.
- **U** option – United Kingdom power cord with IEC 60320 C13 connector, and 13 Amp fuse. BS 1363 / CE Marked.

Internal Software Options: The SMRT410D unit in conjunction with the optional Megger GOOSE Configurator (MGC) software can be used in the testing or commissioning of IEC 61850 compliant devices. In order for the SMRT410D to be able to subscribe as well as publish GOOSE messages, the IEC 61850 feature needs to be enabled². Enter the number **1** for the unit to come with the IEC 61850 option enabled. The number **2** is reserved for future use. Enter the number **3** to enable additional RTMS software features such as the Synchronizer and Frequency test. Enter the number **4** to have both IEC 61850 and RTMS software features enabled. Enter **0** for the unit without internal enhanced software options enabled.

Options: **S**= Standard unit. **T**= With Transducer test capability enabled.

Test Leads Option: Enter the number **1** for the unit to come with Test Leads. Enter **0** for the unit without Test Leads.

²Requires the Optional Megger GOOSE Configurator software to program the unit to subscribe and publish GOOSE messages, see Software Options for part numbers and descriptions.

⁴If a 4th Voltage channel is selected you are limited to a total of 3 VIGENs (Voltage Current Generators)

DESCRIPTION OF SOFTWARE OPTIONS

#	Included Software	Part Number
1	AVTS Basic with RTMS Application Software	84978
Optional Software		
1	AVTS Basic with IEC 61850 Megger GOOSE Configurator, and RTMS Application Software	1002-103
2	AVTS Advanced with RTMS Application Software	81570
3	AVTS Advanced Test with IEC 61850 Megger GOOSE Configurator, and RTMS Application Software	1001-106
4	AVTS Professional with RTMS Application Software	81571
5	AVTS Professional Test with IEC 61850 Megger GOOSE Configurator, and RTMS Application Software	1002-102

DESCRIPTIONS OF SOFTWARE

Included Software – Every unit comes with **AVTS Basic** and the PC version of the **RTMS software**

AVTS Basic with RTMS software (PC Version) Part No.: 84978

AVTS Basic includes Online Vector, Online Ramp and Online Click-On-Fault controls, with the ability to import, execute and save relay specific test modules. The easy to use online tools of Vector and Ramp provide automatic pickup, or dropout tests as well as timing and multi-state dynamic tests. The Online Click-On-Fault tool is used to automatically determine the reach characteristics of single or multi-zone Distance relays using shot for single point tests, or Ramp, Pulse Ramp, or Binary Search tools along user defined search lines. Basic also includes enhanced Relay Test Wizards for; Overcurrent, Differential, Voltage, Frequency and Distance relays. AVTS Basic does not require a software license key to run.

The powerful RTMS software can be run directly from a PC providing both manual and automatic test capabilities. See the RTMS datasheet for more detailed descriptions of test features and capabilities.

Additional Optional Software

AVTS Advanced with RTMS software Part No.: 81570

AVTS Advanced includes all of the features of AVTS Basic in addition to the powerful Test Editor and test editor tools, which includes the Dynamic Control (with dynamic end-to-end test capability, and Recorder features) for developing sequential tests for virtually any function or measuring element within digital relays. In addition, it also includes Modbus communications for automatic download of settings, SS1 File Converter for ASPEN® and CAPE® dynamic test files, End-to-End DFR Playback test capability and basic programming Tools for creating and editing test modules. Software comes with a USB software license key to run on any PC. Test files created in Advanced Test can be used with any PC running AVTS Basic without a software license key.

AVTS Professional with RTMS software Part No.: 81571

Professional Test includes all of the features of AVTS Advanced Test version plus the following additional specialized test tools. The DFR Waveform Viewer and Playback tools are used for viewing and analyzing IEEE C37.111 COMTRADE Standard files from digital fault recorders and microprocessor based relays. The DFR Waveform Viewer includes tools to recreate the analog and digital channels for playback into protective relays for troubleshooting or evaluation. It includes the capability to extend the pre-fault data as well as start the timer associated with the event to time relay operation. These playback test files can also be used in end-to-end tests to recreate the transient event and evaluate the protection scheme. Test files

created in Professional can be used with Advanced Test and Basic. Also included is the One-Touch Test Editor Control Tool for fully automatic testing of microprocessor based relays using VB script files to automatically download relay settings, and automatically test all the measuring elements within the relay based upon those settings. The Waveform Digitizer feature is also included in the Professional Test version of AVTS. It provides tools to create digital time curves for virtually any electromechanical relay time curve (that do not fit a time curve algorithm). It can even be used for digitizing scanned waveforms from a light-beam chart recorder. Software comes with a USB software license key to run on any PC. Test files created in Professional Test can be used with any PC running AVTS Basic without a software license key.

IEC 61850 Megger GOOSE Configurator Software (See Table for Part Numbers)

The Megger GOOSE Configurator (MGC) provides easy to use tools for testing relays and substations using the IEC 61850 protocol. It is an optional software tool available with Basic, Advanced or Professional versions of AVTS Software; see Descriptions of Software Options above. The Configurator provides relay test engineers and technicians the capability to import parameters from configuration files in the Substation Configuration Language (SCL) format, and/or capture GOOSE messages directly from the substation bus. All imported SCL GOOSE messages will be unconfirmed messages. Only captured messages are confirmed messages due to the Capture feature of the MGC. Use the MGC Merge feature to compare imported SCL and captured GOOSE messages to verify all GOOSE messages needed to perform tests. Use them to configure the SMRT to subscribe to preselected GOOSE messages by assigning the data attributes to the appropriate binary inputs of the SMRT. Use the configurator to assign the appropriate binary outputs of the SMRT to publish GOOSE messages simulating circuit breaker status. After the appropriate assignments of binary inputs and outputs have been made, the test file can be saved for reuse. This provides both manual and automatic testing of the relay using either the STVI or AVTS software. Use standard test modules in AVTS to perform automatic tests. Use the Dynamic Control in AVTS Advanced or Professional to perform high speed trip and reclose tests, or use to perform interoperability high-speed shared I/O tests between multiple IED's. The MGC provides mappings of Boolean and Bit Strings and/or simulation of STRuct, Integer/Unsigned, Float and UTC datasets.

TEST LEADS AND ACCESSORIES

All units come with a power cord, an Ethernet communication cable, and instruction manual. All other accessories vary depending on the number of amplifier modules selected, see **Table of Accessories**.

Test Leads and Accessories







All units come with a power cord, an Ethernet communication cable, and instruction manual. All other accessories varies depending on the number of amplifier modules selected, see Table of Accessories.

Included Standard Accessories

Description	Part Number
Power Cord - Depending on the style number, the unit will come with one of the following,	
Line cord, North American	90015-267
Line cord, Continental Europe with CEE 7/7 Schuko Plug	90015-268
Line cord, International color-coded wire	90015-269
Line cord, United Kingdom	90015-270
Ethernet cable for interconnection to PC, 210cm (7 ft.) long (Qty. 1 ea.)	90003-684
Instruction manual USB memory stick	81757

Table of Accessories

Accessories are supplied with the selection of the Test Leads Option. With the Test Leads Option the number and type of leads varies depending on the number of channels ordered. Test Leads and Accessories can be ordered individually, see part numbers below.

	Optional Accessories Descriptions	Test Leads Option	Three (3) Voltage Current Modules	Four (4) Voltage Current Modules	With DIGEN Module ¹	With VGEN and/or Transducer Option
	Accessory Carry Case: Use to carry power cord, Ethernet cable, Optional STVI and test leads.	Qty. 1 ea. Part No. 2003-725				
	Sleeved Pair of Test Leads: Sleeved Test Leads, one red, one black, 200 cm (78.7") long, 600 V, 32 Amperes CAT II		Qty. 2 pr. Part No. 2008-539	Qty. 4 pr. Part No. 2008-539	Qty. 2 pr. Part No. 2008-539	Qty. 4 pr. Part No. 2008-539
	Cable/Spade Lug Adapter (Small): Small lug fit most new relay small terminal blocks. Lug adapter, red, 4.1 mm, rated up to 1000 V/ 20 Amps CAT II		Qty. 14 ea. Part No. 684004	Qty. 18 ea. Part No. 684004	Qty. 2ea. Part No. 684004	Qty. 1 ea. Part No. 684004
	Lug adapter, black, 4.1 mm, rated up to 1000 V/ 20 Amps CAT II.		Qty. 14 ea. Part Number 684005	Qty. 18 ea. Part Number 684005	Qty. 2ea. Part Number 684005	Qty. 1 ea. Part Number 684005
	Jumper Lead: Jumper lead, black, 12.5 cm (5") long, use with voltage / current outputs, 600 V, 32 Amps CAT II		Qty. 4 ea. Part Number 2001-573	Qty. 6 ea. Part Number 2001-573		
	4x6 Sleeved Combination Voltage Leads with Retractable Shrouds: Keeps the test leads from getting entangled. Three common leads connect to the test set, which are interconnected down to one black common to connect to the relay under test. Sleeved Three Phase Test Leads, 200 cm (78.7") long, 600 V, 32 Amperes CAT II.		Qty. 1 ea. Part Number 2008-540	Qty. 1 ea. Part Number 2008-540		
	6x6 Sleeved Combination Voltage Leads with Retractable Shrouds: Keeps the test leads from getting entangled. Three pairs of leads connect to the test set, with three pairs to connect to the relay under test. Sleeved Three Phase Test Leads, 200 cm (78.7") long, 600 V, 32 Amperes CAT II		Qty. 1 ea. Part Number 2008-541	Qty. 1 ea. Part Number 2008-541		



Additional Optional Accessories (Not Included in the SMRT Optional Test Lead Accessories) -



Additional Optional Test Leads and Accessories can be ordered individually, see description and part numbers below.



The following accessories and part numbers are in quantities of 1 each. Order the appropriate number required.

Description	Part No.
Sleeved Pair of Test Leads: Sleeved Test Leads, one red, one black, 200 cm (78.7") long, 600 V, 32 Amperes CAT II. Qty. 2 pr.,	
	
Test Lead, red, use with voltage/current output, or binary I/O, 200 cm long (78.7") 600 V/ 32 Amps CAT II	620143
Test Lead, black, use with voltage/current output , or binary I/O, 200 cm long (78.7") 600 V/ 32 Amps CAT II	620144



Long Individual (Non-Sleeved) Test Leads: Excellent for widely separated individual terminal test connections.	
	
Extra long Lead, black , use with voltage/current output, or binary I/O, 360 cm long (12 ft) 600 V/ 32 Amps CAT II	2003-172
Extra long Lead, red , use with voltage/current output , or binary I/O, 360 cm long (12 ft) 600 V/ 32 Amps CAT II	2003-173



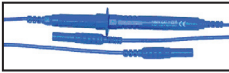

RLC, Relay Lead Connector: Excellent for easily connecting three phase voltage and current leads to the test system.	
	
Two sets of test leads (one for voltages and one for currents), sleeved, 4 mm (0.16 in.) terminals with retractable safety shrouds, color coded red, yellow, blue, black, 200 cm long (78.7") 600 V/ 32 Amps CAT II	RLC
Cable / Spade Lug Adapter (Large): Large spade lug fits older relay terminal blocks, STATES® Company	
	
Lug adapter, red , 6.2 mm, use with test leads up to 1000 V/ 20 Amps CAT II	684002
Lug adapter, black , 6.2 mm, use with test leads up to 1000 V/ 20 Amps CAT II	684003

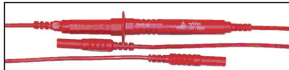
Description	Part No.
Alligator/Crocodile Clip: Excellent for test connections to terminal screws and pins where spade lugs cannot be used.	
	
Alligator clip, red, use with test leads up to 1000 V/ 32 Amps CAT III	684006
Alligator clip, black, use with test leads up to 1000 V/ 32 Amps CAT III	684007
Jumper Lead: Used to common returns together externally when paralleling current channels (not required when using the sleeved combination current leads 2001-396).	
	
Jumper lead, black, 12.5 cm (5") long, use with voltage / current outputs, 600 V, 32 Amps CAT II	2001-573

Flexible Test Lead Adapter: Use with rail-mounted terminals or screw clamp connections where spade lugs and crocodile/alligator clips cannot be used.	
	
Flexible test lead adapter, black, 1.8 mm male pin, use with test leads up to 1000 V/ 32 Amps CAT III	90001-845
Flexible Test Lead Adapter with Retractable Insulated Sleeve: Use for connection to old style non-safety sockets with retractable protective sleeve on one end.	
	
Retractable Sleeve Test Lead, red, 50 cm (20") long, use with test leads up to 600 V, 32 Amperes CAT II	90001-843
Retractable Sleeve Test Lead, black, 50 cm (20") long, use with test leads up to 600 V, 32 Amperes CAT II	90001-844

In-Line Fused Test Lead: Use with high speed binary outputs 5 or 6 ("P" Option) to protect for accidental switching of currents higher than 1 Amp.	
	
Test lead, blue , in-line 500 mA fuse protection, 200 cm long (78.7").	568026

Description	Part No.
<p>In-Line Fused Test Lead: Use with Battery Simulator output to protect for accidental connection to substation battery.</p> 	
<p>Test lead, black, in-line 3.15 A fuse protection, 200 cm long (78.7").</p>	568025
<p>In-Line Resistor Test Lead: Use with old solid state relays with "leaky" SCR trip gates.</p> 	
<p>Test lead, red, in-line 100 k Ohm resistor, use with test leads up to 1000 V/32 Amps CAT III.</p>	500395
<p>Parallel Test Lead Adapter: Used when paralleling up to three current test leads together to a common test point. Usually used when connecting to a test paddle or relay terminal.</p> 	
<p>Parallel test lead adapter, use with test leads up to 600 V/ 32 Amps CAT II</p>	1002-286
GPS unit with accessories	
	
<p>GPS unit with all-weather antenna, power supply, and 15 meter cable</p>	MGTR-II-50
<p>GPS unit with all-weather antenna, power supply, and 30 meter cable</p>	MGTR-II-100
<p>STATES® Company 10 Pole Test Paddle: Use with STATES® FMS 10 Pole Test Switch or ABB FT-1 10 pole Test Switch.</p>	

Description	Part No.
	
<p>Test paddle features knobs which also serve as insulated Ø 4 mm rigid socket accepting spring loaded Ø 4 mm plugs with rigged insulating sleeve, or retractable sleeve. Use with test leads up to 600 V, 32 Amperes CATII.</p>	V1TP10
<p>STATES® 10 Pole Test Paddle Attachment: Use with STATES V1TP10 Test Paddle.</p>	
 	
<p>Test paddle attachment provides an additional 10 insulated connection points for front connection, as well as the standard top connections for test leads. Adapter can provide convenient parallel test connections of test currents to two terminals at one time. Use with test leads up to 600 V, 32 Amperes CAT II.</p>	TPA10
<p>Soft-Sided Carry Case: The soft-sided carry case protects the unit from light rain and dust. The padded sides provide moderate protection while in transit.</p> 	
<p>Soft-sided carry case (1ea)</p>	2007-218
Hard-Sided Transit Case	
<p>Includes custom designed foam inserts for the SMRT46 unit, and accessories. Transit case includes retractable handle, built-in wheels, twist and lock-down latches, spring loaded fold-down handles, with O-ring seal.</p> 	
<p>Rugged, hard-sided transit case (1ea).</p>	1007-084

United States
 4271 Bronze Way
 Dallas, Texas 75237-1088 USA
 T 800.723.2861 (USA only)
 T +1 214.333.3201
 F +1 214.331.7399
 E sales@megger.com

SMRT410D_DS_EN_V12
 www.megger.com
 ISO 9001:2008
 The word 'Megger' is a registered trademark