



## Errata

**Title & Document Type: 8161A Programmable Pulse Generator  
Operating and Programming Manual**

**Manual Part Number: 08161-90005**

**Revision Date: 1981-01-01**

---

### HP References in this Manual

This manual may contain references to HP or Hewlett-Packard. Please note that Hewlett-Packard's former test and measurement, semiconductor products and chemical analysis businesses are now part of Agilent Technologies. We have made no changes to this manual copy. The HP XXXX referred to in this document is now the Agilent XXXX. For example, model number HP8648A is now model number Agilent 8648A.

### About this Manual

We've added this manual to the Agilent website in an effort to help you support your product. This manual provides the best information we could find. It may be incomplete or contain dated information, and the scan quality may not be ideal. If we find a better copy in the future, we will add it to the Agilent website.

### Support for Your Product

Agilent no longer sells or supports this product. You will find any other available product information on the Agilent Test & Measurement website:

[www.tm.agilent.com](http://www.tm.agilent.com)

Search for the model number of this product, and the resulting product page will guide you to any available information. Our service centers may be able to perform calibration if no repair parts are needed, but no other support from Agilent is available.

OPERATING AND PROGRAMMING MANUAL

# **8161A**

# **PROGRAMMABLE**

# **PULSE GENERATOR**

**(Including Options 001, 020 and 907 to 911)**

## SERIAL NUMBERS

This manual applies directly to instruments with serial number 2051G00101 and higher. Any changes made in instruments having serial numbers higher than the above number will be found in a "Manual Changes" supplement supplied with this manual and also in the Manual Changes supplement for the Operating and Service Manual. Be sure to examine this supplement for any changes which apply to your instrument and record these changes in the manual. Backdating information for instruments with lower serial numbers can be found in Section 7 (yellow pages) of the Operating and Service Manual.

© HEWLETT-PACKARD GMBH 1980  
HERRENBERGER STR. 110, D-7030 BÖBLINGEN  
FEDERAL REPUBLIC OF GERMANY

MANUAL PART NO. 08161-90005

Microfiche Part No. 08161-95005

Printed: Jan. 1981



## CERTIFICATION

*Hewlett-Packard Company certifies that this product met its published specifications at the time of shipment from the factory. Hewlett-Packard further certifies that its calibration measurements are traceable to the United States National Bureau of Standards, to the extent allowed by the Bureau's calibration facility, and to the calibration facilities of other International Standards Organization members.*

## WARRANTY

This Hewlett-Packard product is warranted against defects in material and workmanship for a period of one year from date of shipment. During the warranty period, Hewlett-Packard Company will, at its option, either repair or replace products which prove to be defective.

HP warrants that its software and firmware designated by HP for use with an instrument will execute its programming instructions when properly installed on that instrument. HP does not warrant that the operation of the instrument, or software, or firmware will be uninterrupted or error free.

For products returned to HP for warranty service, Buyer shall prepay shipping charges to HP and HP shall pay shipping charges to return the product to Buyer. However, Buyer shall pay all shipping charges, duties, and taxes for products returned to HP from another country.

### LIMITATION OF WARRANTY

The foregoing warranty shall not apply to defects resulting from improper or inadequate maintenance by Buyer, Buyer-supplied software or interfacing, unauthorized modification or misuse, operation outside of the environmental specifications for the product, or improper site preparation or maintenance.

NO OTHER WARRANTY IS EXPRESSED OR IMPLIED. HP SPECIFICALLY DISCLAIMS THE IMPLIED WARRANTIES OF MERCHANTABILITY AND FITNESS FOR A PARTICULAR PURPOSE.

### EXCLUSIVE REMEDIES

THE REMEDIES PROVIDED HEREIN ARE BUYER'S SOLE AND EXCLUSIVE REMEDIES. HP SHALL NOT BE LIABLE FOR ANY DIRECT, INDIRECT, SPECIAL, INCIDENTAL, OR CONSEQUENTIAL DAMAGES, WHETHER BASED ON CONTRACT, TORT, OR ANY OTHER LEGAL THEORY.

## ASSISTANCE

*Product maintenance agreements and other customer assistance agreements are available for Hewlett-Packard products.*

*For any assistance, contact your nearest Hewlett-Packard Sales and Service Office. Addresses are provided at the back of this manual.*

**CONTENTS****List of Contents**

Section 1	General Information	Page
1-1	Introduction . . . . .	1-1
1-4	Specifications . . . . .	1-1
1-6	Safety Considerations . . . . .	1-1
1-9	Instruments Covered by Manual . . . . .	1-1
1-11	Description . . . . .	1-1
1-16	8161A Options . . . . .	1-2
1-23	Accessories Supplied . . . . .	1-2
1-25	Accessories Available . . . . .	1-2
1-27	Recommended Test Equipment . . . . .	1-2
Section 2	Installation	
2-1	Introduction . . . . .	2-1
2-3	Initial Inspection . . . . .	2-1
2-5	Preparation For Use . . . . .	2-1
2-6	Power Requirements . . . . .	2-1
2-8	Line Voltage Selection . . . . .	2-1
2-10	Power Cable . . . . .	2-1
2-13	HP-IB Connector . . . . .	2-2
2-15	HP-IB Logic Levels . . . . .	2-2
2-17	Operating Environment . . . . .	2-2
2-19	Front Handle/Rack Mounting . . . . .	2-2
2-21	Claims and Repackaging . . . . .	2-2
2-22	Claims for Damage . . . . .	2-3
2-24	Storage and Shipment . . . . .	2-3
Section 3	Operating and Programming	
3-1	Introduction . . . . .	3-1
3-3	Special Operating Considerations . . . . .	3-1
3-5	Controls, Connectors and Indicators . . . . .	3-1
3-7	Operators Checks . . . . .	3-1
3-9	Operating Instructions . . . . .	3-1
3-13	Error Indication . . . . .	3-2
3-23	Norm Input Mode . . . . .	3-4
3-25	Parameters . . . . .	3-4
3-33	Delay/Double Pulse Parameters . . . . .	3-5
3-35	Vernier Keys . . . . .	3-5
3-43	Store and Recall . . . . .	3-6
3-47	Standard Parameter Set . . . . .	3-6
3-51	Output Modes . . . . .	3-6
3-58	Trig/Gate/Burst Input Modes . . . . .	3-7
3-62	Trigger Mode . . . . .	3-7
3-64	Gate Mode . . . . .	3-7
3-66	Burst Mode . . . . .	3-7
3-68	Programming Instructions . . . . .	3-8
3-72	Addressing . . . . .	3-8
3-74	Mode and Parameter Setting . . . . .	3-10
3-76	Control Messages and Commands . . . . .	3-10
3-77	Programmed Trigger . . . . .	3-10
3-79	Local, Remote and Local Lockout . . . . .	3-10
3-81	Learn Mode . . . . .	3-10

		Page
3-83	Error Reporting .....	3-11
3-85	Error Recovery .....	3-13
3-90	Programming Examples .....	3-13

Sections 4, 5, 6, 7 and 8 – Performance Tests, Adjustment Procedure, Replaceable Parts, Backdating and Service – are located in the Operating and Service Manual and are covered by a separate list of contents, tables and illustrations.

**TABLES**

Table	Title	Page
1-1	Recommended Test Equipment .....	1-3
1-2	Specifications .....	1-4
3-1	Available Addresses (ATN true) .....	3-8
3-2	Mode and Parameter - Setting Messages (ATN false) .....	3-9
3-3	Control Messages and Commands .....	3-11
3-4	Status Byte .....	3-12
3-5	Code Assignments (ASCII) for the 8161A .....	3-14

**ILLUSTRATIONS**

Figure	Title	Page
1-1	8161A and Supplied Accessories .....	1-0
1-2	Available Rack Mounting Accessories .....	1-0
1-3	Serial Number Plate .....	1-1
2-1	Switch Settings for the various normal power line voltages.	2-1
2-2	Power Cables Available: Plug Identification .....	2-2
2-3	HP-IB Connector .....	2-2
2-4	Removing Plastic Trim .....	2-3
3-1	8161A Controls, Connectors and Indicators .....	3-0
3-2	8161A Variable Pulse Parameters .....	3-1
3-3	Double Pulse Limits .....	3-2
3-4	Leading Edge/Width .....	3-2
3-5	Trailing Edge/Period/Width .....	3-3
3-6	Trailing Edge/Double Pulse/Width .....	3-3
3-7	Trailing Edge/Double Pulse/Width/Period .....	3-3
3-8	Normal Mode .....	3-4
3-9	Slope Generator Ranges .....	3-5
3-10	Trigger Mode .....	3-7
3-11	Gate Mode .....	3-7
3-12	Burst Mode .....	3-7

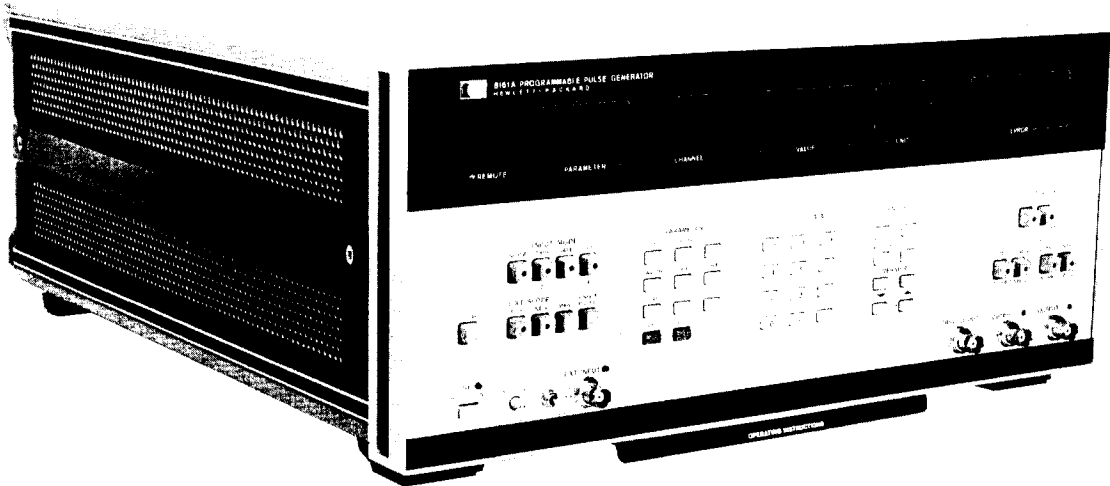

8161A

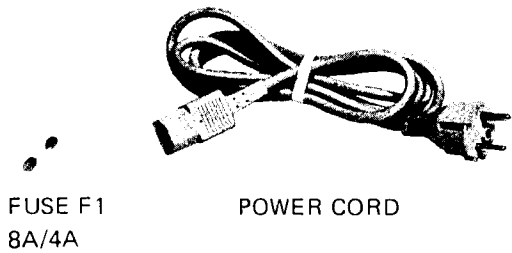

FUSE F1  
8A/4A

POWER CORD

Figure 1-1. 8161A and Supplied Accessories (instrument shown with Option 020 fitted)

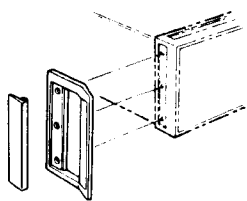

Front handle  
Order Option 907  
(H.P. Part No.  
5061-0090)

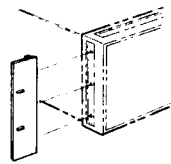

Rack flange  
Order Option 908  
(H.P. Part No.  
5061-0078)

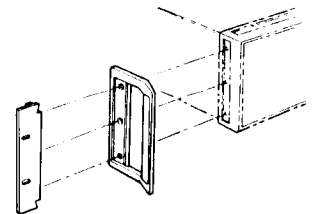

Rack flange with front handle  
Order Option 909  
(H.P. Part No.  
5061-0084)

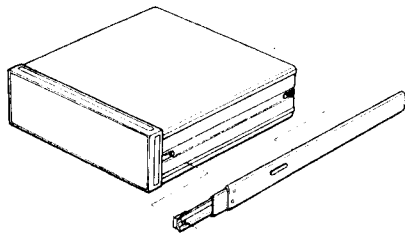

Standard slide kit  
(H.P. Part No. 1494-0017)  
See also § 1-25

Figure 1-2. Available Rack Mounting Accessories

## SECTION I GENERAL INFORMATION

### 1-1 INTRODUCTION

1-2 This Operating Manual contains information required to install, operate and test the Hewlett-Packard Model 8161A. Figure 1-1 shows the mainframe and accessories supplied. This section covers instrument identification, description, accessories, specifications, and other basic information.

1-3 A Microfiche version of this manual is available on 4 x 6 inch microfilm transparencies (order number on title page). Each microfilm contains up to 60 photoduplicates of the manual pages. The microfiche package also includes the latest Manual Changes supplement as well as all pertinent Service Notes.

### 1-4 SPECIFICATIONS

1-5 Instrument specifications are listed in Table 1-2. These specifications are the performance standards or limits against which the instrument is tested.

### 1-6 SAFETY CONSIDERATIONS

1-7 The Model 8161A is a Safety Class 1 instrument (it has an exposed metal chassis that is directly connected to earth via the power supply cable).

1-8 Before operation, the instrument and manual, including the red safety page, should be reviewed for safety markings and instructions. These must then be followed to ensure safe operation and to maintain the instrument in a safe condition.

### 1-9 INSTRUMENTS COVERED BY MANUAL

1-10 Attached to the rear of this instrument is a serial number plate (Figure 1-3). The first four digits of the serial number only change when there is a significant change to the instrument. The last five digits are assigned to instruments sequentially. The contents of this manual apply directly to the instrument serial number quoted on the title page. For instruments with lower serial numbers, refer to the backdating information in Section VII of the O&S manual. For instruments with higher serial numbers, refer to the Manual Change sheets at the end of this manual. In addition to change information, the Manual Change sheets may contain information for correct-

ing errors in the manual. To keep this manual as up-to-date and accurate as possible, Hewlett-Packard recommends that you periodically request the latest Manual Change supplement. The supplement for this manual is identified with this manual's print date and part number, both of which appear on this manual's title page. Complimentary copies of the supplement are available from Hewlett-Packard.

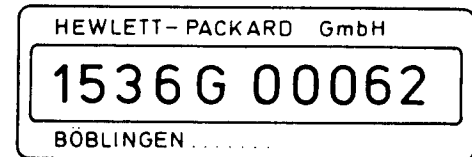

Figure 1-3. Serial Number Plate

### 1-11 DESCRIPTION

1-12 The 8161A is a programmable pulse generator with applications as a bench instrument or part of an automatic test system. It is available with one (standard) or two (option 020) independent channels and can be rack-mounted with input/output connectors on the rear panel if required.

1-13 All parameters are indicated by an alphanumeric display above the keyboard. This eliminates both the need for an oscilloscope to monitor the output and the associated problem of misreading a parameter. All front panel controls are pushbuttons, thus outputs can be very easily and quickly set up and repeatability problems disappear.

1-14 All operations within the 8161A are microprocessor-controlled which further simplifies operation whether performed from the front panel controls or programmed over the HP-IB\*. The microprocessor also enables sophisticated error detection routines to detect and display any incompatible pulse settings.

1-15 The output frequency of the 8161A is 1 Hz to 100 MHz if the output amplifier is being used. All specifications are given in Table 1-2 at the end of this section.

\* *Hewlett-Packard Interface Bus, Hewlett-Packard's implementation of IEEE Standard 488 "Standard Digital Interface for Programmable Instrumentation".*

**1-16 8161A OPTIONS**

1-17 **Option 020.** The standard 8161A has one channel. Option 020 provides a second channel with all parameters variable. Both channels are completely independent except for repetition rate and burst.

1-18 **Option 001** is a standard 8161A with the four BNC input/output connectors taken to the rear panel instead of the front panel. Blanking plugs are then fitted to the front panel. This option is most useful in system applications where the 8161A is rack mounted and all connections must be inside the rack.

1-19 **Options 907, 908, 909** provide handles and/or rack mounting flanges (see Figure 1-2).

1-20 **Option 910** provides an extra copy of the Operating and Service Manual.

1-21 **Option 911** provides an extra copy of the Operating and Programming manual.

1-22 All options will be delivered with the instrument if ordered at the same time as the instrument.

**1-23 ACCESSORIES SUPPLIED**

1-24 The 8161A is supplied complete with the following items (see figure 1-1).

ITEM	HP PART NUMBER
4A fuse for 230V operation	2110-0055
8A fuse for 115V operation	2110-0036
Power cable	see figure 2-2

**1-25 ACCESSORIES AVAILABLE**

1-26 Equipment slides are recommended when rack mounting the 8161A. Slide kits available are as follows:

ITEM	HP PART NUMBER
Standard slide kit — includes two slides for installation into HP rack enclosures (see figure 1-2).	1494-0017
Standard tilt slide kit — same as standard slide kit plus permits tilting instrument up or down 90°.	1494-0026
Slide adaptor bracket kit — brackets for adapting the standard slides above for use in non-HP rack system enclosures of adequate depth.	1494-0023

**1-27 RECOMMENDED TEST EQUIPMENT**

1-28 Equipment required to maintain the model 8161A is listed in Table 1-1. Alternative equipment can be substituted provided that it meets or exceeds the critical specifications listed in the table.



Table 1-1. Recommended Test Equipment

INSTRUMENT	RECOMMENDED MODEL	REQUIRED CHARACTERISTIC	USE *
Counter	HP 5345A	100 MHz, TI A to B, Period	P, A, OP
DVM	HP 3455A	0.1 V – 20 V, ac sample, 0.004 %, acc.	P, A
Time Marker	--	2 ns to 10 s	P, A
Time Interval Probes	HP 5363B	Dynamic range, +9.99 V to -9.99 V	P, A
Pulse Generator	HP 8012B	1 Hz – 50 MHz, delay, pulse, ext. trig	P
Signature Analyzer	HP 1600A	16 bit	T
Logic Analyzer	HP 1600A	16 bit	T
Logic Probe	HP 545A	TTL, MOS	T
Logic Probe	HP 10525A	ECL	T
Real Time Scope	HP 1740A/HP 1743A	100 MHz Bandwidth	P, A, T
Sampling Scope	Tek 760 with 7T11 7S11 and S-3A	Dual channel	P, A, T
System Controller	9825S with:	Desktop computer with HP-IB	P, A, OP
Gen. I/O			
Ext. I/O	98213A		
Interface HP-IB	98034A		
String ROM	98210A		
Alternative System Controllers etc. for <u>Programming Examples only.</u>	9835A		OP
	9845B		OP
	85A		OP
HP-IB Interface (for 85A)	82937A		OP
I/O ROMS (for 9835A/9845B)	9832A		OP
for 85A	HP 00085-15003		OP
DVM	3437A	System Digital Voltmeter	P, A
20 dB attenuator	8941A		P, A
BNC Cable (2)	11170C	50 Ohm cable, BNC (M)	P, A, T, OP
BNC 50 Ohm Term.	10100C	50 Ohm, 2 W, 1 % Feedthrough	P, A, T, OP
BNC "TEE"	1250-0781	1 male, 2 female	P, A, T
Adapter BNC/TIP	10218A	BNC/Time Interval Probe	P, A, T
Cable assembly or Adapter	11172A HP 1250-0595	BNC (M) to TRIAX (M) BNC/TRIAX	P, A, T, OP P, A, T, OP
Extender board (2)	08160-66572	10 pin special	A, T
Extender board (3)	08160-66573	40 pin special	A, T
Extender board	08160-66574	15 pin special	T
Extender board	08160-66575	30 pin special	T
Extender board	08160-66576	37 pin special	T
Extender board	08160-66577	10 pin special	T
Cable Assembly	08160-61610	Test cable	A, T

\* P = Performance Test; A = Adjustments; T = Troubleshooting; OP = Operating and Programming.

Table 1-2. Specifications

### SPECIFICATIONS

The following specifications apply to the 8161A standard and the 8161A Opt. 020 (two channels). Specifications apply with 50 Ohm load resistance. Incompatible values prevented by microprocessor which monitors all pulse parameters. Programming allows all specified range limits to be achieved, irrespective of the accuracy specification.

#### PULSE PARAMETERS

##### PERIOD (PER)

**Range:** 10.0 ns to 980 ms  
**Resolution:** 3 digits (best case 100 ps)  
**Accuracy:**  $\pm 3\%$  of progr. value  $\pm 0.5$  ns (PER < 100 ns)  
 $\pm 2\%$  of progr. value (PER  $\geq 100$  ns)  
**Max. Jitter:** 0.1 % of progr. value + 50 ps

**DELAY, DOUBLE PULSE, WIDTH** (Specifications apply for minimum transition times, measured at 50 % of amplitude. Delay is measured from trigger to main output).

**Delay (DEL) Range:** 0.0 ns to 990 ms  
**Double Pulse (DBL) Range:** 8.0 ns to 990 ms  
**Width (WID) Range:** 4.0 ns to 990 ms  
**Resolution:** 3 digits (best case 100 ps)  
**Accuracy:**  $\pm 1\%$  of progr. value  $\pm 1$  ns  
**Max. Jitter:** 0.1 % + 50 ps ( $\leq 999$  ns)  
 0.05 % (999 ns <  $\leq 9.99$   $\mu$ s)  
 0.005 % (> 9.99  $\mu$ s)

##### DUTY CYCLE LIMITS

**Delay:** for DEL  $\geq 50$  ns, DEL<sub>max</sub> < 0.94 PER - 30 ns  
 for DEL < 50 ns, DEL<sub>max</sub> independent of period  
**Width:** for WID  $\geq 50$  ns, WID<sub>max</sub> < 0.94 PER - 30 ns  
 for WID < 50 ns, WID<sub>max</sub> < 0.94 PER - 3 ns

##### OUTPUT LEVELS

**High Level (HIL) Range:** -4.95 V to 5.00 V  
**Low Level (LOL) Range:** -5.00 V to 4.95 V  
**Resolution:** 3 digits (10 mV)  
**Amplitude:** 0.06 V min, 5.00 V max  
**Level Accuracy:**  $\pm 1\%$  of programmed value  $\pm 3\%$  of amplitude  $\pm 25$  mV  
**Settling Time:** 20 ns plus transition time to achieve specified accuracy.

##### NOTE

In A add B Mode (Opt. 020 only):  
**High Level (HIL) Range:** -1.75 V to 1.80 V  
**Low Level (LOL) Range:** -1.80 V to 1.75 V  
**Amplitude (per channel):** 0.06 V min, 2.50 V max

#### TRANSITION TIMES (10 - 90 % ampl)

**Leading Edge (LEE):** 1.3 ns\* to 900  $\mu$ s  
**Trailing Edge (TRE):** 1.3 ns\* to 900  $\mu$ s  
 \* < 1 ns (20-80 % ampl)  
 \* 1.5 ns in A add B mode (Opt. 020 only).  
**Resolution:** 3 digits (best case 100 ps)  
**Accuracy:**  $\pm 10\%$  of programmed value  $\pm 1$  ns  
**Linearity:**  $\pm 5\%$  for transition times > 30 ns

**PRESHOOT, OVERSHOOT, RINGING:**  $\pm 5\%$  of ampl.  
 $\pm 10$  mV for transition times  $\geq 2.5$  ns, may increase to  $\pm 10\%$  of ampl  $\pm 10$  mV < 2.5 ns.

**A ADD B:** Adds Channel A and B outputs (opt. 020).

#### OUTPUT FORMAT:

**8161A:** simultaneous normal and complement output  
**8161A Opt. 020:** channel A and B, normal/complement independently selectable.

#### OPERATING MODES

**NORM:** Continuous pulse stream.  
**GATE:** External signal enables rate generator. First output pulse sync with leading edge. Last pulse always complete.  
**TRIG:** Each input cycle generates a single output pulse.  
**BURST:** Each input cycle generates a programmable number (0 to 9999) of pulses. Min time between bursts is 1 period. Min period setting in burst mode is 15.0 ns.  
**MAN:** Simulates ext signal when EXT INPUT switched OFF.  
**SINGLE PULSE:** Provides a single pulse independent of input and period settings.

### SUPPLEMENTARY PERFORMANCE CHARACTERISTICS

#### SOURCE IMPEDANCE

**Typical source resistance:** 50 Ohm  
**Typical reflection:** -10 %

#### EXTERNAL INPUT

**Trigger Level:** +10 V to -10 V.  
**Max. Input:**  $\pm 12$  V in 50 Ohm,  $\pm 20$  V in 10 kOhm  
**Minimum Amplitude:** 500 mVpp  
**Slope:** Positive or negative  
**Min. Pulse Width:** 3 ns  
**Typical Input Resistance:** 50 Ohm or (also in OFF) 10 kOhm  
**Delay from Trigger Input to Trigger Output:** 80 ns

#### TRIGGER OUTPUT

Switch selectable TTL and ECL output.  
**Typical output levels into 50 Ohm:** TTL 0 / +2.5 V  
 ECL -0.9 / -1.6 V  
**Typical Source Resistance:** 50 Ohm  
**Typical Pulse Width:** 4 ns (PER < 100 ns),  
 40 ns (100 ns  $\leq$  PER < 1  $\mu$ s),  
 400 ns (PER  $\geq 1$   $\mu$ s).  
 4 ns fixed in external trigger mode.

**PROGRAMMING RANGES**

**Period:** 9.0 ns to 999 ms  
**Delay:** 0.0 ns to 999 ms  
**Double Pulse:** 7.0 ns to 999 ms  
**Width:** 3.0 ns to 999 ms  
**High Level:** -5.05 V to 5.10 V  
**Low Level:** -5.10 V to 5.05 V  
**Transition Time:** Leading and trailing edge transition times are independently programmable for transition times  $\geq 5$  ns within a common range. For transition times  $< 5$  ns, both transition times are set simultaneously.  
 Ranges are as shown below:

1.0 ns - 4.9 ns	0.50 $\mu$ s - 9.99 $\mu$ s
5.0 ns - 99.9 ns	05.0 $\mu$ s - 99.9 $\mu$ s
050 ns - 999 ns	050 $\mu$ s - 999 $\mu$ s

**HP-IB CAPABILITY**

All modes and parameters can be programmed. EXT SLOPE POS/NEG programming can simulate Gate mode. TRIG LEVEL adjustment, 50 Ohm/10 kOhm/OFF switch are not programmable.

**PROGRAMMING TIMES**

**LISTEN** (time for 8161A to receive and verify message), typical.

**Period, Delay, Double Pulse, Width:** 100 ms  
**Transition Times:** 60 ms  
**Output Levels:** 110 ms  
**Burst:** 70 ms (existing burst will be interrupted when programming new burst)  
**Input Modes:** 70 ms  
**Output Modes:** 200 ms  
**Device Trigger:** 40 ms (EXT TRIG),  
 80 ms (BURST)

**TALK** (time for 8161A to transmit a message), typical.

**Status:** 1 byte (indicates nature of programming error),  $< 6$  ms typical.  
**Learn:** 11 lines (18 in option 020) up to 14 characters plus CRLF 10 ms/lin av.

**SETTLING TIMES** (time to execute message), typical.

**Period, Delay, Double Pulse, Width, Transition Times:** 1 ms  
**Output Levels:** 50 ms

**MEMORY:** 9 programmable locations.  
 1 location for active operating state.  
 1 location with fixed parameter set.

**Capacity:** 1 complete operating state per location.  
**Access Time:**  $< 20$  ms (store),  
 $< 160$  ms (recall)

**GENERAL**

**RECALIBRATION PERIOD:** 1 year  
**WARM-UP TIME:** 30 min to meet all specifications  
**REPEATABILITY:** Factor 2 better than specified accuracy.  
**ENVIRONMENTAL:**

**Storage temperature:**  $-40^{\circ}\text{C}$  to  $75^{\circ}\text{C}$   
**Operating temperature:**  $0^{\circ}\text{C}$  to  $50^{\circ}\text{C}$ .  
 Specifications apply from  $20^{\circ}\text{C}$  to  $40^{\circ}\text{C}$ .  
 Accuracy derating for temperatures from  $20^{\circ}\text{C}$  to  $0^{\circ}\text{C}$  and from  $40^{\circ}\text{C}$  to  $50^{\circ}\text{C}$  with factor  $(1 + 0.05 \times \Delta^{\circ}\text{C})$  - where  $\Delta^{\circ}\text{C}$  is the temperature deviation outside the  $20^{\circ}\text{C} - 40^{\circ}\text{C}$  range.

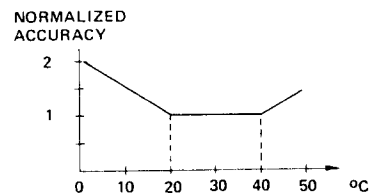

**Humidity range:** 95 % R.H.,  $0^{\circ}\text{C}$  to  $40^{\circ}\text{C}$ .  
**POWER-OFF STORAGE:** After eight hours of operation, batteries maintain all stored data up to 2 weeks with instrument switched off. Hardwired addressable location contains a fixed operating state for confidence check (standard parameter set).  
**POWER:** 115/230 V rms  $\pm 10\%$ ,  $-22\%$ ; 48-66 Hz; 675 VA max.  
**WEIGHT:** Net 20.8 kg (46 lbs), Shipping 25 kg (55 lbs).  
**DIMENSIONS:** 178 mm high, 426 mm wide, 500 mm deep (7 x 16.8 x 19.7 in).

**OPTIONS**

- 020 Second Channel. Includes delay, width, double pulse, transition times, and output amplifier  
 Rear Panel Input and Outputs (instead of front panel) . . . . . no extra charge
- 907 Front Handle Kit (Part-No. 5061-0090)
- 908 Rack Flange Kit (Part No. 5061-0078)
- 909 Rack Flange and Front Handle Combination Kit (Part No. 5061-0084)
- 910 Additional Operating and Service Manual (Includes Opt. 911) (Part No. 08161-90001)
- 911 Additional Operating and Programming Manual (Part No. 08161-90005)

Specifications describe the instrument's warranted performance. Supplemental characteristics are intended to provide information useful in applying the instrument by giving fixed or non-warranted typical performance parameters.

*Data subject to change.*

## SECTION II INSTALLATION

### WARNING

*This instrument weighs 20.8 kg (46 lbs). Care must be exercised when lifting to avoid personal injury. Equipment slides are recommended when rack mounting (see paragraph 1–24).*

### 2–1 INTRODUCTION

2–2 This section provides installation instructions for the instrument and its accessories. It also includes information about initial inspection and damage claims, preparation for use, and packaging, storage and shipment.

### 2–3 INITIAL INSPECTION

2–4 Inspect the shipping container for damage. If the container or cushioning material is damaged, it should be kept until the contents of the shipment have been checked for completeness and the instrument has been checked mechanically and electrically. The contents of the shipment should be as shown in Figure 1–1 plus any accessories that where ordered with the instrument. Procedures for checking the electrical operation are given in Section 4. If the contents are incomplete, if there is mechanical damage or defect, or if the instrument does not pass the operator's checks, notify the nearest Hewlett-Packard office. Keep the shipping materials for carrier's inspection. The HP office will arrange for repair or replacement without waiting for settlement.

### 2–5 PREPARATION FOR USE

### WARNING

*To avoid hazardous electrical shock, do not perform electrical tests when there are signs of shipping damage to any portion of the outer enclosure (covers, panels, meters).*

### 2–6 Power Requirements

2–7 The instrument requires a power source of 115V, or 230V (+10%, –22%) at a frequency of 48 to 66 Hz single phase. The maximum power consumption is 675VA.

### 2–8 Line Voltage Selection

### CAUTION

*BEFORE SWITCHING ON THIS INSTRUMENT make sure that the instrument is set to the local line voltage.*

2–9 Figure 2–1 provides information for line voltage and fuse selection:

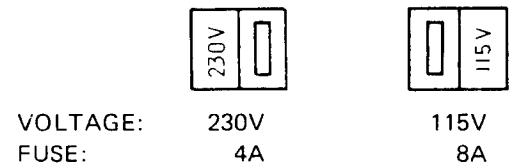

Figure 2–1. Switch Settings for the various Normal Power line Voltages

### 2–10 Power Cable

### WARNING

*To avoid the possibility of injury or death, the following precautions must be followed before the instrument is switched on:*

- a. *If this instrument is to be energized via an auto-transformer for voltage reduction, make sure that the common terminal is connected to the grounded pole of the power source.*
- b. *The power cable plug shall only be inserted into a socket outlet provided with a protective ground contact. The protective action must not be negated by the use of an extension cord without a protective conductor.*
- c. *Before switching on the instrument, the protective ground terminal of the instrument must be connected to a protective conductor of the power cable. This is verified by checking that the resistance between the instrument chassis and the front panel and the ground pin of the power cable plug is zero ohms.*

2-11 In accordance with international safety standards, this instrument is equipped with a three-wire power cable. When connected to an appropriate ac power receptacle, this cable grounds the instrument cabinet. The type of power cable shipped with each instrument depends on the country of destination. Refer to Figure 2-2 for the part number of the power cords available.

2-12 The following work should be carried by a qualified electrician and all local electrical codes must be observed. If the plug on the cable supplied does not fit your power outlet, or if the cable is to be attached to a terminal block, then cut the cable at the plug end and re-wire it. The colour coding used in the cable will depend on the cable supplied (see figure 2-2). If a new plug is to be connected, the plug should meet local safety requirements and include the following features:

- adequate load-carrying capacity (see table of specifications in section 1)
- ground connection
- cable clamp

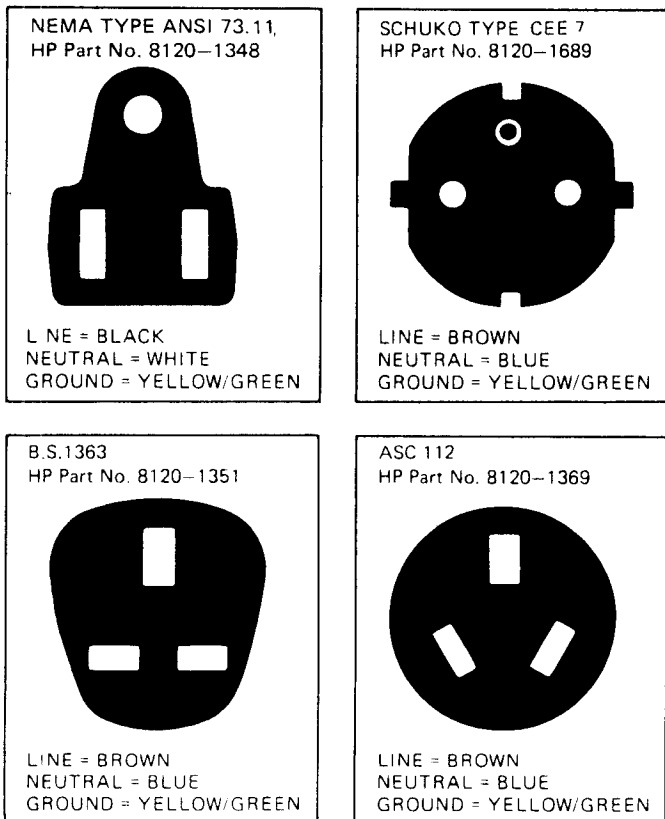

Figure 2-2. Power Cables Available: Plug Identification

2-13 HP-IB Connector

2-14 The rear panel HP-IB connector (Figure 2-3) is compatible with the connectors on Cable Assemblies 10631A, B, C and D. If a cable is to be locally-manufactured, use connector male, HP part number 1251-0293.

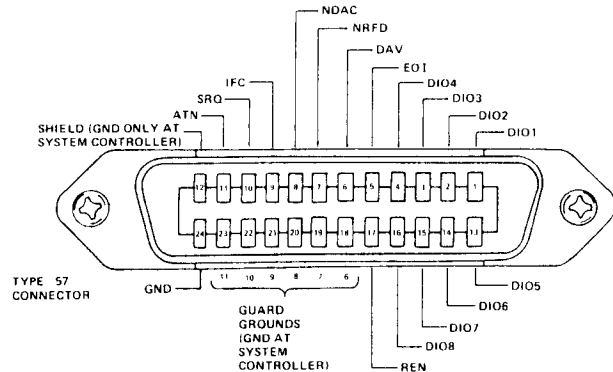

Figure 2-3. HP-IB Connector

2-15 HP-IB Logic Levels

2-16 The 8161A HP-IB lines use standard TTL logic. Logic levels are as follows:

- True = low = digital ground or 0V dc to +0.4V dc,
- False = high = open or +2.5V dc to +5V dc.

All HP-IB lines have LOW assertion ("1") states. High states are held at +3V dc by pullups within the instrument. When a line functions as an input, approximately 3.2mA of current is required to pull it low through a closure to digital ground. When a line functions as an output, it will sink up to 48mA in the low state and approximately 0.6mA in the high state.

2-17 Operating Environment

2-18 The operating temperature limits for this instrument are 0°C to 50°C. However, the accuracy and repeatability specs only apply from 20° to 40°C. Outside this range the accuracy and repeatability specs should be derated (see spec. Table 1-2).

2-19 FRONT HANDLE/RACK MOUNTING

2-20 Figure 1-2 and paragraph 1-24 give the possible handle/rack mounting configurations. If handles are fitted and subsequently need to be removed, the plastic trim must first be taken off as shown in Figure 2-4.

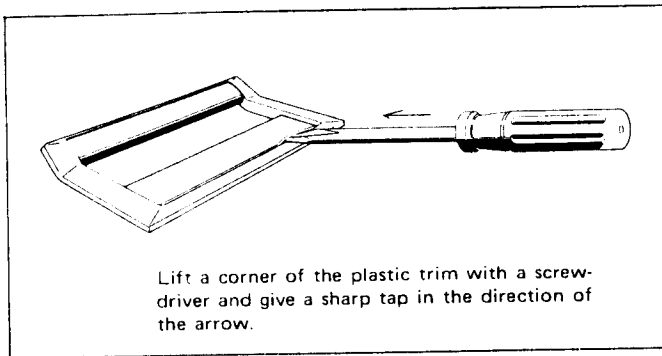

Figure 2-4. Removing Plastic Trim

## 2-21 CLAIMS AND REPACKAGING

### 2-22 Claims for Damage

2-23 If physical damage is evident or if the instrument does not meet specification when received, notify the carrier and the nearest Hewlett-Packard Sales/Service Office. The Sales/Service Office will arrange for repair or replacement of the unit without waiting for settlement of the claim against the carrier.

### 2-24 Storage and Shipment

2-25 The instrument can be stored or shipped at temperatures between  $-20^{\circ}\text{C}$  and  $70^{\circ}\text{C}$ . The instrument should

be protected from temperature extremes which cause condensation within the instrument.

2-26 If the instrument is to be shipped to a Hewlett-Packard Sales/Service Office, attach a tag showing owner, return address, model number and full serial number and the type of service required. The original shipping carton and packaging material may be re-usable but the Hewlett-Packard Sales/Service office will also provide information and recommendations on materials to be used if the original packing is not available or reusable. General instructions for re-packing are as follows:

1. Wrap instrument in heavy paper or plastic.
2. Use strong shipping container. A double wall carton made of 350-pound test material is adequate.
3. Use enough shock-absorbing material (3 to 4-inch layer) around all sides of instrument to provide firm cushion and prevent movement inside container. Protect control panel with cardboard.
4. Seal shipping container securely.
5. Mark shipping container FRAGILE to encourage careful handling.
6. In any correspondence, refer to instrument by model number and serial number.

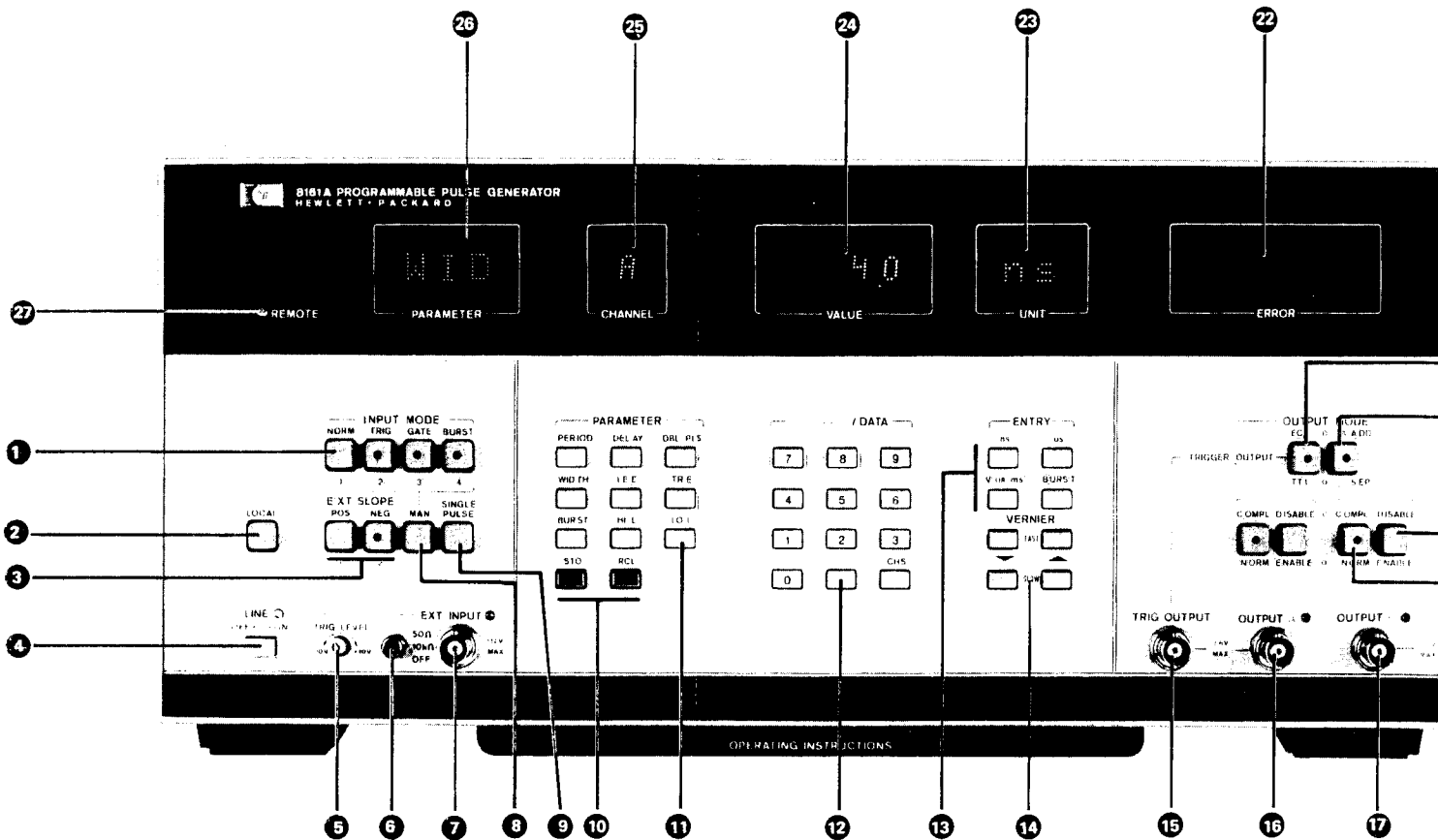

**1** Pushbutton selectors with built-in indicators that light when the input mode is selected. Modes are as follows:

- NORM — rate generator free-running
- TRIG — a trigger signal, either external or via the MAN pushbutton, initiates one output pulse.
- GATE — a gate signal, either external or via the MAN pushbutton, generates an output for as long as the gate is present.
- BURST — a burst trigger, either external or via the MAN pushbutton, initiates one pulse burst.

**2** RESET TO LOCAL is used when operating the 8161A via the HP-IB to reset the 8161A to local (front panel) control.

**3** The POS and NEG EXT SLOPE selector pushbuttons determine whether the 8161A triggers on the positive-going or negative-going slope of the external input signal. Built-in indicators light for the selected slope.

**4** LINE power on/off pushbutton with indicator lamp.

**5** TRIG LEVEL enables the external input trigger level to be adjusted from +10 V to -10 V.

**6** 50  $\Omega$ /10 K $\Omega$ /OFF switch matches the external input to 50  $\Omega$  or 10 K $\Omega$  input impedance, or switches the external input off. An indicator shows when an external input signal is triggering the 8161A.

**7** BNC connector for external input signals.

**8** MAN pushbutton produces a trigger pulse each time it is pressed in TRIG, GATE or BURST modes.

**9** SINGLE PULSE pushbutton initiates one output pulse each time it is pressed.

**10** STO and RCL enable complete operating sets to be stored or recalled as required. Up to 9 sets can be stored/recalled by pressing STO or RCL followed by the appropriate digit 1-9. RCL0 sets up a standard pulse output.

**11 12 13** PARAMETER, CHANNEL/DATA and ENTRY keys are used sequentially to change operating parameters. Changing pulse period or burst is a 3-step operation (parameter, data, entry). Changing all other parameters is a 3-step operation (parameter, data, entry) for the standard 8161A, and a 4-step operation (parameter, channel, data, entry) when option 020 is fitted.

**14** VERNIER keys enable all parameters to be varied.

**15** BNC connector providing TRIG OUTPUT signal.

**16 17** BNC connectors providing OUTPUT A & B signals. Indicators show when outputs are enabled.

Figure 3-1. 8161A Controls, Connectors and Indicators (instrument shown with option 020 fitted)

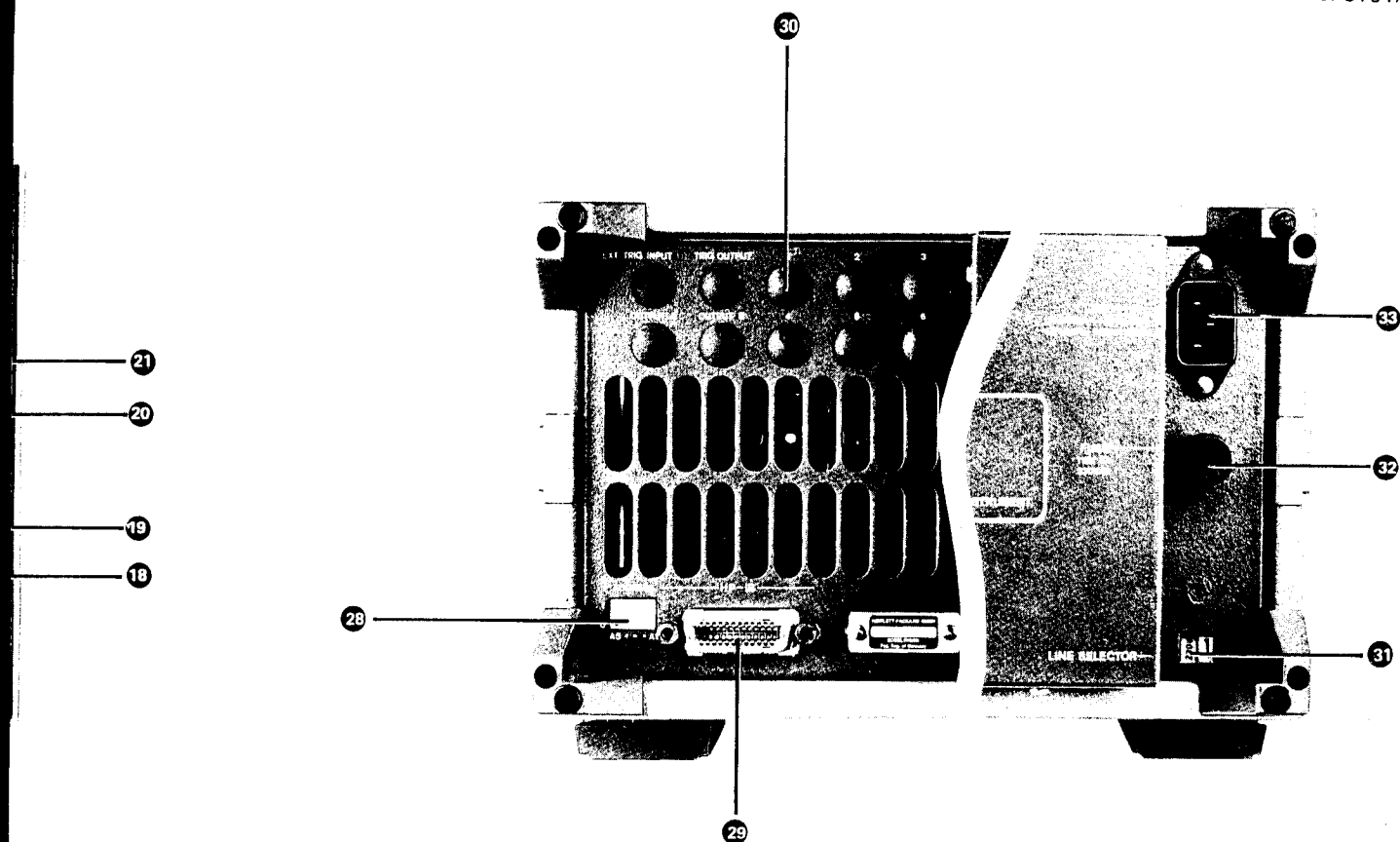

- 18** COMPL/NORM pushbutton selects normal or complement format for outputs A and B. A built-in indicator lights for complement.
- 19** DISABLE/ENABLE pushbutton disables or enables outputs A and B. A built-in indicator lights for disabled output.
- 20** A ADD B / A SEP B pushbutton adds outputs A and B in A ADD B mode. The combined outputs appear at output A. A built-in indicator lights when the outputs are added.
- 21** ECL/TTL pushbutton selects ECL or TTL compatible TRIG OUTPUT signal. A built-in indicator lights when ECL selected.
- 22** ERROR field indicates PARAM, TIMING, SLOPE and LEVEL errors.
- 23** UNIT field indicates the unit in which the currently displayed parameter is measured.
- 24** VALUE field indicates the numerical value of the currently displayed parameter.
- 25** CHANNEL indicates the channel whose parameters are currently being displayed.
- 26** PARAMETER indicates which parameter is currently being displayed.
- 27** REMOTE indicator shows when the 8161A is under the control of a system controller via the HP-IB.
- 28** HP-IB device address switch (5 bits, A 1 to A 5).
- 29** HP-IB connector.
- 30** INPUT/OUTPUT connectors mounted here (instead of front panel) with option 001.
- 31** LINE SELECT sliding switch to be set to local line voltage.
- 32** FUSE protects instrument in case of current overload. 4 A fuse to be used for 230 V operation. 8 A fuse to be used for 115 V operation.
- 33** LINE receptacle. power cord to be plugged in here. Chassis ground for operator protection provided through cord.



## SECTION III OPERATING AND PROGRAMMING

### 3-1 INTRODUCTION

3-2 This section explains the functions of controls, connectors and indicators, and provides operating and programming information.

### 3-3 SPECIAL OPERATING CONSIDERATIONS

3-4 The following steps must be taken before applying power to the Model 8161A.

- a) Read the safety summary at the front of this manual.
- b) Be sure the power selector switches are set properly for the power source being used to avoid instrument damage.

**WARNING**

*The power supply cover on the rear panel may be hot and could cause burns.*

**CAUTION**

*Do not change the LINE SELECTOR switch setting with the instrument on or with power connected to the rear panel.*

### 3-5 CONTROLS, CONNECTORS AND INDICATORS

3-6 Refer to Figure 3-1 for a brief explanation of all controls, connectors and indicators. Use figure 3-1 also for reference in the following operating instructions. Figure 3-2 shows an 8161A output pulse with all the parameters that are variable. The front panel mnemonics are given with each parameter to enable you to associate each control with the parameter it varies.

### 3-7 OPERATORS CHECKS

3-8 You can perform a rapid operational check on the 8161A by recalling the standard parameter set and checking the output.

### 3-9 OPERATING INSTRUCTIONS

3-10 Operating modes and parameters can be set using the front panel controls (local operations) or programmed using the HP-IB (remote operation). Local operation is explained in the following paragraphs. For remote operation refer to paragraph 3-68.

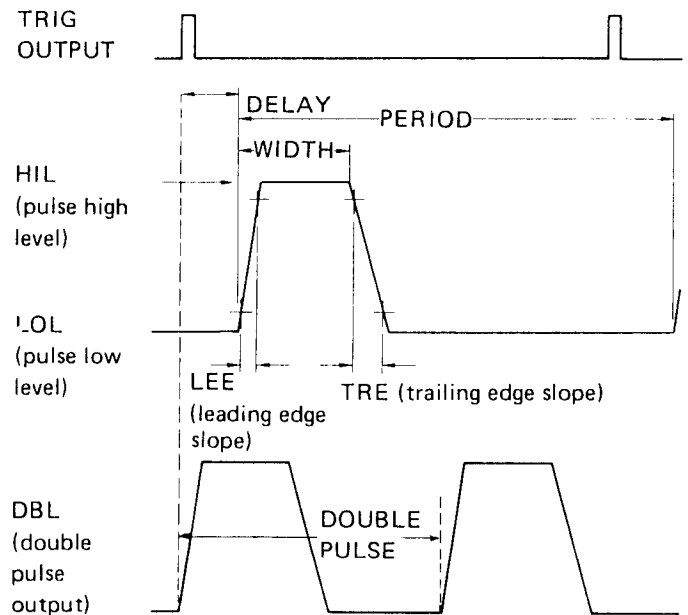

Figure 3-2. 8161A Variable Pulse Parameters

3-11 Commence by setting the LINE switch on and pressing the required DISABLE/ENABLE pushbuttons – channel A, B (if fitted) or both. The corresponding pushbutton lamps will go out and the appropriate channel output lamps go on, to indicate that the outputs are enabled. On single channel instruments the DUMMY LOAD switch (mounted on the front panel between the OUTPUT and OUTPUT connectors) should be set to the unused output. When both outputs are used then the switch must be set to the OFF (middle position).

3-12 The 8161A will automatically assume the operating state prevailing when it was switched off.

### 3-13 Error Indication

3-14 It is possible that while experimenting with different parameter settings you will get an error indication in the ERROR field. The error can be one of four types: PARAM, TIMING, SLOPE or LEVEL and means that you have attempted an invalid operation. For example you may have a TIMING error because you attempted to set a pulse width greater than the pulse period, or you may have a SLOPE error because you tried to set up a leading edge/trailing edge transition time ratio of greater than 20:1. The invalid setting will be accepted but will not be entered to the output until all error conditions have been removed. If you wish to start with an error-free parameter set, you can recall the standard parameter set by pressing keys RCL and 0 (see paragraph 3-47). To remove the error condition simply re-enter the parameter correctly.

3-15 In some instances the reason for the error indication may not be immediately apparent. This is particularly true when double pulse is active. To aid the user identify the error source in such cases, the following formulae, together with figure 3-3, are provided. These formulae are employed by the microprocessor to determine when an error indication is necessary.

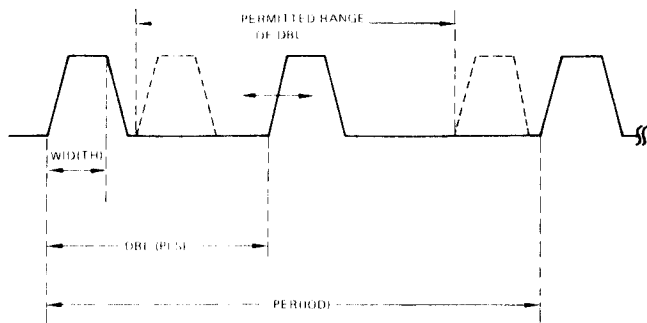

Figure 3-3. Double Pulse Limits

3-16 As can be seen from figure 3-3, there is a permitted 'time-zone' in which DBL may be programmed. Due to internal 8161A circuits, the minimum/maximum limits of this 'zone' vary according to three formulae, depending on the relative values of DBL, WID and PER. The 3 possibilities are:

- 1)  $DBL < 50 \text{ ns}$  in which case the following formula applies:

$$\frac{WID + 9 \text{ ns}}{0.96} \leq 0.94 \times PER - (WID + 9 \text{ ns})$$

- 2)  $DBL \geq 50 \text{ ns}$  and  $WID < 50 \text{ ns}$ , in which case the following formula applies:

$$\frac{WID + 9 \text{ ns}}{0.96} \leq DBL \leq \left[ \begin{array}{l} 0.94 \times PER - (WID + 9 \text{ ns}) \\ \text{or} \\ 0.94 \times PER - 31 \text{ ns} \end{array} \right]$$

\* of these 2 formulae, the one which provides the smaller value for the prevailing parameters is decisive.

- 3)  $DBL \geq 50 \text{ ns}$  and  $WID \geq 50 \text{ ns}$ , in which case the following formula applies:

$$\frac{WID + 31 \text{ ns}}{0.96} \leq DBL \leq 0.94 \times PER - (WID + 31 \text{ ns})$$

Whenever an error indication occurs in double pulse mode, the user should observe his programmed values for DBL and WID to see which of the above formulae apply.

3-17 There are combinations of pulse parameters for which the 8161A will indicate SLOPE error, but will nevertheless accept and enter the parameters to the output. This occurs when the leading edge (LEE) or trailing edge (TRE) is increased to the point where it is incompatible with other parameters e.g. LEE programmed greater than width (WID). (NOTE: This error is 'allowed' only so long as the values for LEE and TRE are within the maximum 20:1 ratio). Using this operation feature, triangular waveforms, as well as complex waveforms in double pulse mode, can be generated.

3-18 As with DBL programming, the microprocessor employs certain formulae to determine when this allowable SLOPE error indication should be given. An explanation of these formulae, together with illustrative aids, is given in the following paragraphs.

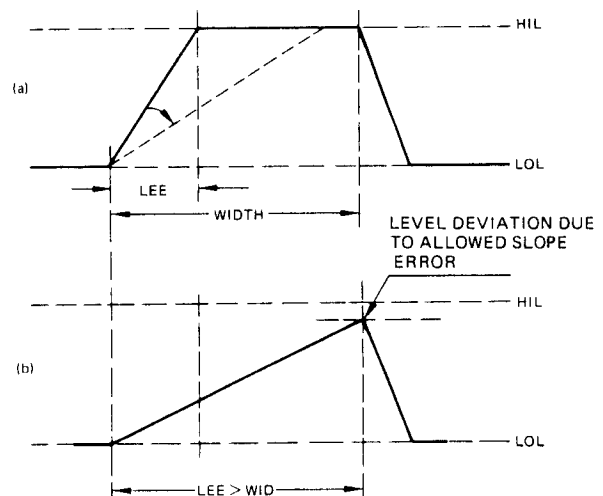

Figure 3-4. Leading Edge/Width (Delay active)

3-19 Figure 3-4 (a and b) illustrates the case when the leading edge is increased to the point where it is equal to or greater than the programmed width (WID) value. SLOPE error indication is given when the conditions for either of the following 2 formulae are met; the first applied to range 1 (see Figure 3-9 – Slope Generator Ranges), and the second to all other ranges:

- 1) Range 1 (1 ns to 4.9 ns)  

$$LEE > \frac{WID}{1.4} - 1 \text{ ns}$$
  - 2) Other ranges  

$$LEE > \frac{WID}{2}$$
- (both formulae apply for either DEL or DBL active)

As can be seen from Figure 3-4 (b), as LEE is increased beyond the WID value, the actual high level at the 8161A output, no longer corresponds to the programmed high level (HIL).

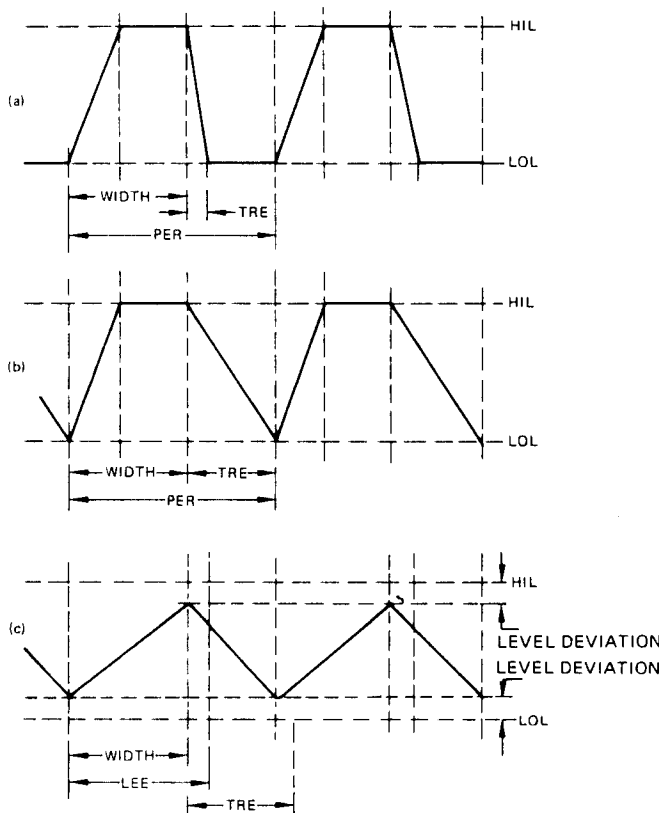

Figure 3-5. Trailing Edge/Period/Width (Delay Active)

3-20 Figure 3-5 (a and b) illustrates the case when DEL is active and the trailing edge (TRE) is increased to the point where the sum of width and trailing edge times is equal to or greater than the period (PER). SLOPE error indication is given when:

$$TRE > \frac{(0.94 \times PER) - WID}{1.4} - 0.7 \text{ ns}$$

Should the sum of trailing edge and width times be greater than the period, the actual low level at the output no longer corresponds to the programmed LOL value. Figure 3-5 (c) illustrates the possible output waveform for a combined leading edge and trailing edge SLOPE error.

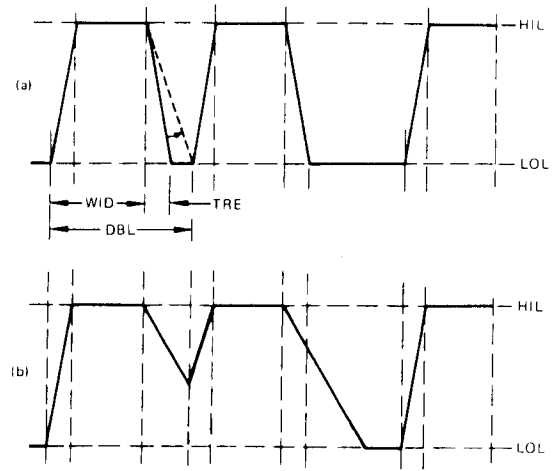

Figure 3-6. Trailing Edge/Double Pulse/Width

3-21 Figure 3-6 (a and b) illustrates the case when DBL is active and the trailing edge (TRE) is increased to the point where the sum of width (WID) and trailing edge (TRE) times is equal to or greater than the programmed DBL time. SLOPE error indication is given when:

$$TRE > \frac{(0.96 \times DBL) - WID}{1.4} - 0.7 \text{ ns}$$

Should the sum of width and trailing edge times exceed the period, then the actual low level **within the pulse-pairs** no longer corresponds to the programmed LOL value (see Figure 3-6 (b)).

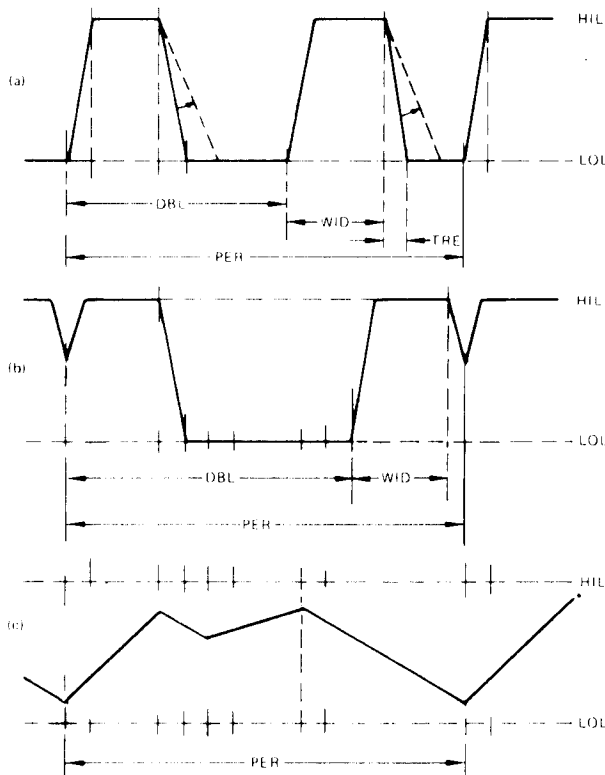

Figure 3-7. Trailing Edge/Double Pulse/Width/Period

3-22 Figure 3-7 (a and b) illustrates the case when DBL is active and the trailing edge (TRE) is increased to the point where the sum of the trailing edge (TRE), width (WID) and double pulse (DBL) times is equal to or greater than the programmed period (PER). SLOPE error indication is given when:

$$TRE > \frac{(0.94 \times PER) - (DBL+WID)}{1.4} - 1.1 \text{ ns}$$

Should the sum of trailing edge (TRE), width (WID) and double pulse (DBL) times exceed the period, then the actual low level **between consecutive pulse-pairs** no longer corresponds to the programmed LOL value (see Figure 3-7 (b) ). Figure 3-7 (c) illustrates a double pulse waveform modified by all the allowable slope errors just described.

### 3-23 NORM Input Mode

3-24 The pushbuttons in the left hand section of the front panel determine the gate/trigger to which the 8160A output is synchronized. One of the four pushbuttons NORM, TRIG, GATE or BURST will be lit to indi-

cate the current input mode. The mode you require initially is NORM so if the 8161A is not already in this mode, press NORM (see paragraph 3-58) for the other input modes). This means that the internal rate generator is free-running and provides the rate stimulus for the output (figure 3-8 shows example).

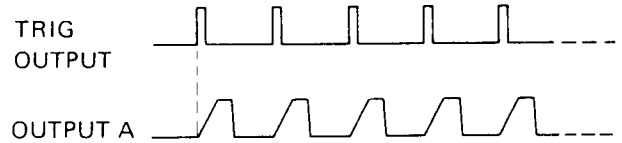

Figure 3-8. Normal Mode

### 3-25 Parameters

3-26 The keyboard in the centre section of the front panel is used to enter all pulse parameters. You press one of the nine grey PARAMETER keys on the left-hand side first to determine which parameter to set-up:

- |                                 |  |   |
|---------------------------------|--|---|
| <input type="checkbox"/> PERIOD | <input type="checkbox"/> DELAY                       | <input type="checkbox"/> DBL PLS<br>(double pulse)    |
| <input type="checkbox"/> WIDTH  | <input type="checkbox"/> LEE (pulse<br>leading edge) | <input type="checkbox"/> TRE (pulse<br>trailing edge) |
| <input type="checkbox"/> BURST  | <input type="checkbox"/> HIL (pulse<br>high level)   | <input type="checkbox"/> LOL (pulse<br>low level)     |

3-27 Start by pressing PERIOD. The display will now show PER (blinking) in the PARAMETER field; nothing in the CHANNEL field; the current period value in the VALUE field; and the current time unit in the UNIT field. The parameter field blinks until the new period value and unit have been entered and accepted.

3-28 You can now enter the new period data in the centre section of 12 grey CHANNEL/DATA keys, e.g. 732. This value will appear in the display VALUE field.

3-29 Now complete the parameter by assigning a unit from the right-hand section of four grey ENTRY keys e.g. ms. This unit will appear in the display UNIT field and the PARAMETER field will stop blinking to indicate that the new parameter has been accepted as valid.

3-30 Thus setting up a new period parameter was a three-step operation; parameter, data, entry. The same applies for changes to the burst parameter e.g. enter PARAMETER key - BURST, DATA keys - 99, ENTRY key - BURST. However, because all other parameters are independently variable for each channel, should option 020 be fitted, parameter changing becomes a four-step operation; parameter, channel, data, entry. (For standard 8161A, only 3 steps are required for any parameter change).

3–31 As an example press PARAMETER key – WIDTH, CHANNEL/DATA key – A, CHANNEL/DATA keys – 126, and ENTRY key – ms. You have now set the pulse width of channel A to 126 ms. You can change parameters DELAY, DBL, PLS, LEE, TRE, HIL and LOL in the same way.

3–32 If you want to check any parameter, simply press the required PARAMETER and, where appropriate, CHANNEL keys and the value will be displayed.

**3–33 Delay/Double Pulse Parameters**

3–34 The 8161A can operate with either delay active (variable delay time between trigger and output pulse) or double pulse active (a second pulse following every output pulse with variable delay between the two) but not both. There is, therefore, a facility built in to the instrument that tells you which of the two is currently selected. If you press PARAMETER key – DELAY, CHANNEL/DATA key (where appropriate) – A or B and the PARAMETER field of the display shows DEL<sup>+</sup>, the <sup>+</sup> tells you that delay is not active (double pulse is selected). If you wish to select pulse delay, simply enter the delay parameter as already described and the <sup>+</sup> will disappear indicating that delay is now active and not double pulse. If you now press PARAMETER key – DBL PLS, DBL<sup>+</sup> will appear in the display.

**3–35 Vernier Keys**

3–36 A set of four VERNIER keys acts as a common vernier for all parameters.

3–37 Press PARAMETER key – WIDTH, CHANNEL/DATA key – A and then VERNIER key SLOW ▼. If you press and release the key, the channel A pulse width will decrement by one step in the last digit. If you hold the key down, after about one second the pulse width will start to decrement continuously. If you press and release FAST ▼ the pulse width will decrement by one step in the next-to-last digit. If you hold the key down, after about one second the pulse width will start to decrement continuously in large steps. The same applies for SLOW and FAST ▲ except that the chosen parameter increments rather than decrements.

3–38 The vernier is active for whichever parameter is currently displayed without having to press the PARAMETER key first, except:

- a) after switch-on, store and recall.

- b) when using the vernier with delay or double pulse parameters, the required parameter must first be made active by entering the unit (see paragraph 3–33) before the vernier can be used.

3–39 If you attempt to generate an incompatible setting whilst using the vernier keys, in all cases except one the parameter will stop at its valid limit. The one exception is when you exceed the leading/trailing edge transition time max. ratio of 20:1 (i.e. ratio limit within a range). The 8161A slope generator is designed in 6 ranges, 5 overlapping and 1 non-overlapping (see Figure 3–9).

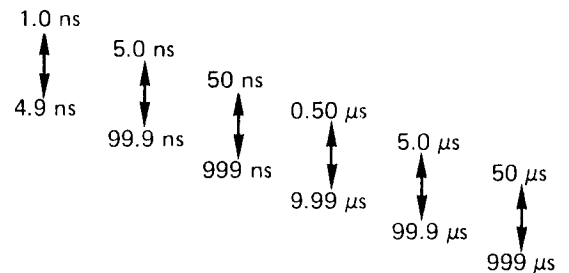

Figure 3–9. Slope Generator Ranges

3–40 For all ranges except the first (1 ns – 4.9 ns), provided that both transition times are within the same 20:1 range, they are independently adjustable. If, however, one pulse edge is adjusted into the next range using the vernier, the other edge steps to within the limit of the same range.

Range 1 is dealt with in 3–42.

3–41 As an example, suppose that you have set up a pulse leading edge of 50 ns and you increase the trailing edge time above 999 ns. The trailing edge vernier will continue to increment without showing an error, but the leading edge time will jump by a factor of 10, i.e. to 500 ns. Thus both edges are now in the fourth range. Note, however, that if you now decrement the trailing edge using the vernier, the leading edge will not jump back to 50 ns until the trailing edge is reduced below 500 ns.

3–42 If either the leading or trailing edge is set within the first range, the other edge will automatically here the same value, i.e. no difference between LEE and TRE is possible for values between 1 ns and 4.9 ns. This applies whether the setting of either edge is made via the keyboard, program or by vernier adjustment to below 5 ns.

Different procedures are necessary when stepping into or out of the range, as shown by the following examples:

a) If the initial settings for LEE and TRE are 50 ns and 99 ns respectively and then TRE is changed to 2.5 ns i.e. within range 1, then LEE will also change to the new value. You cannot, however, move out of range 1 by the reverse procedure, this must be done as follows:

b) First, one of the edges must be set at the required new value (e.g. 50 ns); a SLOPE ERROR signal will now be displayed (but not if the change is made by vernier adjustment as described in paragraph 3-41). Only when the second edge is set within the same range will the error signal disappear and the values be entered to the output.

	CH A	CH B
Input mode	← NORM →	
Slope	← POS →	
Period	← 1 μs →	
Burst	← 10 bt →	
Delay (active)	100 ns	0 ns
Width	100 ns	5 ns
Double pulse (not active)	200 ns	8 ns
Leading edge	10 ns	1 ns
Trailing edge	10 ns	1 ns
High level	1.0 V	1.0 V
Low level	0 V	0 V
Output	A SEP B*	
Trigger level	← TTL →	
Normal output	AN	BN
Output status	DIS	DIS

\* Not applicable for single channel instruments

### 3-43 Store and Recall

3-44 Using the STO (store) and RCL (recall) keys in conjunction with data keys 1-9 it is possible to store parameter sets for 9 output waveforms, and then to recall any of them as the current output. Note that the store function is not possible while an error condition exists or while the keyboard is active.

3-45 Set up a pulse output as previously explained then press STO and data key 1. Now change the parameters of the pulse and press STO 2.

3-46 If you now press RCL 1, the first set of parameters will be recalled. Press RCL 2 and the second set of parameters will be recalled. Up to 9 sets can be stored using STO 1-9 and recalled using RCL 1-9.

### 3-47 Standard Parameter Set

3-48 In addition to the storage locations for user waveforms there is an extra storage location that contains a standard parameter set. This parameter set can be recalled as the current output by pressing RCL followed by data key 0 (note that you can't store any other parameter in this location). The parameters of the standard pulse are as follows:

3-49 The standard parameter set is automatically recalled at switch-on if the 8161A has been switched off for an extended period and the memory contents are no longer valid. The display shows the period of 1.00 μs together with PARAM in the ERROR field to inform you that the other memory locations contain random data. This feature prevents pulses with random parameters from being output.

3-50 The standard parameter set can also be recalled as a simple operator check that the instrument is working correctly.

### 3-51 Output Modes

3-52 Output modes for channels A and B are controlled by six pushbuttons on the right-hand side of the front panel. If the 8161A only contains channel A, the controls for channel B are still fitted but are ineffective.

3-53 A ADD B / A SEP B pushbutton adds together the channel A and channel B signals (if both enabled) and outputs them at OUTPUT A when the pushbutton is lit; the OUTPUT B lamp is unlit. In the A SEP B mode, the two channels are output separately.

3-54 CHANNEL A DISABLE/ENABLE pushbutton disables output A when lit (OUTPUT A lamp unlit).

3-55 CHANNEL A COMPL/NORM pushbutton complements OUTPUT A when lit.

3-56 CHANNEL B COMPL/NORM and DISABLE ENABLE pushbuttons perform for channel B the same function as described for channel A above.

3-57 ECL/TTL pushbutton produces an ECL level trigger signal at TRIGGER OUTPUT when lit or a TTL level signal when unlit.

### 3-58 TRIG/GATE/BURST Input Modes

3-59 An oscilloscope is necessary to check the operating of the TRIG (trigger), GATE and BURST input modes. In all three modes you can generate the trigger/gate signal using an external signal applied to the EXT INPUT connector, or using the MAN (manual) pushbutton, or via the HP-IB using a program instruction.

3-60 If you have an external input to generate the trigger/gate signal, you can adjust the triggering threshold of the external input from -10 V to +10 V using a trimpot on the front panel. You can also match the trigger source impedance to the external input using the 50 Ω / 1 kΩ switch. Set the switch to OFF if you are not using the external input, or using the MAN pushbutton.

3-61 An LED next to the external input lights whenever a trigger/gate signal (generated externally, manually or via HP-IB) occurs to inform you that a signal is present and is triggering/gating the 8161A.

### 3-62 Trigger Mode

3-63 In this mode the trigger signal initiates one complete output cycle (figure 3-10). The delay, width, transition times and output levels of the signal are determined by the 8161A settings.

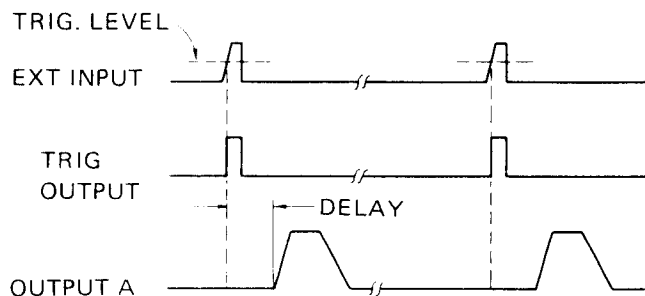

Figure 3-10. Trigger Mode

### 3-64 Gate Mode

3-65 In this mode the leading edge of the gate signal enables the rate generator synchronously and the gate trailing edge disables the rate generator. The first and last output pulses are always complete (figure 3-11).

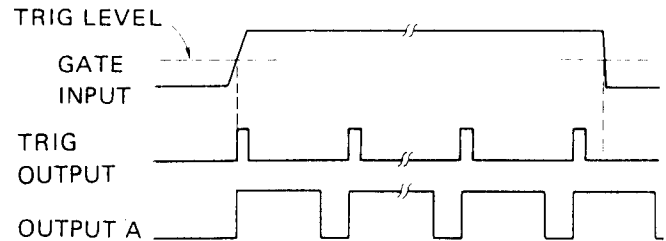

Figure 3-11. Gate Mode

### 3-66 Burst Mode

3-67 In burst mode a preset number of output pulses is generated with each trigger signal (figure 3-12). The burst length can be set between 1 and 9999 pulses either from the front panel or via the HP-IB. When operating from the front panel the burst length is set up as follows:

press PARAMETER key – BURST

press the required DATA keys to enter the burst length. The number will appear on the display.

press the ENTRY key – BURST.

The 8161A is now in burst mode with the burst length set. You can now trigger the burst as already described.

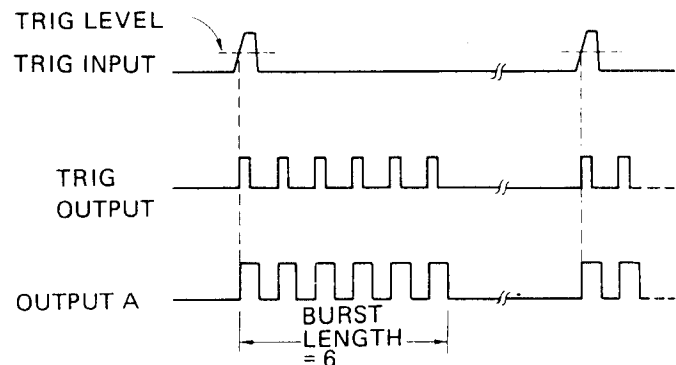

Figure 3-12. Burst Mode

### 3-68 PROGRAMMING INSTRUCTIONS

3-69 The 8161A operates on the HP-IB as follows:  
**listens** to messages from the HP-IB system controller by means of which all 8161A operating parameters and modes can be programmed; access time (the time between program command and the implementation at the 8161A output) is 20 ms,  
**talks**; provides error messages and reports operating or stored parameters.

3-70 The bus lines are as follows (all use negative logic):

- 8-bit data bus** (lines DIO 1 to 8),
- handshake lines** – DAV (data valid), NRFD (not ready for data), NDAC (data not accepted),
- control lines** – IFC (interface clear), ATN (attention), SRQ (service request), REN (remote enable), EOI (end or identify).

The 8161A uses all lines except EOI. Terminations, logic levels and pinouts are described in Section II. In this manual, bus information will generally be restricted to 8161A specifics, for this reason, the handshake lines will not be discussed and the control lines will only be mentioned in connection with specific 8161A activity.

Permissible codes are presented in Table 3-8. For more bus information, refer to the condensed description in HP publication 59401-90030 and to IEEE Standard 488.

3-71 To use the 8161A on the bus, remote control must be implemented. This is done by setting the REN line true. A return to local control can be made manually (LOCAL RESET button), by sending the command GTL (go to local), or by setting REN false. Refer to § 3-79).

### 3-72 Addressing

Table 3-1. Available Addresses (ATN true)

Data bus (DIO lines)		Address in ASCII		
Fixed 8 7 6	Selectable 5 4 3 2 1	Talk	Listen	
0 T L	0 0 0 0 0	@	Space	
0 T L	0 0 0 0 1	A	!	
0 T L	0 0 0 1 0	B	"	
0 T L	0 0 0 1 1	C	#	
0 T L	0 0 1 0 0	D	\$	
0 T L	0 0 1 0 1	E	%	
0 T L	0 0 1 1 0	F	&	
0 T L	0 0 1 1 1	G	'	
0 T L	0 1 0 0 0	H	(	
0 T L	0 1 0 0 1	I	)	
0 T L	0 1 0 1 0	J	*	
0 T L	0 1 0 1 1	K	+	
0 T L	0 1 1 0 0	L	,	
0 T L	0 1 1 0 1	M	-	
0 T L	0 1 1 1 0	N	.	
0 T L	0 1 1 1 1	O	/	
0 T L	1 0 0 0 0	P	0	
0 T L	1 0 0 0 1	Q	1	← 8161A set to this address at factory (17 Dec)
0 T L	1 0 0 1 0	R	2	
0 T L	1 0 0 1 1	S	3	
0 T L	1 0 1 0 0	T	4	
0 T L	1 0 1 0 1	U	5	← Usually controller address!
0 T L	1 0 1 1 0	V	6	
0 T L	1 0 1 1 1	W	7	
0 T L	1 1 0 0 0	X	8	
0 T L	1 1 0 0 1	Y	9	
0 T L	1 1 0 1 0	Z	:	
0 T L	1 1 0 1 1		:	
0 T L	1 1 1 0 0	\	<	
0 T L	1 1 1 0 1		=	
0 T L	1 1 1 1 0	>	>	Forbidden setting! UNT, UNL commands.
0 T L	1 1 1 1 1	^	? ←	

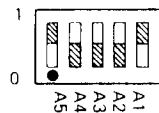

Selector on 8161A rear panel (factory setting)

L = 1 for listen address, 0 for talk address  
 T = 1 for talk address, 0 for listen address

3-73 Talk and listen addresses are transmitted by the system controller over the data bus with the ATN line true. When an instrument recognizes its address, it will adopt the appropriate bus mode (i.e., it will listen to the bus if its listen address has been transmitted, talk if the talk address has been transmitted). The 8161A's addresses are selected by a switch on the rear panel from the possibilities presented in Table 3-1. When allocating addresses, make sure no two instruments have the same address. When programming an address, set ATN true and arrange that the ASCII character derived from Table 3-1 appears on the bus. To deaddress, use UNL, UNT commands (or address another device as talker).



Table 3-2. Mode and Parameter-setting Messages (ATN false)

Message	Serial ASCII bytes	Comments
Input modes		
select normal	11	
select trigger	12	Trigger message (Table 3-3) can be used
select gate	13	
select burst	14	Trigger message (Table 3-3) can be used
External slope		
positive	E1	
negative	E2	
Parameters		
set period	PER	9 NS – 999 MS
set delay	DEL †	0 NS – 999 MS
set double pulse	DBL †	6.6 NS – 999 MS
set width	WID †	3 NS – 999 MS
set leading edge	LEE †	1 NS – 9.99 MS
set trailing edge	TRE †	
set high level	HIL †	-5.05 V ≤ HIL ≤ 5.10 V
set low level	LOL †	-5.10 V ≤ LOL ≤ 5.05 V
set burst	BUR	0-9999 pulses
Channel		
A	A	must not be specified in one channel instrument
B	B	
Unit		
nanoseconds	NS	
microseconds	US	
milliseconds	MS	
burst entry	BT	
volts	V	
Output mode		
A add B	AA	Only effective if channel B is fitted (option 020)
A sep B	AS	
disable both outputs	DI	Provide the same function (disable/enable output A) if no channel B fitted.
enable both outputs	EN	
A disable	AD	Only effective if channel B is fitted (option 020).
A enable	AE	
B disable	BD	Only effective if channel B is fitted (option 020).
B enable	BE	
A complement	AC	
A normal	AN	
B complement	BC	Only effective if channel B is fitted (option 020)
B normal	BN	
Trigger output ECL	EC	
Trigger output TTL	TT	

† For two channel instruments the channel must be specified when programming these parameters.

Examples:

Parameter	Channel	Unit
DEL	A	500NS
HIL	A	1.5 V
BUR		64

Table 3-2 (cont'd)

Message	Serial ASCII bytes	Comments
Sign - +	- +	
Decimal point .	.	
Memory store current operating modes and parameters in 8161A store location 'n'	STO 'n'	n is an integer 1-9
recall and adopt parameters in store location 'n'	RCL 'n'	n is an integer 0-9
		See § 3-43
<b>NOTES</b> <i>Lower case letters can replace any or all of the ASCII capitals.                      The order in which parameters are programmed is not significant. (but consideration should be taken of SRQ - see § 3-84).                      Spaces are not essential.</i>		

**3-74 Mode and Parameter Setting**

3-75 When the 8161A has been listen addressed, it will be prepared to accept messages which will change a parameter or its operating mode. Each mode and parameter-setting message consists of a number of ASCII data bytes transmitted serially over the data lines with ATN false. The coding for the bytes is given on the front panel and also shown in Table 3-2 which summarizes all mode and parameter-setting messages, and provides an example. Reference may be made to Table 3-5 to convert each ASCII byte to a bit pattern on the data bus.

**3-76 Control Messages and Commands**  
(Table 3-3)

**3-77 Programmed Trigger**

3-78 When the 8161A is in trigger or burst modes, a trigger message (GET) will initiate a single cycle or a burst.

**3-79 Local, Remote and Local Lockout**

3-80 When in remote, the 8161A's LOCAL RESET button can be inhibited by the local lockout command. To cancel local lockout, send GTL (go to local) or set the REN line false (or the 8161A may be switched off and on again at the LINE switch).

**3-81 Learn Mode**

3-82 When the 8161A is addressed as a talker after receiving the 'SET': message, it will output its current operating parameters to the bus (same coding as in Table 3-2). The message 'SET n' accesses addressable memory n (where n is an integer 0-9). In neither case are the store contents changed in any way. SET 0 will return the standard parameter set (see § 3-47).

Table 3–3. Control Messages and Commands

Message/Command	8161A	Serial ASCII bytes or ASCII character	Comments
Trigger (GET)	Listen	BS *	ATN true
Remote control	—	—	REN true
Local lockout (LLO)	Listen	DC1 *	ATN true
Cancel local lockout	—	—	REN false
Go to local (GTL)	Listen	SOH *	ATN true
Give current operating parameters	Listen Talk	SET: 8161A transmits operating state, codes as Table 3–5	ATN false
Give parameter set in location n	Listen Talk	Set <i>n</i> 8161A transmits stored state, codes as Table 3–5	<i>n</i> an integer 0–9
Service request	Listen	—	8161A sets SRQ true
Serial poll (SPE)	Talk	CAN * 8161A transmits error message: DIO 7 true if 8160A has set SRQ true, DIO 7 false if SRQ false (or SRQ set true by other instrument). Other bits: see Table 3–4	
		8161A clears SRQ when transmission completed.	
Serial poll disable (SPD)		EM *	Controller disables SPE.

\* Single ASCII character, 1 byte only.

### 3–83 Error Reporting

3–84 In the event of a program attempting to put the 8161A into an error condition, the 8161A will remain in its previous operating condition (except for particular transition time errors — see paragraphs 3–17 to 3–22) and make a service request, i.e. set SRQ line true. Under these circumstances the system controller will normally respond by addressing the 8161A as a talker using a serial poll command (SPE). The 8161A will then place a status byte message on the data bus. The contents of this byte are shown in Table 3–4.

**Note:** An invalid SRQ can occur in character strings where more than one parameter is programmed. The reason is best explained by an example: e.g. current operating parameters of the 8161A include 1 ms width and 2 ms period. A character string then arrives which first attempts to re-program the width to 3 ms and then re-program to period to 4 ms. Immediately upon receiving the new width value, the 8161A sets SRQ true because this value is not compatible with the **current** period. Then when the new period arrives to validate the new width, **both** new values will be accepted by the 8161A and SRQ de-activated. Therefore SRQ can only be considered valid when it occurs at the end of a character string.

Table 3-4. Status Byte

Message Value	DIO 8	SRQ DIO 7	Status Bits		
			DIO 6	DIO 5	DIO 4 – DIO 1
0	not	Not Service Request	X	not	X X X X
1	used	Service Request	X	used	X X X X

DIO 6 '0' = allowed error  
DIO 6 '1' = unallowed error

Status Bits	Meaning	Description
6 4 3 2 1		
0 0 0 0 0	Syntax error	This type of error can only occur from an incorrect character sequence when programming the 8161A via the HP-IB.
0 0 0 0 1	Parameter error	a) The desired parameter or channel does not exist. b) You attempt to STO 0. c) You attempt to RCL n (n = 1 to 9) when the desired memory location contains invalid data.
0 0 0 1 1	Slope error (allowed)	The leading the trailing edge slopes are still within the same range but are excessively long and cause a loss of amplitude (see 5 3-17 to 3-22).
1 0 0 1 0	Timing error	a) Period, delay, width or double pulse settings that are out of the 8161A's range *. b) Period, delay, width or double pulse settings that are incompatible with one another.
1 0 0 1 1	Slope error (unallowed)	a) A pulse with leading or trailing edges that are out of the 8161A total range. * b) A pulse with leading and trailing edges that are in different slope ranges (see 5 3-39).
1 0 1 0 0	Level error	a) An output with high (HIL) or low (LOL) levels that are out of the 8161A's range *. b) An output with high and low levels that are spaced too far apart or too close.

\* These errors will only be reported if the parameter is programmed alone, or if within a string it has the last position.

### 3-85 Error Recovery

3-86 It is important to realize that the 8161A status byte will show only one error, even if more than one error has occurred.

3-87 In the case of unallowed errors, the invalid parameters must be corrected before the new data output can be executed.

3-88 Thus when an error occurs you may have to repeat the whole data string to be sure that all errors have been eliminated and the new data will be executed.

3-89 With 2-channel instruments it is also important to remember that while changing data for channel A, you can cause an error in channel B, e.g. if you change period for channel A, it also changes for channel B.

### 3-90 PROGRAMMING EXAMPLES

3-91 A selection of programming examples, written in two languages, executable by a variety of desktop computers (four models covered) and extending over a wide selection of tasks is given in the Program Examples section.

Notice should be taken of the required address switch settings of the instruments and the test set-up/system interconnection requirements.

The programs, although controller and/or language biased, are designed to show the versatility of the 8161A in various modes and should not be considered as limiting the instrument's usage to such hardware or software.

Table 3-5. Code Assignments (ASCII) for the 8161A

DATA MODE  
(ATN FALSE)

APPLIES ONLY IN COMMAND MODE (ATN TRUE)  
THESE CHARACTERS CAUSE SRQ  
THESE CHARACTERS ARE IGNORED

b <sub>7</sub> b <sub>6</sub> b <sub>5</sub> Bits	0				1				2				3				4				5				6				7															
	b <sub>4</sub>	b <sub>3</sub>	b <sub>2</sub>	b <sub>1</sub>	b <sub>4</sub>	b <sub>3</sub>	b <sub>2</sub>	b <sub>1</sub>	b <sub>4</sub>	b <sub>3</sub>	b <sub>2</sub>	b <sub>1</sub>	b <sub>4</sub>	b <sub>3</sub>	b <sub>2</sub>	b <sub>1</sub>	b <sub>4</sub>	b <sub>3</sub>	b <sub>2</sub>	b <sub>1</sub>	b <sub>4</sub>	b <sub>3</sub>	b <sub>2</sub>	b <sub>1</sub>	b <sub>4</sub>	b <sub>3</sub>	b <sub>2</sub>	b <sub>1</sub>	b <sub>4</sub>	b <sub>3</sub>	b <sub>2</sub>	b <sub>1</sub>	b <sub>4</sub>	b <sub>3</sub>	b <sub>2</sub>	b <sub>1</sub>								
	0	0	0	0	0	0	0	1	0	1	0	0	0	1	0	1	1	0	0	0	1	0	0	1	1	0	1	0	1	1	0	0	1	1	0	1	1	1	0	1	1	1	1	1
					NUL				LLO				SP																															
					SOH			GTL									A				P																							
					STX												B				R																							
					ETX												C				S																							
					EOT												D				T																							
					ENQ												E				U																							
					ACK																V																							
					BEL																W																							
					BS			GET	SPE								H																											
					HT				SPD								I																											
					LF																																							
					VT																																							
					FF												L																											
					CR												M																											
					SO												N																											
					SI												O																											

ADDRESS  
COMMAND  
GROUP  
(ACG)

UNIVERSAL  
COMMAND  
GROUP  
(UCG)

LISTEN  
ADDRESS  
GROUP  
(LAG)

TALK  
ADDRESS  
GROUP  
(TAG)

MODE AND PARAMETER MESSAGES (COLUMN 6 IS INTERPRETED BY 8161A IN SAME WAY AS COLUMN 4, COLUMN 7 AS COLUMN 5). ATN FALSE

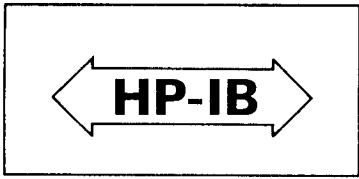

# PROGRAM EXAMPLES

# BASIC HPL

## INTRODUCTION

These examples are an introduction to remote programming of the 8161A Programmable Pulse Generator. The basic requirements for programming are discussed including system connection. The examples are written in 2 programming languages – BASIC and HPL and a step by step explanation of each program is given. The programs range in complexity from a simple one line instruction to a complete error test.

- PROGRAM 1: Operating Verification
- PROGRAM 2: Programming
- PROGRAM 3: Learn Mode
- PROGRAM 4: Period Measurement
- PROGRAM 5: Delay Measurement
- PROGRAM 6: Level Measurement
- PROGRAM 7: Error Message Test

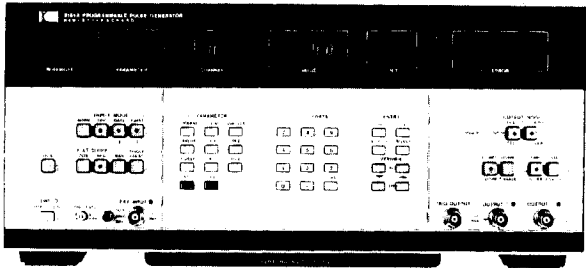

The 8161A has the HP-IB as standard fitment so enabling remote control and programming of the instrument as required. The interface capability of the 8161A is defined in accordance with IEEE Standard 488–1978.

## EQUIPMENT REQUIRED

In order to perform all the examples the following equipment (depending on the controller available and the language preferred) is required:

Controller and peripheral devices:

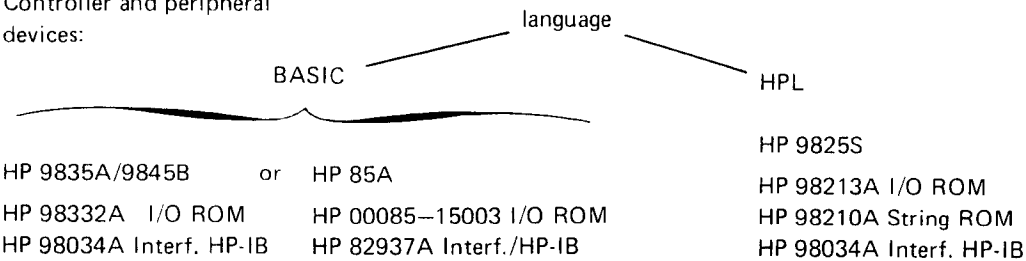

General:

- Counter HP 5345A
- DVM HP 3437A
- Cable assembly (2) HP 11170C
- Cable assembly HP 11172A
- or adapter HP 1250–059
- 50 Ω feedthrough termination HP 10100C

## SET-UP AND CHECK-OUT

Figure 1 shows the complete system connection and switch settings for the 8161A and 98034A Interface Card.

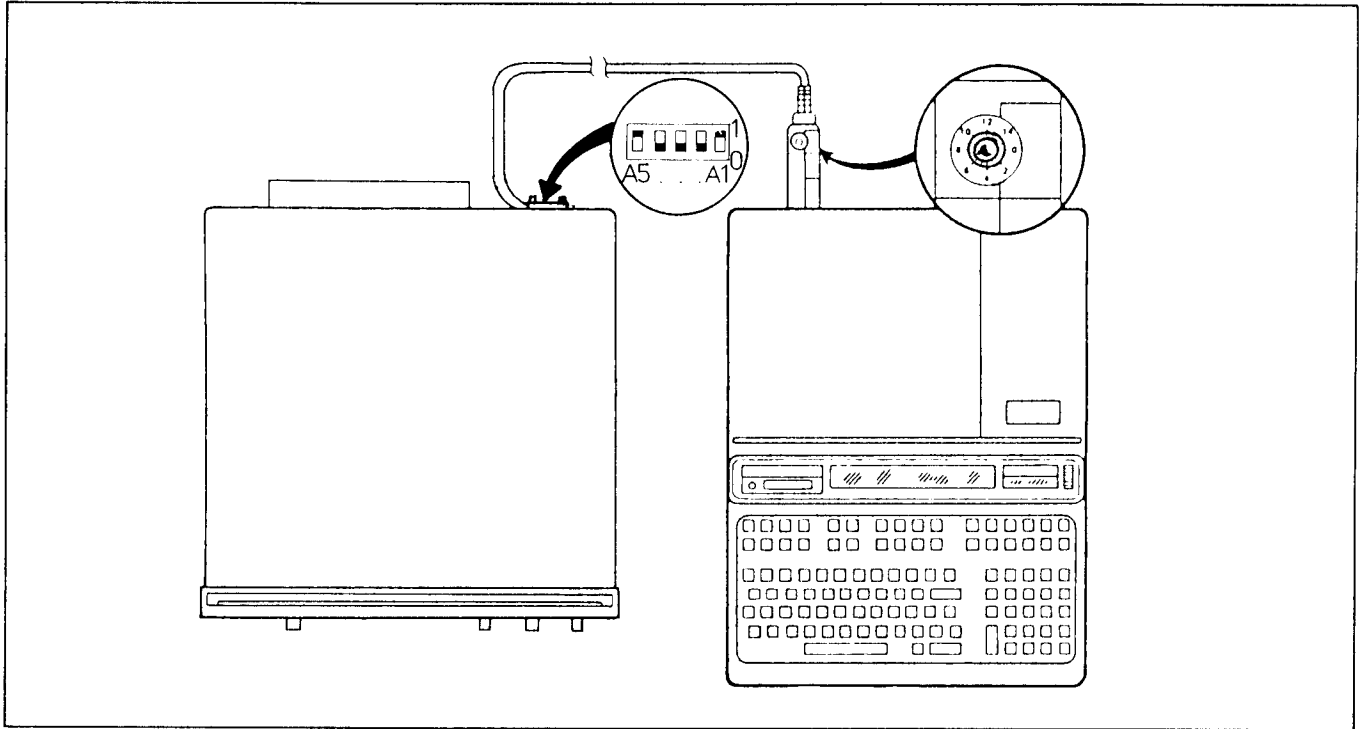

Figure 1. System Connections and Switch Settings

Perform the following steps:

- I. With all power disconnected from the calculator, verify that the corresponding ROM's are installed.
- II. On the 98034 Interface Card, verify that the rotatory switch on the top is set to "7". Seven will then be the select code for the interface card and the bus address for all programs found in this guide.
- III. Connect the 24-pin connector at the end of the 98034A cable to the 8161A pulse generator.
- IV. Facing the rear panel of the 8161A, note the 5 small slide switches to the left of the HP-IB connector. These are the Address switches.
- V. The address of the 8161A is set to "17" in the factory. If your program need's a different address change the switches accordingly. Do not use "21" as this is, usually the controller address.

Switch	A5	A4	A3	A2	A1
position					
binary	1	0	0	0	1
decimal	16	0	0	0	1

Figure 2. Setting address switches



# PROGRAM 1

# HP-IB

# HPL

## OPERATING VERIFICATION

This program enables verification of system connections.

Program 1 describes a simple way of sending data from the controller via the HP-IB to a connected device (8161A).

One line is written into the display and sent to the device by pressing EXECUTE (END LINE for the 85A).

The device's remote lamp should then be on and all front panel buttons disabled. The last parameter transferred will be shown on the 8161A display.

## EQUIPMENT

Controller etc. as appropriate  
Pulse Generator 8161A  
(Address 17)

## Test Set-up

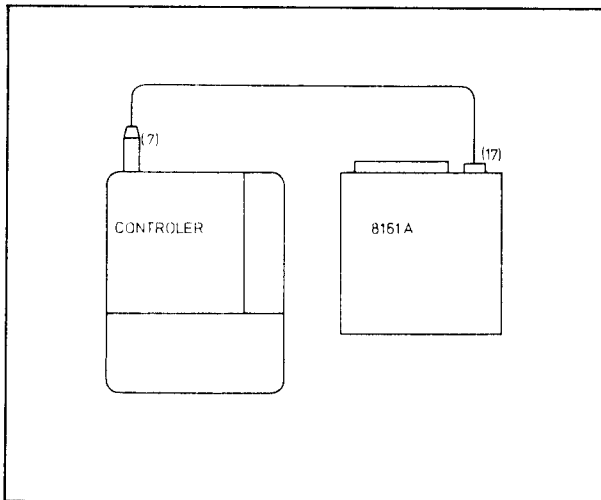

Note: Program failure:

If it fails, verify that the 98034A select code switch is set to "7" and the address switches are set to "17", also check that the interface cable is properly connected.

## 9825S

Type in the following lines:

```
rem 7  
press EXECUTE  
wrt 717, "RCL 0 DEL 50 ns HIL 2 V EN"
```

(For the 2 channel instrument (OPT. 020), A or B must be inserted after DEL and HIL).

press EXECUTE

## EXPLANATION

- rem 7 outputs remote enable ( $\overline{REN}$ ) to the 8161A.
- wrt the write statement transfers data from controller to a device (the 8161A). (i.e. the controller will talk and the 8161A listen).
- 717 First seven is the interface select code, 17 the device address.
- " " The characters within the quotes are output in ASCII.
- RCL 0 Recalls the standard parameter/data set from location 0. It is done in this instance to ensure compatibility between parameter values, when the following delay and level data is input.
- DEL 50 ns HIL 2 V EN  
Sets the 8161A pulse delay to 50 ns and high level to 2 volts. The last two characters (EN) enable the output(s). The characters within quotes may be small or capital and the spacing between them is not critical. It is, however, recommended that you use capitals as shown to aid clarity.

# BASIC

9835A

9845B

85A

For the STANDARD instrument (1 channel) type in:

REMOTE 7

press: EXECUTE

press: END LINE

OUTPUT 717; "RCL 0 DEL 50 ns HIL 2 V EN"  
(for the 2 channel instrument insert A or B after DEL and HIL)

press: EXECUTE

press: END LINE

## EXPLANATION

OUTPUT The output statement transfers data from the controller to an external device.

717 First seven is the interface select code. 17 is the external devices address.

" " The characters within the quotes are output in ASCII.

RCL 0 Recalls the fixed parameter set from location 0. This ensures compatibility between values when the following "DEL" and "HIL" data is input.

DEL 50 ns HIL 2 V EN

Sets a delay of 50 ns, a high level of 2 V and enables the output(s). The characters within quotes may be small or capital and the spacing between them is not critical. It is, however, recommended that you use capitals to aid clarity.

## PROGRAM 2

HP-IB

HPL

### PROGRAMMING

A brief description is given in this section of how to produce and run a program.

The first step is to define the problem in order to define the solution. Usually, correct definition of the problem is half the work involved in programming. A flow chart can be a very useful aid when writing the program statements.

Each program step needs a line number. This line number identifies the line as a part of the program and indicates the relative position of the line in it. When a program is run or executed the execution commences with the line having the lowest line number and continues sequentially through to the last or highest one.

This program examples uses the capability of the HP-IB bus to enable the controller to address the 8161A as listener and as a talker. The purpose is to find out if the 8161A is a 1 or 2 channel instrument, since programming is different.

### EQUIPMENT

Controller etc. as appropriate  
Pulse Generator  
(Address 17)

Test set-up

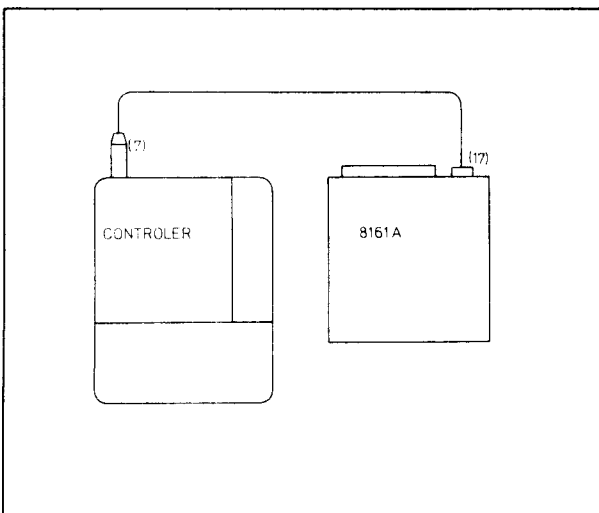

### 9825S

The 9825 automatically allocates line numbers when STORE is pressed. The numbers are assigned in order, starting at 0 and increasing by one each time.

Type in the following program, end each line by pressing: STORE

```
0: ren 7
1: wrt 717, "RCL0 BN"
2: rds(717)→A
3: if A#64 jmp 2
4: prt "SINGLE CHANNEL" jmp 2
5: prt "DUAL CHANNEL"
6: spc 2
7: end
```

### EXPLANATION

- 0 sends remote enable message ( $\overline{REN}$ ) to device.
- 1 the write statement outputs the data to the 8161A. RCL 0 recalls the standard parameter/data set from location 0. BN causes an error (Service Request) SRQ in the standard unit.
- 2 reads the 8161A status into A in order to see if the Service Request line (SRQ bit 7) has been pulled.
- 3 compares value of A with possible value of bit 7. If it is not 64 it will jump 2 lines forward and print line 5. In case of value 64 in A it will print line 4 and then jump 2 lines forward.
- 6 two empty lines for printer.

# BASIC

9835A / 9845B

85A

In order to have automatic line numbering type in:

AUTO then EXECUTE

SHIFT and AUTO then END LINE

The numbers are assigned in order, starting at 10 and increasing by 10 each time. Now type in this program example. End each line by pressing:

STORE

```
10  PRINTER IS 16
20  REMOTE 7
30  OUTPUT 717;"RCL0 BN"
40  STATUS 717:A
50  IF A<>64 THEN GOTO 80
60  PRINT "SINGLE CHANNEL"
70  GOTO 90
80  PRINT "DUAL CHANNEL"
90  END
```

END LINE

```
10  REMOTE 7
20  OUTPUT 717;"RCL0 SN"
30  A=SPOLL(717)
40  IF A#64 THEN GOTO 70
50  PRINT "SINGLE CHANNEL"
60  GOTO 80
70  PRINT "DUAL CHANNEL"
80  END
```

Both programs are very similar. To show the difference the 85A program explanation steps are shown in brackets.

## EXPLANATION

- |    |      |  |
|----|------|--|
| 10 |      | Selects CRT as display.  |
| 20 | (10) | sends remote enable message ( $\overline{REN}$ ) to device.  |
| 30 | (20) | outputs data to 8161A. RCL 0 recalls the standard set from location 0. BN causes a Service Request (SRQ) in the standard unit (bit 7). |
| 40 | (30) | reads the status of the 8161A into variable A in order to find out if the service request line (SRQ bit 7) has been pulled.            |
| 50 | (40) | compares value of A with possible value of bit 7. If value is not 64 it will go to line 80 (70) and display DUAL CHANNEL.              |
| 60 | (50) | if A = 64 SRQ was pulled and the display will show SINGLE CHANNEL.   |

# PROGRAM 3

HP-IB

HPL

## LEARN MODE

This program provides complete mode and parameter information of all 9 independent storage locations (1-9), as well as the standard set (0). The program applies only for the standard instrument. The difference for opt. 20 is shown when needed.

## EQUIPMENT

Controller etc. as appropriate  
Pulse Generator 8161A  
(Address 17)

## Test set-up

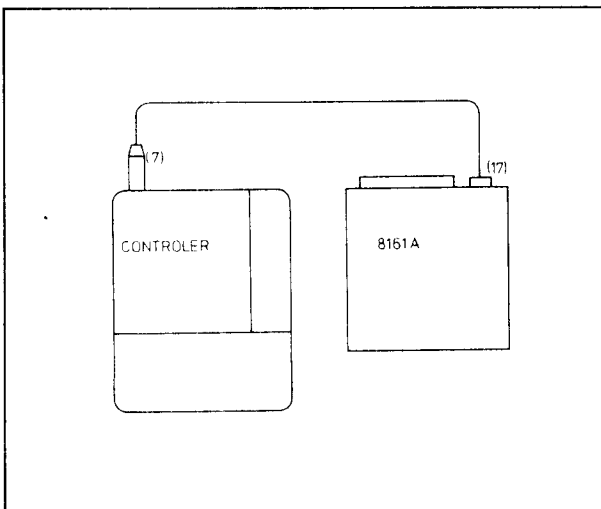

## 9825S

### Program

```
0: prt " LEARN MODE";spc 2
1: ren 7;dim A#[18,16];B#[16]
2: fmt 1;"SET",x,f1;fxd 0
3: wrt 717;"RCL0 BN"
4: rds(717)+A
5: if A#64;19+B;jmp 2
6: 12+B
7: ent "WHICH SET DO YOU WANT ?";Z
8: wrt 717;"SET";Z
9: 1+I
10: rds 717;B#;B#+A#[I];I+1+I;jmp I=B
11: 1+I;wrt 16,1;Z
12: ent A#[I,1,16];I+1+I;jmp I=B
13: spc 2
14: end
```

## EXPLANATION

- 0 prints LEARN MODE and two empty lines.
- 1 dimension of string variables used.
- 2 format statement for printer.
- 3 outputs the data to the 8161A. BN causes service request (SRQ) in the standard unit.
- 4 reads status of 8161A into variable A.
- 5 if no SRQ applies (2 channel unit), variable B is set to 18. Jumps 2 lines forward.
- 6 shift value 12 into variable B (1 channel unit).
- 7 asking for the set number desired (Z).
- 8 outputs "SET" and value of var Z to 8161A.
- 9 variable I is set to 1.
- 10 reads data from 8161A into string locations of A\$ via B\$. I is an increasing variable used as counter for A\$ locations, will jump when I reaches the value of B.
- 11 resets I to 1 and prints format 1 and value of Z.
- 12 prints all data of string A\$ controlled by counter I. Will jump when I equals B.
- 13 prints two blank lines.

# BASIC

9835A

9845B

85A

Program

```
10 PRINTER IS 16
20 PRINT "LEARN MODE"
30 REMOTE 7
40 OUTPUT 717;"RCL0 BN"
50 STATUS 717:A
60 IF A<>64 THEN B=18
70 IF A<>64 THEN GOTO 90
80 B=11
90 PRINT "WHICH SET DO YOU WANT ?"
100 INPUT T
110 OUTPUT 717;"SET";T
120 PRINT "SET";T
130 FOR S=1 TO B
140 ENTER 717:A$
150 PRINT A$
160 NEXT S
170 END
```

Program

```
10 DISP "LEARN MODE"
20 REMOTE 7
30 OUTPUT 717;"RCL0 BN"
40 A=SPOLL(717)
50 IF A#64 THEN B=18
60 IF A#64 THEN GOTO 80
70 B=11
80 DISP "WHICH SET DO YOU WANT"
90 INPUT T
100 OUTPUT 717;"SET";T
110 PRINT "SET";T
120 FOR S=1 TO B
130 ENTER 717:A$
140 PRINT A$
150 NEXT S
160 PRINT USING "4/"
170 END
```

The programs are similar. The 85A program steps are shown in brackets.

## EXPLANATION

10		selects CRT as display.
20	(10)	displays LEARN MODE.
30	(20)	sends remote enable message ( $\overline{REN}$ ) to device.
40	(30)	outputs data to 8161A. RCL 0 recalls the standard set from location 0. BN causes a service request (SRQ) in the standard unit.
50	(40)	reads status of 8161A into variable A. If value is 64 service request has been pulled (bit 7).
60	(50)	if 2 channel version, 18 will be assigned to B.
70	(60)	jump command when 2 channel unit.
80	(70)	11 will be assigned to variable B (1 channel unit).
90	(80)	displays the question.
100	(90)	selected number will be assigned to T.
110	(100)	outputs command SET and value of T to 8161A.
120	(110)	display (prints) SET and value of T.
130	(120)	start of for/next loop.
140	(130)	enters data from 8161A into string A\$.
150	(140)	displays (prints) the data of A\$.
160	(150)	end of for/next loop printer adds four entry lines.
170	(160)	end of program.

# PROGRAM 4

HP-IB

HPL

## PERIOD MEASUREMENT

This program enables 8161A output period values to be measured and compared with programmed ones to produce a percentage deviation figure. The program includes a loop to enable a range of period values to be considered (200 – 215 ns).

Programmed values and deviation are displayed/printed together.

## EQUIPMENT

Controller etc. as appropriate  
Counter 5345A  
(Address 08)  
Pulse Generator 8161A  
(Address 17)

## Test set-up

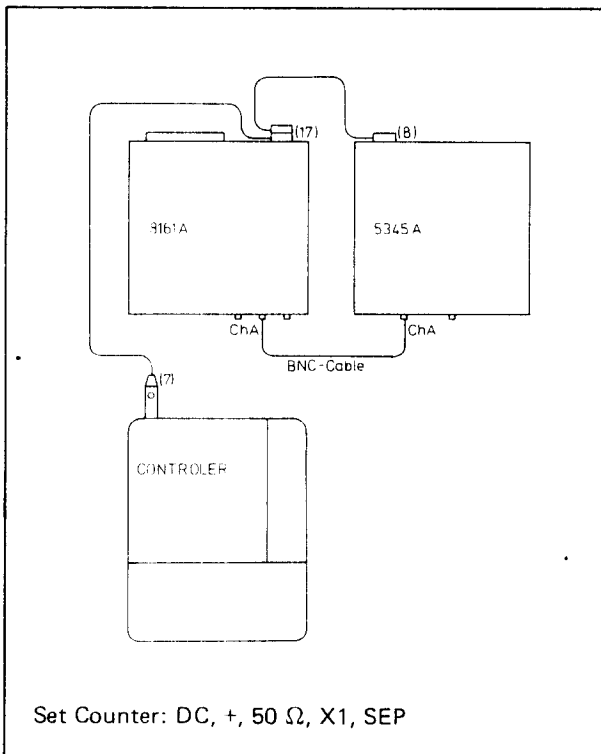

9825S

Program:

```
0: prt " PERIOD TEST";sec
1: fmt 1,f3,f10.2,"%"
2: ren 7
3: wrt 717,"RCL0 EN"
4: wrt 708,"I2E8F1G<D>I1"
5: for I=200 to 215
6: wrt 717,"PER";I;"ns"
7: wrt 708,"I1";wait 60
8: rcd 708;Y;Y*10+9*Y
9: 100*(Y-I)/I*X
10: wrt .16,1;I;"ns";X
11: next I
12: spc 2
13: end
```

## EXPLANATION

- 0 prints PERIOD TEST.
- 1 format statement for printer.
- 2 sends remote enable message (REN) to device.
- 3 outputs settings data to 8161A.
- 4 outputs settings data to 5345A.
- 5 start of for/next loop. I is increased from 200 to 215 ns in single steps.
- 6 outputs period data to 8161A.
- 7 resets 5345A counter.
- 8 reads the counter measurement into variable Y of controller, and converts value for deviation calculation.
- 9 calculates the deviation of Y against I as a percentage and assigns it to X.
- 10 outputs the values of I and X to the printer, using format of line 1.
- 11 end of for/next loop (at 20).
- 12 prints two blank lines.
- 13 end of program.

# BASIC

9835A / 9845B

85A

Program

```

10  PRINTER IS 16
20  PRINT TAB(33);"PERIOD TEST"
30  PRINT SPACE
40  REMOTE 7
50  OUTPUT 717;"RCL0 EN"
60  OUTPUT 708;"I2E8FIG<D>I1"
70  FOR I=200 TO 215
80  OUTPUT 717;"PER",I,"NS"
90  OUTPUT 708;"I1"
100 WAIT 100
110 ENTER 708;Y
120 M=Y*1.0E9
130 X=(M-Y)/I*100
140 PRINT USING "27X.3D,K,9X,
    MED.2D,K";I,"ns",X,"%"
150 NEXT I
160 END
    
```

Program

```

10  CRTSP TAB(10);"PERIOD TEST"
20  PRINT
30  REMOTE 7
40  OUTPUT 717 ;"RCL0 EN"
50  OUTPUT 708 ;"I2E8FIG<D>I1"
60  FOR I=200 TO 215
70  OUTPUT 717 ;"PER",I,"NS"
80  OUTPUT 708 ;"I1"
90  WAIT 100
100 ENTER 708 ; Y
110 M=Y*10^9
120 X=(M-I)/I*100
130 DISP USING 140 ; I,X
140 IMAGE 9X,3D,"ns",X,3D,2D,"%"
150 NEXT I
160 END
    
```

The two programs are similar. The 85A program steps are shown in brackets.

## EXPLANATION

10		selects CRT as printer.
20	(10)	displays test title.
30	(20)	empty line.
40	(30)	sends remote enable message ( $\overline{REN}$ ) to device.
50	(40)	outputs data to 8161A (recalls set 0 enables output).
60	(50)	outputs data for correct 5345A settings.
70	(60)	start of for/next loop. I is increased from 200 to 215 in single steps.
80	(70)	outputs period value to 8161A (value of I).
90	(80)	outputs reset command to 5345A.
100	(90)	wait statement for stable result.
110	(100)	enters data from counter into variable Y.
120	(110)	converts Y to value suitable for deviation calculation (variable M).
130	(120)	calculates the deviation in % (variable X).
140	(130)	displays period and its percent deviation
	(140)	with "USING" format.
150	(150)	end of for/next loop.
160	(160)	end of program.



# PROGRAM 5

HP-IB

HPL

## DELAY MEASUREMENT

This program enables signal output delay values to be measured and compared with programmed ones. A deviation is then calculated and output in % together with the programmed value. Delay values from 400 to 800 ns incremented in 50 ns steps with the aid of a "for/next" loop are covered.

Differences between programming the standard and option 20 units are covered by the program. Either use only channel A or, if B necessary, substitute "B" for "A" as the input to T\$ in the appropriate program line -- e.g.: line 5 in the "9825S program".

## EQUIPMENT

Controller etc. as appropriate  
Counter 5345A  
(Address 8)  
Pulse Generator 8161A  
(Address 17)

Test set-up  
(Note: Counter to be in Time Interval Mode)

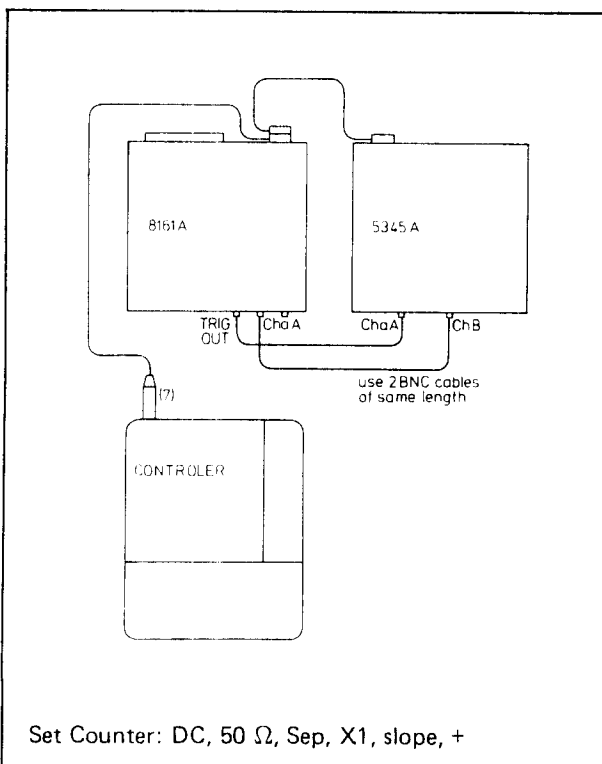

## 9825S

Program

```
0: prt " DELAY TEST";spc
1: rem 7;fmt 1,f3,f10.2,"% "
2: dim T#[1]
3: wrt 717,"RCL0 BN"
4: rds(717)+A
5: if A#64;"A"+T#;jmp 2
6: if A#64;" "→T#
7: wrt 717,"RCL0 PER1MS EN"
8: wrt 708,"I2E0F3G<D>I1"
9: for I=400 to 800 by 50
10: wrt 717,"DEL",T#,I,"NS"
11: wrt 708,"I1";wait 60
12: red 708,Y;Y*10+9+Y
13: 100*(Y-I)/I→X
14: wrt 16.1,Y,"ns",X
15: next I
16: spc 2
17: end
```

## EXPLANATION

- 0 prints DELAY TEST.
- 1 format statement and remote enable ( $\overline{REN}$ ) message.
- 2 dimension of string (T\$).
- 3 outputs data to 8161A. BN causes service request (SRQ) in the standard unit.
- 4 reads status of 8161A into variable A.
- 5 if no SRQ (opt. 020) is active, A (or B) is shifted into T\$. Jumps 2 lines forward.
- 6 if SRQ (standard unit) is active. T\$ remains empty.
- 7 outputs start settings to 8161A.
- 8 outputs settings to 5345A.
- 9 start of for/next loop.
- 10 outputs value for delay to 8161A.
- 11 resets counter and waits to get a stable measurement.
- 12 reads counter value into variable Y and converts it for deviation calculation.
- 13 calculates deviation in %.
- 14 prints result using format statement.
- 15 end of for/next loop.
- 16 two blank lines.
- 17 end of program.

# BASIC

9835A / 9845B

Program

```

10  PRINTER IS 15
20  PRINT TAB(34);"DELAY TEST"
30  PRINT
40  REMOTE 7
50  OUTPUT 717;"RCL0 BN"
60  STATUS 717:A
70  IF A=64 THEN T$=" "
80  IF A<64 THEN T$="A"
90  OUTPUT 717;"RCL0 PER1MS EN"
100 OUTPUT 708;"I2E8F3G<D>I1"
110 FOR I=400 TO 800 STEP 25
120 OUTPUT 717;"DEL",T$,I,"NS"
130 OUTPUT 708;"I1"
140 WAIT 60
150 ENTER 708;Y
160 N=Y*1.0E9
170 X=(N-Y)/I*100
180 PRINT USING "27%,3D,K,9X,"
           M2D.2D,K";I,"ns",X,"%"
190 NEXT I
200 END

```

85A

Program

```

10  DISP TAB(11);"DELAY TEST"
20  DISP
30  REMOTE 7
40  OUTPUT 717 ;"RCL0 BN"
50  A=SPOLL(717)
60  IF A=64 THEN T$=" "
70  IF A#64 THEN T$="A"
80  OUTPUT 717 ;"RCL0 PER1MS EN"
90  OUTPUT 708 ;"I2E8F3G<D>I1"
100 FOR I=400 TO 800 STEP 50
110 OUTPUT 717 ;"DEL",T$,I,"NS"
120 OUTPUT 708 ;"I1"
130 WAIT 60
140 ENTER 708 ; Y
150 Y=Y*10^9
160 X=(ABS(Y)-I)/I*100
170 DISP USING 180 ; I,X
180 IMAGE 9X,3D,"ns",X,3D.2D,"%"
190 NEXT I
200 END

```

The programs are similar. The 85A program steps are shown in brackets.

## EXPLANATION

10		selects CRT as display.
20	(10)	displays title of test.
30	(20)	empty line.
40	(30)	sends remote enable message ( $\overline{REN}$ ) to device.
50	(40)	outputs data to 8161A. BN causes service request in standard unit.
60	(50)	reads status of 8161A into variable A.
70	(60)	SRQ (bit 7) is active in the standard unit. T\$ stays empty.
80	(70)	no SRQ in opt. 020. A (or B) is shifted into T\$ for opt. 020.
90	(80)	outputs settings for 8161A.
100	(90)	outputs settings for counter.
110	(100)	start of for/next loop, starting at 400 increasing by 25 each time.
120	(110)	outputs delay data (value of I).
130	(120)	resets counter for next measurement.
140	(130)	wait statement for stable counter result.
150	(140)	reads measured data from counter.
160	(150)	converts from ns to seconds for deviation calculation.
170	(160)	calculates deviation in %.
180	(170)	displays delay value and its percentage deviation
	(180)	by using format.
190	(190)	end of for/next loop.
200	(200)	end of program.

# PROGRAM 6

HP-IB

HPL

## HIGH LEVEL MEASUREMENT

This program measures the high level from 0.5 V to 5 V in 0.5 V steps. The low level is held at 0 V. The program covers standard and option 20 instruments by allowing for selection of the channel (option 20 only).

The measured level deviation is printed in % by the controller.

## EQUIPMENT

Controller etc. as appropriate

DVM 3437A

(Address 24)

Pulse Generator 8161A

(Address 17)

## Test set-up

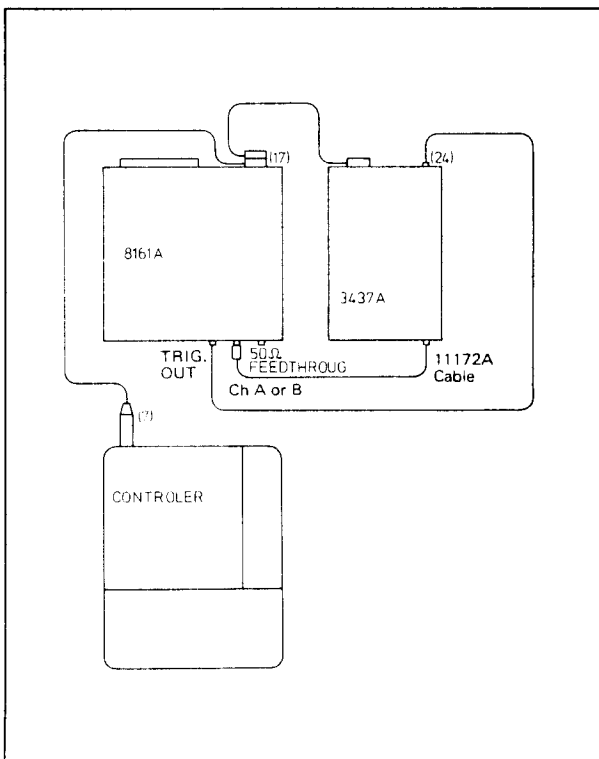

9825S

Program

```
0: prt "HIGH LEVEL TEST";spc 2
1: rem 7;diw T#011;fxd 2
2: fnt 1;f4.1;"V";2;f5.1;"%"
3: fnt 2;f14;x;f2
4: wrt 717;"RCL0 BN"
5: rds(717)→A
6: if A#64;ato 10
7: if A=64;" "+T$
8: prt " SINGLE CHANNEL";spc 2
9: ato 12
10: ent "WHICH CHANNEL ?";T$
11: wrt 16.2;"LEVEL CHANNEL ";T$;spc
12: wrt 717;"RCL0 PER10MS DEL";T$;"0MS"
13: wrt 717;"WID";T$;"5MS EN"
14: wrt 724;"D.0025N1ST2R2F1"
15: for I=1.5 to 5 by .5
16: if I=1.5;wrt 724;"R3"
17: B→X
18: wrt 717;"HIL";T$;I;"V"
19: red 724;F
20: for T=1 to 20
21: red 724;C
22: X+C→X
23: next T
24: X/20→X
25: 100*(abs(X)-I)/I→M
26: wrt 16.1;"HIL";I;M
27: next I
28: spc 2
29: end
```

## EXPLANATION

- pulls remote enable line active, dimensions T\$ and limits digits following decimal point to 2.
- format statements for the printer.
- outputs data to 8161A. BN will cause service request (SRQ) in the standard unit.
- reads status of 8161A into variable A.
- if SRQ is pulled (standard unit) status is 64.
- choice of channel A or B.
- prints channel selected.
- Data to 8161A.
- Data for 3437A.
- start of for/next loop 0.5 to 5.
- for better resolution DVM was set to range 2 set now to range 3.
- outputs value of HIL to 8161A.
- forces DVM to shift previous data.
- start second for/next loop (readings).
- actual reading from DVM.
- average value of 20 readings.
- percent calculation.
- print command using format 1.

# BASIC

9835A / 9845B

Program

```

10  PRINTER IS 1;
20  PRINT "HIGH LEVEL MEASUREMENT"
30  PRINT
40  REMOTE 7
50  OUTPUT 717;"RCL0 BN"
60  STATUS 717:A
70  IF A >64 THEN GOTO 110
80  IF A=64 THEN T$=""
90  PRINT TAB(27);"HIGH LEVEL
    SINGLE CHANNEL"
100 GOTO 150
110 PRINT "WHICH CHANNEL ?"
120 INPUT T$
130 PRINT TAB(29);"HIGH LEVEL
    PRINT CHANNEL";T$;"
140 PRINT
150 OUTPUT 717;"RCL0 PER 10MS DEL",
    T$,"0NS WID",T$,"SMS EN"
160 OUTPUT 724;"D.002SE0SN1ST2R2F1"
170 FOR I=.5 TO 5 STEP .5
180 IF I=1.5 THEN OUTPUT 724;"R3"
190 X=0
200 OUTPUT 717;"HIL",T$,I,"V"
210 ENTER 724:F
220 FOR T=1 TO 20
230 ENTER 724:C
240 X=C+X
250 NEXT T
260 X=X/20
270 M=(ABS(X)-I)/I*100
280 PRINT USING "27X;D.2D;K.10X;
    "3D.2D;K";I,"V",M,"%
290 NEXT I
300 END

```

85A

Program

```

10 DISP "HIGH LEVEL TEST"
20 DISP
30 REMOTE 7
40 OUTPUT 717;"RCL0 BN"
50 A=SPOLL(717)
60 IF A#64 THEN GOTO 100
70 IF A=64 THEN T$=""
80 PRINT TAB(9);"SINGLE CHANNEL
    "
90 GOTO 130
100 DISP "WHICH CHANNEL ?"
110 INPUT T$
120 PRINT TAB(8);"LEVEL CHANNEL
    " T$
130 PRINT
140 OUTPUT 717;"RCL0 PER10MS DE
    L";T$,"0NS WID",T$,"SMS EN"
150 OUTPUT 724;"D.002SN1ST2F3R2
    "
160 FOR I=.5 TO 5 STEP .5
170 IF I=1.5 THEN OUTPUT 724;"R
    3"
180 X=0
190 OUTPUT 717;"HIL",T$,I,"V"
200 ENTER 724 ; F
210 FOR T=1 TO 20
220 ENTER 724 ; C
230 X=C+X
240 NEXT T
250 X=X/20
260 M=(ABS(X)-I)/I*100
270 PRINT USING 280 ; I,M
280 IMAGE 8X;D.2D;"V",X;3D.2D,"%
    "
290 NEXT I
300 PRINT USING "4/"
310 END

```

## EXPLANATION

10	(10)	sets remote enable line active
20		selects CRT as display.
30	(30)	blank line.
50	(40)	outputs data to 8161A. BN causes service request in standard unit.
60	(50)	reads status of 8161A into variable A.
70	(60)	if A is not 64, 8161A has opt. 20 no SRQ.
80	(70)	if A is 64 SRQ is active and T\$ stays empty.
110	(100)	choise of channel A or B.
120	(110)	enters A or B into T\$.
150	(140)	output settings to 8161A.
160	(150)	outputs settings to DVM.

170	(160)	start of for/next loop (voltage value).
180	(170)	DVM was set to range 2 for better resolution (set to range 3 now).
200	(190)	outputs loop data to 8161A.
210	(200)	forces DVM to shift previous data.
220	(210)	start of for/next loop (number of readings to be taken).
230	(220)	reads actual value of DVM into variable C.
260	(250)	calculates average value of the 20 readings taken.
270	(260)	percent calculation.
280	(270)	print statement with "USING format".
	(280)	print statement with "USING format".
290	(290)	end of voltage value loop.
	(300)	prints two blank lines.

# PROGRAM 7



## ERROR MESSAGE TEST

This program performs a complete test of all syntax or parameter errors. Programming of standard or opt. 20 instruments is different, hence both possibilities are covered. An error will be sent to the 8161A which will then set the Service request line (SRQ) 7 high and place an error code on lines 1-4, 6 (see table 3-4). The controller reads and compares the status of the data lines. Then RCL 0 is transmitted to remove the service request and set the instrument to a definite condition. Then the next error can be sent to the 8161A. The test currently in progress will be shown on the display. Any malfunction will cause an error indicator to be printed/displayed.

## EQUIPMENT

Controller etc. as appropriate  
Pulse Generator                      8161A  
(Address 17)

Test set-up

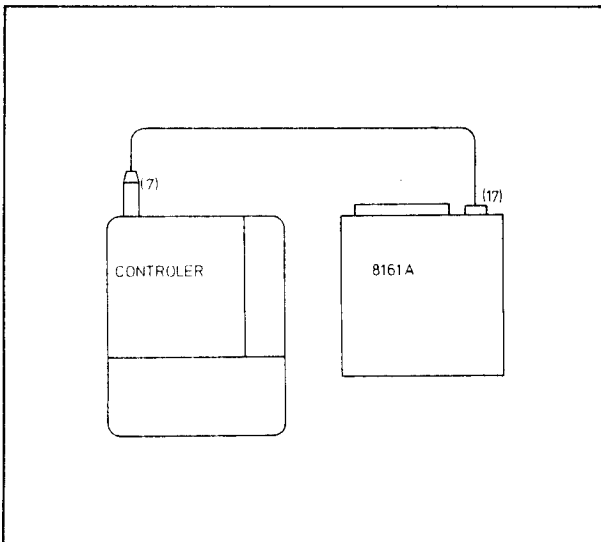

# HPL

9825S

Program

```

0: prt " ERROR MESSAGE          TEST";spc
1: rem 7;dim E#[25];T#[1];2000+C
2: wrt 717;"RCL0 BN"
3: rds(717)+A
4: if A#64;jmp 3
5: prt "1 CHANNEL INSTR.";spc 2
6: " "+T#;jmp 3
7: prt "2 CHANNEL INSTR.";spc 2
8: "A"+T#
9: wrt 717;"RCL0 X2"
10: dsp "SYNTAX ERROR TEST";wait C
11: "SYNTAX ERROR"+E#
12: rds(717)+B;if B#64;asb "EM"
13: wrt 717;"RCL0 STO0"
14: dsp "PARAMETER ERROR TEST";wait C
15: "PARAMETER ERROR"+E#
16: rds(717)+B;if B#65;asb "EM"
17: wrt 717;"RCL0 WID";T#;"2NS"
18: dsp "TIMING ERROR TEST";wait C
19: "TIMING ERROR "+E#
20: rds(717)+B;if B#98;asb "EM"
21: wrt 717;"RCL0 LEE";T#;"1US"
22: dsp "SLOPE ERROR TEST";wait C
23: "SLOPE ERROR"+E#
24: rds(717)+B;if B#99;asb "EM"
25: wrt 717;"RCL0 HIL";T#;"6V"
26: dsp "LEVEL ERROR TEST";wait C
27: "LEVEL ERROR "+E#
28: rds(717)+B;if B#100;asb "EM"
29: wrt 717;"RCL0";jmp 3
30: "EM";prt E#;sfe 1
31: prt "failed";spc ;ret
32: if fla1;prt " TEST FAILED";spc 2;jmp 2
33: prt " TEST PASSED";spc 2
34: end
*11419

```

EXPLANATION

- 1 sends remote enable message ( $\overline{REN}$ ) to all devices; dimensions E\$ and T\$, defines value of variable C (used as wait time).
- 2 outputs data to 8161A. BN causes service request (SRQ) in a standard unit.
- 3 reads status of 8161A into variable A.
- 4 if a standard unit is connected A = 64 (bit 6 high).
- 6 for standard unit T\$ stays empty.
- 8 for option 20, A is shifted into T\$.
- 9 outputs first error to 8161A (X2).
- 10 displays type of error for about 2 seconds.
- 11 used for printer if faulty (line 30).
- 12 reads status of 8161A into variable B, if error is not as expected it will go to subroutine EM line 30.
- 13 removes previous fault (RCL 0) and causes next error (STO 0).
- 16 reads status of 8161A into variable B, will go to subroutine EM (line 30) if error is not 65.
- 17 removes previous fault (RCL 0) and causes next fault (2 NS).
- 20 as line 12 or 16 (status 98).
- 21 as line 13 or 17 (1  $\mu$ s).
- 24 as line 12 or 16 (status 99).
- 25 as line 13 or 17 (6 V).
- 28 as line 12 or 16 (status 100).
- 29 removes error (RCL 0) jumps 3 lines.
- 30 subroutine EM, if one of the tests failed contents of E\$ are printed and flag 1 set.
- 31 prints which status no.failed prints an empty line and returns.
- 32 if flag 1 is set a test failed.

# BASIC

9835A — 9845B

Program

```

10  PRINTER IS LG
20  PRINT "ERROR MESSAGE TEST"
30  Z=0
40  REMOTE ?
50  OUTPUT 717;"RCL0 BN"
60  STATUS 717:B
70  IF A=64 THEN T#=" "
80  IF A<>64 THEN GOTO 110
90  PRINT TAB(28);"1 CHANNEL INSTRUMENT"
100 GOTO 130
110 T#="P"
120 PRINT TAB(28);"2 CHANNEL INSTRUMENT"
130 PRINT
140 OUTPUT 717;"RCL0 X2"
150 PRINT TAB(28);"SYNTAX ERROR TEST"
160 STATUS 717:B
170 IF B<>64 THEN GOSUB 410
180 PRINT
190 OUTPUT 717;"RCL0 ST00"
200 PRINT TAB(28);"PARAMETER ERROR TEST"
210 STATUS 717:B
220 IF B<>65 THEN GOSUB 410
230 PRINT
240 OUTPUT 717;"RCL0 WID",T#;"3US"
250 PRINT TAB(28);"TIMING ERROR TEST"
260 STATUS 717:B
270 IF B<>98 THEN GOSUB 410
280 PRINT
290 OUTPUT 717;"RCL0 LEE",T#;"1US"
300 PRINT TAB(28);"SLOPE ERROR TEST"
310 STATUS 717:B
320 IF B<>99 THEN GOSUB 410
330 PRINT
340 OUTPUT 717;"RCL0 HIL",T#;"6V"
350 PRINT TAB(28);"HIGH LEVEL ERROR TEST"
360 STATUS 717:B
370 IF B<>100 THEN GOSUB 410
380 OUTPUT 717;"RCL0"
390 PRINT
400 GOTO 440
410 PRINT TAB(28);"NOT REPORTED"
420 Z=1
430 RETURN
440 PRINT
450 IF Z=1 THEN PRINT TAB(28);"ERROR
      MESSAGE TEST FAILED"
460 IF Z=0 THEN PRINT TAB(28);"ERROR
      MESSAGE TEST PASSED"
470 END

```

EXPLANATION

10 CRT is selected as display.  
30 sends remote enable message ( $\overline{REN}$ ) to device.  
50 outputs data to 8161A, BN causes service request (SRQ) in a standard unit.  
60 reads status of 8161A into variable A.  
70 if A = 64 then service request is active (standard inst and T\$ stays empty).  
80 if A is not 64, opt. 20 is connected.  
Will jump to line 110 and shift A into T\$.  
140 outputs data to 8161A. RCL 0 removes previous SRQ and transfers first error (X2).  
150 displays type of error.  
160 reads status of 8161A into variable B.  
170 checks if reported status is as expected. If not it will go to subroutine line 360.  
180 blank line.  
190 as lines 140 to 170  
to  
220 STO 0 causes status 65.  
240 as lines 140 to 170  
to  
270 WID 2  $\mu$ s causes status 98.  
290 as lines 140 to 170  
to  
320 LEE 1  $\mu$ s causes status 99.  
340 as lines 140 to 170  
to  
370 HIL 6 V causes status 100.  
380 RCL 0 removes last error.  
410 error subroutine, will display what failed and set Z and return.  
440 blank line  
450 if Z is 1 at least one test failed  
460 if Z is 0 all status tests were passed.

# BASIC

85A

Program

```

10 DISP "ERROR MESSAGE TEST"
20 REMOTE 7
30 Z=0
40 OUTPUT 717 ;"RCL0 BN"
50 A=SPOLL(717)
60 IF A=64 THEN T$=" "
70 IF A#64 THEN GOTO 100
80 DISP "1 CHANNEL INSTRUMENT"
90 GOTO 120
100 T$="A"
110 DISP "2 CHANNEL INSTRUMENT"
120 OUTPUT 717 ;"RCL0 X2"
130 DISP
140 DISP "SYNTAX ERROR TEST"
150 B=SPOLL(717)
160 IF B#64 THEN GOSUB 400
170 DISP
180 OUTPUT 717 ;"RCL0 STO0"
190 DISP "PARAMETER ERROR TEST"
200 B=SPOLL(717)
210 IF B#65 THEN GOSUB 400
220 DISP
230 OUTPUT 717 ;"RCL0 WID",T$,"2
US"
240 DISP "TIMING ERROR TEST"
250 B=SPOLL(717)
260 IF B#98 THEN GOSUB 400
270 DISP
280 OUTPUT 717 ;"RCL0 LEE",T$,"1
US"
290 DISP "SLOPE ERROR TEST"
300 B=SPOLL(717)
310 IF B#99 THEN GOSUB 400
320 DISP
330 OUTPUT 717 ;"RCL0 HIL",T$,"6
V"
340 DISP "LEVEL ERROR TEST"
350 B=SPOLL(717)
360 IF B#100 THEN GOSUB 400
370 OUTPUT 717 ;"RCL0"
380 DISP USING "2/"
390 GOTO 430
400 DISP "NOT REPORTED"
410 Z=1
420 RETURN
430 IF Z=1 THEN DISP "TEST FAILE
0"
440 IF Z=0 THEN DISP "TEST PASSE
0"
450 END

```

EXPLANATION

20 sends remote enable message ( $\overline{\text{REN}}$ ) to device.  
40 outputs data to 8161A. BN causes service request (SRQ) in standard unit.  
50 reads status of 8161A into variable A.  
60 if standard unit is connected, A is 64 (bit 6 high) and T\$ stays empty.  
70 if option 20 is connected A is not 64 so A is shifted into T\$ (line 100).  
120 outputs first error message (X2).  
140 displays type of error.  
150 reads status of 8161A into variable B.  
160 if reported error is not as expected (64) it will jump to subroutine (line 360).  
170 displays empty line.  
180 outputs data to 8161A which removes previous error (RCL 0) and gives next error message (STO 0).  
190 as lines 140 to 160  
to  
220 STO 0 causes status 65  
230 as lines 180 and 140 to 160  
to  
270 WID 2 US causes status 98.  
280 as lines 180 and 140 to 160  
to  
310 LEE 1 US causes status 99.  
320 as lines 180 and 140 to 160.  
to  
360 HIL 6 V causes status 100.  
370 removes last error with RCL 0.  
380 two blank lines in display.  
400 error subroutine.  
410 Z is set when error message failed.  
420 end of subroutine.  
430 if Z is 1 subroutine was called so test failed.  
440 if Z is zero test was performed properly.