

Photron



Compact high-speed cameras with high light sensitivity

The FASTCAM Mini AX is Photron's highest performance model within the FASTCAM Mini series of high-speed cameras. The Mini AX delivers exceptional light sensitivity, excellent image quality and flexible region of interest (ROI) features for customers who do not require the ultimate frame rate performance of the FASTCAM SA-X2 and SA-Z, but would benefit from the same high-end camera image sensor features.

Three performance level models - Mini AX50, AX100 and AX200 - deliver 1-megapixel image resolution (1024 x 1024 pixels) at frame rates up to 2,000fps, 4,000fps and 6,400fps respectively. All three Mini AX models offer a minimum exposure duration of 1µs as standard with recording memory options up to 32GB providing extended recording times and triggering flexibility.

Subject to export approval the Mini AX100 can be offered with maximum frame rates up to 540,000fps and the Mini AX200 with maximum frame rates up to 900,000fps with a minimum exposure time of 260 nanoseconds.

Standard operational features of the FASTCAM Mini AX include a mechanical shutter to allow remote system calibration, Gigabit Ethernet Interface for reliable system control with high-speed data transfer to PC, and the ability to remotely switch off cooling fans to eliminate vibration when recording at high magnifications.

With the combination of high frame rates, high image quality and exceptional light sensitivity contained within a 120mm x 120mm x 94mm rugged camera body weighing just 1.5kg, the FASTCAM Mini AX is ideally suited for use in a wide range of demanding scientific and industrial applications.

FASTCAM Mini AX

Model AX50 / AX100 / AX200

1-Megapixel CMOS Image Sensor:

1024 x 1024 pixels at 2,000fps (Mini AX50)
1024 x 1024 pixels at 4,000fps (Mini AX100)
1024 x 1024 pixels at 6,400fps (Mini AX200)

Maximum Frame Rate:

170,000fps (Mini AX50 type 170K)
212,500fps (Mini AX100 type 200K)
540,000fps (Mini AX100 type 540K)
216,000fps (Mini AX200 type 200K)
540,000fps (Mini AX200 type 540K)
900,000fps (Mini AX200 type 900k)

Class Leading Light Sensitivity:

ISO 12232 Ssat
• ISO 40,000 monochrome
• ISO 16,000 color

Global Electronic Shutter:

1ms to 1µs independent of frame rate
(Mini AX200 model 900K only: 260ns shutter available subject to export control)

Dynamic Range (ADC):

12-bit monochrome, 36-bit color

Compact and Lightweight:

120mm (H) x 120mm (W) x 94mm (D)
4.72" (H) x 4.72" (W) x 3.70" (D)
Weight: 1.5Kg (3.30 lbs.)

Internal Recording Memory:

8GB, 16GB, or 32GB

Fast Gigabit Ethernet Interface:

Provides high-speed image download to standard notebook/PC

Flexible Frame Synchronization:

Frame rate may be synchronized to external unstable frequencies

High-G Rated:

Suitable for application in high-G environments; operation tested to 100G, 10ms, 6-axes

Fan Stop Function:

Remotely switch off cooling fans to eliminate vibration

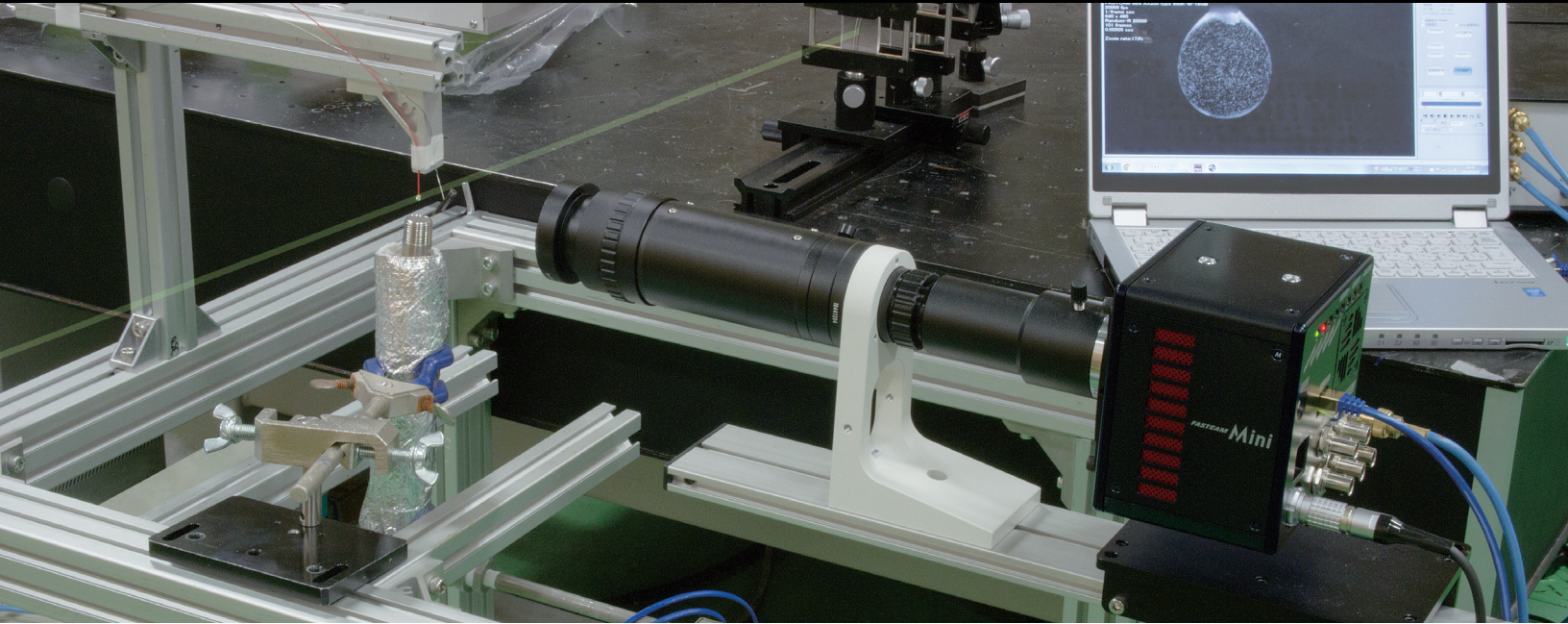

Light Sensitivity:

Expressions of light sensitivity in high-speed cameras can be confusing as a variety of differing measurement techniques are used. Photron publishes light sensitivity figures for its products using the ISO 12232 Ssat Standard.

FASTCAM MINI AX	ISO 12232 Ssat
Monochrome models	ISO 40,000
Color models	ISO 16,000

ISO 12232 Ssat values published by Photron for both monochrome and color cameras are measured excluding infrared sensitivity as defined by the ISO standard measurement procedure ISO 14524.

Monochrome sensors used in the FASTCAM Mini AX cameras are supplied without an IR absorbing filter, extending the camera spectral response beyond 900nm. When the sensitivity of the FASTCAM Mini AX camera is measured to tungsten light including near IR response an equivalent value of ISO 100,000 is obtained.

Image Sensor:

The FASTCAM Mini AX system uses an advanced CMOS image sensor optimized for light sensitivity and high image quality that is unique to Photron.

A 20-micron pixel pitch gives a sensor size at full image resolution of 20.48 x 20.48mm (diagonal 28.96mm).

Lenses designed for both FX (35mm full frame) and also DX (APS-C digital SLR) formats are fully compatible with the FASTCAM Mini AX at full image resolution.

Sensor Type	Proprietary Design Advanced CMOS
Maximum Resolution (pixels)	1024 x 1024 pixels
Sensor Size / Diagonal	20.48 x 20.48mm / 28.96mm
Pixel Size (microns)	20µm x 20µm
Quantum Efficiency	46% at 630nm
Fill Factor	58%
Color Matrix	Bayer CFA (single sensor)
ISO 12232 Ssat sensitivity	ISO 40,000 monochrome ISO 16,000 color (monochrome sensor equivalent ISO 100,000 including near IR response)
Shutter	Global Electronic Shutter 1ms to 1µs independent of frame rate (Mini AX200 model 900K only: 260ns shutter available subject to export control)

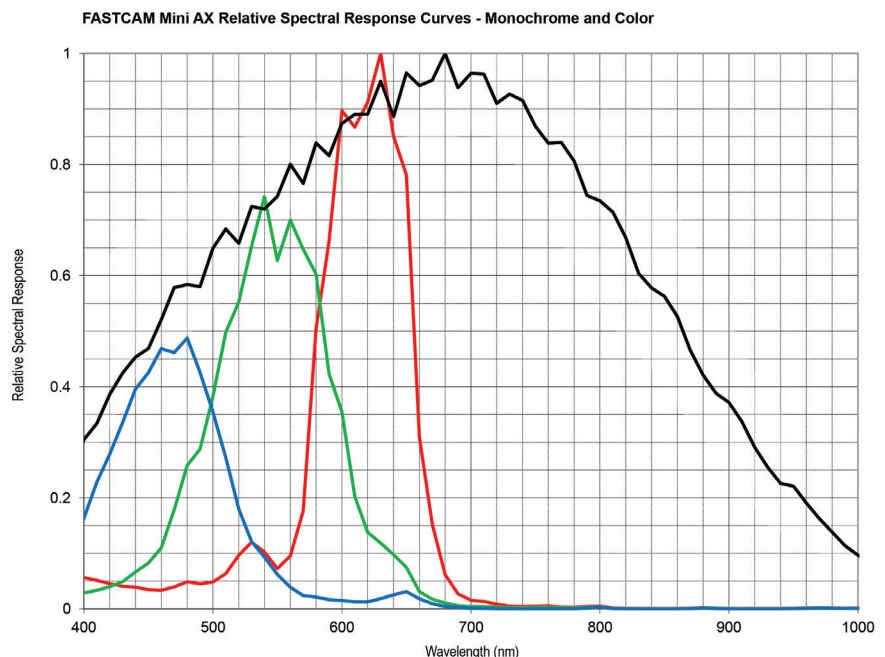

Camera Performance Specifications

Model	Mini AX50	Mini AX100	Mini AX200
Full Frame Performance	2,000fps 1024 x 1024 pixels	4,000fps 1024 x 1024 pixels	6,400fps 1024 x 1024 pixels
Maximum Frame Rate	Type 170K: 170,000fps (128 x 16 pixels)	Type 200K: 212,500fps (128 x 16 pixels) Type 540K: 540,000fps* (128 x 16 pixels)	Type 200K: 216,000fps (128 x 16 pixels) Type 540K: 540,000fps* (128 x 16 pixels) Type 900K: 900,000fps* (128 x 16 pixels)
Minimum Exposure Time	Global electronic shutter to 1.05µs selectable independent or frame rate (260ns option available with Mini AX200 type 900K only) *		
Inter Frame Time (for PIV)	1.71µs		
Ruggedized Mechanical Calibration Shutter	Standard feature		
Dynamic Range (ADC)	12-bit monochrome 36-bit color		
Memory Capacity Options	8GB: 5,457 frames at full resolution 16GB: 10,918 frames at full resolution 32GB: 21,841 frames at full resolution		
Memory Partitions	Up to 64 memory segments		
Region of Interest	Selectable in steps of 128 pixels (horizontal) x 16 pixels (vertical)		
Trigger Inputs	Selectable +/- TTL 5V and switch closure		
Trigger Delay	Programmable on selected input / output triggers: 100ns resolution		
Input / Output	Input: Trigger (TTL/Switch), sync, ready, event, IRIG Output: trigger, sync, ready, rec, exposure		
Trigger Modes	Start, end, center, manual, random, random reset, image trigger, time lapse		
Time Code Input	IRIG-B		
External Sync	+/- TTL 5Vp-p Variable frequency sync		
Camera Control Interface	High-speed Gigabit Ethernet		
Image Data Display	Frame rate, shutter speed, trigger mode, date/time, status, real time / IRIG time, frame count, resolution		
Saved Image Formats	BMP, TIFF, JPEG, PNG, RAW, RAWW, MRAW, AVI, WMV, FTIF, MOV - Images can be saved with or without image data and in 8-bit, 16-bit or 36-bit depth of sensor where supported		
Supported OS	Microsoft Windows operating system including: 7, 8, 8.1, 10 (32/64-bit)		

* Frame rates above 225,000fps and exposure times below 1µs may be subject to export control regulations in some areas

High-Speed Gigabit Ethernet Interface:

The FASTCAM Mini AX camera system is equipped with a high-speed Gigabit Ethernet Interface to provide reliable network communication and fast download of image data.

Dedicated I/O:

A dedicated BNC connection for a contact closure hardware trigger input is provided. In addition, two programmable inputs and two programmable output channels provide direct connection for common tasks such as synchronization of multiple cameras and operation in conjunction with Data Acquisition (DAQ) hardware.

High-G Mechanical Calibration Shutter:

The ruggedized mechanical shutter fitted as standard to the FASTCAM Mini AX camera allows sensor black balance calibration to be carried out remotely from the system control software.

Nikon G-Type Compatible Lens Fitting:

The FASTCAM Mini AX camera is equipped with an objective lens mount compatible with readily available Nikon G-type lenses. Controls provided within the lens mount allow the control of lens aperture on lenses without external iris control.

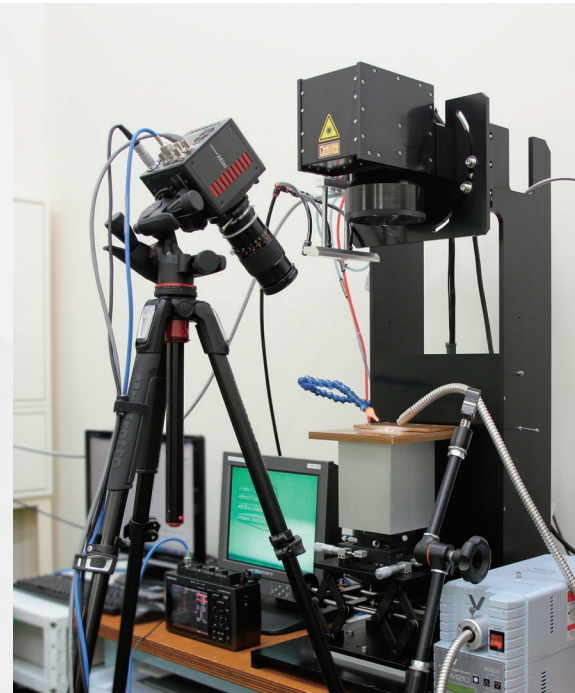

Camera Operation Features

Frame Synchronization	Accurate frame synchronization with other cameras and with external and unstable frequencies.
Dual Slope Shutter (Extended Dynamic Range)	Selectable in 20 steps (0 to 95% in 5% increments) to prevent pixel overexposure without post processing.
Memory Partitions	Up to 64 memory segments allow multiple events to be stored in camera memory before downloading, with automatic progression to the next available partition.
Low Light Mode	Operation at minimum frame rate with separately adjustable shutter time to allow easy camera set-up and focus in ambient lighting.
IRIG Phase Lock	Enables multiple cameras to be synchronized together with other instrumentation equipment or to a master external time source.
Internal Time Delay Generator	Allows programmable delays to be set on input and output triggers; 100ns resolution.
Event Markers	Up to ten user-entered event markers to define specific events within the recorded image sequence .
Download While Recording	FASTCAM Mini AX supports Partition Recording Mode, allowing image data captured in one memory partition to be downloaded while at the same time recording into another partition.
Automatic Download	The system can be set to automatically download image data to the control PC and, when download is complete to re-arm in readiness for the next trigger with automatically incremented file names.
Software Binning	Virtual pixel binning (2x2, 4x4 etc.) allows increased light sensitivity with reduced image resolution without changing camera field of view.

Operation Software Features

Image Calibration	2D image calibration allows the measurement of distance and angle from the image. A calibration grid overlay can be superimposed on the image.
Image Overlay	A stored reference image may be overlaid on the live image to allow accurate camera positioning to achieve the same view as a previous test.
Import of Multiple Image Sequences	Multiple image sequences can be loaded and simultaneously replayed. Timing of image sequences can be adjusted to create a common time reference. Time based synchronization allows images captured at different frame rates to be synchronized.
High Dynamic Range Mode	Making use of the full sensor dynamic range, HDR mode allows enhanced detail in both light and dark areas of an image to be displayed simultaneously.
Motion Detector	In order to highlight subtle changes in an image, Motion Detector allows a reference image to be subtracted from a recorded sequence. Details including propagation of shock waves and surface changes during impact can be visualized using the feature.
Line Profile	A line profile representing grey levels along a line drawn across any region of the image is displayed. In live mode the Line Profile can be used to ensure optimum image focus is achieved.
Histogram	A histogram displaying grey levels within a user-defined image area is displayed. In live mode the Histogram can be used to ensure that optimum exposure levels are set for the scene being recorded.

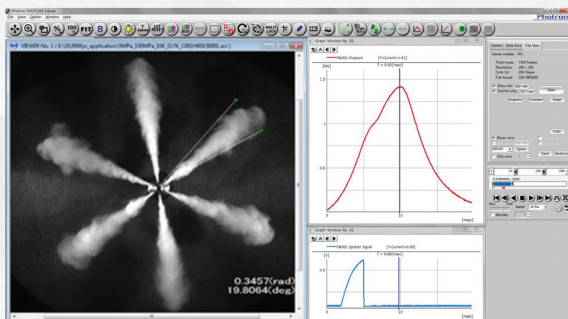

Photron FASTCAM Viewer:

Photron FASTCAM Viewer software (PFV) has been designed to provide an intuitive and feature rich user interface for the control of Photron high-speed cameras, data saving, image replay and simple motion analysis. Advanced operation menus provide access to features for advanced camera operation and image enhancement. Tools are provided to allow image calibration and easy measurement of angles and distances from image data. Also included are a C++ SDK and wrappers for LabView and MATLAB ®.

An optional software plug-in module provides synchronisation between Photron high-speed cameras and data acquired through National Instruments data acquisition systems. Synchronised data captured by the DAQ system provides waveform information which can be viewed alongside high-speed camera images.

Photron FASTCAM Analysis:

PFV software allows image sequences to be exported directly to optional Photron FASTCAM Analysis (PFA) Motion Analysis software. This entry level Motion Analysis software with an on screen 'step by step guide' function launches automatically from Photron FASTCAM Viewer software, and provides automated tracking of up to 5 points using feature or correlation tracking algorithms for the automated analysis of motion within an image sequence.

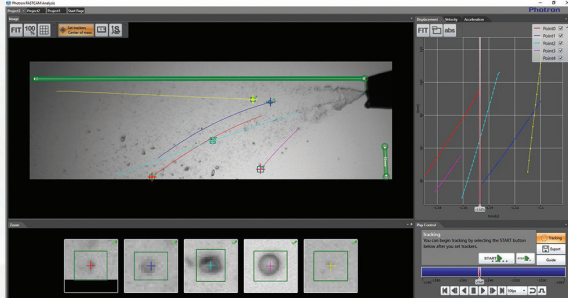

Variable Region of Interest:

Region of Interest (ROI) or sub-windowing allows a user-specified portion of the sensor to be defined to capture images. By using a reduced portion of the image area, the frame rate at which images are recorded can be increased. FASTCAM Mini AX allows the ROI to be set in increments of 128 pixels horizontal and 16 pixels vertical.

Square Image Sensor Format:

Unlike broadcast and media applications where image formats such as 16:9 have now become standard, in scientific and industrial imaging applications an image sensor with a 1:1 image format is generally accepted to be advantageous. To capture the maximum useful image data in applications including microscopy, detonics, combustion imaging and many others, a 1:1 sensor format provides greater flexibility than 'letterbox' image formats. The FASTCAM Mini AX image sensor allows the user to choose either square or rectangular image formats in order to obtain the maximum subject information.

External Frame Synchronization:

The FASTCAM Mini AX camera can be fully synchronized with an external event to allow the timing of when each individual image is captured to be precisely referenced. The camera can be accurately synchronized to unstable frequencies allowing complex events such as combustion in rapidly accelerating or decelerating engines to be recorded and studied.

Record During Download Operation:

FASTCAM Mini AX recording memory can be divided into multiple active sections. The user can record an on-going event in one memory partition while at the same time downloading a previously recorded image sequence in order to improve workflow and optimize camera operation.



Mini AX200							
Resolution (h x v pixels)	Frame Rate Max fps	8GB		16GB		32GB	
		Frames	Time (sec)**	Frames	Time (sec)**	Frames	Time (sec)**
1024 x 1024	6,400	5,457	0.85	10,918	1.71	21,841	3.41
1024 x 896	7,200	6,236	0.87	12,478	1.73	24,961	3.47
896 x 896	8,100	7,127	0.88	14,261	1.76	28,527	3.52
768 x 768	10,800	9,701	0.90	19,410	1.80	38,829	3.60
512 x 512	22,500	21,829	0.97	43,674	1.94	87,365	3.88
512 x 256	43,200	43,658	1.01	87,349	2.02	174,730	4.04
256 x 256	67,500	87,317	1.29	174,698	2.59	349,461	5.18
256 x 128	120,000	174,634	1.46	349,397	2.91	698,922	5.82
128 x 128	162,000	349,269	2.16	698,794	4.31	1,397,845	8.63
128 x 64	259,200	698,538	2.69	1,397,589	5.39	2,795,690	10.79
128 x 32	360,000	1,397,077	3.88	2,795,178	7.76	5,591,381	15.53
128 x 16	540,000	2,794,154	5.17	5,590,357	10.35	11,182,762	20.71
128 x 16	900,000						

Mini AX100							
Resolution (h x v pixels)	Frame Rate Max fps	8GB		16GB		32GB	
		Frames	Time (sec)**	Frames	Time (sec)**	Frames	Time (sec)**
1024 x 1024	4,000	5,457	1.36	10,918	2.73	21,841	5.46
1024 x 896	4,500	6,236	1.39	12,478	2.77	24,961	5.55
896 x 896	5,400	7,127	1.32	14,261	2.64	28,527	5.28
768 x 768	6,800	9,701	1.43	19,410	2.85	38,829	5.71
512 x 512	13,600	21,829	1.61	43,674	3.21	87,365	6.42
512 x 256	25,500	43,658	1.71	87,349	3.43	174,730	6.85
256 x 256	37,500	87,317	2.33	174,698	4.66	349,461	9.32
256 x 128	61,200	174,634	2.85	349,397	5.71	698,922	11.42
128 x 128	76,500	349,269	4.57	698,794	9.13	1,397,845	18.27
128 x 64	127,500	698,538	5.48	1,397,589	10.96	2,795,690	21.93
128 x 32	170,000	1,397,077	8.22	2,795,178	16.44	5,591,381	32.89
128 x 16	540,000	2,794,154	5.17	5,590,357	10.35	11,182,762	20.71

Mini AX50							
Resolution (h x v pixels)	Frame Rate Max fps	8GB		16GB		32GB	
		Frames	Time (sec)**	Frames	Time (sec)**	Frames	Time (sec)**
1024 x 1024	2,000	5,457	2.73	10,918	5.46	21,841	10.92
1024 x 896	2,500	6,236	2.49	12,478	4.99	24,961	9.98
896 x 896	2,500	7,127	2.85	14,261	5.70	28,527	11.41
768 x 768	3,600	9,701	2.69	19,410	5.39	38,829	10.79
512 x 512	7,200	21,829	3.03	43,674	6.07	87,365	12.13
512 x 256	13,600	43,658	3.21	87,349	6.42	174,730	12.85
256 x 256	20,400	87,317	4.28	174,698	8.56	349,461	17.13
256 x 128	37,500	174,634	4.66	349,397	9.32	698,922	18.64
128 x 128	45,900	349,269	7.61	698,794	15.22	1,397,845	30.45
128 x 64	76,500	698,538	9.13	1,397,589	18.27	2,795,690	36.54
128 x 32	127,500	1,397,077	10.96	2,795,178	21.92	5,591,381	43.85
128 x 16	170,000	2,794,154	16.44	5,590,357	32.88	11,182,762	65.78

* Specifications subject to change without notice.

** Recording time is an estimate and may be different depending on recording conditions and settings.

Photo

Schlieren imaging of fuel injection and engine combustion
20,000fps

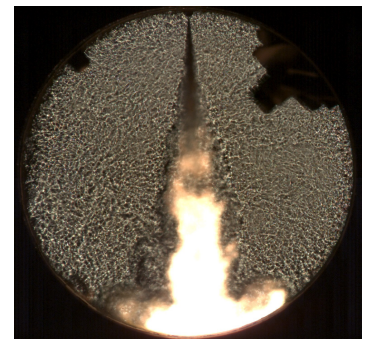

Compatibility with Specialist Lens Systems:

A combination of small physical size, low weight and high light sensitivity allows the FASTCAM Mini AX to be coupled to a range of optical systems such as scientific and long distance microscopes, rigid endoscopes or borescopes, and image intensifiers for applications ranging from imaging flows in microfluidic devices to combustion diagnostics.

PIV and DIC Requirements:

FASTCAM Mini AX specifications match with the requirements for optical measurement techniques such as Particle Image Velocimetry (PIV) and Digital Image Correlation (DIC). The FASTCAM Mini AX has many key performance specifications desired for these measurement systems.

In PIV the detection of low light levels from small particles is fundamental. A high sensitivity image sensor allows the use of smaller tracer particles and/or lower laser power.

For DIC applications a highly sensitive camera allows the use of smaller objective lens apertures yielding greater depth of field and enhanced measurement of out of plane displacements.

Small Physical Size:

The small physical size and weight of the Mini camera range allows the use of conventional opto-mechanical hardware for rigid and stable mounting of multiple cameras, and for the location of cameras in space limited locations.

Specifications subject to change without notice.

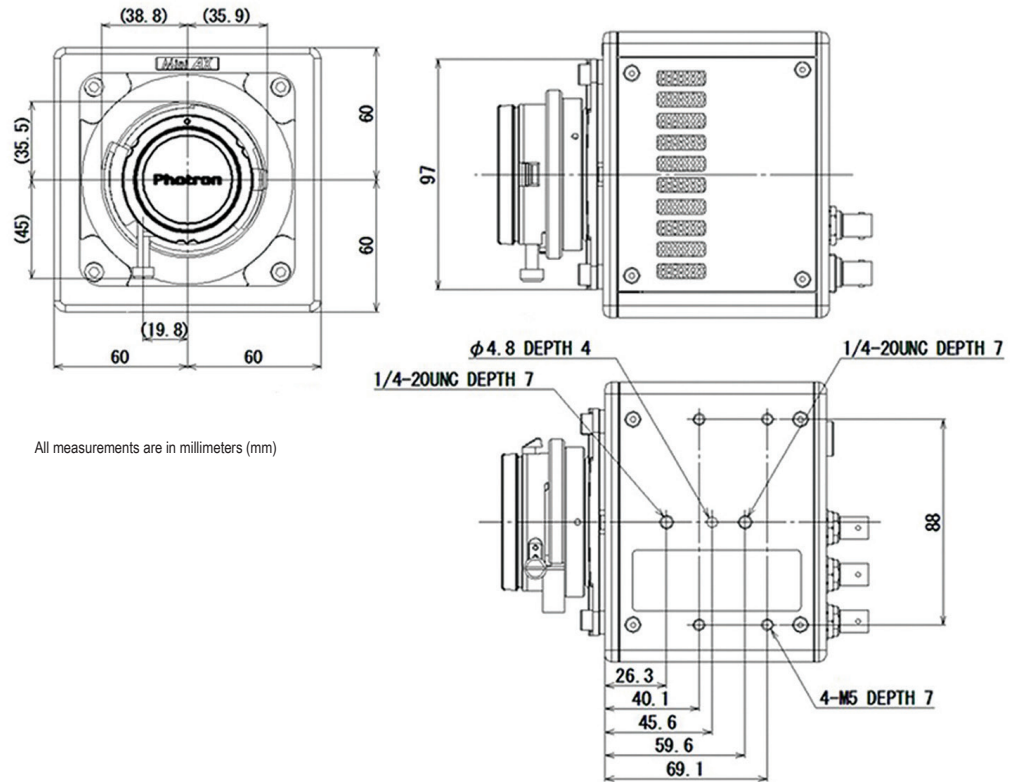

All measurements are in millimeters (mm)

Mechanical and Environmental Specifications

Mechanical

Lens Mount	F-mount (G-type lens compatible) and C-mount provided - Optional lens mounts available include M42 adapter
Camera Mountings	4 x 1/4 - 20 UNC (base and top), 4 x M5 (base)

External Dimensions

Camera Body (excluding protrusions)	120mm (H) x 120mm (W) x 94mm (D) 4.72" (H) x 4.72" (W) x 3.70" (D)
----------------------------------------	-----------------------------------------------------------------------

Weight

Camera Body	1.5kg (3.30lbs)
-------------	-----------------

Environmental

Operating Temperature	0 to 40C, 32° to 104°F
Storage Temperature	-20 to 60C, -4° to 140°F
Humidity	85% or less (non-condensing)
Cooling	Internal fan cooling (fan-off mode supported)
Operational Shock	100G, 10ms, 6-axes

Power

AC Power (with supplied adapter)	100 to 240V, 50 to 60Hz
DC Power	22 to 32V, 55VA

PHOTRON USA, INC.
9520 Padgett Street, Suite 110
San Diego, CA 92126
USA

Tel: 858.684.3555 or 800.585.2129
Fax: 858.684.3558
Email: image@photron.com
www.photron.com

PHOTRON EUROPE LIMITED
The Barn, Bottom Road
West Wycombe, Bucks. HP14 4BS
United Kingdom

Tel: +44 (0) 1494 481011
Fax: +44 (0) 1494 487011
Email: image@photron.com
www.photron.com

PHOTRON (Shanghai)
Room 20C, Zhao-Feng
World Trade Building
No. 369, JiangSu Road
ChangNing District
Shanghai, 200050 China
Tel: +86 (0) 21-5268-3700
Email: info@photron.cn.com
www.photron.cn.com

PHOTRON LIMITED
Kanda Jinbo-cho 1-105
Chiyoda-ku, Tokyo 101-0051
Japan

Tel: +81 (0) 3 3518-6271
Fax: +81 (0) 3 3518-6279
Email: image@photron.co.jp
www.photron.co.jp