

2209

Instruction Manual

Impulse Precision Sound Level Meter Type 2209

This portable sound level meter complies with all existing standards for impulse and precision sound level meters. It is equipped with: an individually calibrated condenser microphone; an internal reference voltage for calibration; "Lin.", "A", "B", "C", and "D" weighting networks; impulse and peak detectors with "Hold" circuits, as well as "Fast", "Slow" and "Impulse" meter responses; overload warning lamps; and an AC and DC output for connection to recorders, etc.. The 2209 can handle crest factors as high as 40, and has a selectable low-frequency cut-off. External filters can be directly attached, and a wide range of accessories is available.

The 2209 can also be connected to an accelerometer for the measurement of vibration. An interchangeable meter scale and a range of attenuator scales facilitate the direct reading of vibration (as well as sound or voltage) over a wide range.

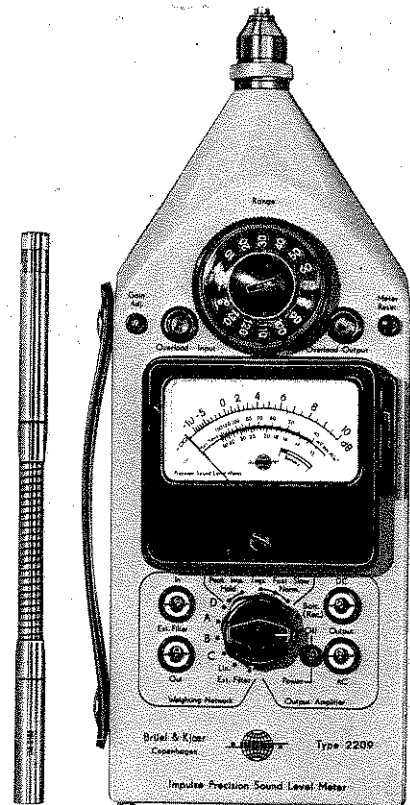

Brüel & Kjær

033-0232



**IMPULSE PRECISION
SOUND LEVEL METER
TYPE 2209**

Applicable to instruments from serial No. 594673

Revision December 1976

CONTENTS

| | | |
|------|---|----|
| 1. | INTRODUCTION AND SPECIFICATIONS (PRODUCT DATA) | 1 |
| 2. | CONTROLS | 9 |
| 3. | OPERATION | 14 |
| 3.1. | INTRODUCTION | 14 |
| 3.2. | PRELIMINARIES | 14 |
| | Battery Considerations | 14 |
| | Selection of Lower Limiting Frequency | 15 |
| | Mounting the Microphone | 15 |
| 3.3. | CALIBRATION FOR SOUND MEASUREMENTS | 16 |
| | General | 16 |
| | Acoustical Calibration (External Source) | 16 |
| | Calibration using Internal Reference Voltage | 18 |
| 3.4. | SOUND MEASUREMENTS | 18 |
| | General | 18 |
| | Procedure for Sound Measurements | 19 |
| 3.5. | CALIBRATION FOR VIBRATION MEASUREMENTS | 20 |
| | General | 20 |
| | Calibration using Accelerometer Calibrator Type 4291 — direct reading in vibration units | 21 |
| | Calibration using Internal Reference Voltage — direct reading in vibration units | 22 |
| | Calibration using Accelerometer Calibrator Type 4291 — meter reading in dB | 24 |
| | Calibration using Internal Reference Voltage — meter reading in dB | 24 |
| 3.6. | VIBRATION MEASUREMENTS | 25 |
| | General | 25 |
| | Procedure for Vibration Measurements | 25 |
| 3.7. | CONVERSION OF RESULTS IN dB TO VIBRATION UNITS | 26 |
| | With 4291 Calibration, Without Integrator | 27 |
| | With 4291 Calibration, With Integrator ZR 0020 | 28 |
| | With Internal Calibration, Without Integrator | 29 |
| | With Internal Calibration, With Integrator ZR 0020 | 29 |
| 3.8. | VOLTAGE CALIBRATION | 30 |
| 3.9. | VOLTAGE MEASUREMENTS | 30 |
| 4. | SPECIAL CHARACTERISTICS | 32 |
| 4.1. | GENERAL | 32 |

| | | |
|-----------|---|-----------|
| 4.2. | IMPULSE DETECTOR | 32 |
| 4.3. | PEAK DETECTOR | 33 |
| 4.4. | HOLD CIRCUIT | 34 |
| 4.5. | CREST-FACTOR CAPABILITIES | 34 |
| 4.6. | INPUT CAPACITANCE | 36 |
| 5. | ACCESSORIES | 37 |
| 6. | USE WITH OTHER INSTRUMENTS | 38 |
| 6.1. | GENERAL | 38 |
| 6.2. | LEVEL RECORDERS | 38 |
| | AC Recording | 38 |
| | DC Recording | 38 |
| 6.3. | TAPE RECORDERS | 40 |
| 6.4. | DIGITAL RECORDERS | 40 |

type 2209

Impulse Precision Sound and Vibration Meter

FEATURES:

- Complies with all existing standards for impulse and precision sound level meters
- Equipped with individually calibrated, high sensitivity, precision condenser microphone
- Conical shaped front-end for minimum disturbance of sound field
- RMS detector with crest-factor capability up to 40
- Peak detector with $20\mu\text{s}$ rise time and Hold facility
- Impulse detector with Max. RMS Hold facility
- "D", "A", "B", "C" and "Lin" frequency weighting
- 2 Hz or 10 Hz selectable low frequency cut-off
- Interchangeable meter and attenuator scales facilitate direct reading of sound and vibration figures
- Performs as Octave or Third-octave analyzer with system-matching filter sets
- AC and DC outputs for recorders etc.
- Overload indicators for both input and output amplifiers
- Performs as Vibration Meter or Analyzer combined with appropriate accessories
- Wide selection of accessories

USES:

- Noise and Vibration measurements for health protection
- Noise and Vibration measurements in industry for quality inspection and development
- Measurement of Shock and Maximum Acceleration
- Audiometer Calibration
- Acoustic Measurements
- Noise and Vibration Analysis with Filter Sets Type 1613 and Type 1616

The Impulse Precision Sound Level Meter Type 2209 provides the sound and vibration analyst with almost everything desirable in a single, portable measuring instrument. The A, B and C weighting networks as well as the D weighting network, intended for aircraft noise measurements, are built-in. The meter response may be switched to the standardized Slow, Fast and Impulse time constants, as well as to indicate the absolute peak value of the measured signal. The impulse facility of the instrument gives the feature of being able to measure the maximum of the short time RMS value of impulsive sounds (1 to 1000 ms) with a time weighting response in accordance with IEC Recommendation 179A. This puts strict requirements to the RMS detector which is able to handle signals with crest factors as high as 40 (10 at full scale deflection). The Peak mode allows objective measurements of signal peaks with duration as short as $20\mu\text{s}$, which is of importance both when determining

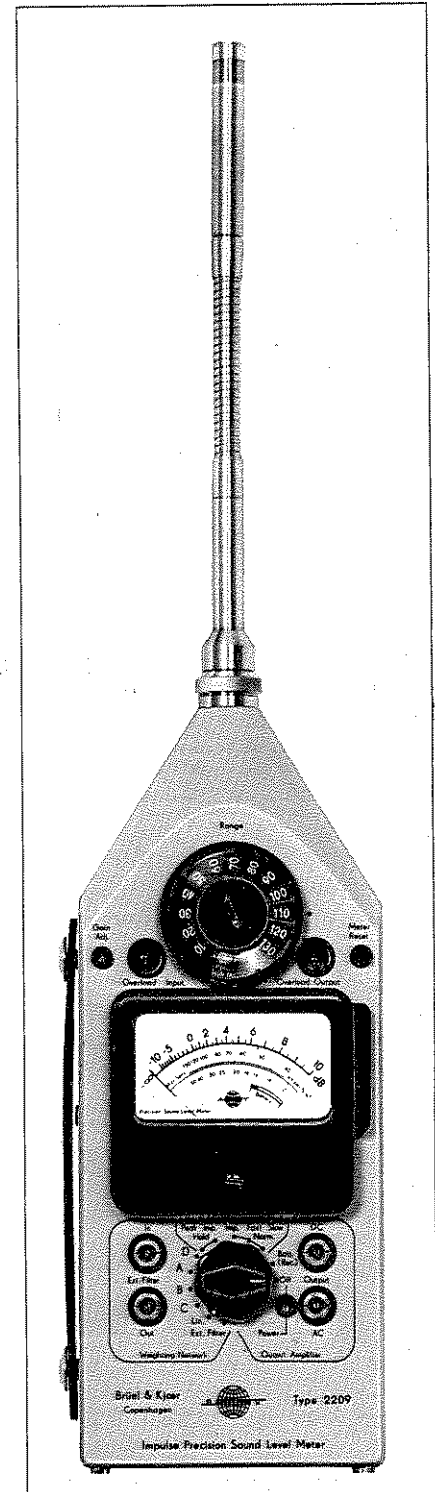

noise and when investigating vibration shocks. Overload indicators in both in- and output amplifiers give warning of excessive signal levels. To allow frequency analysis of the measured signal, the instrument is equipped with in- and output sockets for connection of external filters. AC and DC outputs give the possibility for connection of headphones, level recorders, tape recorders etc.

The instrument complies with the requirements of IEC 179 and 179A for precision and impulse sound level meters as well as DIN 45633 parts 1 and 2 and ANSI S1.4-1971 requirements for Type 1 sound level meters.

It is powered from 3 built-in standard batteries giving it a continuous operating time of 8 hours. Rechargeable NiCd-cells giving 14 hours of continuous operation may also be used. A built-in reference voltage provides easy electrical calibration of the instrument.

A unique feature of this instrument is its system of 20 interchangeable attenuator scales and its reversible meter scale, allowing it to be used both as a direct reading precision sound level meter and as a vibration meter, with a wide variety of microphone and accelerometer sensitivities. 20 interchangeable scales are supplied covering microphone sensitivities from 0,4 to 160 mV per Pa and accelerometer sensitivities from 1 to 285 mV per m/s^2 with indication in both metric and British units. Direct measurement of vibration velocity or displacement in addition to acceleration, can be made if an optional Integrator ZR 0020 is employed.

Sound Measurements

As standard, the instrument is equipped with a B & K high sensitivity, 1/2" diameter free-field Condenser Microphone Type 4165, giving it a measuring range from 24 to 140 dB(A) and a wide frequency range both in free and diffuse sound fields, due to its excellent omnidirectivity. The microphone is delivered with its own individual calibration chart giving all relevant calibration data and complete frequency response curve.

directly on the instrument, but should normally be mounted on the Extension Rod UA 0196, which is included, and which, together with the conical shaped front-end of the instrument secures the free-field characteristics required to fulfil the IEC, DIN and ANSI requirements to precision sound level meters. If it is desired to remove the microphone even further from the instrument, use can be made of the standard Brüel & Kjær microphone Extension Cables available in lengths of 3, 10 and 30 metres. The cables are inserted between the removable input stage and the Sound Level Meter and the influence of cable capacitance on calibration can therefore be neglected. The wide frequency range of the instrument, from 2 Hz to 70 kHz, together with appropriate microphones from B & K's wide range, enables measurements both up in the ultrasonic range and down in the infrasonic range. If desired, the frequency range can be limited downwards to 1.0 Hz by a screw switch in the input stage, to avoid the influence of low frequency pressure variations which might disturb normal measurements in the audible range.

A windscreen, which should be fitted over the microphone when measuring outdoors in order to reduce wind noise, is included. Also included is an input adaptor, to be fitted instead of the microphone, allowing direct electrical input, for instance from accelerometers or hydrophones. For measurement of Noise Dose as described in ISO R1999 and R1996 the Noise Dose Meter Type 4423 can be connected to the output.

Use with other Microphones. For measurement of higher levels and frequencies than is possible with the 1/2" microphone Type 4165, or if a linear random incidence microphone response is required, other 1/2" microphones from the B & K programme can be used directly, for instance Type 4133, 4134, 4163 or 4166. For measurement of lower levels, the 1" microphones Type 4145 or 4161 can be recommended. Adaptors DB 0962 and DB 0375 are available for fitting these microphones directly onto the input stage or onto the extension rod.

requirements to omnidirectivity, use 1" microphones mentioned require the use of a Random Incidence Corrector UA 0055 instead of the normal microphone protection grid. For special applications the sound level meter can be used with other microphones than described here, and the Product Data Sheet for the B & K microphone programme should be consulted. See also survey of accessories available on page 4, Fig.6.

Vibration Measurements

When the microphone is replaced by the Input Adaptor JJ 2614 (included) and one of the B & K accelerometers is connected, the instrument functions as a vibration meter. To give direct reading in vibration units, the meter scale is reversed and the attenuator scale which is calibrated to cover the sensitivity of the accelerometer chosen is fitted instead of the dB-calibrated scale for sound level measurement. If required, vibration velocity and displacement can be measured in addition to acceleration when an Integrator ZR 0020 is mounted between the accelerometer and sound

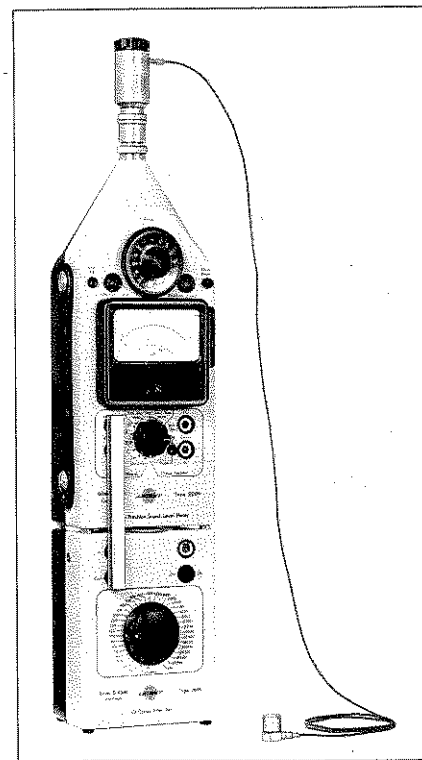

Fig.1. The sound level meter equipped with integrator and accelerometer for vibration measurements, and 1/3 octave filter for frequency analysis

level meter. Also in this case, reading is direct and can be in either British or metric units.

Calibration

Acoustical calibration, which also tests the microphone, can easily be made by either of the two calibrators available: Pistonphone Type 4220, which gives a SPL of 124 dB with $\pm 0,2$ dB accuracy at 250 Hz, and Sound Source Type 4230, which gives a SPL of 94 dB with $\pm 0,25$ dB accuracy at 1 kHz. When using the sound level meter for vibration measurements, complete calibration can be performed by means of the Portable Accelerometer Calibrator Type 4291, which calibrates at 1 g peak and 79,6 Hz.

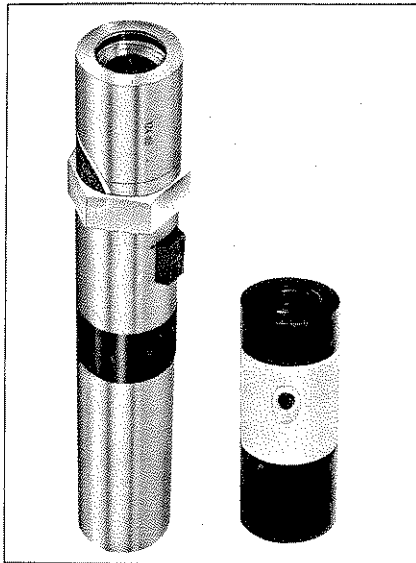

Fig.2. The Pistonphone Type 4220 and Sound Source Type 4230

Audiometer Calibration, Hearing Aid Testing

When the microphone is replaced by an Artificial Ear Type 4152 or 4153 with microphone 4144 or 4134 respectively, a precise, compact and fully portable audiometer calibrator is produced. If the Artificial Mastoid Type 4930 is connected instead of the microphone, measurements on bone vibrators and bone conduction hearing aids can be made, and if the sound level meter is used with Hearing Aid Test Box Type 4217, a complete test facility for hearing aids is created.

Frequency Analysis

For frequency analysis of the mea-

sured sound or vibration level, the Octave Filter Set Type 1613 or the Third-Octave Filter Set Type 1616 attaches directly onto the sound level meter, and connects electrically with a connection bar. Type 1613 contains 11 octave filters (with adjustable attenuation) with centre frequencies from 31,5 Hz to 31,5 kHz. Type 1616 contains 34 third octave filters with centre frequencies from 20 Hz to 40 kHz. Narrower band frequency analysis, as is often required for vibration analysis, can be made using the battery powered Tunable Filter Type 1621, which has bandwidths of 3% and 23%.



Fig.3. The portable Level Recorder Type 2306

Field Recording

When measuring in the field, the tedious work of plotting levels with a pencil can be completely eliminated by use of the small, portable, battery operated Level Recorder Type 2306. It connects via a cable to the output of the sound level meter and can record either sound levels as a function of time or, if the sound level meter is equipped with a filter, sound levels as a function of frequency. For time recordings, use can be made of very slow recording paper speeds, so that diagrams showing sound level variations over longer periods of time can be recorded on a reasonable length of paper. Such charts are of great help in almost any type of noise investigation and ease the location of noise events with respect to time as well as the possible source. Frequency spectrograms can be recorded directly on frequency calibrated paper, and can be made semi-automatically in a few

seconds, using the filters Type 1616 and 1621. The recorded spectrogram and time histories provide immediate documentation of the measurement made and can be inserted directly in the measurement report. If further investigation of the measured signal is required back in the laboratory, the battery operated, portable Tape Recorders Types 7003 and 7004 should be used.

Complete Sets

The instrument can be ordered with accessories according to requirement. However, to simplify ordering, four sets, containing the most commonly used accessories, have been assembled. There are two sets for sound and vibration measurements in the field, the difference being the filter included (Type 1613 or 1616), and two sets for audiometer calibration, again the difference being the filter included.

The sets combine complete portability with laboratory accuracy and are delivered in the sturdy fiberglass carrying case KE 0055 which has separate compartments for each item. The contents of the sets are listed below:

Sound and Vibration Sets Types 3507 and 3511

| | |
|---|-------------|
| Impulse Precision Sound Level Meter with standard accessories | 2209 |
| Octave Filter Set | 1613 |
| | (3507 only) |
| Third Octave Filter Set | 1616 |
| | (3511 only) |
| Pistonphone | 4220 |
| Accelerometer Set | 4366S |
| Microphone 1/2" | 4166 |
| Nose Cone 1/2" | UA 0386 |
| Integrator | ZR 0020 |
| Adaptor for Tripod | UA 0354 |
| Extension Cable | AO 0027 |
| Carrying Case | KE 0055 |

Audiometer Calibrators Types 3508 and 3512

| | |
|---|-------------|
| Impulse Precision Sound Level Meter with standard accessories | 2209 |
| Octave Filter Set | 1613 |
| | (3508 only) |
| Third Octave Filter Set | 1616 |
| | (3512 only) |
| Pistonphone | 4220 |
| Artificial Ear | 4152 |
| Microphone 1" | 4144 |
| 1" Adaptor | DB 0375 |
| Carrying Case | KE 0055 |

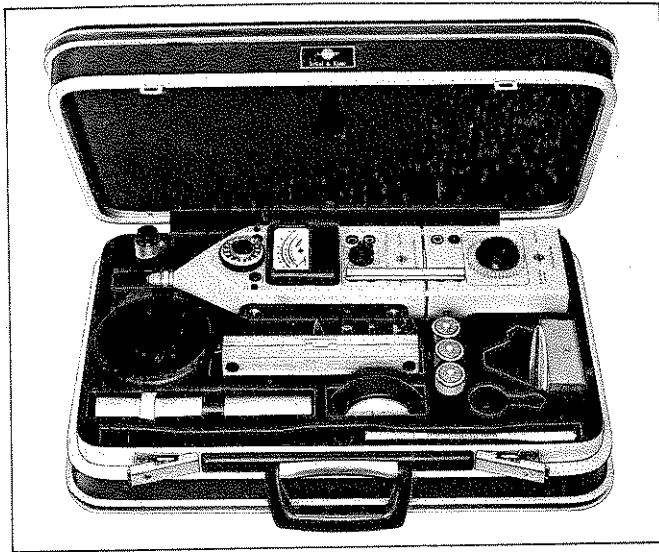

Fig.4. The Sound and Vibration Set Type 3511

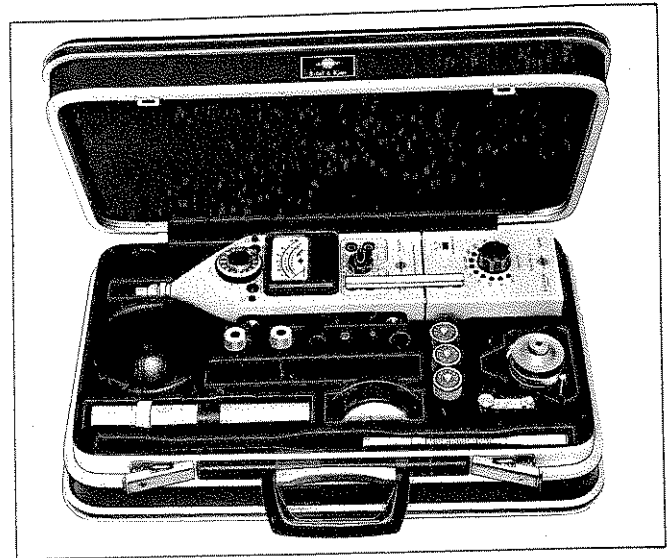

Fig.5. The Audiometer Calibrator Type 3508

Accessories

A wide selection of accessory equipment is available to expand the application possibilities of the sound level meter. A survey showing the connection possibilities of the most useful items is given in Fig.6. For more information on the individual instruments and transducers indicated, please ask for separate data sheets.

Description

The impulse Precision Sound Level Meter Type 2209 contains a condenser microphone, a removable preamplifier input stage, a low noise amplifier and a detector circuit with a moving coil meter. A built-in reference signal provides a ready check of the amplifier and meter circuit. A power supply delivers stabilized voltages to the amplifier circuits and polarization voltage for the microphone.

Microphone

The B & K microphone Type 4165 employed in the sound level meter,

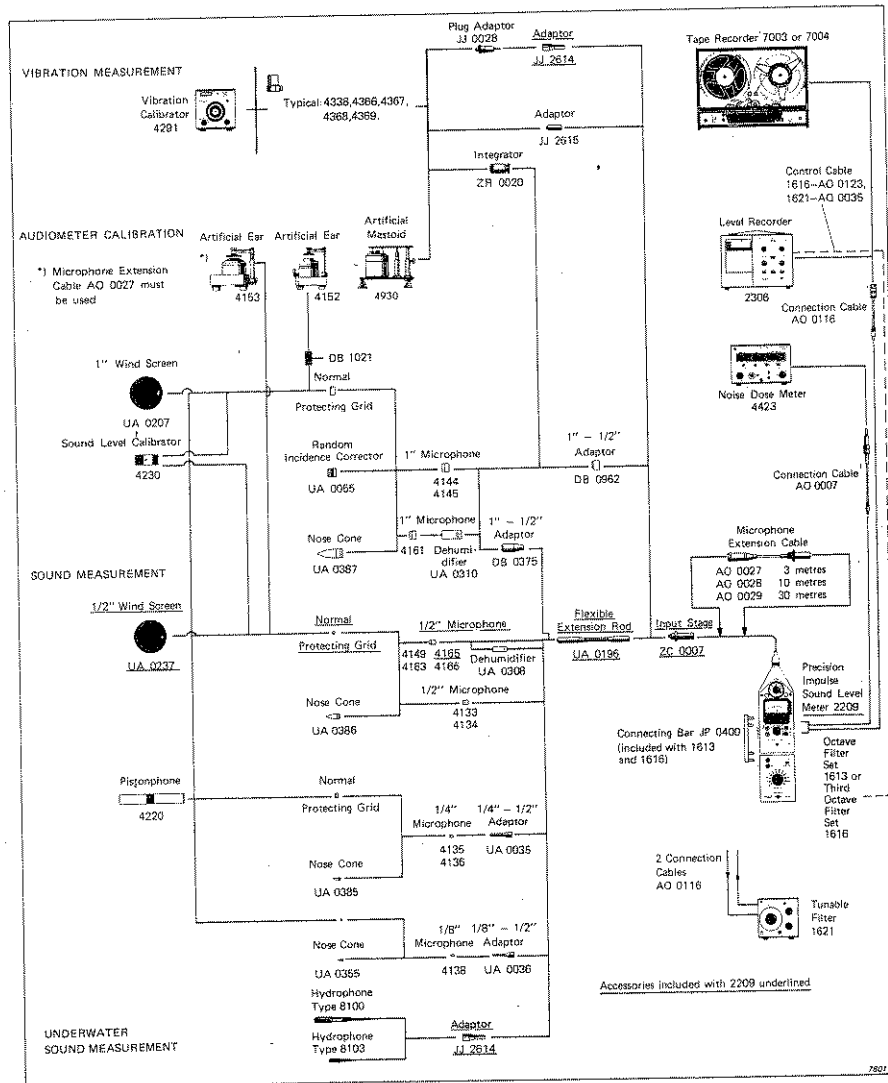

Fig.6. Survey of accessories available for sound and vibration measurements and audiometer calibration

is a precision condenser microphone. It is designed to have a linear frequency response for free-field sound measurements and 0° angle of incidence (perpendicular to microphone diaphragm). The microphone has excellent directional characteristics over a wide frequency range. These characteristics, of the microphone alone and of the complete instrument, are shown in Figs.16 and 17 on page 7. Figs.7 and 8 show the frequency response curves of the complete instrument for 0° incidence sine waves and in a diffuse field. All curves are well within the requirements of the relevant standards. A calibration chart with frequency response curve and sensitivity data (individually determined for each microphone) is supplied with the sound level meter. The microphone is extremely reliable and unaffected by humidity and temperature variations over a wide range. The diaphragm is quartz-coated to offer protection in humid and corrosive atmospheres and back venting allows it to be used with the Dehumidifier UA 0308 for further protection in humid environments. The sensitivity of the microphone is typically 50 mV/Pa (5 mV/ μ bar) with a polarization voltage of 200 volts.

Amplifier

The removable input stage of the amplifier has an extremely high in-

put impedance, to match the high impedance of transducers such as condenser microphones and piezoelectric accelerometers. A switch, built into the preamplifier, allows the low frequency cut-off to be

switched between 2 and 10Hz. See also Fig.10. Following the input stage are the input amplifier and output amplifier, between which the built-in weighting networks A, B, C or D or external filters can be inserted.

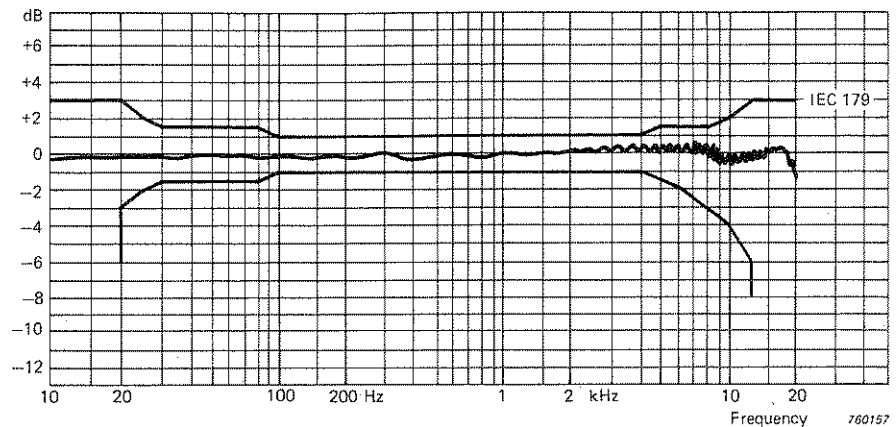

Fig. 7. Free-field frequency response of complete instrument to sine waves with 0° incidence

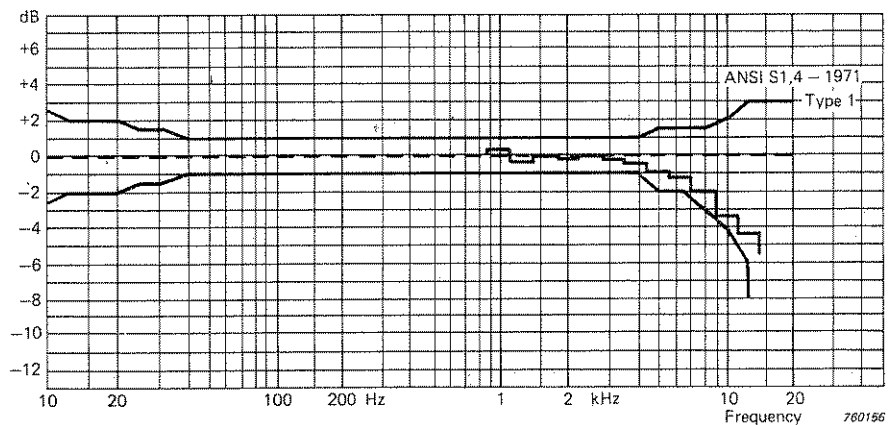

Fig. 8. Diffuse field (random incidence) frequency response of complete instrument

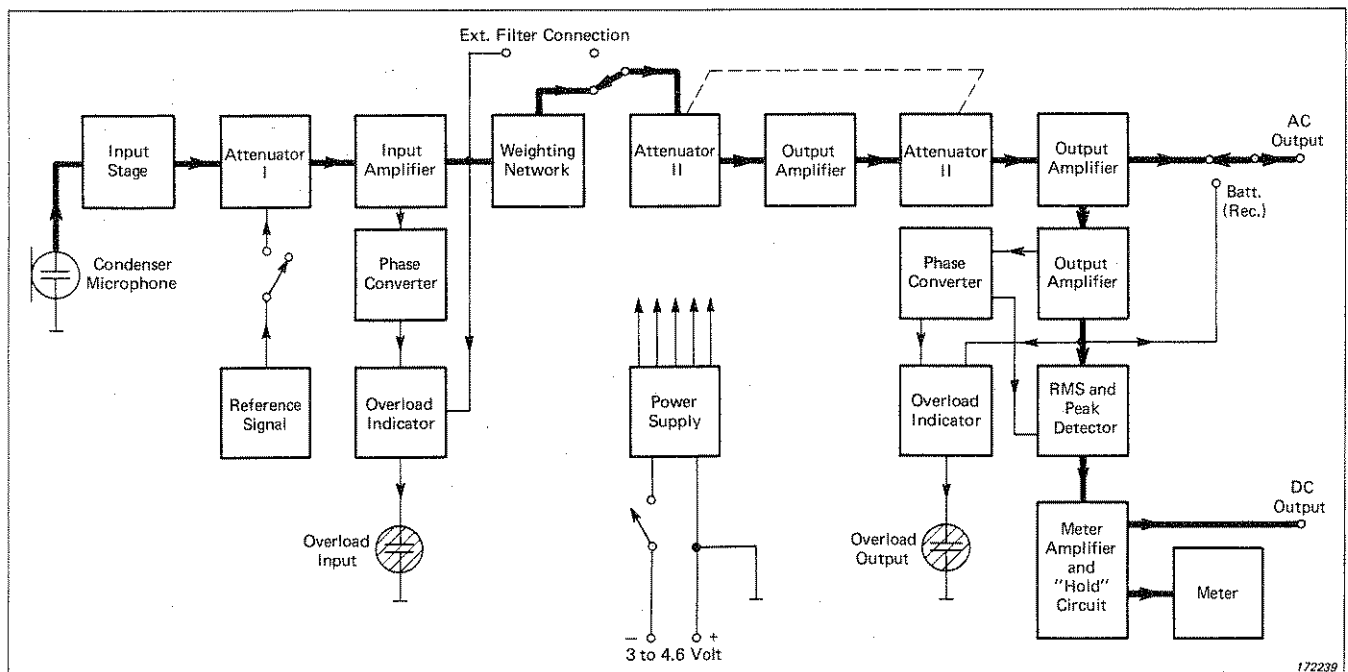

Fig. 9. Block diagram of Type 2209

The input amplifier and the two first sections of the output amplifier are preceded by attenuators which are controlled by the two concentric measuring range selectors on the front panel. The second section of the output amplifier supplies 0.5V RMS at full scale deflection to the AC output socket. This voltage can be increased to 5V RMS when the

meter switch is set to "Batt. (Rec.);" position, which, however, puts some limitations to the allowable load at the output. The third section of the output amplifier drives the meter detectors. As short duration, high amplitude peaks in the measured signal can readily overload the amplifiers without resulting in meter overdeflection, overload indi-

cators are provided for both input and output amplifiers. These indicators will respond to either positive or negative peaks of a duration as short as $50\mu\text{s}$ and will continue to flash for about 1 s after overload.

Detector

The detector is of the RMS type and is equipped with three time constants, "Fast", "Slow" and "Impulse" in accordance with the standard requirements for Precision and Impulse sound level meters. Fig.12 shows the response of the circuits to tone bursts of varying duration. The decay time of the impulse circuit is 3 s, as required by the standards.

An "Impulse Hold" mode, where the RMS value measured with the Impulse time constant is stored in the Hold circuit, is introduced for easy measurement of the max. RMS value of, for instance, impulsive sounds or impacts.

To enable the instrument to measure the Peak value of signals, the time constant of the RMS circuit is reduced to approx. $10\mu\text{s}$ in the "Peak Hold" position. The output of the detector is then stored in the hold circuit in order to obtain a signal of sufficient duration to allow the meter pointer to deflect. Other time constants can be obtained by a small internal modification. A DC output of 0.8V for full scale deflection is available from the detector circuit. The meter is a ribbon suspended moving coil type. The meter scale is graduated from -10 to $+10$ dB on its "Sound Level Meter" side and from 0 to 10 and 0 to 30 on its "Vibration Meter" side. Addi-

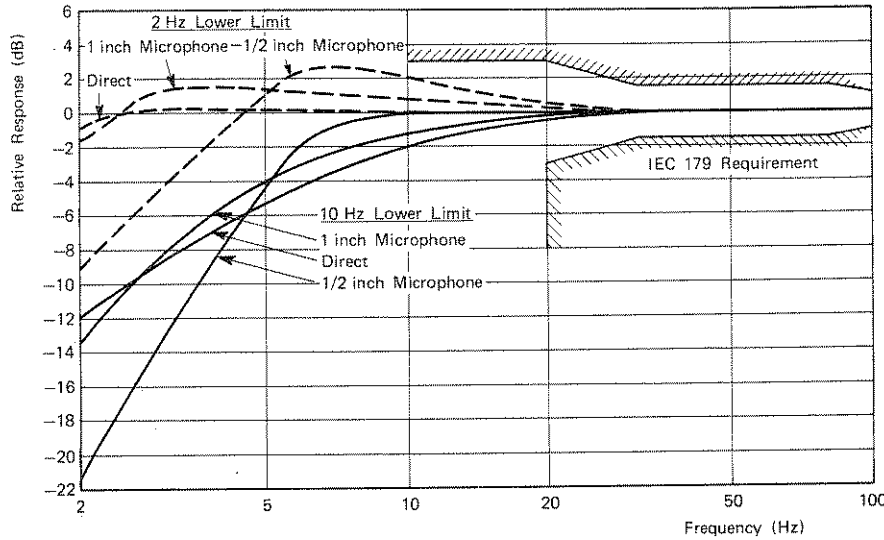

Fig.10. The adjustable low frequency responses of the instrument with 1" and 1/2" microphones

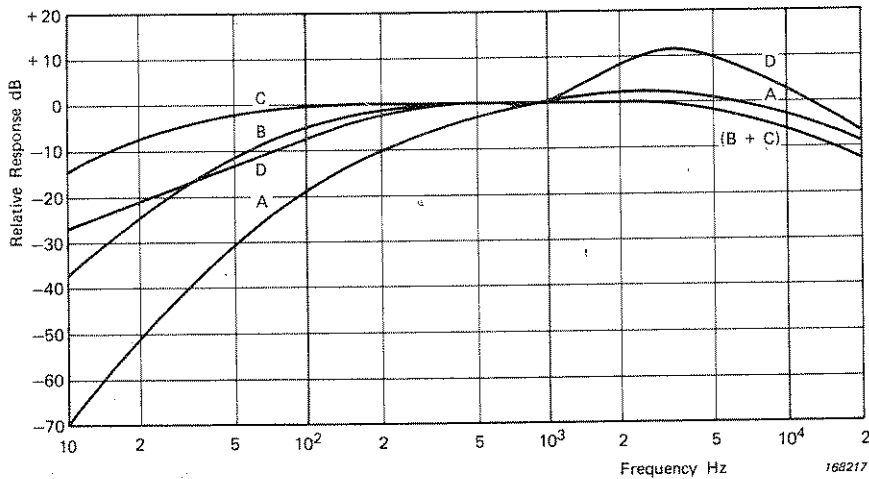

Fig.11. Frequency response curves of the A, B, C and D weighting networks

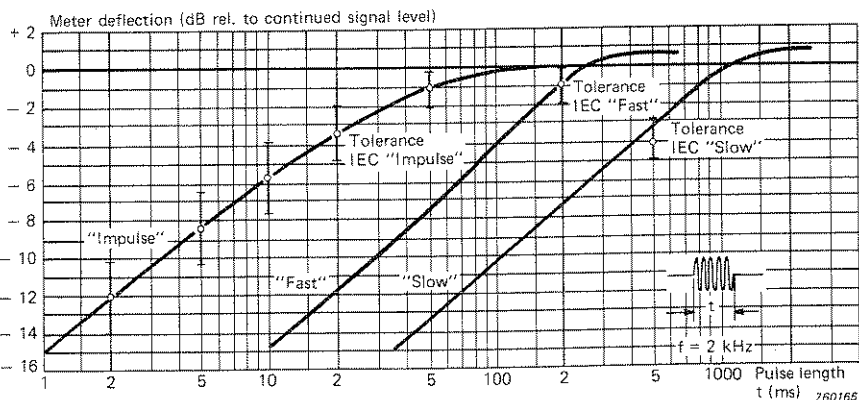

Fig.12. Response of meter rectifier and meter to tone bursts of varying duration

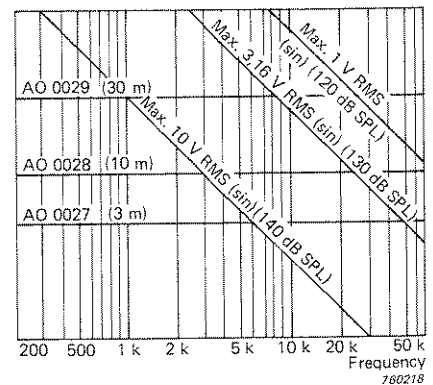

Fig.13. Maximum permissible input voltage with different lengths of extension cable at input, as a function of frequency

tional graduations on both sides allow easy calibration by means of the built-in reference voltage. The scales also include graduations so that battery condition can be read from the meter.

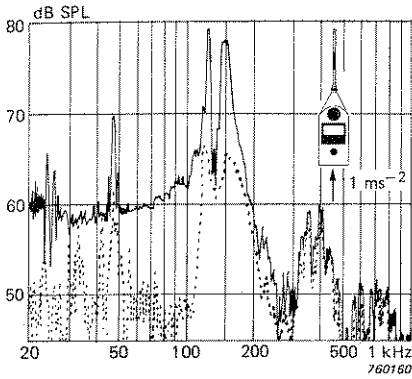

Fig. 14. Equivalent sound pressure level when complete sound level meter is excited vertically at 1 m/s^2 . The dotted line indicates sound level produced by vibration exciter

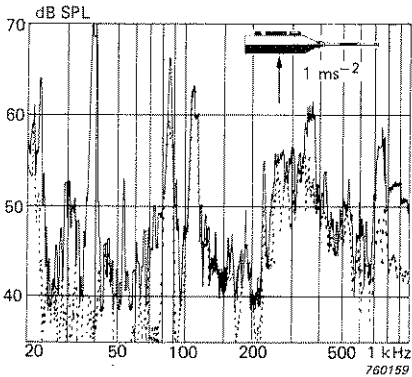

Fig. 15. Equivalent sound pressure level when complete sound level meter is excited horizontally at 1 m/s^2 . The dotted line indicates sound level produced by vibration exciter

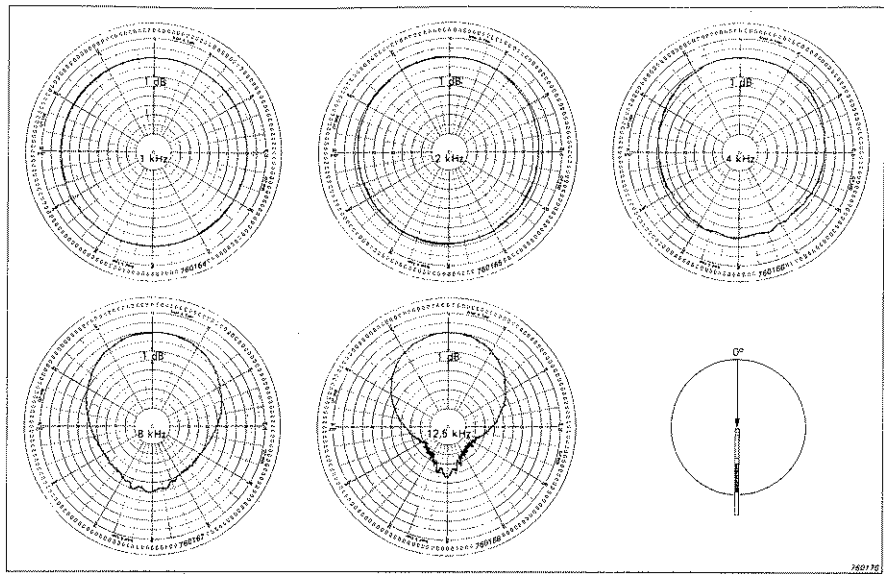

Fig. 16. Directional characteristics of the microphone Type 4165 in a free-field

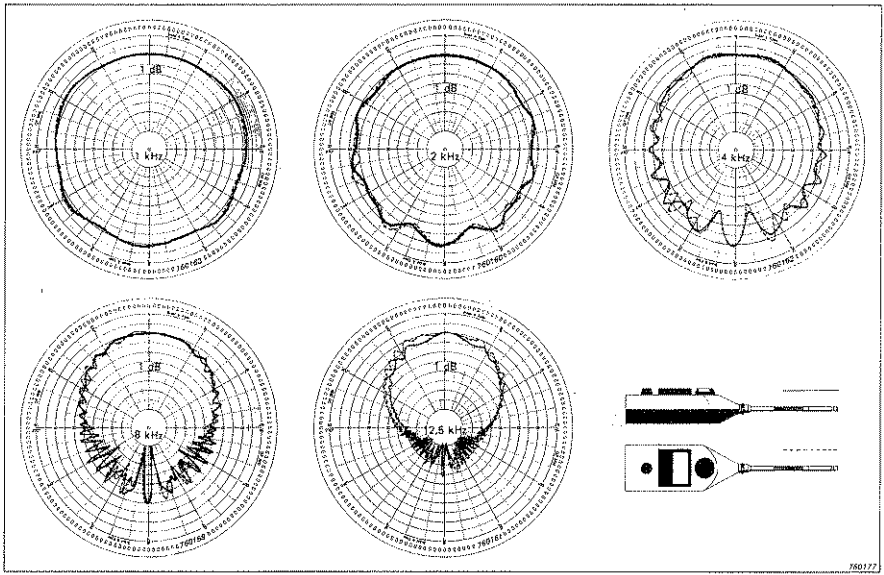

Fig. 17. Directional characteristics of the complete instrument inclusive microphone and extension rod in a free-field

Specifications 2209

(Specifications refer to 2209 with Extension Rod UA 0196 and Microphone 4165, unless otherwise stated)

Measuring Ranges:

| Microphone Type No. | Max. Level (dB) | Minimum Level (dB) | | | | | | | | | | | |
|---------------------|-----------------|--------------------|----|-----|---------------|-----------------|---------------------------|----------------|-------------------------|-------------------|----|----|----|
| | | Weighting Network | | | | | External Filter Type No. | | | | | | |
| | | | | | | | 1613 (Octave) | | | 1616 (1/3 Octave) | | | |
| D | A | B | C | Lin | 31,5 63 Hz | 125 — 250 Hz | 0,5 — 16 (31,5) kHz | 20 — 400 Hz | 0,5 — 16 (40) kHz | Lin | | | |
| 1" | 4144 — 4145 | 140 | 25 | 18 | 22 | 24 | 36 | 23 | 18 | 15 | 17 | 17 | 28 |
| 1/2" | 4165* — 4166 | 140 | 34 | 24 | 28 | 34 | 42 | 33 | 28 | 22 | 25 | 19 | 32 |
| 1/2" | 4133 — 4134 | 150 | 46 | 36 | 40 | 46 | 56 | 45 | 40 | 34 | 37 | 31 | 44 |

* Included in 2209

Frequency Response: (Microphone)*

(zero degree incidence, free-field)

$\pm 1 \text{ dB}$: 4 Hz to 12,5 kHz

$\pm 2 \text{ dB}$: 3 Hz to 20 kHz

*) individually calibrated

(see also curves Figs. 7 and 8)

Frequency Response: (Amplifier)

$\pm 0,5 \text{ dB}$: 5 Hz (20 Hz) to 30 kHz

$\pm 1 \text{ dB}$: 2 Hz (10 Hz) to 70 kHz

(Figures in parenthesis obtainable by switch in input stage)

Frequency Weighting:

A, B and C to IEC 179
D to IEC proposal
(See Fig. 11.)

Input Impedance:

> 1 G Ω // < 0,5 pF

Maximum Input Voltage:

10 V RMS (sinusoidal) (See also Fig. 13.)

Overload Indicators:

Indicate overloads over 50 μ s in duration

Total Amplification:

114 dB

Attenuators:

20 to 140 dB FSD in 10 dB steps
Accuracy: 5 Hz to 50 kHz \pm 0,2 dB
2 Hz to 80 kHz \pm 0,5 dB

Output Impedance: (load does not affect meter deflection)

AC: 600 Ω (200 Ω in pos. "Batt. (Rec.)" max. load 10 k Ω // 200 pF, noise at least 50 dB below FSD voltage)
DC: 25 k Ω

Output Voltage:

AC: 0,5 V RMS for FSD (5 V in "Batt. (Rec.)" mode, max. 100 V peak-to-peak)
DC: 0,8 V for FSD (dynamic range 25 dB)

External Filter Sockets:

Output Impedance: < 5 Ω in series with 470 μ F (max. load 500 Ω)
Input Impedance: 146 k Ω

Inherent Noise:

Linear:
2 Hz to 70 kHz:
Max. 30 μ V referred to input*
10 Hz to 70 kHz:
Max. 30 μ V referred to input**
Curve A:
Max. 2,8 μ V referred to input**
*300 pF across input, **60 pF across input

Detector:

RMS (in pos. "Imp. Hold", "Imp.", "Fast" and "Slow")
Crest Factor Capability:
10 at FSD increasing to
40 at 12 dB below FSD
Meter Accuracy: (For crest factors up to 10)
 \pm 0,5 dB from FSD to 12 dB below FSD
 \pm 1 dB from 12 dB to 20 dB below FSD
(These limits are increased by 0,5 dB for crest factors between 10 and 20 and by

1 dB for crest factors between 20 and 40)

PEAK: (in pos. "Peak Hold")

Rise Time: < 20 μ s

Meter Accuracy: \pm 0,5 dB from FSD to 12 dB below FSD

Frequency Response: \pm 1 dB from 2 Hz (or 10 Hz) to 16 kHz

Meter Damping:

"Fast" and "Slow": to IEC 179

"Impulse": to IEC 179A

"Impulse Hold": decay time < 0,05 dB/s

"Peak Hold": decay time < 0,05 dB/s, rise time < 20 μ s

Microphone Sensitivity:

Approx. 50 mV/Pa, individually calibrated

Microphone Temperature Coefficient:

Approx. -0,01 dB/ $^{\circ}$ C

Microphone Temperature Range:

-50 to + 60 $^{\circ}$ C

Microphone Long Term Stability:

1 dB/300 years at operating temperature 27 $^{\circ}$ C
At 100 $^{\circ}$ C, typically 1 dB per 100 hours

Polarization Voltage:

200 V

Calibration:

Internal 2 kHz oscillator, stability better than \pm 0,2 dB

Directional Characteristics:

See curves Figs. 16 and 17

Amplifier Sensitivity Adjustment:

+ 3 dB to -10 dB

Reference Conditions for Calibration Validity:

Type of Sound Field: Free
Ref. Direction of Incidence: Perpendicular to microphone diaphragm
Ref. Sound Pressure: 20 μ Pa
Ref. Sound Pressure Level: 84 dB
Ref. Frequency: 1 kHz
Ref. Temperature: 20 $^{\circ}$ C
Ref. Measuring Range: 80 dB (90 dB FSD)

Absolute Accuracy at Reference conditions:

\pm 0,7 dB

Effect of Humidity:

< 0,5 dB from 0 to 90% RH provided no condensation occurs

Effect of Vibration:

See curves Fig. 14 and Fig. 15

Effect of Sound Field:

At least 60 dB below sensitivity of microphone 4165

Effect of Ambient Pressure:

Approx. 0,001 dB per mbar at 1013 mbar (1 mbar = 10 2 Pa)

Effect of Electrostatic Field:

Negligible with microphone grid fitted

Effect of Electromagnetic Field:

80 A/m (1 \varnothing sted) (50 Hz) gives:
< 28 dB(D)
< 18 dB(A)
< 28 dB(B)
< 36 dB(C)
< 36 dB(Lin)

Effect of Temperature:

-10 to 50 $^{\circ}$ C (14 to 122 $^{\circ}$ F) \pm 0,5 dB

Batteries:

3 \times 1,5 V. IEC Type R 20 (B & K order No. QB 0004)

Battery Life: (Continuous operation)

8 hours with standard batteries (Varta Super Dry 282)
(National Neo Hi-Top UM 1NE)
20 Hours with Alkaline batteries (Mallory MN 1300)
14 hours with rechargeable NiCd-cells (B & K order No. QB 0008, 3rpd.) (Saft Volta block VR 4D)
(Varta RS 4)
Recharging from Power Supply Type 2808, Battery Box ZG 0073 and Charging Adaptor AQ 0043 + 3 Dummy Cells ZR 0017

Dimensions:

90 \times 120 \times 550 mm (4 \times 5 \times 21,7 in)
(320 mm, (12,7 in) without extension rod)

Weight:

3 kg (6,7 lb)

Accessories included:

1/2" Condenser Microphone 4165
Input Stage ZC 0007
Flexible Extension Rod UA 0196
Input Adaptor JJ 2614
Windscreen UA 0237
4 Screened Plugs JP 0006
Attenuator Scales SA 0012 to SA 0021
Screwdriver AQ 0001

Accessories Available:

See survey Fig. 6

2. CONTROLS

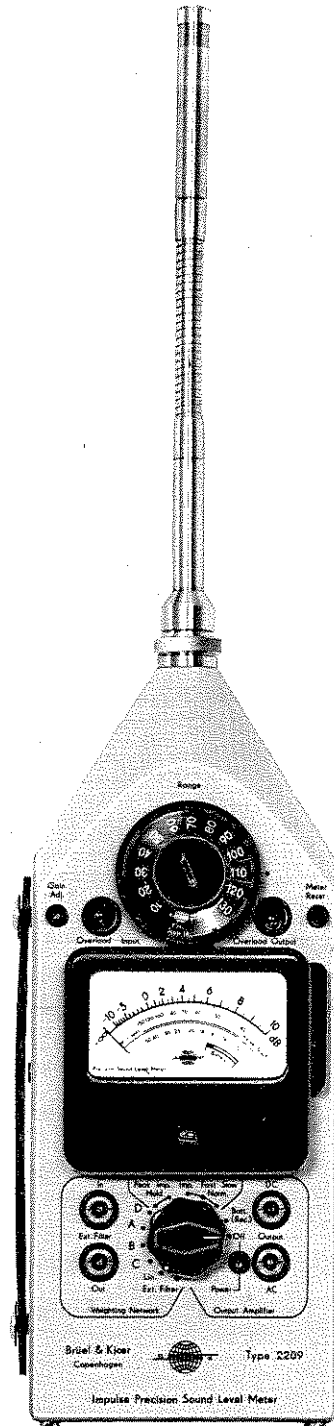

Fig.2.1. Front view of 2209

MICROPHONE: Half-inch condenser Microphone Type 4165.

PROTECTION GRID: Protects the diaphragm of the microphone from physical damage. This grid should not be removed, except when the microphone is to be fitted with a Nose Cone or Rain Cover, or for inspection of the diaphragm. DO NOT TOUCH THE DIAPHRAGM WITH ANY OBJECT.

EXTENSION ROD UA 0196: This flexible extension rod connects the microphone to the sound level meter at a sufficient distance that the influence of the body of the sound level meter and operator on the sound field is minimized. This extension rod must be used in order for the instrument to conform to precision standards.

If a Dehumidifier Type UA 0308 is used, it is placed between the microphone and the extension rod.

When screwing the microphone, extension rod, and sound level meter together, only light finger torque should be used.

METER SWITCH: This 7-position rotary switch is both the power switch and meter function selector, with positions as follows:

"Off": Power off position. In all the other positions the power is on, and the POWER lamp flashes.

"Batt.(Rec.)": Battery check position. If the meter needle deflection is below the red area, the batteries must be replaced. If the meter needle deflection is on the red block, the instrument may be used for a short time before battery replacement is necessary. A higher meter needle deflection indicates sufficient battery power.

"Slow": Provides a "Slow" meter response. (See Fig.12 in Chapter 1.)

"Fast": Provides a "Fast" meter response. (See Fig.12 in Chapter 1.)

"Imp.": Provides the "Impulse" meter response for measurement of subjective level of short-duration sounds. (See Fig.12 in Chapter 1.)

"Imp. Hold": Holds the maximum RMS value of the applied signal until the METER RESET button is depressed. Rise time is the same as that for "Imp." response; decay rate is $< 0,05 \text{ dB/s}$.

"Peak Hold": Holds the maximum peak value of the applied signal until the METER RESET button is depressed. Rise time is $< 20 \mu\text{s}$.

POWER: This lamp flashes when the instrument is switched on.

WEIGHTING NETWORK SWITCH: This 6-position switch determines the frequency-response characteristics of the instrument's electronics, and the selection of an external filter, as follows:

"A", "B", "C", "D": Each of these 4 positions selects one of the standardized frequency-weighting networks for the subjective indication of loudness. (See Fig.11 in Chapter 1.)

"Lin.": Gives linear frequency response from 2 Hz (or 10 Hz; see section 3.2.2) to 70 kHz.

"Ext. Filter": Selects an external filter connected to the EXTERNAL FILTER sockets. No meter needle deflection will be obtained in this position if a filter is not connected.

METER SCALE:

This is a double-sided scale which may be removed by sliding it out to the right. One side is calibrated for precision sound level measurements and the other side for vibration (or voltage) measurements.

"Precision Sound Level Meter" scale: The upper scale (black) is calibrated from "-10" dB to "+10" dB for the reading of sound level. "0" dB on the scale corresponds to the attenuator setting indicated inside the red lines. Thus, for example, if the meter shows "-2" dB and the attenuator setting is "70" dB, then the sound level is 68 dB. The lower scale (red) is used for calibration of the instrument using the sensitivity of the microphone which is found on its individual calibration chart. When checking the batteries (with the METER SWITCH in "Batt. (Rec.)" position), the meter needle deflection must be within the black lines labelled "Battery" on the lowest meter scale, and above the red block for long-term use.

"Vibration Meter" scale: The upper scale (black) is calibrated from "0" to "10" and "0" to "31,6" in linear units. The vibration level (or voltage) is then the meter reading referenced to the full-scale deflection shown inside the red lines, when the appropriate ATTENUATOR SCALE is fitted. The lower scale (red) is used for calibration of the instrument using the sensitivity of the accelerometer (see section 3.5.3) which is found on its individual calibration chart. The "Battery" check scale is the same as the one on the other side of the METER SCALE.

METER MECHANICAL ZERO ADJUSTMENT:

The screw head just below the METER SCALE is adjusted with the instrument switched off to give a meter needle deflection on the "-∞" mark ("Precision Sound Level Meter" scale) or the "0" mark ("Vibration Meter" scale).

METER RESET:

This push button resets the meter when using the "Imp. Hold" or "Peak Hold" position.

INPUT SOCKET SWITCH:

This screwdriver-operated switch is located in the centre of the input-stage socket; see section 3.2.2. The lower frequency limit of the instrument is 2 Hz with this switch fully clockwise and 10 Hz with it fully anticlockwise.

Since the 2209 can measure sound levels (and vibration levels or voltages) over a wide dynamic range (from 24 dB to 140 dB for sound levels, for example) but the METER SCALE can only accurately display 20 dB of this range at a time, an attenuator system is necessary to set the range of the instrument so that the sound level (or vibration level or voltage) will be within the 20 dB indicated on the METER SCALE. In order to minimize the chances of an overload, and to give the best possible signal-to-noise ratio, a dual attenuator system consisting of INPUT and OUTPUT ATTENUATORS is used. The correct use of these switches is described in Chapter 3, Operation.

- INPUT ATTENUATOR (black):** This 9-position switch controls the gain of the input amplifier in 10 dB steps, and also selects the internal reference voltage. The range of this switch is physically limited to a position from "60" dB to "Ref." being adjacent to the black spot. (If ATTENUATOR SCALES other than No. 1A are used, then different values will be noted.) Maximum input gain is obtained in the fully clockwise position; and the internal reference voltage is selected in the fully anticlockwise position (provided the transparent OUTPUT ATTENUATOR is also set to its fully clockwise position).
- OUTPUT ATTENUATOR (transparent):** This 6-position switch controls the gain of the output amplifier in 10 dB steps. The range of rotation of this switch is physically limited so that the red lines on the knob may only be moved anticlockwise from the black dot. Maximum output gain is obtained in the fully anticlockwise position, while the minimum output gain (red lines by the black dot) is recommended for use whenever possible.
- The total gain setting depends on both INPUT and OUTPUT ATTENUATOR positions; the measuring range corresponding to the gain setting is always directly indicated between the red lines on the knob.**
- ATTENUATOR SCALE:** Ten reversible ATTENUATOR SCALES are provided with the 2209 to permit direct reading of virtually any sound, vibration or voltage unit within the range of the instrument. The SCALES are changed by unscrewing the large screw in the centre of the attenuator knobs with a coin or a large screwdriver and removing the transparent knob. Ensure that the small cut-out in the SCALE by the "Ref." mark is correctly located over the pin in the black knob, and then refit the transparent knob (ensuring its correct location) and the screw.
- GAIN ADJ.:** This screwdriver-operated potentiometer is used for adjusting the gain of the input amplifier over a range of 13 dB to permit calibration with various transducer sensitivities. It is adjustable from -10 dB to + 3 dB.
- INPUT and OUTPUT OVERLOAD:** Separate flashing lamps indicate any overload of the input and/or output amplifiers. The INPUT and/or OUTPUT ATTENUATORS should be adjusted as necessary to remove the indicated overload which will otherwise give erroneous readings. If an overload cannot be removed, it should be noted with the measurements.
- EXTERNAL FILTER IN:** Socket for connection to the input of an external filter (such as Octave Filter Set Type 1613 or 1/3 Octave Filter Set Type 1616). The minimum load impedance of the socket is 500 Ω . Accepts plug JP 0006 or cable AO 0007, etc..
- EXTERNAL FILTER OUT:** Socket for connection to the output of an external filter to the 2209. Input impedance of the socket is 146 k Ω . The maximum input voltage is 0,2 V RMS, 2 V Peak. Accepts plug JP 0006 or cable AO 0007, etc..

The EXTERNAL FILTER IN and OUT sockets may be connected to a 1613 or a 1616 directly by means of the Connection Bar JP 0400 supplied with each filter.

DC OUTPUT:

This socket provides a DC voltage from the meter rectifier, giving 0,8 V (open circuit) for full-scale meter needle deflection, with an output impedance of 25 k Ω . The meter reading is not affected by loading this socket. Accepts plug JP 0006 or cable AO 0007, etc..

AC OUTPUT:

This socket provides an AC voltage from the output amplifier. With the METER SWITCH set to "Batt. (Rec.)", the output is 5 V RMS (for full-scale deflection) into a load of not less than 10 k Ω . With the METER SWITCH set to "Slow", "Fast", "Imp.", "Imp. Hold", or "Peak Hold", the output is 0,5 V RMS (for full-scale deflection) with an output impedance of 600 Ω , and any load may be applied without affecting the meter reading. These output voltages are open-circuit values, and are suitable for use with a Tape Recorder, etc.. Accepts plug JP 0006 or cable AO 0007, etc..

TRIPOD-MOUNTING THREADS:

There are two tripod-mounting threads on the rear of the 2209, the upper for mounting the 2209 alone, and the lower for mounting the 2209 when fitted with a filter set (Type 1613 or 1616). For vertical mounting, a thread is also provided on the bottom of the 2209.

3. OPERATION

3.1. INTRODUCTION

This Instruction Manual describes the specific procedures necessary to correctly use the Impulse Precision Sound Level Meter Type 2209. However, there are many aspects of sound measurement of a more general nature that are important to consider in order to get correct reproducible measurements. Many of these are discussed in the accompanying booklet, "Measuring Sound", which should be considered as part of this Instruction Manual.

3.2. PRELIMINARIES

3.2.1. Battery Considerations

The 2209 is powered by three standard torch batteries (D cells or Type R 20 in IEC Publication 86-2). Access to the batteries is gained by sliding the rear cover off the instrument. The batteries should be inserted with polarities as shown in the battery compartment. See Fig.3.1.

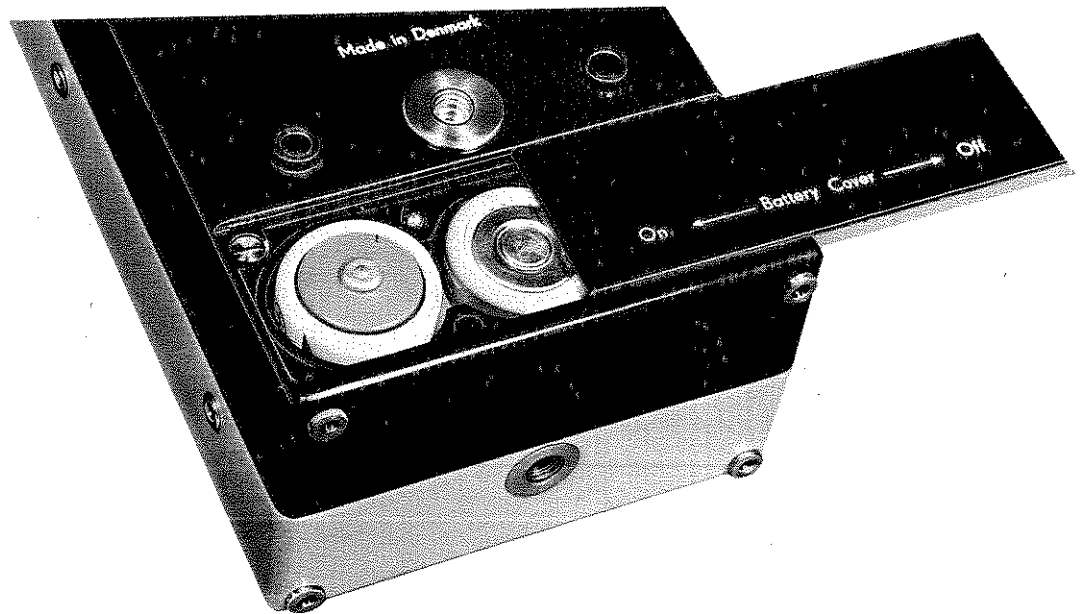

Fig.3.1. Battery compartment of 2209

Good-quality dry cells give an operating time of 8 hours, while alkaline cells such as Moly Duracell MN 1300 give 20 hours of continuous operation. Rechargeable nickel-cadmium cells may also be used, giving an operating time of 14 hours. These cells may be recharged using the Power Supply Type 2808 with Battery Box ZG 0073 and Charge Adaptor AQ 0043 — see the 2808 Instruction Manual.

The 2209 may also be powered directly from the mains using Mains Power Supply WB 0073 which is inserted in the battery compartment. If operated with Hearing Aid Test Box Type 4217 it may be powered by Power Supply Adaptor UA 0364 as described in the 4217 Instruction Manual.

The batteries should be removed from the instrument if it is not used for a long time to prevent possible battery leakage.

3.2.2. Selection of Lower Limiting Frequency

A switch is incorporated into the input-stage socket of the 2209, which acts as a low-frequency cut-off adjustment. (See Fig.3.2.) Access to this screwdriver-operated switch is achieved by removing the Input Stage ZC 0007. Turning the switch fully anticlockwise gives a low-frequency cut-off of 10 Hz, and turning it fully clockwise gives a value of 2 Hz. See Fig.10 of Chapter 1. This switch should be set to give a low-frequency cut-off of 10 Hz, provided no frequencies of interest lie below that value, to reduce the influence of very-low-frequency sounds and vibrations.

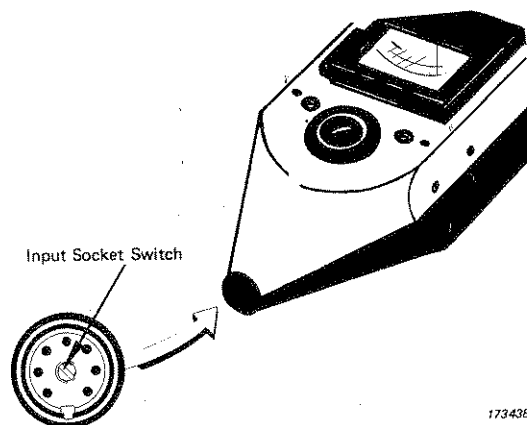

Fig.3.2. Input socket of 2209 (showing switch)

3.2.3. Mounting the Microphone

There are several methods of mounting the microphone, which will be outlined below. (See also Fig.6 of Chapter 1.) However, there are one or two general considerations which will be mentioned first. When connecting or disconnecting the microphone, ensure that the instrument power is turned off. In dry weather, it is recommended that static electricity be discharged from your body before fitting or removing microphones. Only light finger torque should be applied to the microphone, extension rod, etc.. Dust and foreign objects should be kept off the diaphragm, which must not be touched with any object. If the diaphragm must be cleaned, cotton wool should be used very carefully. Dry and preferably warm conditions are recommended for storing the instrument and its accessories.

Direct Mounting

Insert the Input Stage ZC 0007 (with 5 connection pins) into the input-stage socket, and secure it by turning the threaded retainer. If the Dehumidifier UA 0308 is required, it should be screwed on next, and finally the microphone. (The silica-gel of the Dehumidifier should be blue. If it is pink it should be dried out at a maximum temperature of

130°C.) If microphones other than the half-inch type are used, an adaptor is necessary (see Fig.6 of Chapter 1).

Mounting on Extension Rod UA 0196

Insert the Input Stage ZC 0007 as described above. Screw on the Extension Rod, then the Dehumidifier if necessary (as above) and then the microphone. Microphones of other sizes will need an adaptor (see Fig.6 of Chapter 1). The Extension Rod UA 0196 should be used straight to satisfy the various precision standards.

Use of Extension Cable and Tripod

The necessary extension cable (3 m, 10 m or 30 m long, see Fig.6 of Chapter 1) should be inserted directly into the input-stage socket of the 2209, and secured by turning the threaded retainer. The Input Stage ZC 0007 is then attached to the cable, and the microphone and other accessories are attached as previously described. The microphone or the Extension Rod may be attached directly to the tripod using Adaptor UA 0354. This arrangement allows the operator to be close to the Sound Level Meter but at a distance from the microphone.

3.3. CALIBRATION FOR SOUND MEASUREMENTS

3.3.1. General

The 2209 may be calibrated in two ways: either using an acoustic calibrator (effectively a miniature loudspeaker) placed over the microphone; or using the built-in reference voltage in the instrument. The acoustical method has the advantage that it checks the entire instrument, including the microphone, and so is the preferred method. When the instrument is first received, it is a useful check to calibrate it by both methods; these should agree to within about 0,5 dB.

3.3.2. Acoustical Calibration (External Source)

The Sound Level Calibrator Type 4230 or Pistonphone Type 4220 is recommended. The 4230 generates 94 dB ($\pm 0,25$ dB) at a frequency of 1000 Hz while the 4220 generates 124 dB ($\pm 0,2$ dB) at a frequency of 250 Hz.

Calibration with Microphone Type 4165

The calibration procedure when the 2209 is used with the microphone with which it is normally supplied (Type 4165) is as follows:

1. Turn the METER SCALE to "Precision Sound Level Meter", and adjust the METER MECHANICAL ZERO ADJUSTMENT screw with a small screwdriver (if necessary) to give a meter needle setting on the " $-\infty$ " mark of the METER SCALE while the instrument is switched off.
2. Check that the correct ATTENUATOR SCALE (Scale No. 1A, "10" to "130" dB) is inserted (see Chapter 2 for instructions) and set the lower limiting frequency as required (see section 3.2.2).

3. Attach the Input Stage and microphone with the required extension cables and adaptors as described in section 3.2.3.
4. Turn the METER SWITCH to "Batt. (Rec.)" to check the batteries; then set it to "Fast" meter response. (The instrument warm-up time is 30 s.)
5. Set the WEIGHTING NETWORK SWITCH to "C" or "Lin."
6. Set the ATTENUATORS to "90" dB if the Sound Level Calibrator Type 4230 is used, or "120" dB if the Pistonphone Type 4220 is used, with the OUTPUT ATTENUATOR (transparent) as far clockwise as possible (red lines by the black dot).
7. Fit the half-inch adaptor on the acoustic calibrator, and place it over the microphone with its normal protection grid. Turn the acoustic calibrator on, and hold it still over the microphone. (See also the separate Instruction Manuals.)
8. Adjust the GAIN ADJ. potentiometer with a small screwdriver to give a meter reading of "+ 3,8" (= 93,8 dB) if a 4230 is used, or to give a reading of the value given on the calibration chart (corrected as necessary for barometric pressure) if a 4220 is used. (See also the separate Instruction Manuals.)

Calibration with microphones other than Type 4165

The 2209 may be used with one-inch, half-inch, quarter-inch, and eighth-inch B & K condenser microphones. When using quarter-inch or eighth-inch microphones, see also section 4.6. Using the microphone sensitivity (mV/Pa) from its calibration chart, select and insert the correct ATTENUATOR SCALE as shown in Table 3.1. Apart from the choice of adaptor for the acoustic calibrator (step 7), and the calibration value (step 8) when using the 4230, which is given below, the calibration procedure is identical to that given above for the Type 4165. With the use of quarter-inch and eighth-inch microphones, the use of the Pistonphone is recommended for calibration.

| Microphone open circuit sensitivity | B & K Microphone Type | Scale No. | Red Sensitivity Scale |
|-------------------------------------|-----------------------------|-----------|-----------------------|
| 40–160 mV per Pa* | 4144 4145 4161 4165 4166 | 1 A | Upper |
| 11–50 mV per Pa | 4133 4134 4149 4163 | 1 B | Lower |
| 4–16 mV per Pa | 4133 4134 4149 4163 | 2 A | Upper |
| 1,1–5 mV per Pa | 4135 4136 | 2 B | Lower |
| 0,4–1,6 mV per Pa | 4138 | 3 A | Upper |

* 1 Pa = 1 N/m² = 10 μbar

760066

Table 3.1. ATTENUATOR SCALES for sound measurement

In addition, the microphones fall into the free-field or pressure-type categories. Although this does not affect the Pistonphone calibration procedure (at 250 Hz), it does affect the

value to which the 2209 should be calibrated with the Sound Level Calibrator (at 1 kHz).

These values should be set as follows:

| | |
|---|-----------|
| One-inch free-field microphones: | "93,6" dB |
| Half-inch free-field microphones: | "93,8" dB |
| Pressure microphones of both sizes: | "94,0" dB |
| Quarter-inch and eighth-inch microphones: | "94,0" dB |

3.3.3. Calibration using the Internal Reference Voltage

The stable internal voltage ($\pm 0,2$ dB at 2 kHz) in the 2209 may also be used for calibration, as follows:

1. Turn the METER SCALE to "Precision Sound Level Meter" and, using a screwdriver, adjust the METER MECHANICAL ZERO ADJUSTMENT screw (if necessary) to give a meter needle setting on the " $-\infty$ " mark of the METER SCALE while the instrument is switched off.
2. Insert the appropriate ATTENUATOR SCALE, depending on the microphone sensitivity (mV/Pa) given on its calibration chart. Selection is made with reference to Table 3.1. (See Chapter 2 for instructions.)
3. Set the lower limiting frequency as required (see section 3.2.2), and attach the Input Stage, microphone, required extension cables, and adaptors as described in section 3.2.3.
4. Turn the METER SWITCH to "Batt. (Rec.)" to check the batteries; then set it to "Fast" meter response. (The instrument warm-up time is 30 s.)
5. Set the WEIGHTING NETWORK SWITCH to "Lin.". (A weighted position should not be used for this 2 kHz reference voltage.)
6. Set the ATTENUATOR switches to "Ref." (between the red lines).
7. Adjust the GAIN ADJ. potentiometer with a small screwdriver to give a meter needle deflection on the red MICR. SENS. scale (upper scale or lower scale, as shown in Table 3.1) equal to the Open-Circuit Sensitivity of the microphone in mV/Pa obtained from its calibration chart.

3.4. SOUND MEASUREMENTS

3.4.1. General

The accompanying booklet "Measuring Sound" should be read through before proceeding with the measurements, as it contains much useful information on the subject. One or two points should perhaps be emphasized. Ensure that the microphone has the required dynamic range, frequency range and directional characteristics. Always use a Windscreen for outdoor measurements and in a dusty environment. Various Nose Cones are available for reducing wind noise (see Fig.6, Chapter 1), as well as Dehumidifiers. The microphone must be mounted on the Extension Rod UA 0196 to fulfil the requirements of the precision standards. If a one-inch microphone is used, a Random Incidence Corrector may also be necessary for certain measurements. Ensure that the measuring position is suitable and hold the Sound Level Meter at arm's length, or mount it on a

tripod, to minimize reflections from the operator. Finally, make sure that the background noise level is not too high to make meaningful measurements.

3.4.2. Procedure for Sound Measurements

1. Calibrate the 2209 (including checking the batteries, etc.) as described in section 3.3.
2. Set the METER SWITCH as follows:
 - "Fast": For normal measurements of sound
 - "Slow": To be used when the meter needle fluctuations are too fast or great to make meaningful readings in the "Fast" position
 - "Imp.": For obtaining the **subjective** level of short-duration sounds ($< 0,2$ s)
 - "Imp. Hold": For holding the maximum RMS value of the signal
 - "Peak Hold": For holding the maximum peak value of the signal.

Note: It may be found convenient to use only "Fast" or "Slow" here, and to select the required position after step 6.

3. Set the WEIGHTING NETWORK SWITCH to "Lin."
4. Set the OUTPUT ATTENUATOR (transparent) at minimum gain, i.e. fully clockwise so that the red lines are adjacent to the black spot.
5. Turn the INPUT ATTENUATOR (black) clockwise to give the highest possible meter reading without over-deflecting and without the INPUT OVERLOAD lamp on. If necessary (when the INPUT ATTENUATOR is fully clockwise) for small signals, turn the OUTPUT ATTENUATOR (transparent) anticlockwise to give the highest possible meter reading without over-deflecting and without the OUTPUT OVERLOAD lamp on. (Remember to depress the METER RESET button if a "Hold" position is used.)
6. Select the required position of the WEIGHTING NETWORK SWITCH.
7. If the meter needle now over-deflects, reduce the gain by turning the OUTPUT ATTENUATOR (transparent) clockwise, or if this is not possible turn the INPUT ATTENUATOR (black) anticlockwise to give a meter reading in the measuring range, i.e. between "0" and "+ 10" dB. See note below. Do NOT increase the gain of this ATTENUATOR without repeating steps 2 to 5, as the input amplifier may be overloaded. (Remember to depress the METER RESET button if a "Hold" position is used.)
8. If the meter reading is too low, turn the OUTPUT ATTENUATOR (transparent) anticlockwise to give the highest possible meter reading without over-deflection and without the OUTPUT OVERLOAD lamp on. (Remember to depress the METER RESET button if a "Hold" position is used.)
9. With the microphone directed in the correct orientation for measurements, the sound (pressure) level equals the meter needle deflection plus the attenuator setting indicated inside the red lines. When writing down the readings, note also the position of the METER SWITCH and the WEIGHTING NETWORK SWITCH. (Remember to depress the METER RESET button between readings if a "Hold" position is used.)

Note: The most accurate readings will usually be obtained with meter needle deflections between "0" and "+ 10" dB, but for signals with a very high crest factor, readings may be made in the "-10" to "0" dB range to avoid errors due to output over-

load. If the OUTPUT OVERLOAD lamp alone flashes, the signal crest factor exceeds the instrument's capability at that ATTENUATOR setting. If the overload cannot be removed while maintaining a reading between "-10" and "+10" dB, the reading will be too low, and the overload should be noted with the results.

When operating the 2209 with the INPUT ATTENUATOR in the top two ranges for high readings, the input stage may be overloaded without either OVERLOAD lamp flashing. To ensure there is no input-stage overload, measure the peak value of the signal first; if an on-scale reading can be obtained at the highest ATTENUATOR setting, there is no overload of the input stage.

If the INPUT OVERLOAD lamp alone lights, turn the INPUT and OUTPUT ATTENUATORS anticlockwise together, or return to step 3 and set up the instrument again, as the sound level has increased. Any overload should be noted with the meter reading.

3.5. CALIBRATION FOR VIBRATION MEASUREMENTS

3.5.1. General

The Sound Level Meter Type 2209 may also be used to measure vibration levels by using one of the adaptors or the Integrator ZR 0020, shown in Fig.3.3. Full details of the ZR 0020 may be found on its Product Data Sheet. Using the adaptors, acceleration only can be measured; if the Integrator is used, acceleration, velocity, and displacement are all available. With the METER SCALE turned to its "Vibration Meter" side, and the correct ATTENUATOR SCALE inserted, acceleration (and velocity and displacement if the ZR 0020 is used) may be read directly from the instrument in vibration units (ms^{-2} , ms^{-1} , m, in metric units or g, in s^{-1} , in, in Imperial units). This is described in sections 3.5.2, 3.5.3, and 3.6.2.

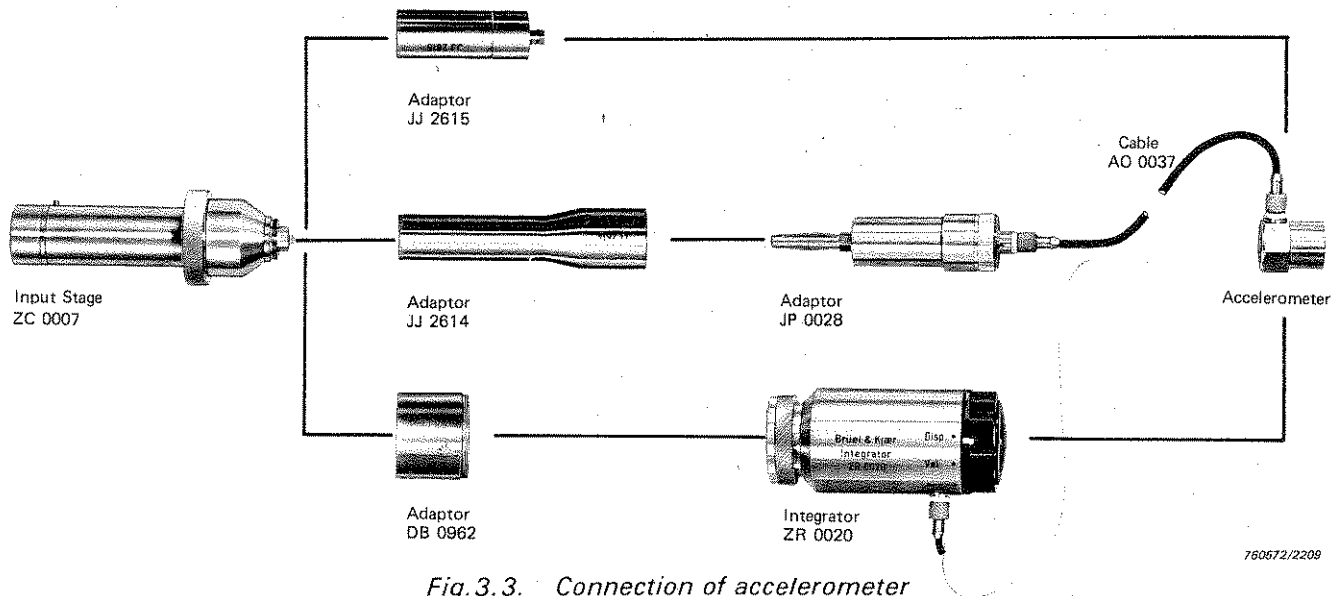

Fig.3.3. Connection of accelerometer

It is also possible to use the "Precision Sound Level Meter" side of the METER SCALE, and make vibration readings in dB. These can be simply converted to vibration units (ms^{-2} , ms^{-1} , m, in metric units or g, in s^{-1} , in, in Imperial units) using the circular Slide Rule QH 0001 provided with the Integrator. This latter method has the advantage

that the ATTENUATOR SCALE does not have to be altered for each change of parameter, and is described in sections 3.5.4, 3.5.5, and 3.6.2.

As with sound measurements, the 2209 can be calibrated in two ways: either using an external calibrator (vibrating the accelerometer at a known rate); or using the built-in reference voltage in the instrument. The external method has the advantage that it checks the entire instrument, including the accelerometer.

3.5.2. Calibration using Accelerometer Calibrator Type 4291 — direct reading in vibration units

The portable battery-operated Accelerometer Calibrator Type 4291 generates a vibration level of 1 g peak (0,707 g RMS) at 500 rad s⁻¹ (79,6 Hz). The calibration procedure for giving direct readings in vibration units is as follows:

1. Turn the METER SCALE to "Vibration Meter" and, using a screwdriver, adjust the METER MECHANICAL ZERO ADJUSTMENT screw (if necessary) to give a meter needle deflection on the "0" mark of the METER SCALE while the instrument is switched off.

| Accelerometer Sensitivity | B & K Accelerometer Type | Acc. | | Vel. | | Disp. | |
|---------------------------|---------------------------------|--------------------|-----|--------------------|----------|-------|------|
| | | m/sec ² | g | m/sec ² | inch sec | m | inch |
| 0,89–1,12 mV/g | | 4 B | 5 B | 6 A | 4 A | 7 B | 5 B |
| 1,12–2,8 mV/g | 4344 4367 4369 8303/4/5 8307 | | | | 4 B | | 6 A |
| 2,8–3,55 mV/g | | 5 A | 6 A | 6 B | 4 B | 8 A | 6 A |
| 3,55–8,9 mV/g | 4321 4345 | | | | 5 A | | 6 B |
| 8,9–11,2 mV/g | 4339 4343 8301 8302 8308 | 5 B | 6 B | 7 A | 5 A | 8 B | 6 B |
| 11,2–28 mV/g | | | | | 5 B | | 7 A |
| 28–35,5 mV/g | | 6 A | 7 A | 7 B | 5 B | 9 A | 7 A |
| 35,5–89 mV/g | 4366 4368 | | | | 6 A | | 7 B |
| 89–112 mV/g | 4338 4370 | 6 B | 7 B | 8 A | 6 A | 9 B | 7 B |
| 112–280 mV/g | | | | | 6 B | | 8 A |
| 280–355 mV/g | | 7 A | 8 A | 8 B | 6 B | 10 A | 8 A |
| 355–890 mV/g | | | | | 7 A | | 8 B |
| 890–1120 mV/g | | 7 B | 8 B | 9 A | 7 A | 10 A | 8 B |
| 1120–2800 mV/g | | | | | 7 B | | 9 A |

760064

Table 3.2. ATTENUATOR SCALES for vibration measurements

2. Insert the appropriate ATTENUATOR SCALE for the type of measurement (acceleration, velocity, or displacement) and the accelerometer sensitivity (see its calibration chart) as indicated in Table 3.2.
3. Set the lower limiting frequency as required (see section 3.2.2).
4. Mount the accelerometer on the 4291 (see the 4291 Instruction Manual), and connect it to the 2209 using one of the methods shown in Fig.3.3. If an Integrator is used, set it to the required position ("Acc.", "Vel.", or "Disp.").
5. Turn the METER SWITCH to "Batt. (Rec.)" to check the batteries; then set it to "Fast" meter response. (The instrument warm-up time is 30 s.)
6. Set the WEIGHTING NETWORK SWITCH to "Lin.". (A weighted position should not be used for this 79,6 Hz reference signal.)
7. Set the 4291 to "Internal Gen." and adjust the ACC. LEVEL so that the lower scale of the 4291 meter indicates the mass of the accelerometer (given on its calibration chart). The accelerometer is now vibrating at exactly 1 g peak.
8. Set the ATTENUATORS of the 2209 to give the meter needle a deflection of at least 1/3 full scale with the OUTPUT ATTENUATOR (transparent) as far clockwise as possible.
9. Using a small screwdriver, turn the GAIN ADJ. potentiometer to give a meter reading of one of the following quantities, depending on the measurement parameter and units:

| | | |
|---------------|---|---|
| Acceleration: | $6,94 \text{ ms}^{-2}$ RMS | $(7,07 \times 10^{-1} \text{ g RMS})$ |
| Velocity: | $13,9 \times 10^{-3} \text{ ms}^{-1}$ RMS | $(5,46 \times 10^{-1} \text{ in s}^{-1} \text{ RMS})$ |
| Displacement: | $27,7 \times 10^{-6} \text{ m RMS}$ | $(1,09 \times 10^{-3} \text{ in RMS})$ |

The 2209 is now calibrated so that direct meter readings (RMS values) may be made of the parameter required in the desired units. (Subsequent selection of, for example "Peak Hold" will of course mean that the peak value of the vibration level will be stored and displayed.) A separate calibration and a different ATTENUATOR SCALE are necessary for each different parameter or measurement unit.

3.5.3. Calibration using the Internal Reference Voltage — direct reading in vibration units

The stable internal voltage ($\pm 0,2 \text{ dB}$ at 2 kHz) in the 2209 may also be used for calibration to give direct readings in vibration units, as follows:

1. Turn the METER SCALE to "Vibration Meter" and, using a screwdriver, adjust the METER MECHANICAL ZERO ADJUSTMENT screw (if necessary) to give a meter needle deflection on the "0" mark of the METER SCALE while the instrument is switched off.
2. Insert the appropriate ATTENUATOR SCALE for the type of measurement (acceleration, velocity, or displacement) and the accelerometer sensitivity (see its calibration chart) as indicated in Table 3.2.
3. Set the lower limiting frequency as required (see section 3.2.2).

4. Connect the accelerometer to the 2209 using one of the methods shown in Fig.3.3. If an Integrator is used, set it to the required position ("Acc.", "Vel.", or "Disp.").
5. Turn the METER SWITCH to "Batt. (Rec.)" to check the batteries; then set it to "Fast" meter response. (The instrument warm-up time is 30 s.)
6. Set the WEIGHTING NETWORK SWITCH to "Lin.". (A weighted position should not be used for this 2 kHz reference voltage.)
7. Set the ATTENUATOR switches to "Ref." (between the red lines).
8. Using a small screwdriver, turn the GAIN ADJ. potentiometer to give the Sensitivity Correction, which is found as follows, on the lower red METER SCALE:

From the accelerometer calibration chart, determine its sensitivity in mV/g. Using this value, and the appropriate units of vibration to be measured (ms^{-2} , g, etc.), read off the Sensitivity Correction (in dB) from Fig.3.4. (Note that the vertical scale is a double (folded) scale, and that accelerometers whose sensitivities differ by a factor of 10, 100, etc., have the same Sensitivity Correction. These factors of 10 are automatically taken account of by the ATTENUATOR SCALE.)

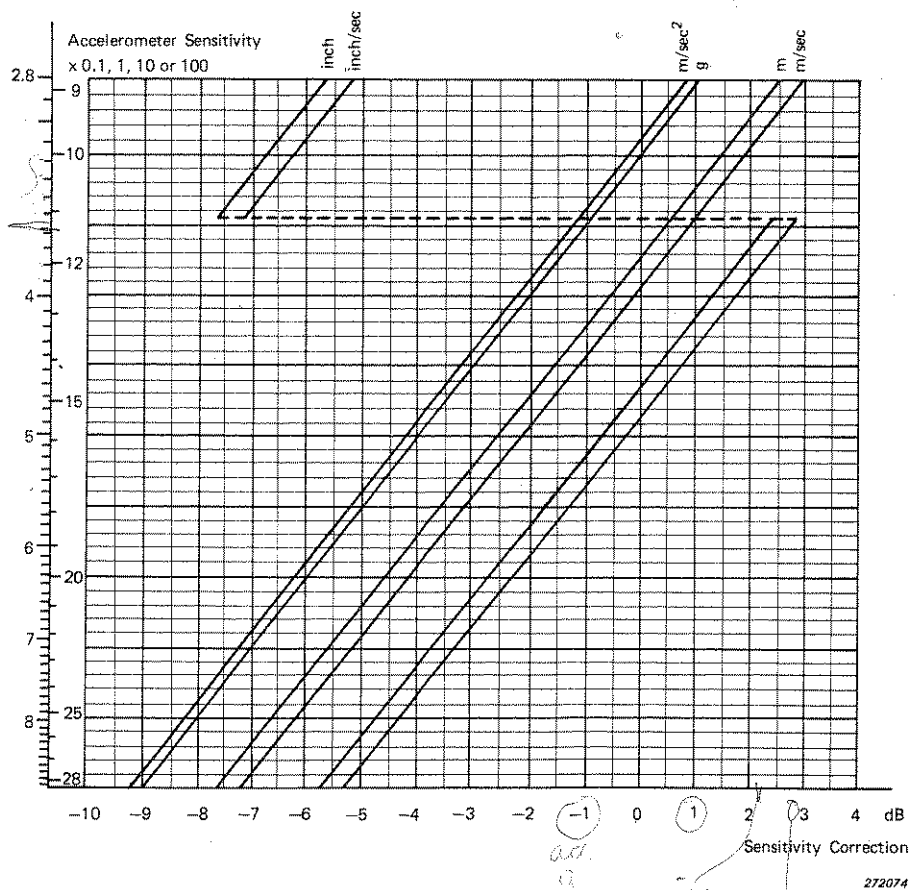

Fig.3.4. Accelerometer Sensitivity Correction Chart

The 2209 is now calibrated so that direct meter readings (RMS values) may be made of the parameter required in the desired units. (Subsequent selection of, for example, "Peak Hold" will of course mean that the peak value of the vibration level will be stored

and displayed.) A separate calibration and a different ATTENUATOR SCALE are necessary for each different parameter or measurement unit.

3.5.4. Calibration using Accelerometer Calibrator Type 4291 — meter reading in dB

The portable battery-operated Accelerometer Calibrator Type 4291 generates a vibration level of 1 g peak (0,707 g RMS) at 500 rad s⁻¹ (79,6 Hz). The calibration procedure for giving readings in dB (which may be converted to vibration units if required) is as follows:

1. Turn the METER SCALE to "Precision Sound Level Meter" and, using a screwdriver, adjust the METER MECHANICAL ZERO ADJUSTMENT screw (if necessary) to give a meter needle deflection on the "—∞" mark of the METER SCALE while the instrument is switched off.
2. Insert the ATTENUATOR SCALE No. 1 A ("10" to "130" dB).
3. Follow steps 3 — 8 of section 3.5.2.
4. Using a small screwdriver, turn the GAIN ADJ. potentiometer to give a meter needle deflection of "+ 7,0" dB.
5. Note the attenuator setting inside the red lines, and add 10 dB. This gives the zero reference value in dB (Z) corresponding to 1 g RMS, or any of the following vibration reference amplitudes (R) (which are equivalent to 1 g RMS at 79,6 Hz) to which the 2209 is now calibrated depending on the Integrator setting:

| | | |
|---------------|--|--|
| Acceleration: | 9,81 ms ⁻² RMS | (1 g RMS ≅ 386 in s ⁻² RMS) |
| Velocity: | 19,6 × 10 ⁻³ ms ⁻¹ RMS | (7,71 × 10 ⁻¹ in s ⁻¹ RMS) |
| Displacement: | 39,2 × 10 ⁻⁶ m RMS | (1,54 × 10 ⁻³ in RMS) |

This adjustment will need to be made for each parameter to be measured. It is thus easier to calibrate for, and to make all measurements of, one parameter first, then recalibrate for another parameter and make measurements, if possible, rather than switch from one to another. The level in vibration units may be calculated as explained in section 3.7.1 or 3.7.2.

(Selection of, for example, "Peak Hold" after calibration will of course mean that the peak value of the vibration level will be stored and displayed.)

3.5.5. Calibration using the Internal Reference Voltage — meter reading in dB

The stable internal voltage (± 0,2 dB at 2 kHz) in the 2209 may also be used for calibration, to give readings in dB, as follows:

1. Turn the METER SCALE TO "Precision Sound Level Meter" and, using a screwdriver, adjust the METER MECHANICAL ZERO ADJUSTMENT SCREW (if necessary) to give a meter needle deflection on the "—∞" mark of the METER SCALE while the instrument is switched off.
2. Insert the ATTENUATOR SCALE No. 1 A ("10" to "130" dB).
3. Follow steps 3 — 7 of section 3.5.3.

4. Using a small screwdriver, turn the GAIN ADJ. potentiometer to give a meter needle deflection on the reference mark on the underside of the upper black dB scale (between the "+ 6" and "+ 7" dB marks).
5. The 2209 is now calibrated so that a reading of "94" dB corresponds to 1 g RMS using an accelerometer with a sensitivity of 50 mV/g. For accelerometers of different sensitivities, the results should be corrected afterwards, as explained in section 3.7.3. The level in vibration units may be calculated as explained in section 3.7.3 or 3.7.4.

(Selection of, for example, "Peak Hold" after calibration will of course mean that the peak value of the vibration level will be stored and displayed.)

3.6. VIBRATION MEASUREMENTS

3.6.1. General

When using the 2209 as a preamplifier and measuring amplifier for an accelerometer, it should be remembered that the accelerometer has a high-frequency resonance (given on its calibration chart) which probably lies within the frequency range of the meter. Measurements should therefore be made with the use of a supplementary low-pass filter, or with a band-pass filter set (see Chapter 1), to prevent measuring the results of the resonance, where it is thought possible that the signal may contain such high frequencies. The lower limiting frequency of the measuring system is set at 2 Hz or 10 Hz by the 2209.

For detailed instructions on the use of the accelerometer, see its Instruction Manual. The 2209 itself should be kept out of the vibration environment. If the accelerometer is to be used at some distance from the meter, extension cables should be used between the meter and its Input Stage, rather than between the accelerometer and the Input Stage, to prevent a decrease in overall sensitivity.

When using the "Peak Hold" circuit, the 2209 is well suited for the measurement of maximum acceleration, which is an important quantity in the investigation of materials fatigue.

3.6.2. Procedure for Vibration Measurements

1. Calibrate the 2209 by one of the methods described in section 3.5, including the battery check, selection of lower limiting frequency, etc..
2. Mount the accelerometer on the test object using one of the methods described in its Instruction Manual.
3. Select "Fast" or "Slow" METER SWITCH position, and turn the WEIGHTING NETWORK SWITCH to "Lin."
4. Set the OUTPUT ATTENUATOR (transparent) at minimum gain, i.e. fully clockwise so that the red lines are adjacent to the black spot.
5. Turn the INPUT ATTENUATOR (black) clockwise to give the highest possible meter reading without over-deflecting and without the INPUT OVERLOAD lamp on. If necessary (when the INPUT ATTENUATOR is fully clockwise) for small input signals, turn the OUTPUT ATTENUATOR (transparent) anticlockwise to give the highest possi-

ble meter reading without over-deflecting and without the OUTPUT OVERLOAD lamp on.

6. Turn the WEIGHTING NETWORK SWITCH and the METER SWITCH to the required positions for measurements.
7. If the meter needle now over-deflects, reduce the gain by turning the OUTPUT ATTENUATOR (transparent) clockwise, or if this is not possible, turn the INPUT ATTENUATOR (black) anticlockwise to give a meter reading of at least 1/3 full scale. See note below. Do NOT increase the gain of this ATTENUATOR without repeating steps 3 to 5, as the input amplifier may be overloaded. (Remember to depress the METER RESET button if a "Hold" position is used.)
8. If the meter reading is too low, turn the OUTPUT ATTENUATOR (transparent) anticlockwise to give the highest possible meter reading without over-deflection and without the OUTPUT OVERLOAD lamp on. (Remember to depress the METER RESET button if a "Hold" position is used.) See note below.
9. If the "Vibration Meter" scale has been used (calibration as in section 3.5.2 or 3.5.3), the vibration level in the calibrated units is read directly from the METER SCALE with reference to the full-scale deflection given between the red lines on the ATTENUATOR SCALE. RMS, impulse, or peak values may be read, depending on the position of the METER SWITCH, which should be noted, as should the position of the WEIGHTING NETWORK SWITCH. (Remember to depress the METER RESET button between readings if a "Hold" position is used.)

If the "Precision Sound Level Meter" scale has been used (calibration as in section 3.5.4 or 3.5.5), then the vibration level (M) in dB is the sum of the meter reading and the ATTENUATOR setting within the red lines. Note the position of the METER SWITCH and the WEIGHTING NETWORK SWITCH. These dB readings may be converted to vibration units (ms^{-2} , g, etc.) as described in section 3.7. (Remember to depress the METER RESET button between readings if a "Hold" position is used.)

Note: The most accurate readings will usually be obtained with meter needle deflections in the upper 2/3 of the scale, but for signals with a very high crest factor, readings may be made at a smaller needle deflection to avoid errors due to output overload. If the OUTPUT OVERLOAD lamp alone flashes, the signal crest factor exceeds the instrument's capabilities at that ATTENUATOR setting. If the overload cannot be removed while maintaining a sensible meter reading, the reading will be too low, and the overload should be noted with the results.

When operating the 2209 with the INPUT ATTENUATOR in the top two ranges for high readings, the input stage may be overloaded without either OVERLOAD lamp flashing. To ensure there is no input-stage overload, measure the peak value of the signal first; if an on-scale reading can be obtained at the highest ATTENUATOR setting, there is no overload of the input stage.

If the INPUT OVERLOAD lamp alone lights, turn the INPUT and OUTPUT ATTENUATORS anticlockwise together, or return to step 3 and set up the instrument again, as the vibration level has increased. Any overload should be noted with the meter reading.

3.7. CONVERSION OF RESULTS IN dB TO VIBRATION UNITS

If measurements have been made in dB (either to save changing ATTENUATOR SCALES, or because they were required in dB), they may be simply converted into vibration units.

The conversion depends on the method of calibration, and whether or not the Integrator has been used. The circular Slide Rule QH 0001 (supplied with the ZR 0020) used for the conversion has two similar sides, one in metric units and the other in Imperial units.

3.7.1. With 4291 Calibration, Without Integrator

Determine the acceleration level (A) in dB referenced to 1 g RMS by:

$$A = M - Z$$

where M = measured value on 2209 (dB)

and Z = zero reference level (dB) (from section 3.5.4 step 5).

From Table 3.3, convert A from dB to a ratio (T). The vibration amplitude is then given by the product RT, where R is the vibration reference amplitude defined in section 3.5.4 step 5.

| dB | 0,0 | 0,1 | 0,2 | 0,3 | 0,4 | 0,5 | 0,6 | 0,7 | 0,8 | 0,9 |
|----|-------|-------|-------|-------|-------|-------|-------|-------|-------|-------|
| 0 | 1,000 | 1,012 | 1,023 | 1,035 | 1,047 | 1,059 | 1,072 | 1,084 | 1,096 | 1,109 |
| 1 | 1,122 | 1,135 | 1,148 | 1,161 | 1,175 | 1,189 | 1,202 | 1,216 | 1,230 | 1,245 |
| 2 | 1,259 | 1,274 | 1,288 | 1,303 | 1,318 | 1,334 | 1,349 | 1,365 | 1,380 | 1,396 |
| 3 | 1,413 | 1,429 | 1,445 | 1,462 | 1,479 | 1,496 | 1,514 | 1,531 | 1,549 | 1,567 |
| 4 | 1,585 | 1,603 | 1,622 | 1,641 | 1,660 | 1,679 | 1,698 | 1,718 | 1,738 | 1,758 |
| 5 | 1,778 | 1,799 | 1,820 | 1,841 | 1,862 | 1,884 | 1,905 | 1,928 | 1,950 | 1,972 |
| 6 | 1,995 | 2,018 | 2,042 | 2,065 | 2,089 | 2,113 | 2,138 | 2,163 | 2,188 | 2,213 |
| 7 | 2,239 | 2,265 | 2,291 | 2,317 | 2,344 | 2,371 | 2,399 | 2,427 | 2,455 | 2,483 |
| 8 | 2,512 | 2,541 | 2,570 | 2,600 | 2,630 | 2,661 | 2,692 | 2,723 | 2,754 | 2,786 |
| 9 | 2,818 | 2,851 | 2,884 | 2,917 | 2,951 | 2,985 | 3,020 | 3,055 | 3,090 | 3,126 |
| 10 | 3,162 | 3,199 | 3,236 | 3,273 | 3,311 | 3,350 | 3,388 | 3,428 | 3,467 | 3,508 |
| 11 | 3,548 | 3,589 | 3,631 | 3,673 | 3,715 | 3,758 | 3,802 | 3,846 | 3,890 | 3,936 |
| 12 | 3,981 | 4,027 | 4,074 | 4,121 | 4,169 | 4,217 | 4,266 | 4,315 | 4,365 | 4,416 |
| 13 | 4,467 | 4,519 | 4,571 | 4,624 | 4,677 | 4,732 | 4,786 | 4,842 | 4,898 | 4,955 |
| 14 | 5,012 | 5,070 | 5,129 | 5,188 | 5,248 | 5,309 | 5,370 | 5,433 | 5,495 | 5,559 |
| 15 | 5,623 | 5,689 | 5,754 | 5,821 | 5,888 | 5,957 | 6,026 | 6,095 | 6,166 | 6,237 |
| 16 | 6,310 | 6,383 | 6,457 | 6,531 | 6,607 | 6,683 | 6,761 | 6,839 | 6,918 | 6,998 |
| 17 | 7,079 | 7,161 | 7,244 | 7,328 | 7,413 | 7,499 | 7,586 | 7,674 | 7,762 | 7,852 |
| 18 | 7,943 | 8,035 | 8,128 | 8,222 | 8,318 | 8,414 | 8,511 | 8,610 | 8,710 | 8,810 |
| 19 | 8,913 | 9,016 | 9,120 | 9,226 | 9,333 | 9,441 | 9,550 | 9,661 | 9,772 | 9,886 |

073010

Table 3.3. Conversion of dB to ratio. Subtract a multiple of 20 ($n \times 20$ where n is a positive or negative integer or 0) from the dB value to be converted such that the remainder is a positive number between 0 and 19,9. Look up the ratio of that remainder in the table. The desired ratio is then 10^n times the value from the table. Example: $-12,6$ dB must be converted to a ratio. To get a positive number between 0 and 19,9, subtract -20 ($= 20 \times (-1)$) from $-12,6$, giving $+7,4$. The ratio of 7,4 is found in the table to be 2,344. Hence the ratio of $-12,6$ dB $= 2,344 \times 10^n = 2,344 \times 10^{-1} = 0,2344$

Example: The zero reference level (Z) is 100 dB. The measured value (M) on the 2209 is 87,4 dB, and it is desired to find the acceleration in ms^{-2} .

$$A = M - Z = 87,4 - 100 = -12,6 \text{ dB}$$

From Table 3.3, $-12,6$ dB becomes a ratio of $T = 0,2344$.
 Then Acceleration = $RT = 9,81 \text{ ms}^{-2} \times 0,2344 = 2,30 \text{ ms}^{-2}$.

If an RMS meter setting has been used, the acceleration is $2,30 \text{ ms}^{-2}$ RMS. (The peak acceleration level (for sinusoidal signal) is $2,30 \times 1,414 = 3,25 \text{ ms}^{-2}$ peak.)

If a peak (or impulse) setting has been used, the acceleration is $2,30 \text{ ms}^{-2}$ peak (or impulse).

This calculation may be made more simply using the circular Slide Rule QH 0001 (if available) as described in the following section.

3.7.2. With 4291 Calibration, With Integrator ZR 0020

The vibration amplitude may only be calculated in the same parameter as that set on the Integrator, and the Slide Rule must not be used to convert from one parameter to another. To determine another parameter, the Integrator must be set and the 2209 calibrated for that parameter and new measurements made. The circular Slide Rule QH 0001 (shown in Fig.3.5) provided with the Integrator should be used to make the calculations as follows:

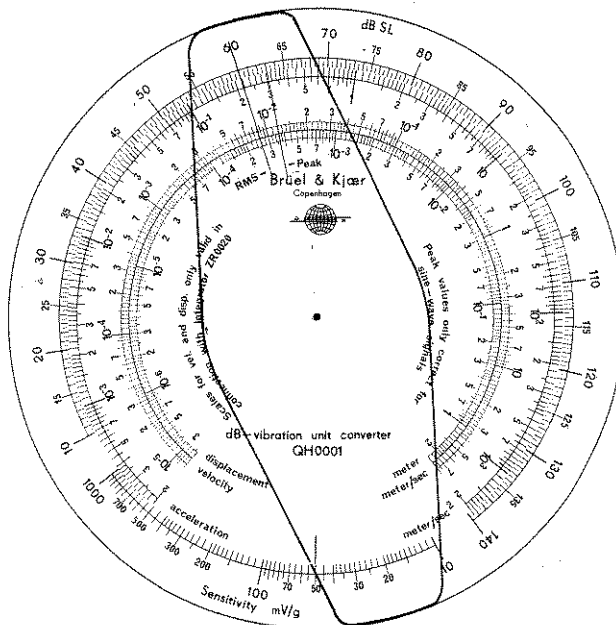

Fig.3.5. Slide Rule QH 0001 set for an accelerometer sensitivity of 50 mV/g and an SPL of 60 dB

1. Turn the cursor until its RMS line lies over the zero reference level (Z) (from section 3.5.4 step 5) on the outer dB SL scale.
2. Rotate the sliding scale until the vibration reference amplitude (R) (see section 3.5.4 step 5) on the appropriate vibration scale (acceleration, velocity, or displacement) also lies under the RMS line on the cursor.

3. Turn the cursor until its RMS line lies over the value of the 2209 meter reading (M) in dB on the outer dB SL scale of the Slide Rule.
4. Read the vibration level on the **same vibration scale** as that used for step 2. See the example below.

Example: The zero reference level (Z) is 80 dB. The vibration reference amplitude (R) is $7,71 \times 10^{-1}$ in s^{-1} , and the 2209 meter reading (M) is 51 dB. Find the equivalent velocity in s^{-1} .

Set the RMS line on the cursor over the "80" dB line on the outer dB SL scale, and turn the sliding scale until the value of " $7,71 \times 10^{-1}$ " on the VELOCITY INCHES/SEC scale also lies under the RMS line. Turn the cursor to "51" dB on the outer dB SL scale. The velocity is " $2,8 \times 10^{-2}$ " in s^{-1} , read from the RMS line.

If an RMS meter setting has been used, the velocity is " $2,8 \times 10^{-2}$ " in s^{-1} RMS. (The peak velocity (for a sinusoidal signal) may be read from the PEAK line as " $3,9 \times 10^{-2}$ " in s^{-1} peak.)

If a peak (or impulse) setting has been used, the velocity is " $2,8 \times 10^{-2}$ " in s^{-1} peak (or impulse), read from the RMS line.

3.7.3. With Internal Calibration, Without Integrator

The acceleration level (A) in dB referenced to 1 g RMS is calculated by the formula:

$$A = M - 94 + 20 \log_{10}(50/S)$$

where M is the meter reading on the 2209 (dB) and S is the sensitivity (mV/g) of the accelerometer used (from its calibration chart).

A is now converted to vibration units as described in section 3.7.1.

The complete calculation may be made more simply using the circular Slide Rule QH 0001 provided with ZR 0020 (if available) as described in the following section.

3.7.4. With Internal Calibration, With Integrator ZR 0020

The vibration amplitude may only be calculated in the same parameter as that set on the Integrator, and the Slide Rule must not be used to convert from one parameter to another. To determine another parameter, the Integrator must be set and the 2209 calibrated for that parameter, and new measurements made. The circular Slide Rule QH 0001 should be used to make the calculations as follows:

1. Set the isolated red line on the sliding scale adjacent to the accelerometer sensitivity in mV/g on the outer scale of the Slide Rule. (It is shown adjacent to 50 mV/g in Fig.3.5.)
2. Turn the cursor so that its RMS line lies over the value of the 2209 meter reading (M) in dB on the outer dB SL scale of the Slide Rule.
3. Read the vibration level on the **scale corresponding to the Integrator setting**. If an RMS meter setting has been used, then the value read from the RMS line will be RMS, and the value from the PEAK line (for a sinusoidal signal) will be peak. If a

peak (or impulse) setting has been used, the value read from the RMS line will be peak (or impulse).

3.8. VOLTAGE CALIBRATION

The 2209 may be used to make direct voltage measurements up to 10V RMS over the frequency range of the amplifier indicated in the specifications (see Chapter 1). The calibration procedure is as follows:

1. Turn the METER SCALE to "Vibration Meter" and, using a screwdriver, adjust the METER MECHANICAL ZERO ADJUSTMENT screw (if necessary) to give a meter needle deflection on the "0" mark of the METER SCALE while the instrument is switched off.
2. Insert ATTENUATOR SCALE No. 3 B for voltage measurements.
3. Set the lower limiting frequency as required (see section 3.2.2).
4. Fit the 2209 with its Input Stage, Adaptor JJ 2614, Plug JP 0101 and/or other connectors necessary to connect the voltage to the 2209.
5. Turn the METER SWITCH to "Batt. (Rec.)" to check the batteries; then set it to "Fast" meter response. (The instrument warm-up time is 30 s.)
6. Set the WEIGHTING NETWORK SWITCH to "Lin." and the ATTENUATORS to "Ref." (between the red lines).
7. Using a small screwdriver, turn the GAIN ADJ. potentiometer to give a Sensitivity Correction of "0" on the red scale.

The 2209 is now calibrated for direct reading of RMS voltage measurements, with reference to the full-scale deflection shown between the red lines on the ATTENUATOR SCALE. (Subsequent selection of, for example, "Peak Hold" will of course mean that the peak value of the vibration level will be stored and displayed.)

3.9. VOLTAGE MEASUREMENTS

The procedure for making voltage measurements is as follows:

1. Calibrate the 2209 as described in section 3.8, including the battery check, selection of lower limiting frequency, etc..
2. Connect the 2209 to the voltage to be measured, using the necessary adaptors and connectors.
3. With the METER SWITCH set to "Fast" and the WEIGHTING NETWORK SWITCH set to "Lin.", ensure that the OUTPUT ATTENUATOR (transparent) is set to minimum gain, i.e. fully clockwise so that the red lines are adjacent to the black spot.
4. Turn the INPUT ATTENUATOR (black) clockwise to give the highest possible meter reading without over-deflecting and without the INPUT OVERLOAD lamp on.
5. Turn the OUTPUT ATTENUATOR (transparent) anticlockwise if necessary to give the highest possible meter reading without over-deflecting and without the OUTPUT OVERLOAD lamp on.

6. The RMS voltage is the meter reading referenced to the full-scale deflection shown between the red lines on the ATTENUATOR scale. The peak voltage may be obtained (for a sinusoidal signal) by multiplying the RMS reading by 1,414, or other positions of the METER SWITCH may be selected as required.

4. SPECIAL CHARACTERISTICS

4.1. GENERAL

A brief general description of the 2209 is given in Chapter 1, including some of the more important characteristics and complete specifications. However, it is possible that the user will require a little more information on the impulse and peak characteristics of the 2209, so these are included here.

4.2. IMPULSE DETECTOR

The purpose of the impulse detector is to approximate the subjective effects of short-duration sound on the human ear. The averaging time of the human ear is in the range from 30 to 100 ms (according to various investigators). Hence for impulses shorter than the ear's averaging time, the subjective loudness will not be so great. The 2209 "Impulse" characteristic is shown in Fig.12 of Chapter 1, together with the IEC tolerances.

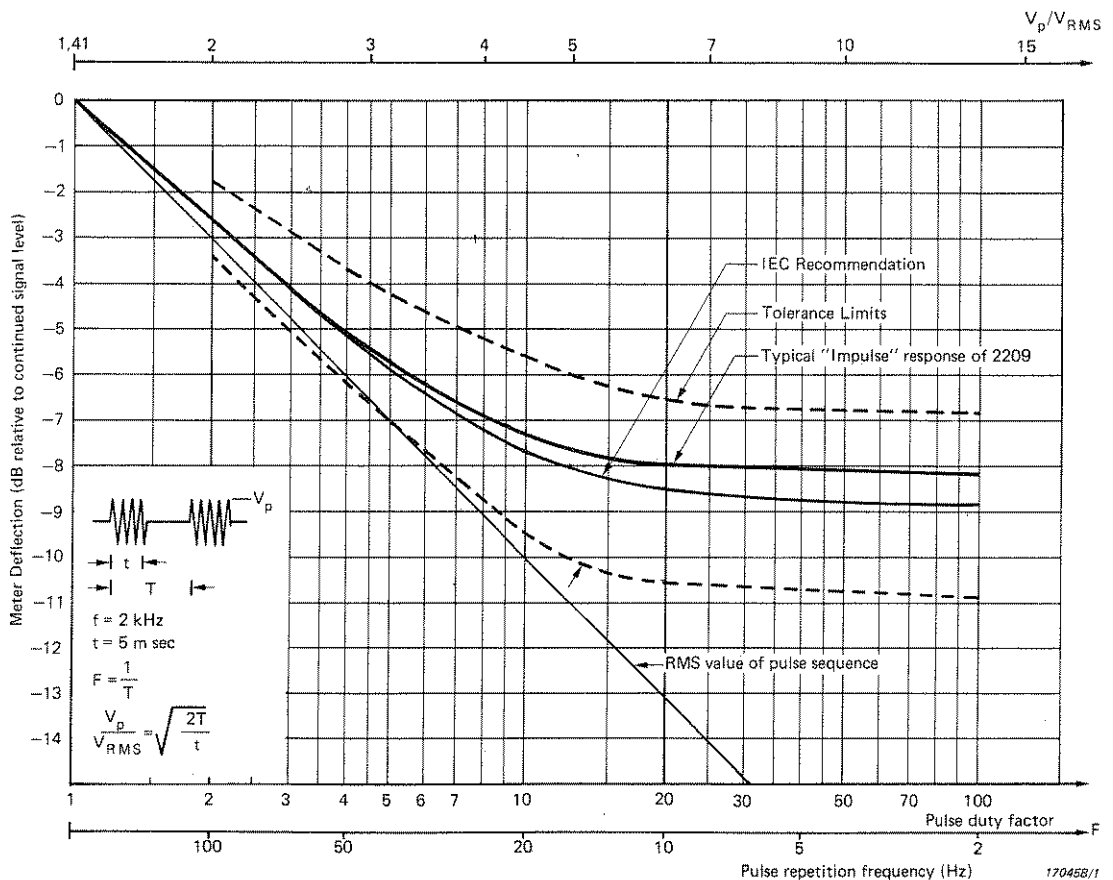

Fig. 4.1. Response of 2209 to repeated impulses

For repeated impulses, the greater the repetition rate, the greater is the subjective loudness. The characteristics of the 2209 for repeated impulses and the IEC specifications are given in Fig.4.1. The decay time of the impulse circuit is 3 s, in accordance with the IEC recommendations.

4.3. PEAK DETECTOR

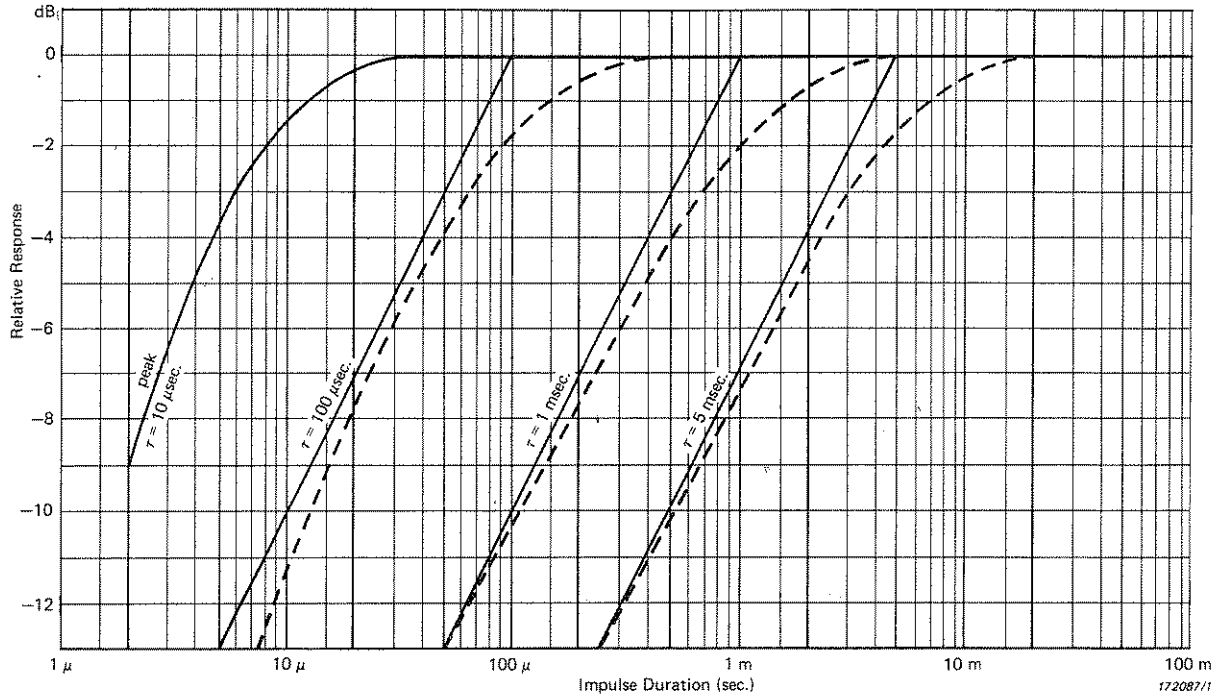

Fig. 4.2. Standard and optional "Peak Hold" responses of 2209

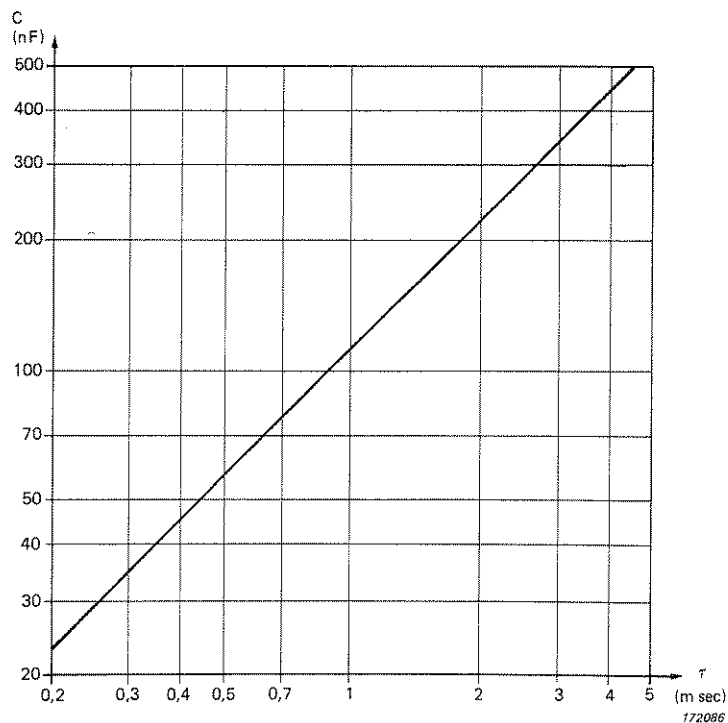

Fig. 4.3. Optional charge capacitor vs. time constants for "Peak" rectifier

To detect peak levels, the time constant of the RMS detector is reduced to $10\mu\text{s}$. The output of the peak circuit is then stored in the hold circuit to permit display by the relatively slow meter. In general, the peak values for noise may be 10 to 20 dB or more above the RMS values.

An internal modification to the 2209 may be made to change the time constant of the peak circuit over a range from $10\mu\text{s}$ to 5 ms by changing the value of one capacitor. See Figs. 4.2 and 4.3 for response characteristics and capacitor values. Information concerning these changes may be obtained from the Service Department.

4.4. HOLD CIRCUIT

The hold circuit stores the highest level fed from the impulse or peak detectors. If the meter needle over-deflects, or if a new reading of lower-level signals is needed, the meter must be reset. Note that once the circuit is holding a signal, changing the ATTENUATORS will not decrease the meter deflection. The decay time of the hold circuit is less than 0,05 dB/s with temperature characteristics shown in Fig. 4.4.

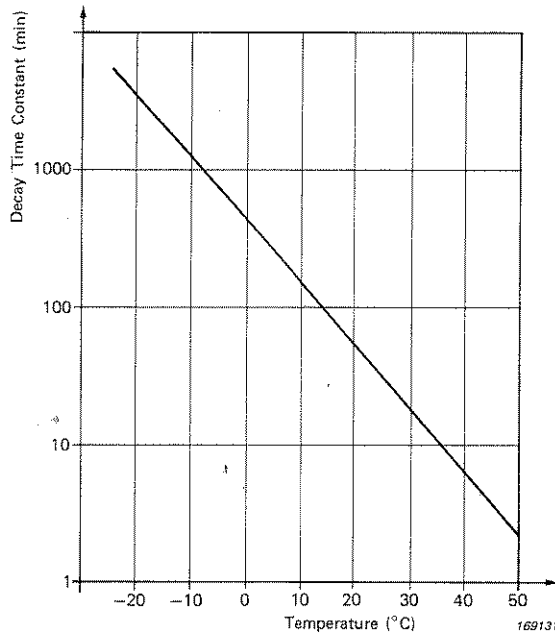

Fig. 4.4. Decay time vs. temperature for "Hold" circuit

4.5. CREST-FACTOR CAPABILITIES

The crest factor of a signal is defined as the ratio of the peak to the RMS value. The 2209 is capable of measuring the RMS values of signals with crest factors up to 40 for less than full-scale meter needle deflections. This feature, in combination with the output overload detector, ensures there is no undetected overload in the detector circuit. Crest-factor capabilities for less than full-scale meter needle deflection are shown in Fig. 4.5.

The accuracy of the RMS measurements as related to the crest factor of the signal is shown in Table 4.1.

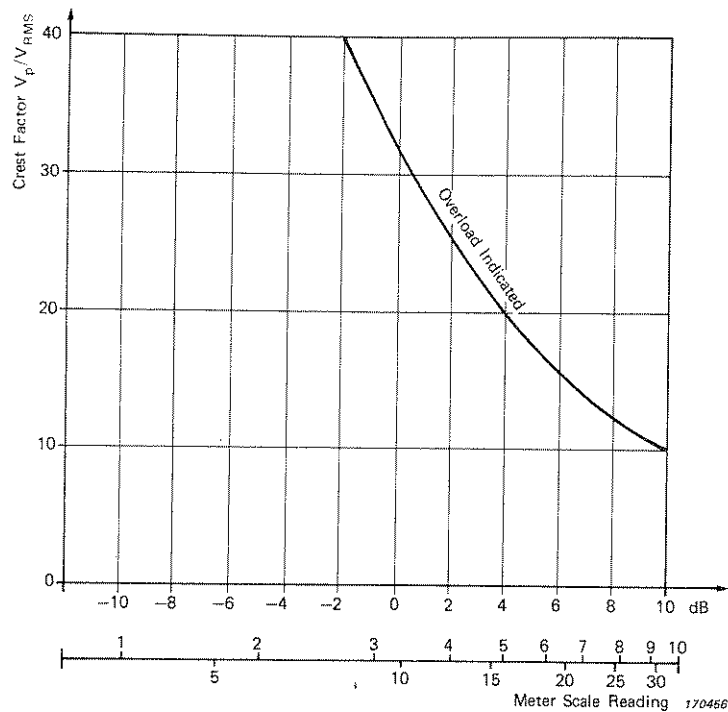
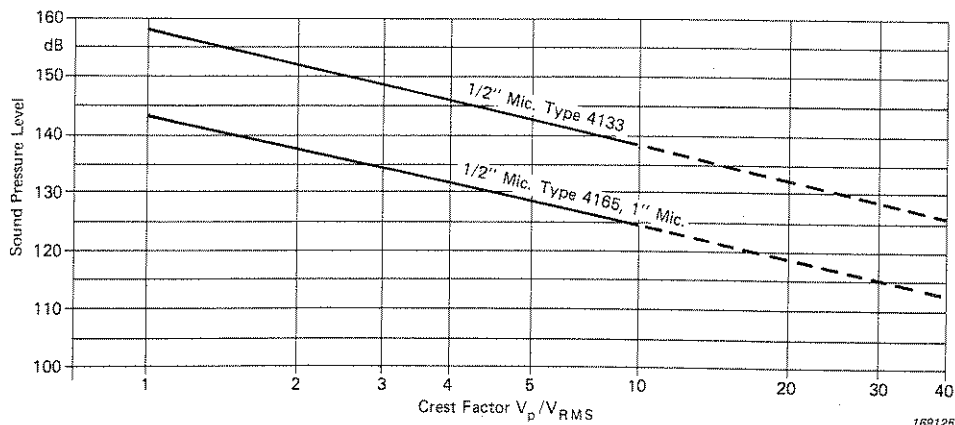

Fig. 4.5. Maximum Crest Factor at a given meter needle deflection

| Meter Deflection (dB scale) | Crest Factor | | |
|-----------------------------|--------------|----------|----------|
| | less than 10 | 10 to 20 | 20 to 40 |
| -10 to - 2 | ± 1 dB | ± 1,5 dB | ± 2 dB |
| - 2 to +10 | ± 0,5 dB | ± 1 dB | ± 1,5 dB |

760065

Table 4.1. Accuracy of METER SCALE readings for various Crest Factors within limitations given in Fig. 4.5



169125

Fig. 4.6. Maximum SPLs that can be accurately measured with one-inch and half-inch microphones with respect to signal crest factor

The 2209's crest-factor capabilities are also related to the maximum sound pressure levels that can be measured accurately. Fig.4.6 shows these relationships for one-inch and half-inch B & K microphones.

4.6. INPUT CAPACITANCE

Due to the low capacitance of condenser microphones, their sensitivity is affected by capacitive loads, as shown in Fig.4.7. For one-inch and half-inch microphones, their capacitance is between about 18 and 65 pF (the actual values are given on the calibration charts), and hence the input capacitance has relatively little effect. With the quarter-inch and eighth-inch microphones, however, whose capacitance is about 6,5 and 3,5 pF respectively, the loading effect is more pronounced, and system calibration using a Piston-phone Type 4220 is recommended.

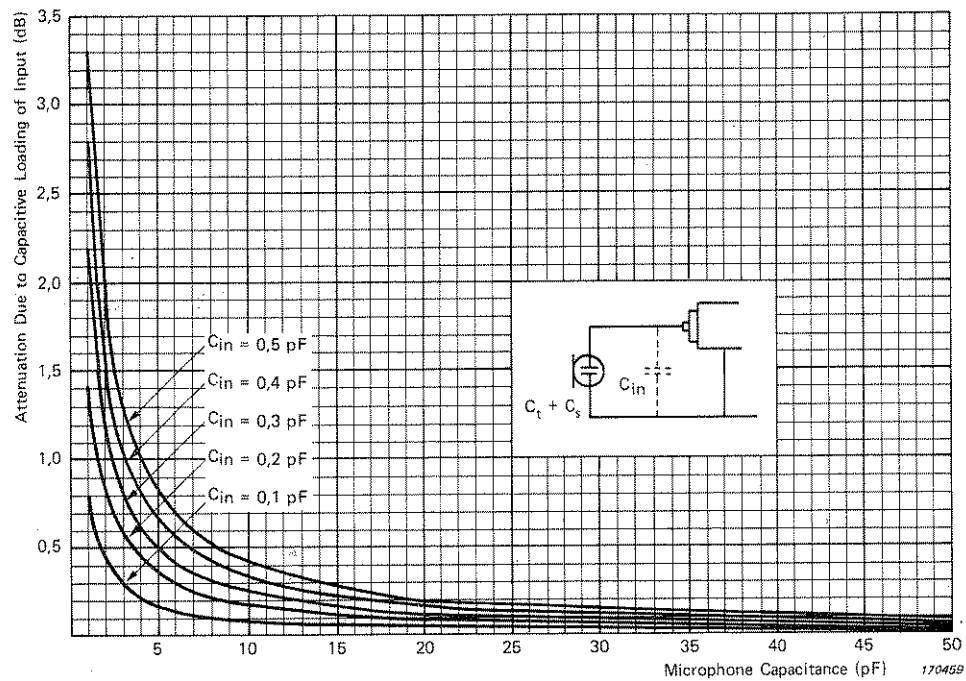

Fig.4.7. Attenuation caused by preamplifier input capacitance

5. ACCESSORIES

The accessories available for and included with the 2209 are summarized in Chapter 1. The following Table 5.1 lists the ten double-sided interchangeable ATTENUATOR SCALES supplied for use with various transducers.

| Scale No. | | Function | B & K Type No. |
|-----------|---|---|----------------|
| 1 | A | 10 – 130 dB | SA 0012 |
| | B | 20 – 140 dB | |
| 2 | A | 40 – 160 dB | SA 0013 |
| | B | 30 – 140 dB | |
| 3 | A | 50 – 160 dB | SA 0014 |
| | B | 10 μ V – 10 V | |
| 4 | A | 3·10 ⁻¹ – 3·10 ⁵ | SA 0015 |
| | B | 10 ⁻¹ – 10 ⁵ | |
| 5 | A | 3·10 ⁻² – 3·10 ⁴ | SA 0016 |
| | B | 10 ⁻² – 10 ⁴ | |
| 6 | A | 3·10 ⁻³ – 3·10 ³ | SA 0017 |
| | B | 10 ⁻³ – 10 ³ | |
| 7 | A | 3·10 ⁻⁴ – 3·10 ² | SA 0018 |
| | B | 10 ⁻⁴ – 10 ² | |
| 8 | A | 3·10 ⁻⁵ – 30 | SA 0019 |
| | B | 10 ⁻⁵ – 10 | |
| 9 | A | 3·10 ⁻⁶ – 3 | SA 0020 |
| | B | 10 ⁻⁶ – 1 | |
| 10 | A | 3·10 ⁻⁷ – 3·10 ⁻¹ | SA 0021 |
| | B | 10 ⁻⁷ – 10 ⁻¹ | |

760067

Table 5.1. ATTENUATOR SCALES and Type Numbers

6. USE WITH OTHER INSTRUMENTS

6.1. GENERAL

The 2209 can be used with a variety of other instruments, such as filters and recorders; a selection of these is shown in Fig.6 of Chapter 1. Details of all these instruments may be found on their Product Data Sheets, or in the B & K Catalogues, and full operational instructions are given in the appropriate Instruction Manuals. However, since the 2209 may be used for measuring signals with high crest factors, some more general information is contained below on the recording of these signals from one of the 2209's OUTPUT sockets.

6.2. LEVEL RECORDERS

B & K produces two mains-operated Level Recorders (Types 2305 and 2307) suitable for laboratory use, etc., and a portable battery-operated Level Recorder (Type 2306) which is very suitable for field recordings. Each type may be connected directly to the 2209 via one of its OUTPUT sockets for recording signals (analyzed or time histories) on a paper trace, as follows.

6.2.1. AC Recording

For the recording of continuous non-impulsive sounds, the AC OUTPUT of the 2209 gives the greater dynamic range (> 50 dB) and linearity. The output voltages are given in the specifications (Chapter 1) and the signals are independent of the METER SWITCH position (except in the "Batt. (Rec.)" position). The operating procedures for the Level Recorders are given in the appropriate Instruction Manuals.

6.2.2. DC Recording

For the recording of discontinuous noise, such as that from typewriters, punch presses, etc., the DC OUTPUT is recommended to ensure stable operation of the Level Recorder in its DC mode. The DC OUTPUT comes directly from the meter rectifier circuits, and thus its characteristics will be selected by the METER SWITCH. For the recording of impulsive sounds, the "Impulse" position should be used.

The DC OUTPUT of the 2209 has a dynamic range of approximately 25 dB. Using 50 mm Level Recorder Paper and a 25 dB Range Potentiometer, the dynamic range is optimized by adjusting the Level Recorder for an indication of "+ 20" dB above the bottom line on the paper corresponding to a full-scale meter needle deflection of the 2209. (For example, if the 2209 indicates "+ 4" dB during calibration, the Level Recorder should be set to indicate "+ 14" dB above the bottom line on the paper. See the Level Recorder Instruction Manual.) Thus a signal 5 dB above the full-scale meter needle deflection can be accurately recorded, provided no overloads occur.

For DC recordings, the Level Recorder controls may be set as follows:

| | |
|---------------------------|---------------------------|
| POTENTIOMETER RANGE: | "25 dB" (2305 or 2307) |
| RECTIFIER: | "DC" (2305 or 2307) |
| RECORDING MODE: | "DC Log." (2306) |
| LOWER LIMITING FREQUENCY: | "50 Hz" (2305 or 2307) |
| WRITING SPEED: | "250 mm/s" (2305 or 2307) |
| WRITING SPEED/LF LIMIT: | "250 mm/s"/"25 Hz" (2306) |
| PAPER SPEED: | "0,3 mm/s" |

Fig.6.1 shows some recordings of punch-press noise from the 2209 DC OUTPUT using various meter responses.

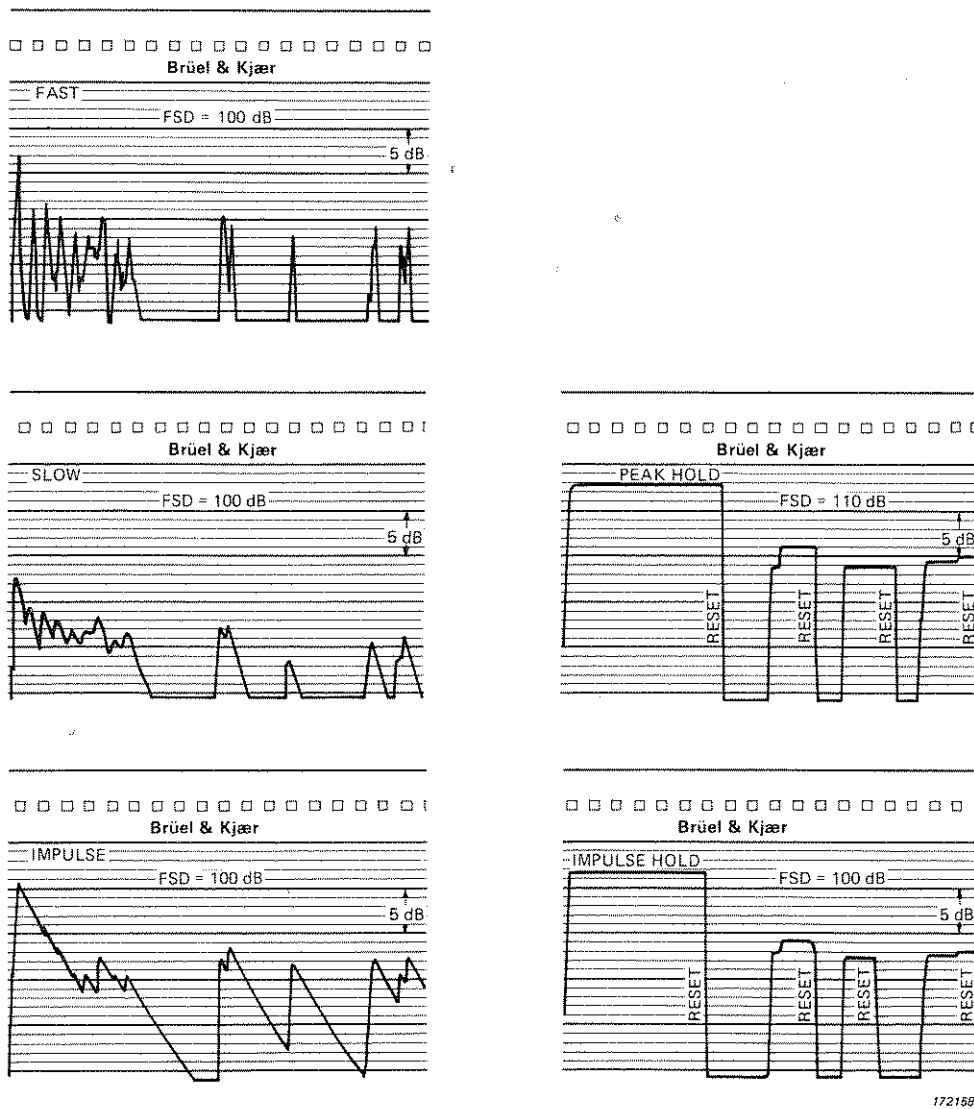

172158

Fig.6.1. Recordings of punch-press noise from DC OUTPUT with various meter responses

6.3. TAPE RECORDERS

When signals are to be recorded from the 2209 for storage and later analysis, the portable battery-operated B & K Tape Recorders Types 7003 and 7004 are available. Always adjust the Tape Recorder gain for the best dynamic range without overload, and record a reference level to which all changes of 2209 ATTENUATOR setting may be referred. For the recording of impulsive or single events, the Tape Loop Cassette UD 0035 may be used with the Tape Recorder to ease analysis. For full details, consult the appropriate Instruction Manuals.

6.4. DIGITAL RECORDERS

The ideal and most flexible approach to impulse recording is the B & K Digital Event Recorder Type 7502, which provides an extremely wide range of frequency transformation, and also permits the recording of information before the triggering. For full details, see its Instruction Manual.

