

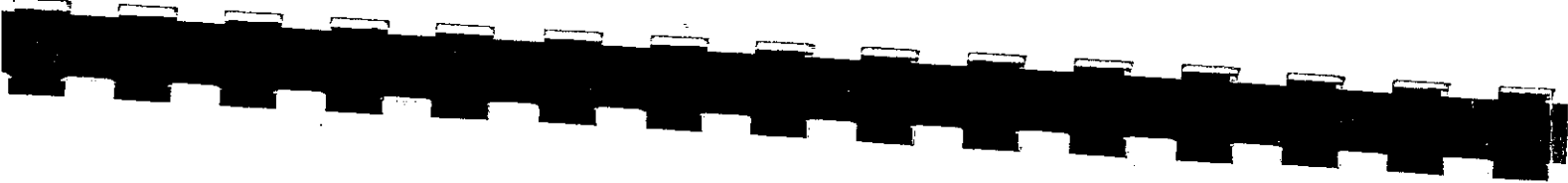

NOTICE

This equipment complies with the requirements in Part 15 of FCC Rules for a Class A computing device. Operation of this equipment in a residential area may cause interference in which case the user will be required to take whatever measures may be necessary to correct the interference at his own expense.



A-SERIES

Electronic Analytical Balances
Operating Instructions

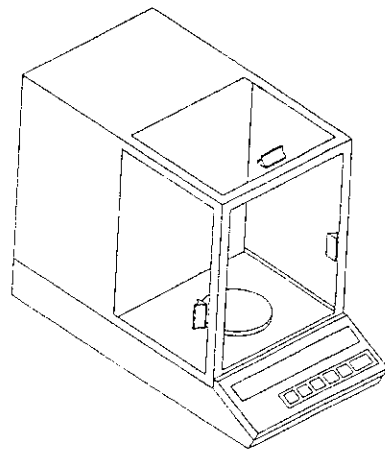

Fisher Scientific

Congratulations on choosing a **Fisher Scientific A-Series Balance**. Your **A-Series Balance** is a precision unit designed and engineered to the most rigorous standards in order to give you years of weighing service.

- ☒ First, check the contents of the shipping carton. You should find the following:

- A-Series Manual
- A-Series Balance
- Weighing Pan
- Power Cord

- ☒ Next, follow the instructions for installing your balance. (See pages 4 -5.)

- ☒ Now you're ready to begin using your **A-Series Balance**. To take advantage of its many features, carefully read your operating manual. It contains step-by-step procedures, examples, and other vital information.

- ☒ Finally, remember to return your completed warranty card within ten days and to record all purchase information in the space provided inside the front cover of your manual.

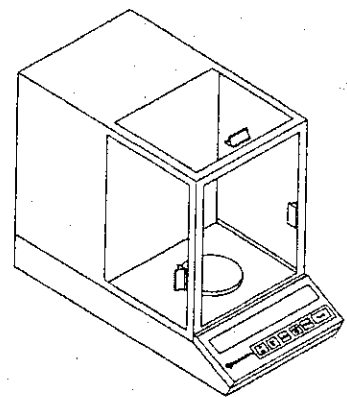

Fisher Scientific A-Series Balances

Specifications

Model	A-160	A-250	A-200D	A-200DS
Capacity	160g	250g	200g/100g	200g/31g
Readability	0.1mg	0.1mg	1/0.1mg	0.1mg/0.01mg

Common Specifications and Features For All Fisher Scientific A-Series Models

- Electrical Requirements 115/230 vac 50/60 Hz
- Response Time Variable,
- Controls Silicone Rubber Keyboard, 5 Keys plus Tare
- Display, Numeric5" Vacuum Fluorescent, seven segment character
- Display, Message25" Vacuum Fluorescent, 14 segment, 10 characters
- Pan Diameter 3 1/4" (8.25 cm)
- RS-232 Bi-directional Interface, 5 different formats
- Automatic Calibration with built-in weights

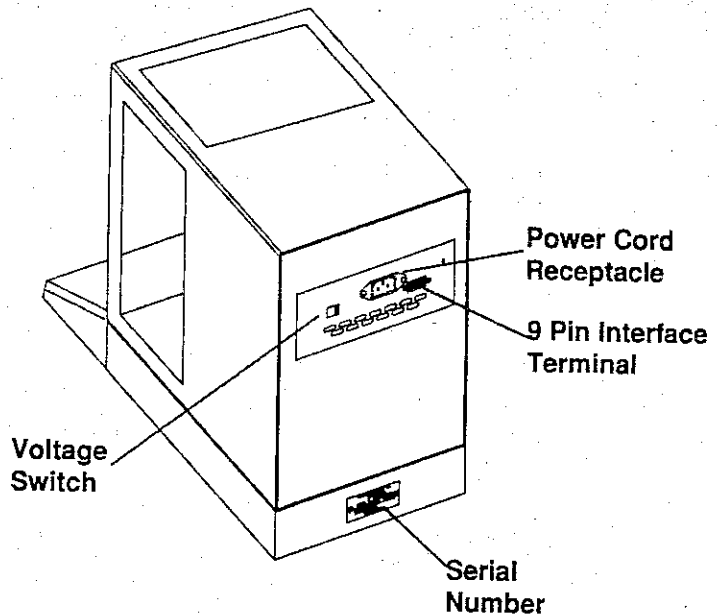
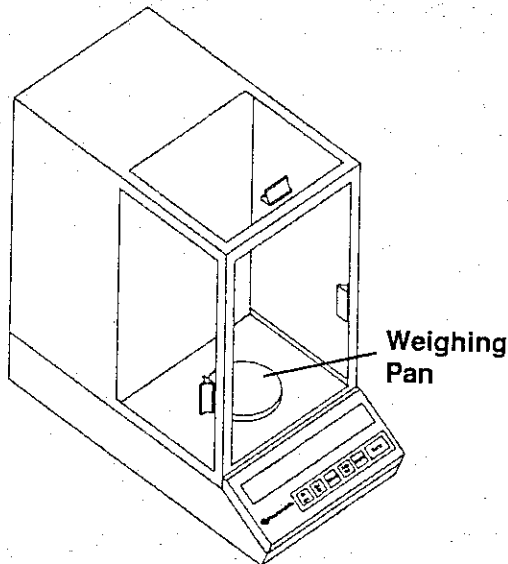
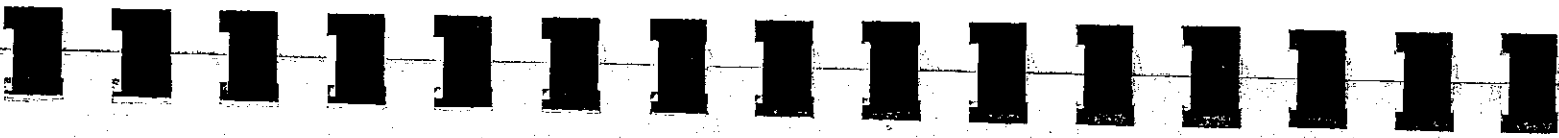

PREPARATION

Select a suitable work area.

- ☐ Work area should be relatively free from drafts and vibrations.
- ☐ Work surface should be level and rigid.
- ☐ Line voltage to the balance should be reasonably constant and free from fluctuations. It is **not** advisable to use an outlet that is shared with fluorescent fixtures or other electrical equipment that draws voltage in an inconsistent manner.
- ☐ Do **not** locate near magnetic materials or equipment/instruments which use magnets in their design.
- ☐ Avoid areas which have variations in room temperatures or have excessive room temperatures. Room temperatures above 105°F/40°C or below 60°F/15°C could affect balance operation and accuracy.

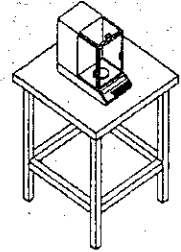

Choose your work site carefully to obtain the best weighing results.

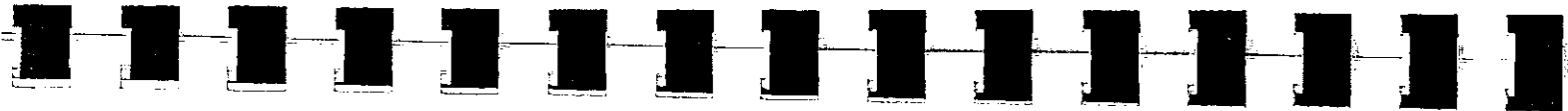

INSTALLATION

Set up your balance by following these steps:

- ☐ Remove balance and all accessories from the carton. There is no internal packing or tie downs inside the balance.
- ☐ Level the balance by using the level bubble and the leveling feet located underneath the base.
- ☐ Place the weighing pan on the balance.
- ☐ Insert power cord into the receptacle located on the rear panel of the unit. Firmly push in the plug.
- ☐ Balance model designation is displayed during start-up message.
- ☐ Allow a **60** minute warm up period.
- ☐ Do **not** unplug your balance. **Fisher Scientific** Electronic Balances are designed to be continuously plugged in.
- ☐ When the unit is **not** in use, press the  key to turn the displays **OFF**.

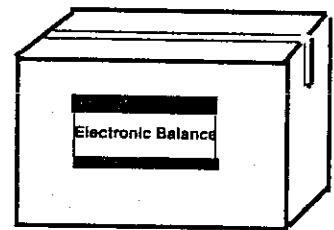

This is a precision electronic instrument. Handle with care to ensure years of trouble-free use.



GENERAL INFORMATION

Dual Display		Beeper	9
Numeric Display	8	Keyboard	10
Message Display	9	Default (Factory) Settings ..	11
Unstable Indicator	9	Dual Range Models	12

GENERAL INFORMATION

Dual Display

Your balance features two displays (a Numeric Display and a Message Display) to give you complete weighing information.

Numeric Display

The Numeric Display continuously shows your weighing results.

The number of decimal places displayed depends on the balance model.

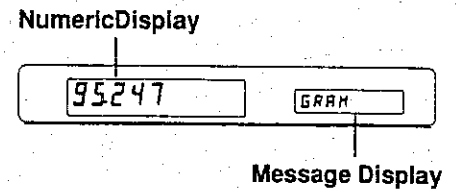

Message Display

The Message Display uses text to clearly provide weighing information.

During a weighing application, the Message Display continues to show the weighing mode, *GRAM*.

During the Set Up procedures, the Message Display shows the options as you cycle through the selections.

Whenever the balance is unstable, an indicator (U) appears on the far right side of the Message Display. When the balance has stabilized, the indicator disappears.



Unstable Indicator

Always make sure your balance is stable before and after each step of your weighing operation.

The letter *U* appears on the far right of the Message Display whenever the balance is **not** stable. It disappears when the balance becomes stable.

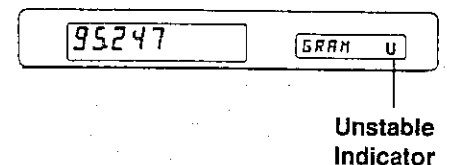

Beeper

An audible BEEP is emitted whenever a function is activated. This signal ensures you that the key you pressed is working. If you press a key and a BEEP is **not** heard, press the key again until the BEEP is heard. However, some keys are disabled in some functions and therefore will **not** BEEP.

To turn the BEEPER *OFF* or adjust its length, see the **Set Up-Display** Section.

A-Series Keyboard

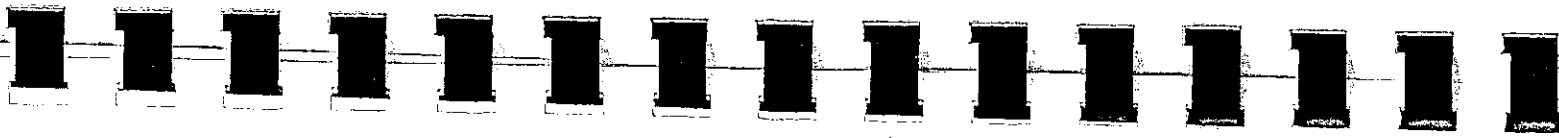
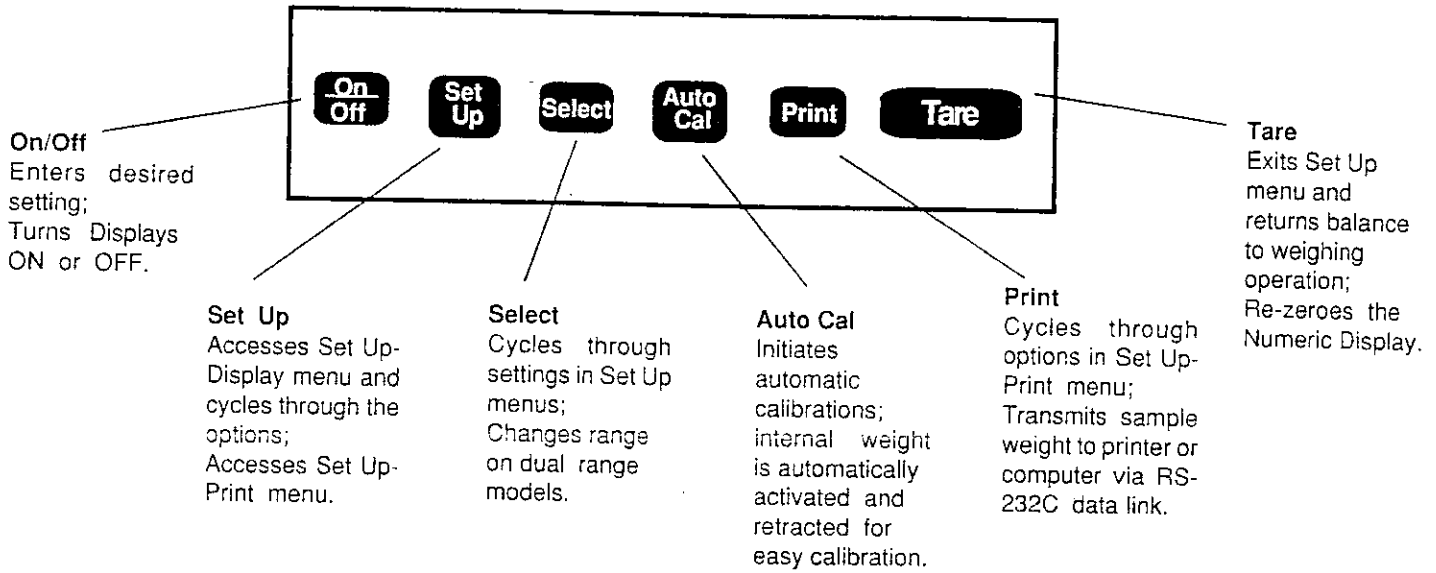

Default (Factory) Settings

Your balance is pre-set at the factory to correspond to the most common user requirements. Listed below are the factory settings that are activated when the balance initially is turned on.

<u>Menu</u>	<u>Setting</u>
Set Up-Display	
Filter	Filter Normal
Auto-Zero	Auto- Zero On
Beeper	Beeper Long
Range	Automatic Range (Model 200D) Manual Range (Model 200DS)
Set Up - Print	
Print	Single
Baud	Baud 300
Print Format	Type 1
Zero Print	Zero Print On
Parity	Parity Off
Interval	No Interval

Additional settings are listed in the Set Up sections of this manual. You can easily change the factory settings to any of these options by following the procedure outlined in that section. For a complete list of all the settings available on your **A-Series** Balance, see **Appendix A**.

Basic Weighing

If you have properly installed your balance and allowed adequate warm-up time, you are now able to do any basic weighing application without further adjustments. The factory settings (see page 12) are automatically activated when the balance is powered up. Just calibrate your balance (see page 18) and then follow the three easy steps listed below:

PROCEDURE

1. Press the **Tare** key to zero the Numeric Display.
2. Place sample to be weighed on the weighing pan.
3. When the unstable indicator disappears on the Message Display, you are ready to record the value on the Numeric Display.

DISPLAYS SHOW

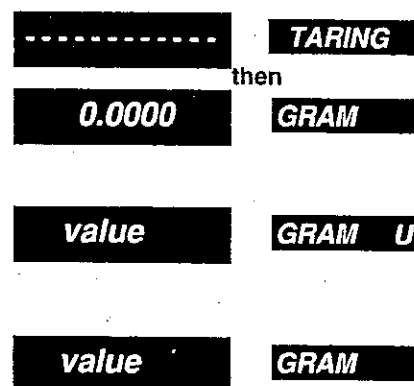

Taring (Zeroing)

Balances have tare capabilities up to their total weight capacity. (Check your balance capacity with the specifications for your model on page 2.)

To weigh a sample in its container with the Numeric Display showing the weight of the sample, use the following Tare Procedure:

PROCEDURE

1. Place sample container on pan, wait for the unstable indicator (U) to disappear, and then press the **Tare** key.
2. Now place sample in its container.
3. When the balance is stable, the Numeric Display shows the weight of the sample.

Auto Cal

All **A-Series** Analytical Balances feature Auto Cal with an internal weight calibrated to NBS standards for accuracy. To use the automatic calibration feature:

- Allow the balance to warm up for at least 60 minutes;
- Wait for the Unstable Indicator (*U*) to disappear on the Message Display.

Then use the following procedure:

(Model **A-160** with a 100 gram internal weight is used as an example in the procedure.)

PROCEDURE

1. Press the **Tare** key to zero the Numeric Display.

2. Press the **Auto Cal** key.

DISPLAYS SHOW

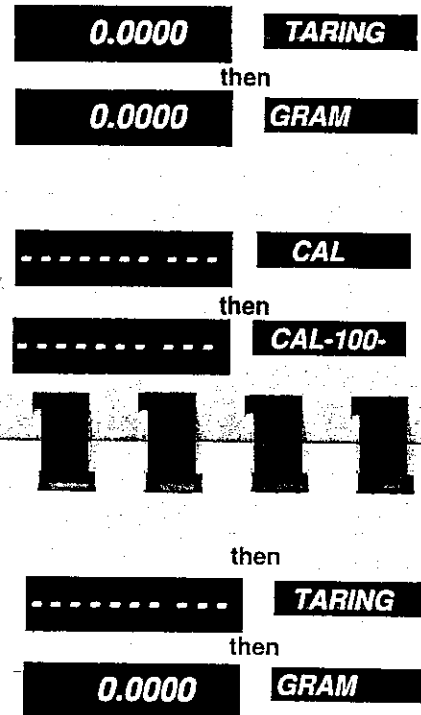

Model **A-200DS** features two internal weights (125g for the coarse range and a 25g for the fine range) and should be calibrated in both ranges.

Using External Weights

External calibration weights also can be used for calibration purposes. Use one of the following permissible calibration weights :

Calibration Values Model A-160

- CAL 50 = 50.000g
- *CAL 100 = 100.000g
- CAL 150 = 150.000g

Calibration Values Models A-250, A-200D

- CAL 50 = 50.000g
- *CAL 100 = 100.000g
- CAL 150 = 150.000g
- CAL 200 = 200.000g

Calibration Values Model A-200DS

- CAL 10 = 10.00000g
- CAL 20 = 20.00000g
- *CAL 25 = 25.00000g
- CAL 100 = 100.0000 g
- *CAL 125 = 125.0000 g
- CAL 200 = 200.0000 g

*Value of the internal weights is supplied with the balance; however, offsets are **not** used when calibrating with external weights.

To calibrate using an external weight:
 (A 100 gram weight is being used as an example in the procedure.)

PROCEDURE

1. Remove samples from the weighing pan.
 2. Press the **Tare** key to zero the Numeric Display.
 3. Place 100 gram calibration weight on the weighing pan and wait for the unstable indicator to disappear.
 4. Press the **Auto Cal** key.
- If weights being used are out of range or the balance capacity is exceeded, the Message Display shows *NO CAL* and does not complete calibration.
5. Remove weight.

DISPLAYS	SHOW
0.0000	GRAM
0.0000	TARING
100.000	GRAM
100.000	CAL-100-
0.0000	GRAM

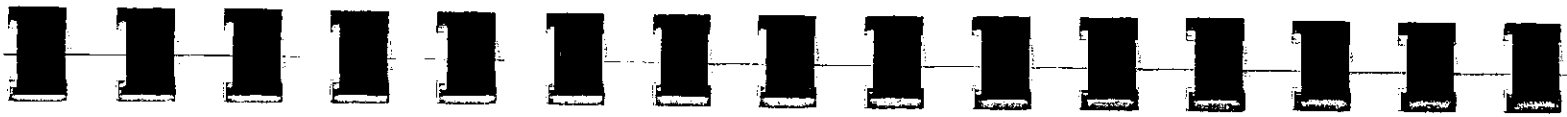

Modifying The Calibration Variance

Corrections can be made to the calibration values to compensate for the difference between the actual weight being used and the desired value. This feature allows the calibration values to be altered to match "known weights". Values can be altered as much as ± 199 digits from the ideal value.

Altering the Cal 100 internal value on **Models A-160, A-250, and A-200D** will change the internal calibration variance as set by the manufacturer. Likewise, altering the Cal 25 or the Cal 125 on **Model A-200DS** will change the the internal calibration variance. The pre-set values are noted on the back of the balance.

The "offsets" established in the procedure on the next page remain in memory until altered by the user. The same procedure must be used to alter the "offsets".

Dual Range

Two A-Series Models are designed as dual range balances:

A-200D

A-200DS

These models provide a fine range to increase readability by a factor of 10. In the Set Up Menu (See page 33) ,you can program the dual range models for Automatic Range or Manual Range.

AUTO R (Automatic Range) allows the balance to change from fine range to coarse range when the capacity is exceeded.

MANUAL R (Manual Range) keeps the balance in the fine range.

Press the **Select** key to change range. However, when changing to the fine range, make sure the weighing pan is empty and the samples to be weighed do not exceed the fine range capacity.

The position of the decimal point on the Numeric Display identifies the weighing range. One decimal place is added when weighing in the fine range.

(For Example: coarse range - 150.0000g
fine range - 25.00000g)



When your balance is changing ranges, it always tares. The displays show

DISPLAYS SHOW

four place models

value **WORKING**

then

0.000 **GRAM**

five place models

----- **WORKING**

then

0.0000 **GRAM**

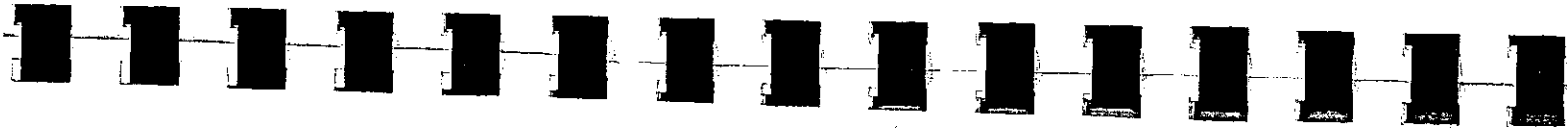

OPERATING YOUR A-SERIES BALANCE

Basic Weighing	16
Taring	17
Auto Cal	18

To modify the calibration variance, use the following procedure:

PROCEDURE

1. Press the **Auto Cal** key.
2. Press repeatedly the **Set Up** key until the calibration value to be modified is displayed.
3. Press the **On Off** key to choose the value.
4. Press repeatedly the **Select** key to select either the plus or minus sign.
5. When the desired sign is displayed, press the **On Off** key to choose it.
6. Press repeatedly the **Select** key to change the most significant digit. (Digits 0 - 1 cycle as you press this key.)

MESSAGE DISPLAY SHOWS

CAL

CAL -100-

V + 00.0 mg

V - 00.0 mg

V - 00.0 mg

V - 10.0 mg

V - 10.0 mg

V - 12.0 mg

V - 12.0 mg

7. When the desired digit is displayed, press the **On Off** key to choose it.
8. Press repeatedly the **Select** key to change the next digit. (Digits 0 - 9 cycle as you press this key.)
9. When the desired digit is displayed press the **On Off** key to choose it.
10. Repeat Steps #8 and #9 for each additional digit.

The balance returns to normal operation after all of the digits have been selected.



BALANCE CONFIGURATION

Using the Set Up Menus

Set Up - Display

Default. 27
Filter. 29
Auto-Zero. . . . 31
Beeper. 32
Range. 33

Set Up - Print

Print. 36
Baud. 38
Format. 39
Zero Print. . . 41
Parity. 42
Interval. . . . 44

Set Up

The **Set Up** key is used to access the Set Up-Display Menu and the Set Up-Print Menu. These menus provide other settings that you can select in order to adapt your balance to fit a particular weighing situation.

Set Up-Display

The shaded parameters indicate the default (factory) settings.

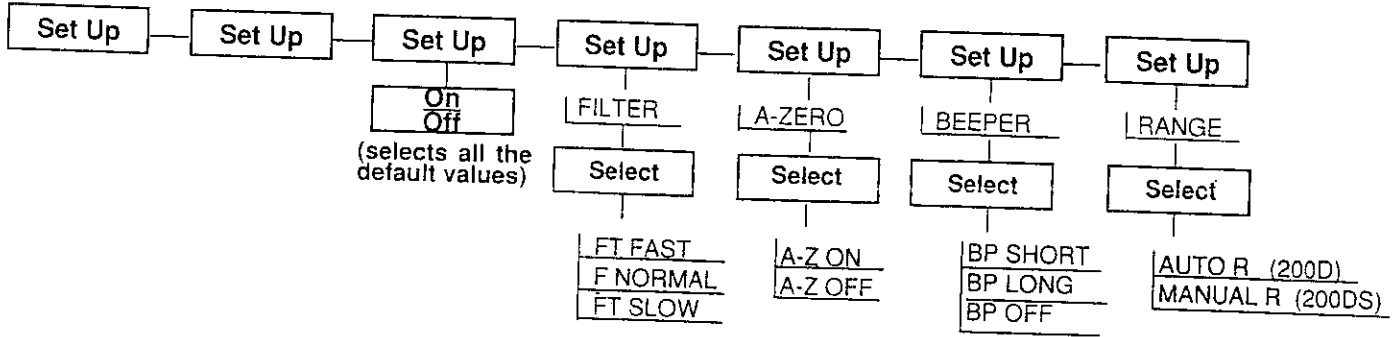

The **Set Up-Display** menu is used for the following options:

- Default Sets the parameter to default settings
- Filter Optimizes response to vibrations by changing the update speed
- Auto Zero Automatic re-zero of display
- Beeper Sets beeper control
- Range On dual range models, selects method for range change

Default Values





Initially, the Default Values are activated when your balance is powered up. These settings, listed below, remain in memory until changed by the user.

- Filter Normal
- Auto-Zero On
- Beeper Long
- Range Automatic (200D)
- Range Manual (200DS)
- Print Single
- Baud 300
- Type 1 Output
- Zero Print On
- Parity Off
- Auto Print

However, If any of the settings have been changed you can quickly re-set all the default values by using the procedure on the next page.

Re-setting The Default Values

PROCEDURE

1. Press the  key.
2. Press the  key again.
3. Press the  key again.
4. Press the  key to choose all the Default Values.

MESSAGE DISPLAY SHOWS

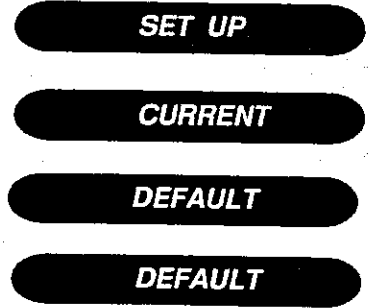

Filter

It is possible to optimize the balance response to compensate for varying conditions, including building vibrations, drafts, surface vibrations, etc. Three settings are available - Filter Fast, Filter Normal, and Filter Slow.

Filter Fast Used under ideal conditions; provides the fastest response time; at this setting, the balance is much more susceptible to vibrations and drafts.

Filter Normal Used under standard lab conditions; operates at moderate speed.

Filter Slow Used in areas with vibrations and drafts; averages more readings at a slower rate.

We recommend that you try various Filter Settings to determine the most suitable setting in relation to your environment and/or usage.

Filter cont..

PROCEDURE

1. Press repeatedly the **Set Up** key to advance to *FILTER*.
2. Press repeatedly the **Select** key to cycle through the settings.
FT FAST
F NORMAL
FT SLOW
4. When the desired setting is displayed, press the **On Off** key to choose it.
5. Either press the **Set Up** key to advance to the next option or press the **Tare** key to exit the menu and return to the weighing mode.

MESSAGE DISPLAY SHOWS

FILTER*setting**setting***A-ZERO****TARING**

Auto-Zero

Auto-Zero helps maintain a zero display reading (when the balance has been Tared to zero) in a less than ideal weighing environment. This feature automatically corrects for zero drift .

A-Z ON (Auto-Zero On) Automatically compensates for zero drift.

A-Z OFF (Auto-Zero Off) Turns off this correction feature.

PROCEDURE

1. Press repeatedly the **Set Up** key to advance to *A-ZERO*.
2. Press repeatedly the **Select** key to cycle through the settings.
A-Z ON
A-Z OFF
4. When the desired setting is displayed, press the **On Off** key to choose it.
5. Either press the **Set Up** key to advance to the next option or press the **Tare** key to exit the menu and return to the weighing mode.

MESSAGE DISPLAY SHOWS

A-ZERO*setting**setting***BEEPER****TARING**

Beeper

The volume of the audible BEEPER can be adjusted or turned OFF. Three settings are available:

- Beeper Short Sets a softer tone for less than a second.
- Beeper Long Sets a louder tone for approximately one second.
- Beeper Off Turns off the tone.

PROCEDURE

1. Press repeatedly the **Set Up** key to advance to *BEEPER*.
2. Press repeatedly the **Select** key to cycle through the settings.

BP SHORT
BP LONG
BP OFF
4. When the desired setting is displayed, press the **On/Off** key to choose it.
5. Either press the **Set Up** key to advance to the next option or press the **Tare** key to exit the menu and return to the weighing mode.

MESSAGE DISPLAY SHOWS

- BEEPER**
- setting*
- setting*
- RANGE**
- TARING**



Range

On dual range models, there are two settings:

- Auto Range** Sets your balance to automatically change range when lower capacity is exceeded; also, with this setting, use the **Select** key to switch ranges.
- Manual Range** Keeps the balance from switching ranges when the capacity is exceeded; instead, the Message Display shows *OVER* when this occurs.

PROCEDURE

1. Press repeatedly the **Set Up** key to advance to *RANGE*.
2. Press repeatedly the **Select** key to cycle through the settings.

AUTO R
MANUAL R
4. When the desired setting is displayed, press the **On/Off** key to choose it.
5. Either press the **Set Up** key to begin the cycle again or press the **Tare** key to exit the menu and return to the weighing mode.

MESSAGE DISPLAY SHOWS

- RANGE**
- setting*
- setting*
- DEFAULT**
- TARING**

Set Up - Print

The shaded parameters indicate the factory settings.

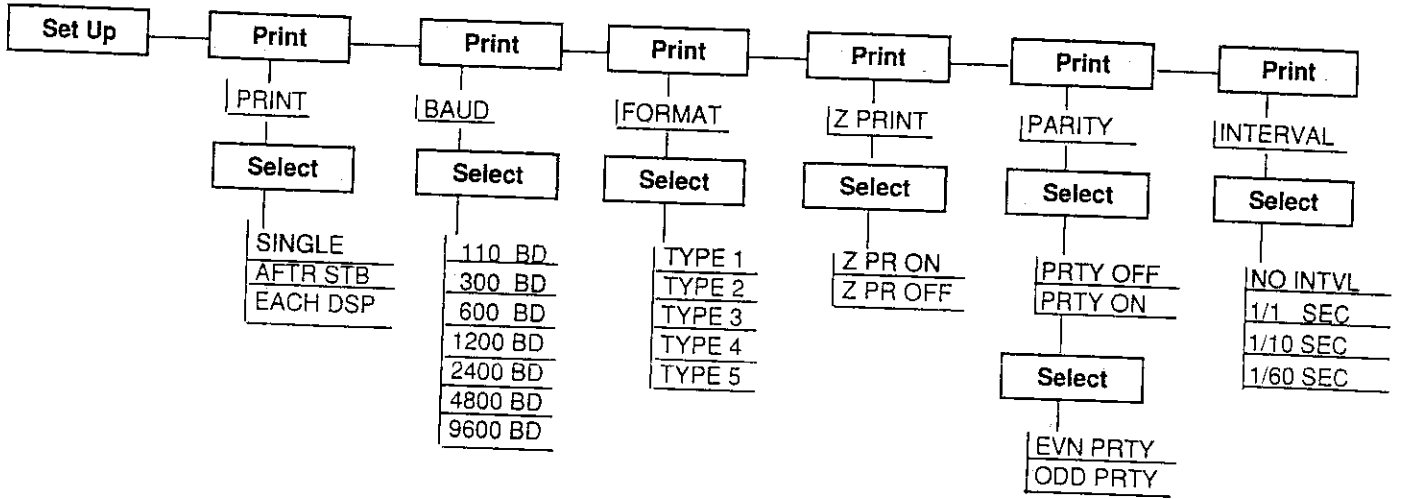

Set Up - Print Menu

The **Set Up** key and the **Print** key are used to access the Print Menu in order to make the following settings:

- Print Allows the balance to send data to a computer or printer when interfaced;
- Baud Sets the transfer rate unit for serial data transmission in bits/second.
- Format Sets the format for the type of I/O string.
- Zero Print Permits balance to print at zero weight
- Parity Permits recognition of simple bit errors in data transmissions.
- Interval Adapts data transfer to match receivers of different speeds.

Print

The Print option allows you to select from three modes of printing a data string when the balance is interfaced to a computer or printer.

- Single: Sends a single data string from balance to printer or computer when the **Print** key is pressed.
- After Stability: Automatically sends a single data string after the display stabilizes.
- Each Display: Continually sends a signal through the I/O port.

PROCEDURE

1. Press the **Set Up** key.
2. Press the **Print** key to advance to *PRINT*.
3. Press the **Select** key to cycle through the settings.
SINGLE
AFTR STB
*EACH DSP**
4. When the appropriate setting is displayed, press the **On/Off** key to choose it.

MESSAGE DISPLAY SHOWS

SET UP

PRINT

setting

setting

5. Either press the **Print** key to advance to the next option or press the **Tare** key to exit the menu and return to the weighing operation.

BAUD

or

TARING

* This option must be selected if you plan to adjust the interval setting.

Set Up-Print

Baud

The rate at which data is input to and output from the balance can be selected. Choose the baud that matches the setting on the printer or computer used with the balance. Seven choices are available.

PROCEDURE

1. Press the **Set Up** key.
2. Press repeatedly the **Print** key to advance to *BAUD*.
3. Press repeatedly the **Select** key to cycle through the settings.

110 BD	1200 BD
300 BD	2400 BD
600 BD	4800 BD
	9600 BD
4. When the appropriate setting is displayed, press the **On/Off** key to choose it.
5. Either press the **Print** key to advance to the next option or press the **Tare** key to exit the menu and return to the weighing operation.

MESSAGE DISPLAY SHOWS

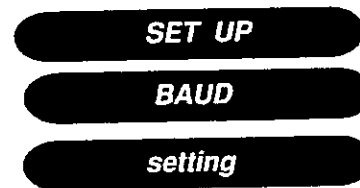

Format

This option sets the format for the type of I/O string. Five choices are available :

	Stable	Unstable
Type 1	1 + 0000.0002	U + 0000.0002
Type 2	S + 0000.0003 g	SD + 0000.0003 g
Type 3	ST + 0000.0003	US + 0000.0003
Type 4	+ 0000.0003	+ 0000.0003
Type 5	+0000.0003 grams	+0000.0003 UNSTABLE

PROCEDURE

1. Press the **Set Up** key.
2. Press repeatedly the **Print** key to advance to *FORMAT*.

MESSAGE DISPLAY SHOWS



Set Up-Print

Format cont.

- 3. Press repeatedly the **Select** key to cycle through the settings.

TYPE 1
 TYPE 2
 TYPE 3
 TYPE 4
 TYPE 5

- 4. When the appropriate setting is displayed, press the **On/Off** key to choose it.

- 5. Either press the **Print** key to advance to the next option or press the **Tare** key to exit the menu and return to the weighing operation.

setting

setting

Z-PRINT

or

TARING

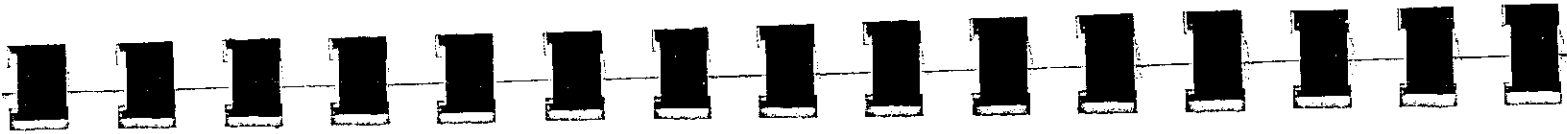

Zero Print

The Zero Print Option selects whether or not to print at zero weight.

PROCEDURE

- 1. Press the **Set Up** key.
- 2. Press repeatedly the **Print** key to advance to Z PRINT.
- 3. Press repeatedly the **Select** key to cycle through the settings.

Z PR ON
 Z PR OFF

- 4. When the appropriate setting is displayed, press the **On/Off** key to choose it.

- 5. Either press the **Print** key to advance to the next option or press the **Tare** key to exit the menu and return to the weighing operation.

MESSAGE DISPLAY SHOWS

SET UP

Z PRINT

setting

setting

PARITY

or

TARING

Parity

The Parity Option permits you to set a control bit to check the accuracy of serially transmitted data. The Parity setting must match the printer or computer used with the balance.

Even Parity requires that the number of set bits must be even.

Odd Parity requires that the number of set bits must be uneven.

PROCEDURE

1. Press the **Set Up** key.
2. Press repeatedly the **Print** key to advance to *PARITY*.
3. Press repeatedly the **Select** key to cycle through the settings.
PRTY OFF
PRTY ON
4. When the appropriate setting is displayed, press the **On Off** key to choose it.

MESSAGE DISPLAY SHOWS

SET UP

PARITY

setting

setting



- 5a. If you have set Parity *ON*, continue to press the **Select** key for the next setting; if you have set Parity *OFF*, skip to Step #6.
- 5b. Continue to press the **Select** key to cycle through the settings.
EVN PRTY
ODD PRTY
- 5c. When the appropriate setting is displayed, press the **On Off** to choose it.
6. Either press the **Print** key to advance to the next option or press the **Tare** key to exit the menu and return to the weighing operation.

setting

setting

setting

INTERVAL

or

TARING

Set Up-Print

Interval

The Interval Option selects the interval for data transfer to your printer. Four choices are available:

- No Interval Transfers data automatically when any change or update occurs.
- Print 1/1 second Transfers data once every second; however, this rate may vary depending upon the baud setting.
- Print 1/10 seconds Transfers data once every ten seconds.
- Print 1/60 seconds Transfers data once every 60 seconds.

PROCEDURE

1. Press the **Set Up** key.
2. Press repeatedly the **Print** key to advance to *INTERVAL*.

MESSAGE DISPLAY SHOWS

SET UP

INTERVAL



3. Press repeatedly the **Select** key to cycle through the settings.

NO INTVL
*1/1 SEC**
*1/10 SEC**
*1/60 SEC**

setting

* To use this setting, the Each Display (EACH DISP) must be selected as outlined in setting the Print Option. (See page 36.)

4. When the appropriate setting is displayed, press the **On/Off** key to choose it.

setting

5. Either press the **Print** key to begin the cycle again or press the **Tare** key to exit the menu and return to the weighing operation.

PRINT

or

TARING

Set Up-Print**Current Values**

This feature permits you to check which parameters have been set using the Set Up procedures described above. This procedure merely informs you and does not permit you to make any changes.

PROCEDURE

1. Press the **Set Up** key.
2. Press the **Set Up** key again.
3. Press the **On Off** key to access the menu.
4. Continue to press the **Select** key to cycle through the list of current values that have been set.
5. Press the **Tare** key to return to normal weighing operation.

MESSAGE DISPLAY SHOWS**SET UP****CURRENT****CURRENT****current settings****TARING****Displays On/Off**

Pressing the **On Off** key turns both displays either *ON* or *OFF*.

When the displays are turned *OFF*, the only key that works is the **On Off** key; the rest of the keyboard is disabled.



INTERFACE APPLICATIONS

Technical Specifications . . . 50
Signal Definition 50

I/O Specifications 51
I/O Commands 53

INTERFACE APPLICATIONS

Technical Specifications

I/O Connector

The mating connector is a 9 pin subminiature D socket, Cinch DE-9S or equivalent. Pins used are as follows:

PIN #	FUNCTION	PIN #	FUNCTION
1	Case Ground	3	Data Output
2	Data Input	7	Ground

NOTE

Improper connections to the I/O connector may result in damage to the balance!

Signal Definition

The **A-SERIES** uses a level compatible RS-232C interface, with 8 data bits, null parity, and two (2) stop bits. For the balance to interface, the balance **must** receive one (1) or two (2) stop bits.

Data output: Voltage output compatible with RS-232C levels, 300 ohm source resistance and ± 10 volt swing minimum.

Data input: Voltage input compatible with RS-232C levels, nominal 3000 ohms input impedance, ± 5 volt minimum swing, ± 20 volts maximum voltage.



Case ground: Tied to earth ground through the power cord.

Signal ground: Tied internally to the case ground.

I/O Specifications

The information transfer to and from the balance is accomplished with RS-232C serial compatible signals, using 8 data bits and null parity. The interface connector is a 9 pin male subminiature D plug.

It is important to determine interface requirements of equipment connected to the balance.

The maximum recommended cable length is 25 feet. The information is transmitted at variable baud rates (from 110 to 9600) in standard ASCII format. Baud from 110 to 4800 will have less than 1% error factor. Baud of 9600 will be approximately 5% slower than actual rate and may **not** work with some peripheral equipment. See "SET UP" procedures for changing baud.

Output Specifications

Output can be in one of the following forms:

	<u>Stable</u>	<u>Unstable</u>
Type 1	1 + 000000.02	U + 000000.02
Type 2	S + 000000.03 g	SD + 000000.03 g
Type 3	ST + 000000.03	US + 000000.03
Type 4	+ 000000.03	+ 000000.03
Type 5	+000000.03 grams	+000000.03 UNSTABLE

The output string is terminated with a <cr> <lf>.

Input Specifications

It is possible to control the balance from a terminal or computer with RS-232C interface and a baud rate between 110 and 9600. When interfaced, all balance settings and operations can be directly accessed from the computer or terminal.



I/O COMMANDS

Using I/O Commands greatly expands the features and functions of your A-Series Balance. If you need more information regarding the additional balance operations, contact our Customer Service Department at 1-800-321-1135.

Description

The following commands can be used to perform the functions. The commands will either be immediate or must be followed by carriage return, noted by <cr>. Do **not** press the <cr> unless it is included in the command. The symbol # designates a number following the command letter. It can be either a simple character or a string of characters. Except as noted, all commands are upper case.

Immediately **Tares** balance to zero.

Calibrate command. Allows the user to re-calibrate the balance using the allowed calibration weights. To use, place the calibration weight on the pan and send the calibrate command. The balance displays CALIBRATE (it may flash very quickly if the balance is able to complete the calibration without waiting), and then returns with the new calibration, if possible.

Parts Re-calibration. Allows the user to display a number to represent the weight on the pan. This can be used for parts counting, check weighing, or conversion to other weight functions not available with the F command. The number # can be any value from .000001 to 999999; however, care must be exercised when using this command to ensure accurate results.

Command

T

CAL<cr>

P#<cr>

I/O

Decimal Point Position. When in the COUNT function, the decimal point may be positioned as necessary. Position zero is to the right of the least significant digit and position seven is to the left of the seventh digit. Seven digits plus the decimal place are available, but there may be some variations depending upon the unit's capacity.

D#

Range Change. Selects Range on dual range models.
Changes Range to Lower capacity.
Changes Range to Higher capacity.

RL
RH

Function select. The balance changes to the function selected by the function number (#). The # represents a hex number (0-9, A-C). It is not necessary to remove the weight or tare when changing functions. The following table lists the Function number and function name.

F#

0 COUNT	5 GRAIN	A KILO (Kilogram)
1 GRAM	6 CARAT	B TAEL
2 DWT (Pennyweight)	7 POUND	C MATH A
3 OUNCE	8 SCRUP (Scruple)	D MATH B
4 OZT (Troy Ounce)	9 DRAM	

SET UP. Accesses Set-up Menu.

SU<cr>

Enters Balance Identification Name.

M#<cr>

Sets Default Values and Exits.

D

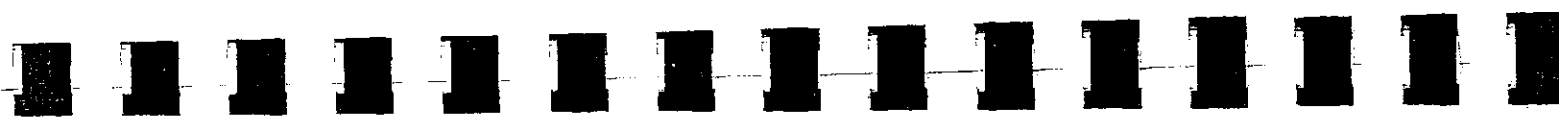

Function

Disables Functions 0-9, A-C.

F#0

Example: F10 = GRAMS OFF

Enables Functions 0-9, A-C.

F#1

Example: F11 - GRAMS ON

Function Initialization re-sets factory parameters.

FI

Sets Filter Integration speeds using a hex number (1-9, A-F) with 1 being the fastest, 5 being the standard, and F being the slowest.

I#

Auto-Zero. Sets Zero Reading Adjustment.

Disables Auto-Zero.

Z0

Enables Auto-Zero.

Z1

Beeper. Adjusts Beeper tone.

Disables Beeper tone.

B0

Sets Beeper for short, soft tone.

B1

Sets Beeper for longer, louder tone.

B2

Range. Adjusts Range Change on dual range models.

Sets Automatic Range change when lower capacity is exceeded.

RA

Keeps balance in lower capacity range, operated Manually.

RM

Exit. Exits and Saves settings that remain stored even if power is lost.

X

I/O

Description	Command
SET UP PRINT. Accesses Print Menu.	SUP<cr>
Print. Sends data string to printer. Prints continuously. Single when Print Key is pressed after balance has stabilized. Prints after balance has stabilized.	P0 P1 P2
Baud. Sets Baud. B1 110 B4 1200 B6 4800 B2 300 B5 2400 B7 9600 B3 600	B#
Format. Sets Format Type for I/O string with F1 being the standard setting. F1 Type 1 F3 Type 3 F5 Type 5 F2 Type 2 F4 Type 4	F#
Zero Print. Sets Printer for Zero Printing. Does not print at zero weight. Prints at zero weight.	Z0 Z1
Parity. Sets Parity Parameters. Turns OFF Parity. Turns ON Parity.	PT0 PT1
Sets Parity at even. Sets Parity at odd.	PT2 PT3
Interval. Sets time Intervals for printing. No Interval. Prints at Intervals set by seconds up to once every 120 seconds.	I0 I#
Sets Echo OFF, half display. Sets Echo ON, full display	E0 E1
Exits and saves settings that remain stored even if power is lost..	X
Prints the data # of times when the balance has stabilized. The # can be 1 to 9. If # is zero, then the balance does a continuous output of the data.	#
Example : If # = 4, then the balance (when stable) outputs its data string four times consecutively following the receipt of the command.	
Enters Balance Identification Number. Up to an eight digit number can be entered, but only the last six digits are shown on the Message Display.	ID=#<cr>
Displays balance name and Identification number.	ID<cr>

Description

Command

Statistical Analysis

Clears memory of any statistical data.

RC

Sample #. Assigns the first sample Number with additional samples being numbered consecutively. # can be from 1 to 1,000.

RN#

Enters sample from weighing pan and assigns sample number beginning with the number previously set.

E

Recalls all statistical data.

R<cr>

Fill Guide

Turns OFF Fill Guide.

G0

Turns ON Fill Guide.

G1

Enters Low Limit.

GL#<cr>

Enters High Limit.

GH#<cr>

Enters Target Weight.

GTW#<cr>

Enters Tolerance Level.

GTL#<cr>

Sets Fill Guide to use Low and High Limits.

GC0

Sets Fill Guide to use Target Weight with Tolerance.

GC1

Sets Fill Guide to display Target Weight on Graph.

GC2

Multiple Tare Values

Enters Multiple Tare Weight directly from the weighing pan.

Z#S

Enters a Multiple Tare Value. The first # is the number of the tare value which can be any digit between 0 and 9. The second # is the weight of the tare value which can be any 6-digit number plus a decimal point.

Z#=#<cr>

Recalls a multiple tare value that has been stored (0-9).

Z#R

Math Function

Enters the value for A.

A#<cr>

Enters the value for B.

B#<cr>

Turns Display OFF .

OF

Turns Display ON .

Activates Keyboard Lock.

KL

Activates all keys on Keyboard.

KU

Linearity Correction

Internal Weight OFF.

W0

Small Internal Weight ON.*

W1*

Large Internal Weight ON.

W2

*Used only with Model A-200DS.

Appendix A- Balance Options

Re-Set To The Default Settings

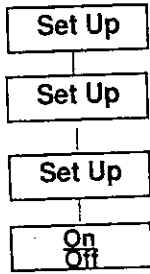

Set Up - Display Parameters

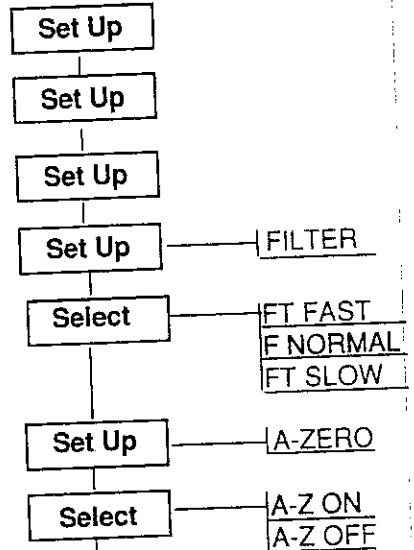

Set Up - Print Parameters

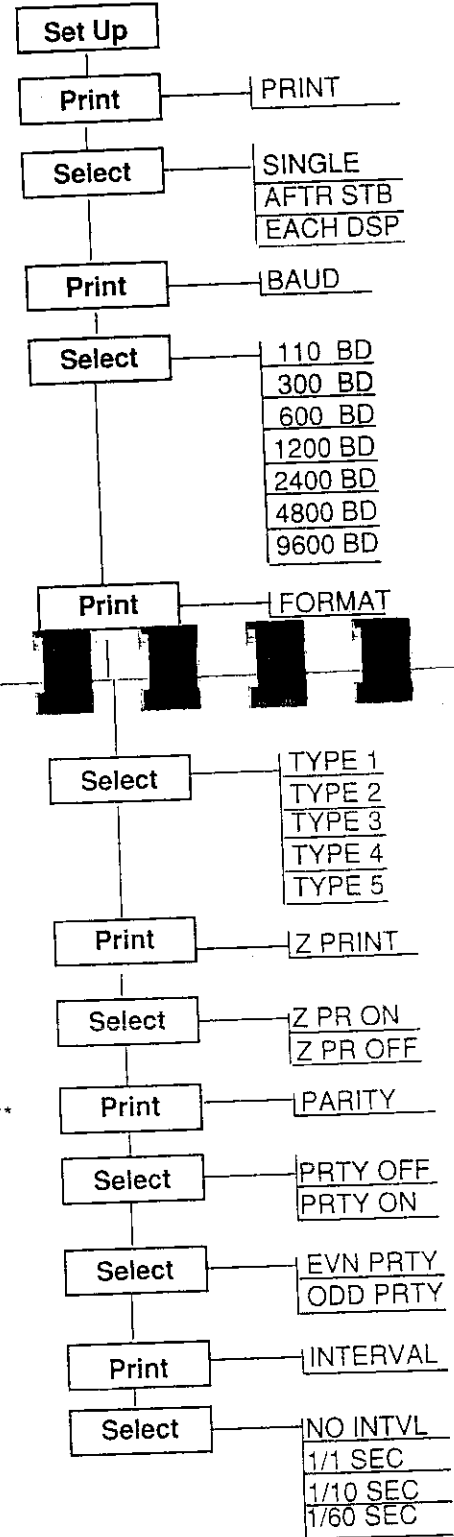

View Current Settings

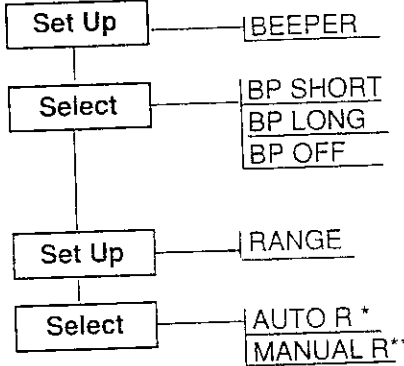
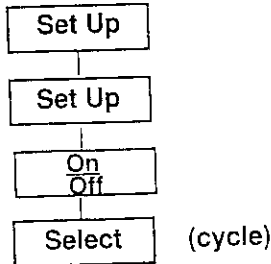

* Factory setting for Model 200D
 ** Factory setting for Model 200DS

The shaded parameters indicate the factory settings. To change any of them, see the appropriate section in this manual.

Appendix B - Trouble Shooting

Display Shows

Cause

Remedy



On Off key pressed to turn *OFF* Displays.
 Power cord not connected.
 No power to outlet or improper voltage.
 Temporary fault.

Press the **On Off** key.
 Connect cord.
 Check power supply.
 Disconnect and re-connect power cord.
 (Wait at least five seconds before re-connecting it.)



Weight exceeds balance capacity.

Reduce weight.



Pan not properly installed.
 Pan obstructed.

Install properly.
 Move balance

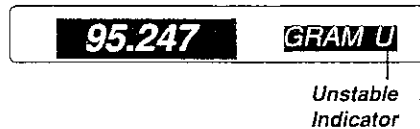

Air movement around balance.
 In-use cover touching pan.
 Unstable location.
 Sample not stationary.

Use draft shield.
 Adjust in-use cover.
 Move balance or alter filter.
 Alter filter.
 Make sample stationary.

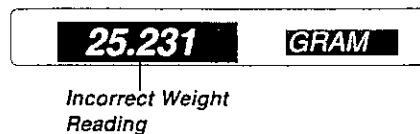

Balance operating error.
 Incorrect weigh unit.
 Pan obstructed.

Re-calibrate balance.
 Check level.
 Check weigh unit setting.
 Check pan placement.
 Check in-use cover.



See Calibration Section

Appendix D- Glossary Of Terms

Automatic Calibration: Automatic self-calibration of the balance.

Auto-Zero: Automatically correcting the zero display due to slow drift.

Baud Rate: The transfer rate unit for serial data transmission in bits/seconds between the computer and the printer.

Bit: Unit used for the information content of a communication.

Calibrate: Adapts the balance to a reference weight.

Capacity: The maximum mass that a balance is capable of weighing (the top end of the range scale). See Balance Specifications for capacity.

Coarse Range: Normal weighing range with ten times less resolution than the fine range. (See Dual Range.)

Counting Pieces: A weighing application for determining the piece count of identical weighing samples.

Default: Pre-set parameters automatically in use when the balance is turned on.

Dual Range Balance: Balance with an auxiliary fine range that has a ten times greater accuracy than the coarse range.

Electronic Balance: Using one of several methods, an electronic balance senses a physical force when weight is placed on it and translates this force into digital form.

Factory Setting: Settings pre-selected in the menu by the manufacturer for normal applications and conditions. These can be changed by the user, but they also can be re-set using the default Set Up Procedure.

Fine Range: Weighing range with ten times greater accuracy than the coarse range.

Interface: Connector with standardized data transfer between the balance and another component of the system (printer, computer).



Leveling: Horizontal aligning of the balance during installation.

Linearity: The amount a weight reading may deviate from a straight line between 0 grams and the maximum capacity of the balance. Within the capacity of the balance, weight readings will deviate a very small amount.

Menu: A series of settings from which the user can choose in order to adapt his balance to his particular weighing situation.

Parity: Checking information in the data transmission.

Percent Weighing: Weighing application that uses a pre-set reference value to equal 100% with the Numeric Display showing the deviation of the sample weight in percent.

Readability: The smallest fraction of a weight that a balance is able to discern.

Example: If weight were added to a balance in increments of .00001 grams, the resolution would be defined as the amount added before the balance reading would change.

Re-zero: Returns balance to zero setting using the Tare Key.

Set Up: The process of configuring the balance to operate in a certain way.

Tare Weight: Weight of a container or package that should **not** be taken into account in the weighing.

Taring: Compensating for a Tare Weight by setting the display of the balance at zero with the container or other packaging material on the weighing pan. Often called re-zeroing.

Unstable Indicator: Symbol that is automatically displayed when the balance reading or weight is **not** stable. It disappears when the reading becomes stable.

Weighing Mode: The weighing unit(s) that can be selected; during a weighing operation, the weighing mode being used is displayed on the Message Display.

Appendix E - Initialization* and/or Linearity Correction

WARNING: The following procedure should only be performed by a qualified technician. Improper adjustment will affect the accuracy of readings.

Equipment: Use two test weights of similar value. Recommended weight is either 1/3 or 1/2 of the balance capacity. However, the exact value of either weight need not be known to do this procedure.

PROCEDURE

1. Press the **Set Up** key.
2. Press the **Auto Cal** key.
3. Press the **Select** key.

To initialize the balance, proceed to the next step.
To perform the linearity correction, skip to Step #6.

4. Press the **On Off** key.
5. Press the **Tare** key and return to normal operation.
6. Press the **Select** key again.

MESSAGE DISPLAY SHOWS

SET UP

INITIALZ

INIT

INIT -xx-

TARING

LIN

7. Press the **On Off** key.
8. When the Numeric Display is stable, again press the **On Off** key.
9. Place the first test weight on the weighing pan.
10. When the Numeric Display is stable, again press the **On Off** key.
11. Remove the first test weight and place the second test weight on the weighing pan.
12. When the Numeric Display is stable, again press the **On Off** key.
13. Place both test weights on the weighing pan.
14. When the Numeric Display is stable, again press the **On Off** key and the Message Display shows the Linearity Correction.
15. Remove weights and press the **Tare** key to return to normal operations.

LIN 1

LIN 2

LIN 3

LIN 4

L number

* Initialization re-sets to the default parameters and erases all user data.

Appendix F- Warranty Information

Denver Instrument Co. warrants electronic analytical balances against defects in material and workmanship for a period of **one** year from the date of original purchase, PROVIDED THE BALANCE IS MAINTAINED AND USED IN ACCORDANCE WITH THE OPERATING INSTRUCTIONS SUPPLIED WITH THE UNIT. Specifically, the warranty DOES **NOT** EXTEND TO balances subjected to misuse, abuse, unauthorized repairs, removal of cover or shipping damages. The warranty is voided if any of the following occur:

- ❑ Mechanical abuse (dropping balance, dropping weighted object on pan, etc.)
- ❑ Applications abuse (chemical spillage leaking into unit, chemical dusts accumulated internally, etc.)
- ❑ Evidence the unit has been tampered with, modified, or cover removed (substituted parts, poor soldering, missing screws, scratched or damaged parts, etc.)
- ❑ Failure to follow Packing/Shipping Instructions, particularly failure to remove pan prior to shipping.

A-Series Limited Warranty

A properly completed and returned Warranty Card can expedite any service needed.

THE WARRANTY STATED HEREIN IS IN LIEU OF ALL OTHER EXPRESSED OR IMPLIED WARRANTIES; FURTHERMORE, UNDER NO CIRCUMSTANCES WILL DENVER INSTRUMENT COMPANY BE LIABLE OR OBLIGATED FOR ANY CONSEQUENTIAL, INCIDENTAL, OR SPECIAL DAMAGES.

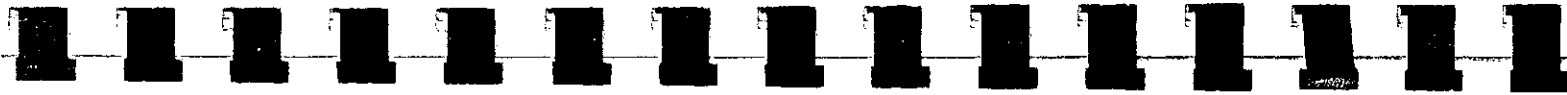

The most unique and comprehensive warranty and program available today for electronic balances!! Instituted in 1982, our "Guaranteed Weigh" means just that . . . we guarantee that your FISHER SERIES-A Balance covered under this program consistently will perform its specified weighing function:

A-Series Guarantee

If you happen to have any problem with your **A-Series** Balance:

- ❑ Contact our Customer Service Department directly at **1-800-321-1135**.
- ❑ A Customer Service Representative will guide you through step-by-step trouble shooting procedures in an attempt to promptly correct any problems.
- ❑ If the step-by-step consultation does not solve the problem, you will be given a return authorization code and advised of the procedures for returning the unit.
- ❑ Upon receipt and inspection of the defective unit, we will promptly repair or replace your unit.
- ❑ Balances which have **not** been maintained in accordance with the operating instructions, have been misused or abused, will be repaired and returned. Charges may apply.

In the event of an electronic or mechanical malfunction, please call 1-800-321-1135. You will receive instructions on how to expedite warranty service on this balance. Do not return the balance without prior authorization.

REMOVE PAN FROM BALANCE PRIOR TO SHIPMENT

Internal damage may result if pan is left on balance.

FOR FURTHER INFORMATION, CONTACT CUSTOMER SERVICE DEPT. AT 1-800-321-1135.

Please Return Enclosed Warranty Registration Card Within Ten (10) Days.