



**Advanced Test Equipment Rentals**  
**www.atecorp.com 800-404-ATEC (2832)**

**RSA3408B**  
**8 GHz Real-Time Spectrum Analyzer**  
**User Manual**



  
071-2364-02

**Tektronix**



# User Manual



## **RSA3408B** **8 GHz Real-Time Spectrum Analyzer** **071-2364-02**

This document applies to firmware version 4.10  
and above.

[www.tektronix.com](http://www.tektronix.com)

Copyright © Tektronix. All rights reserved. Licensed software products are owned by Tektronix or its subsidiaries or suppliers, and are protected by national copyright laws and international treaty provisions.

Tektronix products are covered by U.S. and foreign patents, issued and pending. Information in this publication supercedes that in all previously published material. Specifications and price change privileges reserved.

TEKTRONIX and TEK are registered trademarks of Tektronix, Inc.

## **Contacting Tektronix**

Tektronix, Inc.  
14200 SW Karl Braun Drive  
P.O. Box 500  
Beaverton, OR 97077  
USA

For product information, sales, service, and technical support:

- In North America, call 1-800-833-9200.
- Worldwide, visit [www.tektronix.com](http://www.tektronix.com) to find contacts in your area.

## **End User License Agreement for Microsoft Software**

You have acquired a device (“DEVICE”) that includes software licensed by Tektronix Japan, Ltd. (“TJ”) from Microsoft Licensing Inc. or its affiliates (“MS”). Those installed software products of MS origin, as well as associated media, printed materials, and “online” or electronic documentation (“SOFTWARE”) are protected by international intellectual property laws and treaties. The SOFTWARE is licensed, not sold. All rights reserved.

**IF YOU DO NOT AGREE TO THIS END USER LICENSE AGREEMENT (“EULA”), DO NOT USE THE DEVICE OR COPY THE SOFTWARE. INSTEAD, PROMPTLY CONTACT TJ FOR INSTRUCTIONS ON RETURN OF THE UNUSED DEVICE(S) FOR A REFUND. ANY USE OF THE SOFTWARE, INCLUDING BUT NOT LIMITED TO USE ON THE DEVICE, WILL CONSTITUTE YOUR AGREEMENT TO THIS EULA (OR RATIFICATION OF ANY PREVIOUS CONSENT).**

**GRANT OF SOFTWARE LICENSE.** This EULA grants you the following license:

You may use the SOFTWARE only on the DEVICE.

### **NOT FAULT TOLERANT.**

THE SOFTWARE IS NOT FAULT TOLERANT. TJ HAS INDEPENDENTLY DETERMINED HOW TO USE THE SOFTWARE IN THE DEVICE, AND MS HAS RELIED UPON TJ TO CONDUCT SUFFICIENT TESTING TO DETERMINE THAT THE SOFTWARE IS SUITABLE FOR SUCH USE.

### **NO WARRANTIES FOR THE SOFTWARE.**

**THE SOFTWARE IS PROVIDED “AS IS” AND WITH ALL FAULTS. THE ENTIRE RISK AS TO SATISFACTORY QUALITY, PERFORMANCE, ACCURACY, AND EFFORT (INCLUDING LACK OF NEGLIGENCE) IS WITH YOU. ALSO, THERE IS NO WARRANTY AGAINST INTERFERENCE WITH YOUR ENJOYMENT OF THE SOFTWARE OR AGAINST INFRINGEMENT. IF YOU HAVE RECEIVED ANY WARRANTIES REGARDING THE DEVICE OR THE SOFTWARE, THOSE WARRANTIES DO NOT ORIGINATE FROM, AND ARE NOT BINDING ON, MS.**

### **NOTE ON JAVA SUPPORT.**

The SOFTWARE may contain support for programs written in Java. Java technology is not fault tolerant and is not designed, manufactured, or intended for use or resale as online control equipment in hazardous environments requiring fail-safe performance, such as in the operation of nuclear facilities, aircraft navigation or communication systems, air traffic control, direct life support machines, or weapons systems, in which the failure of Java technology could lead directly to death, personal injury, or severe physical or environmental damage. Sun Microsystems, Inc. has contractually obligated MS to make this disclaimer.

### **NO LIABILITY FOR CERTAIN DAMAGES.**

**EXCEPT AS PROHIBITED BY LAW, MS SHALL HAVE NO LIABILITY FOR ANY INDIRECT, SPECIAL, CONSEQUENTIAL OR INCIDENTAL DAMAGES ARISING FROM OR IN CONNECTION WITH THE USE OR PERFORMANCE OF THE SOFTWARE. THIS LIMITATION SHALL APPLY EVEN IF ANY REMEDY FAILS OF ITS ESSENTIAL PURPOSE. IN NO EVENT SHALL MS BE LIABLE FOR ANY AMOUNT IN EXCESS OF U.S. TWO HUNDRED FIFTY DOLLARS (U.S.\$250.00).**

**LIMITATIONS ON REVERSE ENGINEERING, DECOMPILATION, AND DISASSEMBLY.**

You may not reverse engineer, decompile, or disassemble the SOFTWARE, except and only to the extent that such activity is expressly permitted by applicable law notwithstanding this limitation.

**SOFTWARE TRANSFER ALLOWED BUT WITH RESTRICTIONS.**

You may permanently transfer rights under this EULA only as part of a permanent sale or transfer of the Device, and only if the recipient agrees to this EULA. If the SOFTWARE is an upgrade, any transfer must also include all prior versions of the SOFTWARE.

**EXPORT RESTRICTIONS.**

You acknowledge that SOFTWARE is of US-origin. You agree to comply with all applicable international and national laws that apply to the SOFTWARE, including the U.S. Export Administration Regulations, as well as end-user, end-use and country destination restrictions issued by U.S. and other governments. For additional information on exporting the SOFTWARE, see <http://www.microsoft.com/exporting/>.

**LIMITATION ON SOFTWARE PROGRAMS USED ON THE DEVICE.**

The combination of software programs you use on the DEVICE shall address not more than two (2) general office automation or consumer computing functions. Such functions include, but are not limited to: email, word processing, spreadsheets, database, network browsing, scheduling, and personal finance.

**STORAGE/NETWORK USE.**

The SOFTWARE may not be installed, accessed, displayed, run, shared or used concurrently on or from different computers, including a workstation, terminal or other digital electronic device ("Computing System"). Notwithstanding the foregoing and except as otherwise provided below, any number of Computing Systems, may access or otherwise utilize the file and print services and internet information services of the SOFTWARE, if included.

You may use the SOFTWARE on a single DEVICE as interactive workstation software, but not as server software. However, you may permit a maximum of ten (10) Computing Systems to connect to the DEVICE to access and use services of the SOFTWARE, such as file and print services and internet information services. The ten-connection maximum includes any indirect connections made through other software or hardware which pools or aggregates connections.

## **Warranty 2**

Tektronix warrants that this product will be free from defects in materials and workmanship for a period of one (1) year from the date of shipment. If any such product proves defective during this warranty period, Tektronix, at its option, either will repair the defective product without charge for parts and labor, or will provide a replacement in exchange for the defective product. Parts, modules and replacement products used by Tektronix for warranty work may be new or reconditioned to like new performance. All replaced parts, modules and products become the property of Tektronix.

In order to obtain service under this warranty, Customer must notify Tektronix of the defect before the expiration of the warranty period and make suitable arrangements for the performance of service. Customer shall be responsible for packaging and shipping the defective product to the service center designated by Tektronix, with shipping charges prepaid. Tektronix shall pay for the return of the product to Customer if the shipment is to a location within the country in which the Tektronix service center is located. Customer shall be responsible for paying all shipping charges, duties, taxes, and any other charges for products returned to any other locations.

This warranty shall not apply to any defect, failure or damage caused by improper use or improper or inadequate maintenance and care. Tektronix shall not be obligated to furnish service under this warranty a) to repair damage resulting from attempts by personnel other than Tektronix representatives to install, repair or service the product; b) to repair damage resulting from improper use or connection to incompatible equipment; c) to repair any damage or malfunction caused by the use of non-Tektronix supplies; or d) to service a product that has been modified or integrated with other products when the effect of such modification or integration increases the time or difficulty of servicing the product.

**THIS WARRANTY IS GIVEN BY TEKTRONIX WITH RESPECT TO THE PRODUCT IN LIEU OF ANY OTHER WARRANTIES, EXPRESS OR IMPLIED. TEKTRONIX AND ITS VENDORS DISCLAIM ANY IMPLIED WARRANTIES OF MERCHANTABILITY OR FITNESS FOR A PARTICULAR PURPOSE. TEKTRONIX' RESPONSIBILITY TO REPAIR OR REPLACE DEFECTIVE PRODUCTS IS THE SOLE AND EXCLUSIVE REMEDY PROVIDED TO THE CUSTOMER FOR BREACH OF THIS WARRANTY. TEKTRONIX AND ITS VENDORS WILL NOT BE LIABLE FOR ANY INDIRECT, SPECIAL, INCIDENTAL, OR CONSEQUENTIAL DAMAGES IRRESPECTIVE OF WHETHER TEKTRONIX OR THE VENDOR HAS ADVANCE NOTICE OF THE POSSIBILITY OF SUCH DAMAGES.**





# Table of Contents

<b>General Safety Summary</b> .....	<b>xv</b>
<b>Compliance Information</b> .....	<b>xvii</b>
EMC Compliance .....	xvii
Safety Compliance .....	xviii
Environmental Considerations .....	xx
<b>Preface</b> .....	<b>xxi</b>
About This Manual .....	xxi
Related Documents .....	xxii
Conventions .....	xxiii

## Getting Started

<b>Product Overview</b> .....	<b>1-1</b>
Features .....	1-1
Application .....	1-2
Real-Time Analysis .....	1-3
Architecture .....	1-7
<b>Installation</b> .....	<b>1-11</b>
Unpacking to Check Contents .....	1-11
Applying Power .....	1-12
Setting Up the Stand .....	1-15
Functional Check .....	1-16
Powering Off the Analyzer .....	1-20
Restarting the Analyzer .....	1-21
Backing Up User Files .....	1-22
Installing Other Applications .....	1-22
<b>Calibration</b> .....	<b>1-23</b>
Cal Menu .....	1-24
Calibrating Gain .....	1-25
Calibrating Center Offset .....	1-26
Calibrating DC Offset .....	1-27
Calibrating IF Flatness .....	1-27
Adjusting Display Brightness .....	1-28
Confirming Performance .....	1-28

## Operating Basics

<b>Interface Maps</b> .....	<b>2-1</b>
Controls and Connectors .....	2-2
Display Screen .....	2-9
<b>Functional Overview</b> .....	<b>2-15</b>
Menu Keys .....	2-15
Menu Operations .....	2-18
Measurement Basics .....	2-22
Setting System Parameters .....	2-25
Using Windows XP .....	2-27

<b>Tutorial</b> .....	<b>2-29</b>
Preparations .....	2-30
Displaying Spectrum .....	2-33
Using Markers and Peak Search .....	2-40
Using Averaging and Comparison Displays .....	2-43
Displaying DPX Spectrum .....	2-46
Displaying a Spectrogram .....	2-48
Spectrum Analysis .....	2-51
Modulation Analysis .....	2-53
Turning Off the Power .....	2-60

## Reference

<b>Spectrum Analysis (S/A Mode)</b> .....	<b>3-1</b>
Measurement Screen Layout .....	3-2
Spectrum Analysis .....	3-4
DPX Spectrum Display .....	3-18
Spectrogram Display .....	3-21
Real-Time Analysis .....	3-23
Zoom Function .....	3-27
<b>Modulation Analysis (Demod Mode)</b> .....	<b>3-31</b>
Measurement Screen Layout .....	3-33
Analog Modulation Analysis .....	3-41
Digital Modulation Analysis (Option 21 Only) .....	3-48
Audio Measurements (Option 10 Only) .....	3-67
RFID Analysis (Option 21 Only) .....	3-77
<b>Time Analysis (Time Mode)</b> .....	<b>3-99</b>
Measurement Screen Layout .....	3-99
Time Variation Measurement .....	3-100
CCDF Measurement .....	3-104
Pulse Measurements .....	3-109
Signal Source Analysis (Option 21 Only) .....	3-119
<b>Setting Frequency and Span</b> .....	<b>3-135</b>
Frequency and Span Setting Menu .....	3-136
Using the Channel Table .....	3-138
Using the Marker and Peak Search .....	3-139
Frequency Setting Range .....	3-140
Vector Span .....	3-142
<b>Setting Amplitude</b> .....	<b>3-143</b>
Amplitude Menu .....	3-143
Over-Voltage Input .....	3-147
Amplitude Correction .....	3-148
<b>Setting Acquisition and Analysis Parameters</b> .....	<b>3-157</b>
Acquisition/Analysis Menu .....	3-157
Seamless Acquisition .....	3-161
<b>Trigger</b> .....	<b>3-163</b>
Trigger Menu .....	3-164
Creating a Trigger Mask (Option 02 Only) .....	3-171
Trigger Point Indicator .....	3-177
Synchronous Operation with External Instruments .....	3-178

<b>FFT and RBW</b> .....	<b>3-179</b>
RBW/FFT Menu .....	3-180
FFT Points .....	3-184
FFT Window .....	3-185
<b>Trace Comparison Display and Average Function</b> .....	<b>3-191</b>
Trace/Avg Menu .....	3-192
Displaying Trace 1 and 2 .....	3-196
Averaging the Waveform .....	3-197
Saving/Loading Waveform Data .....	3-200
Trace Compression .....	3-200
<b>Setting Views</b> .....	<b>3-203</b>
View Menu .....	3-204
Basic Procedure .....	3-205
Spectrum View Setting .....	3-206
DPX Spectrum View Setting .....	3-207
Spectrogram View Setting .....	3-208
Time Domain View Setting .....	3-210
CCDF View Setting .....	3-212
Constellation View Setting (Option 21 Only) .....	3-213
EVM View Setting (Option 21 Only) .....	3-215
Symbol Table Setting (Option 21 Only) .....	3-218
Eye Diagram Setting (Option 21 Only) .....	3-219
AM/AM View Setting (Option 21 Only) .....	3-221
AM/PM View Setting (Option 21 Only) .....	3-222
PDF View Setting (Option 21 Only) .....	3-223
Noisogram View Setting (Option 21 Only) .....	3-224
<b>Display Line</b> .....	<b>3-227</b>
Display Line Operation (Other than Real Time S/A) .....	3-228
Multi Display Lines (Real Time S/A Only) .....	3-231
<b>Marker Operation and Peak Search</b> .....	<b>3-235</b>
Markers Menu .....	3-236
Using Markers .....	3-238
Peak Search .....	3-243
<b>Using the Online Help</b> .....	<b>3-245</b>
Displaying the Online Help .....	3-245
Using a Mouse and Keyboard .....	3-248
<b>Selecting Input Source</b> .....	<b>3-249</b>
Input Menu .....	3-249
<b>File Operations</b> .....	<b>3-251</b>
File Type .....	3-251
Load/Save Menu .....	3-252
Saving and Loading Files .....	3-254
Entering a File Name .....	3-262
Deleting a File .....	3-264
Making/Deleting a Directory .....	3-264

<b>File Format</b> .....	<b>3-265</b>
Data File Format .....	3-266
Trace File Format .....	3-274
Bitmap Trace File Format .....	3-276
CSV File Format .....	3-278
MAT File Format .....	3-278
Limit Mask File Format .....	3-279
User Filter File Format .....	3-280
<b>Screen Copy</b> .....	<b>3-283</b>
Print Menu .....	3-283
Printing a Screen Copy .....	3-284
Creating a File .....	3-285

## Appendices

<b>Appendix A: Menu Tree</b> .....	<b>A-1</b>
<b>Appendix B: Digital Demodulation Symbol Mapping</b> .....	<b>B-1</b>
<b>Appendix C: Digital IQ Output Connector Pin Assignment</b> <b>(Option 05)</b> .....	<b>C-1</b>
<b>Appendix D: Using the Removable Hard Disk Drive</b> <b>(Option 06)</b> .....	<b>D-1</b>
Replacing the Hard Drive .....	D-1
Using the USB Flash Drive .....	D-1
<b>Appendix E: Restoring the Instrument Operating System</b> .....	<b>E-1</b>
Restoring the Operating System from the Instrument Hard Disk .....	E-1
<b>Appendix F: Inspection and Cleaning</b> .....	<b>F-1</b>
Inspecting the Exterior .....	F-1
Cleaning the Exterior .....	F-2
Lubrication .....	F-2
Cleaning the Interior .....	F-2
<b>Appendix G: Options and Accessories</b> .....	<b>G-1</b>
Options .....	G-1
Standard Accessories .....	G-3
Optional Accessories .....	G-3

## Glossary

## Index

# List of Figures

Figure 1-1: Concept of the swept spectrum analyzer .....	1-3
Figure 1-2: Sweep of resolution filter .....	1-3
Figure 1-3: Concept of the real-time spectrum analyzer .....	1-4
Figure 1-4: Concurrent acquisition .....	1-4
Figure 1-5: Frame acquisition .....	1-5
Figure 1-6: DPX processing .....	1-5
Figure 1-7: DPX spectrum display .....	1-6
Figure 1-8: Block diagram .....	1-7
Figure 1-9: AC Input (rear panel) .....	1-12
Figure 1-10: Principal power switch (rear panel) .....	1-13
Figure 1-11: Front panel power switch (On/Standby switch) .....	1-13
Figure 1-12: Initial screen .....	1-14
Figure 1-13: RF INPUT connector .....	1-14
Figure 1-14: Setting up the stand .....	1-15
Figure 1-15: Spectrum of the calibration signal (100 MHz, about -20 dBm) .....	1-16
Figure 1-16: Setup display .....	1-17
Figure 1-17: Reference level setting and overrange indicator .....	1-18
Figure 1-18: Spectrogram display .....	1-19
Figure 1-19: Calibration menu structure .....	1-24
Figure 1-20: UNCAL display .....	1-25
Figure 1-21: Center offset .....	1-26
Figure 1-22: DC offset .....	1-27
Figure 1-23: System menu .....	1-28
Figure 2-1: Front panel .....	2-2
Figure 2-2: Rear panel .....	2-4
Figure 2-3: Side panel .....	2-6
Figure 2-4: Connecting USB devices .....	2-7
Figure 2-5: Operation with mouse and keyboard .....	2-8
Figure 2-6: Display screen configuration .....	2-9
Figure 2-7: Status display .....	2-11
Figure 2-8: Pre- and post-trigger regions .....	2-11
Figure 2-9: Key lock display .....	2-12
Figure 2-10: Setup display .....	2-13

Figure 2-11: Menu keys .....	2-16
Figure 2-12: Example menu item display .....	2-18
Figure 2-13: Menu item types .....	2-19
Figure 2-14: Numeric setting menu .....	2-19
Figure 2-15: Changing value with the knob .....	2-20
Figure 2-16: Changing value with the keypad .....	2-21
Figure 2-17: Numeric keypad .....	2-21
Figure 2-18: Step size for the center frequency .....	2-22
Figure 2-19: Changing the step size to the predetermined values ..	2-22
Figure 2-20: Selecting the measurement mode .....	2-23
Figure 2-21: Starting/Stopping data acquisition .....	2-24
Figure 2-22: Restoring default settings .....	2-24
Figure 2-23: System menu .....	2-25
Figure 2-24: Displaying versions and options .....	2-26
Figure 2-25: Displaying the Windows XP accessory menu .....	2-28
Figure 2-26: Cable connection .....	2-30
Figure 2-27: Principal power switch (rear panel) .....	2-31
Figure 2-28: Power switch (On/Standby) .....	2-31
Figure 2-29: Initial screen .....	2-32
Figure 2-30: Frequency, span, and amplitude settings .....	2-33
Figure 2-31: Menu items for numeric value input .....	2-34
Figure 2-32: Numeric value entry keypad .....	2-34
Figure 2-33: Center frequency of 100 MHz, span of 36 MHz .....	2-35
Figure 2-34: Center frequency of 100 MHz, span of 20 kHz .....	2-36
Figure 2-35: Setting amplitude .....	2-37
Figure 2-36: Reference level of 10 dBm .....	2-38
Figure 2-37: Status indicator .....	2-39
Figure 2-38: Measurement with a single marker .....	2-40
Figure 2-39: Measurement with the delta marker .....	2-41
Figure 2-40: Searching for the peak .....	2-43
Figure 2-41: Averaging a waveform .....	2-44
Figure 2-42: Comparison display with averaged waveform .....	2-45
Figure 2-43: DPX spectrum display .....	2-46
Figure 2-44: Persistence display .....	2-47
Figure 2-45: Concurrent display of spectrum and spectrogram ...	2-48
Figure 2-46: Tall display of spectrum and spectrogram .....	2-49
Figure 2-47: Spectrogram view .....	2-50
Figure 2-48: Channel power measurement .....	2-51

<b>Figure 2-49: Channel power measurement (Channel Bandwidth = 40 kHz)</b> .....	2-52
<b>Figure 2-50: Carrier frequency measurement</b> .....	2-52
<b>Figure 2-51: AM signal measurement</b> .....	2-54
<b>Figure 2-52: Analysis range settings</b> .....	2-55
<b>Figure 2-53: Frame and block</b> .....	2-56
<b>Figure 2-54: Changing the acquisition length</b> .....	2-57
<b>Figure 2-55: Single view display</b> .....	2-58
<b>Figure 2-56: Scale settings</b> .....	2-59
<b>Figure 3-1: S/A menu structure</b> .....	3-1
<b>Figure 3-2: S/A measurement screen</b> .....	3-2
<b>Figure 3-3: “Flex” grid style</b> .....	3-3
<b>Figure 3-4: Channel power measurement</b> .....	3-5
<b>Figure 3-5: ACPR measurement band power markers</b> .....	3-6
<b>Figure 3-6: Example of ACPR measurement</b> .....	3-7
<b>Figure 3-7: C/N measurement band power markers</b> .....	3-8
<b>Figure 3-8: Example of C/N measurement</b> .....	3-8
<b>Figure 3-9: OBW measurement band power marker</b> .....	3-9
<b>Figure 3-10: OBW measurement</b> .....	3-9
<b>Figure 3-11: Carrier frequency measurement</b> .....	3-10
<b>Figure 3-12: EBW measurement band power markers</b> .....	3-11
<b>Figure 3-13: EBW measurement</b> .....	3-11
<b>Figure 3-14: Setting up spurious signal measurement</b> .....	3-12
<b>Figure 3-15: Example of spurious signal measurement</b> .....	3-13
<b>Figure 3-16: Spectrum emission mask measurement</b> .....	3-15
<b>Figure 3-17: Measurement limits editor</b> .....	3-16
<b>Figure 3-18: DPX process flow</b> .....	3-18
<b>Figure 3-19: DPX spectrum display</b> .....	3-19
<b>Figure 3-20: Persistence display</b> .....	3-20
<b>Figure 3-21: Spectrum and spectrogram concurrent display</b> .....	3-21
<b>Figure 3-22: View orientation</b> .....	3-22
<b>Figure 3-23: Single display</b> .....	3-22
<b>Figure 3-24: Difference between normal and real-time modes</b> .....	3-23
<b>Figure 3-25: Real-time mode</b> .....	3-26
<b>Figure 3-26: Spectrogram display in averaging</b> .....	3-26
<b>Figure 3-27: Zoom function</b> .....	3-27
<b>Figure 3-28: Zoom domain settings using the acquisition and analysis menu</b> .....	3-28

Figure 3-29: Zoomed area settings using the marker .....	3-29
Figure 3-30: Demod menu structure .....	3-31
Figure 3-31: Demod mode screen .....	3-33
Figure 3-32: Analysis range setting in the overview .....	3-34
Figure 3-33: Marker keys .....	3-35
Figure 3-34: Specifying the range with the marker and the reference cursor .....	3-36
Figure 3-35: Specifying the analysis range using the mouse .....	3-37
Figure 3-36: FFT processing range setting on the overview .....	3-38
Figure 3-37: Changing the overview and subview .....	3-39
Figure 3-38: One-view display .....	3-40
Figure 3-39: AM demod measurement .....	3-43
Figure 3-40: FM demod measurement .....	3-44
Figure 3-41: PM demod measurement (main view) .....	3-46
Figure 3-42: IQ versus time measurement (main view) .....	3-46
Figure 3-43: Pulse spectrum measurement .....	3-47
Figure 3-44: Process flow for digitally modulated signals .....	3-54
Figure 3-45: Constellation analysis .....	3-56
Figure 3-46: EVM measurement .....	3-57
Figure 3-47: IQ/Frequency versus time measurement .....	3-58
Figure 3-48: Power variance measurement .....	3-59
Figure 3-49: Symbol table analysis .....	3-60
Figure 3-50: Eye diagram analysis (main view) .....	3-60
Figure 3-51: Setting Linear Signal Region .....	3-61
Figure 3-52: AM/AM measurement .....	3-62
Figure 3-53: AM/PM measurement .....	3-63
Figure 3-54: CCDF measurement .....	3-64
Figure 3-55: PDF measurement .....	3-65
Figure 3-56: FSK deviations measurement (4FSK) .....	3-66
Figure 3-57: Spectrogram display in the average or high resolution mode .....	3-68
Figure 3-58: Signal/Noise and Distortion measurement .....	3-71
Figure 3-59: Harmonics measurement results (bottom of the screen)	3-73
Figure 3-60: Harmonic level calculation .....	3-74
Figure 3-61: Interval limit between harmonics .....	3-74
Figure 3-62: Hum and Noise Ratio measurement result (bottom of the screen) .....	3-75
Figure 3-63: RFID waveform and measurement items .....	3-78
Figure 3-64: Carrier measurement .....	3-81



Figure 3-65: Spurious measurement .....	3-82
Figure 3-66: ACPR measurements .....	3-84
Figure 3-67: Modified Miller code .....	3-87
Figure 3-68: Transmission power on/down measurement parameters .....	3-88
Figure 3-69: Power on/down measurements .....	3-91
Figure 3-70: RF envelope / FSK pulse measurement (main view) ..	3-93
Figure 3-71: RF envelope / FSK pulse measurement parameters ..	3-94
Figure 3-72: Constellation, eye diagram, and symbol table (main view) .....	3-96
Figure 3-73: Definition of the modulation depth and index .....	3-98
Figure 3-74: Time menu structure .....	3-99
Figure 3-75: IQ versus Time measurement .....	3-101
Figure 3-76: Power variance measurement .....	3-102
Figure 3-77: Frequency measurement .....	3-103
Figure 3-78: CCDF calculation process .....	3-104
Figure 3-79: CCDF single view .....	3-107
Figure 3-80: CCDF multi-view .....	3-108
Figure 3-81: Definition of pulse characteristics .....	3-110
Figure 3-82: Definition of pulse-on/off .....	3-110
Figure 3-83: Setting for View Results For... .....	3-114
Figure 3-84: Setting the View Define menu .....	3-115
Figure 3-85: Waveform display in the subview .....	3-118
Figure 3-86: Phase noise measurement parameters .....	3-122
Figure 3-87: Phase noise measurement .....	3-123
Figure 3-88: Spurious measurement .....	3-126
Figure 3-89: Real-time phase noise measurement parameters .....	3-128
Figure 3-90: Real-time phase noise measurement .....	3-129
Figure 3-91: Settling time displayed in the subview .....	3-130
Figure 3-92: Real-time spurious measurement .....	3-132
Figure 3-93: Frequency versus Time measurement parameters .....	3-133
Figure 3-94: Frequency versus Time measurement .....	3-134
Figure 3-95: Frequency and Span menu structure .....	3-136
Figure 3-96: Setting frequency and span .....	3-137
Figure 3-97: Setting the center frequency using Marker ⇒ .....	3-139
Figure 3-98: Relationship between the frequency and span settings	3-141
Figure 3-99: Vector mode and scalar mode .....	3-142
Figure 3-100: Amplitude menu structure .....	3-143
Figure 3-101: Setting the amplitude .....	3-144

Figure 3-102: Overrange indicator .....	3-147
Figure 3-103: The amplitude correction concept .....	3-148
Figure 3-104: Amplitude correction example .....	3-150
Figure 3-105: Amplitude correction data input .....	3-153
Figure 3-106: Amplitude offset .....	3-155
Figure 3-107: Frequency offset .....	3-155
Figure 3-108: Amplitude correction setup display .....	3-156
Figure 3-109: Acquisition/Analysis menu structure .....	3-157
Figure 3-110: Acquisition and analysis parameters .....	3-159
Figure 3-111: Parameters in the zoom mode .....	3-160
Figure 3-112: Frame cycle .....	3-161
Figure 3-113: Seamless acquisition .....	3-161
Figure 3-114: Trigger menu structure .....	3-164
Figure 3-115: Trigger position .....	3-166
Figure 3-116: Power trigger detection range .....	3-167
Figure 3-117: Trigger level and slope .....	3-168
Figure 3-118: Acquiring and displaying data by Trigger and Repeat modes .....	3-169
Figure 3-119: Trigger mask .....	3-171
Figure 3-120: Filling operation for creating a mask .....	3-172
Figure 3-121: Example mask .....	3-173
Figure 3-122: Default mask .....	3-174
Figure 3-123: Changing the position of Point A .....	3-174
Figure 3-124: Changing the position of Point B .....	3-175
Figure 3-125: Adding Point C .....	3-175
Figure 3-126: Trigger point display .....	3-177
Figure 3-127: Synchronous operation of two RSA3408B analyzers .....	3-178
Figure 3-128: FFT and RBW process .....	3-179
Figure 3-129: RBW/FFT menu structure .....	3-180
Figure 3-130: Process flow when RBW/FFT = FFT .....	3-182
Figure 3-131: FFT overlap .....	3-183
Figure 3-132: Generating spurious signals by increasing the number of FFT points .....	3-184
Figure 3-133: Windowing process of time domain data .....	3-186
Figure 3-134: Comparison display of Trace 1 and 2 .....	3-191
Figure 3-135: Trace/Avg menu structure .....	3-192
Figure 3-136: Displaying an averaged waveform .....	3-198
Figure 3-137: Compared display .....	3-199
Figure 3-138: Relationships between frame, bin, and pixel .....	3-201

<b>Figure 3-139: Compression method for displaying the waveform ..</b>	<b>3-202</b>
<b>Figure 3-140: Setting the scale in spectrum view .....</b>	<b>3-206</b>
<b>Figure 3-141: Setting the scale in spectrum view .....</b>	<b>3-208</b>
<b>Figure 3-142: Scale and format settings in spectrogram view .....</b>	<b>3-209</b>
<b>Figure 3-143: Setting the scale in time domain view .....</b>	<b>3-211</b>
<b>Figure 3-144: Setting the scale in CCDF view .....</b>	<b>3-212</b>
<b>Figure 3-145: Vector and constellation displays .....</b>	<b>3-213</b>
<b>Figure 3-146: Phase multiplication display for a CPM signal .....</b>	<b>3-214</b>
<b>Figure 3-147: Setting the scale in EVM view .....</b>	<b>3-215</b>
<b>Figure 3-148: EVM, magnitude and phase error displays .....</b>	<b>3-216</b>
<b>Figure 3-149: Constellation view and error vectors in <math>1/4\pi</math> QPSK ..</b>	<b>3-217</b>
<b>Figure 3-150: D8PSK symbol value .....</b>	<b>3-218</b>
<b>Figure 3-151: Symbol table .....</b>	<b>3-219</b>
<b>Figure 3-152: Eye diagram view .....</b>	<b>3-220</b>
<b>Figure 3-153: Vector and dot displays for AM/AM view .....</b>	<b>3-221</b>
<b>Figure 3-154: Vector and dot displays for AM/PM view .....</b>	<b>3-222</b>
<b>Figure 3-155: Setting the scale in PDF view .....</b>	<b>3-223</b>
<b>Figure 3-156: Setting the scale in noisogram view .....</b>	<b>3-225</b>
<b>Figure 3-157: Display line .....</b>	<b>3-227</b>
<b>Figure 3-158: Lines menu structure (other than Real Time S/A) ...</b>	<b>3-228</b>
<b>Figure 3-159: Two horizontal lines .....</b>	<b>3-229</b>
<b>Figure 3-160: Two horizontal and two vertical lines .....</b>	<b>3-230</b>
<b>Figure 3-161: Multi display lines (Real Time S/A mode) .....</b>	<b>3-231</b>
<b>Figure 3-162: Lines menu structure (Real Time S/A) .....</b>	<b>3-232</b>
<b>Figure 3-163: Marker display .....</b>	<b>3-235</b>
<b>Figure 3-164: Markers menu structure .....</b>	<b>3-236</b>
<b>Figure 3-165: Measurement with a single marker .....</b>	<b>3-238</b>
<b>Figure 3-166: Using the delta marker to take measurements .....</b>	<b>3-239</b>
<b>Figure 3-167: Measurement with the reference cursor .....</b>	<b>3-240</b>
<b>Figure 3-168: Changing the Trace .....</b>	<b>3-241</b>
<b>Figure 3-169: Interlocked markers .....</b>	<b>3-242</b>
<b>Figure 3-170: Marker movement on the Bitmap trace .....</b>	<b>3-242</b>
<b>Figure 3-171: Functions of the peak search keys .....</b>	<b>3-243</b>
<b>Figure 3-172: Setting the minimum frequency jump .....</b>	<b>3-244</b>
<b>Figure 3-173: Online help for the front panel key .....</b>	<b>3-246</b>
<b>Figure 3-174: Online user manual .....</b>	<b>3-247</b>
<b>Figure 3-175: Word search using the keyboard .....</b>	<b>3-248</b>
<b>Figure 3-176: Input menu structure .....</b>	<b>3-249</b>

<b>Figure 3-177: Load/Save menu structure</b> .....	<b>3-252</b>
<b>Figure 3-178: Save to the preset file (lower right of the screen)</b> ....	<b>3-256</b>
<b>Figure 3-179: Selecting the folder</b> .....	<b>3-257</b>
<b>Figure 3-180: Save to File menu</b> .....	<b>3-258</b>
<b>Figure 3-181: Load from the preset file (lower right of the screen)</b> .	<b>3-260</b>
<b>Figure 3-182: Load from File menu</b> .....	<b>3-260</b>
<b>Figure 3-183: Displaying the file name on the Load Data side key</b> .	<b>3-261</b>
<b>Figure 3-184: Alphanumeric keypad</b> .....	<b>3-262</b>
<b>Figure 3-185: Data file structure</b> .....	<b>3-266</b>
<b>Figure 3-186: Adding dummy frames</b> .....	<b>3-268</b>
<b>Figure 3-187: Data block</b> .....	<b>3-270</b>
<b>Figure 3-188: Trace file (.TRC) structure</b> .....	<b>3-274</b>
<b>Figure 3-189: Bitmap trace file (.DPT) structure</b> .....	<b>3-276</b>
<b>Figure 3-190: Data sequence for writing to the Bitmap trace file</b> ..	<b>3-277</b>
<b>Figure 3-191: Limit mask file example</b> .....	<b>3-279</b>
<b>Figure 3-192: User filter file structure</b> .....	<b>3-280</b>
<b>Figure 3-193: Print menu structure</b> .....	<b>3-283</b>
<b>Figure A-1: Menu keys</b> .....	<b>A-1</b>
<b>Figure B-1: Symbol mapping: BPSK, QPSK, 8PSK, 16QAM, 32QAM, and 64QAM</b> .....	<b>B-1</b>
<b>Figure B-2: Symbol mapping: 256QAM, GFSK, 4FSK, 8FSK, and 16FSK</b> .....	<b>B-2</b>
<b>Figure C-1: Digital IQ output connector pin assignment</b> .....	<b>C-1</b>
<b>Figure C-2: Definition of the setup and hold time</b> .....	<b>C-5</b>
<b>Figure D-1: Detaching the removable hard disk drive</b> .....	<b>D-2</b>

# List of Tables

<b>Table 1-1: Span and RBW</b> .....	<b>1-17</b>
<b>Table 2-1: Key functions of the keyboard</b> .....	<b>2-8</b>
<b>Table 2-2: Status display</b> .....	<b>2-11</b>
<b>Table 2-3: Setup display</b> .....	<b>2-13</b>
<b>Table 2-4: Menu key summary</b> .....	<b>2-16</b>
<b>Table 2-5: Measurement modes</b> .....	<b>2-23</b>
<b>Table 3-1: Standard menu in the S/A mode</b> .....	<b>3-1</b>
<b>Table 3-2: Measurement items in the S/A mode</b> .....	<b>3-4</b>
<b>Table 3-3: Limits Setting Menu Items</b> .....	<b>3-17</b>
<b>Table 3-4: Features of the real-time mode</b> .....	<b>3-24</b>
<b>Table 3-5: Span setting range in the real-time mode</b> .....	<b>3-24</b>
<b>Table 3-6: Standard menu in the Demod mode</b> .....	<b>3-32</b>
<b>Table 3-7: Communication standard and preset parameters</b> .....	<b>3-49</b>
<b>Table 3-8: Modulation type and available measurement item</b> .....	<b>3-49</b>
<b>Table 3-9: Audio measurement items</b> .....	<b>3-67</b>
<b>Table 3-10: Audio LPF</b> .....	<b>3-69</b>
<b>Table 3-11: Audio HPF</b> .....	<b>3-69</b>
<b>Table 3-12: Audio de-emphasis filter</b> .....	<b>3-70</b>
<b>Table 3-13: Definition of the Signal/Noise &amp; Distortion measurement items</b> .....	<b>3-72</b>
<b>Table 3-14: Definition of the hum and noise ratio</b> .....	<b>3-76</b>
<b>Table 3-15: Compatible RFID standards</b> .....	<b>3-77</b>
<b>Table 3-16: Measurement items for RFID analysis</b> .....	<b>3-78</b>
<b>Table 3-17: Standard settings</b> .....	<b>3-85</b>
<b>Table 3-18: Details of the RF envelope / FSK pulse measurement table</b> .....	<b>3-93</b>
<b>Table 3-19: Measurement result display items</b> .....	<b>3-97</b>
<b>Table 3-20: Symbol value definition</b> .....	<b>3-98</b>
<b>Table 3-21: Signal source measurement items</b> .....	<b>3-119</b>
<b>Table 3-22: Phase noise measurement frequency band</b> .....	<b>3-124</b>
<b>Table 3-23: Bin width for each decade</b> .....	<b>3-124</b>
<b>Table 3-24: The number of waveform points</b> .....	<b>3-125</b>
<b>Table 3-25: Frequency and span setting range</b> .....	<b>3-140</b>
<b>Table 3-26: Reference level setting range</b> .....	<b>3-144</b>

<b>Table 3-27: Vertical scale setting range</b> .....	<b>3-146</b>
<b>Table 3-28: How to acquire a waveform</b> .....	<b>3-165</b>
<b>Table 3-29: Trigger level setting range</b> .....	<b>3-167</b>
<b>Table 3-30: Characteristics and usage of FFT windows</b> .....	<b>3-185</b>
<b>Table 3-31: FFT window and bandpass filter</b> .....	<b>3-187</b>
<b>Table 3-32: Trace type</b> .....	<b>3-193</b>
<b>Table 3-33: Averaging method</b> .....	<b>3-194</b>
<b>Table 3-34: Number of bins (FFT points: 1024)</b> .....	<b>3-200</b>
<b>Table 3-35: Bitmap color scheme</b> .....	<b>3-207</b>
<b>Table 3-36: Symbol value of CPM</b> .....	<b>3-219</b>
<b>Table 3-37: Front panel keys for online help</b> .....	<b>3-247</b>
<b>Table 3-38: Type of files used in the analyzer</b> .....	<b>3-251</b>
<b>Table 3-39: File save operation</b> .....	<b>3-255</b>
<b>Table 3-40: Preset file names</b> .....	<b>3-256</b>
<b>Table 3-41: File load operation</b> .....	<b>3-259</b>
<b>Table 3-42: Combinations of valid A, P, I and Q</b> .....	<b>3-271</b>
<b>Table 3-43: Limit mask file format</b> .....	<b>3-279</b>
<b>Table B-1: <math>\pi/4</math> shift DQPSK</b> .....	<b>B-3</b>
<b>Table B-2: GMSK</b> .....	<b>B-3</b>
<b>Table C-1: I OUTPUT connector pin assignment</b> .....	<b>C-1</b>
<b>Table C-2: Q OUTPUT connector pin assignment</b> .....	<b>C-3</b>
<b>Table F-1: External inspection checklist</b> .....	<b>F-1</b>
<b>Table G-1: Power cord identification</b> .....	<b>G-2</b>
<b>Table G-2: Standard accessories</b> .....	<b>G-3</b>
<b>Table G-3: Optional accessories</b> .....	<b>G-3</b>
<b>Table G-4: Accessories for optional software</b> .....	<b>G-4</b>

# General Safety Summary

Review the following safety precautions to avoid injury and prevent damage to this product or any products connected to it. To avoid potential hazards, use this product only as specified.

*Only qualified personnel should perform service procedures.*

## **To Avoid Fire or Personal Injury**

**Use Proper Power Cord.** Use only the power cord specified for this product and certified for the country of use.

**Connect and Disconnect Properly.** Do not connect or disconnect probes or test leads while they are connected to a voltage source.

**Ground the Product.** This product is grounded through the grounding conductor of the power cord. To avoid electric shock, the grounding conductor must be connected to earth ground. Before making connections to the input or output terminals of the product, ensure that the product is properly grounded.

**Observe All Terminal Ratings.** To avoid fire or shock hazard, observe all ratings and markings on the product. Consult the product manual for further ratings information before making connections to the product.

**Power Disconnect.** The power switch disconnects the product from the power source. See instructions for the location. Do not block the power switch; it must remain accessible to the user at all times.

**Do Not Operate Without Covers.** Do not operate this product with covers or panels removed.

**Avoid Exposed Circuitry.** Do not touch exposed connections and components when power is present.

**Do Not Operate With Suspected Failures.** If you suspect there is damage to this product, have it inspected by qualified service personnel.

**Do Not Operate in Wet/Damp Conditions.**

**Do Not Operate in an Explosive Atmosphere.**

**Keep Product Surfaces Clean and Dry.**

**Provide Proper Ventilation.** Refer to the manual's installation instructions for details on installing the product so it has proper ventilation.

**Symbols and Terms**

**Terms in this Manual.** These terms may appear in this manual:



---

**WARNING.** *Warning statements identify conditions or practices that could result in injury or loss of life.*

---



---

**CAUTION.** *Caution statements identify conditions or practices that could result in damage to this product or other property.*

---

**Terms on the Product.** These terms may appear on the product:

**DANGER** indicates an injury hazard immediately accessible as you read the marking.

**WARNING** indicates an injury hazard not immediately accessible as you read the marking.

**CAUTION** indicates a hazard to property including the product.

**Symbols on the Product.** The following symbols may appear on the product:



Protective Ground  
(Earth) Terminal



CAUTION  
Refer to Manual



Mains Disconnected  
OFF (Power)



Mains Connected  
ON (Power)



# Compliance Information

This section lists the EMC (electromagnetic compliance), safety, and environmental standards with which the instrument complies.

## EMC Compliance

### EC Declaration of Conformity - EMC

Meets intent of Directive 2004/108/EC for Electromagnetic Compatibility. Compliance was demonstrated to the following specifications as listed in the Official Journal of the European Communities:

**EN 61326-1:2006, EN 61326-2-1:2006.** EMC requirements for electrical equipment for measurement, control, and laboratory use. <sup>1, 2, 3, 4</sup>

- CISPR 11:2003. Radiated and conducted emissions, Group 1, Class A
- IEC 61000-4-2:2001. Electrostatic discharge immunity
- IEC 61000-4-3:2002. RF electromagnetic field immunity <sup>5</sup>
- IEC 61000-4-4:2004. Electrical fast transient/burst immunity
- IEC 61000-4-5:2001. Power line surge immunity
- IEC 61000-4-6:2003. Conducted RF immunity <sup>6</sup>
- IEC 61000-4-11:2004. Voltage dips and interruptions immunity <sup>7</sup>

**EN 61000-3-2:2006.** AC power line harmonic emissions

**EN 61000-3-3:1995.** Voltage changes, fluctuations, and flicker

### European Contact.

Tektronix UK, Ltd.  
Western Peninsula  
Western Road  
Bracknell, RG12 1RF  
United Kingdom

- 1 **This product is intended for use in nonresidential areas only. Use in residential areas may cause electromagnetic interference.**
- 2 **Emissions which exceed the levels required by this standard may occur when this equipment is connected to a test object.**
- 3 **To ensure compliance with the EMC standards listed here, high quality shielded interface cables should be used.**
- 4 **At the IEC 61000-4-11 Voltage-Interruption Transient Immunity test at 0% for 250 cycles, the EUT reboots and can take greater than 10 seconds to recover.**
- 5 **Performance degradation information for the IEC 61000-4-3 test: Residual spurious signals can increase to the following levels with exposure to the disturbance levels of this test: -60 dBm, due to disturbance signals at the 80-1000 MHz frequency band of this test, -30 dBm, due to disturbance signals at the 1.4-2.0 GHz and 2.0-2.7 GHz frequency bands of this test.**
- 6 **Performance degradation information for the IEC 61000-4-6 test: Residual spurious signals can increase to the worse of either 60 dB below reference level or -60 dBm, with exposure to the disturbance levels of this test.**
- 7 **Performance Criterion C applied at the 70%/25 cycle Voltage-Dip and the 0%/250 cycle Voltage-Interruption test levels (IEC 61000-4-11).**

**Australia / New Zealand  
Declaration of Conformity  
- EMC**

Complies with the EMC provision of the Radiocommunications Act per the following standard, in accordance with ACMA:

- CISPR 11:2003. Radiated and Conducted Emissions, Group 1, Class A, in accordance with EN 61326-1:2006 and EN 61326-2-1:2006.

## **Safety Compliance**

**EC Declaration of  
Conformity - Low Voltage**

Compliance was demonstrated to the following specification as listed in the Official Journal of the European Communities:

Low Voltage Directive 2006/95/EC.

- EN 61010-1: 2001. Safety requirements for electrical equipment for measurement control and laboratory use.

**U.S. Nationally  
Recognized Testing  
Laboratory Listing  
Canadian Certification**

- UL 61010-1:2004, 2<sup>nd</sup> Edition. Standard for electrical measuring and test equipment.
- CAN/CSA-C22.2 No. 61010-1:2004. Safety requirements for electrical equipment for measurement, control, and laboratory use. Part 1.

**Additional Compliances**

- IEC 61010-1: 2001. Safety requirements for electrical equipment for measurement, control, and laboratory use.

---

<b>Equipment Type</b>	Test and measuring equipment.
<b>Safety Class</b>	Class 1 — grounded product.
<b>Pollution Degree Description</b>	<p>A measure of the contaminants that could occur in the environment around and within a product. Typically the internal environment inside a product is considered to be the same as the external. Products should be used only in the environment for which they are rated.</p> <ul style="list-style-type: none"><li>■ Pollution Degree 1. No pollution or only dry, nonconductive pollution occurs. Products in this category are generally encapsulated, hermetically sealed, or located in clean rooms.</li><li>■ Pollution Degree 2. Normally only dry, nonconductive pollution occurs. Occasionally a temporary conductivity that is caused by condensation must be expected. This location is a typical office/home environment. Temporary condensation occurs only when the product is out of service.</li><li>■ Pollution Degree 3. Conductive pollution, or dry, nonconductive pollution that becomes conductive due to condensation. These are sheltered locations where neither temperature nor humidity is controlled. The area is protected from direct sunshine, rain, or direct wind.</li><li>■ Pollution Degree 4. Pollution that generates persistent conductivity through conductive dust, rain, or snow. Typical outdoor locations.</li></ul>
<b>Pollution Degree</b>	Pollution Degree 2 (as defined in IEC 61010-1). Note: Rated for indoor use only.

## Environmental Considerations

This section provides information about the environmental impact of the product.

### Product End-of-Life Handling

Observe the following guidelines when recycling an instrument or component:

**Equipment Recycling.** Production of this equipment required the extraction and use of natural resources. The equipment may contain substances that could be harmful to the environment or human health if improperly handled at the product's end of life. In order to avoid release of such substances into the environment and to reduce the use of natural resources, we encourage you to recycle this product in an appropriate system that will ensure that most of the materials are reused or recycled appropriately.



This symbol indicates that this product complies with the applicable European Union requirements according to Directives 2002/96/EC and 2006/66/EC on waste electrical and electronic equipment (WEEE) and batteries. For information about recycling options, check the Support/Service section of the Tektronix Web site ([www.tektronix.com](http://www.tektronix.com)).

**Mercury Notification.** This product uses an LCD backlight lamp that contains mercury. Disposal may be regulated due to environmental considerations. Please contact your local authorities or, within the United States, refer to the E-cycling Central Web page ([www.eiae.org](http://www.eiae.org)) for disposal or recycling information.

**Perchlorate Materials.** This product contains one or more type CR lithium batteries. According to the state of California, CR lithium batteries are classified as perchlorate materials and require special handling. See [www.dtsc.ca.gov/hazardouswaste/perchlorate](http://www.dtsc.ca.gov/hazardouswaste/perchlorate) for additional information.

### Restriction of Hazardous Substances

This product has been classified as Monitoring and Control equipment, and is outside the scope of the 2002/95/EC RoHS Directive.

# Preface

This is the user manual for the RSA3408B 8 GHz Real-Time Spectrum Analyzer. It covers the following information:

- Product features
- Installation
- Operation
- Menu structure
- Accessories

## About This Manual

This manual is composed of the following chapters:

- *Getting Started* describes the functions, architecture, installation, and calibration of the analyzer.
- *Operating Basics* explains the functions of the front, rear, and side panels and the menus. This section also provides tutorials for beginners. It gives step-by-step procedures for measurement using a signal generator.
- *Reference* explains the basic concepts of measurement processes and application-specific operations. It also describes the front panel keys and menus.
- *Appendices* provide additional information including the menu tree, accessories, and cleaning information.

First time users should install the analyzer in *Getting Started*, and then go to *Operating Basics* and perform the tutorials beginning on Page 2-29.

The analyzer uses Microsoft Windows XP as the operating system. This manual does not describe common usage of Windows XP. Refer to your Windows manuals as necessary.

## Related Documents

In addition to this user manual, the following documentation is available for your analyzer. Tektronix part numbers are supplied in *Appendix G: Options and Accessories*.

- *RSA3000B Series Programmer Manual* (standard accessory, PDF) contains the programming commands and other information related to controlling the analyzer over the GPIB interface.
- *RSA3408B Technical Reference* (standard accessory, PDF) provides specifications and performance verification procedures.
- *RSA3408B Service Manual* (optional accessory) describes how to verify the characteristics of, adjust, disassemble, assemble, and troubleshoot the analyzer, and contains the information required for repair, including module replacement, and calibration.

### PDF Manuals

The Programmer Manual and Technical Reference described above (PDF only) are included in the Documents CD (Tektronix part number 063-4089-XX).

### Optional Software User Manuals

When using the optional software, refer to the following manuals:

- *RSA3303B, RSA3308B, & RSA3408B Option 24 User Manual* provides operating basics for the GSM/EDGE analysis.
- *RSA3303B, RSA3308B, & RSA3408B Option 25 User Manual* provides operating basics for the cdma2000 forward and reverse link analysis.
- *RSA3303B, RSA3308B, & RSA3408B Option 26 User Manual* provides operating basics for the cdma2000 1xEV-DO forward and reverse link analysis.
- *RSA3303B, RSA3308B, & RSA3408B Option 28 User Manual* provides operating basics for the TD-SCDMA analysis.
- *RSA3408B Option 29 User Manual* provides operating basics for the WLAN analysis.
- *RSA3303B, RSA3308B, & RSA3408B Option 30 User Manual* provides operating basics for the 3GPP Release 99 and Release 5 uplink and downlink analysis.
- *RSA3303B, RSA3308B, & RSA3408B Option 40 User Manual* provides operating basics for the 3GPP Release 6 analysis.

## Conventions

This manual uses the following conventions:

- Front-panel key and control labels are printed in boldface. For example:

Press **Span**.

- To identify keys on the front panel, the area name label precedes the key. For example:

Press the Mode: **Demod** key.

- Menu and on-screen form titles are printed in the manual in the same case (initial capitals) as they appear on the analyzer screen, such as Span, Source, and Channel Power. If it is part of a procedure, the menu title is shown in boldface. For example:

Press the **Source** side key.

- A series of keys, controls, and/or menu items separated by an arrow symbol (>) indicates the order in which to perform the listed tasks. For example:

Select **RBW/FFT > Filter Shape... > Gaussian**.





# Getting Started



# Product Overview

The RSA3408B is a portable real-time spectrum analyzer having RF measurement capability up to 8 GHz with wide vector span of 36 MHz. The real-time spectrum analyzer has a different architecture from traditional tools, and is uniquely capable of capturing continuous, intermittent, or random signals with equal ease. The data acquired seamlessly is analyzed in time, amplitude, phase, and frequency domains correlating with time. Furthermore, DPX spectrum processing provides an intuitive understanding of time-varying RF signals with color graded displays based on frequency of occurrence.

## Features

- DC to 8 GHz measurement frequency range
- 100 Hz to 3 GHz measurement span and 36 MHz vector span
- Real-time analysis for seamless capture of time-varying RF signals
- DPX spectrum display facilitates observation of intermittent signals
- Spectrogram provides a 3-D representation of time-varying spectrum
- Spectrum analysis of power, ACPR, C/N, OBW, EBW, and spurious signals
- Analog modulation analysis of AM, PM, FM, ASK and FSK signals
- Digital modulation analysis ranging from BPSK to 256QAM (Option 21)
  - Constellation analysis
  - EVM analysis
  - AM/AM and AM/PM distortion analyses
  - RFID analysis
- Time characteristic analysis
  - Pulse measurements
  - Signal source analysis
- CCDF analysis
- 8.4 inch TFT color display and sturdy cabinet
- USB, LAN, and GPIB interfaces

## Application

The RSA3408B can perform real-time analysis for the following purposes:

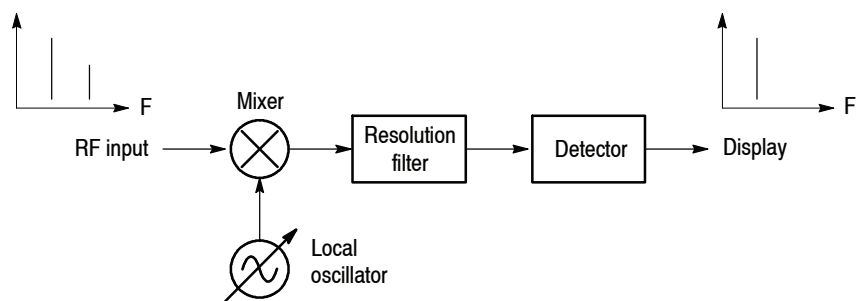
- Signal quality analysis of analog and digital modulation
- Understanding frequency and spectral occupancy behavior over time
- Capture and characterization of undesired, unknown, or interfering signals
- Device/system design or operational diagnostic measurement
- Finding answers to elusive EMI problems
- VCO/synthesizer design
- RFID device characterization
- General purpose digital modulation vector signal analysis (Option)
- Spectrum monitoring
- Radar measurements
- Audio measurements (Option)
- Characterization, troubleshooting, and verification of wireless designs (Option):
  - WLAN 802.11a/b/g/n
  - 3GPP Release 5 and 6
  - TD-SCDMA
  - cdma2000 1x
  - cdma2000 1xEV-DO
  - W-CDMA
  - GSM/EDGE

## Real-Time Analysis

This section explains real-time analysis with the comparison of a conventional swept spectrum analyzer and a real-time spectrum analyzer.

### Conventional Swept Spectrum Analyzer

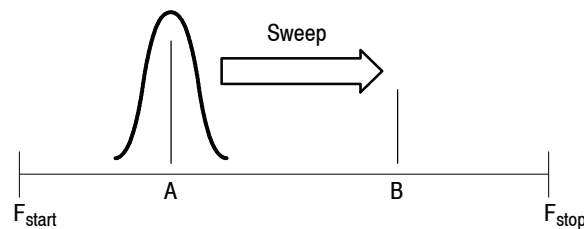
Figure 1-1 is a block diagram of the conventional swept spectrum analyzer. There are two RF input signals in this example. The RF signal is converted to IF (intermediate frequency) by the swept local oscillator. IF output goes through a bandpass filter, where resolution of the spectrum analyzer is defined.



**Figure 1-1: Concept of the swept spectrum analyzer**

The filter is swept from  $F_{\text{start}}$  to  $F_{\text{stop}}$ . See Figure 1-2. Only signals within the filter bandwidth are observed at one point in time. Signal A is detected first and then signal B is detected and displayed.

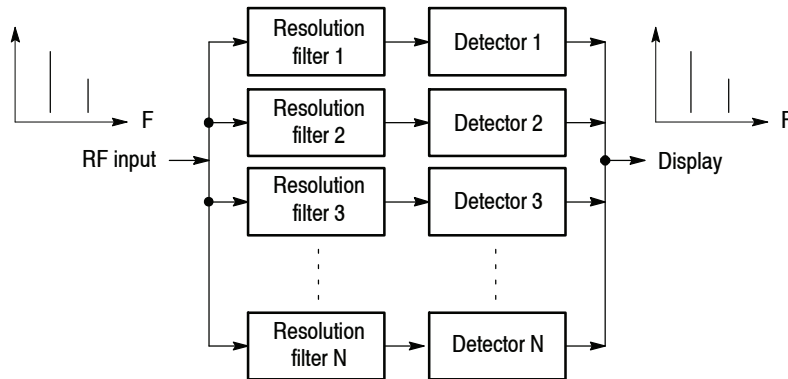
**NOTE.** An intermittent signal, such as a burst phenomenon, will not be detected unless it is present at the exact moment that the filter is being swept past it.



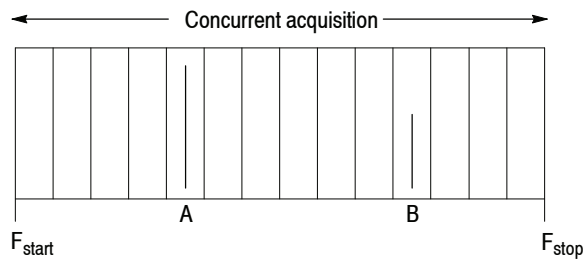
**Figure 1-2: Sweep of resolution filter**

**Real-Time Spectrum Analyzer**

The real-time spectrum analyzer is conceptually equipped with a series of bandpass filters as shown in Figure 1-3. Signals passing through those filters are concurrently observed and recorded continuously. Signals A and B are concurrently acquired and displayed as shown in Figure 1-4.

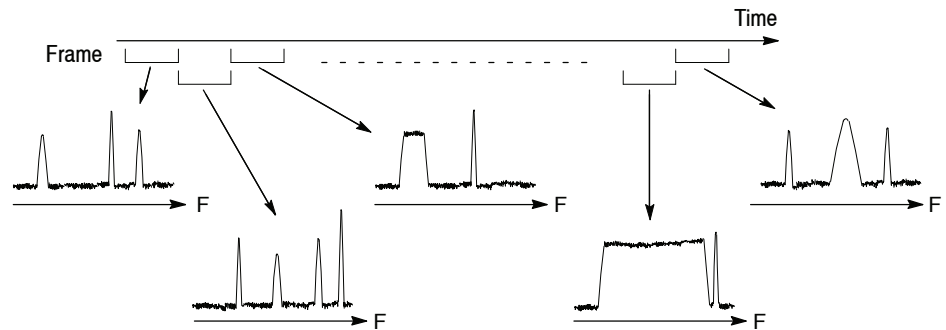


**Figure 1-3: Concept of the real-time spectrum analyzer**



**Figure 1-4: Concurrent acquisition**

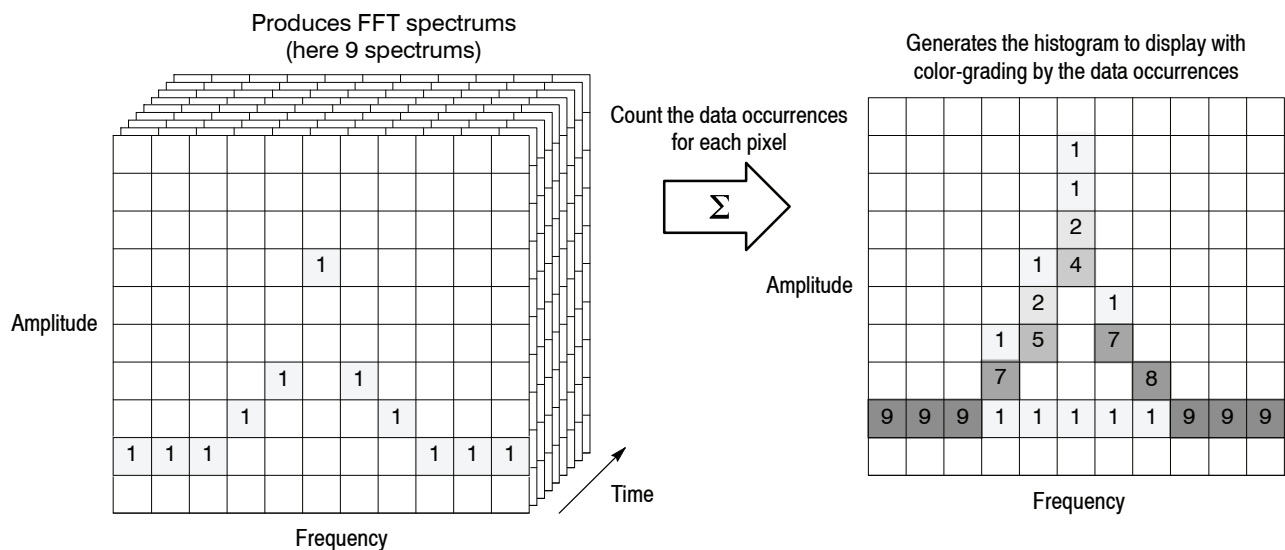
The method used to concurrently acquire signals in a certain frequency range is not bandpass filters, but FFT (Fast Fourier Transformation). The RSA3408B first acquires a series of frames of data in the time domain, as shown in Figure 1-5, and then performs the FFT process for each frame. This method enables continuous analysis of spectra and ensures the capture of real-time phenomenon such as burst signals in digital mobile communication. The RSA3408B is equipped with a 102.4 MHz A/D converter to analyze the spectrum by single scanning for spans up to 36 MHz.



**Figure 1-5: Frame acquisition**

**DPX Spectrum Display**

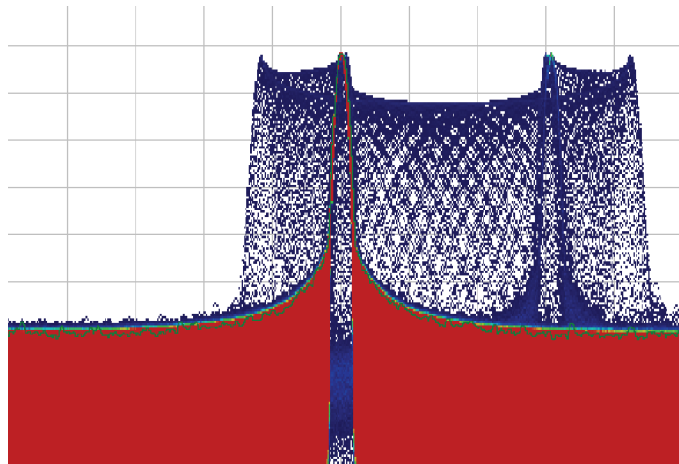
Along with the real-time processing capability, the analyzer has the proprietary DPX (Digital Phosphor) waveform processing technology that enhances visibility of transient phenomena and intermittent events. The DPX process emulates traditional variable persistence CRTs that store waveforms on the phosphor coating by employing the proprietary DPX engine in the real-time spectrum analyzer. The DPX engine produces more than 50,000 FFT spectrums per second and records the data occurrences for each pixel to make a histogram, which is displayed on the color-graded bitmap. Figure 1-6 illustrates the concept of DPX processing and Figure 1-7 shows an example of the DPX spectrum.



**Figure 1-6: DPX processing**

The DPX spectrum display reveals transient signal behavior that helps you discover instability, glitches, and interference.

Here, an infrequently occurring transient is seen in detail. The frequency of occurrence is color-graded, indicating the infrequent transient event in blue and the noise background in red.



**Figure 1-7: DPX spectrum display**

The screen display is generally updated at certain intervals to rewrite waveforms. But the persistence mode in the DPX spectrum display enables a data point once displayed to remain visible for a decay period you specify. You can adjust the persistence time to optimize display characteristics for varying signal conditions, from a live RF view of dynamic signals to the discovery of single occurrences. Persistence is what enables the spectrum analyzer to display events that occur only rarely.



## Architecture

Figure 1-8 shows the block diagram of the signal processing system.

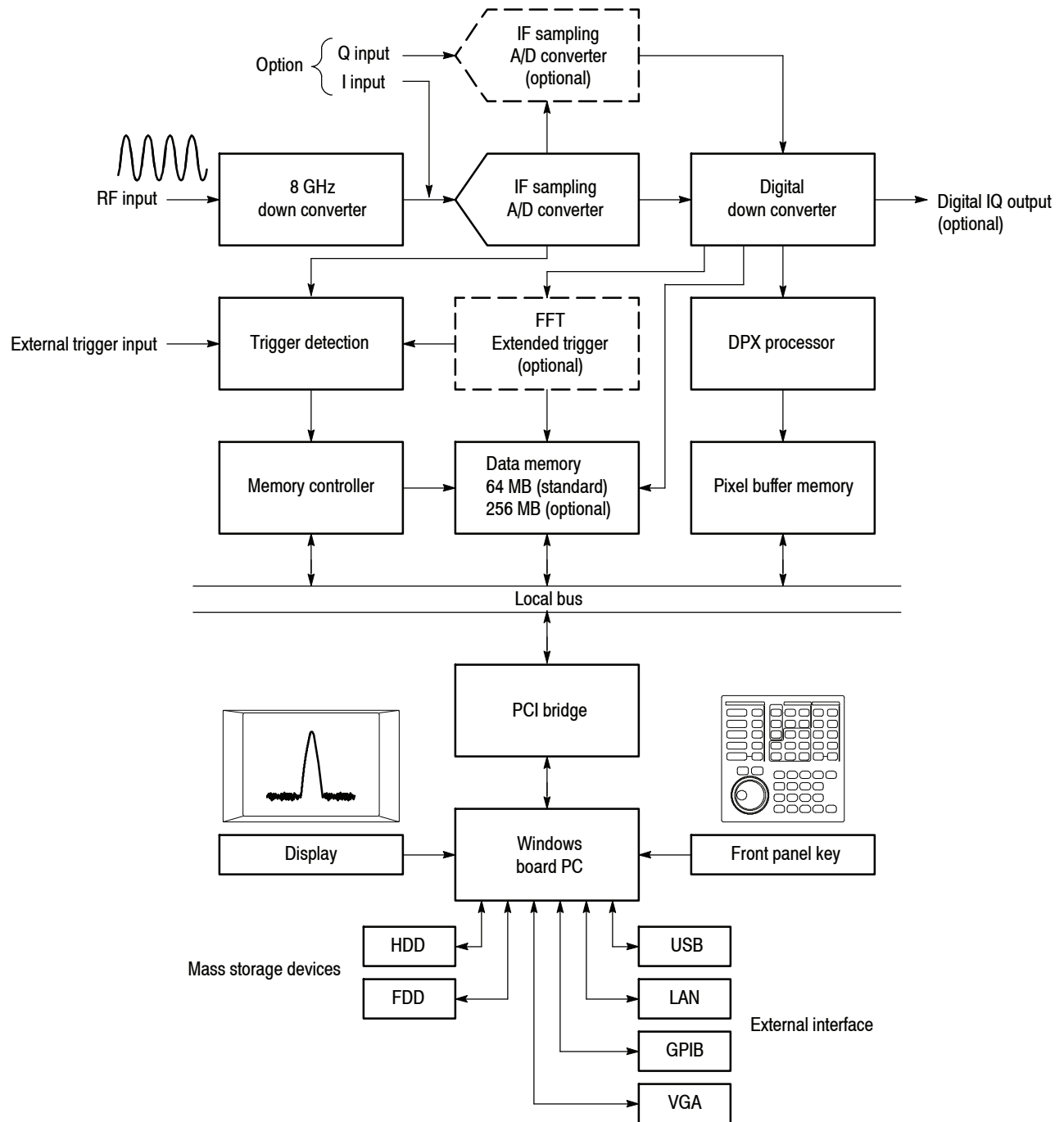


Figure 1-8: Block diagram

**8 GHz  
Down Converter**

Converts the RF signal, applied through the front-panel INPUT connector, into a 76 MHz IF signal. This converter processes signals up to 8 GHz by IF conversions in three stages. A 10 MHz oscillator provides a high-accuracy reference for all stages of IF conversion. The converter also adjusts signals for A/D conversion using a low-noise amplifier, fine-tuning attenuator, and anti-alias filter. The output signal from the down converter is sent to the IF sampling A/D converter.

**IF Sampling A/D Converter**

The IF analog output from the down converter enters the A/D converter through the fine-tuning attenuator, low-noise amplifier, and anti-alias filter, to be converted into a digital signal. The sampling rate of the A/D converter is 102.4 MHz with a resolution of 14 bits. The I/Q splitter separates the real signal from the A/D converter into complex (I and Q) components. With Option 03, you can input I and Q signals from the rear panel connectors.

**Digital Down Converter**

Performs center frequency and span fine-tuning. The digital data from the A/D converter is transformed to a complex signal of maximum  $\pm 20$  MHz, setting any center frequency to 0 Hz. A decimating filter composed of FIR (Finite Impulse Response) filters changes the span by effectively reducing the sampling rate. It allows extremely accurate filtering with minimal spurious emissions. The data streams from the digital down converter are then divided into frames and saved in the data memory.

Option 05 provides the digital IQ data output from the rear panel connectors to store and analyze on an external PC.

**FFT/Extended Trigger  
(Optional)**

Option 02 provides a real-time digital trigger function that monitors the frequency spectrum for the occurrence of specific events. A trigger mask is used to set conditions for trigger.

The FFT processor performs high-speed calculations to create extended trigger signals. The FFT processor performs 1024-point complex FFT at high speed to create extended trigger signals. The FFT processor consists of an input buffer, FFT calculation DSP, output buffer, and timing control circuit. Performing a 1024-point complex FFT at  $10^5$  times per second allows the trigger to operate in real time in spans up to 36 MHz.

Because the trigger comparator is continuously operating at the maximum rate, no events will be missed. The pre-trigger and post-trigger positions can be set as needed; events before and after the trigger event can be measured.

**Data Memory**

A high-speed 64 MB standard SDRAM stores spectrum data. It is expanded to 256 MB with Option 02. For each data point, I and Q data use 2 bytes. This memory can store 16,000 frames for 1 waveform = 1024 points of analysis, and 64,000 frames for Option 02. For example, W-CDMA communication data can be captured for up to 2.5 seconds on standard and 10 seconds on Option 02. The memory is accessed from the system controller via the ISA/PCI bridge.

**DPX Processor/  
Pixel Buffer Memory**

In the DPX spectrum mode, time-domain data from the digital down converter goes to the proprietary DPX processor that performs real-time FFT over 50,000 times per second. The spectrum traces are accumulated in the pixel buffer memory, where a counter is incremented each time a trace writes to a point on the display. A color is assigned to each display point based on the value of its counter. Thus, as acquisitions occur over time, a color-graded waveform, the Bitmap, develops on the display that shows the frequency of data occurrence (signal density).

**Windows Board PC**

The system controller board has an Intel Celeron 1.2 GHz CPU. It runs on Windows XP, and controls menu operation from the front panel keys. It is equipped with a 10 GB hard disk and 3.5 inch disk drive to store data and settings. Waveforms, menus, and measurement results are shown on the color display, which uses an 8.4 inch XGA TFT-LCD module.

The standard analyzer has the following external interfaces:

- USB (for a mouse, keyboard, printer and so on)
- LAN (Ethernet 10/100BASE-T)
- GPIB
- VGA (for an external monitor)



# Installation

This section describes how to install this instrument. The topics are organized as follows:

- Unpacking to check contents
- Applying the power
- Setting up the stand
- Functional check
- Powering off the analyzer
- Restart
- Backing up the user file

Before starting installation, you should become familiar with the *General Safety Summary* on page xv.

## Unpacking to Check Contents

1. This product is packed in a cardboard box for delivery. Before opening the box, make sure that there is no damage on the surface.
2. Open the box, check that the product has no damage and that all the standard accessories are found inside. For a list of accessories, refer to *Standard Accessories* on page G-3. If you find any damaged or missing components, contact your local Tektronix representative.
3. It is recommended to keep the box and packing materials. You may need them to send this product to Tektronix for calibration or repair.



---

**CAUTION.** *The analyzer has exhaust fans on the side panel. Leave a space of at least 5 cm (2 in) on both sides for proper air circulation.*

---

## Applying Power

Power on the analyzer using the following procedure:

### AC Power Requirements

The analyzer operates from an AC line frequency of 47–63 Hz, over the range of 90–250 Volts, without the need for configuration, except the power cord. Refer to page G-2 for the power cord options.

The maximum power consumption is 350 W. Refer to *Specifications* in the *RSA3408B Technical Reference* for additional information on power and environmental requirements.



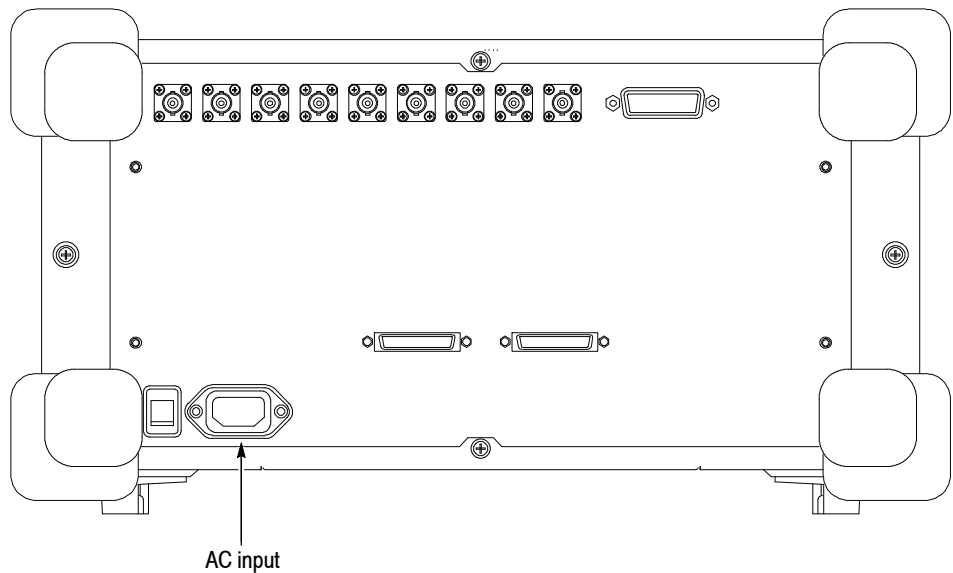
---

**CAUTION.** Use only power cords that are approved for the country of use. Using non-approved power cords could result in fire or shock hazard.

---

### Connecting the Power Cord

1. Plug the power cord into the AC input on the rear panel.

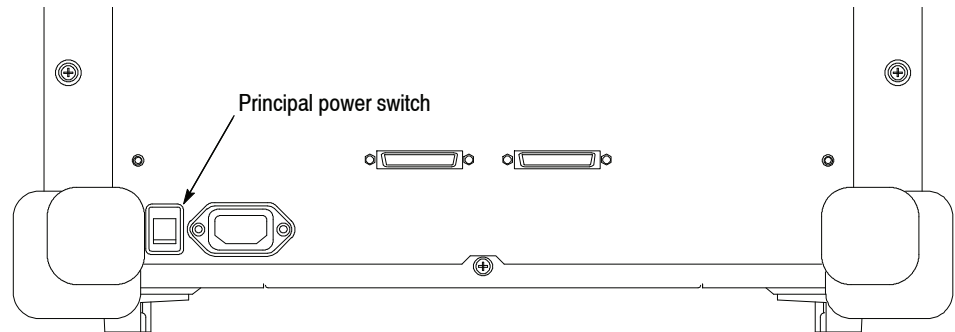


**Figure 1-9: AC Input (rear panel)**

2. Connect the plug of the power cord to a properly grounded outlet.

**Turning on the Analyzer**

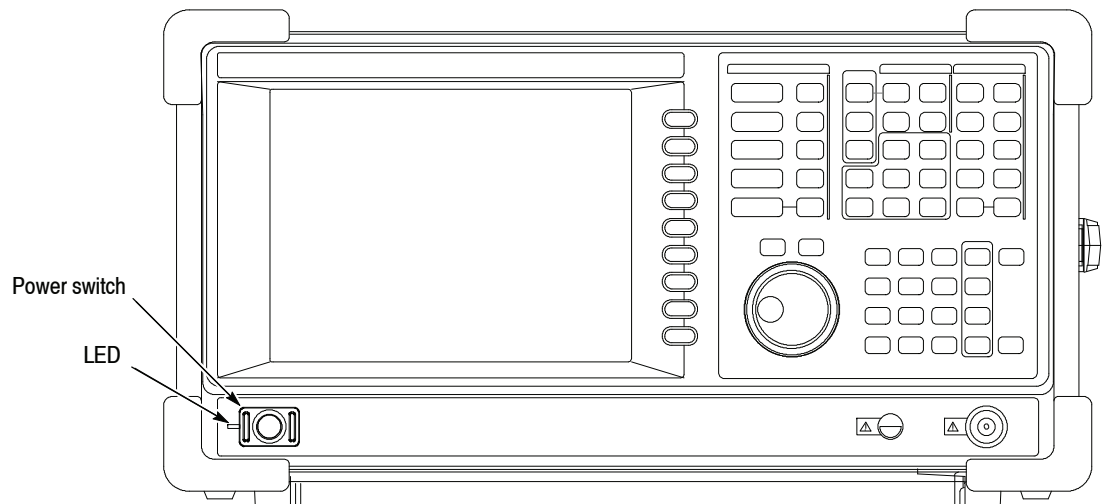
1. Turn on the principal power switch on the rear panel.



**Figure 1-10: Principal power switch (rear panel)**

When you turn on the principal power switch, a voltage is applied to the analyzer standby circuit. Make sure the LED next to the power switch on the front panel lights up in orange.

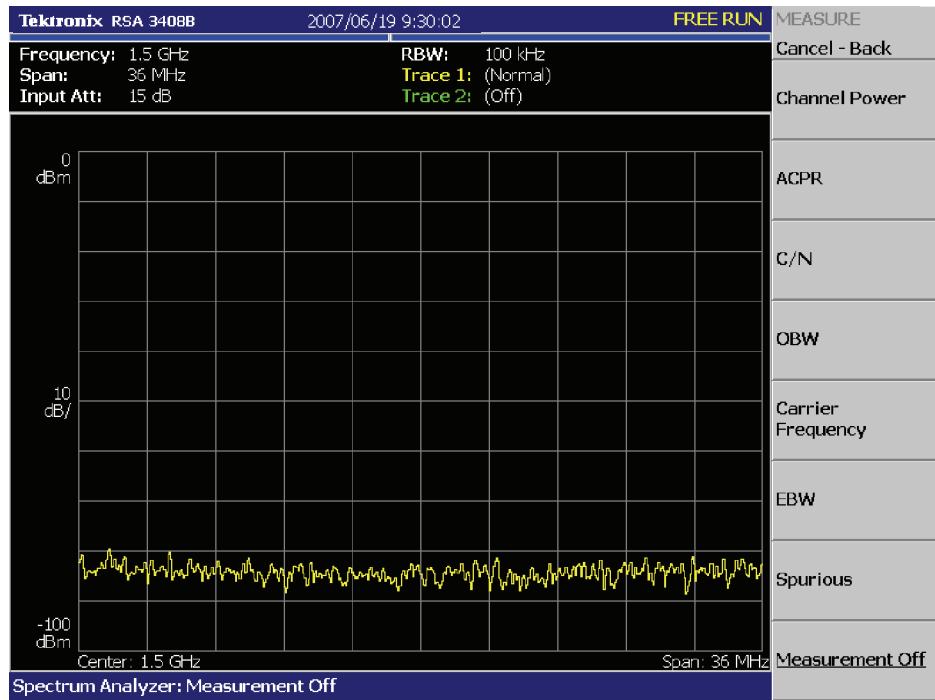
2. Turn on the power switch (On/Standby) on the lower left of the front panel. The LED next to the power switch changes to green.



**Figure 1-11: Front panel power switch (On/Standby switch)**

When you turn on the analyzer, Windows XP starts. After several minutes, the analyzer application starts.

The initial screen appears as shown in Figure 1-12. The displayed spectrum represents the noise floor of the analyzer.

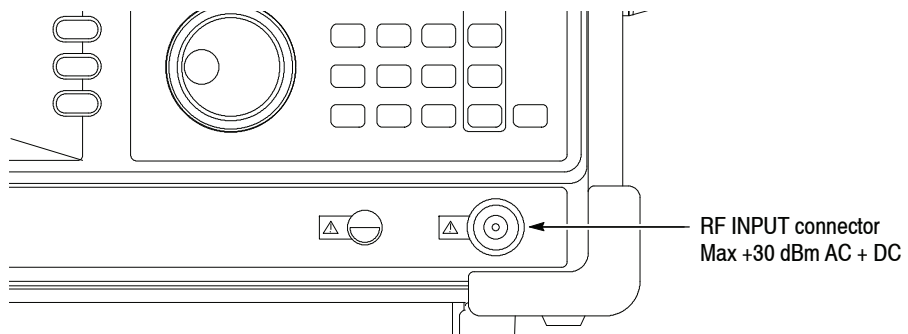


**Figure 1-12: Initial screen**

If “UNCAL” is displayed on top of the screen, run the gain calibration routine (refer to *Calibrating Gain* on page 1-25).



**CAUTION.** Never apply signals with a combined amplitude greater than +30 dBm to the RF INPUT connector. If you exceed this input rating, you can permanently damage the analyzer. (The RF INPUT connector is shown in Figure 1-13.)

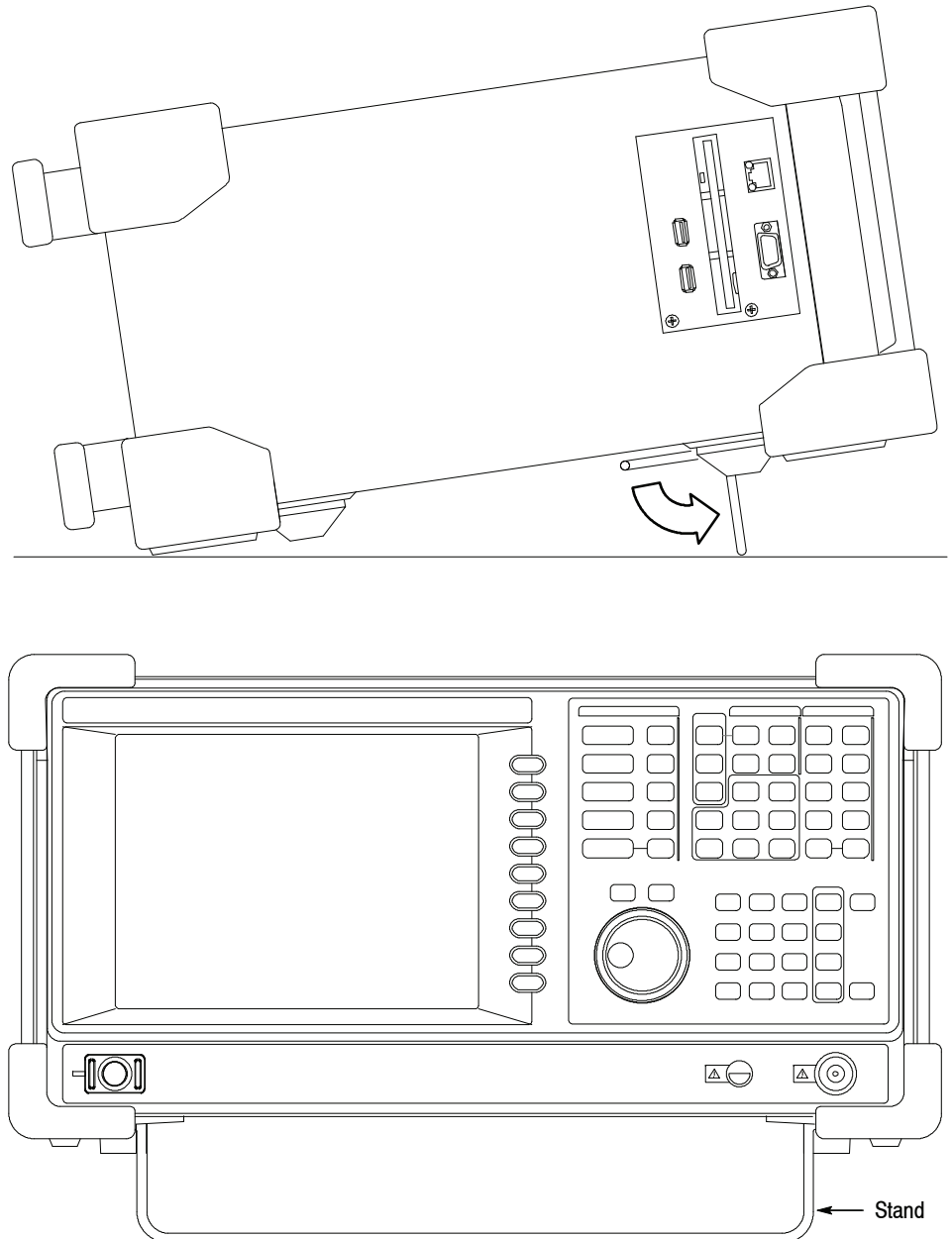


**Figure 1-13: RF INPUT connector**



## Setting Up the Stand

To set up the stand, place the analyzer on a table. Lift the front of the analyzer and pull out the stand until it is perpendicular to the analyzer.



**Figure 1-14: Setting up the stand**

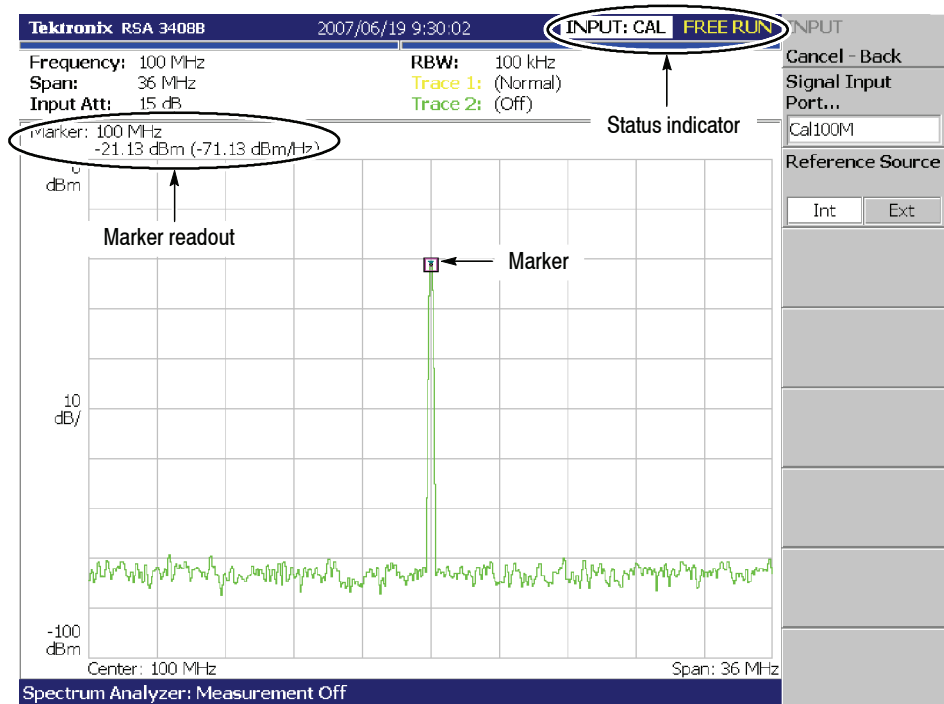
## Functional Check

The analyzer has a built-in calibration signal source with a frequency of 100 MHz and an amplitude of approximately -20 dBm. Using this source, perform this quick functional check to verify that your instrument is operating correctly.

1. Turn on the analyzer.
2. Display the spectrum of the calibration signal:
  - a. Press the **S/A** key on the front panel and then press the **Spectrum Analyzer** side key.
  - b. Press the **Preset** key on the front panel to reset the analyzer.
  - c. Press the **Input** key on the front panel.
  - d. Press the **Signal Input Port...** side key to select **Cal100M**.

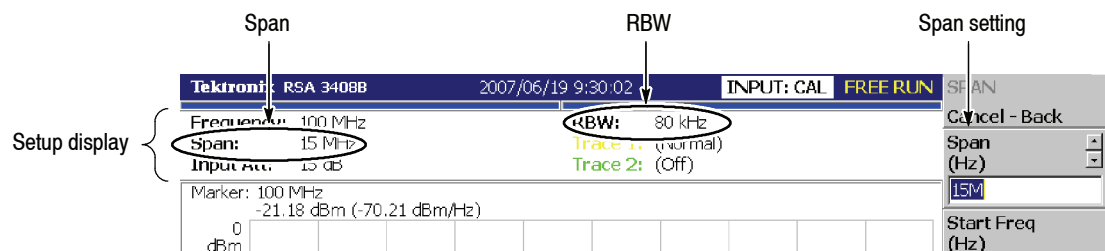
The spectrum of the calibration signal appears.

- e. Check that “INPUT: CAL” and “FREE RUN” are displayed in the status indicator at the upper right of the screen (see Figure 1-15).



**Figure 1-15: Spectrum of the calibration signal (100 MHz, about -20 dBm)**

3. Check the center frequency and peak amplitude using the marker:
  - a. Press the **Peak** key on the front panel to place the marker on the peak (see Figure 1-15).
  - b. Check the marker readouts on screen. The frequency should be 100 MHz and the amplitude should be approximately -20 dBm.
  - c. Press the **Marker Setup** key on the front panel and then the **Markers** side key to select Off. Check that the marker disappears.
4. Check the RBW (Resolution Bandwidth) while changing the span setting.
  - a. Press the **Span** key on the front panel.
  - b. Confirm that the span is 36 MHz and the RBW is 100 kHz in the setup display on the upper part of the screen (see Figure 1-16).



**Figure 1-16: Setup display**

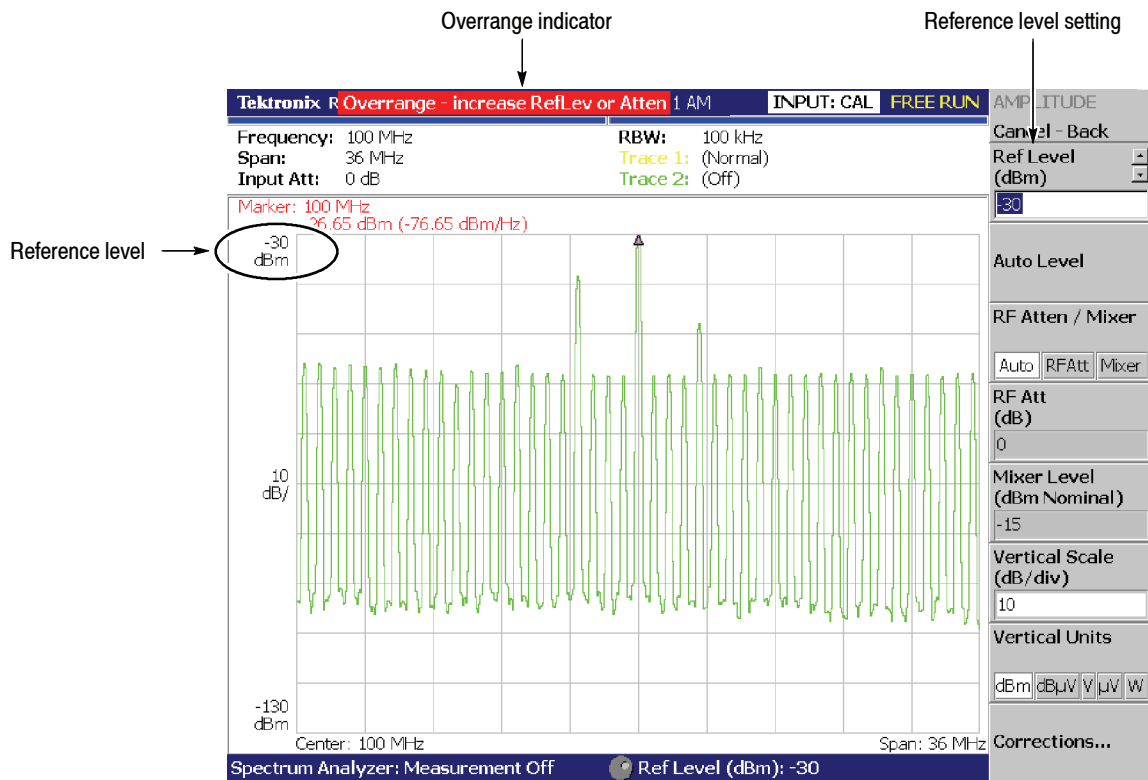
- c. Using the general purpose knob, change the span setting as listed in Table 1-1 and check that the RBW is displayed correctly.

**Table 1-1: Span and RBW**

Span	RBW
36 MHz	100 kHz
15 MHz	80 kHz
5 MHz	20 kHz
100 kHz	500 Hz
1 kHz	20 Hz

- d. Using the numeric keypad, set the span back to 36 MHz. (Press **3 > 6 > MHz**, in that order, on the keypad.)

5. Check the reference level:
  - a. Press the **Amplitude** key on the front panel.
  - b. Make sure that the reference level is set to 0 dBm with the **Ref Level** side key. Check that 0 dBm is displayed on the upper left side of the graticule (see Figure 1-17).
  - c. Use the general purpose knob to set the reference level to -30 dBm.
  - d. Confirm that “Overrange - increase RefLev or Atten” is indicated in the red box at the top center of the screen. Make sure that -30 dBm is displayed on the upper left side of the graticule and that the spectrum waveform is distorted as shown in Figure 1-17.



**Figure 1-17: Reference level setting and overrange indicator**

- e. Using the numeric keypad, set the reference level back to 0 dBm. (Press **0** > **Enter**, in that order, on the keypad.)

6. Check the spectrogram display:
  - a. Press the **S/A** key on the front panel.
  - b. Press the **S/A with Spectrogram** side key. Check that the spectrogram is displayed on the lower side of the screen (see Figure 1-18).
  - c. Press the **Run/Stop** key on the front panel to stop data acquisition. Confirm that the trace display freezes and **PAUSE** is displayed in the status indicator at the top right of the screen.

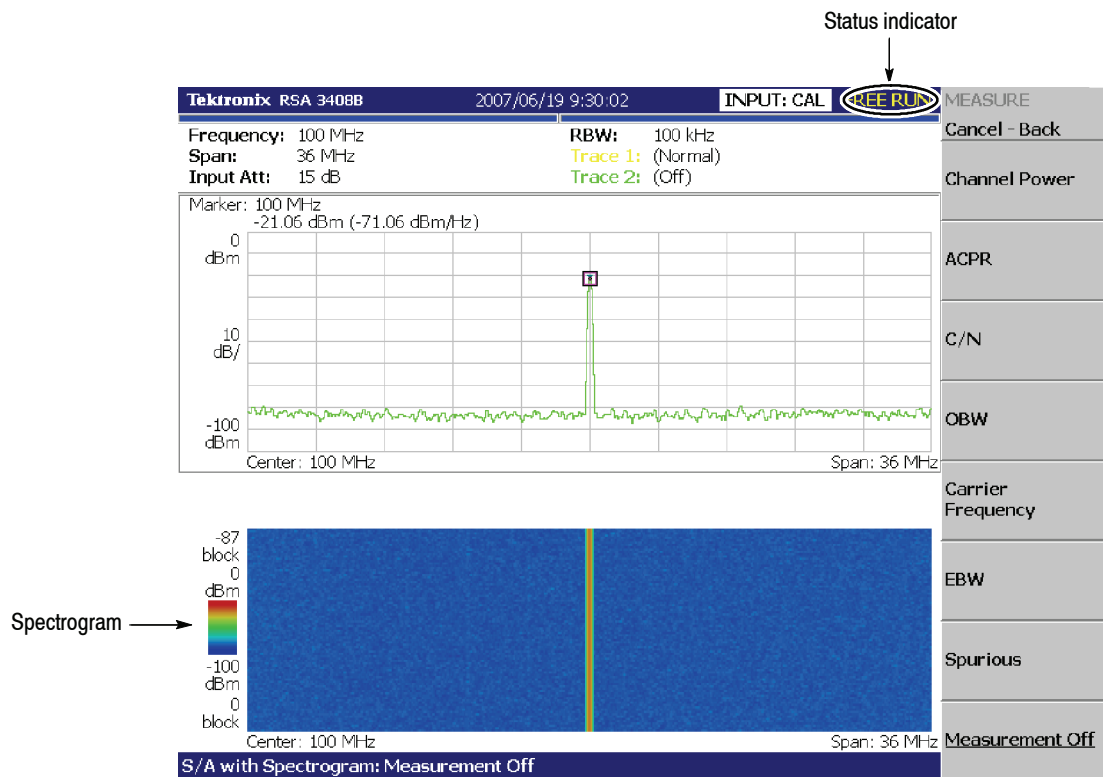


Figure 1-18: Spectrogram display

## Powering Off the Analyzer

Turn off the power switch on the front panel.



---

**CAUTION.** *When you power on or off the analyzer, you must use the front-panel power switch. Failure to do so may cause the operating system to shut down improperly.*

*When you power on the analyzer again, wait at least 10 seconds after the last power off.*

---

When you press the front-panel On/Standby switch, the analyzer starts a shutdown process (including a Windows shutdown) to preserve settings and then power off. The LED next to the power switch changes to orange. Avoid using the rear-panel power switch or disconnecting the power cord to power off the analyzer.

To completely remove power to the analyzer, perform the shutdown just described, and then set the power switch on the rear panel to off.

---

**NOTE.** *Turning off the front-panel power switch does not shut down the principal power supply completely. To turn off the principal power supply, press the principal power switch on the rear panel. Turning off the principal power switch turns off the front-panel LED. When you do not use the analyzer for a long time or in case of emergency, you should unplug the power cord.*

---

## Restarting the Analyzer

When the analyzer operates abnormally, use the following procedure to turn the analyzer off and on again.

---

**NOTE.** *When the analyzer operates abnormally, it will not be shut down by turning off the front-panel power switch alone.*

---

1. Make sure that the front-panel power switch is in the turned-off position.
2. Turn off the principal power switch on the rear panel.
3. Wait at least 10 seconds and then turn on the principal power switch again.
4. Turn on the front-panel power switch.

### When Scan Disk Appears

If the analyzer was not shut down properly, Windows Scan Disk may run when you turn on the analyzer. When the Scan Disk screen appears, wait until the Scan Disk is completed. If an error is detected, refer to the Windows manual for treatment. For more information on accessing Windows on the analyzer, refer to *Using Windows XP* on page 2-27.

### When the Display Brightness Is Not Even

It is a characteristic of the LCD (Liquid Crystal Display) panel to sometimes have uneven brightness, dead pixels (dots that never turn on) or stuck pixels (dots that always stay on). This is neither a malfunction nor a defect, and not a cause for repair or exchange.

### Restoring the Instrument Operating System

Refer to *Appendix E: Restoring the Instrument Operating System*.

## Backing Up User Files

You should back up your user files on a regular basis in case of system failures. The Backup tool is located in the System Tool folder in the Windows Accessory folder. Start this tool to select the files and folders to back up. For more information, use Windows online help. For more information about access to Windows on the analyzer, refer to *Using Windows XP* on page 2-27.

The following files should be backed up frequently:

- Status files (\*.sta)
- Data files (\*.iqt)
- Trace files (\*.trc)
- Correction files (\*.cor)

Refer to page 3-251 for details on file operations.

### Using LAN

The analyzer is equipped with a LAN Ethernet interface as standard, allowing you to save data in peripheral devices such as other PCs, hard disks, and MO via a network. Refer to page 2-6 for connecting to LAN.

## Installing Other Applications

The analyzer incorporates Windows XP as the operating system. Some combinations of internal measurement applications and external applications may cause deterioration in the basic performance or conflicts between these applications. It is not recommended that you install other applications, including Microsoft Word, Excel, and Outlook, on the analyzer. If you install an external application, you do so at your own risk, keeping in mind that it may lower the performance of the analyzer.



# Calibration

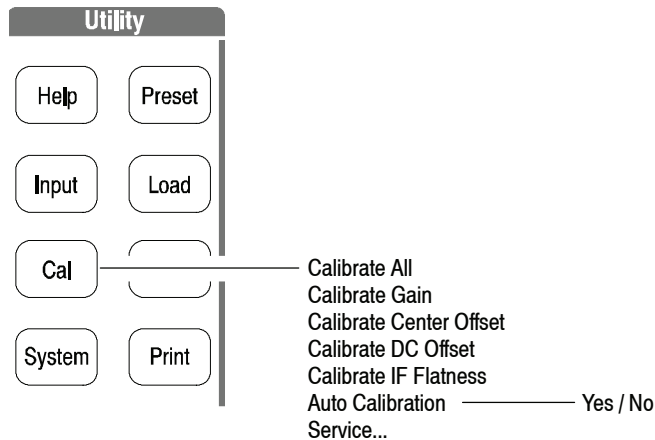
Perform these routines to optimize the analyzer performance:

- Gain calibration
- Center offset calibration
- DC offset calibration
- IF flatness calibration
- Display brightness adjustment

Each item is explained in this section.

## Cal Menu

Use the **Cal** key to calibrate the analyzer.



**Figure 1-19: Calibration menu structure**

The Cal menu contains the following controls:

**Calibrate All.** Performs all possible calibration operations.

**Calibrate Gain.** Calibrates the internal gain steps.  
Refer to page 1-25 for the gain calibration.

**Calibrate Center Offset.** This calibration cancels a center offset.  
Refer to page 1-26 for the center offset calibration.

**Calibrate DC Offset.** This calibration cancels DC offset in baseband.  
Refer to page 1-27 for the DC offset calibration.

**Calibrate IF Flatness.** Calibrates the IF (intermediate frequency) flatness.  
Refer to page 1-27 for the IF flatness calibration.

**Auto Calibration.** Determines whether to automatically perform all possible calibration operations. The default setting is On.

**Service...** This menu item is only to be used by qualified personnel for repair and calibration. Refer to the *RSA3408B Technical Reference and Service Manual* (optional accessory) for details.

If you want to perform all possible calibration operations together, press the **Calibrate All** side key. When **Auto Calibration** is set to Yes, they will be performed automatically any time the analyzer is in an uncal state.

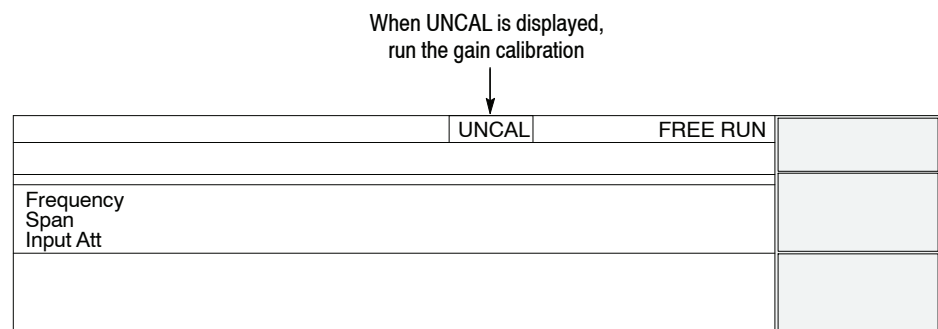
**NOTE.** When you run the calibration during signal acquisition, the calibration starts after the acquisition is completed.

## Calibrating Gain

The gain calibration calibrates the analyzer’s amplifier gain using the internal signal generator. Run this internal calibration routine as required when you boot the analyzer or when UNCAL (uncalibrated) is displayed during operation.

Allow the analyzer to warm up for 20 minutes before you begin the calibration. The warm-up period allows electrical performance of the analyzer to stabilize.

During normal operation, when the ambient temperature changes by more than  $\pm 5$  °C from the temperature at the last calibration, UNCAL is displayed in the yellow box at the top of the screen (see Figure 1-20). If this happens, run the gain calibration.



**Figure 1-20: UNCAL display**

To run the gain calibration, do the following:

1. Press the **CAL** key on the front panel.
2. Press the **Calibrate Gain** side key.

The calibration runs. It takes several seconds to complete the process.

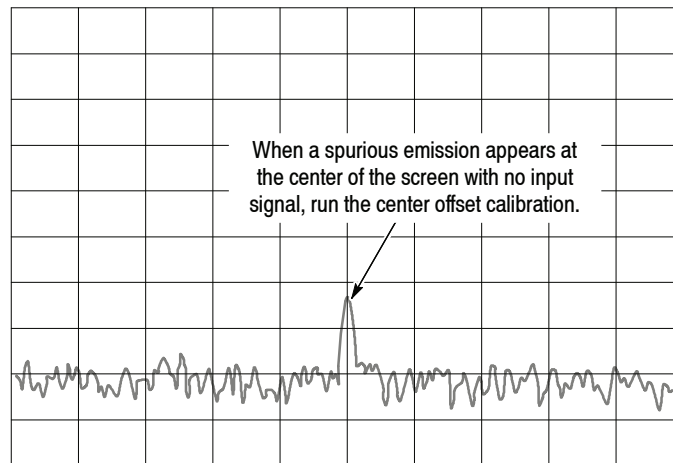
## Calibrating Center Offset

When you display a spectrum and no input signal is present, a spurious emission may appear at the center frequency regardless of frequency settings. The center offset calibration cancels those spurious emissions. If the spurious emission is too obvious when you narrow the span, run the calibration.

---

**NOTE.** *Option 03 only. When you input I and Q signals from the rear panel connectors, set the IQ input signal level to zero externally.*

---



**Figure 1-21: Center offset**

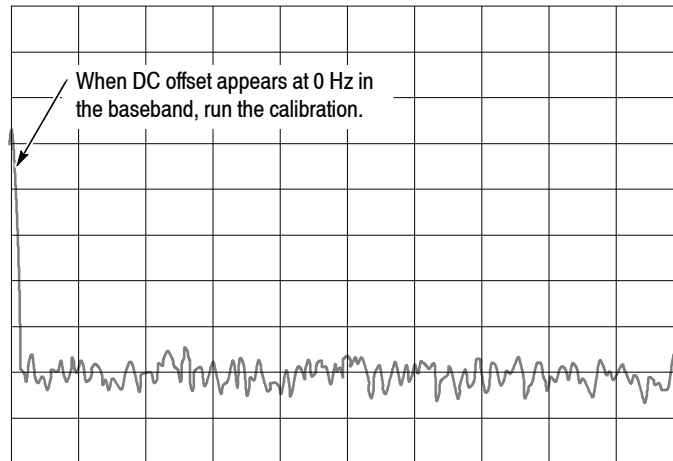
To run the center offset calibration, do the following:

1. Press the **Cal** key on the front panel.
2. Press the **Calibrate Center Offset** side key.

The calibration runs. It takes several seconds to complete the process.

## Calibrating DC Offset

The DC offset calibration cancels DC offset that appears at 0 Hz in the baseband (DC to 40 MHz). When you change the amplitude setting and the DC offset is too obvious, run the DC offset calibration.



**Figure 1-22: DC offset**

To run the DC offset calibration, do the following:

1. Press the **Cal** key on the front panel.
2. Press the **Calibrate DC Offset** side key.

The calibration runs. It takes several seconds to complete the process.

## Calibrating IF Flatness

The IF flatness calibration adjusts the IF (intermediate frequency) flatness using the internal signal generator. It optimizes the flatness of gain and phase within the IF bandwidth automatically. This calibration is recommended in digital modulation analysis.

To run the IF flatness calibration, do the following:

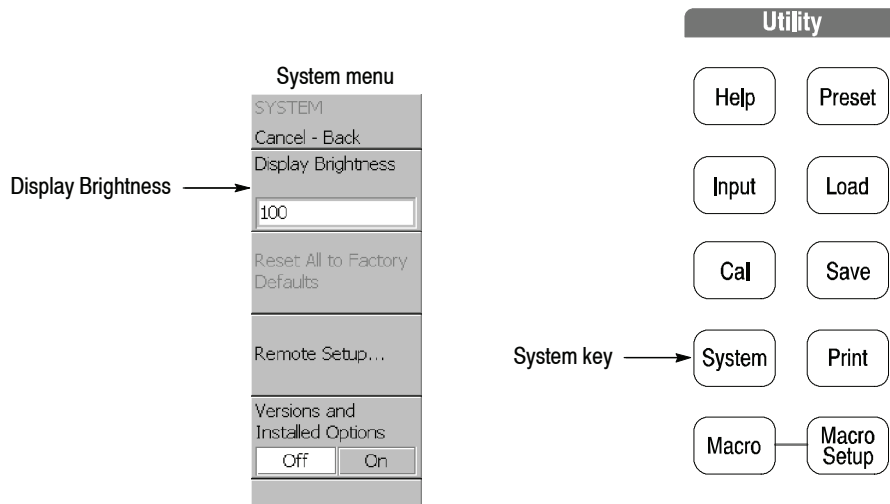
1. Press the **Cal** key on the front panel.
2. Press the **Calibrate IF Flatness** side key.

The calibration runs. It takes several seconds to complete the process.

## Adjusting Display Brightness

Adjust the brightness of the display according to your environment.

1. Press the **System** key on the front panel (see Figure 1-23).



**Figure 1-23: System menu**

2. Press the **Display Brightness** side key.
3. Turn the general purpose knob to adjust the brightness. The setting range is 0 to 100.

## Confirming Performance

The electrical characteristics described in the *RSA3408B Technical Reference* can be checked only by our service personnel. If you need any service, contact your local Tektronix representative.

# Operating Basics





# Interface Maps

This section describes the controls, connectors, and display:

- Controls and connectors
  - Front panel
  - Rear panel
  - Side panel
  - Using a mouse and keyboard
- Display screen
  - Elements of the display
  - Status display
  - Front panel key lock
  - Setup display

For using the removable hard disk drive (Option 06), refer to Appendix D.

## Controls and Connectors

Figures 2-1 through 2-3 on the following pages show the controls and connectors on the front, the side, and the rear panels. For the connector specifications, refer to the *RSA3408B Technical Reference*.

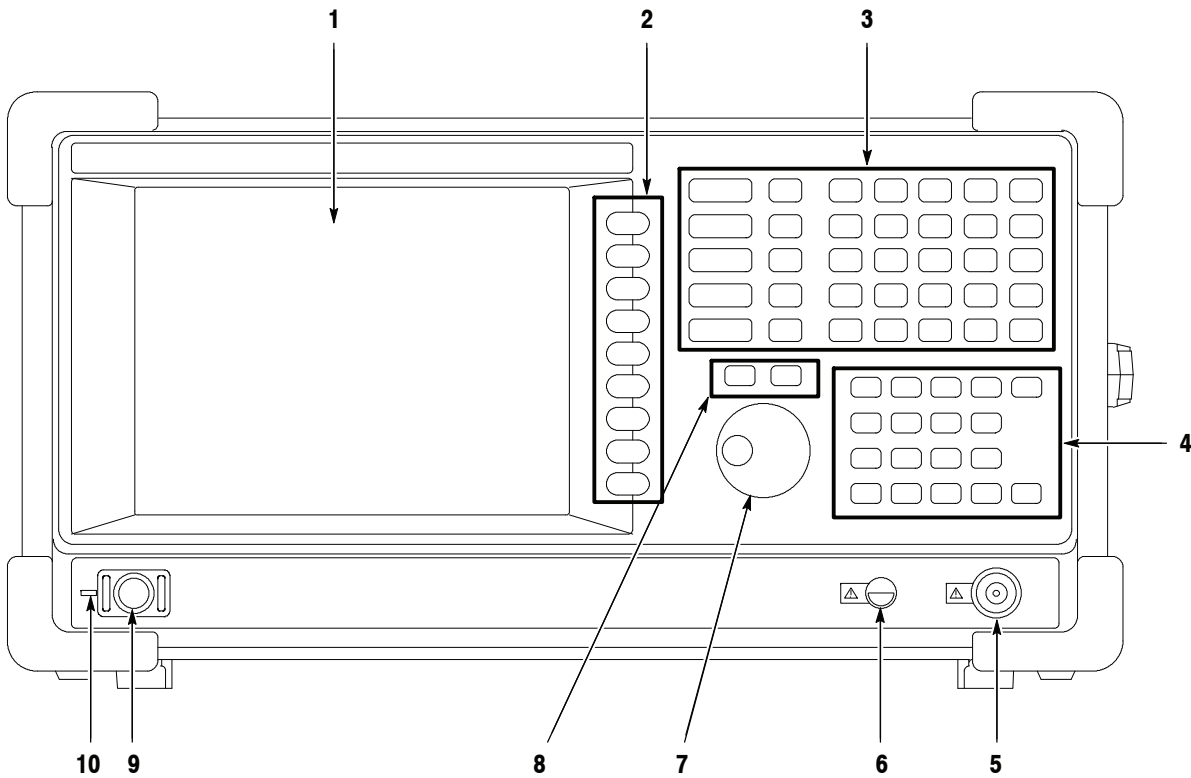


Figure 2-1: Front panel

**Front-Panel Interface**

1. **Display.** LCD (Liquid Crystal Display).  
Size: 21.3 cm (8.4 inch)  
Resolution: 800 × 600 dots  
Color: 256 colors maximum
2. **Side Keys.** Select menu items associated with menu keys.
3. **Menu keys.** Select menus. Refer to page 2-15 for details.  
  
Refer to page 2-18 for menu operations.
4. **Keypad.** Enters alphanumeric characters. Refer to page 2-19 for entering a numeric value and page 3-262 for entering a file name.
5. **RF input connector.** Connects an input signal.  
Type: N-type connector  
Input impedance: 50  $\Omega$   
Maximum capacity of non-breakdown input: 30 dBm

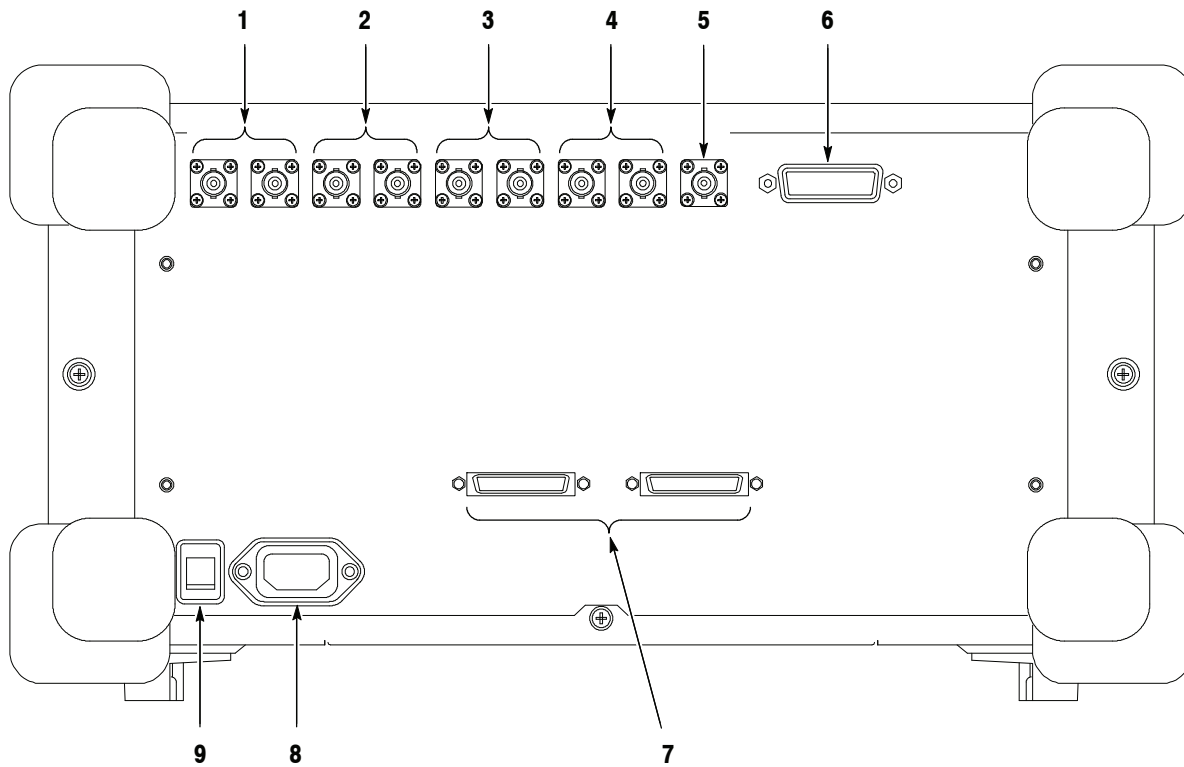


---

**CAUTION.** Do not apply a signal of more than +30dBm; to do so may damage the instrument.

---

6. **Preamplifier power source.** Provides power source for a preamplifier (optional accessory). Refer to the *RSA3408B Technical Reference* for specifications.
7. **General purpose knob.** Changes a setting.
8. **Up/Down keys.** Increases or decreases a value.  
  
Refer to page 2-20 for changing a setting using the general purpose knob or the up/down keys.
9. **Power switch (On/Standby).** Refer to page 1-12 for applying power.
10. **LED.** Green on operating, orange on standby.



**Figure 2-2: Rear panel**

**Rear-Panel Interface**

1. **REF IN/OUT connector.** A 50  $\Omega$  BNC connector for reference signal input/output to synchronize the analyzer with other instrument.
2. **I+/I- INPUT connector (Option 03 only).** A 50  $\Omega$  BNC connector for I signal differential input. When using one connector as a single-ended input, terminate the other end in 50  $\Omega$ .
3. **Q+/Q- INPUT connector (Option 03 only).** A 50  $\Omega$  BNC connector for Q signal differential input. When using one connector as a single-ended input, terminate the other end in 50  $\Omega$ .

For connectors **1**, **2**, and **3** above, refer to *Selecting Input Source* on page 3-249 to control the reference signal input/output and I/Q input.

4. **TRIG IN/OUT connector.** A 50  $\Omega$  BNC connector for trigger signal input/output. Refer to page 3-163 for trigger.
5. **421 MHz IF OUT connector.** A 50  $\Omega$  BNC connector for 421 MHz IF (Intermediate Frequency) output.
6. **GPIB connector.** Used to control the analyzer from an external controller. Refer to the *RSA3408B Programmer Manual* for GPIB control.
7. **DIGITAL IQ OUT (Option 05 only).** MDR (3M) 50-pin connectors for generating I and Q data after A/D conversion (refer to *Architecture* on page 1-7) to store and analyze on an external PC. For the pin assignment, refer to Appendix C.

---

**NOTE.** *IQ Input (option 03) and Digital IQ Output (option 05) function connectors are factory installed. The functions are enabled by software key code entry. The required key code must be accepted by the instrument before you can use these functions. Refer to Displaying Versions and Installed Options on page 2-26 for entering the key code.*

---

8. **AC line connector.** Connect an AC power cable.

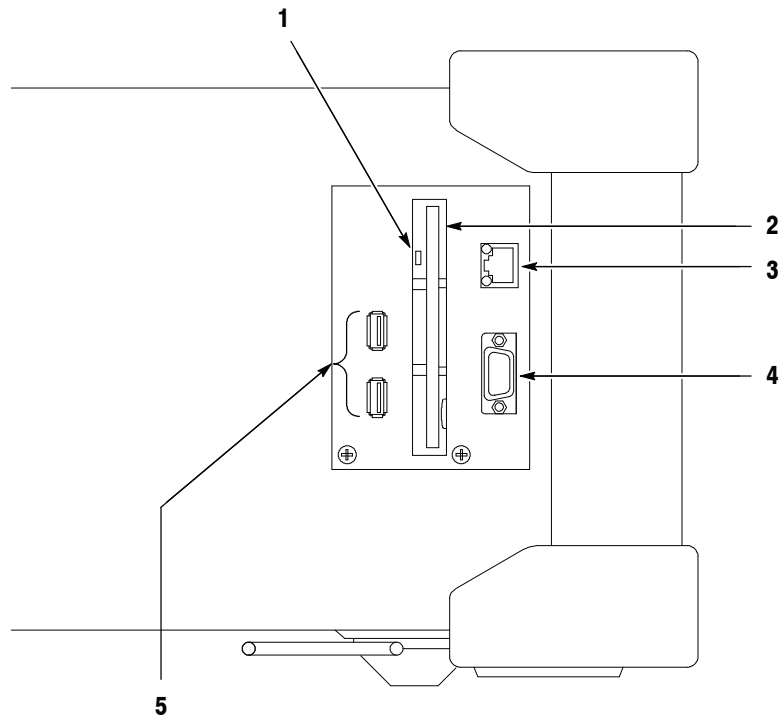


---

**WARNING.** *The instrument uses the power plug as a disconnecting device. The instrument must be installed where the plug can be easily reached by the operator. When you do not use the instrument for a long time or in case of emergency, you should unplug the power cord.*

---

9. **PRINCIPAL POWER SWITCH.** When this switch is on, the internal standby circuit is energized. Refer to page 1-12 for applying power.



**Figure 2- 3: Side panel**

**Side-Panel Interface**

- 1. Indicator.** Indicates whether the disk drive is active.




---

**CAUTION.** When this indicator is lit, you must not remove the disk from the disk drive. If you do so, the data stored on the medium may be destroyed or an error may occur.

---

- 2. Floppy disk drive.** A 3.5-inch 2HD (1.44MB) or 2DD (720KB) disk formatted for MS-DOS can be used to save and load data and settings.
- 3. LAN Ethernet connector.** 10/100BASE-T connector. When you reboot the analyzer after connecting to LAN, the analyzer recognizes the network speed automatically and sets it to 10 Mbps or 100 Mbps. You can share resources such as files or disks on the network.

---

**NOTE.** The Windows XP default network settings are configured when the instrument is shipped from the factory. Contact your system administrator for information about setting network parameters in your LAN.

For using Windows XP on the analyzer, refer to page 2-27.

---

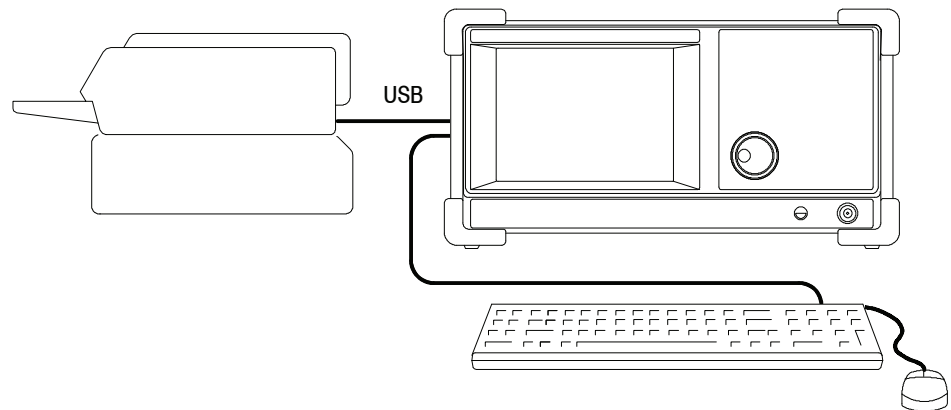
- VGA output connector.** 15 pin D-sub connector (female) to send the display of this instrument to another monitor.

---

**NOTE.** When you use an external monitor, connect a VGA cable to the analyzer and to the monitor, and then turn on the monitor before you turn on the analyzer.

---

- USB connectors (two ports).** Connect USB devices such as a mouse, keyboard, and printer. You can connect the devices any time, with no setup (plug & play), to either or both ports. You can also connect a mouse to a USB port on a keyboard (see Figure 2-4).



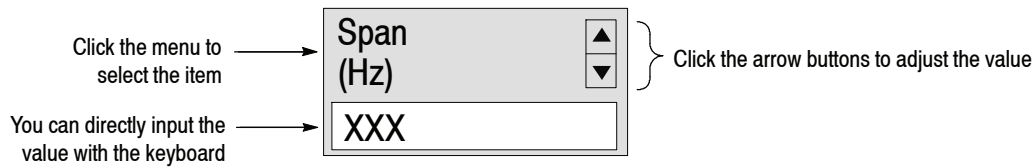
**Figure 2-4: Connecting USB devices**

### Using a Mouse and Keyboard

You can operate the analyzer using the standard accessory mouse and keyboard instead of the side keys and the front panel keypad.

The mouse and keyboard operations are as follows:

- Click the menu item instead of pressing the side keys.
- If the menu item has arrow buttons, click them to select the value.



**Figure 2- 5: Operation with mouse and keyboard**

**Table 2- 1: Key functions of the keyboard**

Key	Purpose	Function
Numeric keys	Numeric input	Enter a numeric value in a numeric input field.
Left/Right arrow keys	Caret move	Moves the caret in an alpha or numeric input field.
Home	Caret move	Moves the caret to the beginning of an input field.
End	Caret move	Moves the caret to the end of an input field.
Backspace	Alphanumeric input	Deletes the character before the caret.
Delete	Alphanumeric input	Deletes the character after the caret.
ESC	Alphanumeric input	Aborts a numeric entry and restores the original value.
ENTER	Alphanumeric input	Accepts a value in the input field.
K or k key	Alphanumeric input	Kilo (10 <sup>3</sup> ). Press ENTER to complete entry of the value.
M key	Alphanumeric input	Mega (10 <sup>6</sup> ). Press ENTER to complete entry of the value.
G or g key	Alphanumeric input	Giga (10 <sup>9</sup> ). Press ENTER to complete entry of the value.
m key	Alphanumeric input	milli (10 <sup>-3</sup> ). Press ENTER to complete entry of the value.
U or u key	Alphanumeric input	micro (10 <sup>-6</sup> ). Press ENTER to complete entry of the value.
N or n key	Alphanumeric input	nano (10 <sup>-9</sup> ). Press ENTER to complete entry of the value.



## Display Screen

Figure 2-6 shows the elements of the display screen.

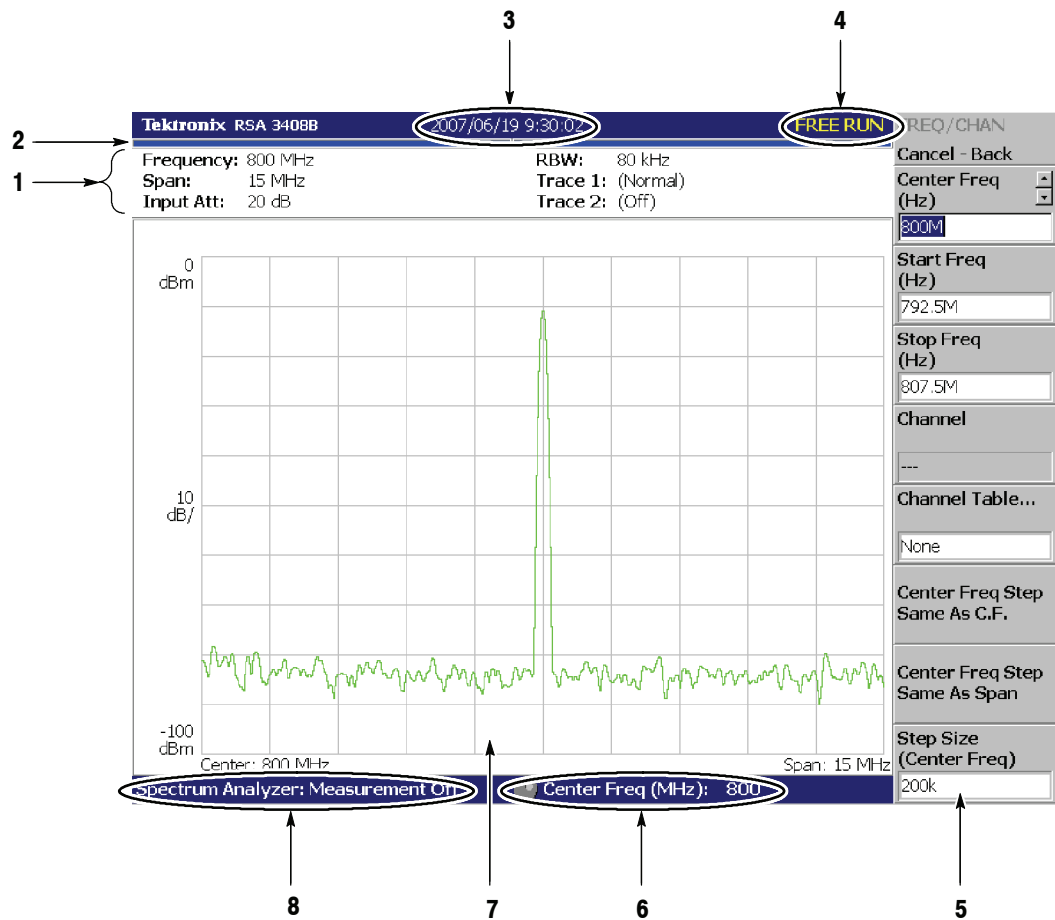


Figure 2-6: Display screen configuration

**Elements of the Display**

1. **Setup display area.** Displays the current hardware value. Refer to *Setup Display* on page 2-13.
2. **Progress bar.** Indicates the progress of the acquisition cycle on the left bar and the measurement cycle on the right bar. The progress fills up in blue from left to right.
3. **Date/Time display area.** Shows the current date and time.
4. **Status display area.** Shows the trigger status. Refer to *Status Display* on page 2-11.
5. **Side menu display area.** When you press a menu key on the front panel, the menu associated with that key is displayed. Refer to page 2-15 for details of menu items.
6. **Menu setting display area.** Displays the last setting of the menu item that can be set with the general purpose knob.
7. **View.** The View window displays the waveform or the measurement results. Multiple views can be displayed on one display screen, depending on the measurement mode.

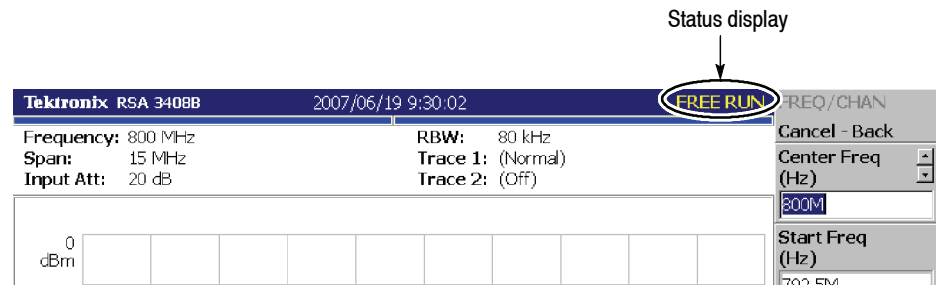
For more information, refer to:

Spectrum Analysis (S/A mode)	page 3-1
Modulation Analysis (Demod mode)	page 3-31
Time Analysis (Time mode)	page 3-99
Setting Views	page 3-203

8. **Measurement function display area.** Displays the measurement function currently in use (the settings of the Mode and Measure menus).

**Status Display**

The status display area in the upper right side of the screen (see Figure 2-7) shows the instrument status as listed in Table 2-2.

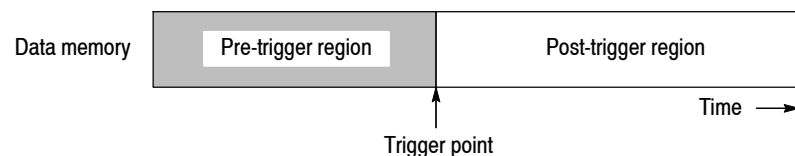


**Figure 2-7: Status display**

**Table 2-2: Status display**

Item	Description
ARM	The pre-trigger portion of the acquisition record is filling. A trigger event occurring during this state will not be recognized.
READY	Pre-trigger data has been acquired, and the instrument is waiting for a trigger event.
TRIG'D	Pre-trigger data has been acquired, and a trigger event has been detected. The instrument is now acquiring post-trigger data.
FREE RUN	The instrument acquires and measures without waiting for a trigger event.
PAUSE	The user has temporarily stopped acquisition/measurement cycling.

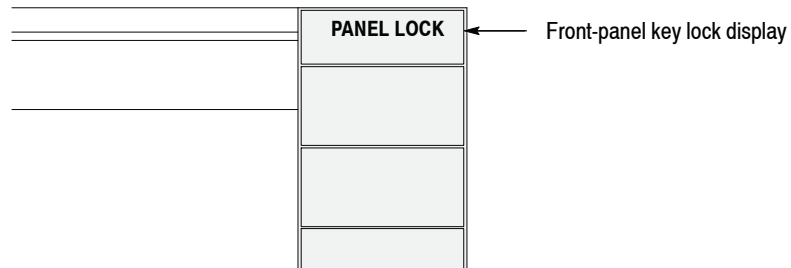
The acquired data is stored in the data memory from address zero in order of acquisition. When you set a trigger condition, the acquired data is stored in the pre-trigger region until the trigger event occurs. Thereafter, it is stored in the post-trigger region (see Figure 2-8).



**Figure 2-8: Pre- and post-trigger regions**

### Front Panel Key Lock

When controlling this instrument through GPIB, you can disable all the keys on the front panel except the power switch using the `:SYSTEM:KLOCK` command. At this time, the message “PANEL LOCK” is displayed on the top side key (see Figure 2-9).



**Figure 2-9: Key lock display**

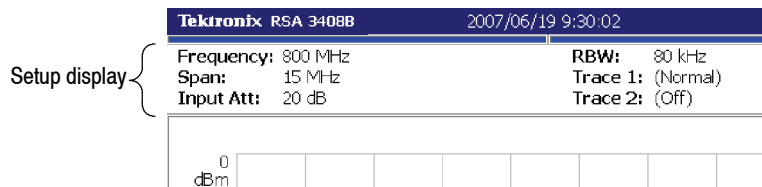
To cancel the key lock, the following two methods can be used:

- Use the `:SYSTEM:KLOCK` command to cancel.
- Turn the power off and then on.

Refer to the *RSA3000B Series Programmer Manual* for information about the GPIB commands.

**Setup Display**

The setup display area in the upper part of the screen shows the analyzer hardware settings (see Figure 2-10). The contents differ depending on the measurement mode: spectrum analysis (S/A), modulation analysis (Demod), or time analysis (Time), as shown in Table 2-3.

**Figure 2-10: Setup display****Table 2-3: Setup display**

Item	Description	Mode
Frequency	Indicates the center frequency.	All
Span	Indicates the span.	
Input Att.	Indicates the attenuation of an input signal before it enters the internal mixer.	
RBW	Indicates RBW (Resolution Bandwidth) for compatibility with swept spectrum analyzers. Refer to <i>FFT and RBW</i> on page 3-179.	S/A
NBW	Indicates NBW (Noise Bandwidth) instead of RBW when FFT-processed data does not go through RBW process.	
Trace 1 and 2	Indicates the Trace 1 and 2 trace type.	
Spectrum Length	Indicates time length of a 1024-point FFT frame. It is determined by the span.	Real Time S/A
Spectrum Interval	Indicates time interval between FFT frames. Refer to <i>FFT Start Point</i> on page 3-183.	
Acquisition Length	Indicates time to acquire a block of data. It can be set in the Acquisition/Analysis menu.	Demod and Time



# Functional Overview

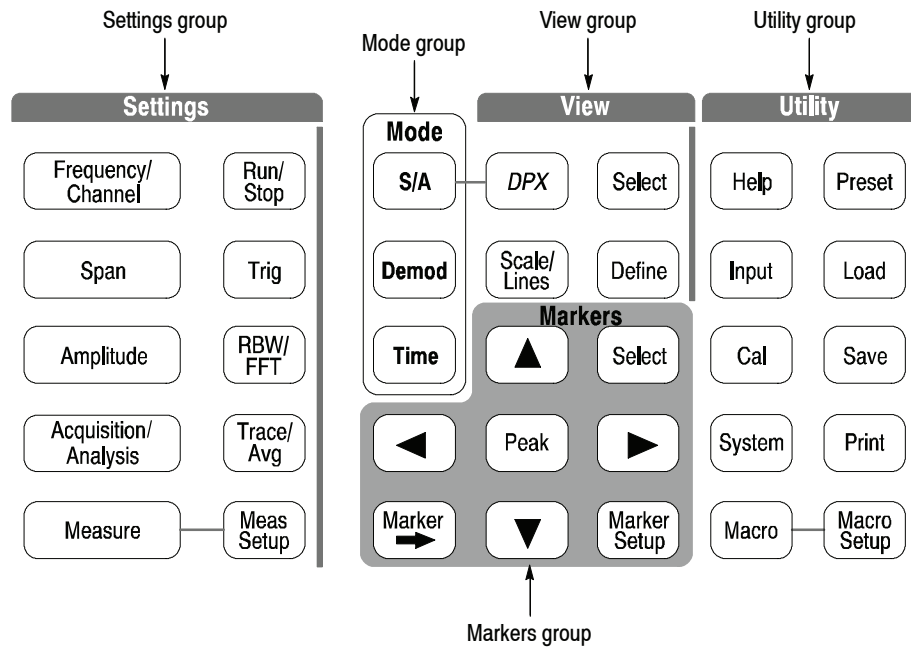
This section provides the operating fundamentals:

- Menu Keys
- Menu Operations
- Measurement Basics
- Setting System Parameters
- Using Windows XP

## Menu Keys

Menu keys on the front panel (shown in Figure 2-11 on page 2-16) are divided into the following five functional groups:

- **Settings.** Sets frequency, amplitude, and time parameters for specified measurement and controls data acquisition.
- **Mode.** Selects a measurement mode.
- **View.** Selects a view content and scales a measurement graph.
- **Markers.** Controls markers.
- **Utility.** Provides system initialization, waveform storage facilities, instrument calibration, screen hard copy, and miscellaneous other functions.



**Figure 2-11: Menu keys**



Table 2-4 summarizes the front-panel menu key functions. For details, refer to each section listed in the Reference column.

**Table 2-4: Menu key summary**

Menu group	Menu key	Function	Reference
Settings	Frequency/Channel	Sets frequency or channel.	<i>Setting Frequency and Span</i> (page 3-135)
	Span	Sets span.	
	Amplitude	Sets amplitude.	<i>Setting Amplitude</i> (page 3-143)
	Acquisition/Analysis	Sets acquisition and analysis parameters.	<i>Setting Acquisition and Analysis Parameters</i> (page 3-157)
	Run/Stop	Start or stop data acquisition.	<i>Starting/Stopping Data Acquisition</i> (page 2-24)
	Trig	Controls trigger.	<i>Trigger</i> (page 3-163)
	RBW/FFT	Sets RBW and FFT parameters.	<i>FFT and RBW</i> (page 3-179)
	Trace/Avg	Controls trace display and average function.	<i>Trace Comparison Display and Average Function</i> (page 3-191)



Table 2-4: Menu key summary (Cont.)

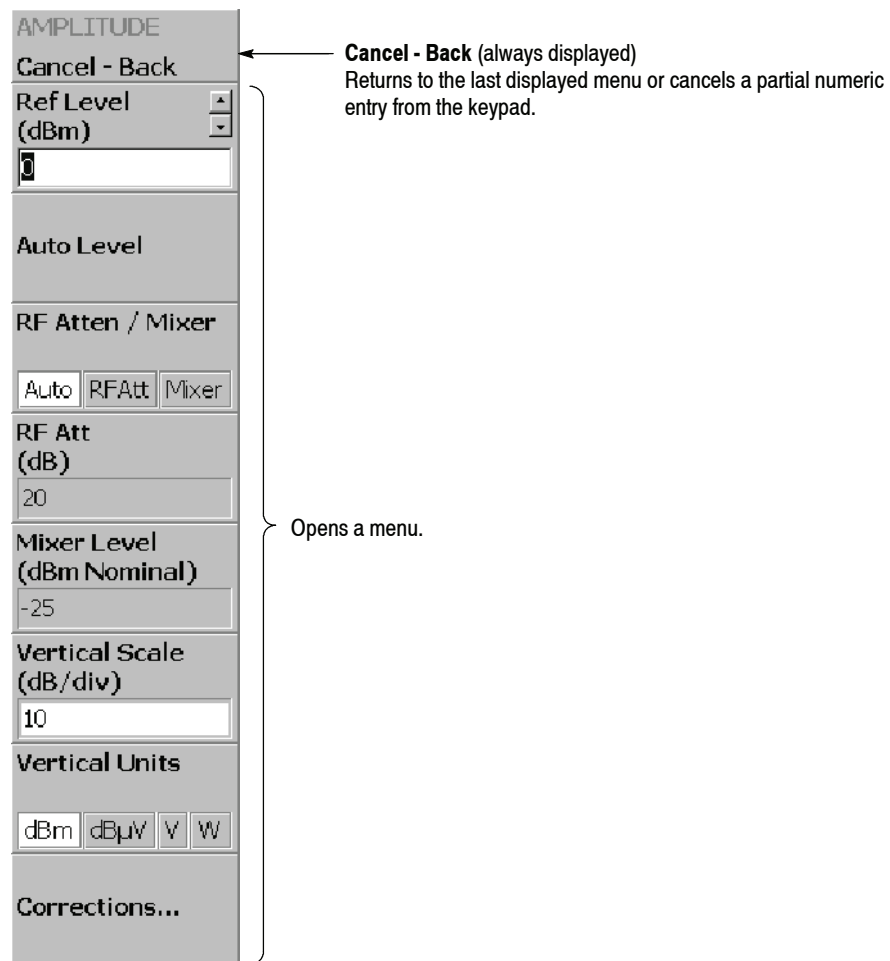
Menu group	Menu key	Function	Reference
Settings	Measure	Selects a measurement item.	<i>Spectrum Analysis (S/A Mode)</i> (page 3-1) <i>Modulation Analysis (Demod Mode)</i> (page 3-31)
	Meas Setup	Sets measurement parameters.	
Mode	S/A	Selects spectrum analysis.	<i>Time Analysis (Time Mode)</i> (page 3-99)
	Demod	Selects modulation analysis.	
	Time	Selects time analysis.	
View	DPX	Displays the DPX spectrum.	<i>DPX Spectrum Display</i> (page 3-18) <i>Setting Views</i> (page 3-203) <i>Display Line</i> (page 3-227)
	Select	Selects a view on screen.	
	Define	Sets view format.	
	Scale/Lines	Scales a graph and controls display lines.	
Markers	Peak	Searches for peak on waveform.	<i>Marker Operation and Peak Search</i> (page 3-235)
		Move the marker to the next peak.	
	Select	Selects a marker.	
	Marker 	Sets parameters based on the marker position.	
	Marker Setup	Sets marker parameters.	
Utility	Help	Displays online help.	<i>Using Online Help</i> (page 3-245)
	Input	Selects the input source.	<i>Selecting Input Source</i> (page 3-249)
	Cal	Calibrates the analyzer.	<i>Calibration</i> (page 1-23)
	System	Controls system parameters.	<i>Setting System Parameters</i> (page 2-25)
	Preset	Returns settings to the factory defaults.	<i>Restoring Default Settings</i> (page 2-24)
	Load	Load data from a file.	<i>File Operations</i> (page 3-251)
	Save	Save data to a file.	
	Print	Prints the screen image.	<i>Screen Copy</i> (page 3-283)
	Macro	Shows a menu listing all macros.	For installing macros, contact your local Tektronix sales office.
	Macro Setup	Shows a menu to configure macros.	

## Menu Operations

This section describes basic operations of the analyzer menus and how to select menu items and input numeric values.

### Menu Item Information

Up to nine soft keys can be displayed down the right side of the screen (see Figure 2-12). Cancel - Back is always displayed at the top, and the other eight keys select menu items.



**Figure 2-12: Example menu item display**

**NOTE.** When the setting is prohibited or is not available, the item is displayed in gray.

**Menu Item Types** The different types of menu items are shown in Figure 2-13.



**Numeric entry**

The current value of parameter is displayed. To change the value, press the associated side key and use the general purpose knob, up/down keys, or the keypad.



**Toggle**

You can switch selection items by pressing the associated side key.



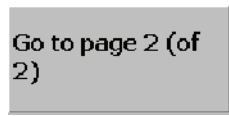
**Function execution**

The function indicated on the label is executed by pressing the associated side key. In this example, the "Channel Power" measurement is performed.



**Move to sub-menu**

If the label is followed by "...", you can move to a lower-level menu by pressing the associated side key.



**Move between pages**

When the number of menu items is greater than seven, this menu appears. To move to the next page, press the associated side key. If you are on the last page, you will return to the first page.



**Invalid**

Menu items without labels do not cause any action.

**Figure 2-13: Menu item types**

**Numeric Input**

An example numeric input field is shown in Figure 2-14. In this type of field, you can change the numeric value by turning the general purpose knob, by pressing the up/down (▲▼) keys, or by entering a value using the keypad.



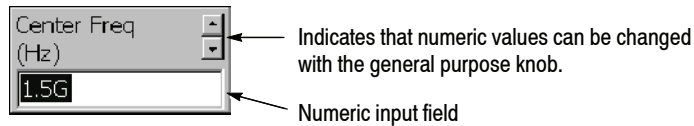
← Numeric input field

**Figure 2-14: Numeric setting menu**

**Changing a Setting Using the General Purpose Knob or the Up/Down Keys.**

1. Press the side key for setting a numeric value. For example, press **Frequency/Channel > Center Freq** to set a center frequency.

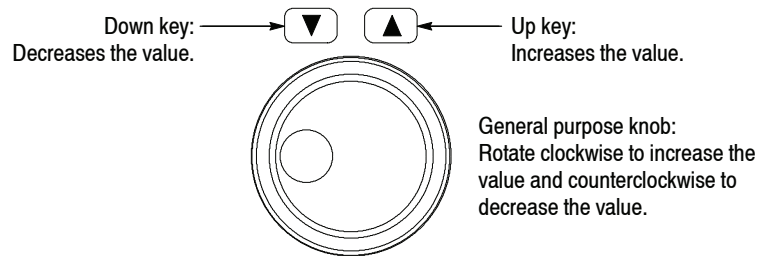
The menu item changes to the display shown in Figure 2-15.



**Figure 2- 15: Changing value with the knob**

2. Turn the general purpose knob to increase or decrease the value.

You can also use the up and down (▲▼) keys to increase or decrease a setting value, respectively.



The up and down keys have the same functions as the general purpose knob except the step size (the amount per click by which the general purpose knob changes a setting value or the amount per press for the up and down keys) as follows:

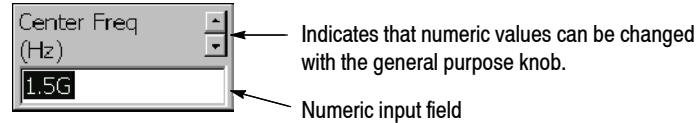
- For the general purpose knob, the step size is determined internally. You cannot change the step size.
- For the up and down keys, the step size is set with the **Step Size** side key. Refer to *Changing the Step Size* on page 2-22 for the detail.

The changed value is immediately reflected on the analyzer settings and displays.

**Entering a Value Using the Keypad.** You can enter values using the front panel keypad, shown in Figure 2-17.

1. Press the side key for setting a numeric value. For example, press **Frequency/Channel > Center Freq** to set a center frequency.

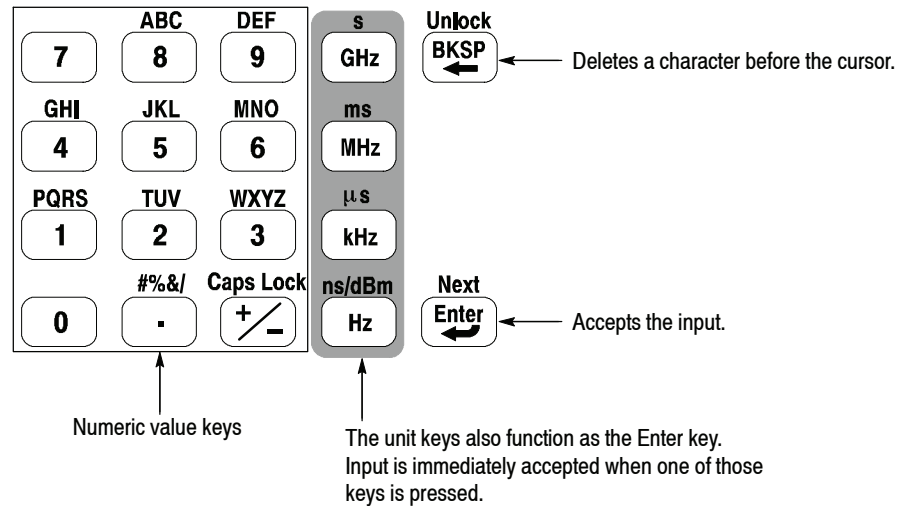
The menu item changes to the display shown in Figure 2-16.



**Figure 2-16: Changing value with the keypad**

2. Press the keys required to enter the desired numeric value. For example, to enter the frequency 123.45 MHz, press **1 2 3 . 4 5 MHz**.

To delete an entered number, press the **BKSP** (Backspace) key.



**Figure 2-17: Numeric keypad**

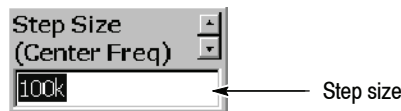
3. Confirm the input by pressing the unit key or **Enter** key. The confirmed value is immediately reflected to the analyzer settings and display.

Press the **Cancel - Back** side key to cancel the change.

### Changing the Step Size

When using the up and down (▲▼) keys to increase or decrease a setting value, you can change the step size (the amount per press by which the up or down key changes the setting value) with the **Step Size** side key. (The step size cannot be changed for menu items that do not display **Step Size**.)

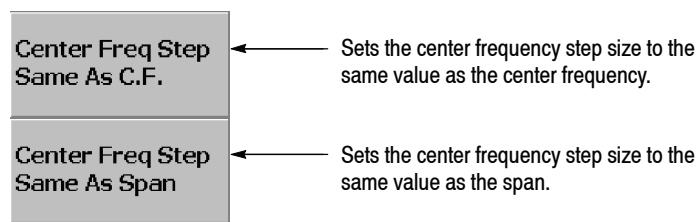
In the example shown in Figure 2-18, the step size for the center frequency is set to 100 kHz; the displayed frequency set value changes by 100 kHz step for each press of the up or down key.



**Figure 2-18: Step size for the center frequency**

**Step Size for Center Frequency.** The step size is set with the **Step Size** side key. The center frequency step size can be also set with two side keys in the Frequency/Channel menu (see Figure 2-19 below).

- **Center Freq Step Same As C.F.** Useful for quickly locating harmonics of a signal seen at the center frequency.
- **Center Freq Step Same As Span.** Useful for quickly analyzing a larger frequency area without overlapping span windows.



**Figure 2-19: Changing the step size to the predetermined values**

## Measurement Basics

### Selecting the Measurement Mode

When you start a measurement, first select the measurement mode. For details on each mode, refer to the section shown in Table 2-5.

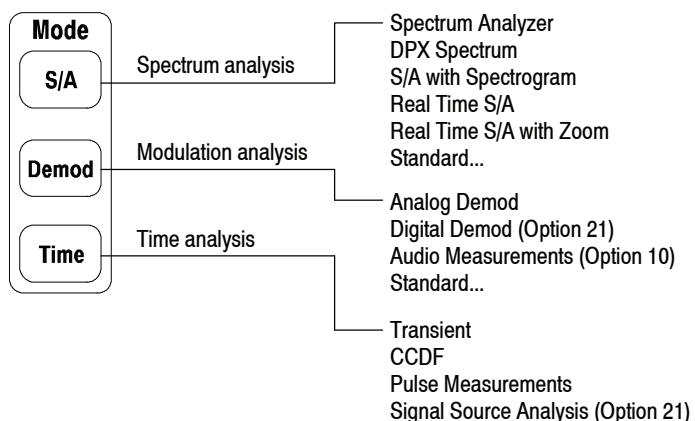


Figure 2-20: Selecting the measurement mode

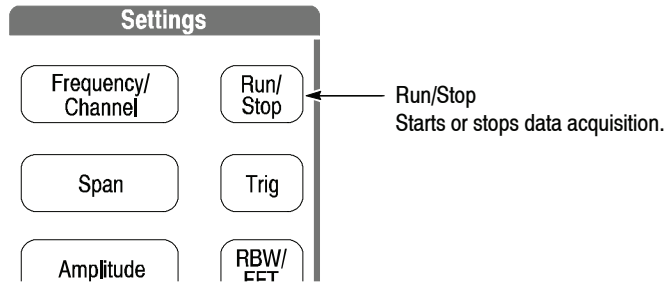
Table 2-5: Measurement modes

Menu key	Measurement mode	Description	Reference
Spectrum analysis			
S/A	Spectrum Analyzer	General spectrum analysis	<i>Spectrum Analysis (S/A Mode)</i> page 3-1
	DPX Spectrum	DPX (Digital Phosphor) Spectrum analysis	
	S/A with Spectrogram	Spectrum analysis with spectrogram	
	Real Time S/A	Real-time spectrum analysis	
	Real Time S/A with Zoom	Real-time spectrum analysis with zoom function	
	Standard... <sup>1</sup>	Communication standard specific analysis	
Modulation analysis			
Demod	Analog Demod	Analog modulation analysis	<i>Modulation Analysis (Demod Mode)</i> page 3-31
	Digital Demod	Digital modulation analysis (Option 21)	
	Audio Measurements	Audio measurements (Option 10)	
	Standard... <sup>1</sup>	Communication standard specific analysis	
Time analysis			
Time	Transient	Time characteristics analysis	<i>Time Analysis (Time Mode)</i> page 3-99
	CCDF	CCDF analysis	
	Pulse Measurements	Pulse characteristics analysis	
	Signal Source Analysis	Signal source analysis (Option 21)	

<sup>1</sup> Contains optional analysis functions. Refer to *Appendix G: Options and Accessories* for optional software.

### Starting/Stopping Data Acquisition

Use the **Run/Stop** key on the front panel to start or stop data acquisition.

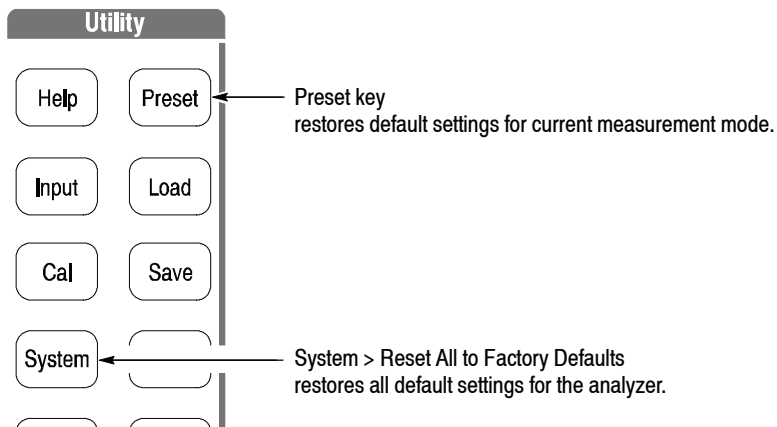


**Figure 2-21: Starting/Stopping data acquisition**

If acquisition and measurements are waiting for a trigger, or are paused/stopped, pressing this key will start the acquisition. If acquisition and measurements are running, pressing this key will stop acquisition and measurements, aborting the current acquisition.

### Restoring Default Settings

The analyzer saves the settings when it is turned off. When you turn on the analyzer, it starts with the settings as they were when it was shut down.



**Figure 2-22: Restoring default settings**

- Pressing the **Preset** key returns the instrument settings to the factory defaults for the current measurement mode.
- Pressing **System > Reset All to Factory Defaults** sets all parameters for all measurements and modes to the default values.



## Setting System Parameters

The System menu sets system-wide parameters such as the display brightness, factory defaults, and GPIB address.

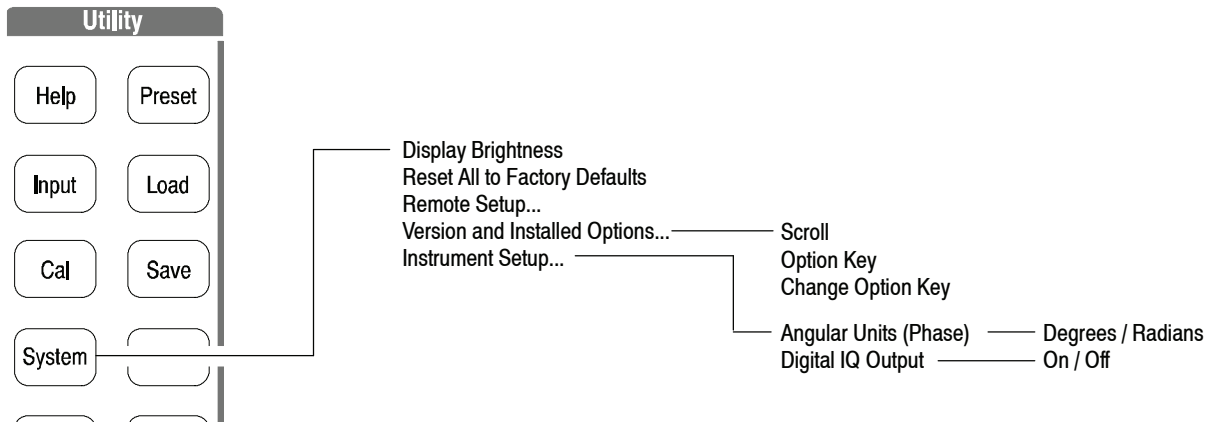


Figure 2-23: System menu

### System Menu

The System menu contains the following controls:

**Display Brightness.** Adjusts the brightness of display. Setting range: 0 to 100.

**Reset All to Factory Defaults.** Sets all parameters for all measurements and modes to the default values.

**Remote Setup...** Sets GPIB parameters. Refer to the *RSA3000B Series Programmer Manual* for details.

**Versions and Installed Options.** Displays the current versions of all standard and optional software, and any third party software licenses. Refer to page 2-26 for information about displaying versions and installed options.

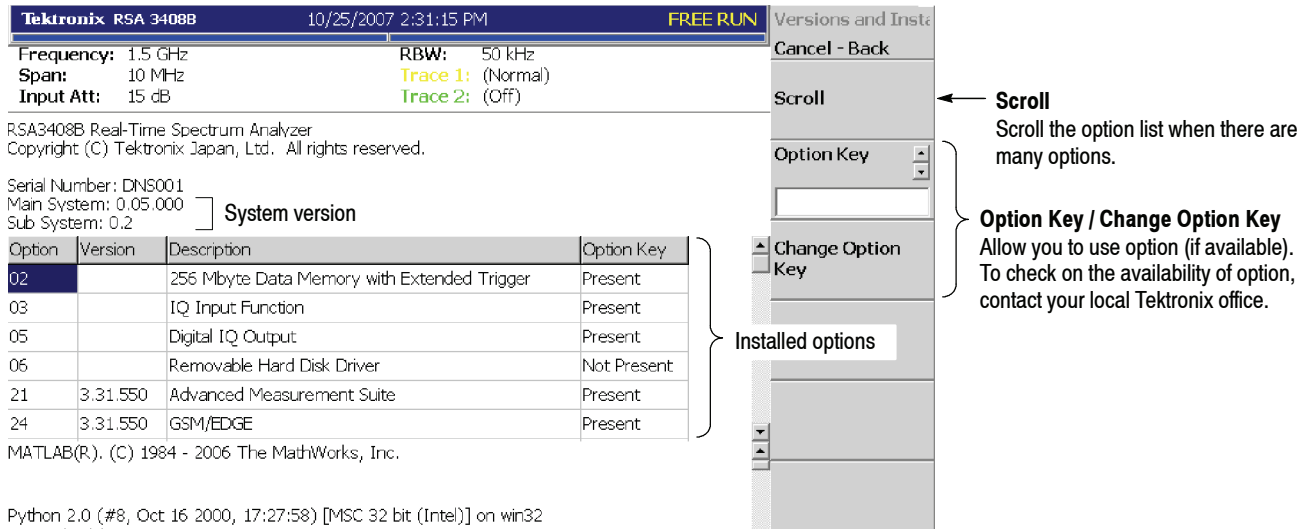
**Instrument Setup...** Sets the fundamental parameters for measurements.

- **Angular Units.** Selects degree (default) or radian for the angular unit.
- **Digital IQ Output.** *Option 05 Only.* Turns on or off the digital IQ output from the rear panel connectors.

### Displaying Versions and Installed Options

You can see the system versions and installed options. For information on options for the analyzer, refer to *Appendix G: Options and Accessories*.

1. Press the **System** key on the front panel.
2. Press the **Versions and Installed Options...** side key.  
The screen appears as shown in Figure 2-24.



**Figure 2-24: Displaying versions and options**

The following information is shown on the screen:

- **Version**
  - Main System: Basic application software version
  - Sub System: Firmware version

- **Option**

The table shows version and name of the option installed. The “Option Key” field tells you the following information:

- Present: Indicates that you can use the option.
- Not Present: Indicates that you cannot use the option.  
For information about how to remove the protection and use the option, refer to *Enabling the Option*.

3. To exit the version display, press any front-panel key.

**Enabling the Option.**

1. Contact your local Tektronix office to order the option. You will receive an option key (alphanumeric code).
2. Press the **Option Key** side key (see Figure 2-24) and enter the option key using the alphanumeric keypad on the front panel.

---

**NOTE.** To input “-” (hyphen), press the “.” (period) key.

---

3. Press the **Change Option Key** side key to accept the input.

Now you can use the option on the analyzer.

## Using Windows XP

This analyzer operates under Windows XP. You can switch to a Windows XP desktop screen or execute a Windows XP application program.

### Displaying the Windows Desktop

To display the Windows desktop screen, follow these steps:

1. Connect a USB mouse and keyboard to the analyzer. For the USB connectors on the side panel, see Figure 2-3 on page 2-6.
2. Use a mouse to move the pointer to the bottom of screen (see Figure 2-25). The task bar appears.
3. Locate the pointer on the **RSA3408B** icon in the task bar and right-click. A menu appears.
4. Select **Close** from the menu. The analyzer system program terminates and the Windows XP desktop screen appears.

**Switching from Windows Desktop to the Analyzer View.** To switch from the Windows desktop screen to the analyzer view display, from the task bar, select **Start > Program > TEK RTSA**. The analyzer program starts.

### Starting Windows XP Applications

When you use a mouse to move the pointer to the bottom of screen, a task bar appears (see Figure 2-25). The task bar contains Start and the analyzer application icons. Follow the Windows XP operating procedure and access Windows applications using the Start menu.

### Setting Date and Time

The screen displays the date and time managed by the Windows XP operating system. You can use the Windows time setting program to set the date and time.

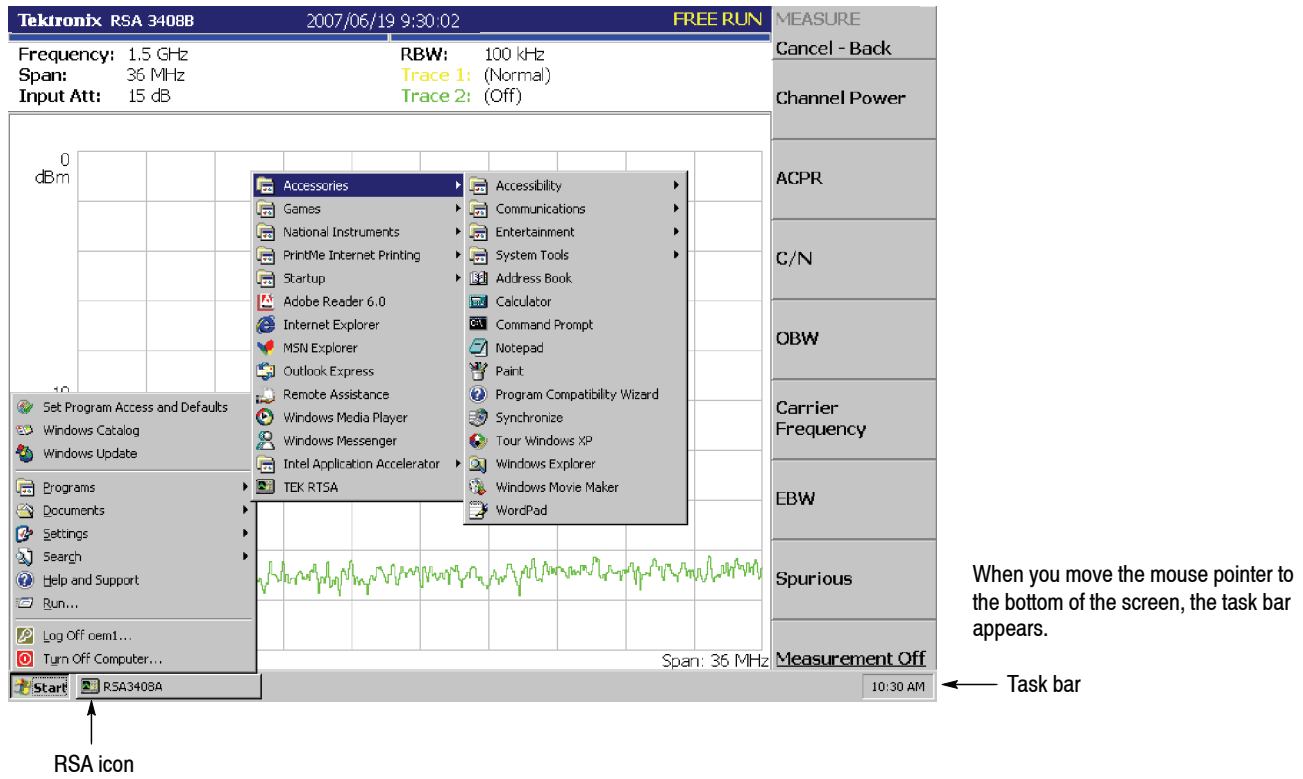


Figure 2- 25: Displaying the Windows XP accessory menu

# Tutorial

This section provides some basic procedures such as applying power, displaying the results of measurements, and shutting off the analyzer. This section uses default settings in most examples.

- Preparations: Connecting devices and applying the power
- Displaying spectrum
- Using markers and peak search
- Using averaging and comparison displays
- Displaying DPX spectrum
- Displaying spectrogram
- Spectrum analysis
- Modulation analysis
- Turning off the power

---

**NOTE.** *You must complete the installation procedures (starting on page 1-11) before performing any of the following steps.*

---

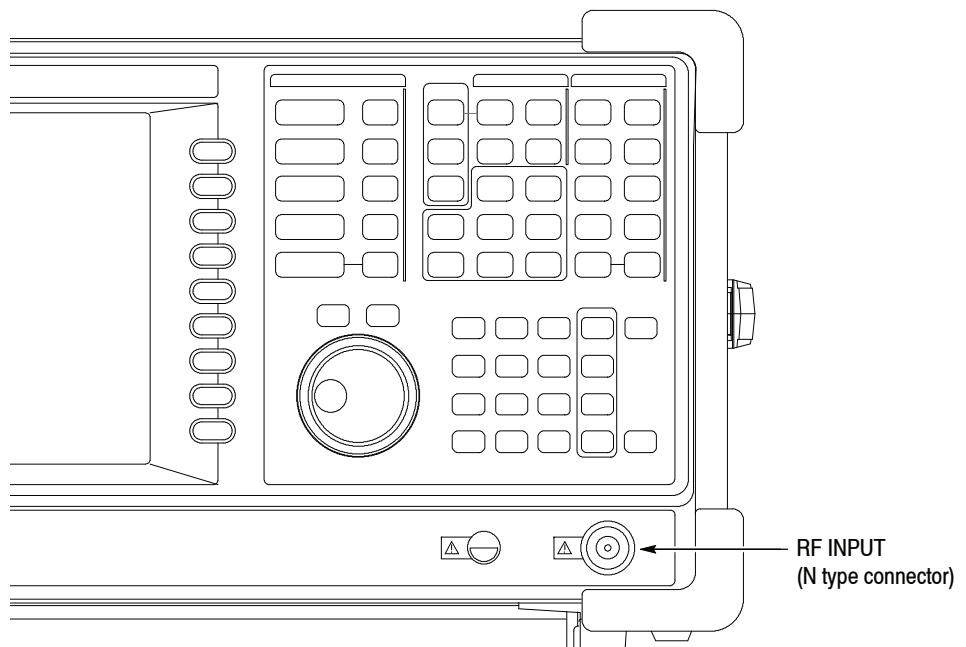
## Preparations

This tutorial uses a digitally modulated signal. The following equipment is used as a signal source:

- Analog signal generator (example: HP8657B)
- One 50  $\Omega$  coaxial cable

### Connecting the Signal Generator

1. Connect the output of the signal generator to the RF INPUT connector on the analyzer front panel using a coaxial cable (see Figure 2-26).



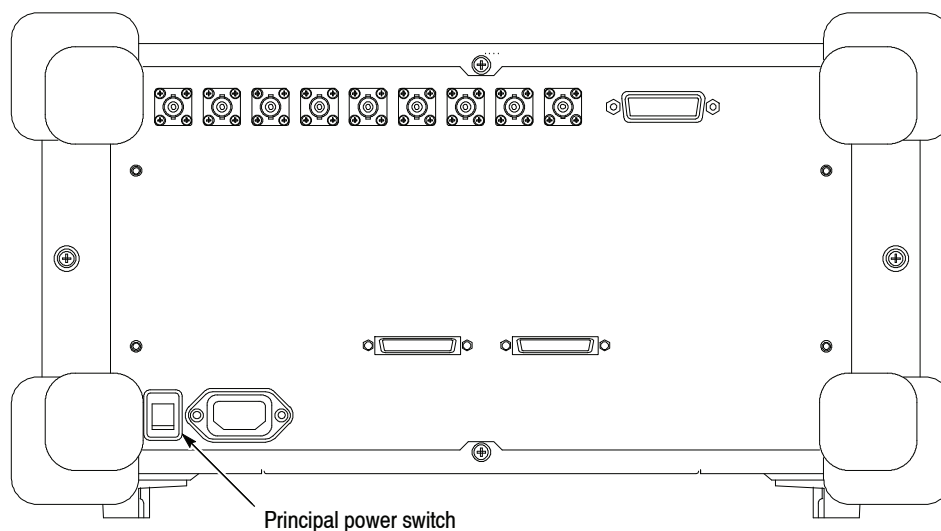
**Figure 2-26: Cable connection**

2. Set the signal generator as follows:

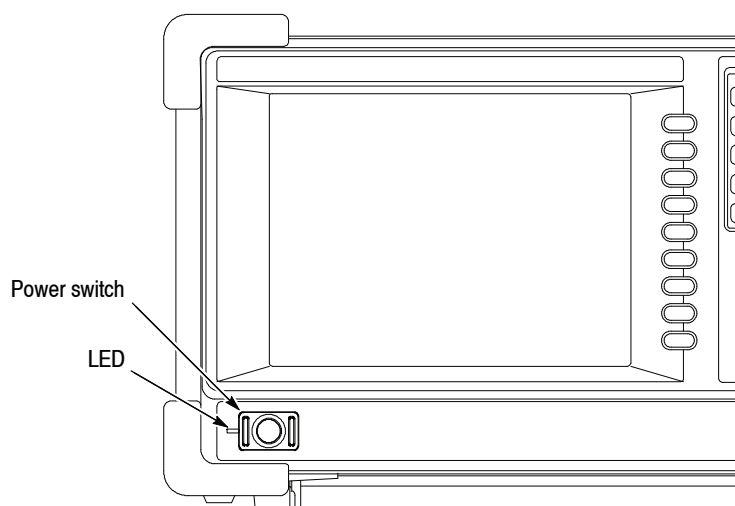
Center frequency	.....	100 MHz
Output level	.....	-10 dBm
Modulation type	.....	AM
Modulation source	.....	Internal 10 kHz
Modulation depth	.....	50%

**Applying the Power**

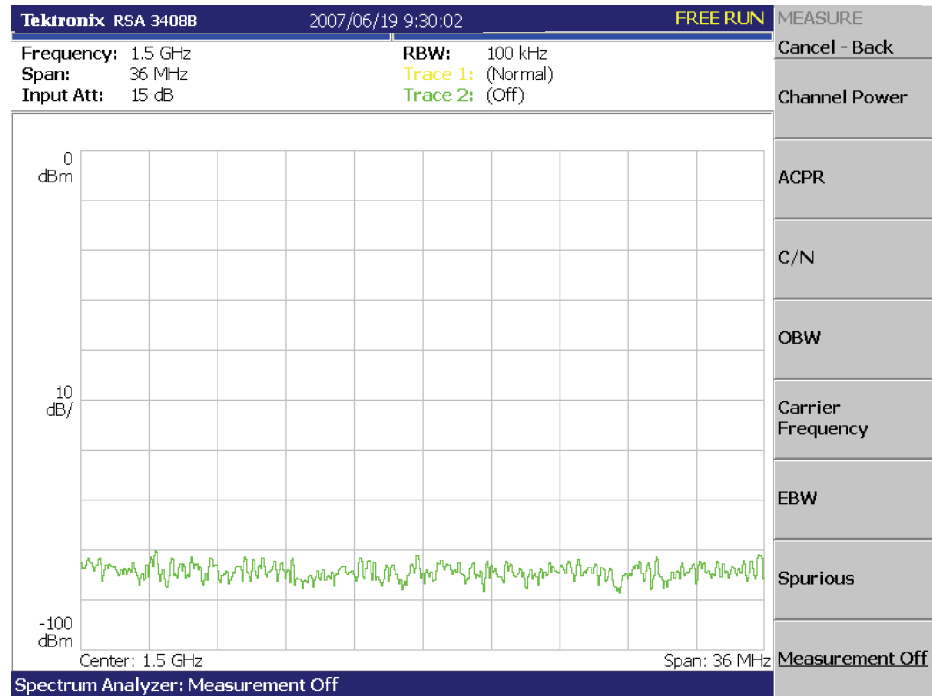
1. Apply power to the signal generator.
2. Turn on the principal power switch (**PRINCIPAL POWER SWITCH**) on the rear panel, as shown in Figure 2-27. The orange LED on the front panel lights.

**Figure 2-27: Principal power switch (rear panel)**

3. Turn on the power switch (On/Standby) on the front panel, as shown in Figure 2-28.

**Figure 2-28: Power switch (On/Standby)**

The initial screen shown in Figure 2-29 appears after Windows XP starts up (the background color is in white in this manual to make figures more viewable).



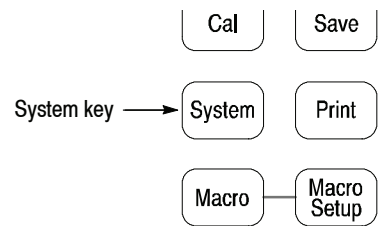
**Figure 2-29: Initial screen**

### Restoring Default Settings

The analyzer saves the settings when it is turned off. When you turn on the analyzer, it starts with the settings as they were when it was shut down.

This tutorial starts with the factory default settings. Perform the following steps to restore the factory default settings:

1. Press the **System** key.



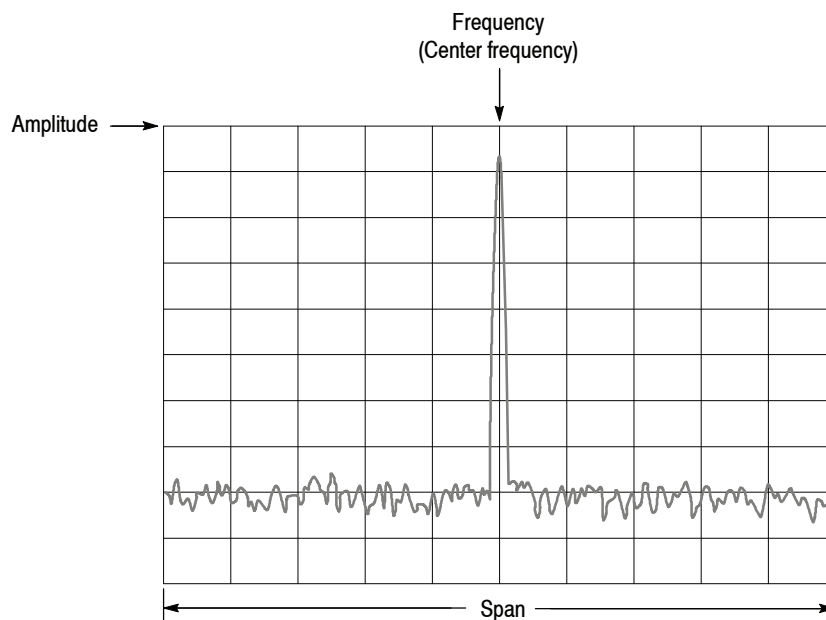
2. Press the **Reset All to Factory Defaults** side key.

The instrument is now ready to take measurements.



## Displaying Spectrum

This section describes how to set the frequency, span, and amplitude, and then appropriately display the spectrum. Figure 2-30 shows the settings.

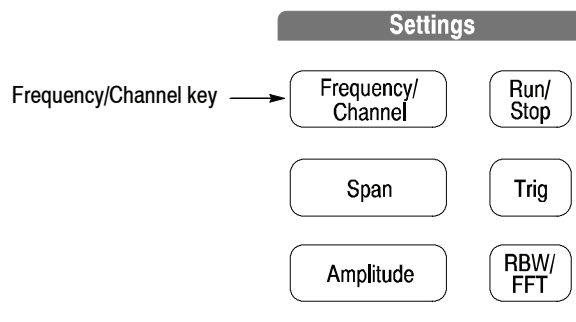


**Figure 2-30: Frequency, span, and amplitude settings**

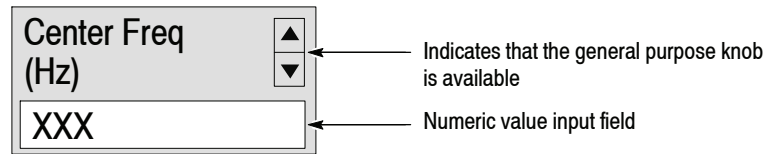
### Setting Center Frequency and Span

The center frequency is set to 1.5 GHz, and span is set to 36 MHz when you power on the analyzer. Change the settings of center frequency and span to display the waveform around 100 MHz.

1. Press the **Frequency/Channel** key on the front panel.



The Frequency/Channel menu, shown in Figure 2-31, is displayed on the right side of the screen. Notice that the Frequency menu item is available for entering the numeric value for center frequency.



**Figure 2-31: Menu items for numeric value input**

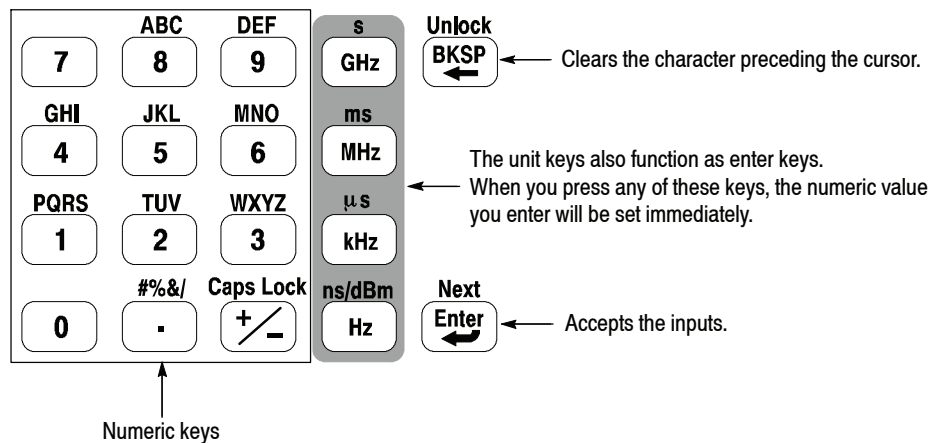
You can change the value using the general purpose knob or enter the value using the numeric value entry keypad, shown in Figure 2-32.

2. Enter the new center frequency at 100 MHz. Because the interval between 1.5 GHz (current setting) and 100 MHz is wide, it is more convenient to use the keypad here.

Press **1 0 0 MHz**, in order, on the keypad.

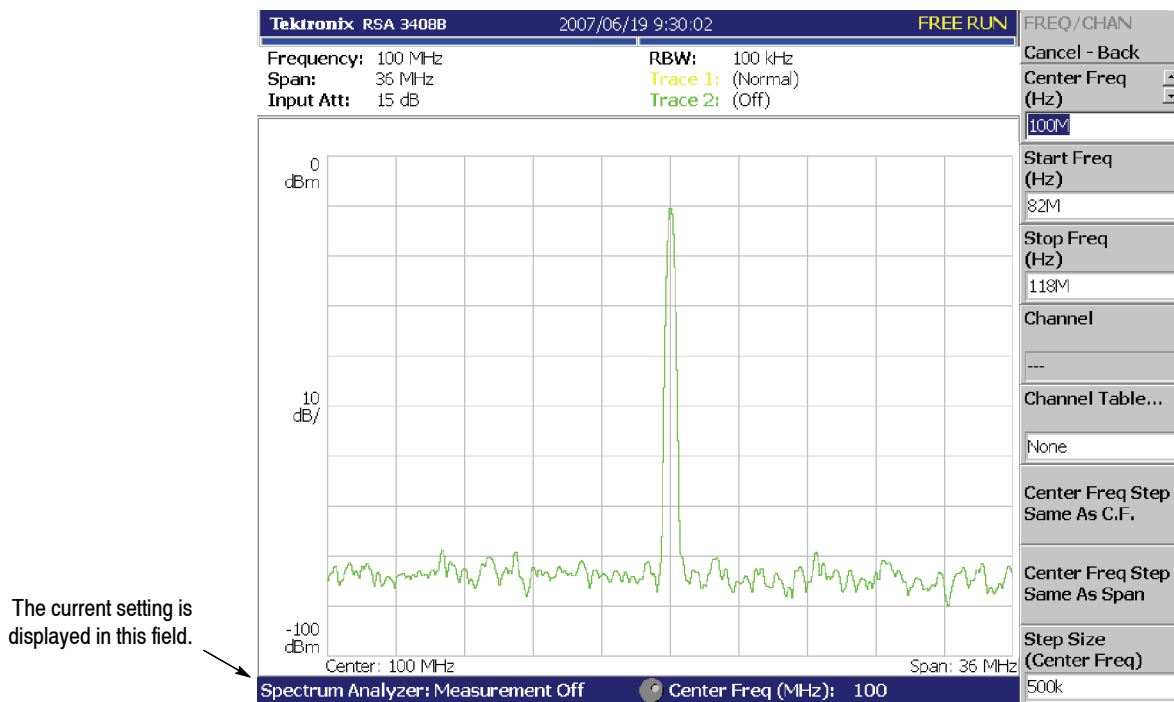
The **GHz**, **MHz**, **kHz**, and **Hz** keys also function as enter keys. When you press any of these keys, the numeric value you enter will be set immediately.

If you enter incorrect values, clear them using the **BKSP** (back space) key and then enter the correct digit.



**Figure 2-32: Numeric value entry keypad**

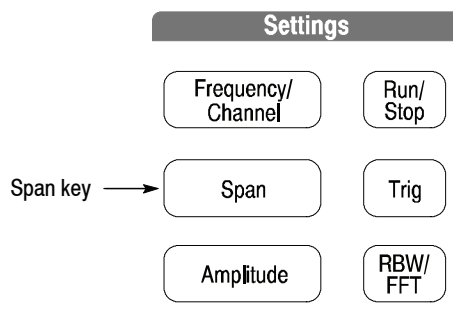
The spectrum waveform is displayed on the screen as shown in Figure 2-33. The current setting is displayed on the bottom of the screen (“Center Freq (MHz): 100” in this example).



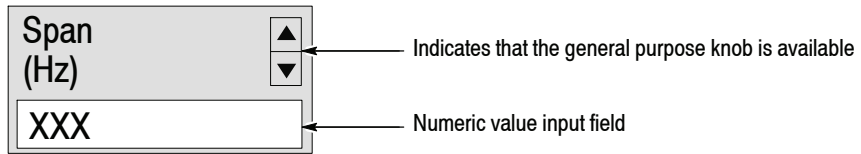
**Figure 2-33: Center frequency of 100 MHz, span of 36 MHz**

The next step is to set the span. It is currently set to 36 MHz as the default value. Change the setting to 20 kHz.

3. Press the **Span** key on the front panel.

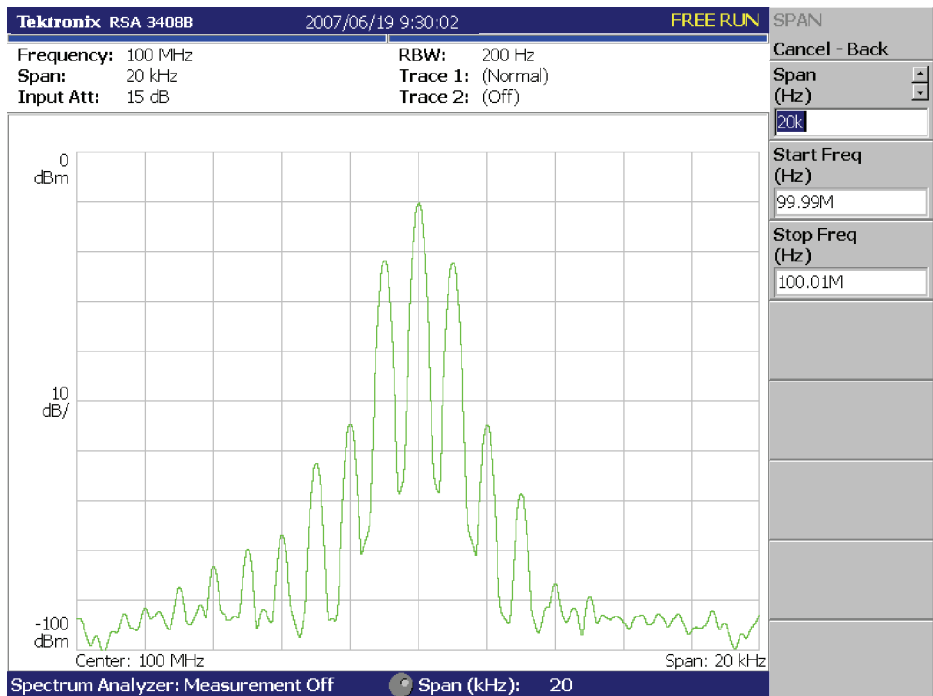


The **Span** menu item is selected.



4. Turn the general purpose knob to the left to select **20k**.  
The hardware is set with the selected value immediately.

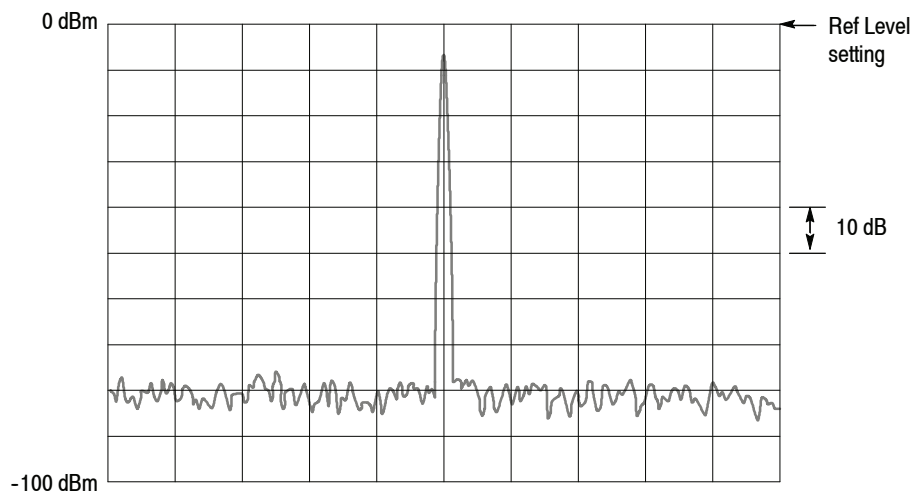
The spectrum waveform is displayed on the screen as shown in Figure 2-34.



**Figure 2-34: Center frequency of 100 MHz, span of 20 kHz**

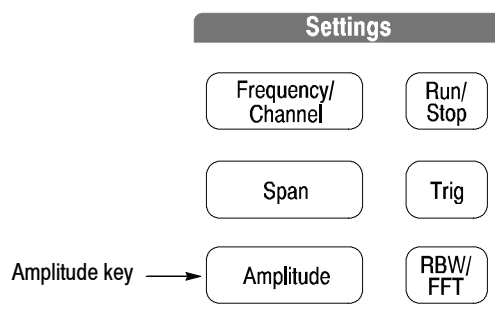
### Setting Up Amplitude

In Figure 2-35, the vertical scale shows the spectrum view, set up for 10 dB per division. Ref level is the maximum value of the vertical axis, and it is set to 0 dBm when the analyzer is powered on. Observe the change in the waveform as you change this setting in the following procedure:

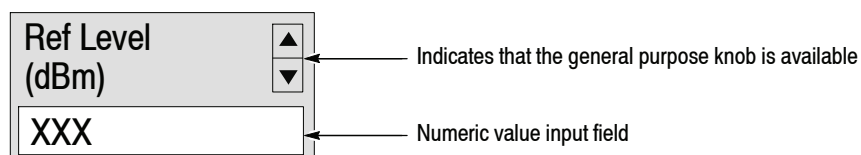


**Figure 2-35: Setting amplitude**

1. Press the **Amplitude** key on the front panel.



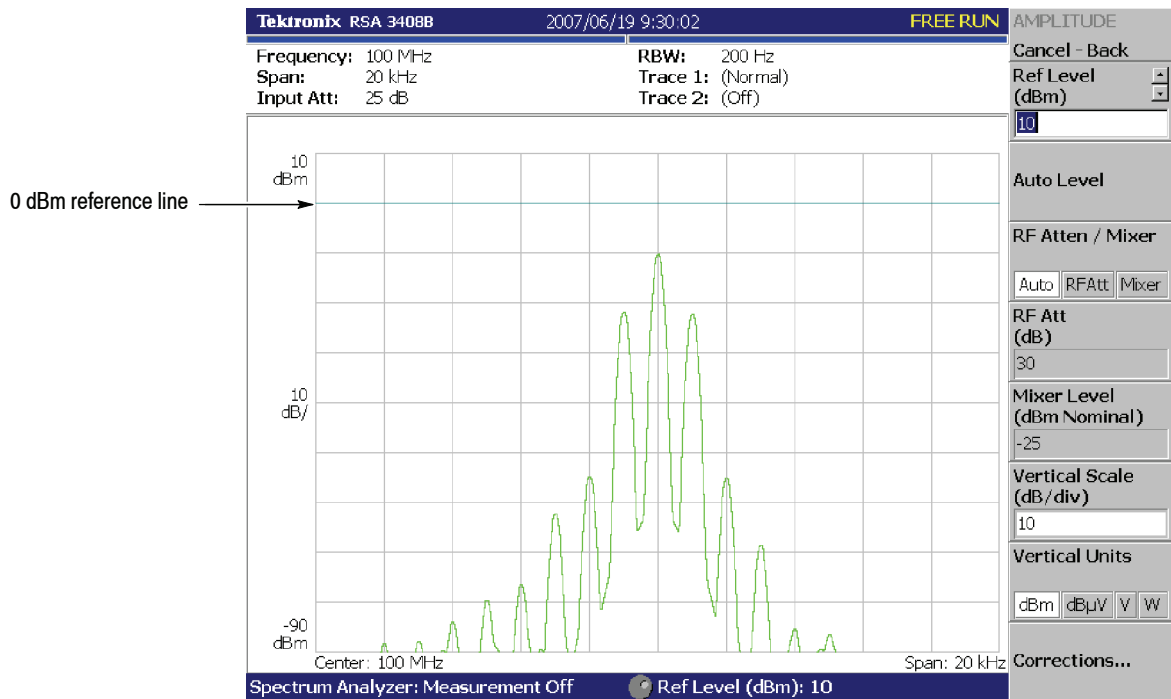
The Amplitude menu is displayed on the right side of the screen. Notice that the Ref Level item is available for entering amplitude.



2. Observe the changes in the waveform as you turn the general purpose knob.
  - As you turn the knob to the right, the amplitude increases and the waveform shifts to a relatively lower position.
  - As you turn the knob to the left, the amplitude decreases and the waveform shifts to a relatively higher position.

In Figure 2-36, the amplitude is set to 10 dBm. When the amplitude is set to 0 dBm or higher, a blue standard line is displayed indicating 0 dBm.

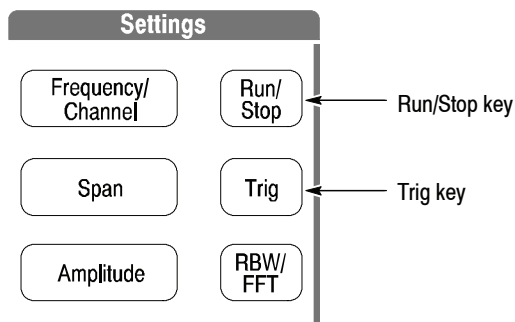
3. Set the Ref Level back to 0 dBm after confirming the amplitude operation.



**Figure 2-36: Reference level of 10 dBm**

## Starting and Stopping Data Acquisition

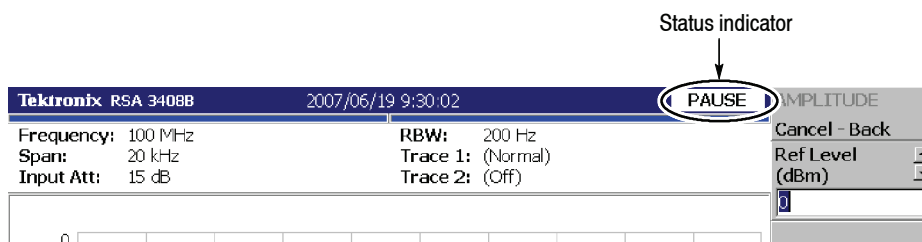
Use the **Run/Stop** key to start or stop data acquisition. There are two acquisition modes: the continuous mode, in which data is acquired repeatedly, and the single mode, in which one waveform is acquired. You can select the mode using the Trig menu.



By default, the analyzer is now acquiring data in the continuous mode.

1. Press the **Run/Stop** key to stop data acquisition.

When acquisition stops, “PAUSE” is shown in the status indicator on screen (see Figure 2-37).



**Figure 2-37: Status indicator**

2. Acquire data in the single mode using the following steps:
  - a. Press the **Trig** key on the front panel.
  - b. Press the **Repeat...** side key and select **Single**.
  - c. Press the **Run/Stop** key to acquire data. One waveform is acquired and displayed every time you press the key.
3. Press the **Repeat...** side key again and select Continuous to return to the continuous mode.

When acquisition starts, “READY” is displayed in the status indicator, indicating that the analyzer is ready for trigger.

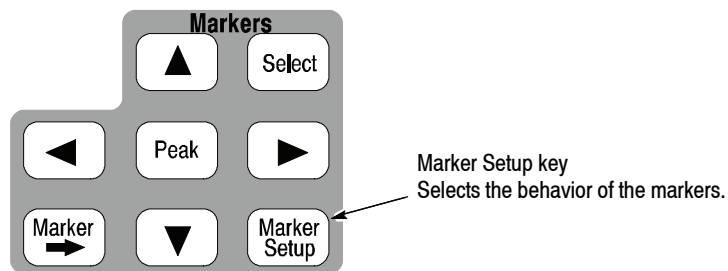
## Using Markers and Peak Search

The markers are used to measure amplitude or frequency (and also to find the peak signal).

One or two markers can be displayed as Marker 1 and 2. To measure an absolute value, only Marker 1 is used, and that is called “single marker mode.” To measure a relative value, Markers 1 and 2 are used, and that is called “delta marker mode.” To position the markers, use the general purpose knob or the numeric input keypad.

### Measuring with a Single Marker

1. Press the **Marker Setup** key on the front panel.



2. Press the **Markers** side key to select **Single**.

The marker (□) appears at center on the waveform.

3. The **Marker X Position** menu item is selected by default. Turn the general purpose knob to move the marker to a measurement point (see Figure 2-38).

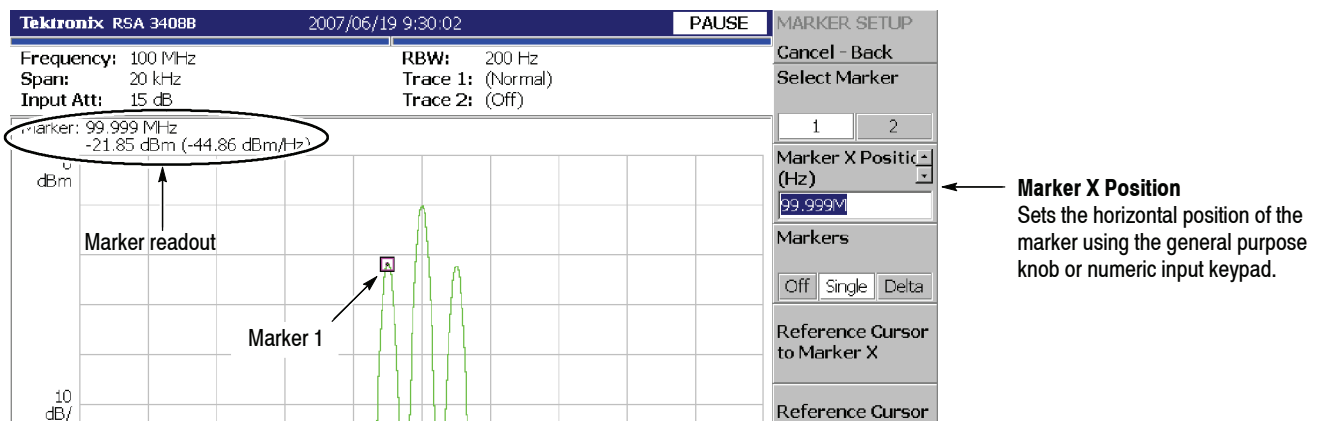


Figure 2-38: Measurement with a single marker



### Measuring Difference with Delta Marker

Turn on Marker 1 and 2 to measure the difference in amplitude and frequency. On the screen, the “□” symbol represents the active marker and “◇” represents the fixed marker. You can operate only the active marker.

1. Press the **Marker Setup** key on the front panel.
2. Press the **Markers** side key to select **Delta**.

The fixed marker (◇) appears at the active marker position.

3. Make sure that **1** (Marker 1) is selected in the **Select Marker** menu item. This means that Marker 1 is the active marker.
4. The **Marker X Position** menu item is selected. Using the general purpose knob or the numeric input keypad, move the marker to a reference point (see Figure 2-39).

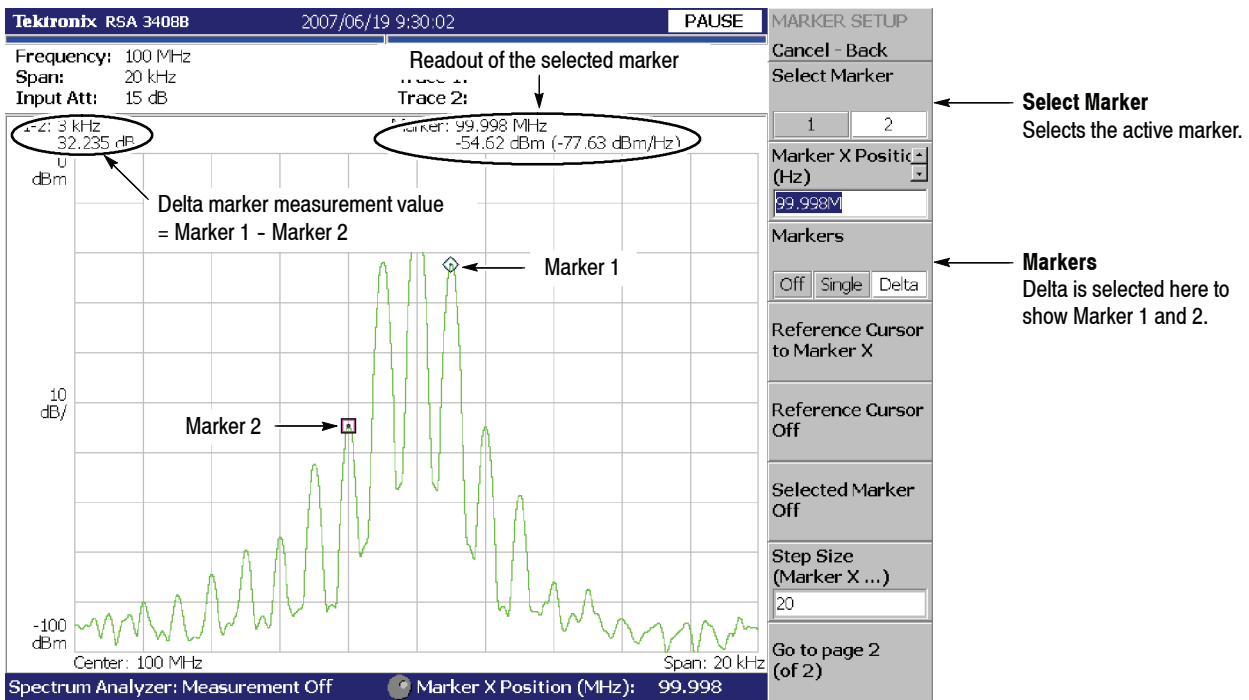


Figure 2-39: Measurement with the delta marker

5. Press the **Select Marker** side key (top) to select **2**, making Marker 2 active.

You can also select the marker using the Markers: **Select** key on the front panel. The Markers: **Select** key and the **Select Marker** side key have the same function.

6. The **Marker X Position** menu item is selected. Using the general purpose knob or the numeric input keypad, move the marker to the desired measurement point (see Figure 2-39).

The difference between the two marker positions (Marker 1 - Marker 2) is indicated in the upper left part of the screen.

7. Press the **Markers** side key to select **Single**.

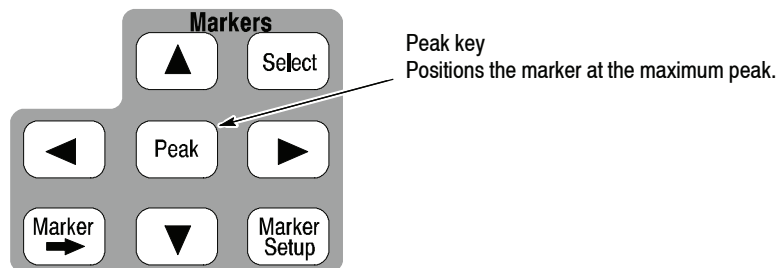
The analyzer returns to the single marker mode.

### Searching for the Peak

Measure the frequency interval between the maximum intensity spectrum and a peak to its left by using the delta marker and peak search functions together.

1. Press the **Peak** key on the front panel.

Marker 1 moves to the maximum intensity spectrum.



2. Press the **Markers** side key to select **Delta**.

The fixed marker ( $\diamond$ ) appears at the active marker position.

3. Press the **Select Marker** side key to select **2**, making Marker 2 active.
  - a. Press the marker right key ( $\blacktriangleright$ ) to move the marker to the next signal peak to the right. Try it several times.
  - b. Press the marker left key ( $\blacktriangleleft$ ) to move the marker to the next signal peak to the left. Try it several times.
  - c. Using the marker left or right key, move the marker to the peak that you want to measure.

The difference between the two marker positions is shown in the upper left part of the screen (see Figure 2-40).

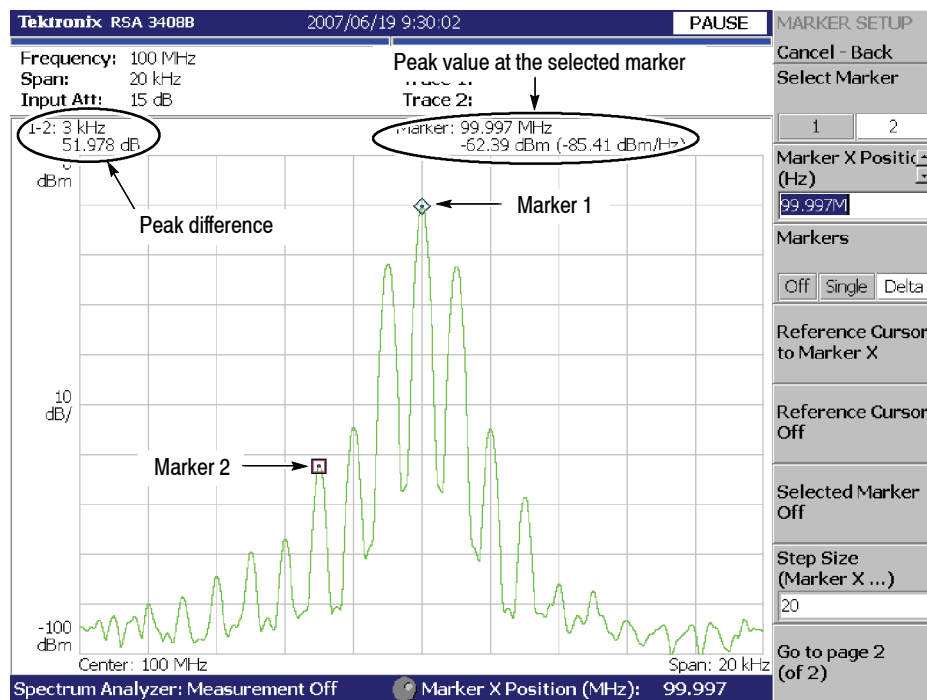


Figure 2-40: Searching for the peak

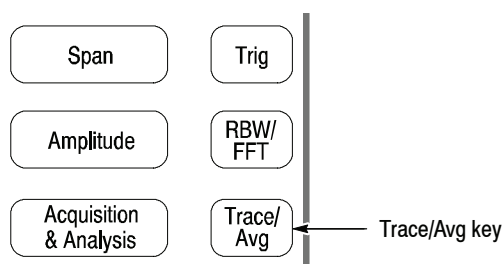
4. Press the **Markers** side key to select **Off**. Both markers disappear.

## Using Averaging and Comparison Displays

This section describes how to use the averaging function, which displays the waveform with reduced noise. The averaged waveform can be displayed with the original waveform.

**Averaging** There are several averaging methods; select RMS (Root-Mean-Square) in this example.

1. Press the **Trace/Avg** key.



2. Press the **Trace Type** side key to select **Average**.
3. Press the **Number of Averages** side key to specify how many traces are accumulated to create the averaged waveform.

In this example, enter 64 with the numeric keypad.  
Press **6 4 Enter** in order.

4. Press the **Run/Stop** key on the front panel to acquire the waveform.

The averaged waveform is displayed on the screen. The average count is shown in the upper right part of the screen (see Figure 2-41). When the waveform is acquired in the free run mode, the averaging is done with exponential RMS (root-mean-square). This method continues the average with an exponential weighting applied to old values, using the number of averages (64 in this example) as the weighting factor.

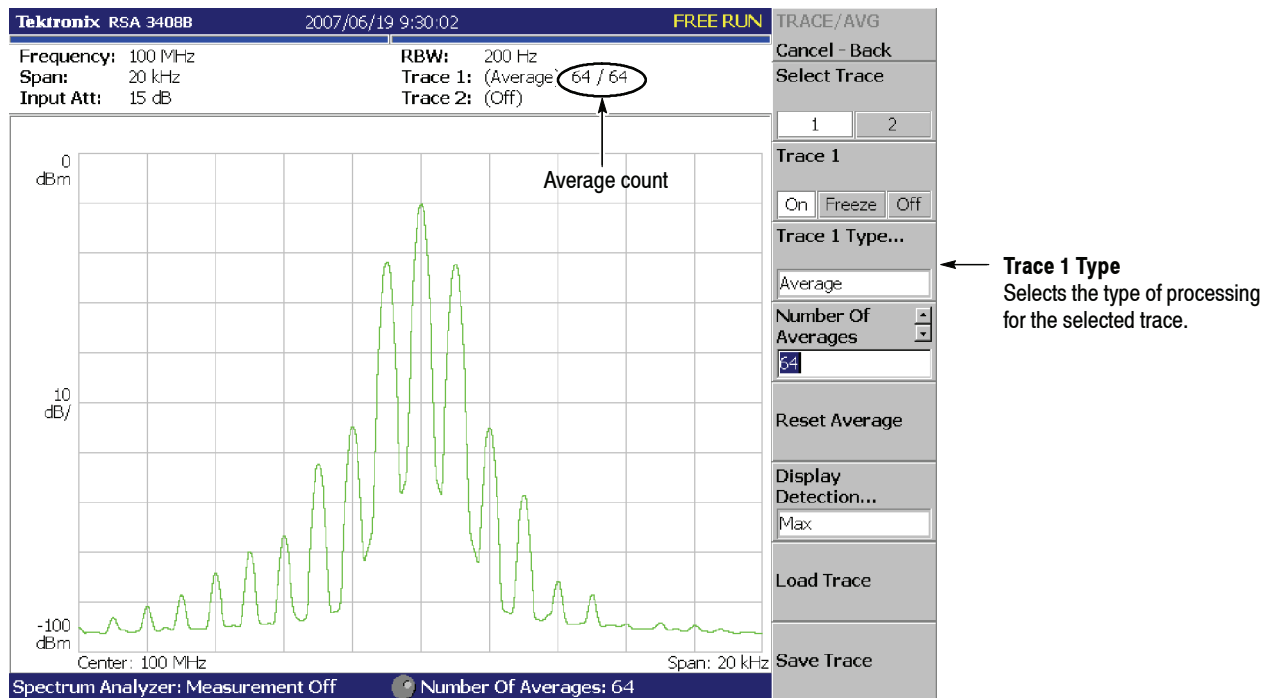


Figure 2-41: Averaging a waveform

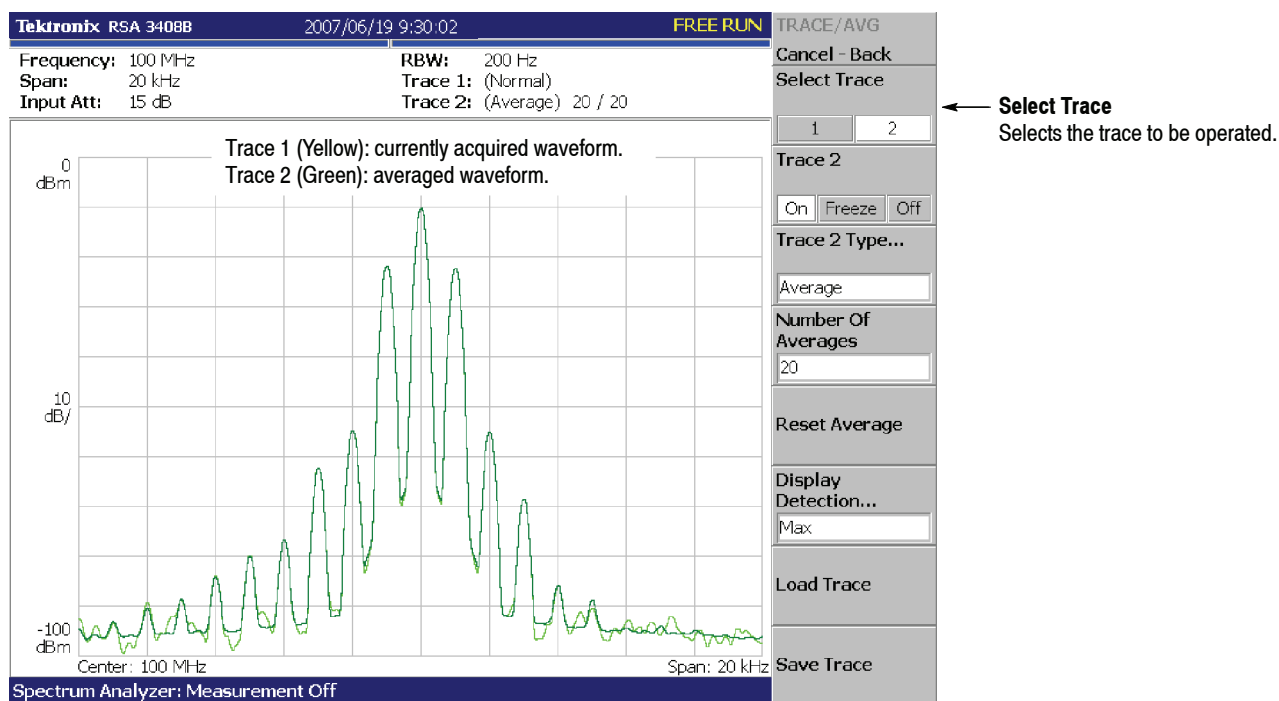
5. Press the **Reset Average** side key to restart averaging.

## Comparison Display

You can display two different types of traces concurrently on the screen. In this procedure, you will display the currently acquired waveform and an averaged waveform for comparison.

1. Press the **Trace/Avg** key on the front panel.
2. Make sure that **1** (Trace 1) is selected in the **Select Trace** menu item.
3. Press the **Trace Type...** side key and select **Normal** to define Trace 1 as the currently acquired waveform.
4. Press the **Select Trace** side key to select **2** (Trace 2).
5. Press the **Trace 1 Type...** side key and select **Average** to define Trace 2 as the averaged waveform.
6. Press the **Run/Stop** key on the front panel to acquire a waveform.

The currently acquired waveform (Trace 1 in yellow) is displayed with the averaged waveform (Trace 2 in green). See the display in Figure 2-42.



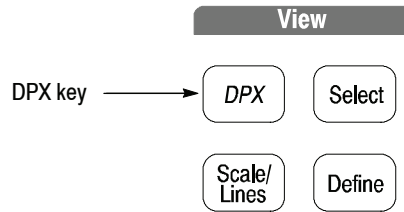
**Figure 2-42: Comparison display with averaged waveform**

7. Press the **Trace 2 Type...** side key again and select **Off** to remove Trace 2.

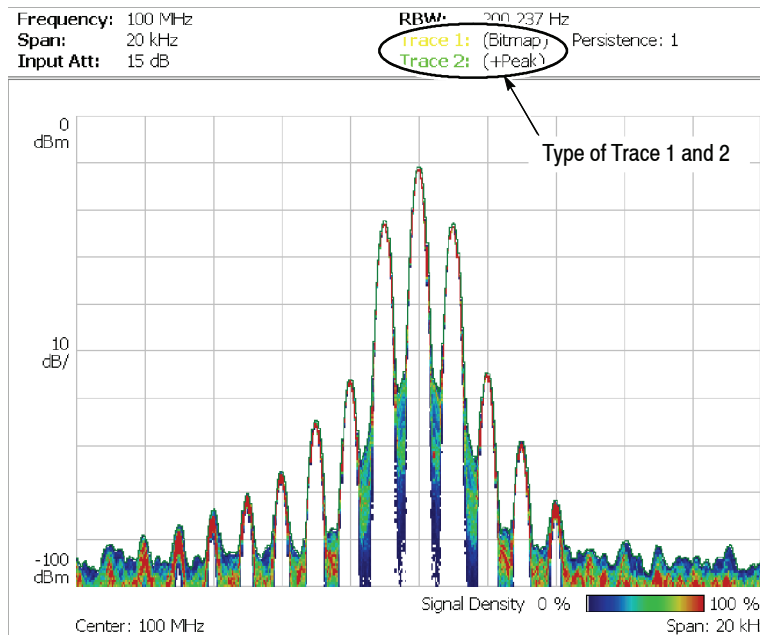
## Displaying DPX Spectrum

The DPX spectrum measurement records data occurrences for each pixel on screen to show the bitmap trace with color-grading according to the density.

1. Press the **DPX** key on the front panel to display the DPX spectrum.



Two traces are displayed by default with Trace 1 as Bitmap and Trace 2 as +Peak. The Bitmap trace indicates high density in red and low in blue. (See Figure 2-43.)



**Figure 2-43: DPX spectrum display**

### Changing the Trace Type

Change the Trace 1 type.

1. Press the **Trace/Avg** key on the front panel.
2. Press the **Select Trace** side key to select **1** (Trace 1).

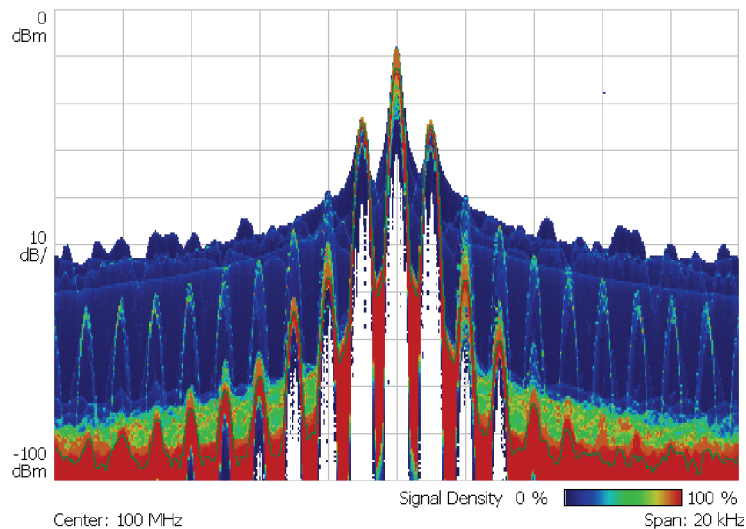
3. Press the **Trace 1 Type...** side key to select the trace type.  
For example, select **MaxHold** and observe the waveform.  
The MaxHold trace holds the maximum amplitude for each frequency.

### Persistence Display

When persistence is enabled, signal events fade gradually from the display. You can limit how long a point will be displayed by adjusting the Variable Persistence control, selecting Infinite Persistence, or turning Persistence off. The persistence controls are valid for the Bitmap trace.

1. Press the **Trace/Avg** key on the front panel.
2. Press the **Trace 1 Type...** side key to select **Bitmap**.
3. Press the **Dot Persistence** side key to select **Variable** (variable persistence display).
4. Press the **Persistence Value** side key and set the value ranging from 1 to 1000 (no unit). For example, set 20.
5. Slowly change the amplitude or frequency of the signal generator to vary the output waveform and observe the transient on the DPX display.

Change the persistence value several times and observe how the waveform fades out. Use the **Reset Bitmap** side key to restart the display.



**Figure 2-44: Persistence display**

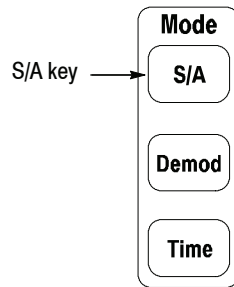
6. Reset the signal generator to the original setting for the next step.  
(Amplitude: -10 dBm, Frequency 100 MHz)

## Displaying a Spectrogram

The spectrogram view is a useful tool to observe spectrum changes in time series in a three-dimensional view. The horizontal and vertical axes indicate frequency and frame number, respectively, and the color axis represents amplitude.

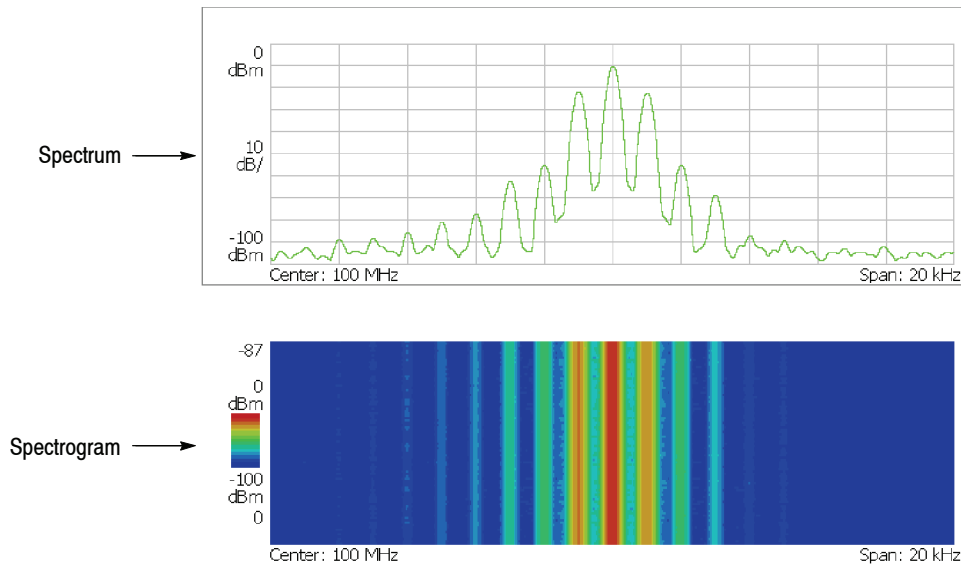
Display the spectrogram using the following steps:

1. Press the Mode: S/A key.



2. Press the S/A with Spectrogram side key.
3. If no waveform is displayed, press the Run/Stop key to acquire data.

The spectrum and spectrogram are displayed concurrently (see Figure 2-45).

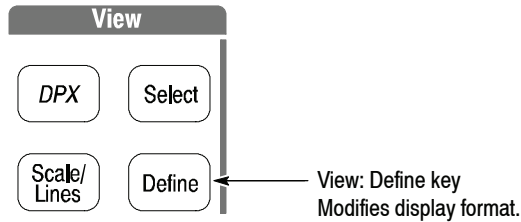


**Figure 2-45: Concurrent display of spectrum and spectrogram**



4. Display the spectrum and spectrogram side-by-side:

- a. Press the View: **Define** key.



- b. Press the **View Orientation** side key to select **Tall**.

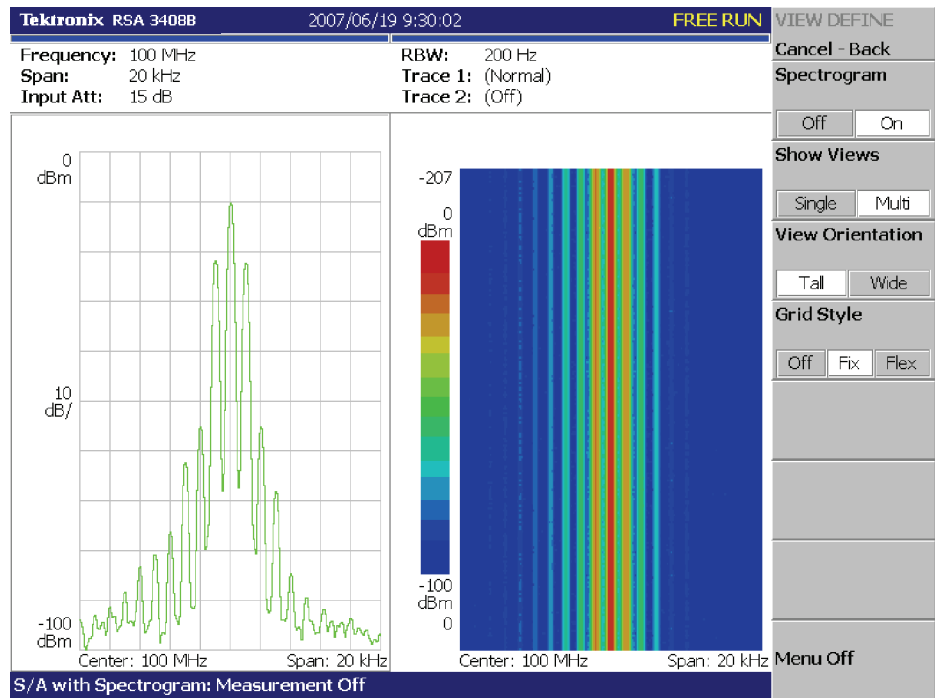


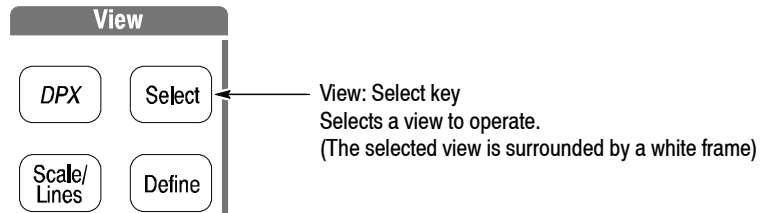
Figure 2-46: Tall display of spectrum and spectrogram

- c. Press the **View Orientation** side key to select **Wide**.

5. Display spectrogram only:

- a. Press the View: **Select** key and then select the spectrogram on the display.

The selected view is framed in white on screen.



- b. Press the View: **Define** key and then press the **Show Views** side key to select **Single**.

Only the spectrogram is displayed (see Figure 2-47).

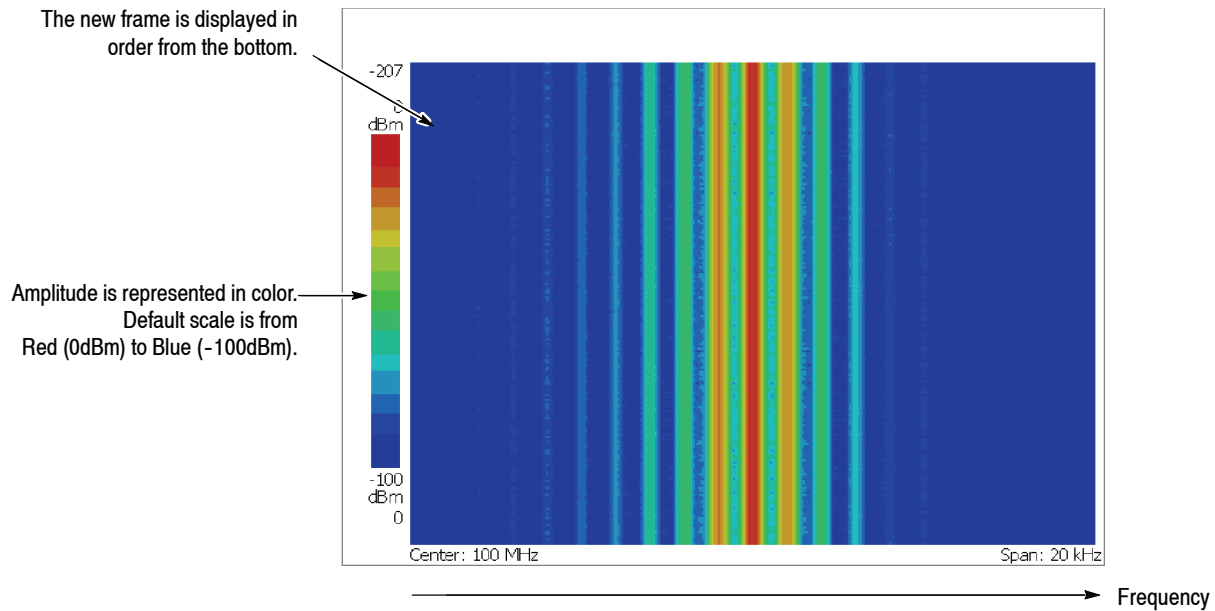


Figure 2-47: Spectrogram view

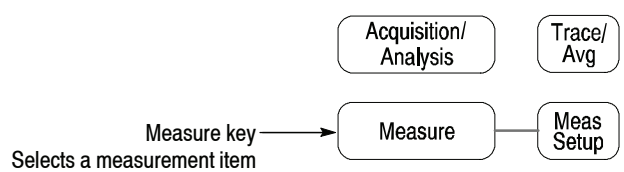
- c. Press the **Show Views** side key again to return to **Multi**.

## Spectrum Analysis

There are several measurement items in the spectrum analysis, such as ACPR (Adjacent Channel Leak Power Ratio), C/N (Carrier vs. Noise Power Ratio), and OBW (Occupied Band Width). These items enable you to perform measurements using simple key operations. Here, you will measure channel power and carrier frequency as examples.

### Measuring Channel Power

1. Press the **Measure** key on the front panel.



Measurement items are displayed in the menu on the right side of the screen.

2. Press the **Channel Power** side key.

A band power marker, indicating measurement range, is displayed on the spectrum waveform. The measurement result is displayed below the waveform (see Figure 2-48).

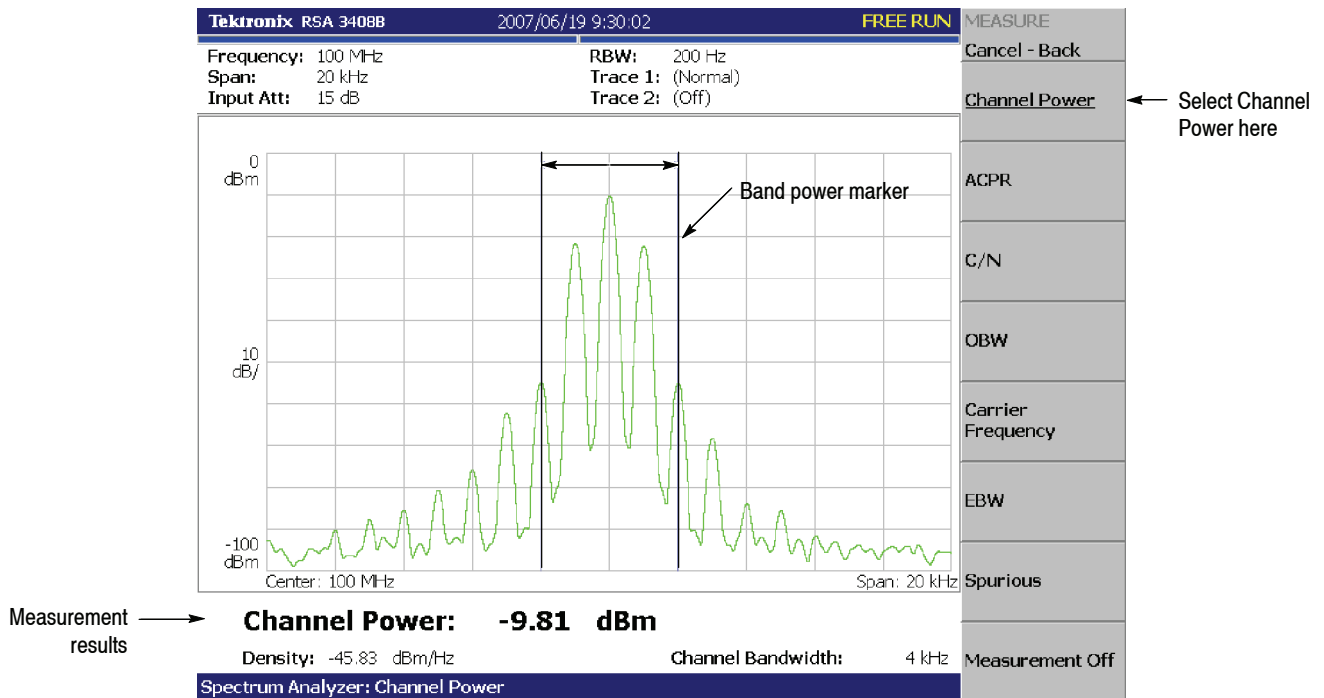


Figure 2-48: Channel power measurement

### Changing a Measurement Parameter

Change a measurement parameter:

1. Press the **Meas Setup** key on the front panel.
2. The **Channel Bandwidth** menu item is selected. Using the general purpose knob, set the measurement range to 40 kHz for example. See the display in Figure 2-49.

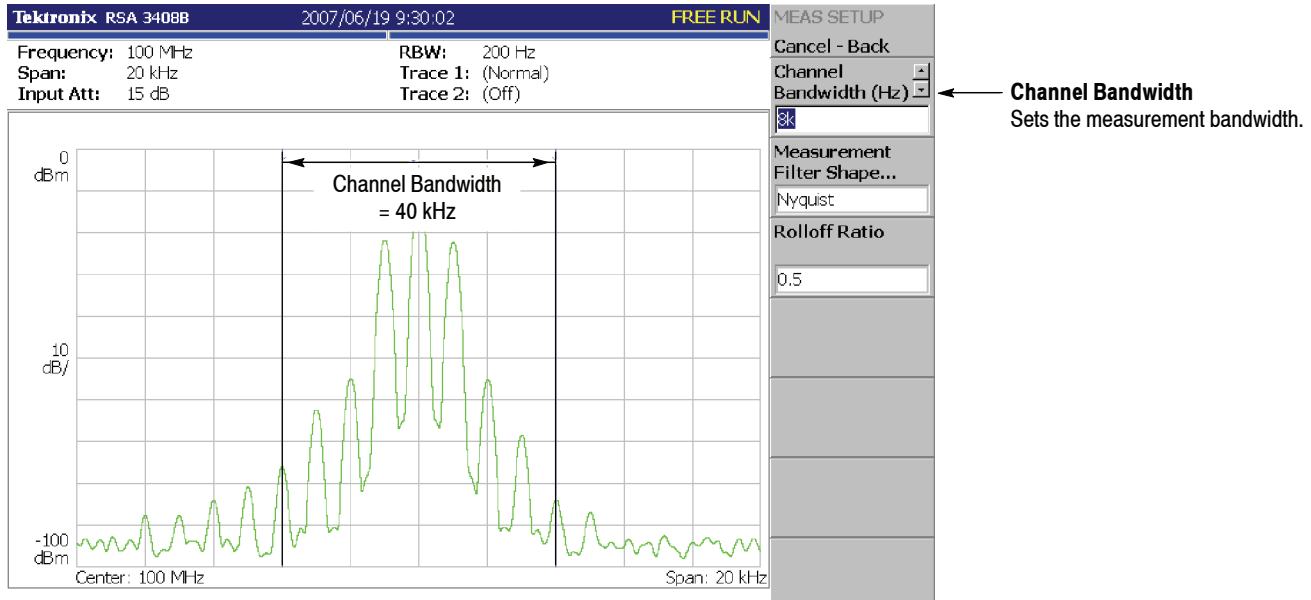


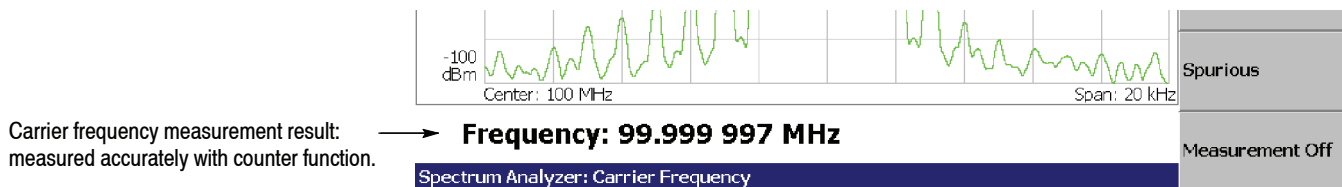
Figure 2-49: Channel power measurement (Channel Bandwidth = 40 kHz)

### Measuring Carrier Frequency

Carrier frequency can be measured accurately, using the counter function:

1. Press the **Measure** key on the front panel.
2. Press the **Carrier Frequency** side key.

The measurement result is displayed at the bottom of the screen (see Figure 2-50).



Carrier frequency measurement result: measured accurately with counter function.

→ **Frequency: 99.999 997 MHz**

Spectrum Analyzer: Carrier Frequency

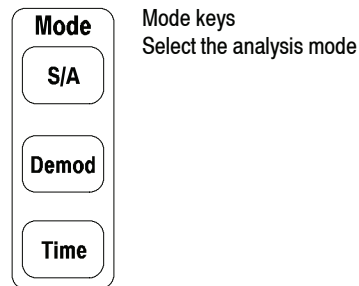
Figure 2-50: Carrier frequency measurement

## Modulation Analysis

This section describes how to analyze a modulated signal. Settings are the same as those in the previous section; center frequency of 100 MHz, span of 20 kHz, and amplitude of 0 dBm.

### Selecting Analysis Mode

The analyzer functions are classified into three functional groups, selected using the Mode keys.



- Spectrum analysis      Mode: **S/A**  
Performs general spectrum analysis. All operations in the tutorial up to this point have been performed in this mode.
- Modulation analysis      Mode: **Demod**  
Performs analog and digital (optional) modulation analyses.
- Time analysis              Mode: **Time**  
Performs time characteristic analysis, including CCDF measurement.

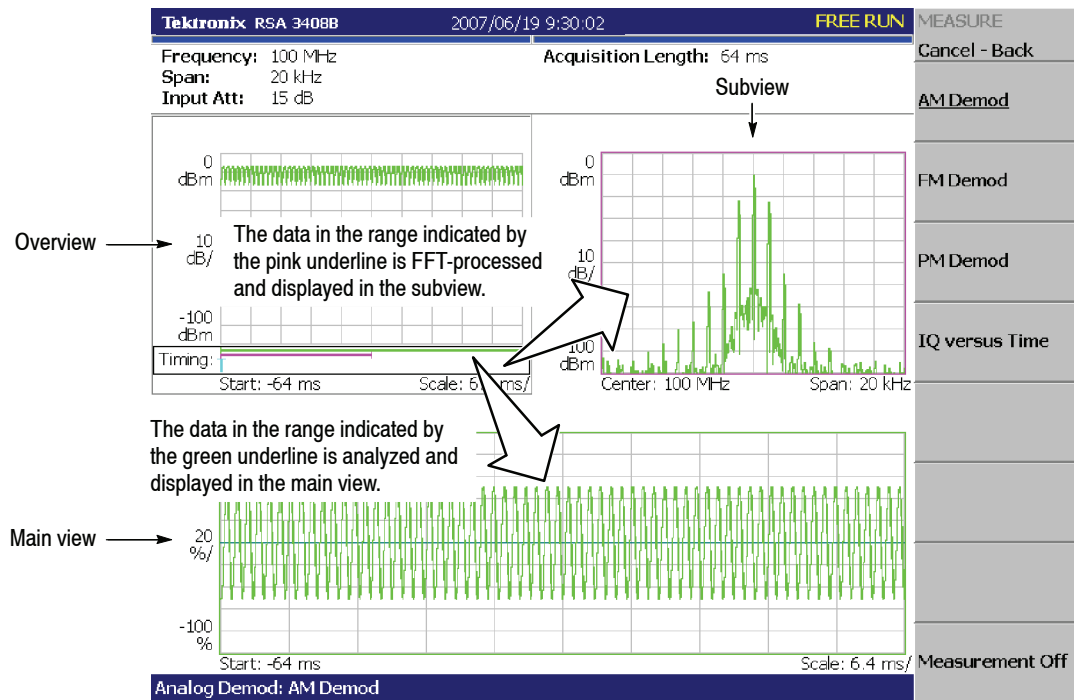
The measurement procedures for modulation analysis and the time analysis are similar. Select the analog modulation analysis as follows:

1. Press the **Demod** key on the front panel.
2. Press the **Analog Demod** side key.

## Selecting a Measurement Item

Observe an AM signal change in time series as an example.

1. Press the **AM Demod** side key.
2. Press the **Run/Stop** key to acquire the signal (see Figure 2-51).



**Figure 2-51: AM signal measurement**

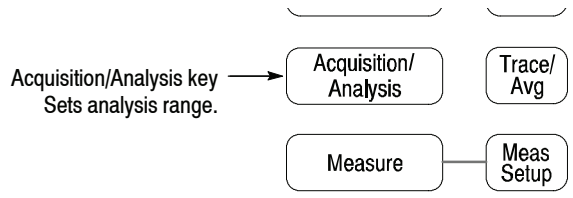
Three views are displayed on the screen in the Demod mode:

- *Overview*: Displays all data of the specified block in the time domain. The measurement range indicated by the green underline is specified in this view.
- *Main view*: Displays the measurement result and waveform of the range specified in the overview (they may be displayed in separate views). In this case, level changes of I and Q signals are displayed as the yellow and green traces, respectively, in the main view.
- *Subview*: Displays spectrum as an auxiliary view by default. You can specify the range in the overview to create the spectrum for the subview.

### Setting Analysis Range

Set an analysis range, which will be displayed with a green underline in the overview.

1. Press the **Acquisition/Analysis** key on the front panel.



Two vertical green lines appear, indicating the analysis range, shown in Figure 2-52.

2. Press the **Acquisition History** side key to specify the number of the block to be analyzed. Leave it at “0” (the latest block), its default value.
3. Press the **Analysis Length** side key and specify the time length of the analysis range. For example, enter **32 ms** using the numeric keypad.
4. Press the **Analysis Offset** side key and specify the starting point of the range. For example, enter **24 ms** using the numeric keypad.

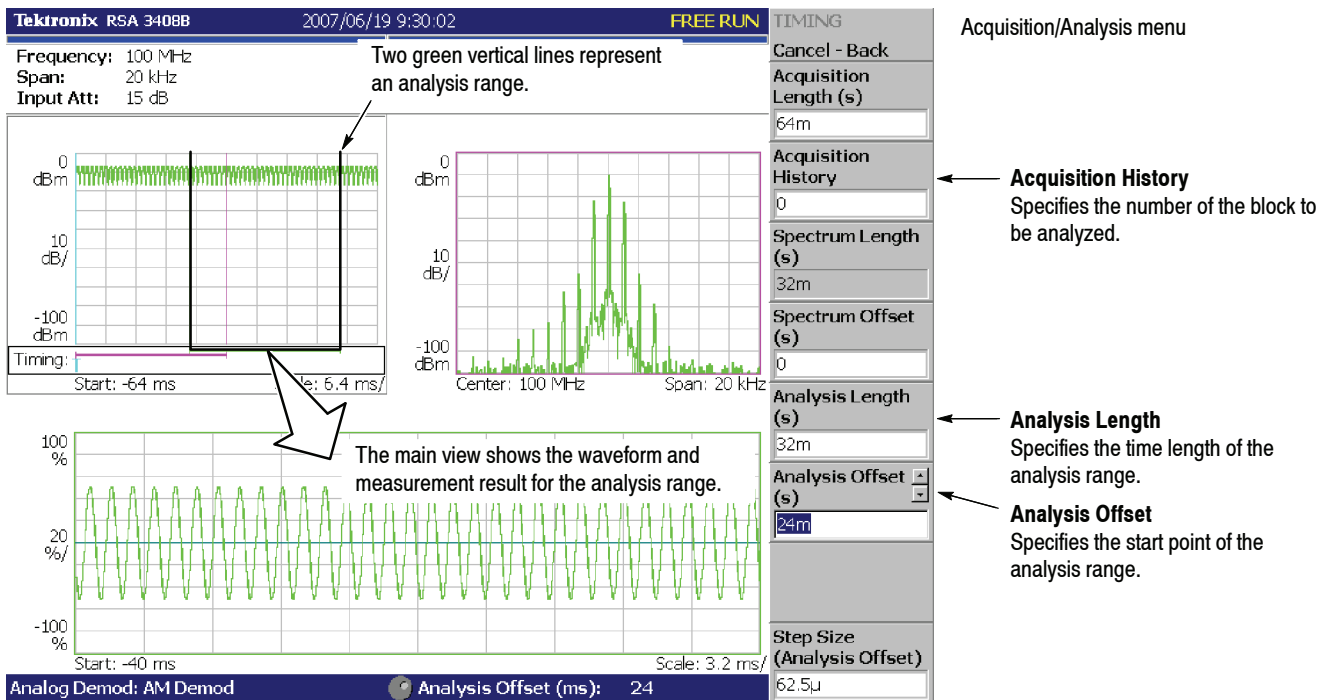
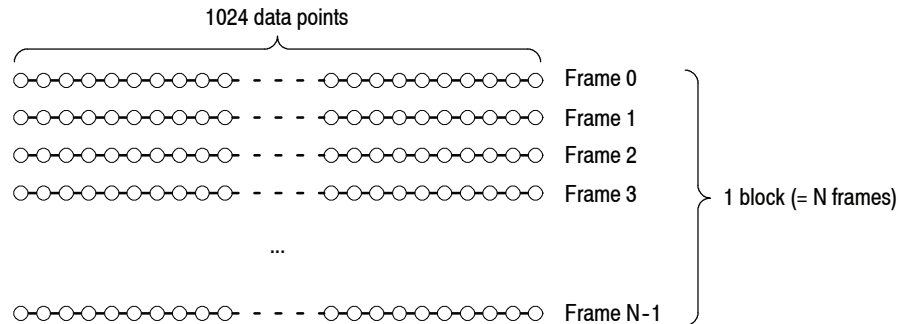


Figure 2-52: Analysis range settings

## Setting the Acquisition Length

One frame consists of 1024 data points and one block consists of several frames. Data are acquired in block units in the Demod mode. The number of frames in one block is referred to as block size. Frame and block size are shown in Figure 2-53.



**Figure 2-53: Frame and block**

Suppose that one block contains N frames. The acquisition length for a block is calculated using this equation:

$$(\text{One block acquisition length}) = N \times (\text{One frame acquisition length})$$

One block acquisition length is set using **Acquisition Length** in the Acquisition/Analysis menu. One frame acquisition length is set internally, depending on span, and displayed in **Spectrum Length** in the Acquisition/Analysis menu.

To set the acquisition length, perform the following steps:

1. Press the **Acquisition/Analysis** key on the front panel.

By default, Acquisition Length is set to 64 ms and Spectrum Length 32 ms. The number of frames in a block is  $64 \div 32 = 2$ .

2. Press the **Acquisition Length** side key to change the value. For example, set 256 ms by turning the knob (see Figure 2-54).

In this case, Acquisition Length is 256 ms and Spectrum Length 32 ms, so the data is displayed in the overview for  $256 \div 32 = 8$  frames (8192 points). The green underline indicating the analysis range gets narrower than the previous setting: one block = 2 frames.



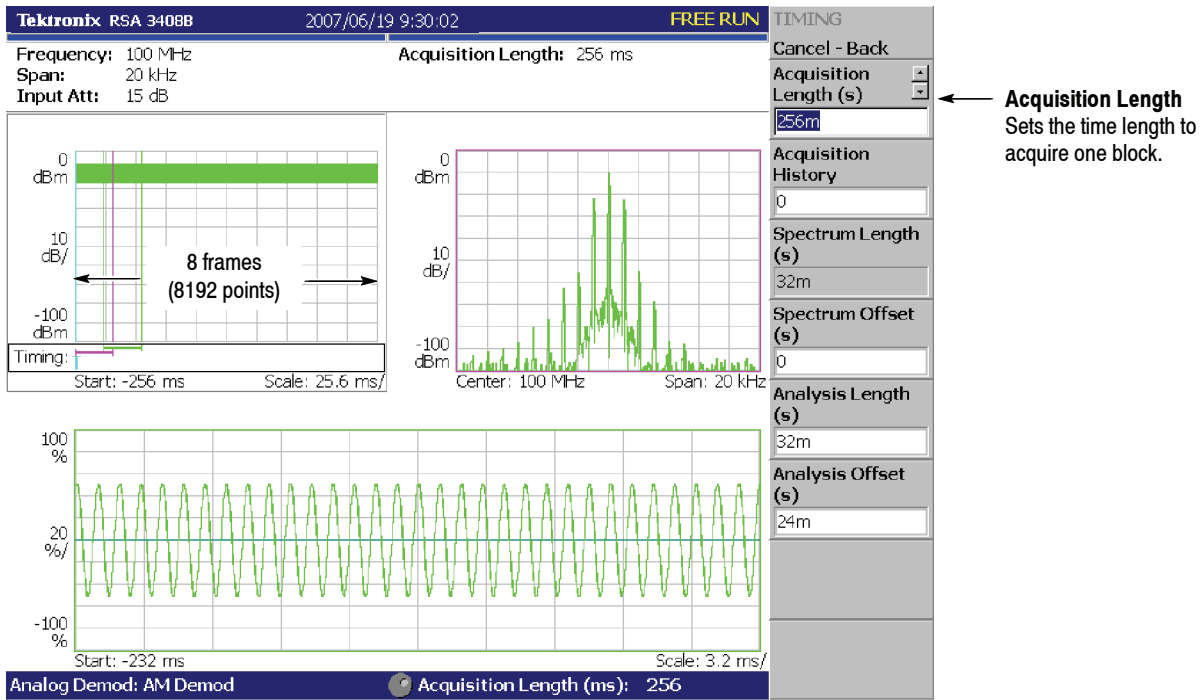
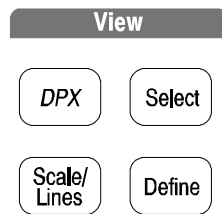


Figure 2-54: Changing the acquisition length

### Displaying Single View and Changing Scale

Although three views are normally displayed in the Demod mode, you can select one view to display full screen. This section describes how to display one view and change the vertical and horizontal scales using the View keys.

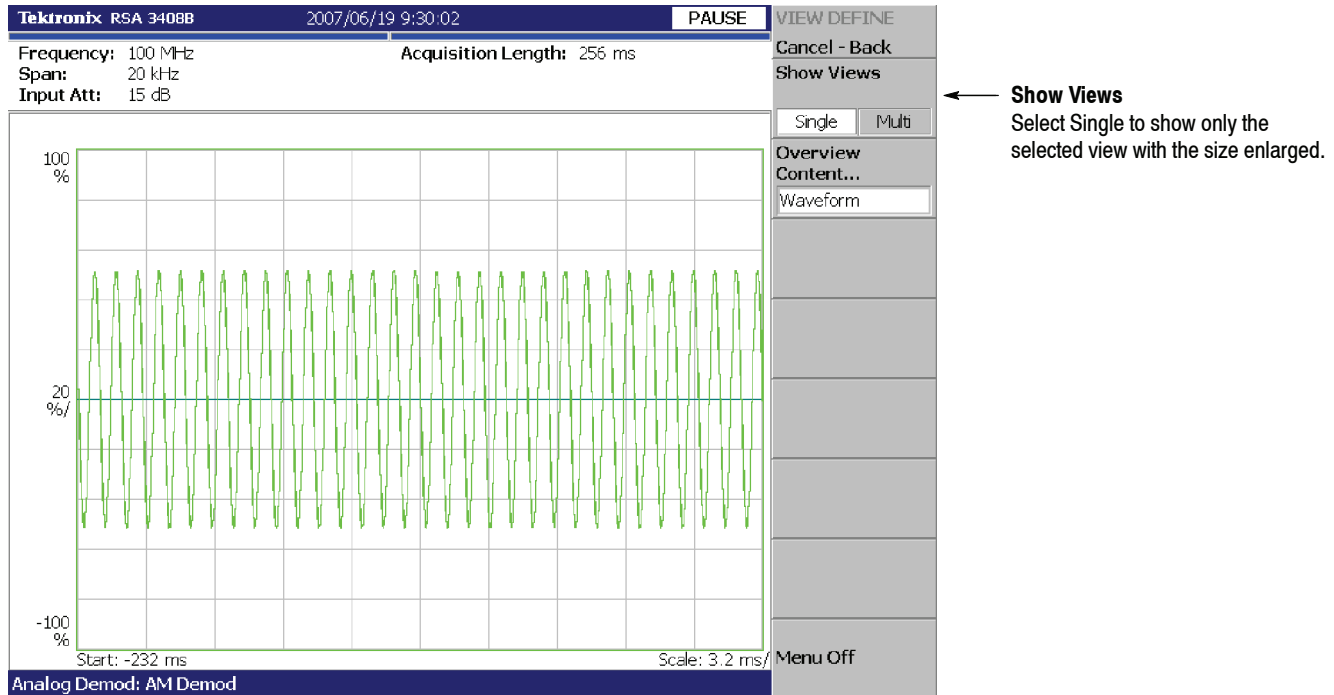
1. Press the **Run/Stop** key to stop data acquisition and observe the waveform.
2. Press the View: **Select** key to select the main view. The selected view is surrounded with a white frame.



View keys  
Control the scale and format of views

3. Press the **Define** key, and then the **Show Views** side key, shown in Figure 2-55, to select **Single**.

Only the main view is displayed, with the size enlarged on the screen.



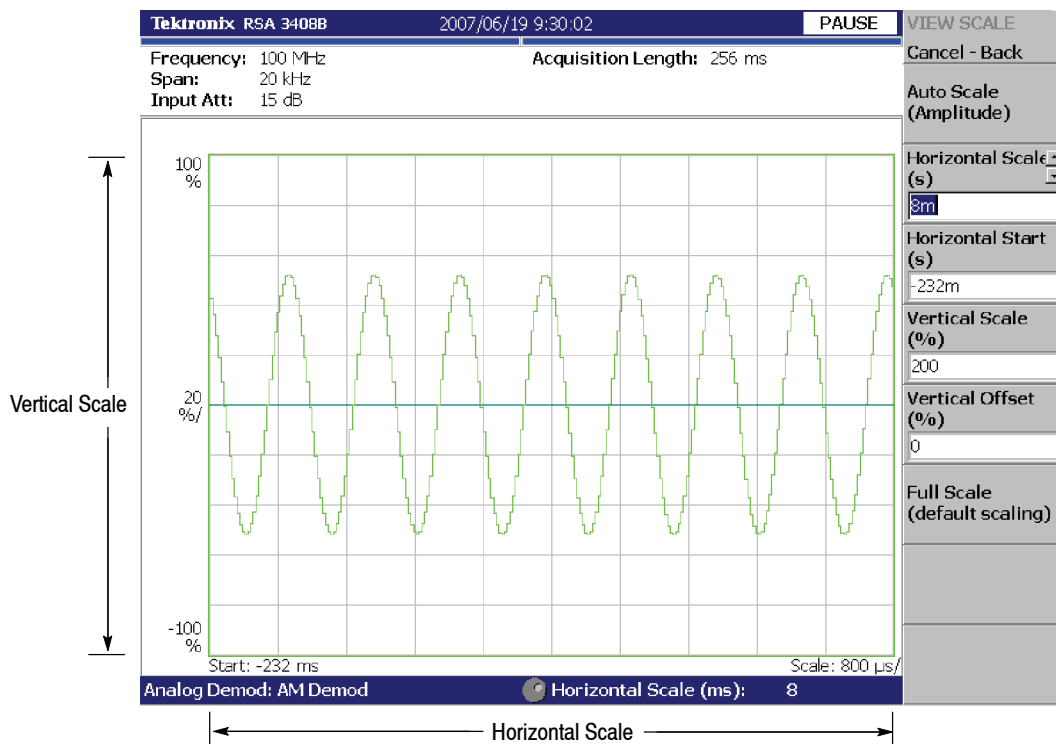
**Figure 2-55: Single view display**

4. Change the scale:
  - a. Press the **Scale/Line** key in the View area.
  - b. Press the **View Scale...** side key.
  - c. Press the **Horizontal Scale** side key and change the scale of the horizontal axis (see Figure 2-56).

Try several settings by turning the general purpose knob; observe the changes in the display.

- d. Press the **Vertical Scale** side key and change the vertical axis scale.

Try several settings by turning the knob; observe the changes in the display.



**Figure 2-56: Scale settings**

### Completing the Measurement

Complete the measurement with the following procedure:

1. Press the **Measure** key on the front panel.
2. Press the **Measurement Off** side key.

The display returns to the spectrum view. However, the analysis mode is still in the Demod mode.

## Turning Off the Power

When you have completed the measurements, turn off the power:

1. Press the On/Standby switch at the lower left of the front panel.

Windows XP runs the shutdown process and the power source goes to the standby state, with the orange LED on.

2. Turn off the signal generator.

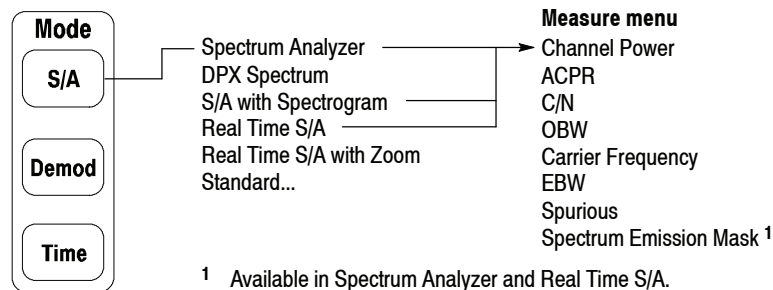
You have now completed the tutorial.

# Reference



# Spectrum Analysis (S/A Mode)

This section describes how to perform measurements in the spectrum analysis (S/A) mode.



**Figure 3-1: S/A menu structure**

The S/A menu has the following items:

- **Spectrum Analyzer.** Performs general spectrum analysis. Refer to page 3-4 for details.
- **DPX Spectrum.** Performs analysis displaying the DPX (Digital Phosphor) spectrum view. Refer to page 3-18 for details.
- **S/A with Spectrogram.** Performs spectrum analysis with spectrogram. Refer to page 3-21 for details.
- **Real Time S/A.** Performs real-time spectrum analysis with spectrogram. Refer to page 3-23 for details.
- **Real Time S/A with Zoom.** Performs real-time spectrum analysis with zoom function. Refer to page 3-27 for details.
- **Standard....** Performs spectrum analysis according to a communication standard. For details, refer to the user manual included in each option as shown in Table 3-1.

**Table 3-1: Standard menu in the S/A mode**

Menu item	Option	Description
W-CDMA-UL	Option 30	W-CDMA uplink analysis
3GPP-R5-DL	Option 30	3GPP Release 5 downlink analysis
3GPP-R5-UL	Option 30	3GPP Release 5 uplink analysis

## Measurement Screen Layout

Figure 3-2 shows the basic screen layout in the spectrum analysis (S/A mode). The spectrum waveform and measurement results are displayed. You can display the spectrum and the spectrogram at the same time. Refer to *Spectrogram Display* on page 3-21.

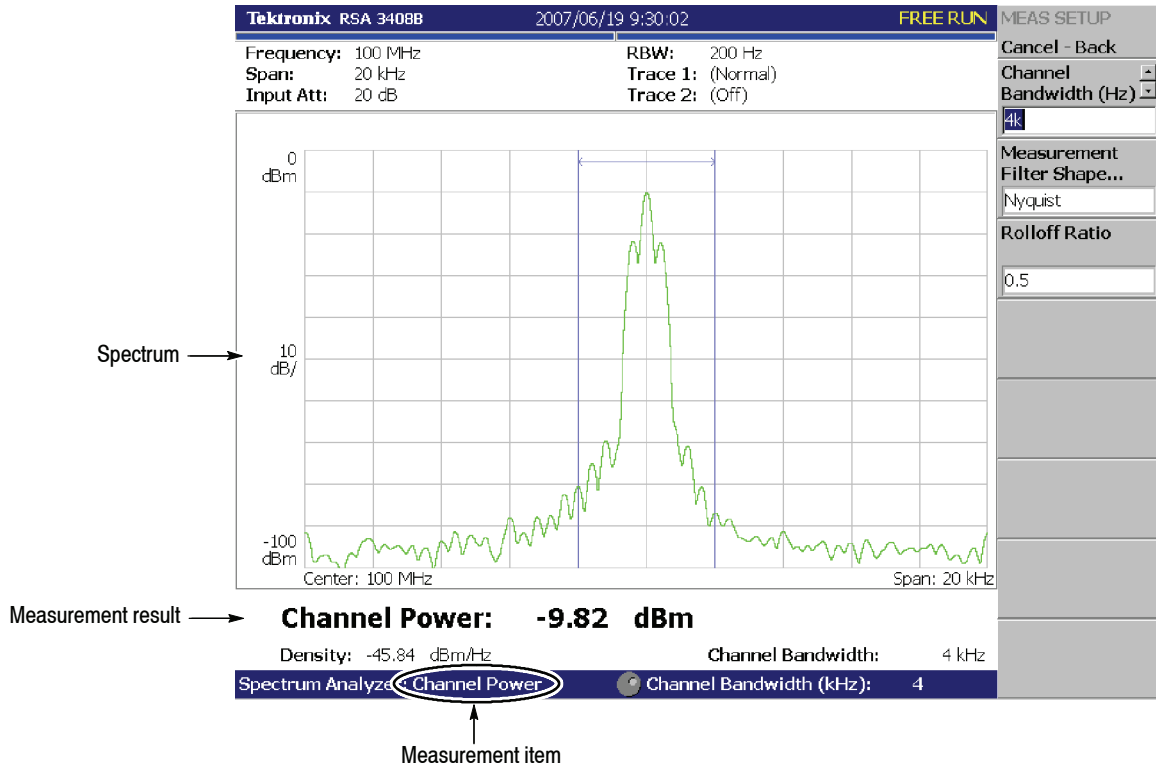


Figure 3-2: S/A measurement screen



## Changing the Grid Style

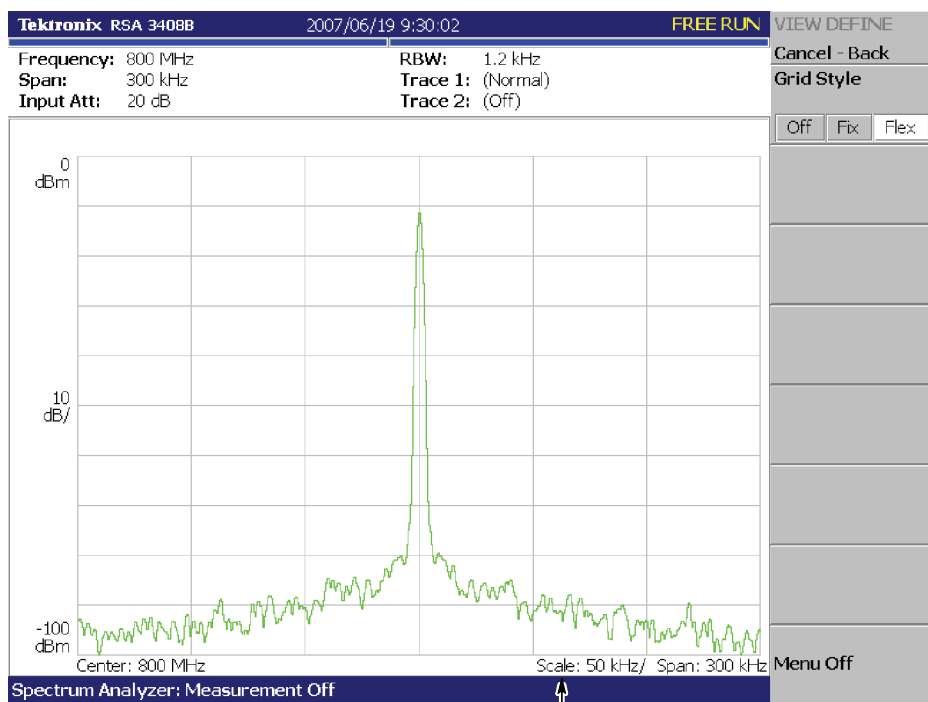
The graticule is a 10 × 10 grid by default. You can select a different grid style by pressing View: **Define > Grid Style** as follows:

**NOTE.** The Grid Style menu item is available only in the S/A mode except Real Time S/A.

**Off.** Turns off the graticule.

**Fix.** Always displays a 10 × 10 grid.

**Flex.** Displays the graticule with the horizontal scale (per division) in a 1-2-5 sequence.



The horizontal scale is set to 50 kHz/div for a span of 300 kHz in the "Flex" grid style.

**Figure 3-3: "Flex" grid style**

## Spectrum Analysis

You can select the following measurement items with the **Measure** key when you select **Spectrum Analyzer**, **S/A with Spectrogram**, or **Real Time S/A** in the S/A mode.

**Table 3-2: Measurement items in the S/A mode**

Measure menu	Title	Refer to:
Channel Power	Channel Power Measurement	page 3-5
ACPR	ACPR (Adjacent Channel Power Ratio) Measurement	page 3-6
C/N	C/N (Carrier to Noise ratio) Measurement	page 3-7
OBW	OBW (Occupied Bandwidth) Measurement	page 3-8
Carrier Frequency	Carrier Frequency Measurement	page 3-10
EBW	EBW (Emission Bandwidth) Measurement	page 3-10
Spurious	Spurious Signal Measurement	page 3-12
Spectrum Emission Mask	Spectrum Emission Mask (SEM) Measurement <sup>1</sup>	page 3-14

<sup>1</sup> **Not available in S/A with Spectrogram.**

Pressing the **Measurement Off** side key stops the measurement and returns to the original spectral display.

### Basic Procedure

1. Press the **S/A** key and then the **Spectrum Analyzer** side key.
2. Select the measurement item (refer to Table 3-2).
3. Display the spectrum waveform of the measurement signal:
  - a. Press the **Run/Stop** key on the front panel to start data acquisition.

---

**NOTE.** For details on setting frequency, span, and amplitude, refer to Setting Frequency and Span on page 3-135 and Setting Amplitude on page 3-143.

---

- b. Set the frequency by pressing the **Frequency/Channel** key on the front panel.
  - c. Set the span by pressing the **Span** key on the front panel.
  - d. Set the amplitude by pressing the **Amplitude** key on the front panel.
4. Set the following Measurement Setup controls by pressing the **Meas Setup** key on the front panel.

## Channel Power Measurement

This measurement calculates power in the range specified using a band power marker (shown in Figure 3-4).

**Meas Setup Menu.** The Meas Setup menu for the channel power measurement contains the following controls:

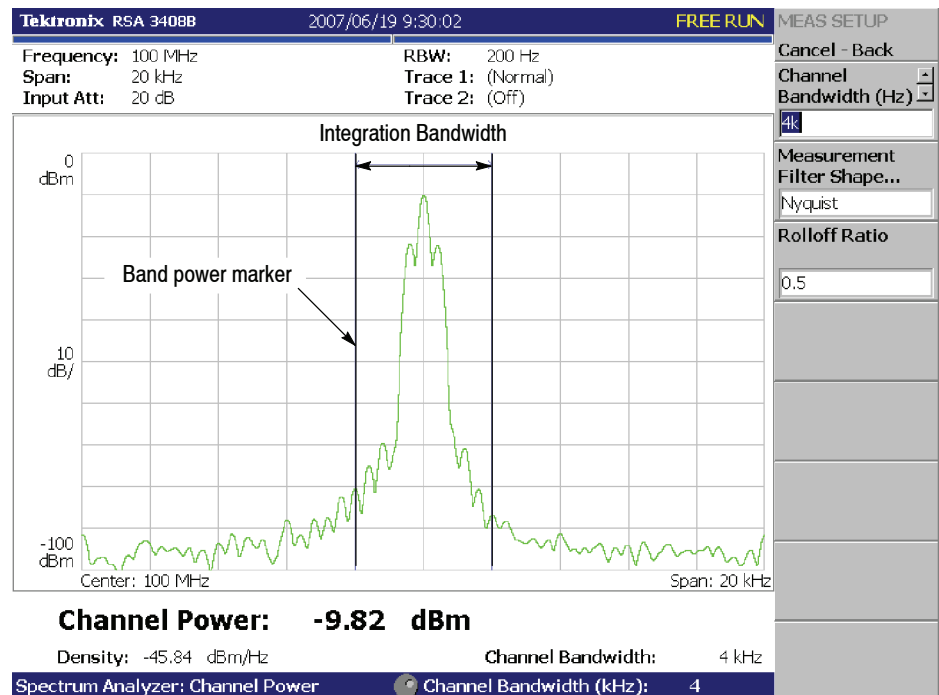
**Integration Bandwidth.** Sets frequency range for power measurement (see Figure 3-4).

**Measurement Filter Shape...** Selects a filter shape from these types:

- Rect (Rectangular)
- Gaussian
- Nyquist
- Root Nyquist

**Rolloff Ratio.** Enters rolloff ratio when Nyquist or Root Nyquist filter is selected. Range: 0.0001 to 1 (default value: 0.5).

An example of the channel power measurement is shown in Figure 3-4.



**Figure 3-4: Channel power measurement**

**ACPR Measurement**

The power ratio of the carrier signal to the signal appearing in its adjacent frequency band (leak signal) is measured in the ACPR (Adjacent Channel Power Ratio) measurement. Frequency ranges are set using three band power markers.

**Meas Setup Menu.** The Meas Setup menu for the ACPR measurement contains the following controls (see Figure 3-5):

**Main Channel Bandwidth.** Sets frequency range of main channel.

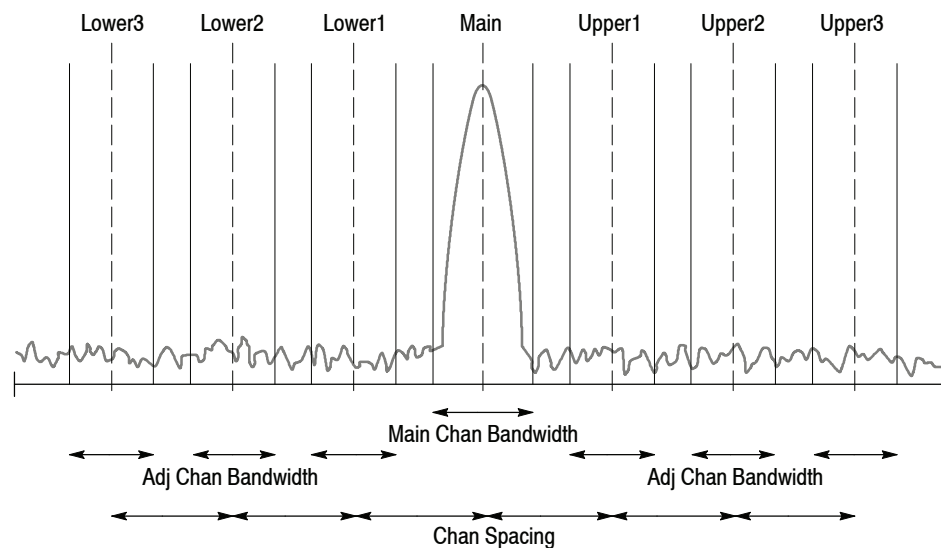
**Adjacent Channel Bandwidth.** Sets frequency range of adjacent channel.

**Chan Spacing.** Sets a frequency interval between two adjacent channels.

**Measurement Filter Shape...** Selects a filter shape from these types:

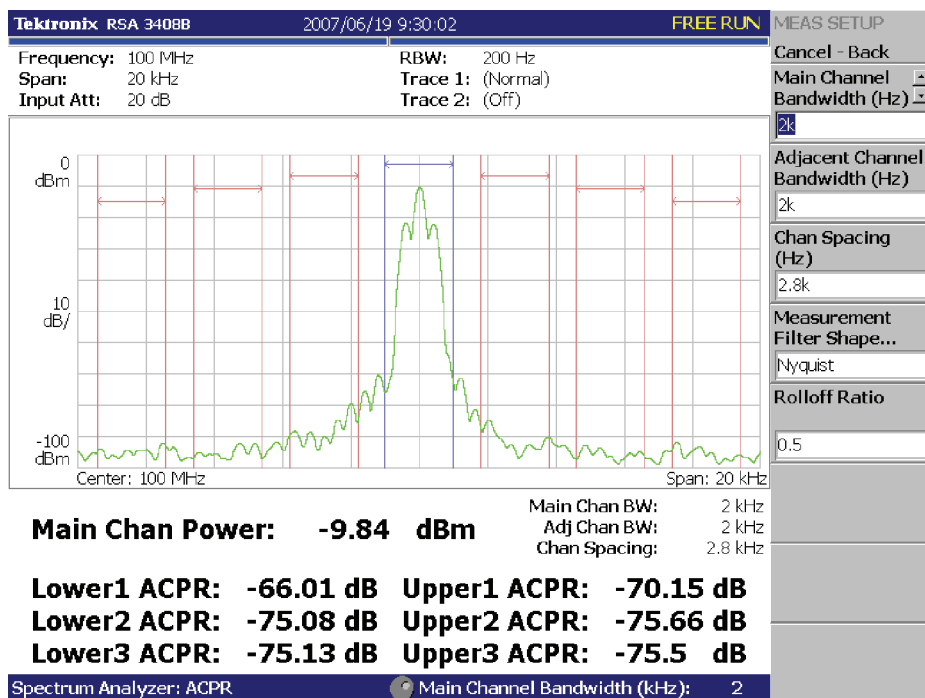
- Rect (Rectangular)
- Gaussian
- Nyquist
- Root Nyquist

**Rolloff Ratio.** Enters rolloff ratio when Nyquist or Root Nyquist filter is selected. Range: 0.0001 to 1 (default value: 0.5).



**Figure 3-5: ACPR measurement band power markers**

Figure 3-6 shows an example of the ACPR measurement.



**Figure 3-6: Example of ACPR measurement**

## C/N Measurement

Measures Carrier to Noise ratio (C/N).

**Meas Setup Menu.** The Meas Setup menu for the C/N measurement contains the following controls (see Figure 3-7).

**Offset Frequency.** Sets the offset frequency from carrier to noise.  
 Range:  $-\text{Span}/2$  to  $+\text{Span}/2$ .

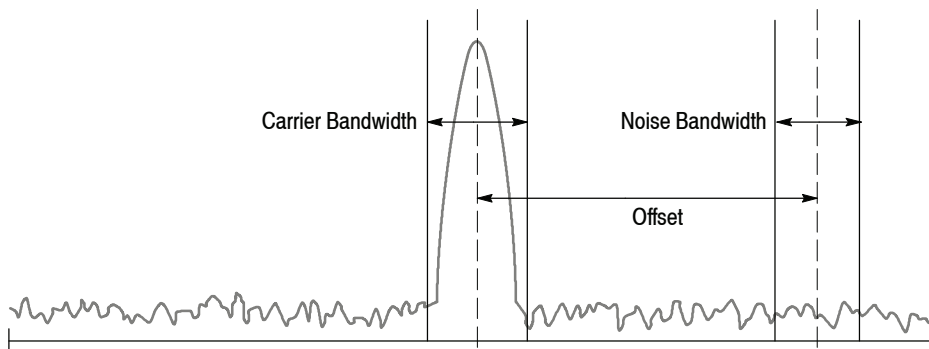
**Noise Bandwidth.** Sets the noise bandwidth.

**Carrier Bandwidth.** Sets the carrier bandwidth.

**Measurement Filter Shape...** Selects a filter shape from these types:

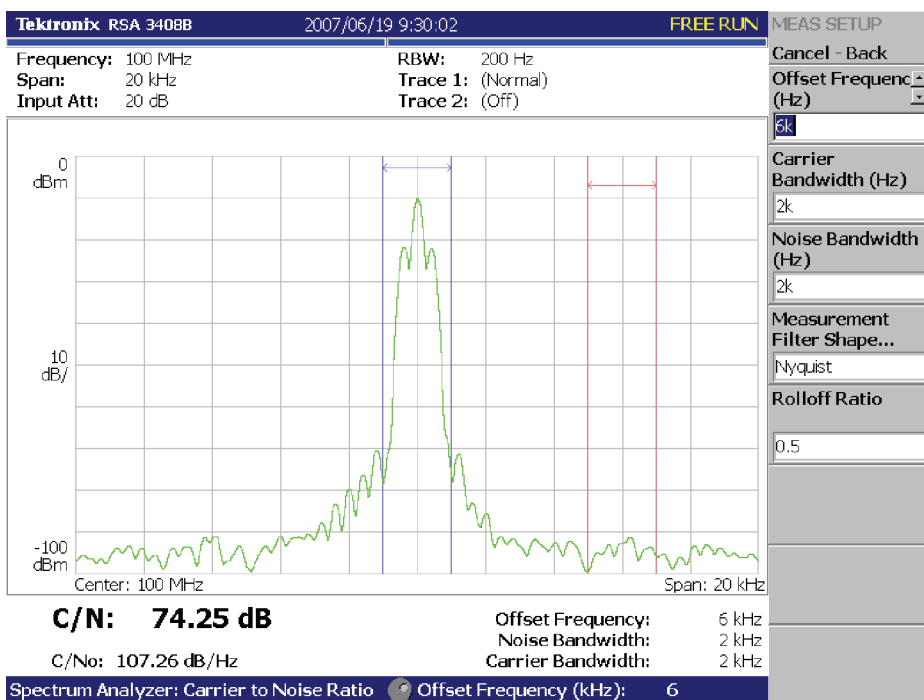
- Rect (Rectangular)
- Gaussian
- Nyquist
- Root Nyquist

**Rolloff Ratio.** Enters rolloff ratio when Nyquist or Root Nyquist filter is selected. Range: 0.0001 to 1 (default value: 0.5).



**Figure 3-7: C/N measurement band power markers**

Figure 3-8 shows an example of the C/N measurement.



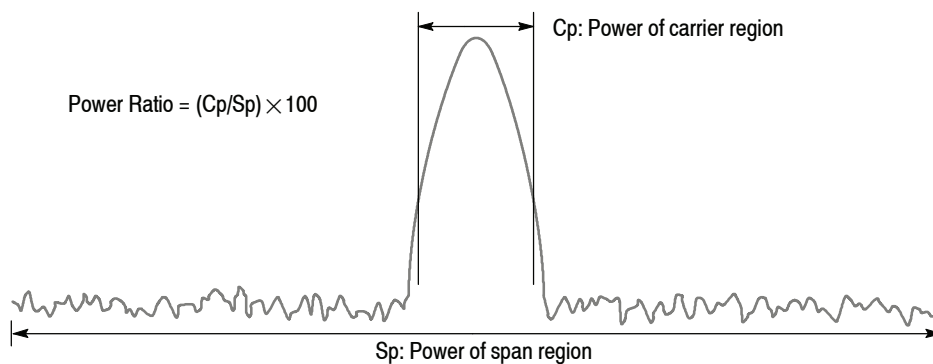
**Figure 3-8: Example of C/N measurement**

**OBW Measurement**

The OBW (Occupied Bandwidth) measures the frequency bandwidth, using the ratio you specify for carrier signal power / power within the span setting.

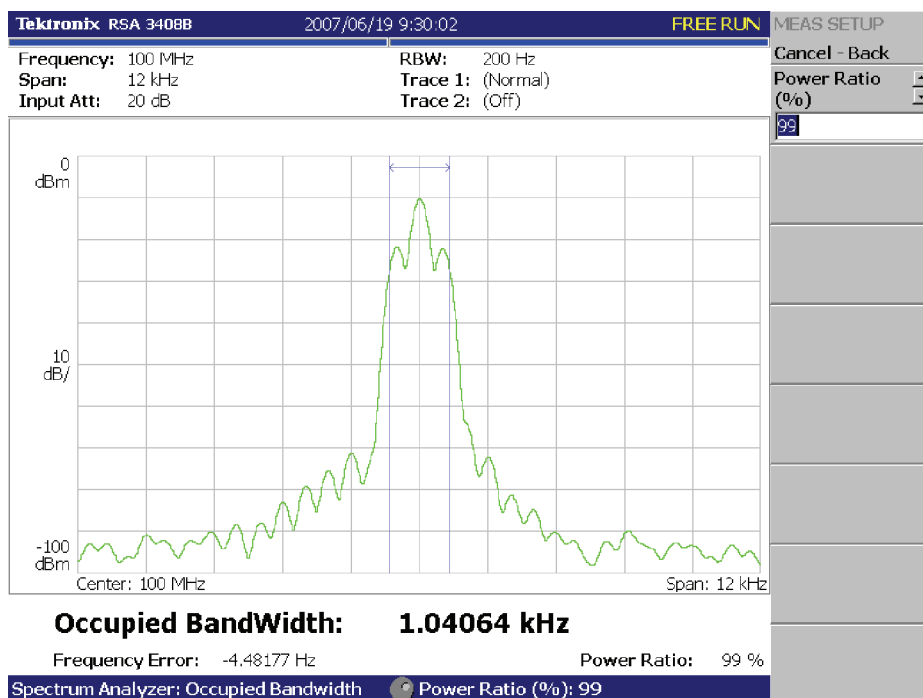
**Meas Setup Menu.** The Meas Setup menu for the OBW measurement contains the following control.

**Power Ratio.** Specifies the power ratio of the carrier and span regions for calculating OBW (see Figure 3-9). The default setting is 99% as defined in T-53 or IS-95 standard. Range: 80 to 99.99%.



**Figure 3-9: OBW measurement band power marker**

Figure 3-10 shows an example of the OBW measurement.



**Figure 3-10: OBW measurement**

### Carrier Frequency Measurement

Carrier frequency is accurately measured using the counter function.

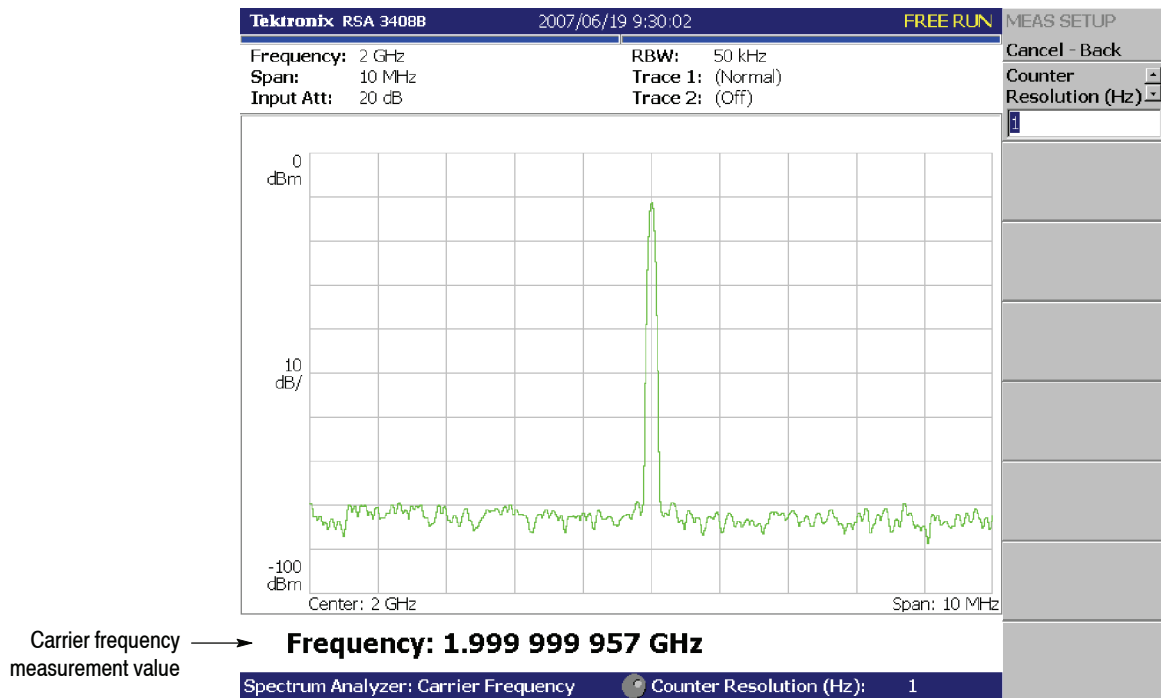
**NOTE.** You must set the frequency and the span to display only the spectrum with the carrier you want to measure. Measurement error will occur if other frequency components are displayed together.

**Meas Setup Menu.** The Meas Setup menu for the Carrier Frequency measurement contains the following control:

**Counter Resolution.** Sets the counter resolution. The measurement result is displayed on the bottom of the view with this resolution.

Range: 1 mHz to 1 MHz in a tenfold sequence (default: 1 Hz).

Figure 3-11 shows an example of the carrier frequency measurement.



**Figure 3- 11: Carrier frequency measurement**

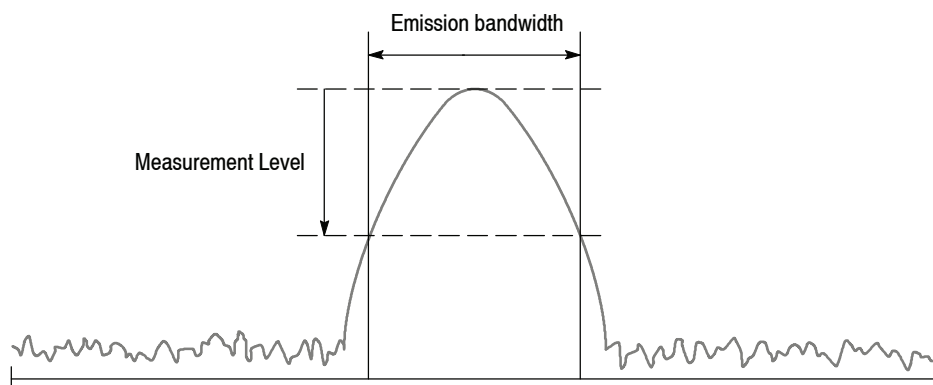
### EBW Measurement

The frequency bandwidth between the maximum peak of the spectrum and the specified dB value is measured in EBW (Emission Bandwidth).



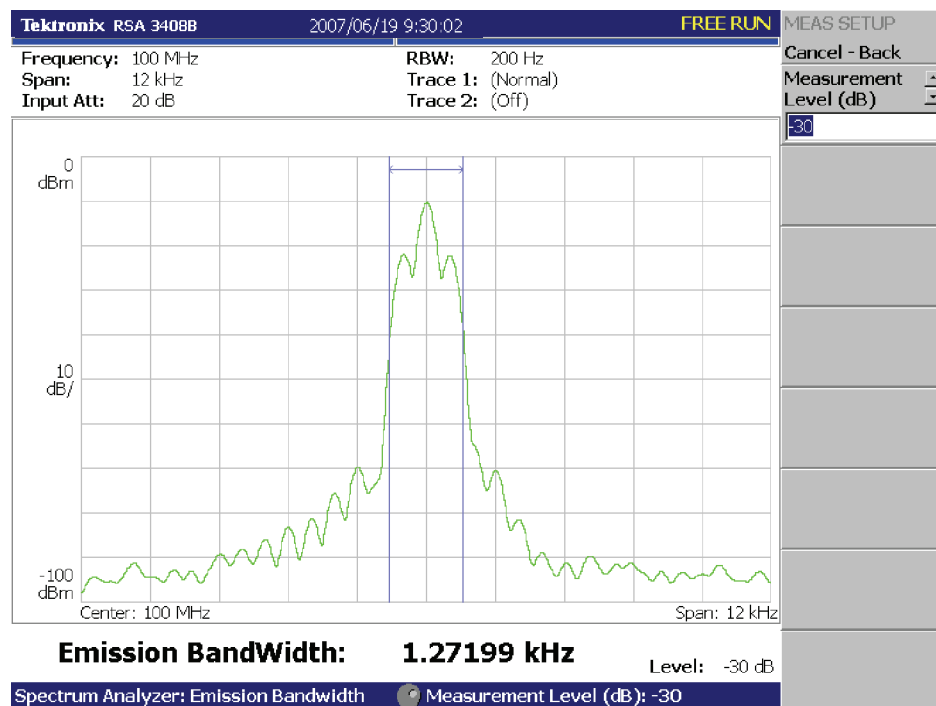
**Meas Setup Menu.** The Meas Setup menu for the EBW measurement contains the following control:

**Measurement Level.** Specifies how far down from the peak level the bandwidth is measured (see Figure 3-12). Range: -100 to -1 dB (default: -30 dB).



**Figure 3-12: EBW measurement band power markers**

Figure 3-13 shows an example of the EBW measurement.



**Figure 3-13: EBW measurement**

## Spurious Signal Measurement

The spurious signal measurement detects up to 20 spurious signals and calculates the frequency difference and the amplitude ratio relative to the normal signal by setting the level conditions.

---

**NOTE.** For detecting stationary spurious signals, waveform averaging is effective for reducing noise. Refer to page 3-191 for averaging.

---

**Meas Setup Menu.** The Meas Setup menu for the spurious signal measurement contains the following controls:

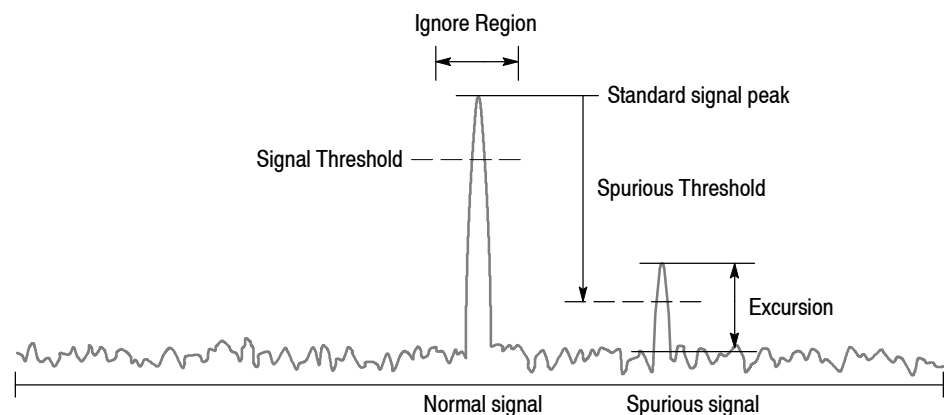
**Signal Threshold.** Sets the threshold for detecting the standard signal (see Figure 3-14). A signal with amplitude exceeding this threshold is regarded as a standard signal. Range: -100 to +30 dBm (default: -20 dBm)

**Ignore Region.** Sets the frequency range centered at the carrier (standard signal) peak, in which spurious signals are not to be detected to avoid false recognition of spurious signals (see Figure 3-14). Range: 0 to Span/2 Hz (default: 0 Hz)

**Spurious Threshold.** Sets the threshold for detecting spurious signals (see Figure 3-14). Enter the value relative to the peak of standard signal. Range: -200 to -30 dBc (default: -70 dBc)

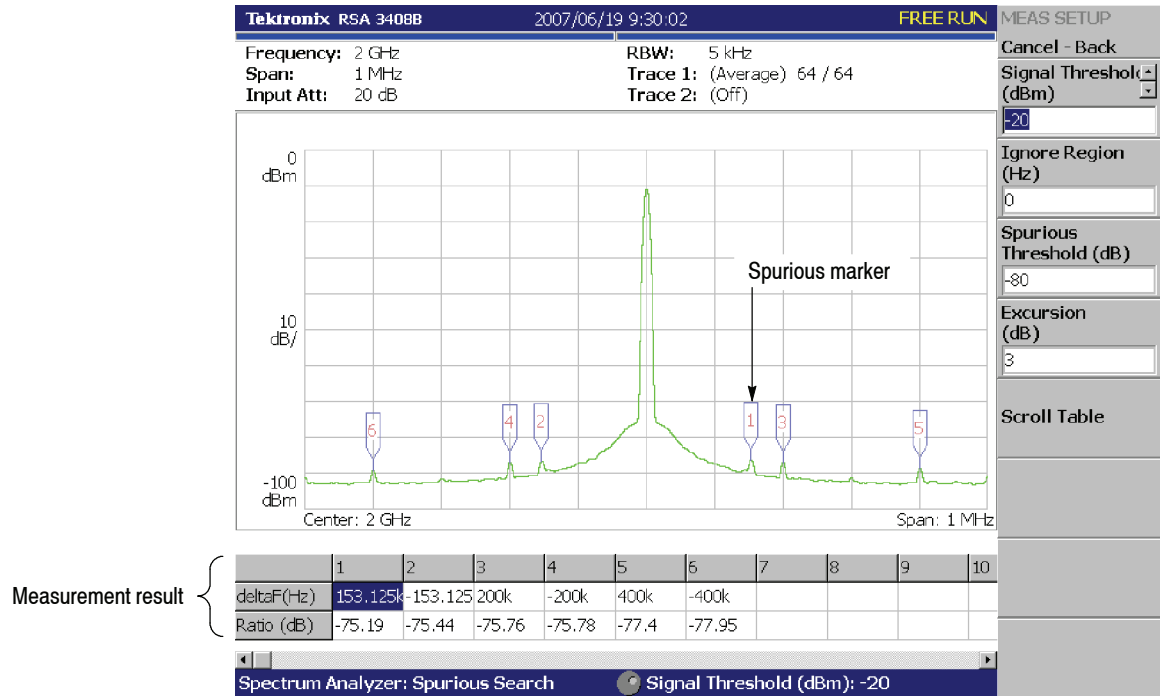
**Excursion.** Sets the deviation amount of amplitude that is considered to be spurious (see Figure 3-14). If a signal with amplitude larger than the Excursion exceeds the Spurious Threshold, it is considered to be spurious. Range: 0 to 30 dB (default: 3 dB)

**Scroll Table.** Horizontally scrolls the spurious table displayed in the lower part of the screen. Up to 20 spurious signals are displayed.



**Figure 3-14: Setting up spurious signal measurement**

Figure 3-15 shows an example of spurious signal measurement.



**Figure 3-15: Example of spurious signal measurement**

Detected spurious signals are assigned markers, numbered in descending order by amplitude. The frequency difference (deltaF) and the amplitude ratio (Ratio) in relation to the standard signal are shown in the table in the lower part of the screen.

## **Spectrum Emission Mask Measurement**

The spectrum emission mask measurement performs a pass/fail test displaying the limit mask to verify that excessive power is not transmitted outside of the designated channel.

**Meas Setup Menu.** The Meas Setup menu for the spectrum emission mask measurement contains the following controls:

**Measurement...** Selects how to specify frequency zones for the limit mask.

- **Offset From Channel.** Specifies frequency zones by the offset from the center frequency.
- **Inband Spurious.** Specifies frequency zones by the absolute frequency values.

**Ref. Channel Select.** Selects the method to determine the reference channel level.

- **Auto.** Sets the level automatically, evaluating the spectrum trace.
- **Man.** Sets the level manually, using the **Ref. Channel Level** side key.

**Ref. Channel Level.** Sets the reference channel level when Ref. Channel Select is set to Man (manual). Range: -150 to 30 dBm (default: 0 dBm).

**Channel Bandwidth.** Defines the frequency window occupied with the reference channel (see Figure 3-16).

This setting is available when Ref. Channel Select is set to Auto.

**Measurement Filter Shape...** Selects a measurement filter shape.

- Rect (Rectangular)
- Gaussian
- Nyquist
- Root Nyquist

This setting is available when Ref. Channel Select is set to Auto.

**Rolloff Ratio.** Enters the roll-off ratio when the Measurement Filter Shape is Nyquist or Root Nyquist filter. Range: 0.0001 to 1 (default value: 0.5).

This setting is available when Ref. Channel Select is set to Auto.

**Limits...** Sets the pass/fail limits for the measurement.

Press this side key to open the limits editor.

For more information, refer to *Editing the Measurement Limits* on page 3-16.

**Scroll Table.** Vertically scrolls the limit table displayed on the bottom of the screen.

Figure 3-16 shows an example of the spectrum emission mask measurement.

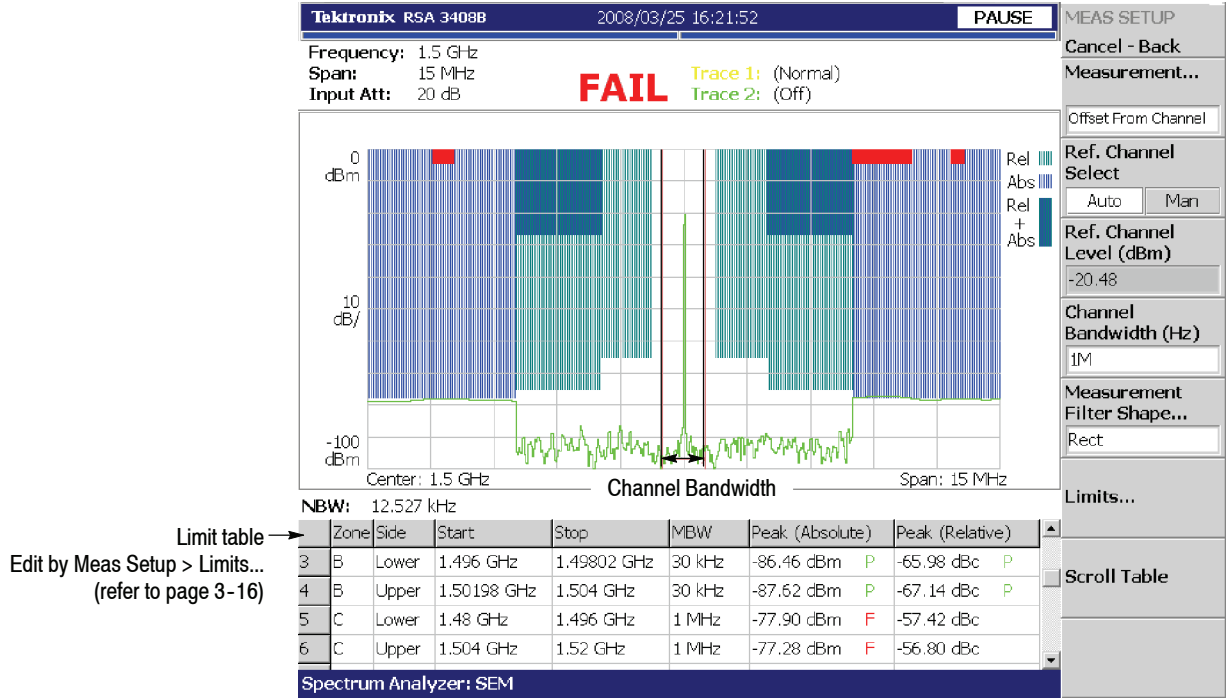


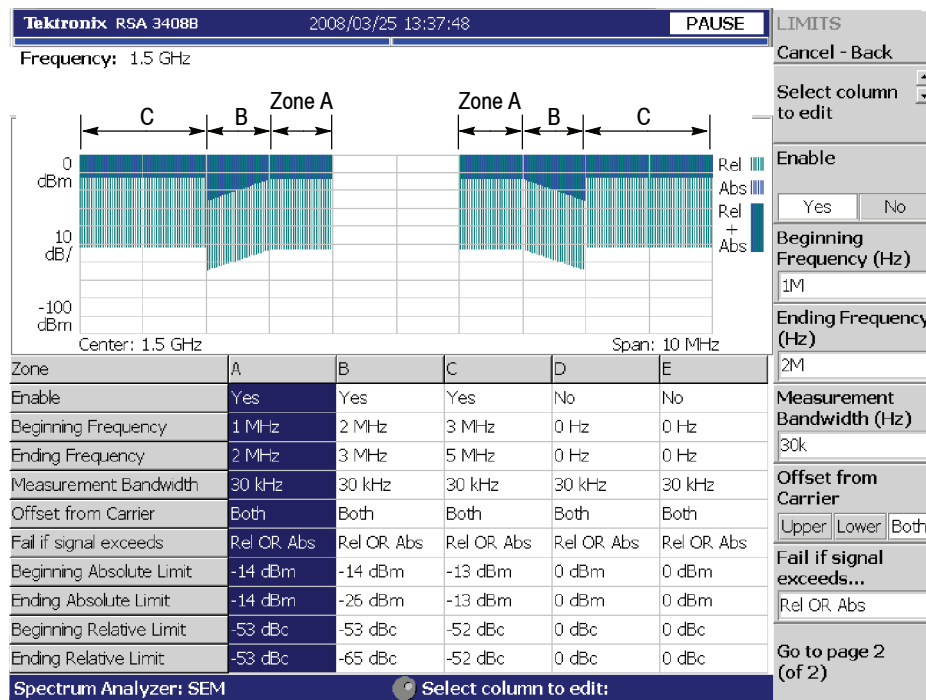
Figure 3-16: Spectrum emission mask measurement

**Editing the Measurement Limits.** When you select Limits... in the Meas Setup menu, the measurement limits editor appears (see Figure 3-17). You can set up to 12 frequency zones (A to L) symmetrical about the center frequency. Enter the pass/fail conditions for each zone.

Follow these steps to set the limit mask.

1. Press the **Select column to edit** side key.
2. Turn the general purpose knob or press the arrow keys to select the column (A to L) to edit.
3. Press the **Enable** side key to enable or disable use of the limits for the zone.
4. Set the other items as appropriate (refer to Table 3-3).
5. When you press the **Rescale Graph** side key, the graph is rescaled to match the set limits.

To restore the scale, press the **Return To Original Scale** side key.



**Figure 3-17: Measurement limits editor**

**Table 3-3: Limits Setting Menu Items**

Item	Description	Limit range
Enable	Enables or disables the mask in the specified zone (A, B, C, ... or L).	-
Beginning Frequency	Sets the beginning frequency of the zone.	-8 to 8 GHz
Ending Frequency	Sets the ending frequency of the zone.	-8 to 8 GHz
Resolution Bandwidth	Sets the resolution bandwidth (RBW).  Select the RBW filter shape by pressing RBW/FFT > RBW Filter Shape...: Rect (Rectangular), Gaussian, Nyquist, or RootNyquist. For Nyquist and RootNyquist, set the rolloff ratio. Refer to <i>FFT and RBW</i> on page 3-179 for details. Note that the measurement filter shape can be selected by pressing Meas Setup > Measurement Filter Shape...	10 Hz to 10 MHz
Offset from Carrier <sup>1</sup>	Specifies which offset side is to be measured: Upper (positive), Lower (negative), or Both.	-
Fail if signal exceeds	Selects the method to detect fail in the pass/fail test. The choices are:  <ul style="list-style-type: none"> <li>■ Absolute. Fail is detected when one of the absolute measurement results is larger than the linearly-interpolated value between Beginning Absolute Limit and Ending Absolute Limit.</li> <li>■ Relative. Fail is detected when one of the relative measurement results is larger than the linearly-interpolated value between Beginning Relative Limit and Ending Relative Limit.</li> <li>■ Rel OR Abs. Fail is detected when one of the absolute measurement results is larger than the linearly-interpolated value between Beginning Absolute Limit and Ending Absolute Limit OR one of the relative measurement results is larger than the linearly-interpolated value between Beginning Relative Limit and Ending Relative Limit.</li> <li>■ Rel AND Abs. Fail is detected when one of the absolute measurement results is larger than the linearly-interpolated value between Beginning Absolute Limit and Ending Absolute Limit AND one of the relative measurement results is larger than the linearly-interpolated value between Beginning Relative Limit and Ending Relative Limit.</li> </ul>	-
Beginning Absolute Limit	Sets an absolute limit level at the Beginning Frequency.	-200 to 200 dBm
Ending Absolute Limit	Sets an absolute limit level at the Ending Frequency.	-200 to 200 dBm
Beginning Relative Limit	Sets a relative limit level at the Beginning Frequency.	-200 to 200 dBm
Ending Relative Limit	Sets a relative limit level at the Ending Frequency.	-200 to 200 dBm

<sup>1</sup> Available when **Offset From Channel** is selected for Measurement in the **Meas Setup** menu.

**Saving and Loading the Limit Mask.** The limit mask set in the limits editor can be saved to a CSV file (\*.csv) by pressing **Save > Save SEM Limits**, and loaded from the file by pressing **Load > Load SEM Limits**. Refer to *File Operations* on page 3-251 and *Limit Mask File Format* on page 3-279 for details.

## DPX Spectrum Display

DPX Spectrum technology enables you to see how traces change over time, displaying transient and intermittent events that cannot be seen on a swept spectrum analyzer. A DPX Spectrum indicates how traces change in two ways. First, it uses color grading to show how often a particular signal occurs. Second, it uses persistence to keep events visible in the display, allowing newer events to be compared to older events.

The DPX Spectrum display works by using a two-dimensional array to accumulate data points for the display. As shown in the Figure 3-18, input signal data after A/D conversion go through the proprietary DPX engine to compute more than 50,000 FFTs per second. These results are written to the pixel buffer memory. Each time a trace writes to a point on the display, a counter in the array is incremented. A color is assigned to each point in the display based on the value of its counter. Thus, as acquisitions occur over time, a colored waveform, the Bitmap, develops on the display that shows how frequently a display point has been addressed.

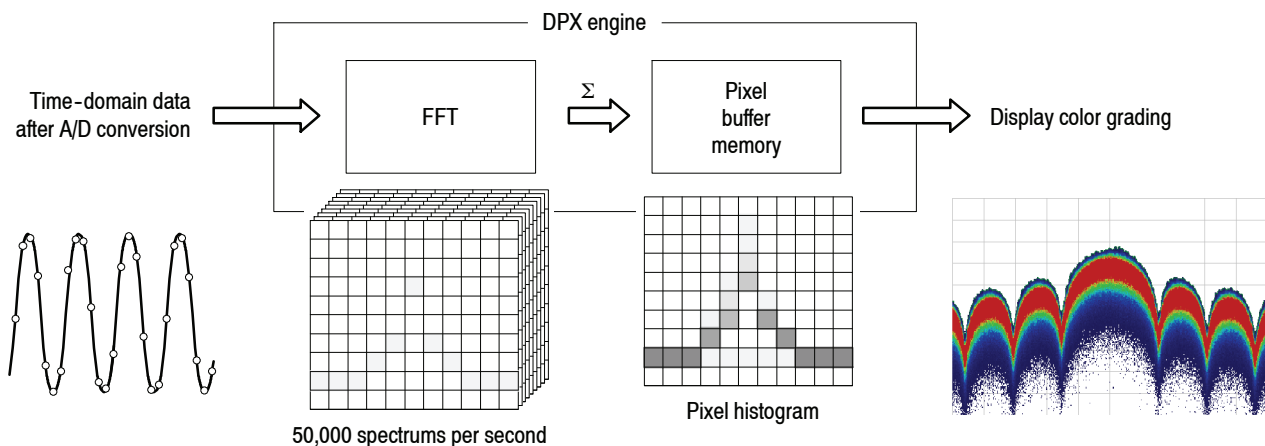


Figure 3-18: DPX process flow

### Displaying the DPX Spectrum

Use the following steps to display the DPX spectrum.

1. Press the **DPX** key on the front panel. (Or press **S/A > DPX Spectrum**.)
2. Press **Trace/Avg > Select Trace** to select **1** (Trace 1).
3. Press the **Trace 1 Type...** side key and select the type of Trace 1. Trace 1 defaults to Bitmap.
  - **Bitmap.** Displays the density of acquired data. The number of data points acquired at each pixel is indicated by color. Pressing the **Reset Bitmap** side key restarts the process.

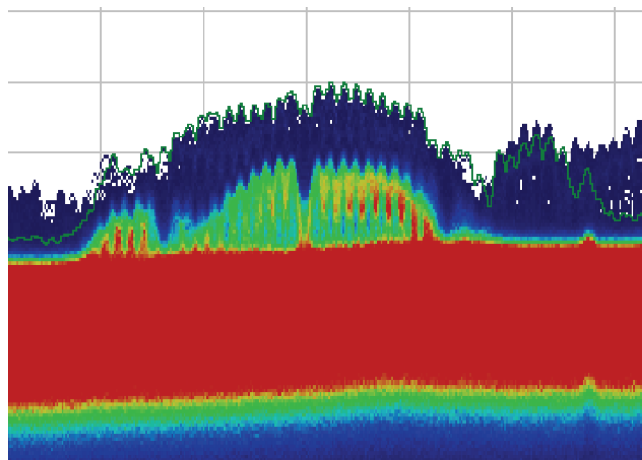


- **+Peak.** Displays the maximum amplitude acquired at each frequency in each screen update.
- **MaxHold.** Holds the maximum amplitude at each frequency. Pressing the **Reset MaxHold** side key restarts the process.
- **-Peak.** Displays the minimum amplitude acquired at each frequency in each screen update.
- **MinHold.** Holds the minimum amplitude at each frequency. Pressing the **Reset MinHold** side key restarts the process.
- **Average.** Computes the average amplitude of the spectrum points within each frequency bin to create a trace for each screen update, and then average the traces with the number set in the **Number Of Averages** side key to display. Pressing the **Reset Average** side key restarts the process.

Refer to *Trace Comparison Display and Average Function* on page 3-191 for the details.

4. Press **Select Trace** to select **2** (Trace 2).
5. Press the **Trace 2 Type...** side key and select the type of Trace 2. The selections are the same as Trace 1. Trace 2 defaults to **+Peak**.
6. Set the scale as needed by pressing **Scale/Lines > View Scale...** Refer to *Setting Views* on page 3-203 for the details.

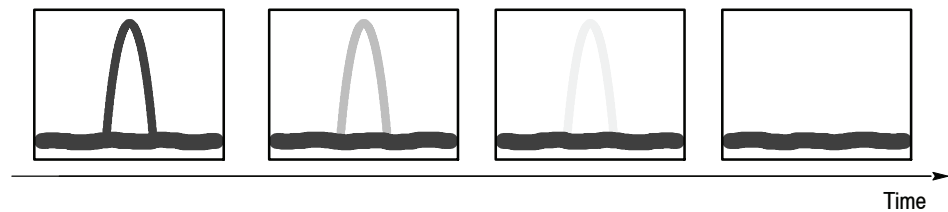
You can save and load a trace in a file with the extension of *.dpt* for the bitmap or *.trc* for other than bitmap using the **Save Trace 1/2** and **Load Trace 1/2** side keys in the Trace/Avg menu. Refer to *File Operations* on page 3-251 for the details.



**Figure 3-19: DPX spectrum display**

## Persistence

You can select the persistence mode for the Bitmap trace. While the screen display is generally updated periodically to rewrite waveforms, the persistence mode enables a data point once displayed to remain visible for a decay period. This allows you to see the history of occurrence for dynamic signals while still receiving immediate feedback on signal variations over time. You can adjust the persistence to optimize display characteristics for varying signal conditions, from a live RF view of dynamic signals to the discovery of single occurrences.



The persistence function facilitates observing single or intermittent events by fading out waveforms gradually. You can set a decay period ranging from zero to infinity.

**Figure 3-20: Persistence display**

Use the following steps to adjust the persistence.

1. Press the **Trace/Avg** key on the front panel.
2. Press the side key **Trace 1 (or 2) Type > Bitmap**.
3. Press the **Dot Persistence** side key to select the persistence mode.
  - **Off.** Disables the persistence mode. All points are reset every screen update.
  - **Variable.** Selects the variable persistence mode. Set a persistence time, that is how long a point in the display is visible before fading, using the **Persistence Value** side key.
  - **Infinite.** Selects the infinite persistence mode that prevents a point in the display from fading. Once a point in the display has been written to, it will remain visible until you press the **Reset Bitmap** side key.
4. When selecting the variable persistence mode, press the **Persistence Value** side key to set the persistence time. Range: 1 to 1000 (no unit, default: 10)
5. Press the **Intensity** side key to control the visibility of events. An increased intensity level allows a single, short event to be seen. This also allows the effect of variable persistence to be seen on infrequent events. Range: 1 to 100% (default: 25%).

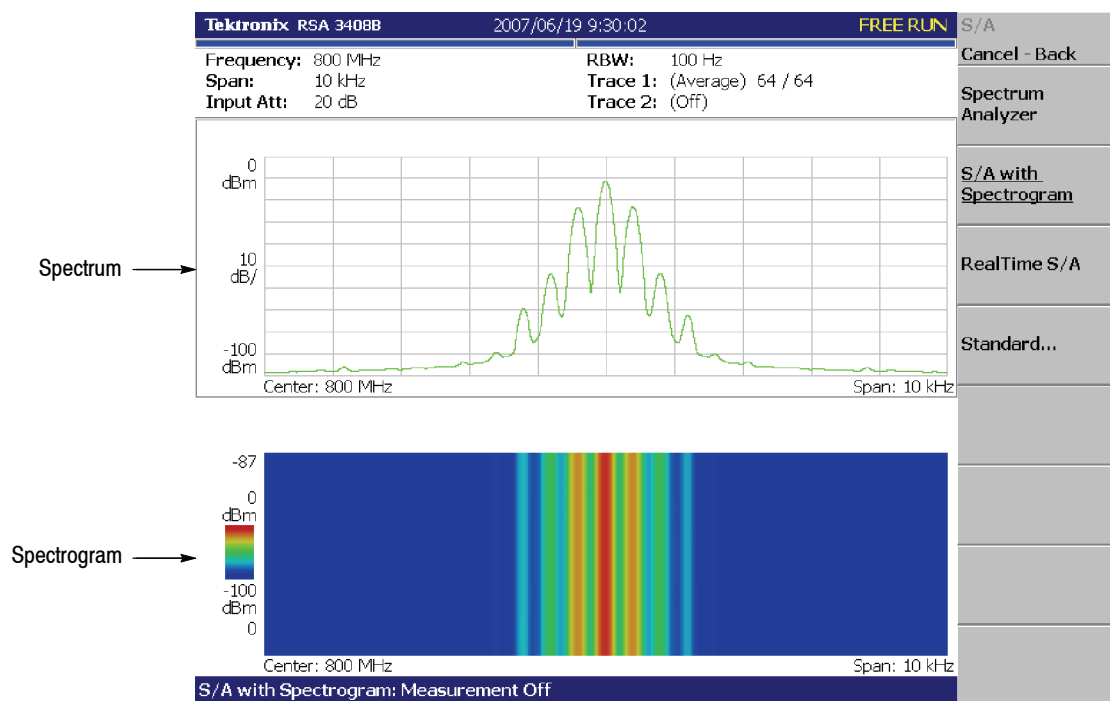
## Spectrogram Display

You can display the spectrum of an input signal concurrently with the spectrogram.

Follow these steps to display the spectrogram:

1. Press the **S/A** key on the front panel.
2. Press the **S/A with Spectrogram** side key.

The spectrum and spectrogram are displayed on the same screen as shown in Figure 3-21.

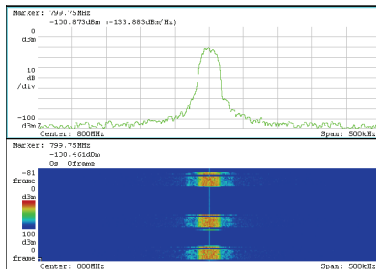


**Figure 3-21: Spectrum and spectrogram concurrent display**

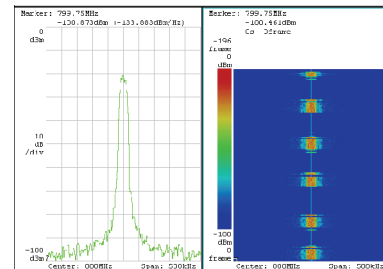
### Changing Display Style

You can change display style as required.

1. Press the View: **Define** key.
2. Press the **View Orientation** side key to select the view style: **Wide** or **Tall**.



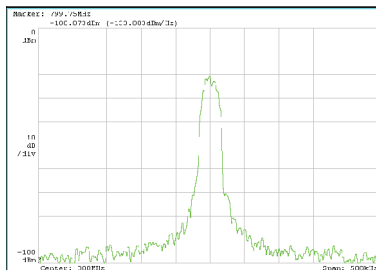
**Wide display**  
Displays spectrum and spectrogram in line-split display.



**Tall display**  
Display spectrum and spectrogram side by side.

**Figure 3-22: View orientation**

3. When you display either spectrum or spectrogram only on full-screen, press the View: **Select** key to select the view. The selected view is surrounded by a light-blue frame.
4. Press the **Show Views** side key and select **Single** as shown in Figure 3-23.



**Single display**  
Displays the selected view on one screen.

**Figure 3-23: Single display**

Refer to *Setting Views* on page 3-203 for details.

## Real-Time Analysis

When you select **S/A > Real Time S/A** or **Real Time S/A with Zoom**, the analyzer performs the real-time analysis, displaying the spectrogram. Refer to *Spectrogram Display* on page 3-21 for the display. Refer to *Zoom Function* on page 3-27 for the zoom.

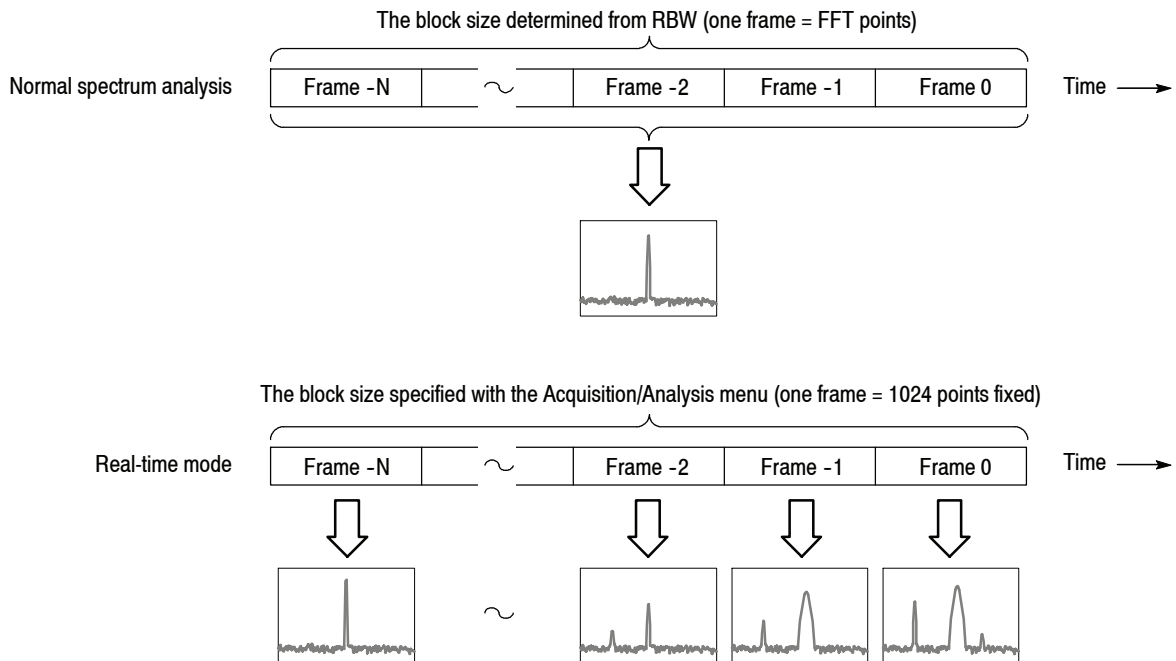
---

**NOTE.** *The Real-Time S/A mode has FFT overlap capability. Refer to FFT and RBW on page 3-179 for detail.*

---

### Features of the Real-Time Mode

An input waveform is acquired in blocks, where a block is defined as a number of frames and a frame is defined as a number of FFT data points. The number of frames acquired at one time is called block size. In the normal spectrum analysis, the instrument acquires data for the block size determined from RBW and creates one spectrum waveform. In the real-time mode, the instrument acquires data for the block size specified with the Acquisition/Analysis menu, performs the FFT process, and creates spectrum waveforms for each frame so that you can observe spectrum variation in time seamlessly. The difference between normal and real-time modes is shown in Figure 3-24.



**Figure 3-24: Difference between normal and real-time modes**

Table 3-4 shows the features of the real-time mode compared with the normal spectrum analysis.

**Table 3-4: Features of the real-time mode**

Item	Normal spectrum analysis	Real-time mode
Span	Up to 3 GHz (arbitrary value can be set)	Up to 36 MHz (1-2-5 sequence)
Trigger	Only the Repeat menu item available	All the Trigger menu items available
RBW/FFT	FFT points: 64 to 8192 (powers of 2) RBW: 1 Hz to 10 MHz	FFT points: 1024 fixed RBW: No RBW process FFT overlap capability
Timing	No acquisition and analysis parameters	Acquisition Length and Spectrum Offset can be set

### Basic Procedure

The following steps show the basic procedure for real-time spectrum analysis with spectrogram:

1. Press the **S/A** key on the front panel.
2. Press the **Real Time S/A** side key. The spectrum is displayed concurrently with the spectrogram.
3. Display the spectrum waveform of the measurement signal:

---

**NOTE.** For details on setting frequency, span, and amplitude, refer to Setting Frequency and Span on page 3-135 and Setting Amplitude on page 3-143.

For details on setting trigger, refer to Trigger on page 3-163.

---

- a. Set the frequency by pressing the **Frequency/Channel** key on the front panel.
- b. Set the span by pressing the **Span** key on the front panel. Table 3-5 shows the span setting range.
- c. Set the amplitude by pressing the **Amplitude** key on the front panel.
- d. Set the trigger by pressing the **Trig** key on the front panel.

**Table 3-5: Span setting range in the real-time mode**

Measurement band	Setting range
Baseband (DC to 40 MHz)	100 Hz to 40 MHz (1-2-5 sequence)
RF (40 MHz to 8 GHz)	100 Hz to 20 MHz (1-2-5 sequence) and 36 MHz

4. Press the **Acquisition/Analysis** key on the front panel and then the **Acquisition Length** side key to set the time length to acquire one block.

Suppose that one block contains N frames; the acquisition length is calculated with this equation:

$$(\text{One block acquisition length}) = N \times (\text{One frame acquisition length})$$

Where N = 1 to 16000 (standard) or 64000 (Option 02)

One frame acquisition length is determined by span internally, and shown with **Spectrum Length** in the setup display area (see Figure 3-25). For the details, refer to *Specifications* in the *RSA3408B Technical Reference*.

Waveform data is acquired and displayed on the basis of blocks. For details about the time parameters, refer to page 3-157.

5. When you have acquired the measurement data, stop the data acquisition. If the analyzer is in the continuous acquisition mode, press **Run/Stop**.
6. Press the **Spectrum Offset** side key and set the number of the frame to measure and display in the spectrum view (upper view) by turning the general purpose knob or using the numeric keypad.

Serial numbers are given to each frame regardless of the block size, with zero representing the latest frame. The selected frame is indicated by the marker on the spectrogram (see Figure 3-25).

Alternatively, the frame number can be set as follows:

- a. Press the View: **Select** key to select the spectrogram view.
  - b. Press the **Marker Setup** key.
  - c. Press the **Go to page 2 > Marker X Vertical** side key.
  - d. Set the frame number by turning the general purpose knob or using the numeric keypad.
7. To take a spectrum measurement, press the **Measure** key on the front panel. The measurement items and procedures are the same as in the normal spectrum analysis. Refer to *Spectrum Analysis* on page 3-4.
  8. To change the display format, press the **Define** key on the front panel. The setting procedure is the same as in the normal spectrum analysis. Refer to *Spectrogram Display* on page 3-21.

---

**NOTE.** In the real-time mode, you cannot turn on or off the spectrogram in the View: Define menu.

---

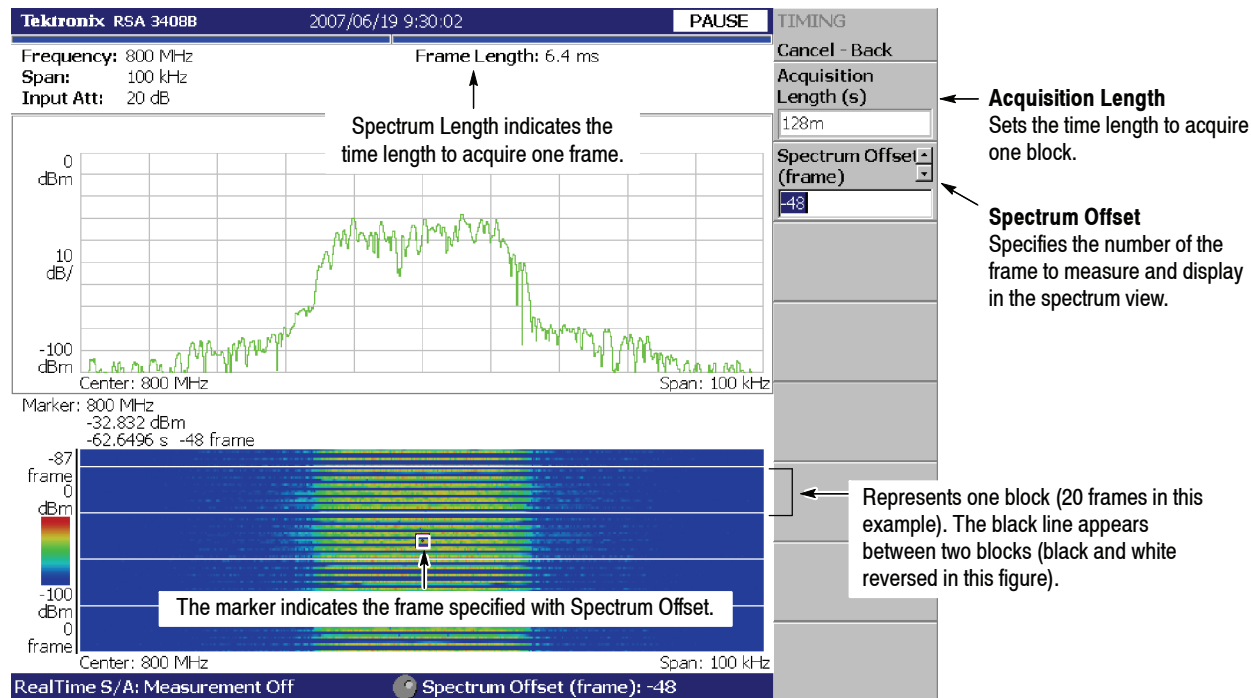


Figure 3-25: Real-time mode

### Trace Averaging

You can use the averaging to reduce noise on the spectrum trace.

1. Press the **Trace/Avg** key on the front panel to select **Trace Type... > Average**.
2. Press the **Number Of Averages** side key and set the average count.

For each acquisition of a block of data, the analyzer takes traces as many as specified by **Number Of Averages** from the trigger point to perform averaging. The frames used for averaging are surrounded by a green box on the spectrogram (see Figure 3-26).

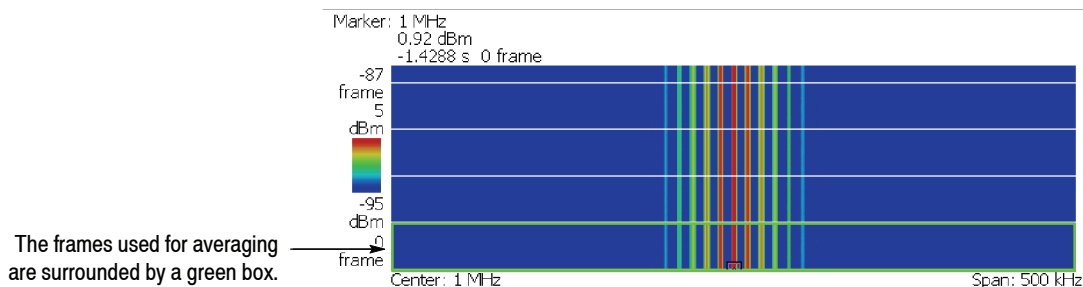
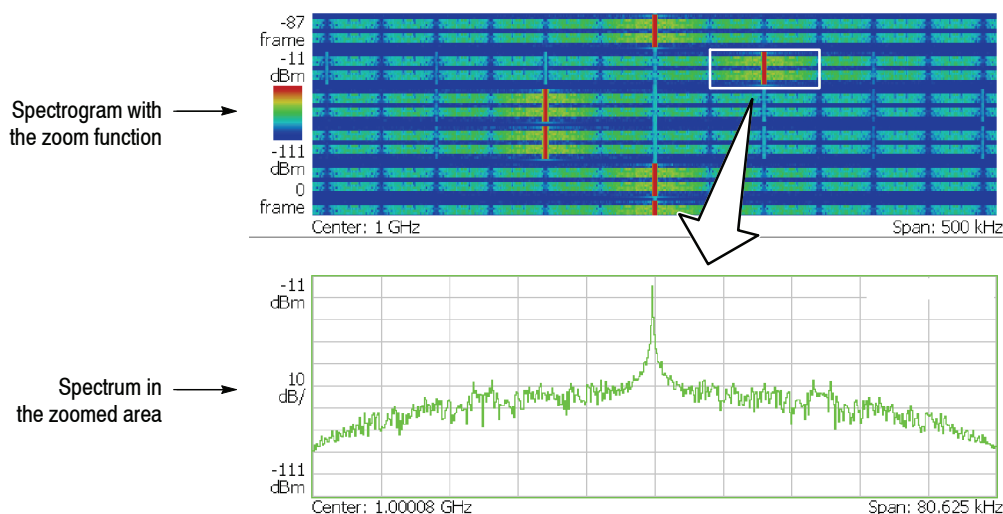


Figure 3-26: Spectrogram display in averaging



## Zoom Function

When you select **S/A > Real Time S/A with Zoom**, the real-time analysis area can be specified on the spectrogram. Even though frequency hopping occurs, measurement can only be made by clipping the optional burst (see Figure 3-27).



**Figure 3-27: Zoom function**

### Acquisition /Analysis Menu

In the spectrogram with the zoom function display, the zoomed area is set by the following Acquisition/Analysis menu (see Figure 3-28). The area is the analysis range.

**Acquisition Length.** Sets the capture time of one block.

**Acquisition History.** A block number that analyzes/displays data is specified. The latest block number is 0. Older blocks have larger negative numbers.

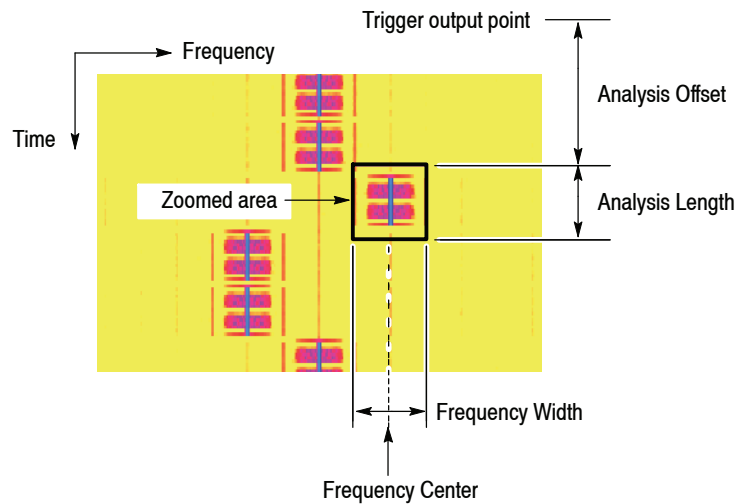
**Analysis Length.** Sets the time length of the zoomed area in the block set in the Acquisition History.

**Analysis Offset.** Sets the starting point of the zoomed area by considering the trigger output point as the reference.

**Frequency Center.** Sets the frequency of the center of zoomed area.

**Frequency Width.** Sets the frequency width of the zoomed area.

Refer to *Setting Acquisition and Analysis Parameters* on page 3-157.



**Figure 3-28: Zoom domain settings using the acquisition and analysis menu**

### Setting a Zoomed Area Using the Marker

The zoomed area can be set by using the marker and reference cursor instead of entering a numeric value in the Acquisition/Analysis menu (see Figure 3-29). The mouse can also be used in the marker operation (refer to *USB connectors* on page 2-7 for connecting the mouse). In the following procedure, [Mouse] indicates an operation where the mouse is used.

1. Press the View: **Select** key on the front panel and select the spectrogram with zoom function.

[Mouse] Click on the spectrogram to select it and then go to step 4.

2. Press the **Marker Setup** key on the front panel.
3. Press the **Markers** side key and select **Single** to display the marker.

4. Move the marker to the upper left point of the zoomed area using the **Marker X Position** and the **Marker X Vertical** side keys.

[Mouse] Move the mouse pointer to the upper left point of the zoomed area and left-click to put the marker on it.

5. Press the **Reference Cursor to the Marker X** side key to display the reference cursor on the marker position.

[Mouse] Right-click to display the reference cursor.

6. Move the marker to the lower right point of the zoomed area using the **Marker X Position** and **Marker X Vertical** side keys.

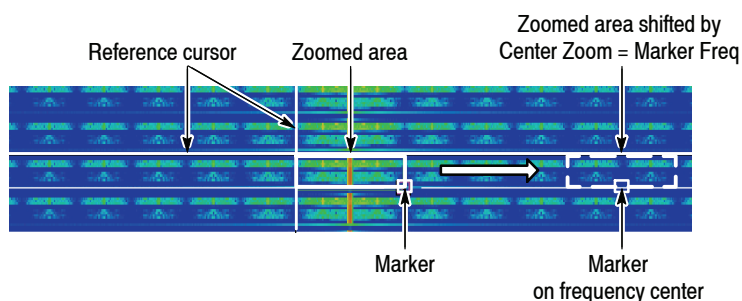
[Mouse] Move the mouse pointer to the lower right point of the zoomed area and left-click to put the marker on it.

7. Press the **Marker**  $\Rightarrow$  key on the front panel, and then press the **Analysis Time = Marker Time** side key.

The zoomed area is enclosed in a green frame.

8. When you shift the zoomed area to the left or right on the frequency axis, perform these steps:
  - a. Select **Marker Setup > Marker X Position** and set the new frequency center to put the marker on it.  
  
[Mouse] Move the mouse pointer to the new frequency center and then left-click to put the marker on it.
  - b. Select **Marker**  $\Rightarrow$  **> Center Zoom = Marker Freq.**

The zoomed area shifts to the specified frequency.



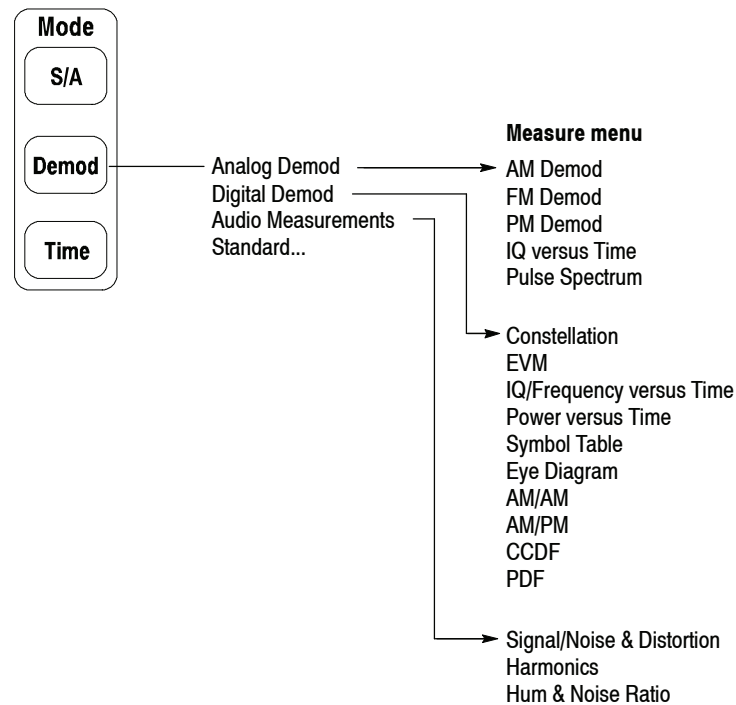
**Figure 3-29: Zoomed area settings using the marker**

**NOTE.** The zoomed spectrum is calculated based on time domain data acquired with a higher sampling rate than for obtaining a normal spectrum. So, a large zoom ratio may cause the skirt shape of the spectrum to differ from that of the spectrum without zoom. However, it does not affect carrier power measurement results.



# Modulation Analysis (Demod Mode)

This section describes how to perform measurements in the modulation analysis (Demod) mode.



**Figure 3-30: Demod menu structure**

There are four items in the Demod menu:

- **Analog Demod.** Performs analog modulation analysis. Refer to page 3-41 for details.
- **Digital Demod.** *Option 21 Only.* Performs digital modulation analysis. Refer to page 3-48 for details.
- **Audio Measurements.** *Option 10 Only.* Performs audio analysis. Refer to page 3-67 for details.
- **Standard...** Performs modulation analysis according to a communication standard. For details, refer to the user manual included in each option as shown in Table 3-6. For RFID analysis, refer to page 3-77.

**Table 3-6: Standard menu in the Demod mode**

<b>Menu item</b>	<b>Option</b>	<b>Description</b>
W-CDMA-UL	Option 30	W-CDMA uplink analysis
3GPP-R5-DL	Option 30	3GPP Release 5 downlink analysis
3GPP-R5-UL	Option 30	3GPP Release 5 uplink analysis
3GPP-R6-DL	Option 40	3GPP Release 6 downlink analysis
3GPP-R6-UL	Option 40	3GPP Release 6 uplink analysis
TD-SCDMA	Option 28	TD-SCDMA analysis
GSM/EDGE	Option 24	GSM/EDGE analysis
cdma2000-Fwd	Option 25	cdma2000 forward link analysis
cdma2000-Rev	Option 25	cdma2000 reverse link analysis
1xEV-DO-Fwd	Option 26	cdma2000 1xEV-DO forward link analysis
1xEV-DO-Rev	Option 26	cdma2000 1xEV-DO reverse link analysis
IEEE802.11a/b/g	Option 29	WLAN 802.11a/b/g analysis
802.11n (nx1)	Option 29	WLAN 802.11n (nx1) analysis
802.11n MIMO (2x2)	Option 29	WLAN 802.11n MIMO (2x2) analysis
RFID	Option 21	RFID analysis

## Measurement Screen Layout

The following three views are displayed on screen by default in the Demod mode (see Figure 3-31):

- Overview:** Displays all data in one acquisition block. The Timing field at the bottom of the overview indicates the contents of the main view and the subview, as well as the trigger point. For information about the trigger point, refer to *Trigger Point Indicator* on page 3-177.
- Main view:** Displays the measurement results and waveform for the range specified by the green horizontal line in the overview. Some measurements show the results and waveform separately on the right and left sides of the main view.
- Subview:** Displays the spectrum (default). The FFT processing range is indicated by the pink horizontal line shown in the overview.

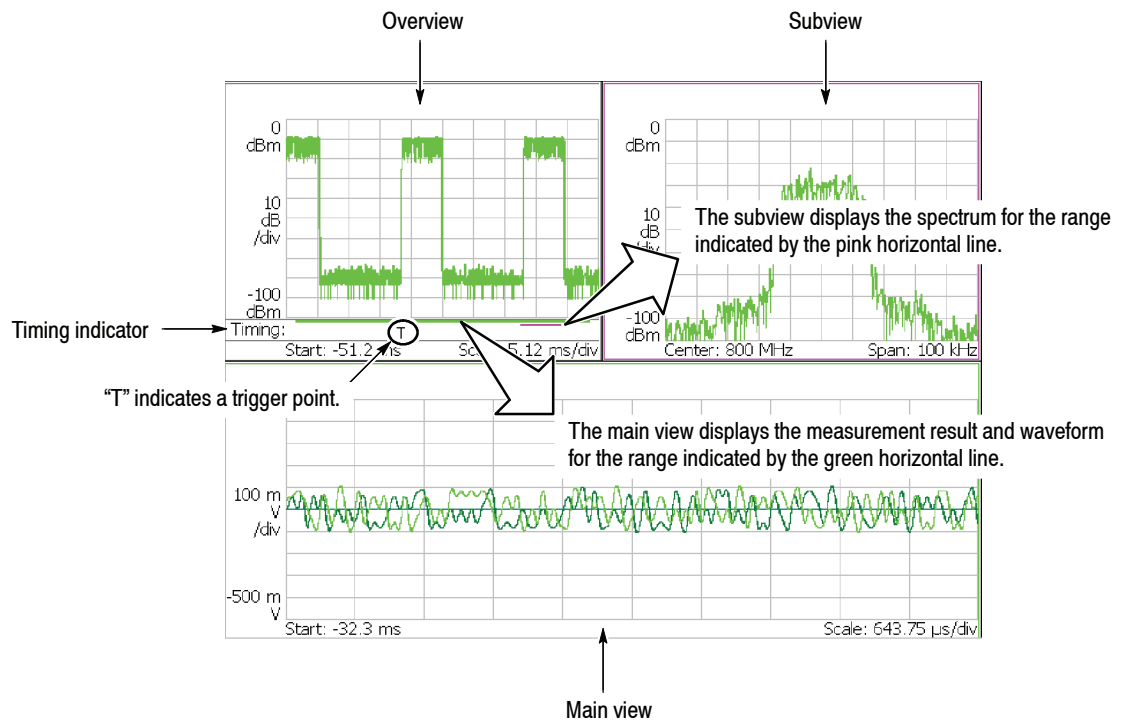


Figure 3-31: Demod mode screen

### Setting the Analysis Range

The analysis is performed for the range specified in the overview (see Figure 3-32), and then the measurement result and waveform are displayed in the main view. Set the analysis range after data acquisition with the following procedure, using the Acquisition/Analysis menu. The range is indicated by green lines.

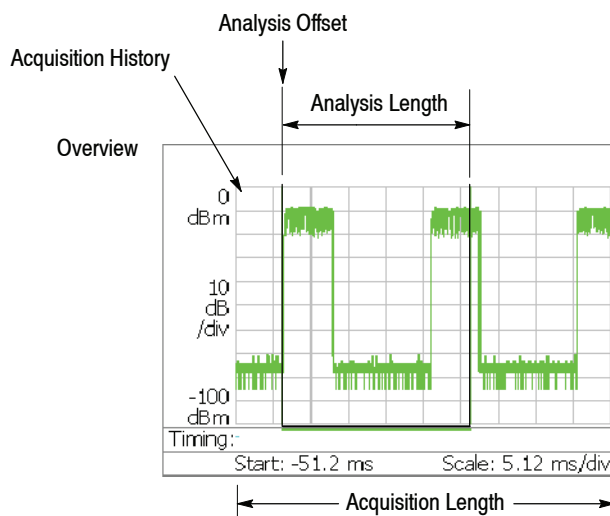
1. Press the **Acquisition/Analysis** key on the front panel.
2. Set the time length to acquire one block by pressing the **Acquisition Length** side key.

Suppose that one block contains N frames; the acquisition length is calculated with this equation:

$$(\text{One block acquisition length}) = N \times (\text{One frame acquisition length})$$

One frame acquisition length is determined by span and indicated on the **Spectrum Length** side key.

3. *For data acquired in the continuous mode:*  
Specify the number of the block to be analyzed by pressing the **Acquisition History** side key. 0 (zero) represents the latest block.
4. Specify the time length of analysis range by pressing the **Analysis Length** side key.
5. Specify the start point of the analysis range by pressing the **Analysis Offset** side key.

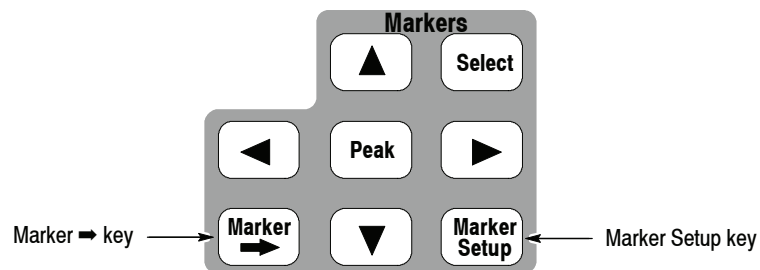


**Figure 3-32: Analysis range setting in the overview**



**Specifying Origin of Analysis Range Using the Marker.** You can also use the marker (□) in place of the **Analysis Offset** side key to specify the origin of analysis range. Do the following steps in place of step 5 on the previous page.

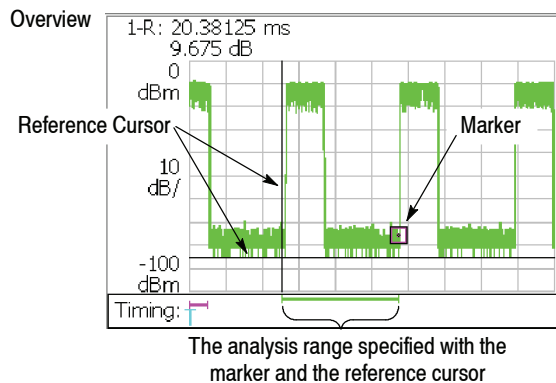
1. Press the **Marker Setup** key on the front panel (see Figure 3-33).
2. Press the **Markers** side key to select **Single**.  
The marker (□) appears on the screen.
3. Rotate the general purpose knob to move the marker to the measurement starting point.
4. Press the **Marker** ➔ key on the front panel and then press the **Analysis Time = Marker Time** side key. The green line resizes to the specified range.



**Figure 3-33: Marker keys**

**Specifying Analysis Range Using the Marker and Reference Cursor.** You can use the marker and the reference cursor in place of the **Analysis Length** and the **Analysis Offset** side keys to specify the analysis range. Perform the following steps in place of steps 4 and 5 on page 3-34.

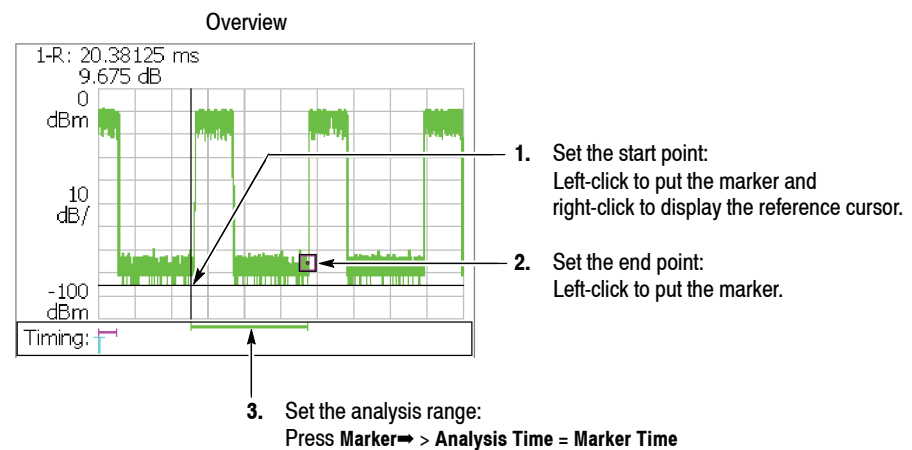
1. Press the View: **Select** key on the front panel to select the overview.
2. Press the **Marker Setup** key on the front panel.
3. Press the **Markers** side key to select **Single**.  
The marker ( $\square$ ) appears on the screen.
4. Rotate the general purpose knob to move the marker to the measurement start point.
5. Press the **Reference Cursor to Marker X** side key.  
The reference cursor appears at the marker position (see Figure 3-34).
6. Rotate the general purpose knob to move the marker to the measurement end point.
7. Press the **Marker**  $\Rightarrow$  key on the front panel and then press the **Analysis Time = Marker Time** side key. The green line resizes to the specified range.



**Figure 3-34: Specifying the range with the marker and the reference cursor**

**Specifying Analysis Range Using a Mouse.** You can use a USB mouse in place of the **Analysis Length** and the **Analysis Offset** side keys to set the analysis range. Perform the following steps in place of steps 4 and 5 on page 3-34. For connecting the mouse, refer to page 2-7.

1. Click on the overview to select it.
2. Move the mouse pointer to the measurement start point, and then left-click to put the marker on it. See Figure 3-35.
3. Right-click to display the reference cursor.
4. Move the mouse pointer to the measurement end point, and then left-click to put the marker on it.
5. Press the **Marker**  $\Rightarrow$  key on the front panel and then press the **Analysis Time = Marker Time** side key. The green line resizes to the specified range.



**Figure 3-35: Specifying the analysis range using the mouse**

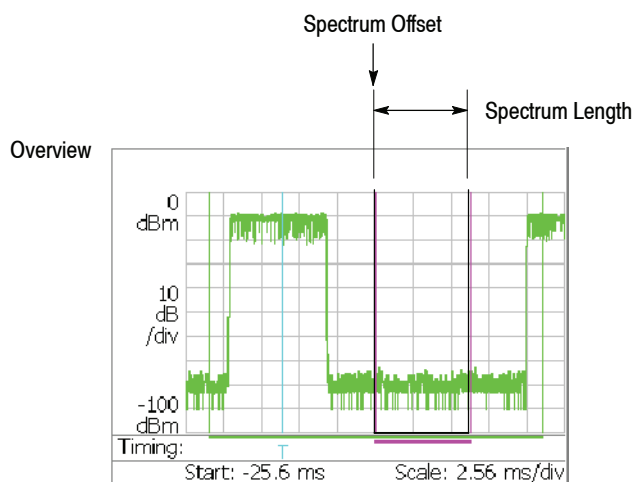
### Setting FFT Processing Range for the Subview

Set the FFT processing range (shown in Figure 3-36) for the spectrum displayed in the subview with the following procedure using the Acquisition/Analysis menu after data acquisition. The range is indicated by a pink line.

1. Press the **AcquisitionAnalysis** key on the front panel.

The **Spectrum Length** side key shows the time for creating the FFT available in the subview. It is determined by the span internally.

2. Press the **Spectrum Offset** side key and specify the beginning of the range using the general purpose knob or numeric input keypad.



**Figure 3-36: FFT processing range setting on the overview**

### Changing the Overview and Subview

By default, the overview shows the waveform representing the signal level change over time, and the subview shows the spectrum waveform. To change the views, use the following procedure:

---

**NOTE.** You can change the subview only in the digital modulation analysis (Option 21).

---

1. Press the View: **Define** key on the front panel.
2. Press the **Overview Content...** side key and select the overview:
  - Waveform (Amplitude versus Time, default display)
  - Spectrogram

The overview displays all data in one acquisition block.

In the RFID analysis (Option 21, refer to page 3-77), you can also select Zoom (spectrogram with zoom function) for the overview.

3. *Digital modulation analysis (Option 21) only*  
Press the **Subview Content...** side key and select a view.

The subview content depends on measurement. Refer to each measurement description.

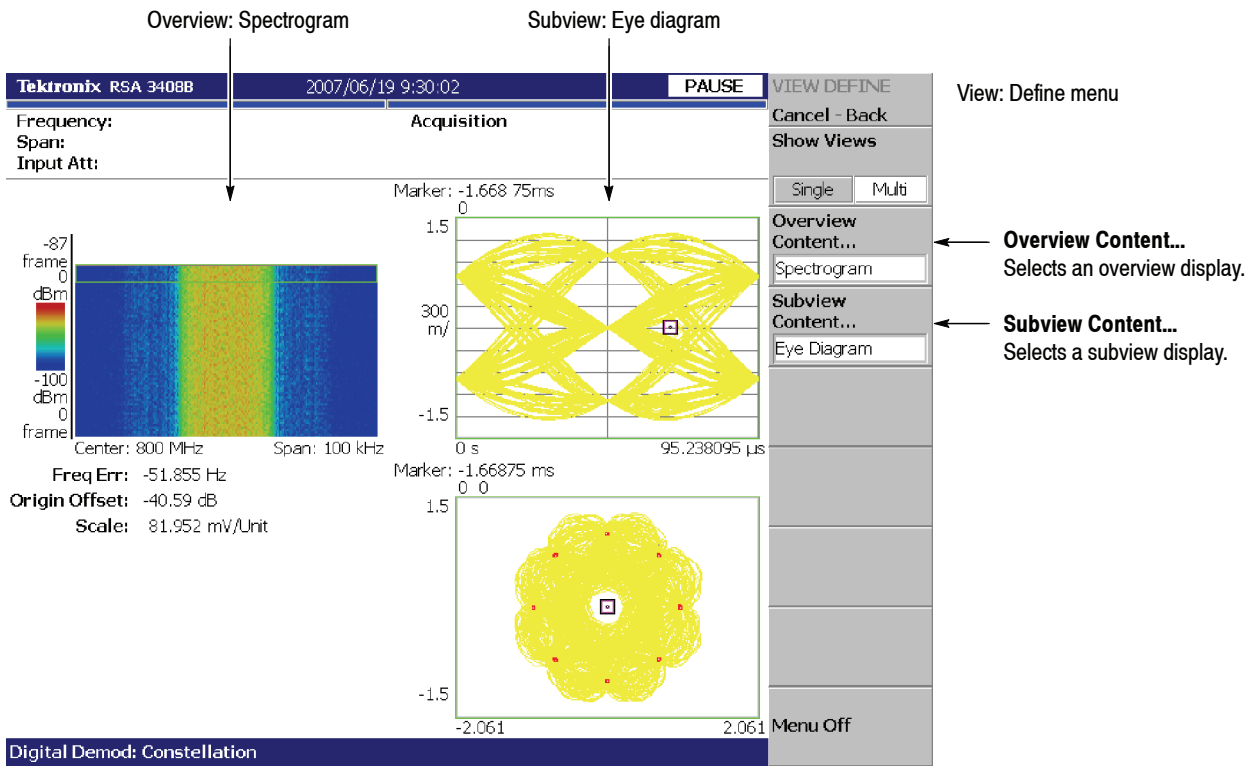
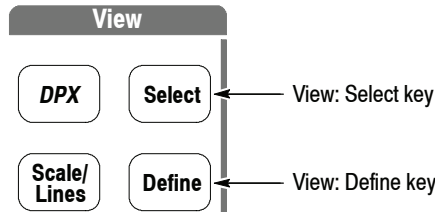


Figure 3-37: Changing the overview and subview

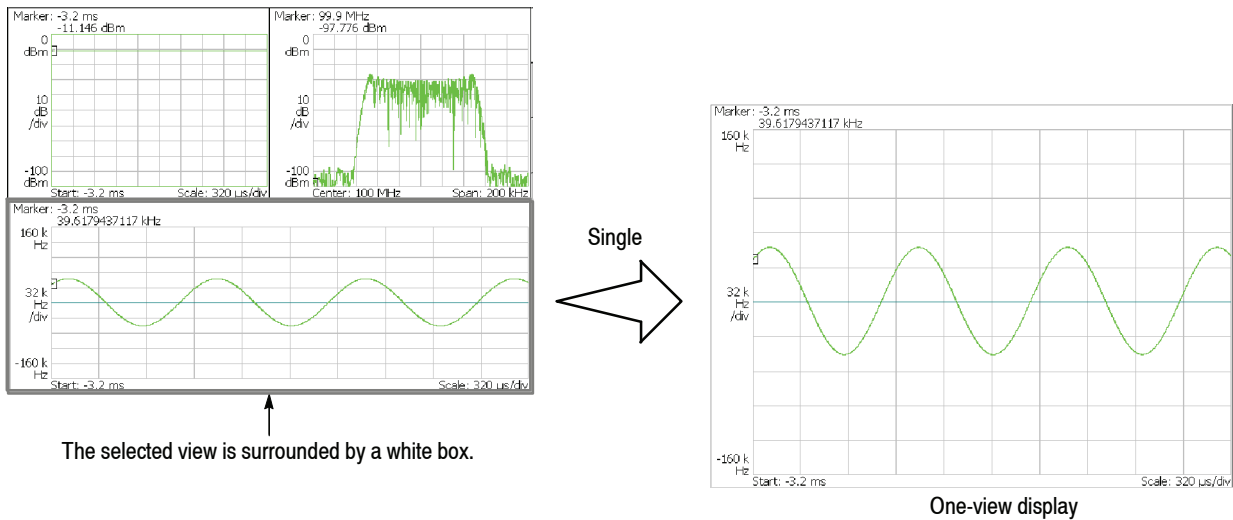
**One-View Display**

Three views are displayed on screen by default. To display one view, perform the following steps:

1. Press the View: **Define** key on the front panel.



2. Select a view to make the single display by pressing the **Select** key in the View area. The selected view is surrounded by a white box.
3. Press the **Show Views** side key to select **Single**. Figure 3-38 shows the one view display.



**Figure 3-38: One-view display**

## Analog Modulation Analysis

You can select the following measurement items with the **Measure** key when you select **Analog Demod** in the Demod menu.

- AM Demod page 3-43
- FM Demod page 3-44
- PM Demod page 3-45
- IQ versus Time page 3-46
- Pulse Spectrum page 3-47

### Basic Procedure

Follow this procedure to perform analog modulation analysis:

1. Press the Mode: **Demod** key on the front panel.
2. Press the **Analog Demod** side key.
3. Select a measurement item.
4. Display the measurement waveform:

---

**NOTE.** You should set appropriate frequency and span. It is important to set frequency and span as close to the measurement signal band as possible and finely adjust them. The modulated signal will not be recognized unless frequency and span are set appropriately.

For information about setting frequency, span, and amplitude, refer to Setting Frequency and Span on page 3-135 and Setting Amplitude on page 3-143.

---

- a. Set frequency by pressing the **Frequency/Channel** key on the front panel.
  - b. Set span by pressing the **Span** key on the front panel.
  - c. Set amplitude by pressing the **Amplitude** key on the front panel.
5. Set analysis range by pressing the **Acquisition/Analysis** key on the front panel. Refer to page 3-34 for information about setting the analysis range.
  6. Set the measurement parameters by pressing the **Meas Setup** key on the front panel. For the Meas Setup menu, refer to the following sections.

**ASK/FSK Modulation Analysis.** Basic ASK and FSK modulation analysis can be performed using Analog Modulation Analysis. This analysis includes frequency deviation and depth of modulation. Typical settings are as follows:

■ ASK signal measurement

Measurement item . . . AM Demod  
Span . . . . . 500 kHz  
Acquisition Length . . . 10.24 ms

■ FSK signal measurement

Measurement item . . . FM Demod  
Span . . . . . 500 kHz  
Acquisition Length . . . 10.24 ms  
Vertical Scale . . . . . 1.6 MHz (deviation scale: 800 kHz)

The following pages show examples for each measurement item. Refer to page 3-203 for information about setting scale and formatting each view. Refer to page 3-38 for information about changing the overview and subview.



**AM Demod Measurement**

Demodulates and measures an AM signal. Figure 3-39 shows an example. The main view displays the measurement results and the modulation factor versus time graph. **Measure > Show Measurements** is selected in Figure 3-39.

The modulation factor is defined by the following equation:

$$(\text{modulation factor}) = (A_m - A_0) / A_0$$

Where

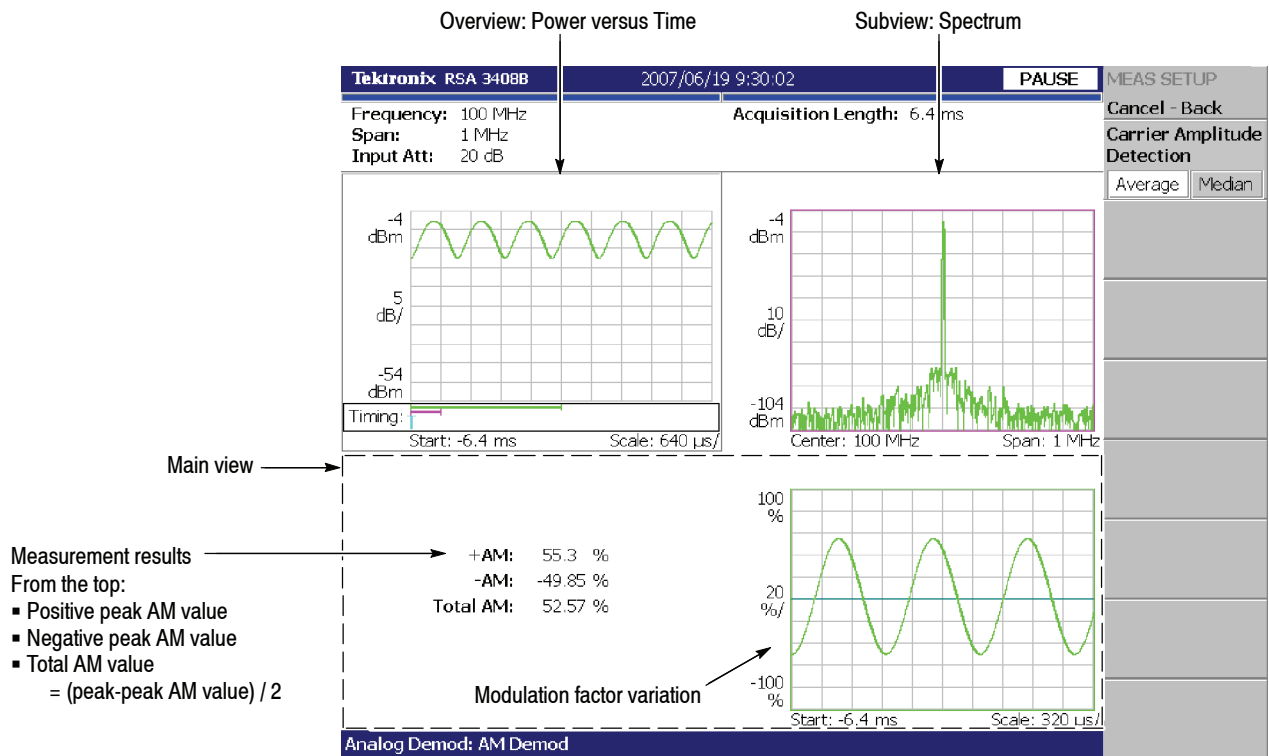
$A_m$ : Amplitude of the modulation signal

$A_0$ : Amplitude of the carrier with no modulation (0% modulation)

**Meas Setup Menu.** The Meas Setup menu for the AM demod measurement contains the following control:

**Carrier Amplitude Detection.** Selects how to calculate the amplitude of the carrier with no modulation ( $A_0$  in the above equation).

- **Average. Default.** Defines  $A_0$  as the average amplitude in the analysis range.
- **Median.** Defines  $A_0$  as the median amplitude ( $[(\text{maximum})+(\text{minimum})]/2$ ) in the analysis range.



**Figure 3-39: AM demod measurement**

### FM Demod Measurement

Demodulates and measures an FM signal. Figure 3-40 shows an example. The main view displays the measurement results and the frequency deviation versus time graph. **Measure > Show Measurements** is selected in Figure 3-40.

**Meas Setup Menu.** The Meas Setup menu for the FM demod measurement contains the following controls:

**Auto Carrier.** Determines whether to detect the carrier automatically.

- **On. Default.** Automatically detects the carrier for every frame. The error from the center frequency is shown on the **Freq Error** side key.
- **Off.** Sets the carrier frequency using **Frequency Offset** described below.

**Frequency Offset.** Sets the carrier frequency when Off is selected in Auto Carrier. Enter the carrier offset from the center frequency. Range: -30 to +30 MHz.

**Threshold.** Sets the threshold level above which the input signal is determined to be a burst in time domain. The burst detected first is used for the measurement. Range: -100.0 to 0.0 dB.

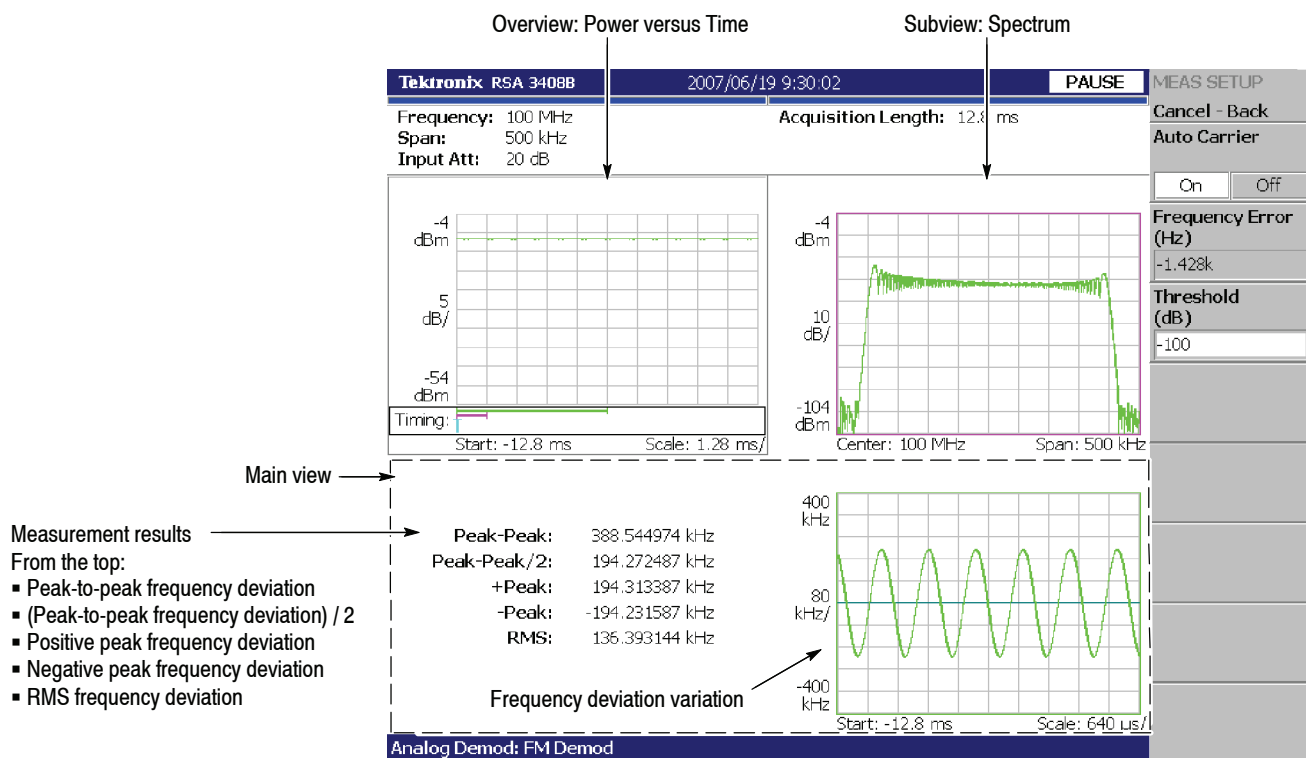


Figure 3-40: FM demod measurement

**PM Demod Measurement**

Demodulates and measures a PM signal. Figure 3-41 shows an example. The main view displays the phase error versus time graph.

**Meas Setup Menu.** The Meas Setup menu for the PM demod measurement contains the following controls:

**Auto Carrier.** Determines whether to detect the carrier automatically.

- **On. Default.** Automatically detects the carrier for every frame.

For the center frequency set by pressing **Frequency/Channel** > **Center Freq**, there is a relation:

$$(\text{Carrier frequency}) = (\text{Center frequency}) + (\text{Frequency offset})$$

The carrier frequency is indicated in the **Carrier Frequency** side key and the frequency offset in the **Frequency Error** side key.

- **Off.** Sets the carrier frequency using **Carrier Frequency** or **Frequency Offset** described below. **Carrier Frequency** and **Frequency Offset** are interlocked.

**Carrier Frequency.** Sets the carrier frequency when Off is selected in Auto Carrier. Range:  $(\text{Center frequency}) \pm (\text{Span})/2$ .

Pressing **Marker**⇒ > **CarrierFreq=MarkerFreq** sets the carrier frequency to the value at the Marker 1 position.

**Frequency Offset.** Sets the frequency offset when Off is selected in Auto Carrier. Range:  $-(\text{Span})/2$  to  $+(\text{Span})/2$ .

**Auto Phase.** Determines whether to set the phase offset automatically.

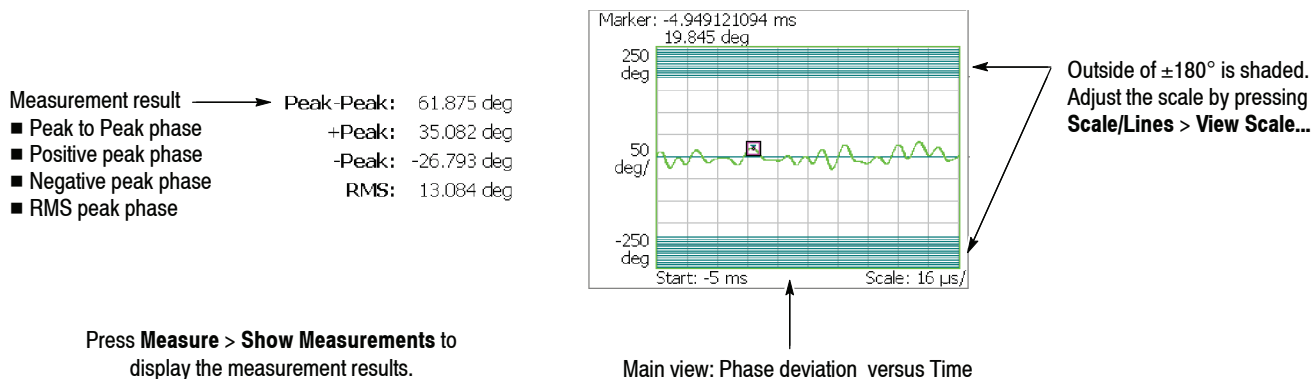
- **On. Default.** Automatically sets the phase offset to fit the waveform to the screen centering  $0^\circ$  phase on the vertical axis. The phase offset is indicated on the **Phase Offset** side key.

- **Off.** Sets the phase offset using **Phase Offset** described below.

**Phase Offset.** Sets the phase offset when Off is selected in Auto Phase. For example, when setting  $10^\circ$ , the waveform shifts upward by  $10^\circ$  on screen. Range:  $-180$  to  $+180^\circ$ .

Pressing **Marker**⇒ > **MarkerPhase to Zero** puts the center ( $0^\circ$  phase) of the vertical axis at the Marker 1 position.

**Threshold.** Sets the threshold level above which the input signal is determined to be a burst in time domain. The burst detected first is used for the measurement. Range:  $-100.0$  to  $0.0$  dBfs (default:  $-35$  dBfs).



**Figure 3-41: PM demod measurement (main view)**

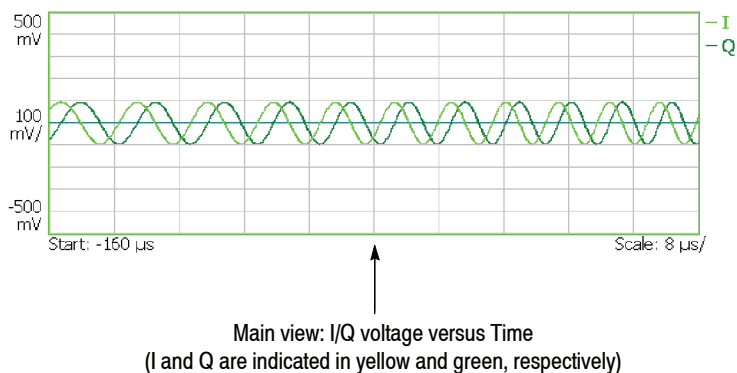
You can display the measurement results in the analysis range on the left side of the main view (see Figure 3-41) by pressing **Measure** > **Show Measurements**.

You can select degree or radian for the angular unit by pressing **System** > **Instrument Setup...** > **Angular Units**.

**IQ versus Time Measurement**

“IQ versus Time” measures I and Q level over time. Figure 3-42 shows an example. The main view shows the I/Q voltage versus time graph. I and Q are indicated in yellow and green, respectively.

The IQ level measurement has no Meas Setup menu items.

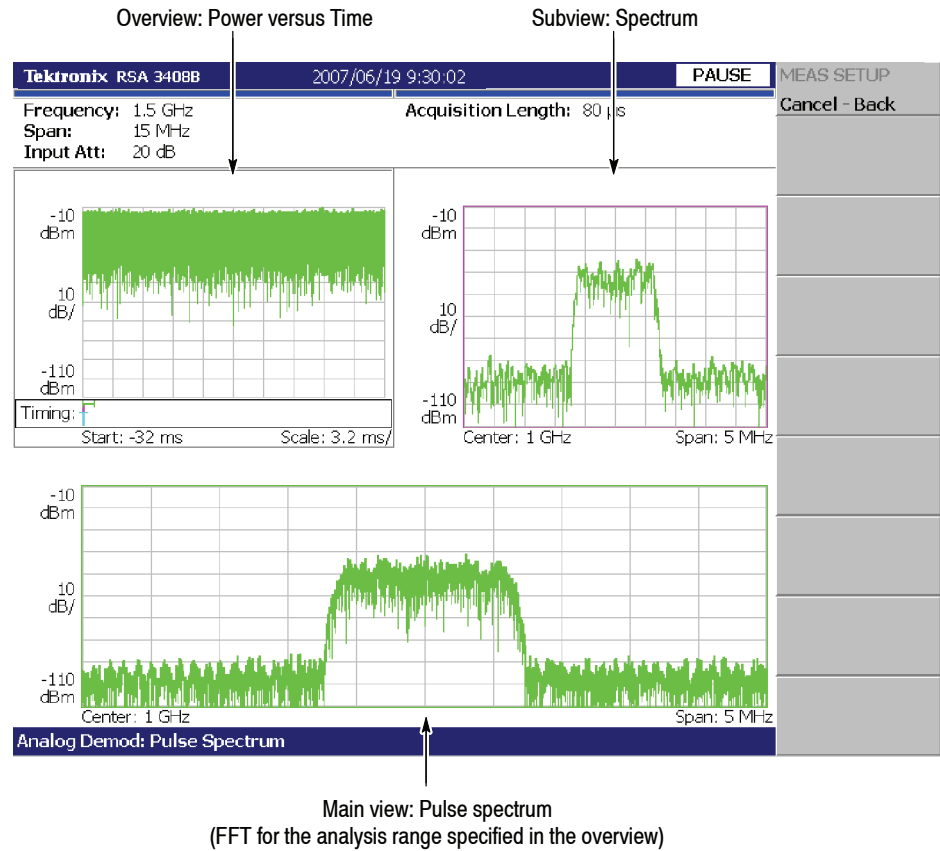


**Figure 3-42: IQ versus time measurement (main view)**

**Pulse Spectrum Measurement**

This measurement performs FFT for the analysis range specified in the overview. On specifying the analysis range, refer to *Setting the Analysis Range* on page 3-34. Figure 3-43 shows the pulse spectrum measurement. The main view shows the pulse spectrum (FFT for the analysis range).

The pulse spectrum measurement has no Meas Setup menu items.



**Figure 3-43: Pulse spectrum measurement**

## Digital Modulation Analysis (Option 21 Only)

You can select the following measurement items using the **Measure** key when you select **Digital Demod** in the Demod menu.

- Constellation page 3-56
- EVM page 3-57
- IQ/Frequency versus Time page 3-58
- Power versus Time page 3-59
- Symbol Table page 3-60
- Eye Diagram page 3-60
- AM/AM page 3-61
- AM/PM page 3-63
- CCDF page 3-64
- PDF page 3-65
- FSK Deviations page 3-66

Refer to *Appendix B* for digital demodulation symbol mapping.

**Meas Setup Menu**

This subsection describes the Meas Setup menu items common to all the measurements in the digital modulation analysis. For the Meas Setup menu items specific to a measurement, refer to that measurement description.

**Parameter Presets...** Selects a communication standard. Parameters are set according to the standard you have selected (refer to Table 3-7).

**Table 3-7: Communication standard and preset parameters**

Standard	Modulation	Symbol rate	Filter	$\alpha$ /BT
802.15.4/OQPSK	OQPSK	1 Msps	None	0
NADC	1/4 $\pi$ QPSK	24.3 ksps	Root Raised Cosine	0.35
PDC	1/4 $\pi$ QPSK	21 ksps	Root Raised Cosine	0.5
PHS	1/4 $\pi$ QPSK	192 ksps	Root Raised Cosine	0.5
TETRA	1/4 $\pi$ QPSK	18 ksps	Root Raised Cosine	0.35
GMS	GMSK	270.833 ksps	None	0.3
CDPD	GMSK	19.2 ksps	None	0.5
Bluetooth	GFSK	1 Msps	None	0.5
P25_C4FM	P25_C4FM	4.8 ksps	Raised Cosine	0.2

**Modulation Type...** Selects a modulation method. Available measurement items depend on the modulation method, as shown in Table 3-8.

**Table 3-8: Modulation type and available measurement item**

Measurement item	1/4 $\pi$ QPSK	PSK/QAM <sup>1</sup>	GMSK	ASK	FSK <sup>2</sup>	OQPSK	P25_C4FM	CPM
Constellation	✓	✓	✓	✓	✓	✓	✓	✓
EVM	✓	✓	✓			✓		✓
IQ/Frequency versus Time	✓	✓	✓		✓	✓	✓	✓
Power versus Time				✓				
Symbol Table	✓	✓	✓	✓	✓	✓	✓	✓
Eye Diagram	✓	✓	✓	✓	✓	✓	✓	✓
AM/AM, AM/PM		✓						
CCDF, PDF	✓	✓	✓			✓		✓
FSK Deviations					✓			

<sup>1</sup> Includes BPSK, QPSK, 8PSK, D8PSK, 16QAM, 32QAM, 64QAM, 128QAM, and 256QAM.

<sup>2</sup> Includes GFSK, FSK, 4FSK, 8FSK, and 16FSK.

**Restrictions of Use.**

- When the modulation type is P25 C4FM, the analysis is performed only for the span of 20 kHz and 50 kHz. For the 50 kHz span, Acquisition Length in the Acquisition/Analysis menu must be set to greater than 32 ms.
- When the modulation type is OQPSK, set the span so that the sampling rate is more than three times as fast as the symbol rate. The sampling rate varies according to span setting. For the detail, refer to the *Acquisition* table described in the *Specifications* section of the *Technical Reference* (refer to *Related Documents* on page xviii).

**Modulation Parameters...** Sets the following modulation parameters:

**Symbol Rate.** Enters the symbol rate for demodulating digitally modulated signals. The symbol rate and the bit rate are related as follows:

$$(\text{Symbol rate}) = (\text{Bit rate})/(\text{Number of bits per symbol})$$

For example, the number of bits per symbol is 3 for 8PSK.

**Measurement Filter...** Selects a filter for demodulating a digitally modulated input signal:

- None (no filter)
- Root Raised Cosine
- User Filter

**Reference Filter...** Selects a filter for creating a reference signal:

- None (no filter)
- Raised Cosine
- Gaussian
- Half Sine
- User Filter

Refer to *Process Flow for Digitally Modulated Signals* on page 3-54 for the measurement and reference filters.

When you select User Filter, load the file using the **Load User Filter Measurement** and **Reference** side keys before taking measurements.

**Filter Parameter.** Enters an  $\alpha$ /BT value for the Measurement Filter and Reference Filter. Range: 0.0001 to 1



**Load User Filter (Measurement).** Loads the user-defined measurement filter from the file.

**Load User Filter (Reference).** Loads the user-defined reference filter from the file.

---

**NOTE.** For the user-defined filter file, refer to page 3-280.

---

*The parameters for the modulation type (refer to page 3-49) of ASK only:*

**Auto Modulation Depth.** Determines whether to automatically detect or manually set the modulation depth used to distinguish between the two states of an ASK signal.

- **On. Default.** Automatically calculates the modulation depth for the analysis range and displays the value in the Modulation Depth side key.
- **Off.** Sets the modulation depth using the Modulation Depth side key.

**Modulation Depth.** Sets the modulation depth when Auto Modulation Depth is Off. Range: 0 to 100%.

*The parameters valid for the modulation type (refer to page 3-49) of ASK, FSK, and GFSK:*

**Decoding Format.** Selects the method used to decode data bits from each symbol.

- NRZ (default)
- Manchester
- Miller

*The parameters valid for the modulation type (refer to page 3-49) of GFSK, FSK, 4FSK, 8FSK, and 16FSK:*

**Auto Frequency Deviation.** Determines whether to automatically detect or manually set the frequency deviation used to distinguish between the digital values of a signal.

- **On. Default.** Automatically calculates the frequency deviation for the analysis range and displays the value in the Frequency Deviation side key.
- **Off.** Sets the frequency deviation using the Frequency Deviation side key.

**Frequency Deviation.** Sets the frequency deviation when Auto Frequency Deviation is Off. Range: 0 to Span/2 Hz.

**Symbol Timing Search.** Determines whether to automatically detect or manually set the symbol rate.

- **On.** Automatically detects the symbol rate to perform analysis. The calculated symbol rate is displayed in the main view. Also, from the difference between the calculated rate (C) and the set rate (S), the symbol timing error ( $= (C-S)/S$ ) is indicated. (The S is the value specified by the **Symbol Rate** side key (refer to page 3-50).)

---

**NOTE.** *The automatic detection of symbol rate is performed within  $\pm 5\%$  of the Symbol Rate setting value. The detection fails outside the range.*

---

- **Off. Default.** Performs analysis with the symbol rate set by the **Symbol Rate** side key.

*The parameters valid for the modulation type (refer to page 3-49) of CPM:*

**Auto Modulation Index Detection.** Determines whether to automatically detect or manually set the modulation index.

- **On. Default.** Automatically detects the modulation index and displays the value in the Modulation Index... side key.
- **Off.** Sets the modulation index using the Modulation Index... side key.

**Modulation Index...** Selects the modulation index when Auto Modulation Index Detection is Off: “4/16,5/16” (default), “5/16,6/16”, “6/16,7/16”, “7/16,10/16”, “12/16,13/16”, or “8/16,8/16”.

**Auto Carrier.** Determines whether to automatically detect or manually set the carrier frequency.

- **On. Default.** Automatically detects a carrier for every frame and displays the error from center frequency as “Freq Error” on the screen.
- **Off.** Sets the carrier frequency using Frequency Error.

**Frequency Offset.** Sets the carrier frequency when Auto Carrier is Off. Enter the frequency offset from the center frequency.

**Shifting Q Data for OQPSK**

When the modulation type is OQPSK, you can shift Q data by half a symbol relative to I data by pressing View: **Define > Q Data Half Symbol Shift**.

The Q Data Half Symbol Shift side key has the following selections:

- **+**. Shifts Q data by half a symbol in the positive direction on the time axis.
- **0**. Does not shift Q data (default).
- **-**. Shifts Q data by half a symbol in the negative direction on the time axis.

This function is available in the following views:

- Constellation
- EVM
- Eye diagram
- IQ versus Time

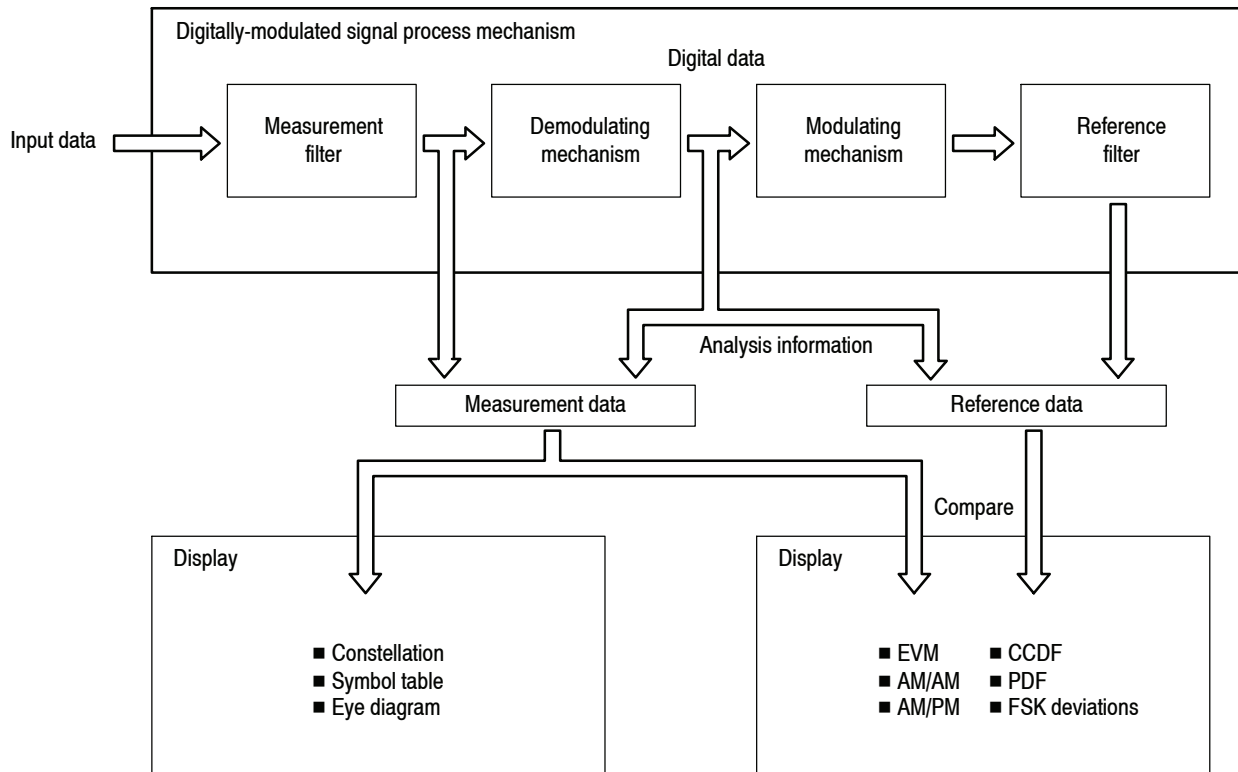
---

**NOTE.** When Q Data Half Symbol Shift is set to 0 (zero), the magnitude and phase errors cannot be calculated, displaying “----” for the Mag Error and Phase Error in the constellation and EVM measurement readout.

---

**Process Flow for Digitally Modulated Signals**

To determine the necessary settings in digital modulation analysis, you must know the digitally-modulated signal process in the analyzer. Figure 3-44 outlines the process.



**Figure 3-44: Process flow for digitally modulated signals**

The input signal goes through the measurement filter after being converted into a digital signal, and then is stored as measurement data and is concurrently demodulated. The demodulated signal is modulated again, goes through the reference filter, and is stored as reference data. The displays of Constellation, Symbol table, and Eye diagram are created based on measurement data, and those of the EVM, AM/AM, AM/PM, CCDF, PDF, and FSK deviations based on the comparison of the measurement data and the reference data.

**Basic Procedure**

To perform digital modulation analysis, follow these steps:

1. Press the Mode: **Demod** key on the front panel.
2. Press the **Digital Demod** side key and then select the measurement item.
3. Display the measurement waveform:

---

**NOTE.** You should set appropriate frequency and span. It is important to set frequency and span as close to the measurement signal band as possible and finely adjust them. The modulated signal will not be recognized unless frequency and span are set appropriately.

For information about setting frequency, span, and amplitude, refer to Setting Frequency and Span on page 3-135 and Setting Amplitude on page 3-143.

---

- a. Set the frequency by pressing the **Frequency/Channel** key on the front panel.
  - b. Set the span by pressing the **Span** key on the front panel.
  - c. Set the amplitude by pressing the **Amplitude** key on the front panel.
4. Set analysis range by pressing the **Acquisition/Analysis** key on the front panel. Refer to page 3-34 for details.

---

**NOTE.** When the modulation type (refer to page 3-49) is ASK, FSK or GFSK, the measurement requires at least 16 symbols in the analysis length (refer to page 3-34 for setting the analysis length).

---

5. Set the measurement parameters by pressing the **Meas Setup** key on the front panel. Refer to page 3-49 for the Meas Setup menu description.

**If No Measurement Result or Waveform is Displayed on the Main View.** Unless the analyzer obtains valid data for the measurement, neither the result nor waveform appears on the main view. In this case, try the following steps:

- Set the center frequency to the middle of the measurement signal bandwidth.
- Set the span near the measurement signal bandwidth.
- Set the data acquisition length (Acquisition/Analysis > Acquisition Length) larger to increase the amount of data.

The following pages show examples for each measurement item. Refer to page 3-203 for information about setting scale and formatting each view. Refer to page 3-38 for information about changing the overview and subview.

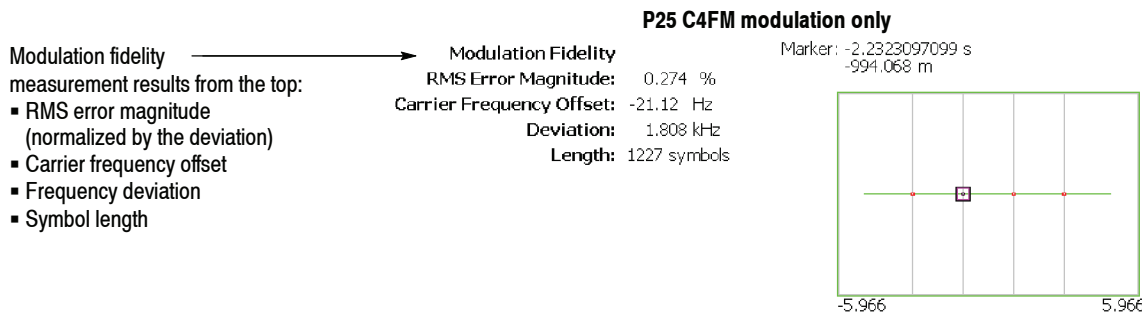
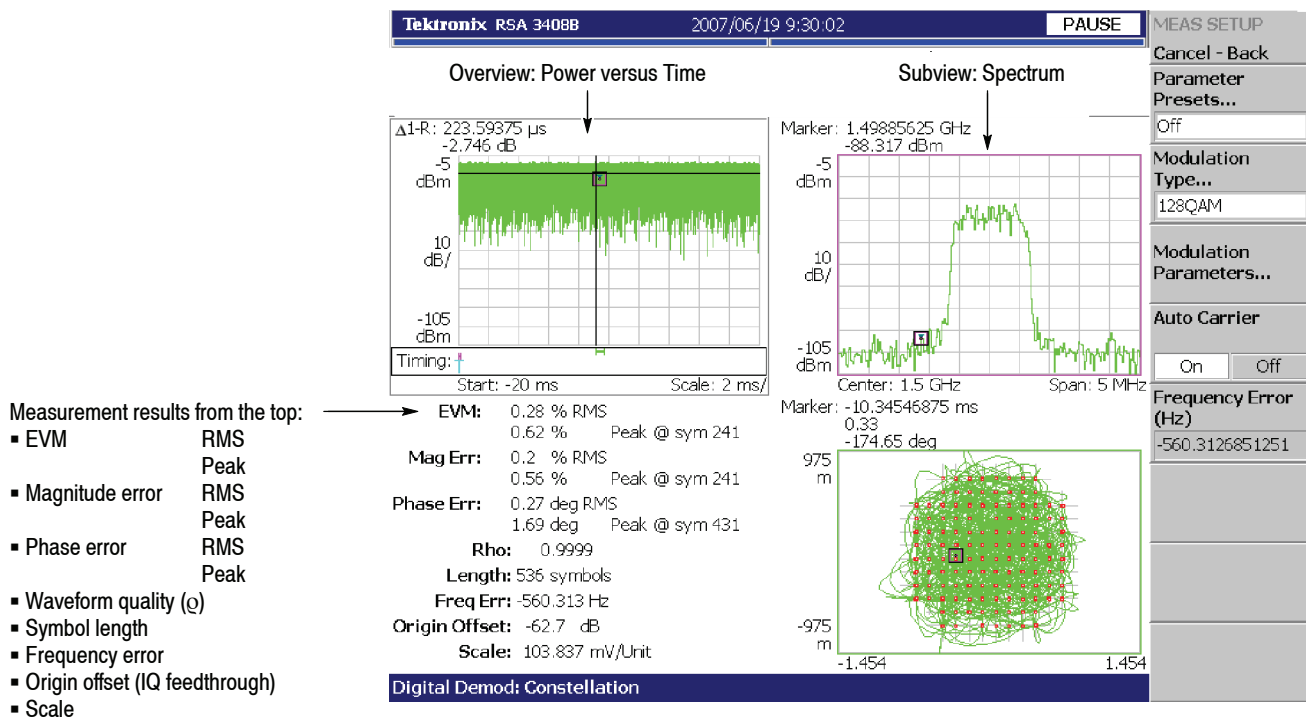
**Constellation Measurement**

Performs digital demodulation processing and displays a constellation diagram. Figure 3-45 shows an example. The main view displays the measurement results and the constellation diagram. When the modulation type (**Meas Setup > Modulation Type...**) is P25 C4FM, the modulation fidelity is displayed as the measurement result.

**NOTE.** In the constellation view, I and Q signals are normalized to prevent the scale from changing when signal attenuation changes.

For the Meas Setup menu, refer to page 3-49.

For setting views, refer to page 3-203.



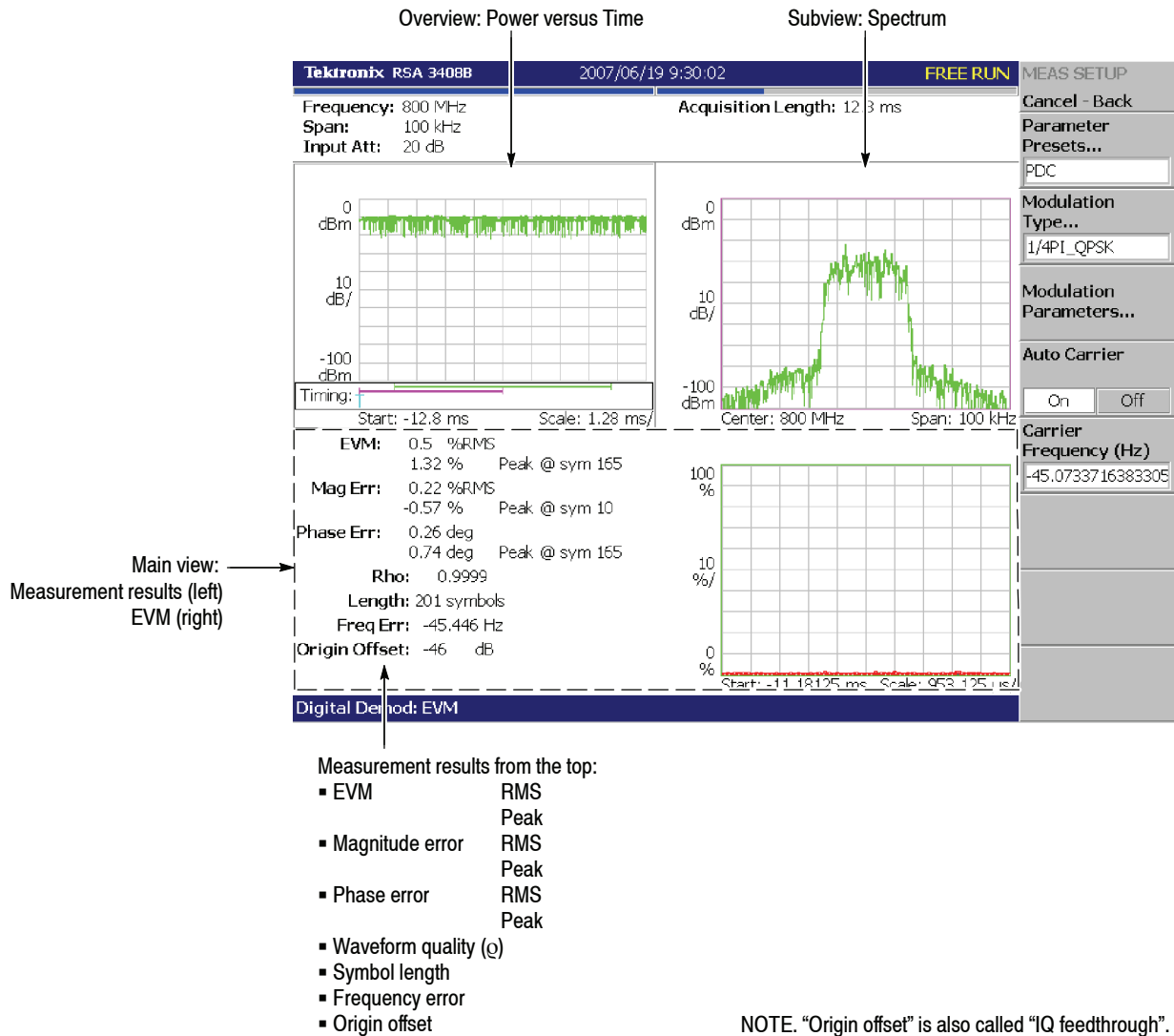
**Figure 3-45: Constellation analysis**

**EVM Measurement**

Measures EVM (Error Vector Magnitude). Figure 3-46 shows an example. The main view displays the measurement results and the EVM versus time graph.

For the Meas Setup menu, refer to page 3-49.

For setting views, refer to page 3-203.



**Figure 3-46: EVM measurement**

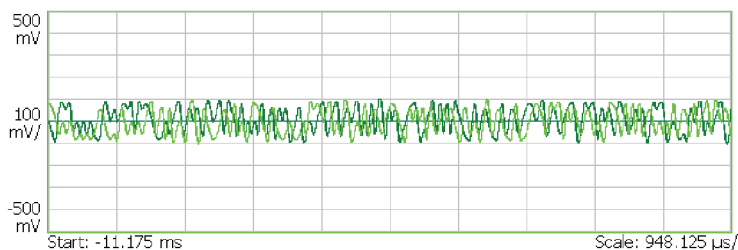
You can select degree or radian for the angular unit by pressing **System > Instrument Setup... > Angular Units**.

### IQ/Frequency versus Time Measurement

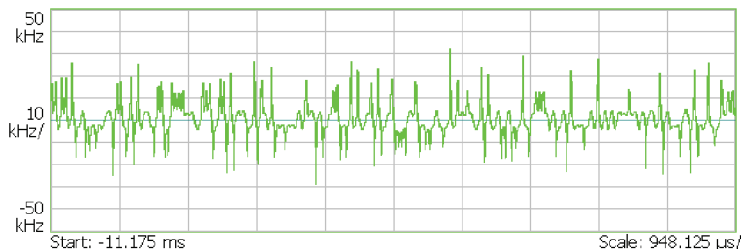
Observes I/Q signal voltage change over time. When the modulation type (**Meas Setup > Modulation Type...**) is FSK, GFSK, or P25 C4FM, it displays frequency change over time. Figure 3-47 shows an example. The main view shows I/Q voltage versus time graph where I and Q are indicated in yellow and green, respectively, or shows frequency deviation versus time graph for the FSK, GFSK, or P25 C4FM modulation. For the P25 C4FM modulation, the main view also shows the modulation fidelity measurement results and the waveforms with the red dots indicating the symbol points.

For the Meas Setup menu, refer to page 3-49.  
 For setting views, refer to page 3-203.

Main view: I/Q voltage versus Time  
 (I and Q are indicated in yellow and green, respectively)



Main view: Frequency deviation versus Time  
 (FSK and GFSK modulation only)

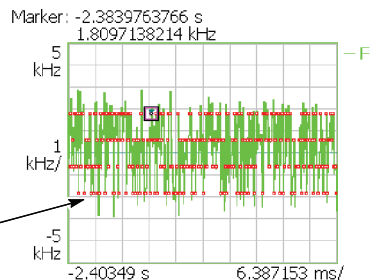


Main view: Measurement results and  
 Frequency deviation versus Time  
 (P25 C4FM modulation only)

- Modulation fidelity measurement results from the top:
- RMS error magnitude (normalized by the deviation)
  - Carrier frequency offset
  - Frequency deviation
  - Symbol length

**Modulation Fidelity**  
 RMS Error Magnitude: 0.274 %  
 Carrier Frequency Offset: -21.12 Hz  
 Deviation: 1.808 kHz  
 Length: 1227 symbols

The red dots indicate the symbol points.



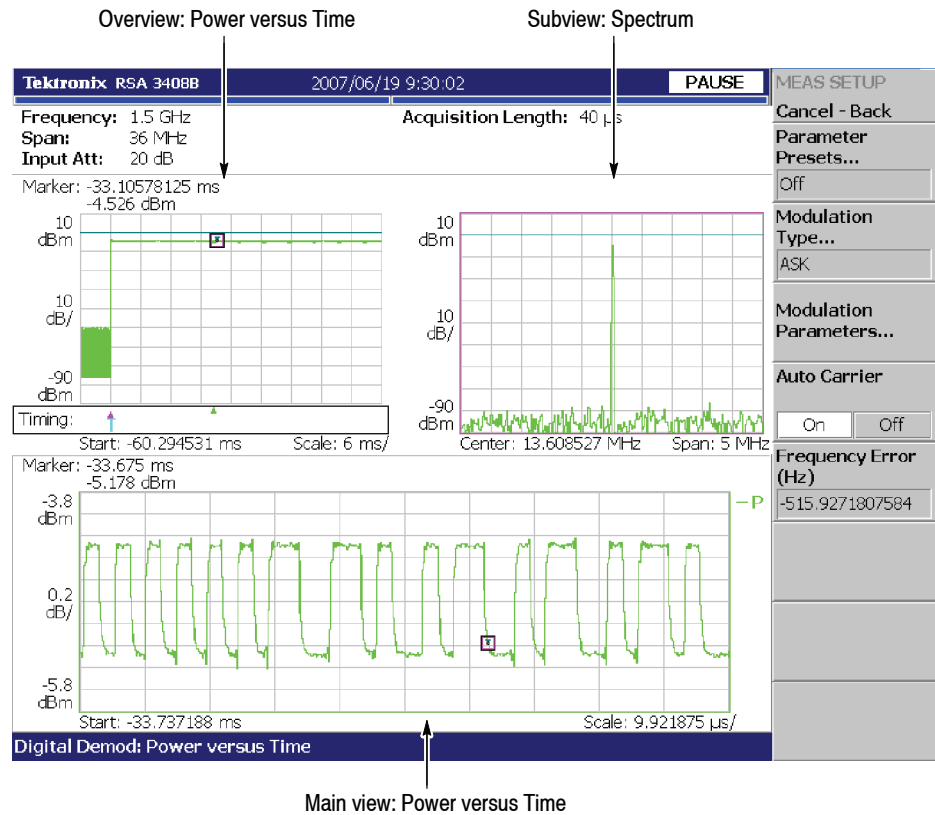
**Figure 3-47: IQ/Frequency versus time measurement**



**Power versus Time Measurement**

Observes signal power change over time. Figure 3-48 shows an example. The main view displays a power versus time graph.

For the Meas Setup menu, refer to page 3-49.  
For setting views, refer to page 3-203.

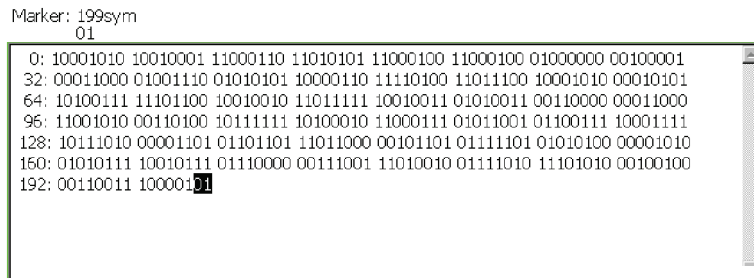


**Figure 3-48: Power variance measurement**

**Symbol Table Analysis**

Performs digital demodulation processing and displays a symbol table in the main view. Figure 3-49 shows an example.

For the Meas Setup menu, refer to page 3-49.  
 For setting views, refer to page 3-203.

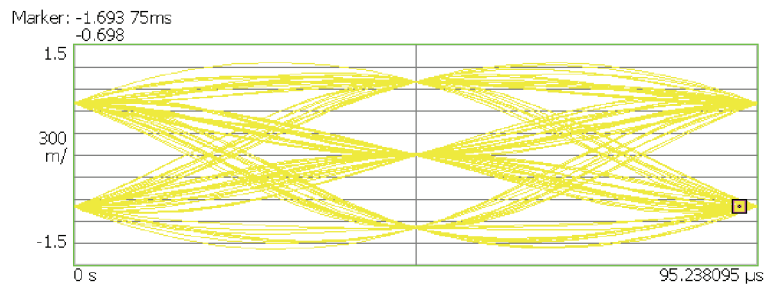


**Figure 3-49: Symbol table analysis**

**Eye Diagram Analysis**

Performs digital demodulation processing and displays an eye diagram in the main view. Figure 3-50 shows an example.

For the Meas Setup menu, refer to page 3-49.  
 For setting views, refer to page 3-203.



**Figure 3-50: Eye diagram analysis (main view)**

You can select degree or radian for the angular unit by pressing **System > Instrument Setup... > Angular Units**.

**AM/AM Measurement**

Performs digital demodulation processing and displays an AM/AM distortion graph for measuring non-linearity characteristics of a DUT (device under test) such as an RF amplifier. Figure 3-52 on page 3-62 shows an example. The main view displays the XY graph of recovered reference amplitude versus measured signal amplitude and the table of AM/AM coefficients extracted from curve fitting.

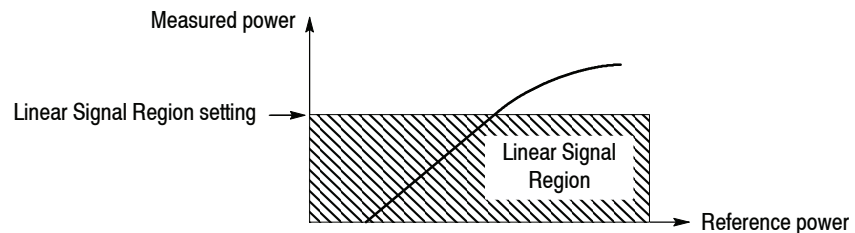
**Meas Setup Menu.** The Meas Setup menu for the AM/AM measurement contains the following controls. For information about the common controls for the digital modulation analysis, refer to *Meas Setup Menu* on page 3-49.

**Linear Signal Region Unit.** Selects the unit to set the Linear Signal Region.

- **dB.** *Default.* Specifies the Linear Signal Region with a value relative to the maximum power measured in the analysis range.
- **dBm.** Specifies the Linear Signal Region with an absolute power.

**Linear Signal Region.** Sets a region that should have an ideal AM/AM characteristic. Generally, signal distortion increases with amplitude. Linear Signal Region sets the region where the trend is assumed to be linear (see Figure 3-51). The analysis is performed with this assumption. The region is indicated by blue oblique lines in the main view.

Range: -100 to 50 dB (the default is -10 dB)



**Figure 3-51: Setting Linear Signal Region**

**Maximum Coefficient.** Sets the maximum order of the best-fit curve polynomial. The polynomial is expressed as follows (n: Max 15):

$$f(x) = a_0x^0 + a_1x^1 + a_2x^2 + \dots + a_nx^n$$

The values of  $a_n$  are shown in the main view (see Figure 3-52 on page 3-62).

**Display Reference Line.** Determines whether the reference line is visible. The reference line represents an ideal AM/AM trend line.

**Display Best-Fit Line.** Determines whether the best-fit line is visible.

**Linear Signal Region Mask.** Determines whether the linear signal region is visible.

**Scroll Table.** Scrolls the coefficient table when it has many rows.

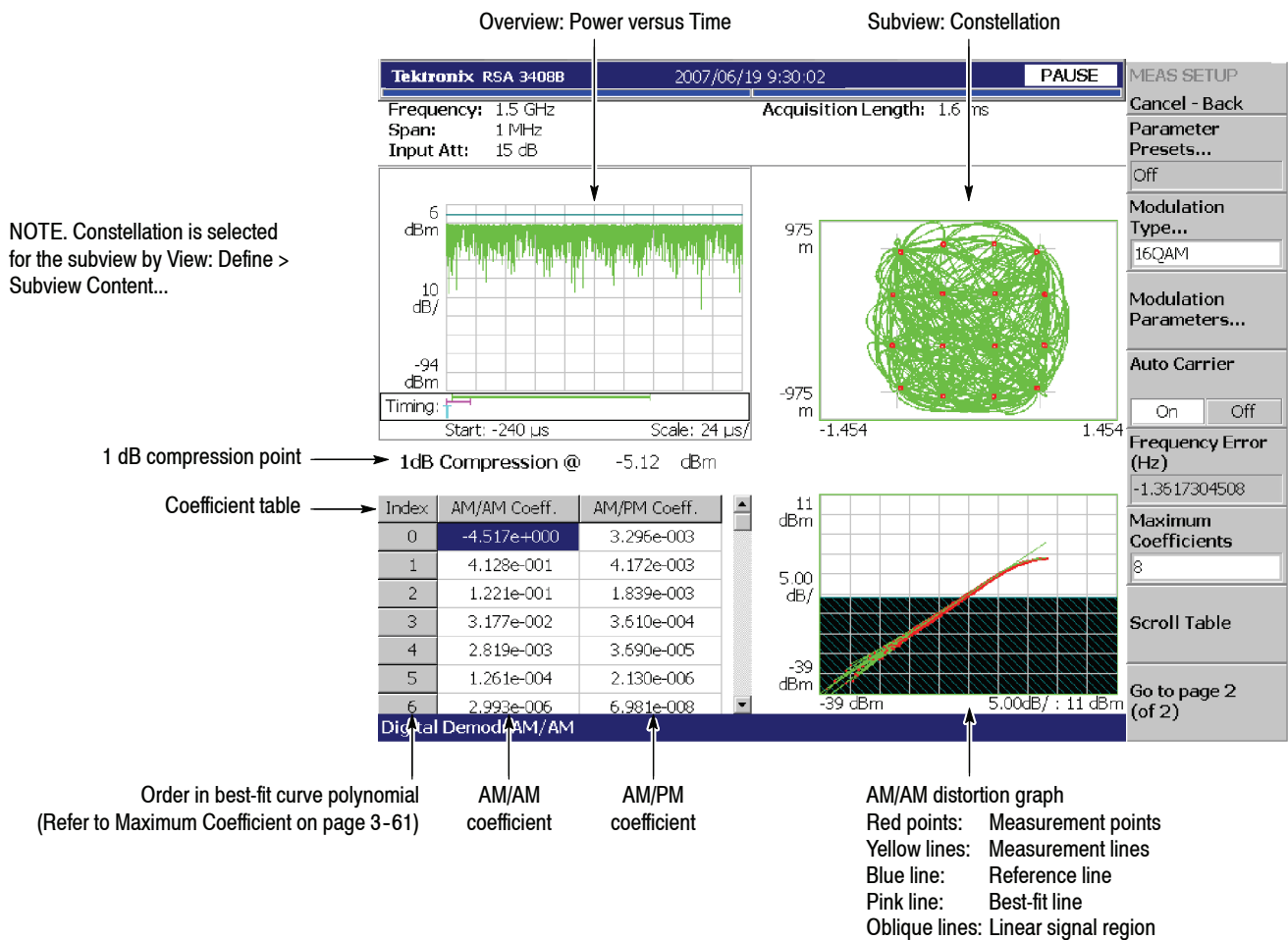


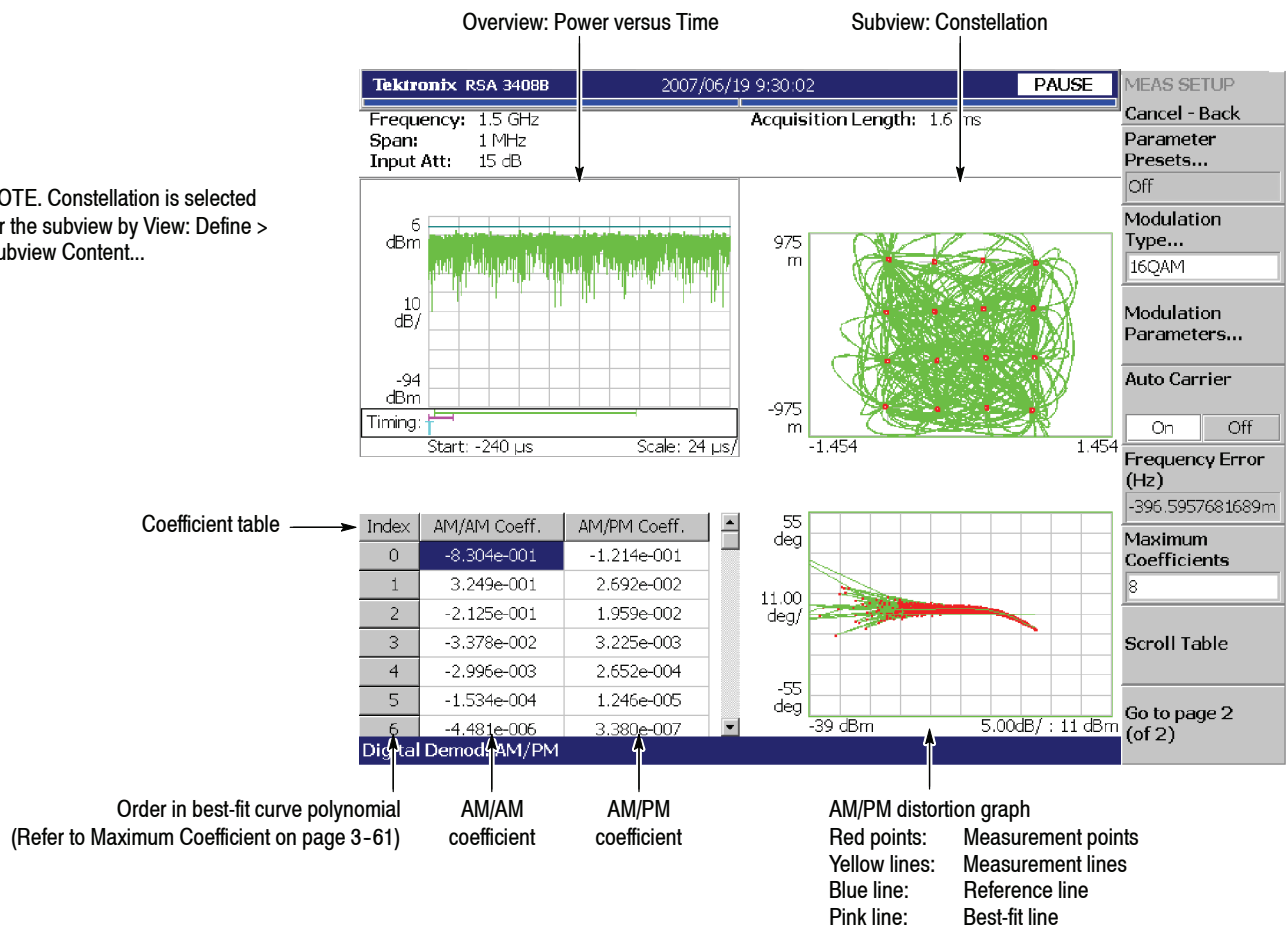
Figure 3-52: AM/AM measurement

**AM/PM Measurement**

Performs digital demodulation processing and displays an AM/PM distortion graph for measuring non-linearity characteristics of a DUT (device under test) such as an RF amplifier. Figure 3-53 shows an example. The main view displays the XY graph of recovered reference amplitude versus measured phase error and the table of AM/PM coefficients extracted from curve fitting.

**Meas Setup Menu.** The Meas Setup menu for the AM/PM measurement has the same controls as in the AM/AM measurement, except for the Linear Signal Region Mask. Refer to page 3-61.

NOTE. Constellation is selected for the subview by View: Define > Subview Content...



**Figure 3-53: AM/PM measurement**

**CCDF Measurement**

Performs digital demodulation processing and displays a CCDF graph. Figure 3-54 shows an example. The main view displays the XY graph of power level versus the probability that the instantaneous power of the input is above that power level. For the CCDF measurement, refer to page 3-104 in the Time mode.

**Meas Setup Menu.** The Meas Setup menu for the CCDF measurement contains the following controls. (For information about the common controls for the digital modulation analysis, refer to page 3-49.)

**Linear Signal Region Unit.** *Display only.* You can set it in the AM/AM or AM/PM measurement (refer to page 3-61).

**Linear Signal Region.** *Display only.* You can set it in the AM/AM or AM/PM measurement (refer to page 3-61).

**Horizontal Division.** Sets the horizontal interval between display points. Range: 0.01 to 1 dB (the default is 0.1 dB)

**Display Gaussian Line.** Determines whether to display the Gaussian line.

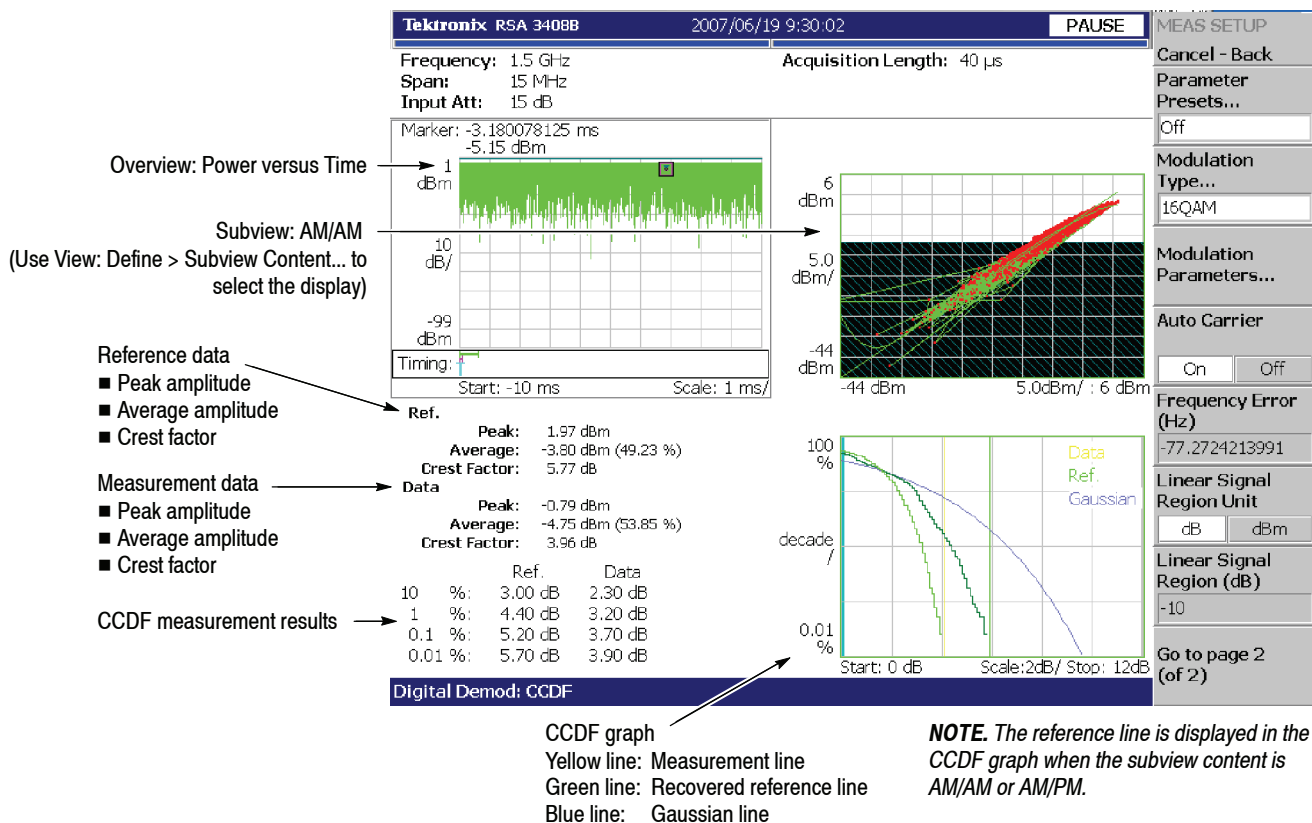


Figure 3-54: CCDF measurement

**PDF Measurement**

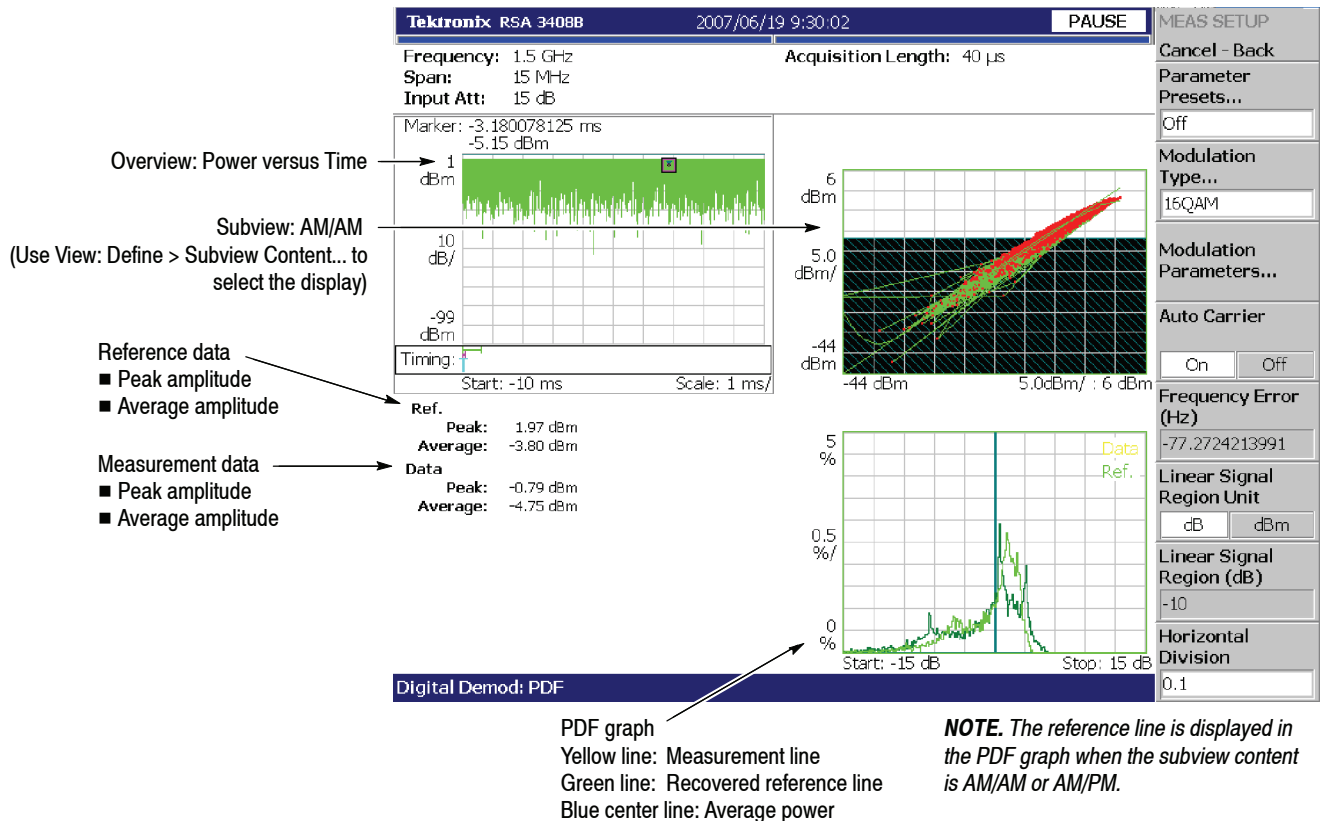
Performs digital demodulation processing and displays a PDF (Probability Distribution Function) graph. Figure 3-55 shows an example. The main view displays the XY graph of power level versus occurrence probability. The horizontal axis represents power level relative to the mean value at the center.

**Meas Setup Menu.** The Meas Setup menu for the PDF measurement contains the following controls. On the common controls for the digital modulation analysis, refer to *Meas Setup Menu* page 3-49.

**Linear Signal Region Unit.** *Display only.* You can set it in the AM/AM or AM/PM measurement (refer to page 3-61).

**Linear Signal Region.** *Display only.* You can set it in the AM/AM or AM/PM measurement (refer to page 3-61).

**Horizontal Division.** Sets the horizontal interval between display points. Range: 0.01 to 1 dB (the default is 0.1 dB)

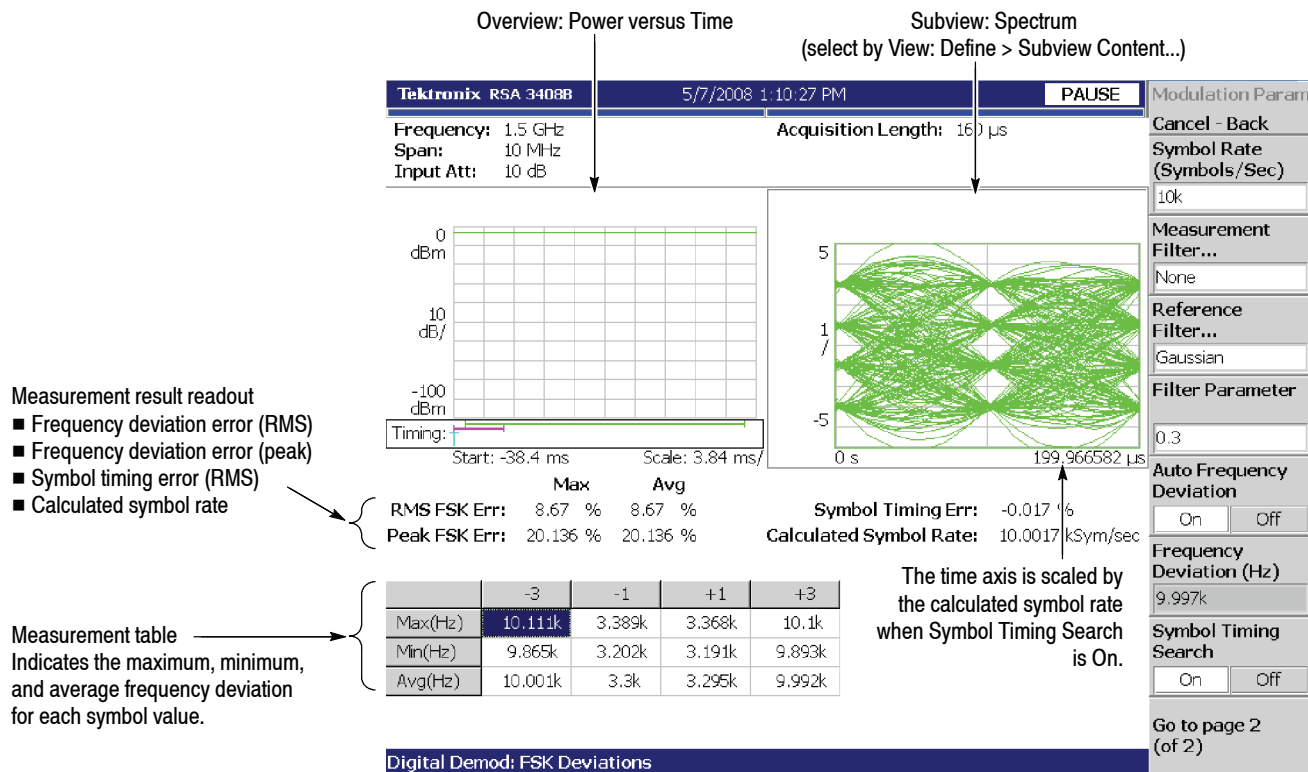


**Figure 3-55: PDF measurement**

### FSK Deviations Measurement

Measures the frequency deviation error when Modulation Type in the Meas Setup menu is set to GFSK, FSK, 4FSK, 8FSK, or 16FSK.

For the Meas Setup menu, refer to page 3-49.



**Figure 3-56: FSK deviations measurement (4FSK)**

The RMS and peak frequency deviation errors are displayed in the measurement result readout on the screen. When Symbol Timing Search in the Meas Setup menu (refer to page 3-52) is set to On, the calculated symbol rate is indicated. Also, from the difference between the calculated rate (C) and the set rate (S), the symbol timing error ( $= (C-S)/S$ ) is shown. (The S is the value specified by the **Symbol Rate** side key. Refer to page 3-50.)

When using the average function (Trace/Avg menu) at the same time, the measurement is repeated by the average count to obtain the maximum and average values, which are displayed as Max and Avg in the readout. When the averaging is disabled, Max and Avg are the same value.

The measurement table on the bottom of the screen indicates the maximum, minimum, and average frequency deviations in the analysis range for each symbol value.



## Audio Measurements (Option 10 Only)

The audio measurement function performs traditional audio quality measurements such as S/N (Signal to Noise ratio) and THD (Total Harmonic Distortion). The measurement items are divided into three groups as listed in Table 3-9 (select the item using the **Measure** key). You can measure burst signals as well as CW (Continuous Wave). The demodulated signal waveform is displayed in real time in the spectrum and spectrogram. You can select the following audio filters: CCITT, C-Message, LPF (Low-Pass Filter) and HPF (High-Pass Filter), and de-emphasis process. The measurement resolution can be enhanced by trace averaging and high-resolution FFT.

**NOTE.** The audio measurements are based on the real-time spectrum analysis function in the S/A mode (Real Time S/A). Refer to Real-Time Analysis on page 3-23.

**Table 3-9: Audio measurement items**

Measure menu	Measurement items
Signal/Noise and Distortion	<ul style="list-style-type: none"> <li>■ S/N (Signal to Noise Ratio)</li> <li>■ SINAD (Signal to Noise And Distortion)</li> <li>■ THD (Total Harmonic Distortion)</li> <li>■ TNHD (Total Non-Harmonic Distortion)</li> <li>■ Audio frequency</li> <li>■ Audio level</li> <li>■ AM modulation depth: Maximum, Minimum, and RMS</li> <li>■ FM frequency deviation: RMS, +/- Peak, Peak-to-Peak, and Peak-to-Peak/2</li> </ul>
Harmonics	<ul style="list-style-type: none"> <li>■ Harmonic frequency / level</li> <li>■ Non-harmonic frequency / level</li> </ul>
Hum & Noise Ratio	<ul style="list-style-type: none"> <li>■ RMS power ratio (Baseband)</li> <li>■ RMS modulation depth ratio (AM)</li> <li>■ RMS frequency deviation ratio (FM)</li> </ul>

### Basic Procedure

Use the following procedure to perform the audio measurements:

1. Press the **Demod** key on the front panel and select **Audio Measurement** using the side key.
2. Press the **Measure** key and select a measurement item. For example, press the **Signal/Noise & Distortion** side key to perform the S/N measurement.
3. Press the **Meas Setup** key and then press the **Demod Type** side key to select the input signal type: Baseband (for a non-modulated signal), AM, or FM.

4. Adjust the amplitude and frequency to display the spectrum waveform.

Refer to page 3-135 for setting frequency and span.

Refer to page 3-143 for setting amplitude.

---

**NOTE.** A reference level that is too high will cause a higher noise level in the resulting audio spectrum. Set the reference level to the minimum value that does not cause overrange (refer to page 3-147).

---

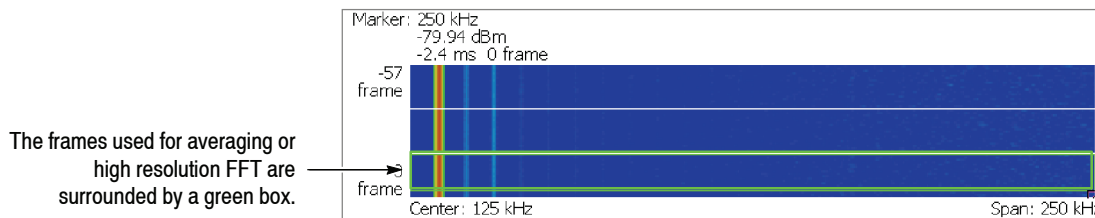
*Easy setting of the center frequency in baseband:* When you select Baseband for Demod Type in the Meas Setup menu, enter 0 (zero) for Center Freq in the Frequency/Channel menu. Afterward, the center frequency is set to half a span automatically.

5. Press the **Meas Setup** key and set the measurement parameters as needed. For details, refer to *Meas Setup Menu* in each measurement section beginning on page 3-69.

**Measurement with Higher Resolution.** To enhance measurement resolution, you can use the waveform averaging and the high-resolution FFT.

1. Press the **Trace/Avg** key.
2. Press the **Trace Type...** side key to select one of the following items:
  - **Normal.** *Default.* Displays the normal spectrum.
  - **Average.** Averages the spectrum traces to reduce noise in the waveform. Use the **Number Of Averages** side key to set the number of traces to combine, ranging from 1 to 1000.
  - **Hi-Res.** Allows you to set the number of FFT points from the basic 1024 (1024×1) up to 65536 (1024×64). Use the **Extended Resolution...** side key to select the number of points: ×1, ×2, ×4, ×8, ×16, ×32, or ×64.

The frames used for averaging or high resolution FFT are surrounded by a green box on the spectrogram (see Figure 3-57).



**Figure 3-57: Spectrogram display in the average or high resolution mode**

**Signal/Noise and Distortion**

Measures audio quality such as S/N (Signal to Noise ratio) and THD (Total Harmonic Distortion).

**Meas Setup Menu.** The Meas Setup menu for the Signal/Noise and Distortion measurement contains the following controls:

**Demod Type.** Specifies the modulation scheme of the input signal.

- **Baseband.** Directly input a non-modulated audio signal to measure.
- **AM.** Demodulates the AM signal to measure.
- **FM. Default.** Demodulates the FM signal to measure.

**Audio LPF.** Selects the audio low-pass filter to apply to the acquired audio signal before the measurements are performed.

**Table 3-10: Audio LPF**

Menu item	Filter type	Order
None (default)	No filter	-
C-Message	Defined by table <sup>1</sup>	-
CCITT	Defined by table <sup>2</sup>	-
3 kHz	Butterworth	5
15 kHz		5
30 kHz		3
80 kHz		3

<sup>1</sup> ITU-T O.41, TABLE A.1/O.41. Refer to <http://www.itu.int/rec/T-REC-O.41-199410-I/en>.

<sup>2</sup> ITU-T O.41, TABLE 1/O.41. Refer to the above site.

**Audio HPF.** Selects the audio high-pass filter to apply to the acquired audio signal before the measurements are performed.

**Table 3-11: Audio HPF**

Menu item	Filter type	Order
None (default)	No filter	-
50 Hz	Butterworth	2
300 Hz		2
400 Hz		5

**De-emphasis.** Selects the de-emphasis time constant.

**Table 3-12: Audio de-emphasis filter**

Menu item	Filter type	Order
None (default)	No filter	-
25 $\mu$ s	De-emphasis	1
50 $\mu$ s		1
75 $\mu$ s		1
750 $\mu$ s		1

**Harmonics #.** Sets the maximum number of harmonics and non-harmonics to detect. The detected harmonics and non-harmonics are tagged with a number on the spectrum trace (see Figure 3-58). Range: 1 to 12 (default: 12).

---

**NOTE.** *The Harmonics # setting affects only the THD (Total Harmonic Distortion) and TNHD (Total Non-Harmonic Distortion) calculation results.*

---

The following items are used for detecting only *non*-harmonics. Their functions are the same as the Spurious measurement in the S/A mode (refer to page 3-12):

**Ignore Region**

**Non-Harmonics Threshold**

(“Spurious Threshold” in the Spurious measurement)

**Excursion**

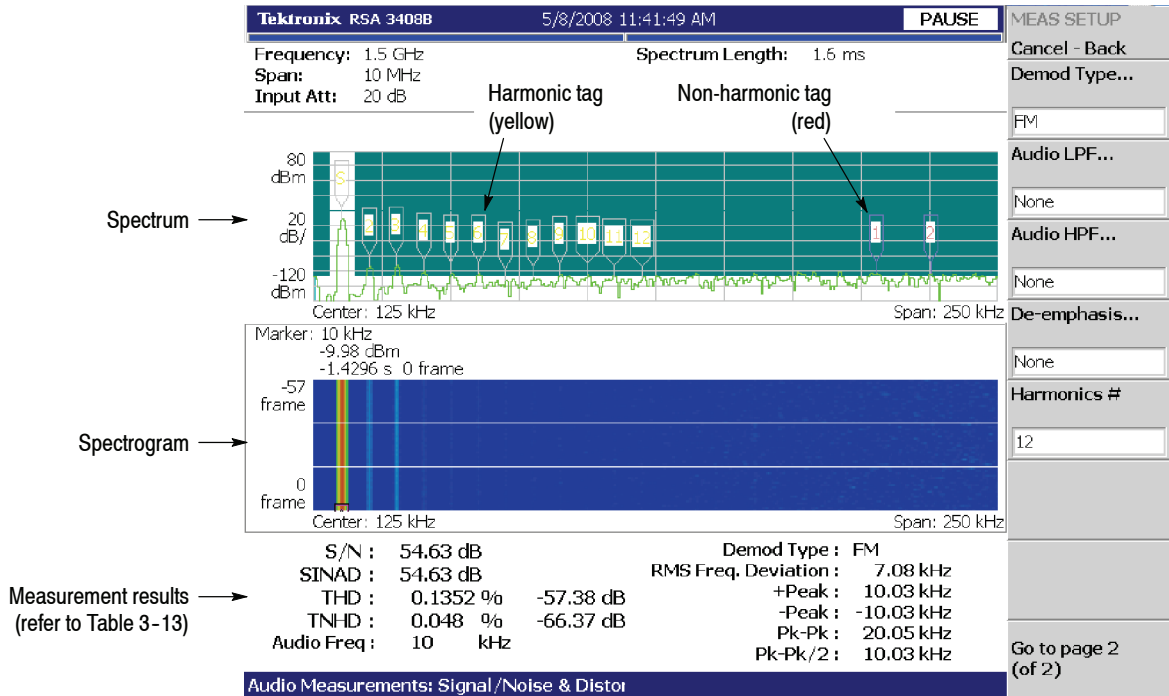
---

**NOTE.** *The harmonics are determined by a multiple of the fundamental wave frequency regardless those three settings.*

*The Ignore Region setting affects only the TNHD (Total Non-Harmonic Distortion) calculation result.*

---

**Measurement Screen.** Figure 3-58 shows an example of the Signal/Noise and Distortion measurement for an FM signal.



**Figure 3-58: Signal/Noise and Distortion measurement**

The detected harmonics and non-harmonics are tagged with a colored number on the spectrum trace:

- Yellow (harmonic tag). These indicate the order of the harmonic. The fundamental wave is tagged as “S” (Signal).
- Red (non-harmonic tag). These are numbered in descending order of amplitude.

The measurement results are displayed at the bottom of the screen. Refer to Table 3-13 for definitions of the items in the measurement results.

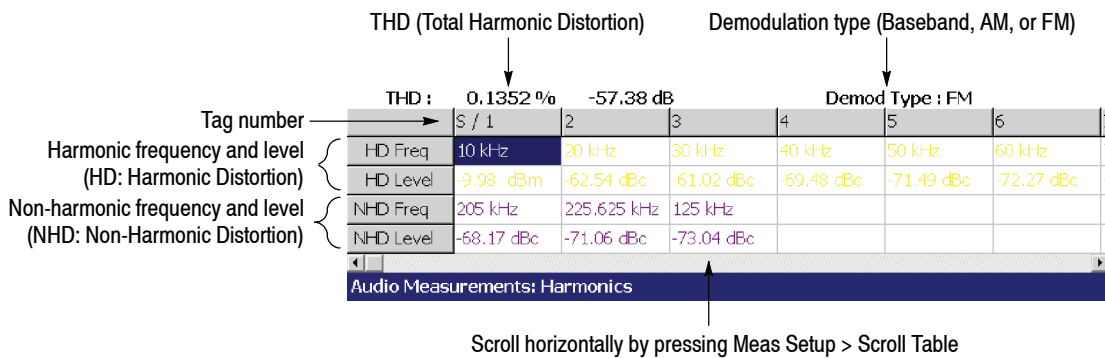
**Table 3- 13: Definition of the Signal/Noise & Distortion measurement items**

Modulation method	Displayed item	Definition
Baseband, AM and FM	S/N	Signal to Noise ratio  $S/N = S/N\&D$  Where S: Signal Power Spectral Density N&D: Noise and Distortion Power Spectral Density
	SINAD	Signal to Noise And Distortion  $SINAD = (S + N\&D)/N\&D$  Where S: Signal Power Spectral Density N&D: Noise and Distortion Power Spectral Density
	THD	Total Harmonic Distortion  $THD = \sqrt{(V_1^2 + V_2^2 + \dots + V_n^2)}/SL$  Where V <sub>n</sub> : Voltage Value of Harmonic Distortion Products SL: Signal Level Voltage
	TNHD	Total Non-Harmonic Distortion  $TNHD = \sqrt{(V_1^2 + V_2^2 + \dots + V_n^2)}/SL$  Where V <sub>n</sub> : Voltage Value of Non-Harmonic Distortion Products SL: Signal Level Voltage
	Audio Freq.	Audio frequency
Baseband	Audio Level	Absolute amplitude (dBm)
AM	RMS	RMS modulation depth
	Max	Maximum modulation depth
	Min	Minimum modulation depth
FM	RMS	RMS frequency deviation
	+Peak	+Peak frequency deviation
	-Peak	-Peak frequency deviation
	Pk-Pk	Peak-peak frequency deviation
	Pk-Pk/2	Half peak-peak frequency deviation

**Harmonics** Detects up to 12 harmonics and 12 non-harmonics, to measure each frequency and level.

**Meas Setup Menu.** The Meas Setup menu for the Harmonics measurement is the same as Signal/Noise and Distortion. Refer to page 3-69.

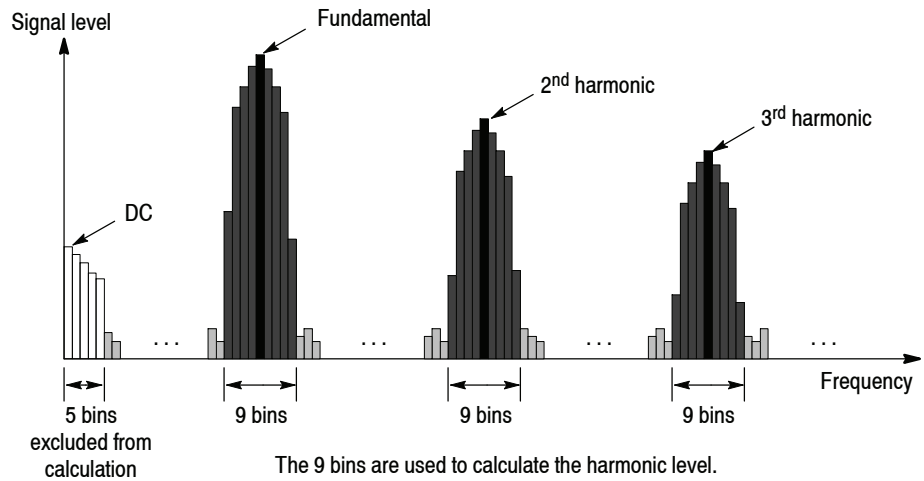
**Measurement Screen.** Figure 3-59 shows an example of the Harmonics measurement results displayed on the bottom of the screen.



**Figure 3-59: Harmonics measurement results (bottom of the screen)**

The measurement table shows frequencies and levels for each order of the harmonics and for the non-harmonics in descending order of amplitude, corresponding to the tag number indicated on the spectrum trace. The level is indicated by absolute amplitude (dBm) for the fundamental wave (S) and by relative amplitude to the fundamental wave (dBc) for the others.

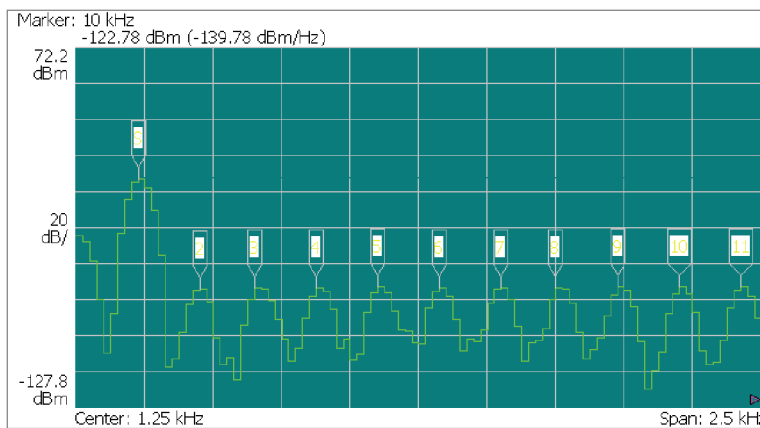
**Calculation of Harmonic Level.** The harmonics measurement calculation is performed assuming that the window function (FFT/RBW > FFT Window) is Blackman-Harris 4B as the default setting. Applying this window widens one-bin line spectrum in the Rect (rectangular) window to 9 bins, expanding by approximately 4 bins on both sides. When calculating SINAD or other audio parameters, 5 bins including the DC component are eliminated to search for the fundamental with the highest level. The harmonic frequencies are determined by an integral multiple of the fundamental frequency. The harmonic level calculation uses the total level of 9 bins including 4 bins on both sides (see Figure 3-60). (For information about bin, refer to *Trace Compression* on page 3-200.)



**Figure 3-60: Harmonic level calculation**

**NOTE.** Due to the relationship between the span and the input frequency, if the interval between two adjacent harmonics becomes less than 8 (=4+4) bins, the harmonic waves overlap each other, losing the reliability of calculation results.

This example shows bins overlapping with the distance between harmonics of 7 or 8 bins.



To expand the waveform horizontally, press Scale/Lines > View Scale... > Horizontal Scale to set a smaller value.

**Figure 3-61: Interval limit between harmonics**



**Hum and Noise Ratio**

Measures the ratio of the modulation depth (AM) or the frequency deviation (FM) under two different conditions. The conditions usually tested are with “regular modulation” and with “modulation turned off”, which shows how much residual AM or FM is present when the modulation is turned off relative to when the modulation is present. It is also possible to perform this on an audio non-modulated signal measuring RMS voltage using “before a filter” and “after a filter” as the two conditions to calculate the ratio. You can select the audio filters in the Meas Setup menu.

**Meas Setup Menu.** The following items are the same as in the Signal/Noise and Distortion measurement. Refer to page 3-69:

- Demod Type**
- Audio LPF**
- Audio HPF**
- De-emphasis**

The following item is added for the Hum and Noise Ratio measurement.

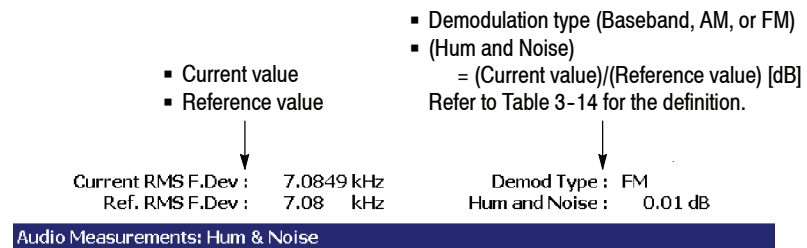
**Save as Ref.** Stores the reference value.

---

**NOTE.** At the beginning of the Hum and Noise Ratio measurement, input the reference signal to store the reference value by pressing the **Save as Ref.** side key.

---

**Measurement Screen.** Figure 3-62 shows an example of the Hum and Noise Ratio measurement result displayed on the bottom of the screen.



**Figure 3-62: Hum and Noise Ratio measurement result (bottom of the screen)**

The result indicates the hum and noise (dB) with current and reference values for the selected modulation method. The definition of the hum and noise ratio is shown in Table 3-14.

**Table 3-14: Definition of the hum and noise ratio**

<b>Modulation method</b>	<b>Definition</b>
Baseband	(Hum and Noise) = (Current RMS power)/(Reference RMS power)
AM	(Hum and Noise) = (Current RMS modulation depth)/(Reference maximum modulation depth)
FM	(Hum and Noise) = (Current RMS frequency deviation)/(Reference RMS frequency deviation)

## RFID Analysis (Option 21 Only)

This section describes the method of RFID (Radio Frequency Identification) analysis. RFID is an automatic individual identification technology that uses a radio. The IC microprocessors in which data is recorded and the antenna module are considered to be the “Tag”. A tag can be incorporated in various objects or living beings. The tag information is read by the radio wave from the “Interrogator” (also called Reader/Writer) and if necessary, the data is written in the tag. This instrument performs an analysis based on the ISO/IEC and EPCglobal standards related to RFID.

### Compatible Standards

RFID analysis is based on the standards listed in Table 3-15.

**Table 3-15: Compatible RFID standards**

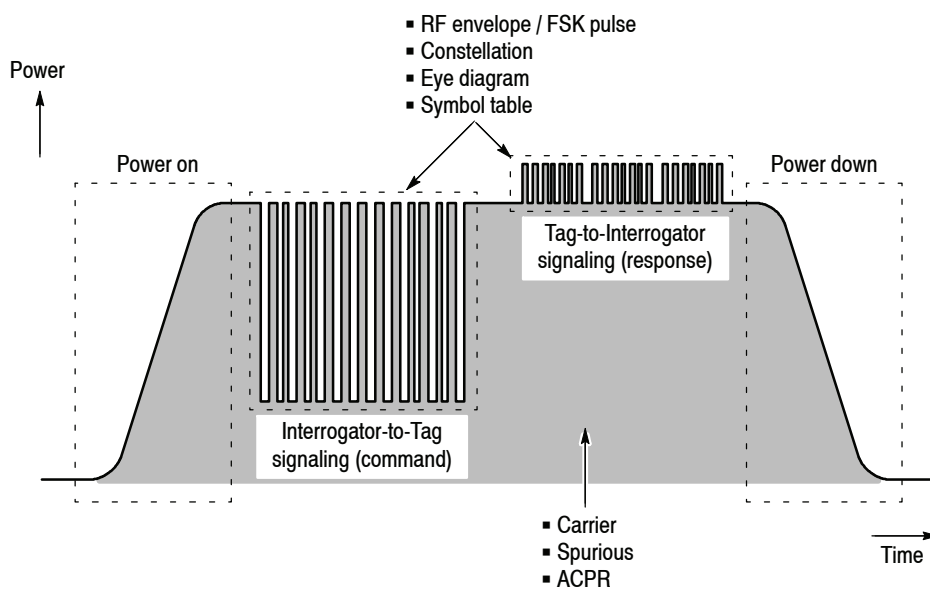
Standard	Description
ISO/IEC 18000-4	Information technology - Radio frequency identification for item management - Part 4: Parameters for air interface communications at 2.45 GHz Mode-1 <sup>1</sup>
ISO/IEC 18000-6	Information technology - Radio frequency identification for item management - Part 6: Parameters for air interface communications at 860 MHz to 960 MHz Type-A, Type-B
ISO/IEC 18000-7	Information technology - Radio frequency identification for item management - Part 7: Parameters for active air interface communications at 433MHz
ISO/IEC 18092	Information technology - Telecommunications and information exchange between systems - Near Field Communication - Interface and Protocol (NFCIP-1)
ISO/IEC 14443-2	Identification cards - Contactless integrated circuit(s) cards - Proximity cards - Part 2:Radio frequency power and signal interface Type-A, Type-B
ISO/IEC 15693-2	Identification cards - Contactless integrated circuit(s) cards - Vicinity cards - Part 2: Air interface and initialization
EPCglobal	EPC Radio-Frequency Identity Protocols Class-1 Generation-2 UHF RFID Protocol for Communications at 860 MHz-960 MHz Version 1.0.9 (ISO/IEC 18000-6 Type-C)
C0G1 (EPCglobal Gen1 Class0)	Auto-ID Center Draft protocol specification for a 900 MHz Class 0 Radio Frequency Identification Tag
C1G1 (EPCglobal Gen1 Class1)	Auto-ID Center TECHNICAL REPORT 860MHz-930MHz Class 1 Radio Frequency Identification Tag Radio Frequency & Logical Communication Interface Specification Candidate Recommendation, Version 1.0.1

<sup>1</sup> This instrument does not support ISO/IEC 18000-4 Mode-2.

**Measurement Items** Table 3-16 shows the measurement items in the RFID analysis. (Select the items using the **Measure** key.)

**Table 3-16: Measurement items for RFID analysis**

Measure menu	Measurement items
Carrier	<ul style="list-style-type: none"> <li>■ Carrier frequency</li> <li>■ OBW (Occupied Bandwidth)</li> <li>■ EBW (Emission Bandwidth)</li> <li>■ Maximum EIRP (Effective Isotropically Radiated Power)</li> </ul>
Spurious	<ul style="list-style-type: none"> <li>■ Spurious</li> </ul>
ACPR	<ul style="list-style-type: none"> <li>■ ACPR (Adjacent Channel Leak Power Ratio)</li> </ul>
Power On/Down	<ul style="list-style-type: none"> <li>■ Transmission Power on/down rise/fall time</li> <li>■ Settling time</li> <li>■ Overshoot</li> <li>■ Undershoot</li> </ul>
RF Envelope / FSK Pulse	<ul style="list-style-type: none"> <li>■ On/Off width</li> <li>■ Duty cycle</li> <li>■ On/Off ripple</li> <li>■ Rise/Fall time</li> </ul>
Constellation	<ul style="list-style-type: none"> <li>■ Modulation depth</li> </ul>
Eye Diagram	<ul style="list-style-type: none"> <li>■ Modulation index</li> <li>■ Frequency error</li> </ul>
Symbol Table	<ul style="list-style-type: none"> <li>■ Bit rate or Tari</li> </ul>



**Figure 3-63: RFID waveform and measurement items**

Figure 3-63 illustrates the measurement items with a typical RFID waveform. The analyses are performed on the carrier in the Carrier, Spurious, and ACPR measurements, on the transmission power on/down in the Power On/Down measurement, and on the Interrogator-to-Tag or Tag-to-Interrogator signaling in the RF Envelope, Constellation, Eye Diagram, and Symbol Table measurements.

### Basic Procedure

Use the following procedure to perform the RFID analysis.

---

**NOTE.** *If you use a signal input (Input > Signal Input Port...) other than RF, the measurements are not guaranteed.*

*For Option 02 (256 MB memory), the acquisition length (Acquisition/Analysis > Acquisition Length) and the analysis length (Acquisition/Analysis > Analysis Length) are both up to 1.28 s at the maximum real-time span (36 MHz). The length of a burst is up to 20 ms. A burst more than 20 ms is analyzed every 20 ms as one burst each. The time length varies according to span settings.*

---

1. Press the **Demod** key on the front panel.
2. Select **Standard... > RFID** using the side keys.
3. Select a measurement item by pressing the side key.  
For example, press the **Carrier** side key to perform the carrier measurement.
4. Adjust the amplitude and frequency to display the measurement waveform.

Refer to page 3-135 for setting frequency and span.  
Refer to page 3-143 for setting amplitude.

5. Set the analysis range in the overview.  
(This is not necessary in the spurious and ACPR measurements.)

Refer to page 3-34 for details of the analysis range settings.

If you use the zoom function, do these steps:

- Press the View: **Define** key.
- Press the **Overview Content...** side key and select **Zoom**.

Refer to *Zoom Function* on page 3-27 for setting the analysis area on the spectrogram with the zoom function.

6. Press the **Meas Setup** key and set the measurement parameters.  
Refer to *Meas Setup Menu* in each measurement description.
7. Press the **Analyze** side key and carry out the analysis.  
(It is not necessary in the spurious and ACPR measurements.)

## Carrier Measurement

Measures the carrier frequency, OBW (Occupied Bandwidth), EBW (Emission Bandwidth), and the maximum EIRP (Effective Isotropically Radiated Power).

**Meas Setup Menu.** The following items are provided in the Meas Setup menu of the carrier measurement.

**Analyze.** Perform measurements for acquired data in the analysis range.

---

**NOTE.** When you change settings in the Meas Setup menu, press the **Analyze** side key to perform the measurement for the modified settings.

---

**Counter Resolution.** Sets the resolution of the carrier frequency measurement. Setting range: 1 mHz to 1 MHz (switching by 10 times, default: 1 Hz)

Refer to page 3-10 for the carrier frequency measurement in the S/A mode.

**Power Ratio Unit for OBW or EBW.** Selects the unit for the OBW or EBW measurement: % or dB.

Refer to *OBW Measurement* (page 3-8) and *EBW Measurement* (page 3-10) in the spectrum analysis (S/A mode).

**Power Ratio for OBW (%).** Valid when % is selected for the unit.

Sets the power ratio of the carrier and span region of the OBW measurement. Range: 80 to 100% (default: 99%).

**Power Ratio for EBW (dB).** Valid when dB is selected for the unit.

Sets the power ratio of the carrier and span region of the EBW measurement. Range: -80 to 100 dB (default: -20 dB).

**Antenna Gain.** Sets the amplitude offset for the maximum EIRP measurement. The maximum EIRP value to which the amplitude offset value is added is displayed as the measurement result. Range: -100 to 100 dB (default: 0 dB).

**Channel Bandwidth.** Sets the channel bandwidth for the maximum EIRP measurement. Range: 0 to Span (default: 0 Hz).

Figure 3-64 shows an example of the carrier measurement.

NOTE. The overview and subview contents can be selected using the View: Define menu.

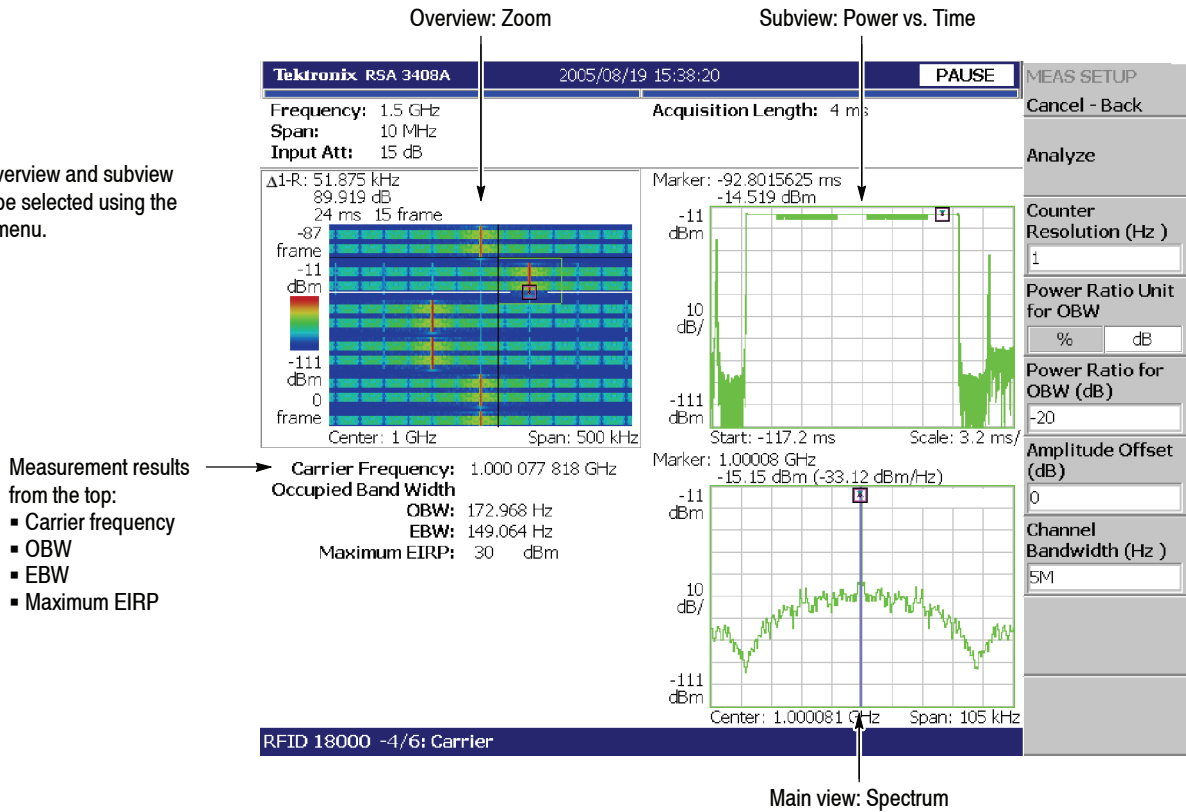


Figure 3-64: Carrier measurement

**Changing the View.** The view contents can be changed in the next item by pressing the View: **Define** key.

**Show Views.** Select whether to display a single view or multiple views.

- **Single.** Only displays the view selected using the View: **Select** key.
- **Multi.** Displays the overview, sub view and main view.

**Overview Content...** Selects the overview information.

- Spectrogram
- Waveform (Power versus Time waveform)
- Zoom (Spectrogram with the zoom function)

Selects Waveform or Zoom while selecting the analysis range.

Refer to *Zoom Function* on page 3-27 for setting the analysis area on the spectrogram with the zoom function.

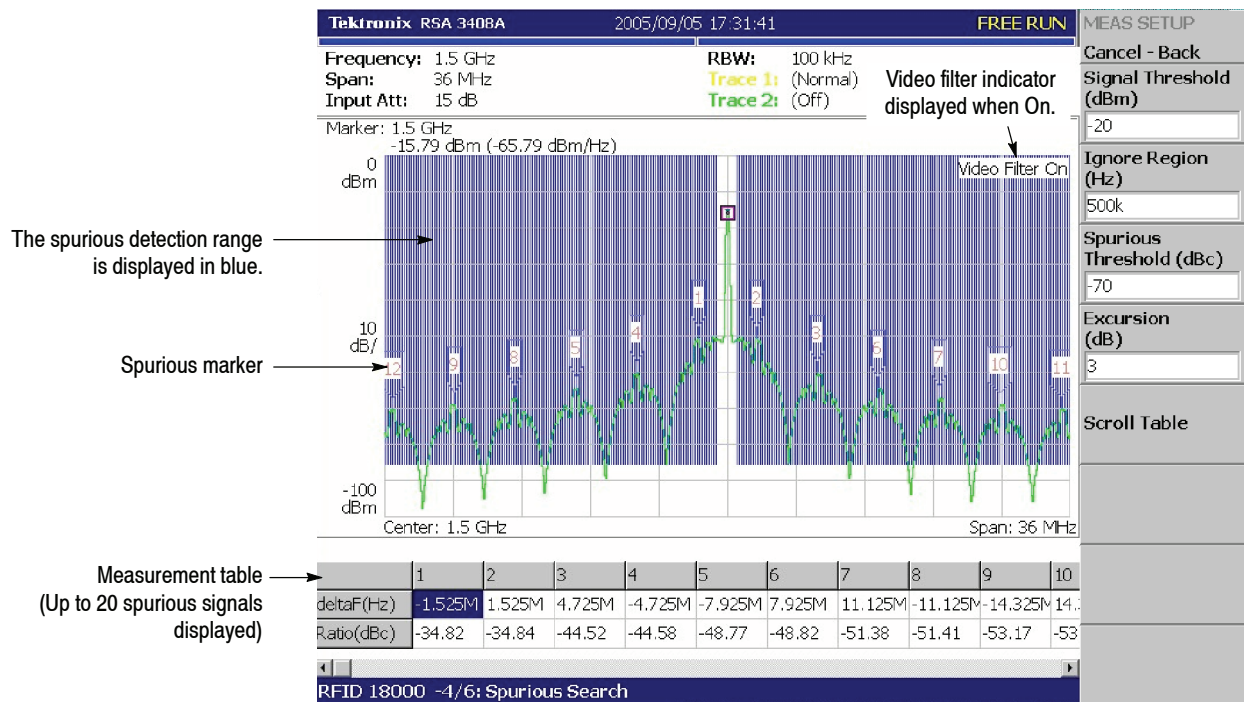
**Subview Content...** Selects the subview information.

- Spectrum
- Power versus Time
- Frequency versus Time
- Zoomed Spectrum (Spectrum of a zoomed area in the Zoom display)

**Setting the View Scale.** Refer to page 3-203 for information on setting the scale for each view. Note that when the subview is Power versus Time or Frequency versus Time, Default Scale is used instead of Full Scale in the View Scale menu. The time-domain waveform is processed in units of 256K data points. When the number of points equivalent to the analysis length (Acquisition/Analysis > Analysis Length) is 256K or less, pressing the **Default Scale** side key sets the horizontal scale so that the whole waveform is displayed in the analysis range. When it is greater than 256K, the horizontal full scale is set to the time equivalent of 256K points, displaying part of the waveform in the analysis range.

### Spurious Measurement

Measures the spurious level of the RF signal. It is the same as the spurious measurement in the S/A mode (refer to page 3-12).



**Figure 3-65: Spurious measurement**



**Meas Setup Menu.** The Meas Setup menu of the spurious measurement is same as that of the S/A mode. Refer to page 3-12.

Figure 3-65 (on page 3-82) shows an example of the spurious measurement. For the detected spurious signals, the spurious marker is displayed on the waveform by assigning the numbers from 1 in the maximum order of amplitude. Furthermore, the frequency difference ( $\Delta F$ ) and amplitude ratio (Ratio) with the carrier is displayed in the table, in the lower part of the screen.

**Using Video Filter.** The spurious measurement in the RFID analysis has a video filter function for compatibility with measurement data from conventional swept spectrum analyzers. Normally swept spectrum analyzers smooth the detected signal with a video filter having a bandwidth equal to the resolution bandwidth. However, you can set the bandwidth and sweep time on this analyzer. When you use the video filter, press the **RBW/FFT** key on the front panel to set the following items:

**Video Filter.** Determines whether to use the video filter.

When you use the filter, select On. Then the following items appear:

**VBW.** Sets the frequency bandwidth of the video filter. Range: 1 Hz to 1 GHz. The setting value may be limited by the sweep time setting.

**Sweep Time for VBW.** Sets the sweep time to scan a set span. Range: 1  $\mu$ s to 100 s.

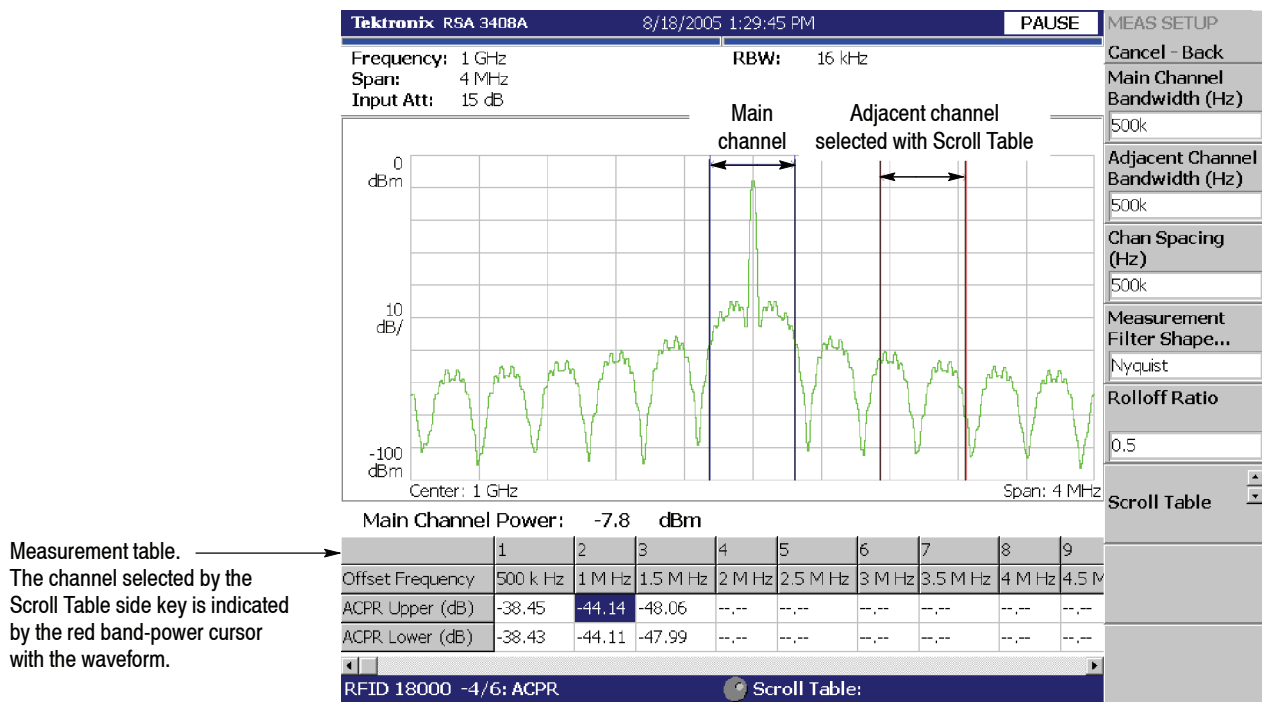
**ACPR Measurement**

The ACPR (Adjacent Channel Leak Power Ratio) measurement is similar to that of the S/A mode (refer to page 3-6). However, in the ACPR measurement of the RFID analysis, the adjacent channel is measured for up to 25 channels from up and down.

**Meas Setup Menu.** The Meas Setup menu of the ACPR measurement is the same as that of the S/A mode except that Scroll Table is added. Refer to page 3-6.

**Scroll Table.** Selects an adjacent channel (1 to 25 in the upper/lower side) from the measurement table displayed in the bottom of the screen.

Figure 3-66 shows an example of the ACPR measurement.



**Figure 3-66: ACPR measurements**

**Power On/Down Measurement**

Measures the rise/fall time, settling time, overshoot, and undershoot of the transmission power pulse.

---

**NOTE.** *In the analysis range, there must be at least one pulse rise or fall. If there is not, the analysis is not performed.*

---

**Meas Setup Menu.** The following menu items are common to the power on/down, RF envelope/FSK pulse, constellation, eye diagram, and symbol table measurements.

**Analyze.** Perform measurements for acquired data in the analysis range.

---

**NOTE.** *When you change settings in the Meas Setup menu, press the **Analyze** side key to perform the measurement for the modified settings.*

---

**Standard Type...** Sets the parameters according to the standard as shown in Table 3-17.

**Table 3-17: Standard settings**

Standard type	Link	Modulation type	Decoding format	Bit rate / Tari <sup>1</sup>
18000-4-1	Interrogator to Tag	ASK	Manchester / NRZ	30 kbps
	Tag to Interrogator		FM0 / NRZ	
18000-6-A	Interrogator to Tag	ASK	PIE (Type A)	20 $\mu$ s (Tari)
			NRZ	33 kbps
	Tag to Interrogator		FM0 / NRZ	33 kbps
18000-6-B	Interrogator to Tag	ASK	Manchester / NRZ	10 kbps
	Tag to Interrogator		FM0 / NRZ	
18000-6-C	Interrogator to Tag	DSB-ASK SSB-ASK PR-ASK	PIE (Type C)	6.25 $\mu$ s (Tari)
			NRZ	26.7 kbps
	Tag to Interrogator	ASK	FM0 Miller (M_2 / M_4 / M_8) NRZ	26.7 kbps
18000-7	-	FSK	Manchester / NRZ	27.7 kbps
14443-2-A	Interrogator to Tag	ASK	Modified Miller / NRZ	105.9375 kbps
	Tag to Interrogator	Subcarrier OOK	Manchester / NRZ	105.9375 kbps
		Subcarrier BPSK	NRZ-L (4 periods)	211.875 kbps
			NRZ-L (2 periods)	423.75 kbps

**Table 3- 17: Standard settings (Cont.)**

Standard type	Link	Modulation type	Decoding format	Bit rate / Tari <sup>1</sup>
14443-2-B	Interrogator to Tag	ASK	NRZ	105.9375 kbps
	Tag to Interrogator	Subcarrier BPSK	NRZ-L (8 periods)	105.9375 kbps
			NRZ-L (4 periods)	211.875 kbps
			NRZ-L (2 periods)	423.75 kbps
18092(424k)	-	ASK	Manchester / NRZ	212 kbps
15693-2	Interrogator to Tag	ASK	1 out of 4 / 1 out of 256	Not settable (fixed internally)
	Tag to Interrogator		SSC High / SSC Low DSC High / DSC Low	
C0G1	Interrogator to Tag	ASK	PWM	40 kbps
	Tag to Interrogator	FSK	NRZ	
C1G1	Interrogator to Tag	ASK	PWM	70.18 kbps
	Tag to Interrogator		Bit Cell	140.35 kbps
Manual	-	ASK DSB-ASK SSB-ASK PR-ASK OOK	Manchester / FM0 / NRZ Miller / Modified Miller Miller (M_2 / M_4 / M_8)	40 kbps
			PIE (Type A)	20 μs (Tari)
			PIE (Type C)	6.25 μs (Tari)
		FSK	Manchester / FM0 / NRZ Miller / Modified Miller	9.6 kbps

[Abbrev.] DSB: Double sideband; SSB: Single sideband; PR: Phase reversal; OOK: On/Off key;  
 PIE: Pulse interval encoding; PWM: Pulse Width Modulation  
 SSC: Single Subcarrier; DSC: Double Subcarrier

<sup>1</sup> Default values are shown. It can be set from 1 bps to 51.2 Mbps (bit rate) or from 1 ns to 1 s (Tari).

---

**NOTE.** The standard types of C0G1 and C1G1 disable the constellation measurement.

---

Tari is the reference time interval for a data-0 in Interrogator-to-Tag signaling, defined in ISO/IEC 18000-6 Part A specification (an abbreviation for Type A Reference Interval).

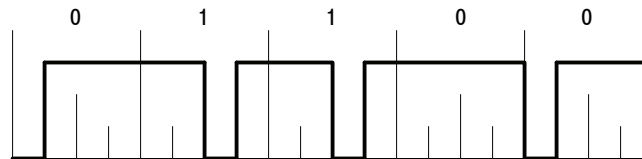
The period of the NRZ-L decoding format (2, 4, and 8 periods) indicate the number of subcarrier cycles per symbol.

---

**NOTE.** This instrument does not support one-period NRZ-L.

---

The M values (M\_2, 4, and 8) of the Miller decoding format indicate the number of subcarrier cycles per symbol. Refer to the ISO/IEC and EPCglobal documents listed in *Compatible Standards* on page 3-77 for details on the encoding/decoding formats except the modified Miller code illustrated in Figure 3-67.



**Figure 3-67: Modified Miller code**

**Link...** Selects whether to measure Interrogator-to-Tag signaling or Tag-to-Interrogator signaling.

- **Interrogator.** Detects the interrogator preamble from a measurement signal and decodes the signal with the interrogator decoding format.
- **Tag.** Detects the tag preamble from a measurement signal and decodes the signal with the tag decoding format.

**Modulation Type.** Selects the modulation type. Refer to Table 3-17.

**Decoding Format.** Selects the decoding format. Refer to Table 3-17.

**Auto Bit Rate** or **Auto Tari.** Selects whether to set the bit rate or Tari automatically. Tari is the parameter for the PIE Type A and C decoding formats.

- **On.** Detects the bit rate or Tari automatically based on the Bit Rate or Tari set value.
- **Off. Default.** Sets the bit rate or Tari using the Bit Rate or Tari side key.

---

**NOTE.** *The Auto Bit Rate or Auto Tari can be set to On or Off for the four measurements of RF Envelope, Constellation, Eye Diagram, and Symbol Table, but it is fixed to Off for the Power On/Down measurement. When you run the Power On/Down measurement, these four measurements are also performed at the same time with the Auto Bit Rate or Auto Tari still set to Off. If you want to turn it On to perform the measurements, select **On** for **Auto Bit Rate** or **Auto Tari** and then press the **Analyze** side key in each measurement.*

---

*Auto Bit Rate, Auto Tari, Bit Rate, and Tari are invalid for the 15693-2 standard.*

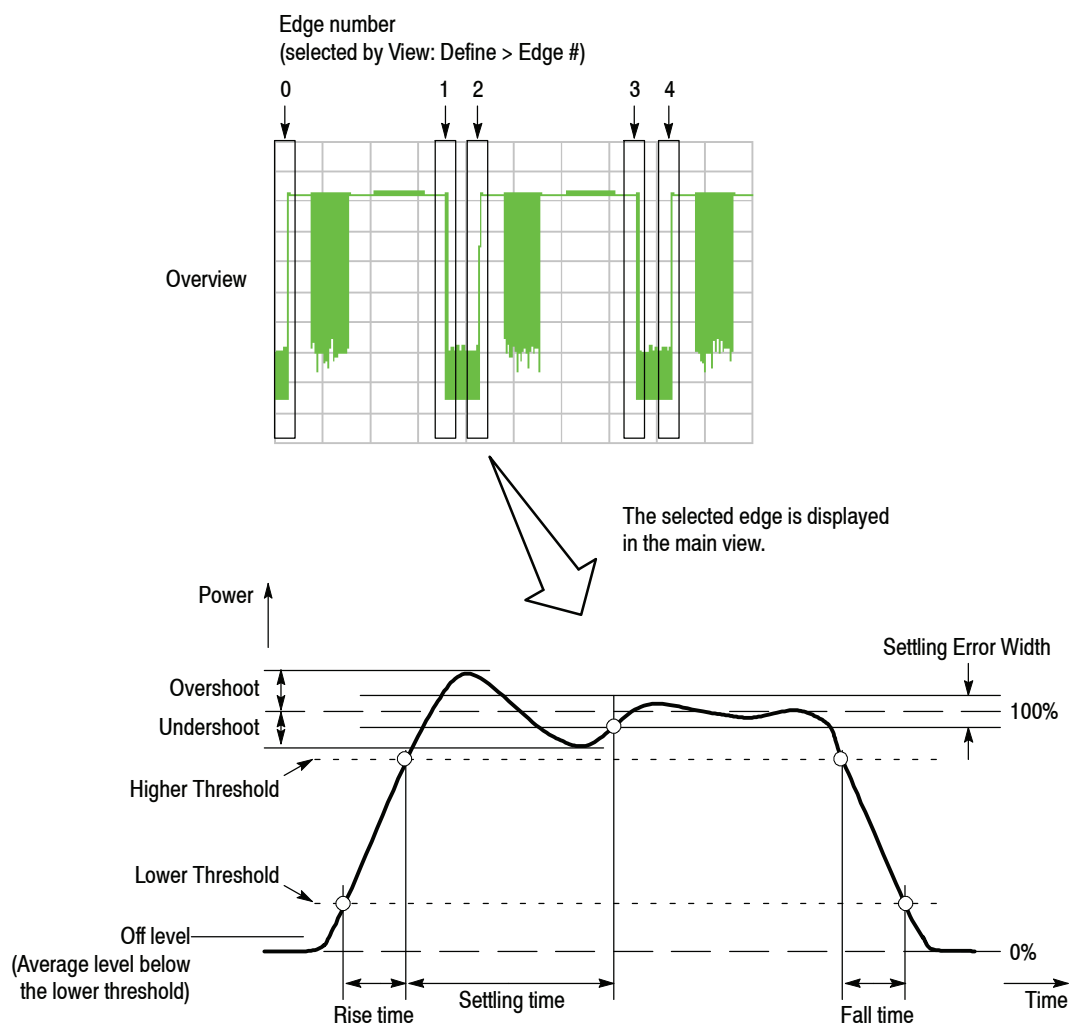
---

**Bit Rate.** Sets the bit rate. Range: 1 bps to 51.2 Mbps. Refer to Table 3-17.

**Tari.** Sets the Tari. Range: 1 ns to 1 s. Refer to Table 3-17.

**NOTE.** You must set the bit rate or Tari manually to perform the analysis properly. Refer to Setting the Bit Rate / Tari on page 3-90.

**Settling Error Width +/-.** Sets an error range for determining the settling time. See Figure 3-68. Range: 1 to 100% (default: 5%).



**Figure 3-68: Transmission power on/down measurement parameters**

**Lower Threshold.** Sets the lower threshold value for measuring the rise/fall time of the pulse. See Figure 3-68. Range: 1% to (Middle Threshold). Default value: 10%, or 5% only for the 14443-2-A, 18092(424k), and 15693-2 standards.

**Middle Threshold.** Sets the middle threshold value for measuring the width of the pulse. See Figure 3-68. Range: (Lower Threshold) to (Higher Threshold). Default value: 50%, or 60% only for the 14443-2-A, 18092(424k), and 15693-2 standards.

**Higher Threshold.** Sets the higher threshold value for measuring the rise/fall time of the pulse. See Figure 3-68. Range: (Middle Threshold) to 99%. Default value: 90%, or 95% only for the 15693-2 standard.

**Interpolation Points.** When the sample rate is lower than the bit rate, because the data cannot be analyzed correctly, the shortage of the sample rate is calculated and interpolated by the spline method.

Range: 0 to 7 (default: 0). Zero means no interpolation.

$$\text{(Effective sample rate)} = \frac{\text{(Actual sample rate)}}{[(\text{Interpolation Points setting value}) + 1]}$$

The actual sample rate and effective sample rate are displayed in the main view of the power on/down and RF envelope measurements (see Figure 3-69 on page 3-91 and Figure 3-70 on page 3-93).

**Advanced Parameter...** For the standard types of 14443-2-A and 14443-2-B only. Sets the following three parameters:

**Channel Filter...** Selects the filter for demodulating an input signal.

- None (no filter, default for Interrogator)
- Raised Cosine (default for Tag)

**Preamble.** Determines whether to search for the preamble.

- **On. Default.** Searches for the preamble while analyzing data. The preamble is displayed in yellow in the symbol table.
- **Off.** Analyzes data without searching for the preamble.

**Side Band.** Selects the sideband to analyze.

- **Upper. Default.** Analyzes the upper sideband.
- **Lower.** Analyzes the lower sideband.

**Setting the Bit Rate / Tari.** You must set the bit rate or Tari near the true value (within  $\pm 20\%$  of the true value approximately depending on waveform) to perform the analysis properly in the power on/down, RF envelope, constellation, eye diagram, and symbol table measurements.

---

**NOTE.** *If the bit rate or Tari setting value is out of range, the analyzer cannot distinguish between the rising edge of the power-on CW and that of the RF envelope pulse.*

---

In the measurement setup, enter the bit rate or Tari and perform the analysis using the following steps:

1. Press the **Meas Setup** key on the front panel.
2. Press the **Standard Type...** side key and select the standard.
3. Select **Link, Modulation Type,** and **Decoding Format** as appropriate.
4. Select Off in the **Auto Bit Rate** or **Auto Tari** side key.
5. Press the **Bit Rate** side key and set the bit rate, or press the **Tari** side key and set the Tari. Enter a value near the true value (within about  $\pm 20\%$  of the true value).
6. Press the **Auto Bit Rate** or **Auto Tari** side key to select On.

---

**NOTE.** *When you set Auto Bit Rate or Auto Tari to On, the analyzer estimates the bit rate or Tari from your input value and performs measurements based on the estimate. If you want to use your input value directly in measurements without using an estimate, leave the Auto Bit Rate or Auto Tari setting Off.*

---

7. Press the **Analyze** side key to perform the analysis.  
The analysis is performed based on the bit rate or Tari set value.

After the analysis has been completed, the estimated bit rate or Tari is displayed in the **Bit Rate** side key.

In the constellation, eye diagram, and symbol table measurements, the calculated bit rate or Tari is also displayed in the main view (see Figure 3-72 on page 3-96).



Figure 3-69 shows an example of the power on/down measurements. You can save the measurement table to a file (\*.csv) by **Save > Save Table**. For file operations, refer to page 3-251.

NOTE. The overview and subview contents can be selected using the View: Define menu.

- Sample rate
  - Effective sample rate
- (Refer to *Interpolation Points* on page 3-89)

Measurement table

- Rise/Fall time
- Settling time
- Overshoot
- Undershoot
- Off level

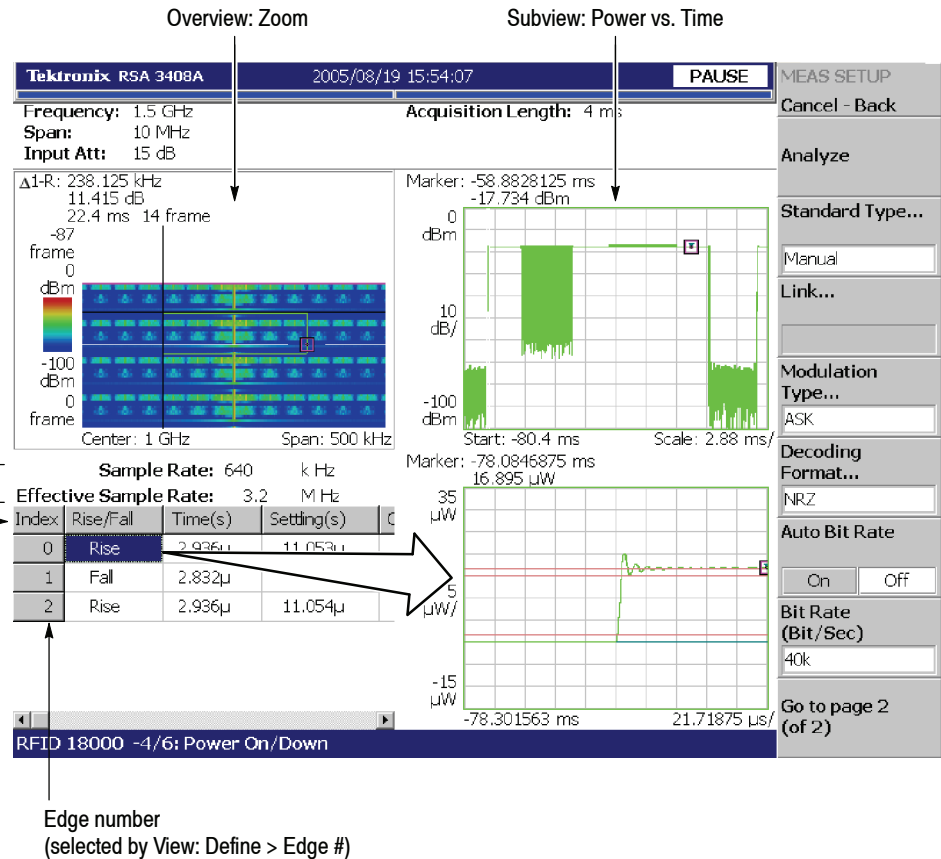


Figure 3-69: Power on/down measurements

**Changing the View.** The contents of the view can be changed in the following item by pressing the View: **Define** key.

The following items are the same as the RF carrier measurement. Refer to page 3-80:

- Show Views
- Overview Content...
- Subview Content...

**Edge #.** Selects an edge number (index number of the measurement table) for displaying a waveform on the main screen. The edge number is assigned to the rising/falling edge of each pulse. (Refer to page 3-88, Figure 3-68.)

**Guidelines.** Selects whether to display the guideline (red) along with the waveform in the main view.

- **On.** *Default.* Displays the guideline.
- **Off.** No guideline is displayed.

**Scroll Table.** Scrolls the measurement table in the main view horizontally.

**Changing the Vertical Unit.** The unit is W (watts) by default for the vertical axis of the graph displayed in the main view. You can also select dBm and V (volts) using View: **Scale/Lines** > **Scale** > **Unit**.

---

**NOTE.** *The measurement table in the main view always displays the results for waveform data with the default unit of W. Selecting the unit does not affect the table contents.*

---

### **RF Envelope / FSK Pulse Measurement**

Measures time attributes for each envelope on the Interrogator-to-Tag or Tag-to-Interrogator signaling and displays the measurement table with the amplitude versus time waveform.

The RF Envelope measurement switches to the FSK Pulse measurement with one of the following settings in the Meas Setup menu:

- Standard Type is set to 18000-7
- Standard Type is set to Manual and Decoding Format FSK

The vertical axis changes from amplitude in the RF Envelope measurement to frequency in the FSK Pulse.

**Meas Setup Menu.** The Meas Setup menu of the RF envelope / FSK pulse measurement is the same as the power on/down measurement. Refer to page 3-85.

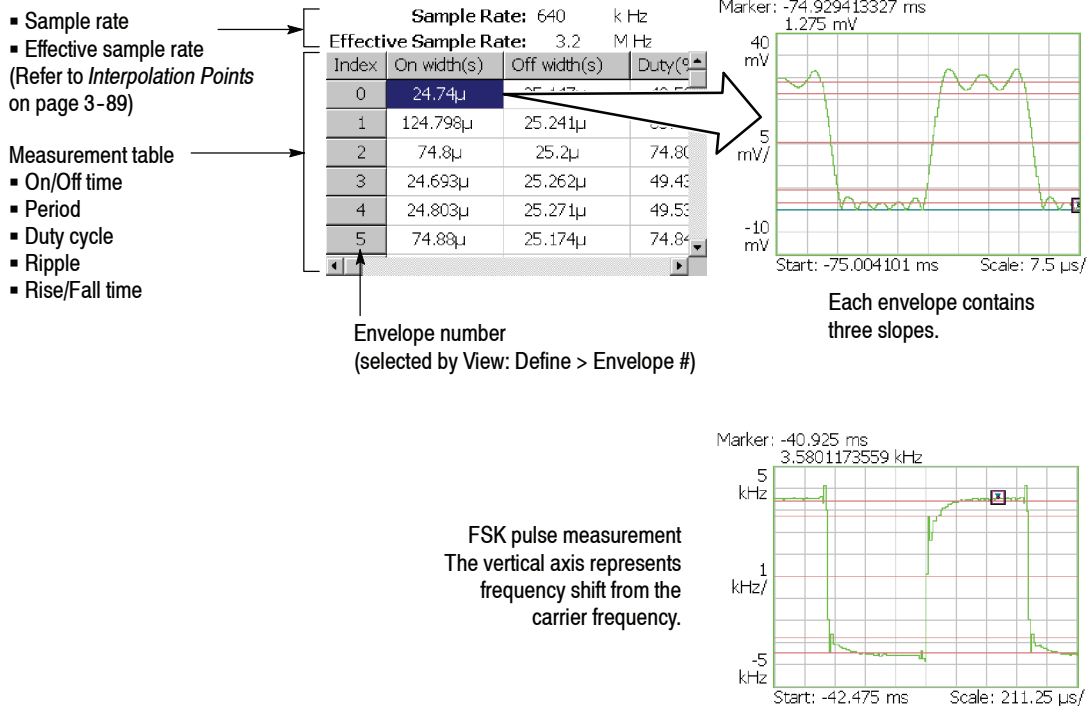


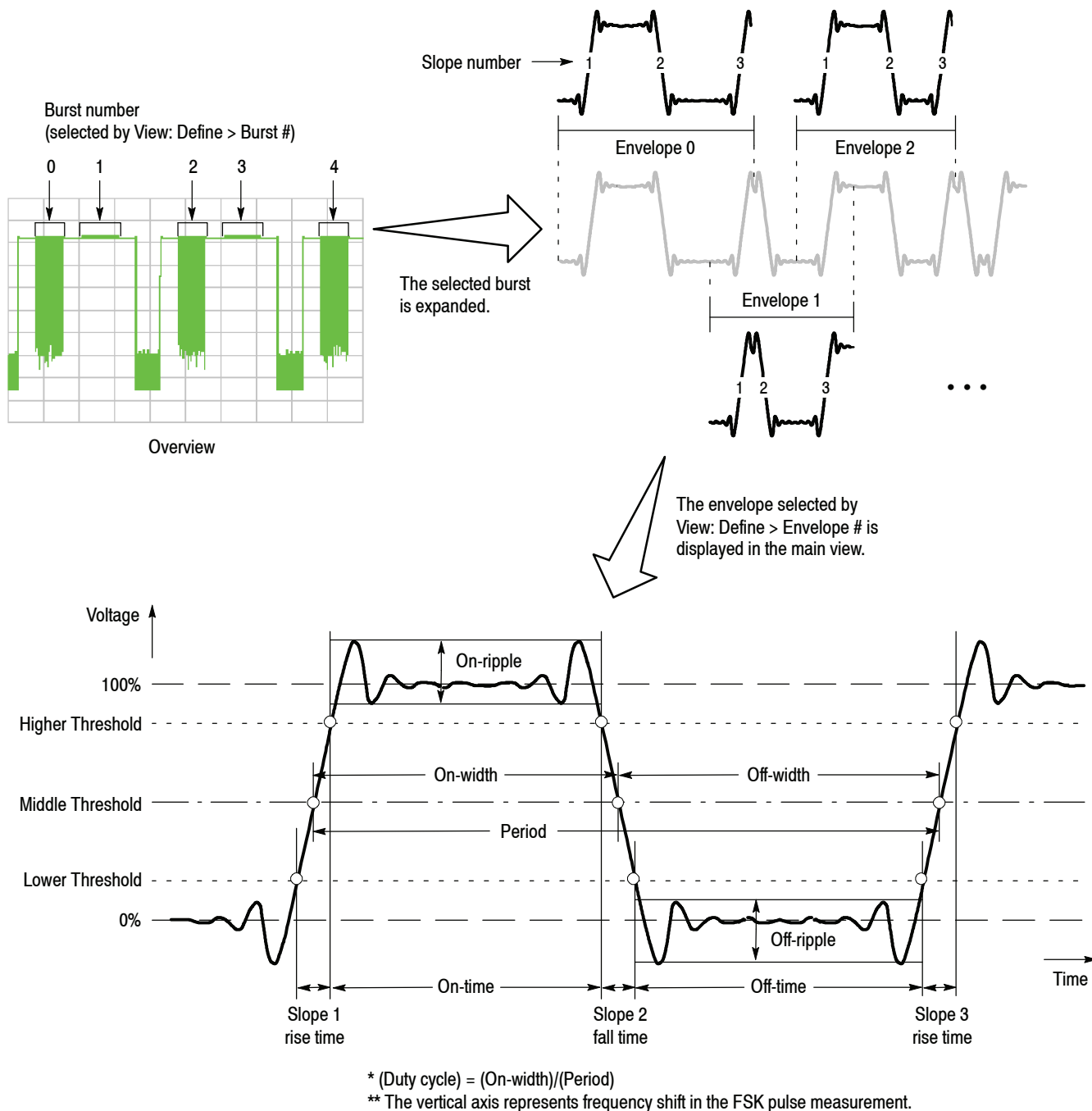
Figure 3-70: RF envelope / FSK pulse measurement (main view)

Figure 3-70 shows an example of the RF envelope / FSK pulse measurement main view. The following items are provided in the measurement table (see also Figure 3-71).

Table 3-18: Details of the RF envelope / FSK pulse measurement table

Item	Description
Index	Envelope # (Select by View: Define > Envelope)
On-width / Off-width	Pulse width for pulse on or off
Period	Period (= (On-width) + (Off-width) )
Duty	Duty cycle (= (On-width) / (Period) )
On-ripple / Off-ripple	Ripple of on-time or off-time
Slope 1, 2, and 3	Rise/Fall time of slope 1, 2, and 3 (Slope 3 is Slope 1 of the envelope on the right)
T1, T2, T3, and T4 <sup>1</sup>	Pulse characteristic values defined in the 14443-2-A, 18092(424k), and 15693-2 standards

<sup>1</sup> For the definitions of T1, T2, T3, and T4, refer to the ISO/IEC 18092, 14443-2, and 15693-2 standard specifications shown in Table 3-15 on page 3-77.



**Figure 3-71: RF envelope / FSK pulse measurement parameters**

You can save the measurement table to a file (\*.csv) by **Save > Save Table**.  
For file operations, refer to page 3-251.

**Changing the View.** The contents of the view can be changed in the next item by pressing the View: **Define** key.

The next items are the same as the carrier measurement. Refer to page 3-81.

**Show Views  
Overview Content...**

**Subview Content...** Selects the information displayed in the subview.

- Spectrum
- Power versus Time
- Frequency versus Time
- Zoomed Spectrum (Spectrum for a zoomed area in the Zoom display)
- RF Envelope (Waveform same as the RF envelope in the main view)
- Constellation (Waveform same as the constellation in the main view)
- Eye Diagram (Waveform same as the eye diagram in the main view)
- Symbol Table (Same as the symbol table in the main view)

Refer to page 3-27 for the zoom function.

Refer to page 3-82 for setting the view scale.

**Burst #.** Selects the burst number to be measured.

(Refer to page 3-94, Figure 3-71.)

The setting range is limited as follows (default: 0):

$$(\text{Burst \# setting}) + (\text{Edge \# setting}) \leq 20000 \text{ (for Edge \#, refer to page 3-92)}$$

**Envelope #.** Selects the envelope number (the index number in the RF envelope measurement table) that displays the waveform in the main view.

Range: 0 to 65536. (Refer to page 3-94, Figure 3-71.)

**Guidelines.** Selects whether to display the guidelines (red color) along with the waveform in the main view.

- **On. Default.** Displays the guidelines.
- **Off.** No guideline is displayed.

**Scroll Table.** Scrolls the measurement table in the main view horizontally.

**Display Area.** *Valid for the constellation and the eye diagram views.*

Sets the percentage of display area (sample points) from the beginning in the selected burst.

Range: 0.1 to 100% (default: 100%). 100% represents the whole burst.

**Changing the Vertical Unit.** The unit for the vertical axis of the graph displayed in the main view is V (volts) by default. You can also select dBm and W (watts) using View: **Scale/Lines > Scale > Unit**.

**NOTE.** The measurement table in the main view always displays the results for waveform data with the default unit of W. Selecting the unit does not affect the table contents.

**Constellation, Eye Diagram, and Symbol Table**

Measures modulation attributes on the Interrogator-to-Tag or Tag-to-Interrogator signaling and displays the constellation, eye diagram, or symbol table (see Figure 3-72).

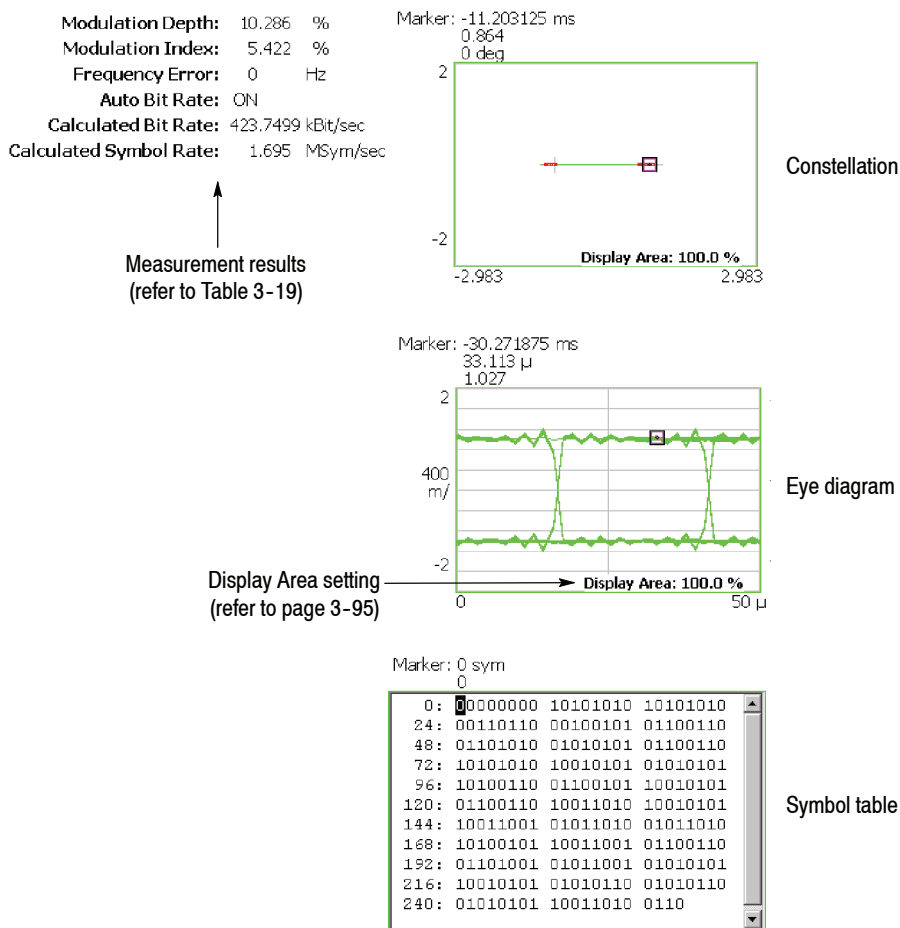


Figure 3-72: Constellation, eye diagram, and symbol table (main view)

The constellation, eye diagram, and symbol table are based on the digital modulation analysis function. Refer to *Digital Modulation Analysis* on page 3-48.

**Meas Setup Menu.** The Meas Setup menu for the constellation, eye diagram, and symbol table is the same as the power on/down measurement. Refer to page 3-85.

The measurement result display items depend on standards (Meas Setup > Standard Type) as shown in Table 3-19.

**Table 3-19: Measurement result display items**

18000-4-1, 18000-6-A/B/C, 14443-2-A/B, 18092(424k), C0G1, and C1G1 standards and Manual	18000-7 standard	15693-2 standard	Manual (FSK modulation only)
<ul style="list-style-type: none"> <li>▪ Modulation depth</li> <li>▪ Modulation index</li> <li>▪ Frequency error</li> <li>▪ Auto bit rate (on/off) <sup>1</sup></li> <li>▪ Calculated bit rate <sup>2</sup></li> <li>▪ Calculated symbol rate <sup>2</sup></li> <li>▪ Subcarrier jitter (rms) <sup>3</sup></li> <li>▪ Frequency offset <sup>3</sup></li> <li>▪ Calculated Tari data-0 <sup>4</sup> (duration of a data-0)</li> <li>▪ Calculated Tari data-1 <sup>4</sup> (duration of a data-1)</li> </ul>	<ul style="list-style-type: none"> <li>▪ Frequency deviation</li> <li>▪ Preamble detection (Interrogator / Tag)</li> <li>▪ Frequency error</li> <li>▪ Auto bit rate (on/off) <sup>1</sup></li> <li>▪ Calculated bit rate</li> <li>▪ Calculated symbol rate</li> </ul>	<ul style="list-style-type: none"> <li>▪ Modulation depth</li> <li>▪ Modulation index</li> <li>▪ Frequency error</li> <li>▪ Calculated bit rate</li> </ul>	<ul style="list-style-type: none"> <li>▪ Frequency deviation</li> <li>▪ Frequency error</li> <li>▪ Auto bit rate (on/off) <sup>1</sup></li> <li>▪ Calculated bit rate</li> <li>▪ Calculated symbol rate</li> </ul>

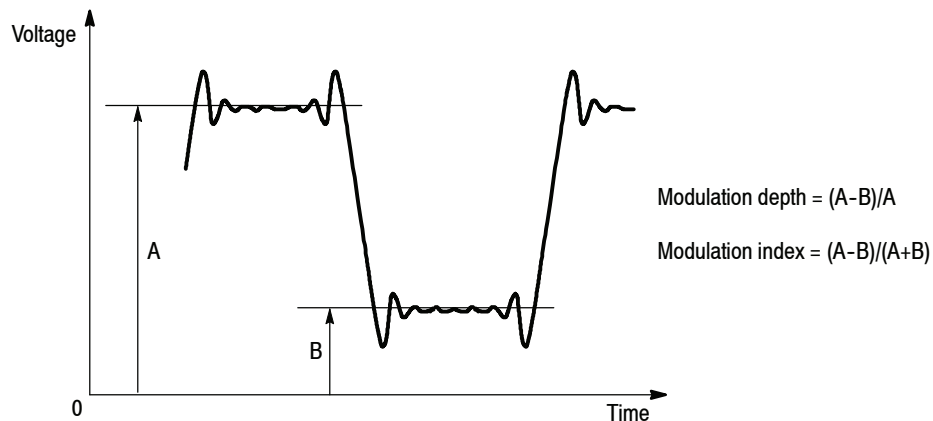
<sup>1</sup> Set in the Meas Setup menu.

<sup>2</sup> For other than PIE decoding.

<sup>3</sup> For Subcarrier BPSK only.

<sup>4</sup> For PIE decoding only.

Figure 3-73 shows the definition of the modulation depth and index.



**Figure 3-73: Definition of the modulation depth and index**

Table 3-20 shows the definition of symbol values displayed in the symbol table.

**Table 3-20: Symbol value definition**

Symbol value	Definition
0	0
1	1
X	Don't care
P	Preamble
S	Frame Sync or SOF <sup>1</sup>
N	Null
I	Interrogator
T	Tag
E	EOF <sup>1</sup>

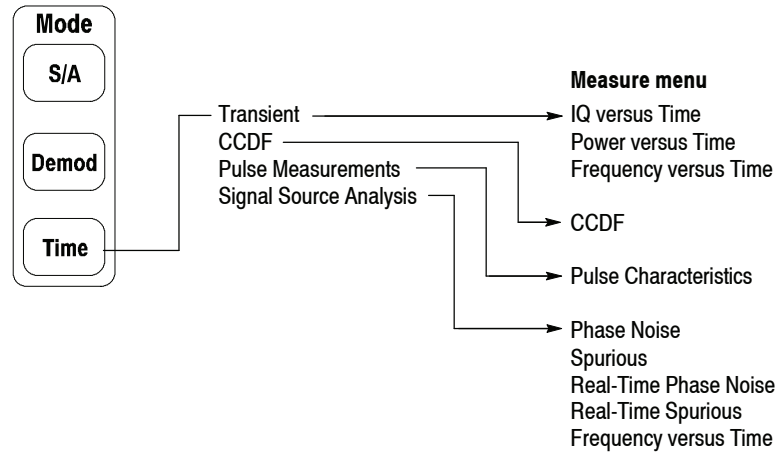
<sup>1</sup> 15693-2 standard only.

**Changing the View.** The view controls for the constellation, eye diagram, and symbol table are the same as the RF envelope measurement except for the Scroll Table side key. Refer to page 3-95.



# Time Analysis (Time Mode)

This section describes how to perform measurements in the time analysis (Time mode).



**Figure 3-74: Time menu structure**

There are three items in the Time menu:

- **Transient.** Performs time variation measurement. Refer to page 3-100 for details.
- **CCDF.** Performs CCDF measurement. Refer to page 3-104 for details.
- **Pulse Measurements.** Performs pulse measurements. Refer to page 3-109 for details.
- **Signal Source Analysis.** *Option 21 Only.* Performs signal source analysis. Refer to page 3-119 for details.

## Measurement Screen Layout

The measurement screen layout in the time analysis (Time mode) is the same as in the modulation analysis (Demod mode). Refer to *Measurement Screen Layout* on page 3-33 for the view functions, setting an analysis range, and changing the view content.

## Time Variation Measurement

You can select the following time variation measurement items using the **Measure** key when you select **Transient** in the Time menu.

- IQ versus Time
- Power versus Time
- Frequency versus Time

The time variation measurements have no Meas Setup menu items.

### Basic Procedure

Follow these steps to perform the time variation measurement:

1. Press the Mode: **Time** key on the front panel.
2. Press the **Transient** side key and select a measurement item.
3. Display the measurement waveform:

---

**NOTE.** *You should set appropriate frequency and span. It is important to set frequency and span as close to the measurement signal band as possible and finely adjust them. The modulated signal will not be recognized unless frequency and span are set appropriately.*

*For details on setting frequency, span, and amplitude, refer to Setting Frequency and Span on page 3-135 and Setting Amplitude on page 3-143.*

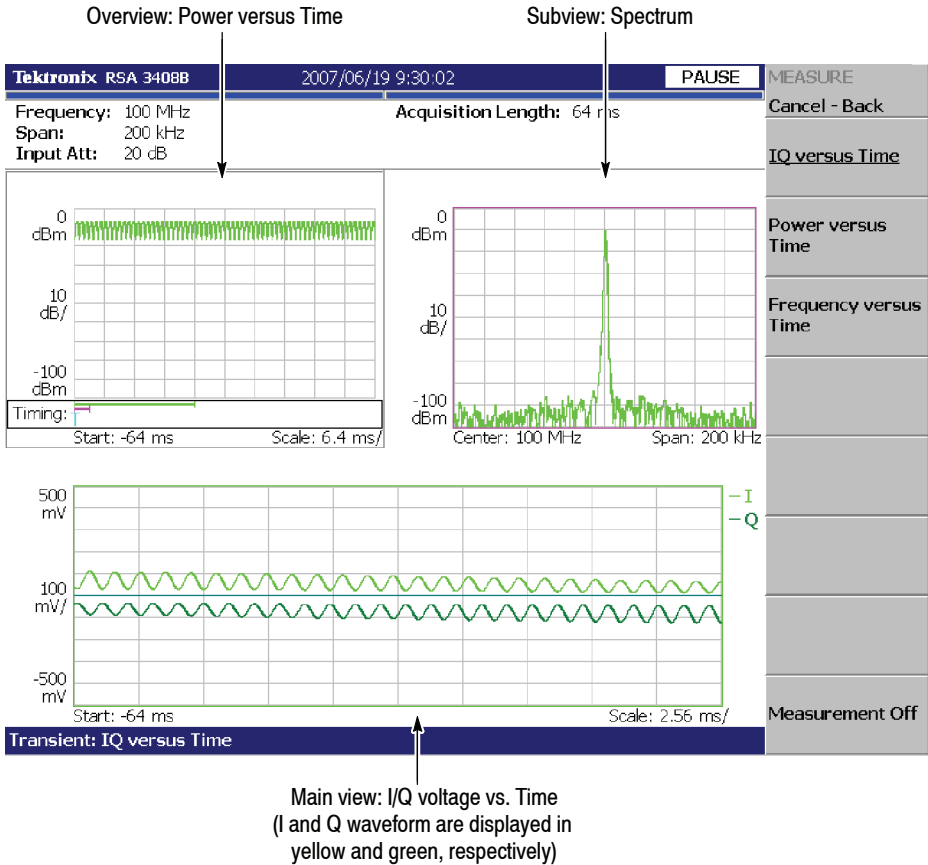
---

- a. Set the frequency by pressing the **Frequency/Channel** key on the front panel.
  - b. Set the span by pressing the **Span** key on the front panel.
  - c. Set the amplitude by pressing the **Amplitude** key on the front panel.
4. Set the analysis range by pressing the **Acquisition/Analysis** key on the front panel. Refer to page 3-34 for details about setting analysis range.

The following pages show the examples for each measurement item. Refer to page 3-203 for information about setting scale and formatting each view. Refer to page 3-38 for information about changing the overview.

**IQ versus Time Measurement**

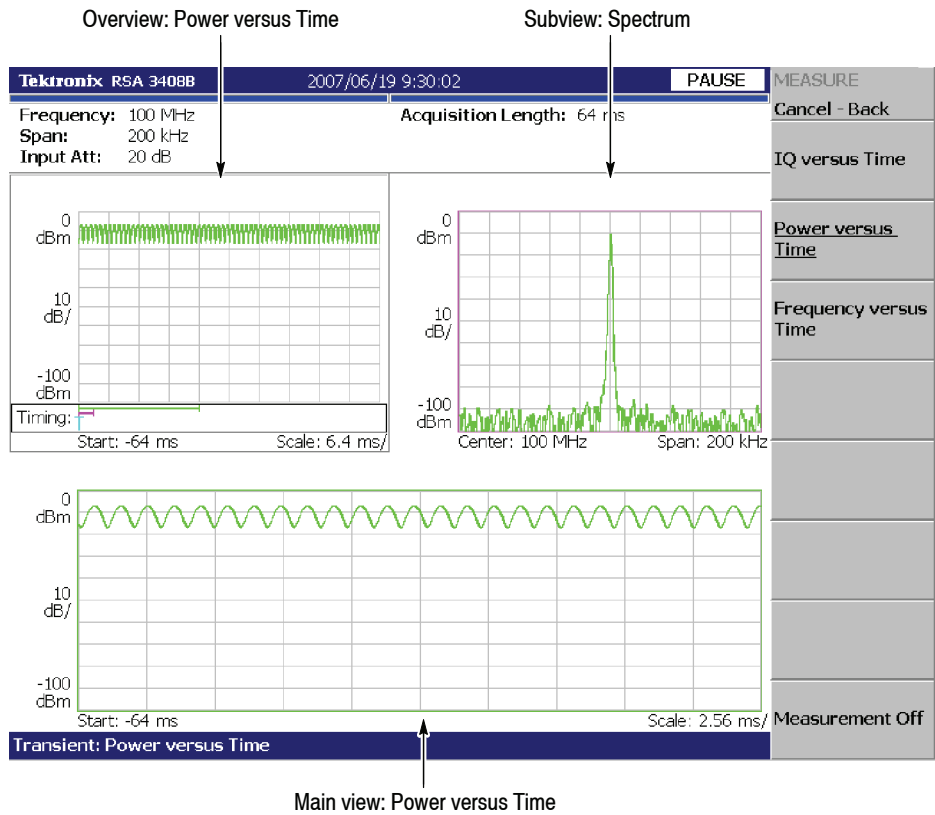
Observes I and Q signal level over time. Figure 3-75 shows an example. The main view displays I/Q voltage versus time. I and Q are indicated in yellow and green, respectively.



**Figure 3-75: IQ versus Time measurement**

**Power versus Time Measurement**

Observes signal power change over time. Figure 3-76 shows an example. The main view displays power level versus time.



**Figure 3-76: Power variance measurement**

### Frequency versus Time Measurement

Observes signal frequency change over time. Figure 3-77 shows an example. The main view displays the frequency deviation from the center frequency versus time.

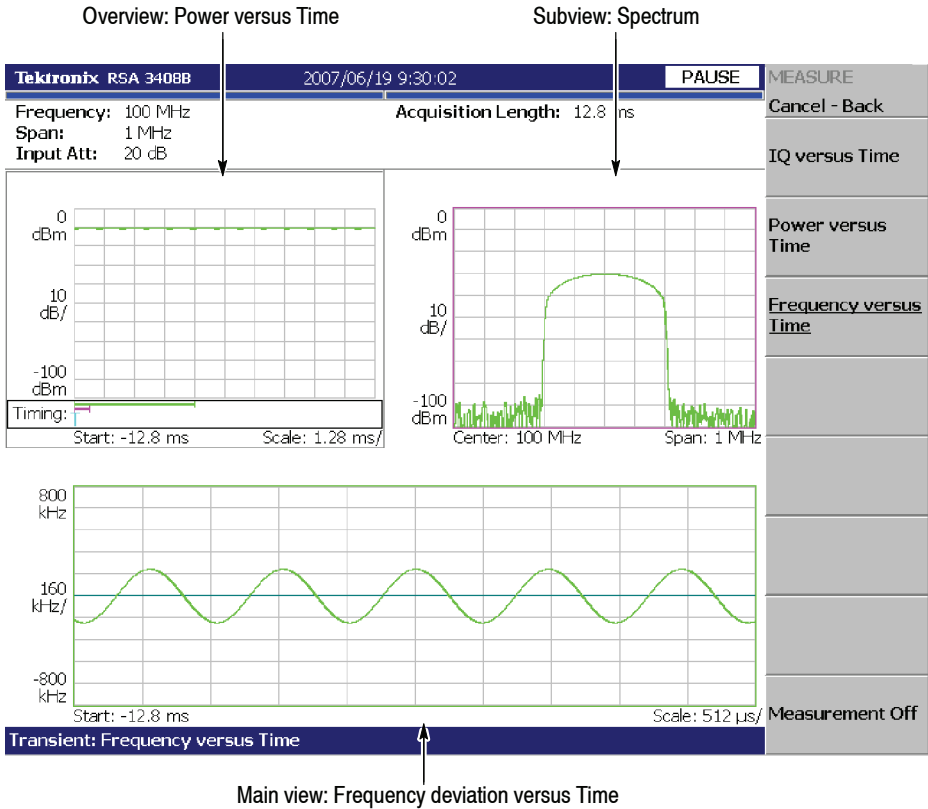


Figure 3-77: Frequency measurement

## CCDF Measurement

CCDF (Complementary Cumulative Distribution Function) represents the probability that the peak power above average power of a measured signal exceeds a threshold. The analyzer displays the ratio of peak power to average power along the horizontal axis, and the probability that the ratio is exceeded along the vertical axis.

This CCDF analysis function and the real-time analysis function allow you to measure the time-varying crest factor in the time series for code-multiplexing signals such as CDMA/W-CDMA signals, and multi-carrier signals such as OFDM signals. This function is useful in designing amplifiers for CDMA/W-CDMA and OFDM.

### CCDF Calculation Process

The CCDF analysis obtains the distribution of the amplitude of observed signals and makes a graph of accumulation from the threshold. CCDF is calculated using this formula:

$$SP(X) = \int_X^{Max} P(Y) dY$$

$$CCDF(X) = SP(X + Average)$$

$$CCDF(crest\ factor) = 0$$

where  
 P = Probability density of amplitude  
 Max = Maximum of amplitude  
 Average = Average of amplitude

The analyzer processes input signals internally using the following procedure (see Figure 3-78):

1. Measure the amplitude of the input signal over time.
2. Determine the amplitude distribution.
3. Obtain CCDF using the above formula.

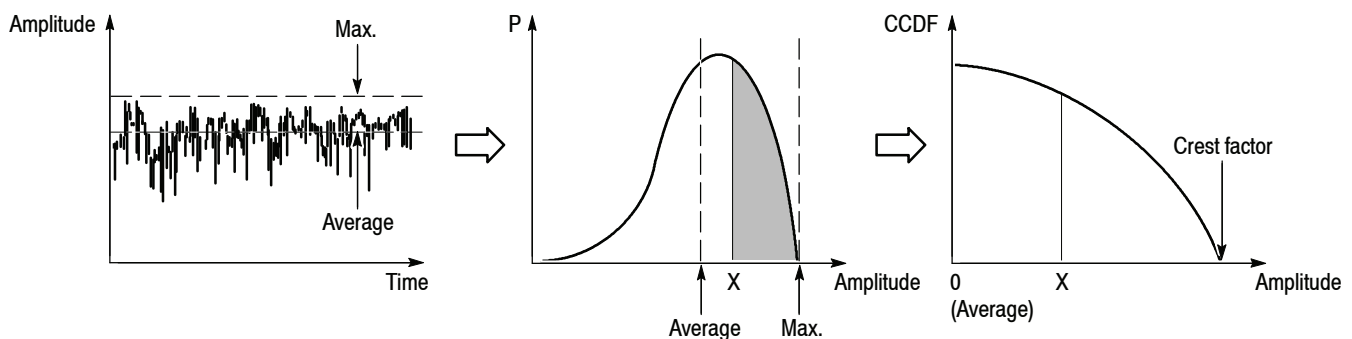


Figure 3-78: CCDF calculation process

**Basic Procedure**

Follow these steps to perform the CCDF measurement:

1. Press the **Time** key on the front panel.
2. Press the **CCDF** side key.
3. Display the measured waveform.

---

**NOTE.** Make sure to set the proper frequency and span. It is important to set the frequency and the span as close to the measured signal bandwidth as possible and adjust precisely. If not, modulated signals are not recognized correctly.

For details about setting frequency, span, and amplitude, refer to Setting Frequency and Span on page 3-135 and Setting Amplitude on page 3-143.

---

- a. Press the **Frequency/Channel** key on the front panel to set the frequency.
- b. Press the **Span** key on the front panel to set the span.
- c. Press the **Amplitude** key on the front panel to set the amplitude.
4. Set the analysis range by pressing the **Acquisition/Analysis** key on the front panel. Refer to page 3-34 for details about setting the analysis range.

---

**NOTE.** The CCDF measurement does not have Analysis Length and Analysis Offset controls in the Acquisition/Analysis menu.

---

5. Set the measurement parameters described just below by pressing the **Meas Setup** key on the front panel.

**Single Acquisition.** In single acquisition mode, you can set the total number of accumulated data points with **Trace/Avg > Maximum Points**, ranging from 2048 to  $10^{15}$ .

### **Meas Setup Menu**

The Meas Setup menu for the CCDF measurement contains the following controls:

**Display Gaussian Line.** Determines whether to display Gaussian line on screen.

**Display Reference Line.** Determines whether to display the most recently stored reference line on screen.

**Store Reference Line.** Stores the current CCDF curve as a new reference line. Automatically enables the reference line display.

**Reset Measurement.** Performs the CCDF calculation again from the beginning. The calculation is performed accumulatively until this side key is pressed.

**CCDF Auto-Scaling.** Selects whether to fix the scale of the horizontal axis (amplitude) of CCDF graph display.

- **Off. Default.** The scale of the horizontal axis is set to a fixed value using CCDF Scale.
- **On.** Displays the graph with the signal peak value as the maximum value (right edge) of the horizontal axis.

**CCDF Scale.** Sets the full-scale of the horizontal axis of CCDF graph display when CCDF Auto Scaling is Off. Range: 1 to 100 dB.

**Threshold.** Sets the threshold which defines the samples to be included in the CCDF calculation. Range: -250 to 130 dBm.



Measurement Display

Figure 3-79 shows an example of the CCDF measurement.

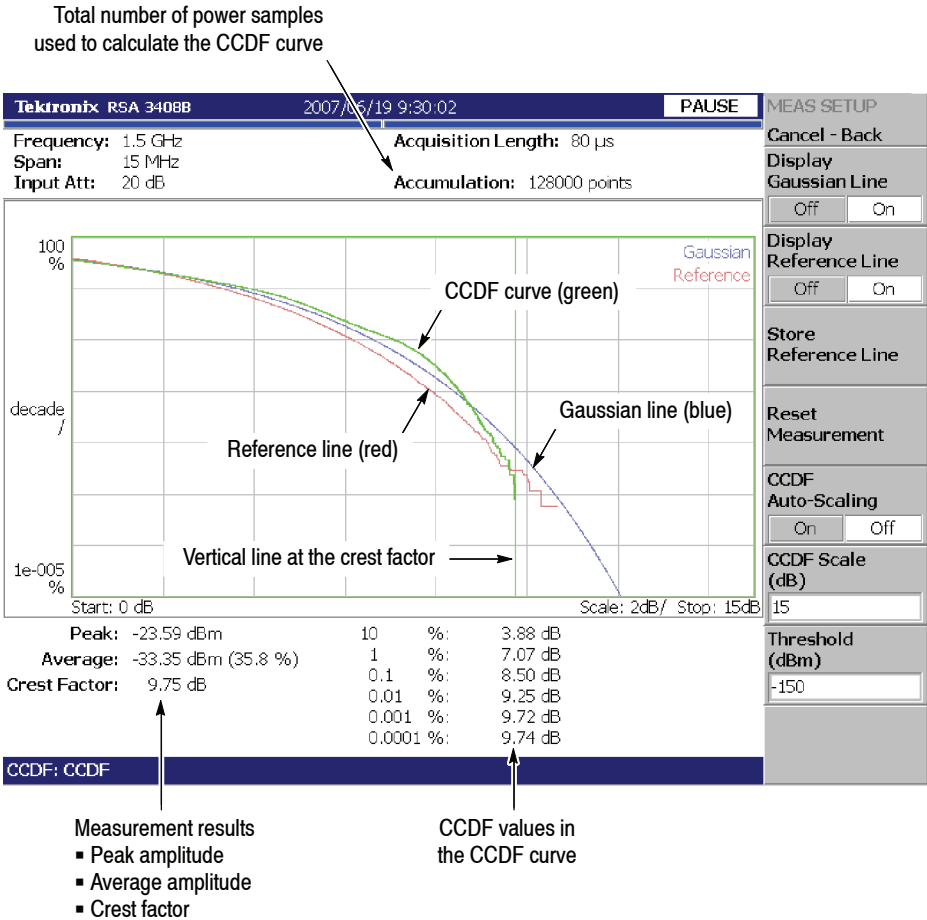


Figure 3-79: CCDF single view

**Changing the View**

You can change the contents of the views by pressing the View: **Define** key with the following controls:

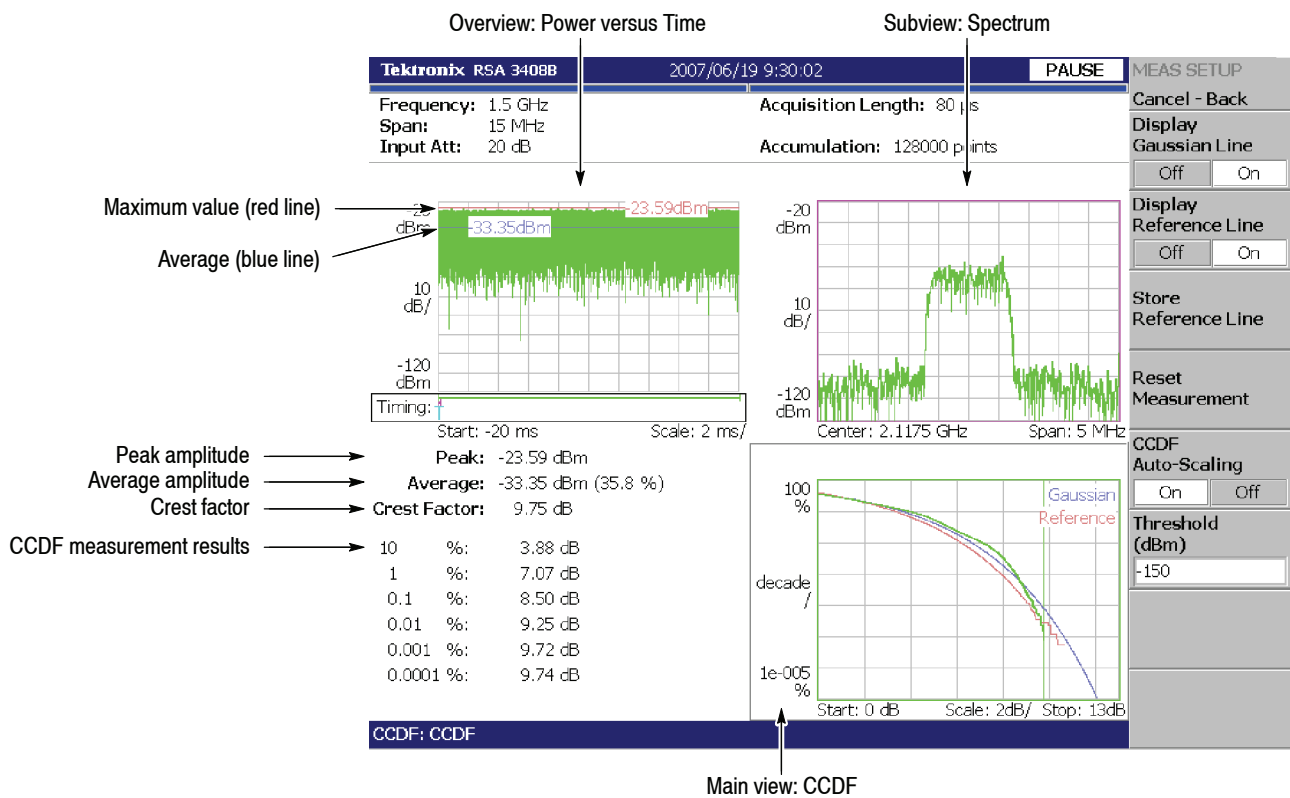
**Show Views.** Selects the view style:

- **Single.** Displays only the view selected by the View: **Select** key.
- **Multi.** Displays the overview, the subview, and the main view.

**Overview Content...** Selects the content of the overview:

- Spectrogram
- Waveform (power versus time)

Refer to page 3-203 for information about setting the view scale and format. Figure 3-80 shows an example of the CCDF multi-view.



**Figure 3-80: CCDF multi-view**

## Pulse Measurements

This section describes how to perform the pulse measurements. Select **Time > Pulse Measurements > Pulse Characteristics** to measure various pulse characteristics.

### Measurement Items

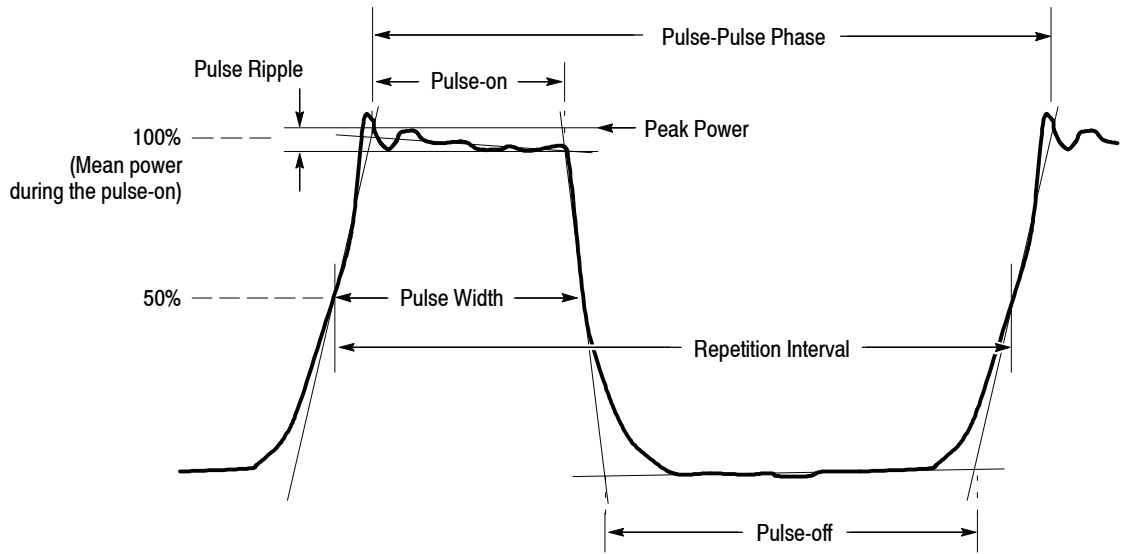
The following lists shows the measurement items (Measure menu) for pulse characteristics and their definitions (see Figure 3-81).

- **Pulse Width.** Measures the time from rising edge to falling edge at the level of -3 dB (50%) of the mean power for the pulse-on.
- **Peak Power.** Measures the maximum power during the pulse-on.
- **On/Off Ratio.** Measures the ratio of the mean power during the pulse-on to that during the pulse-off time.
- **Pulse Ripple.** Measures the difference between the maximum and the minimum power during the pulse-on.
- **Repetition Interval.** Measures the time from a pulse rising edge to the next pulse rising edge.
- **Duty Cycle.** Measures the ratio of the pulse width to the repetition interval.
- **Pulse-Pulse Phase.** Measures the phase difference between the first pulse and the selected pulse in the analysis window.
- **Channel Power.** Measures the channel power for the pulse-on spectrum.
- **OBW.** Measures the OBW (Occupied Bandwidth) for the pulse-on spectrum.
- **EBW.** Measures the EBW (Emission Bandwidth) for the pulse-on spectrum.
- **Frequency Deviation.** Measures the signal frequency change from the center frequency over time during the pulse-on.

For information about Channel Power, OBW and EBW measurements, refer to the S/A (Spectrum Analysis) mode.

Channel Power	page 3-5
OBW	page 3-8
EBW	page 3-10

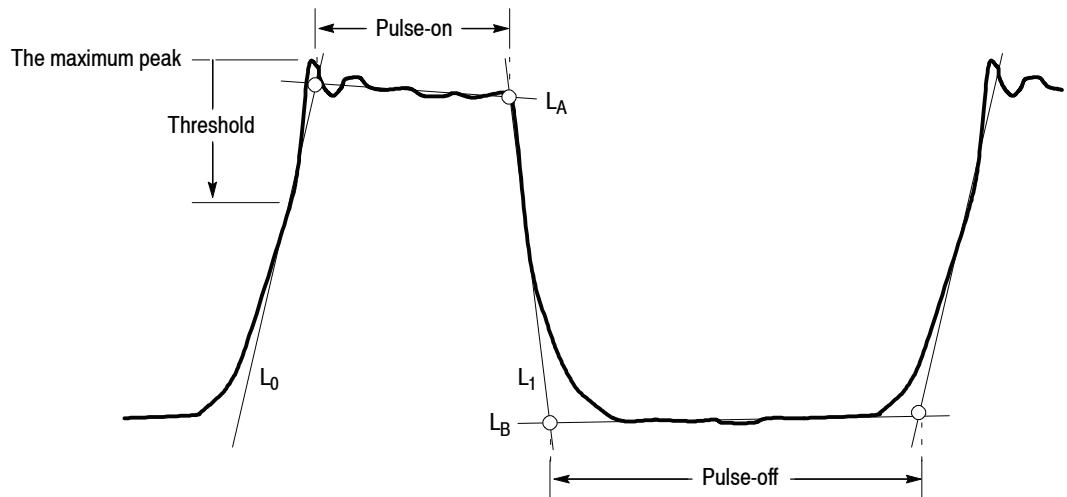
The frequency deviation measurement is based on the Frequency versus Time measurement in the Transient mode. Refer to page 3-103.



**Figure 3-81: Definition of pulse characteristics**

**Definition of Pulse-On/Off Time**

The pulse-on and -off times are fundamental parameters for pulse measurements. These parameters are defined in Figure 3-82. The threshold is a level to detect a pulse, relative to the maximum peak in the acquired data. You can set it by using Detection Threshold in the Meas Setup menu (refer to page 3-116).



**Figure 3-82: Definition of pulse-on/off**

The  $L_0$ ,  $L_1$ ,  $L_A$ , and  $L_B$  lines represent the following:

- $L_0$ : Tangent line through the threshold point on the rising edge
- $L_1$ : Tangent line through the threshold point on the falling edge
- $L_A$ : Regression line calculated on the pulse top
- $L_B$ : Regression line calculated on the pulse bottom

These lines are displayed in red in the subview. The pulse-on and -off times are determined by the nodes of these lines as shown in Figure 3-82.

### Basic Measurement Procedure

Use this procedure to perform the pulse measurements:

1. Press the **Time** key on the front panel.
2. Press the side key **Pulse Measurement > Pulse Characteristics**.
3. Display the measurement waveform:
  - a. Press the **Frequency/Channel** key on the front panel to set the frequency.
  - b. Press the **Span** key on the front panel to set the span.
  - c. Press the **Amplitude** key on the front panel to set the amplitude.

For information about setting frequency, span, and amplitude, refer to *Setting Frequency and Span* on page 3-135 and *Setting Amplitude* on page 3-143.

4. *For the channel power, OBW, and EBW measurements only:*  
You can select an FFT window for the measurement.  
Refer to *RBW/FFT Menu* on page 3-113.
5. Press the **Acquisition/Analysis** key on the front panel to set the analysis range. Refer to page 3-34 for details on setting analysis range.
6. Press the View: **Define** key on the front panel to select the measurement item(s) for display. Refer to page 3-113 for the View Define menu.

By default, only the pulse-width measurement result is displayed on screen.

7. Press the **Meas Setup** key on the front panel to set the measurement parameters. Refer to page 3-116 for the Meas Setup menu.

8. After you capture a measurement waveform, stop the data acquisition. If you are acquiring data in the continuous mode, press the **Run/Stop** key.
9. Press the **Meas Setup** key and then **Analyze** side key to start the analysis of the acquired data.
10. Press the View: **Define** key to select a pulse to observe from the measurement results.

#### **Hints for Taking Measurements.**

- It takes longer to detect pulses when the analysis length in the Acquisition/Analysis menu is set to a larger value.
- The results are not displayed in the Channel Power, OBW, or EBW measurement.

The number of data samples in Pulse-On must be 20 to 16,384 for FFT calculation. Change the span to display the results.

- The results are not displayed in the Pulse Repetition Interval or the Duty Cycle measurement.

The observed pulse and the next one must be contiguous. If either pulse is not recognized due to noise and so on, the measurement results are not shown.

#### *Error messages (displayed on the bottom of the screen)*

- Message: Filter bandwidth is too wide or Channel bandwidth is too wide. Indicates that you set Filter Bandwidth or Channel Bandwidth inappropriately in the Meas Setup menu (refer to page 3-116).

In this case, change the setting of Filter Bandwidth or Channel Bandwidth until the message disappears.

- Message: Too long pulse. Indicates that the number of data samples of a pulse width exceeds about 260,000.

In this case, change the span.

- Message: Too long repetition interval. Indicates that the number of data samples of a pulse repetition interval exceeds about 260,000.

In this case, change the span.

**RBW/FFT Menu**

The RBW/FFT menu for the pulse measurements contains the following controls:

**FFT Window...** Selects an FFT window for the channel power, OBW, and EBW measurements from these two:

- Nyquist (default)
- Blackman-Harris 4B

**Rolloff Ratio...** Sets the roll-off ratio for the Nyquist window.  
Range: 0.0001 to 1 (default: 0.2)

For details on FFT and RBW, refer to page 3-179.

**View Define Menu**

The View Define menu for the pulse measurements contains the following controls:

**Show Views.** Selects a single view or multi-view display.

- **Single.** Displays only the view selected by the View: **Select** key on the front panel.
- **Multi. Default.** Displays the overview, subview, and main view.

**Overview Content...** Selects a view displayed in the overview.

- Waveform (Power versus Time)
- Spectrogram

Refer to page 3-203 for information about setting views.

**Select Measurement...** Selects a measurement item to display in the subview from the items selected in Displayed Measurement.

**Select Pulse.** Selects a pulse to measure when you select A Single Pulse in View Results For... described below. 0 (zero) represents the most current pulse while larger negative numbers represent subsequent pulses.

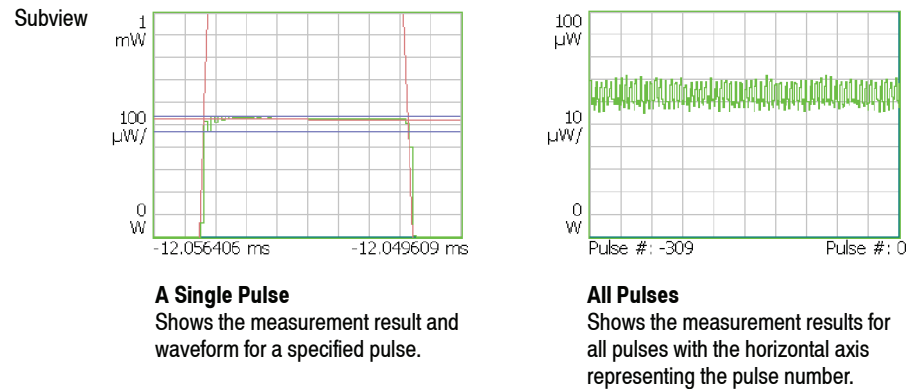
---

**NOTE.** *The main view shows the measurement results for up to 1000 pulses (the pulse number of -999 to 0).*

---

**View Results For...** Selects how to display the measurement results in the subview (see Figure 3-83).

- **A Single Pulse.** Displays the measurement results for one pulse specified with Select Pulse.
- **All Pulses.** Displays the measurement results for all pulses in the analysis range. The horizontal axis represents the pulse number and the vertical axis represents the measurement results.



**Figure 3-83: Setting for View Results For...**

**Displayed Measurement...** Determines whether to show the measurement result in the main view for each measurement item. Select On to show the result. For the measurement items, refer to page 3-109.

---

**NOTE.** You must select at least one measurement item in Displayed Measurement. If you turn all items off, an error message “One or more measurement items must be selected” will appear on the bottom of the screen.

---

**Display Time Range...** Selects how to display a pulse in the subview.

- **Adaptive. Default.** Adjusts the horizontal scale for each pulse to fit the pulse width to the subview.
- **Max.** Adjusts the horizontal scale to fit the maximum pulse width in the analysis range to the subview.



**Guidelines...** Determines whether to display the guidelines in the subview.

- **On. Default.** Displays the guidelines in the subview.
- **Off.** Hides the guidelines in the subview.

For the guidelines, refer to *Definition of Pulse-On/Off Time* on page 3-110.

**Menu Off.** Turns off the side menu to expand the measurement results and waveform view area on screen. To recall the side menu, press the key on the front panel.

When View Results For... is A Single Pulse:

- Select a pulse with **Select Pulse**
- Select a measurement item with **Select Measurement**

Indicates the position of the pulse selected with **Select Pulse**

The measurement result highlighted in the main view is displayed in the subview with the waveform

Pulse #	PW (s)	Peak (W)	On/Off (dB)	Off (s)	PR1 (s)	Duty (%)
-100	4.688μ	550.862μ	42.85	62.488μ	16.016μ	28.78
-99	4.688μ	543.778μ	42.28	56.938μ	16.016μ	28.78
-98	4.688μ	539.938μ	44.12	66.504μ	16.016μ	28.78
-97	4.688μ	544.175μ	51.55	70.392μ	16.016μ	28.78
-96	4.609μ	547.838μ	46.69	60.182μ	15.938μ	28.431
-95	4.688μ	548.438μ	42.84	59.344μ	16.016μ	28.78
-94	4.688μ	543.539μ	42.22	56.879μ	16.016μ	28.78
-93	4.688μ	541.538μ	44.23	67.598μ	16.016μ	28.78

Pulse index

Select the displayed items with **Displayed Measurement...**

**Figure 3-84: Setting the View Define menu**

You can save the measurement table to a file (\*.csv) by **Save > Save Table**. For file operations, refer to page 3-251.

## Meas Setup Menu

The Meas Setup menu for the pulse measurements contains the following controls:

**Analyze.** Starts analysis on acquired data in the analysis range.

**Detection Threshold.** Sets the threshold level to detect pulses in acquired data. This level is shown with a green arrow in the subview (see Figure 3-85).  
Range: -100 to 0 dBc (default: -3 dBc)

**Channel Bandwidth.** *For the Channel Power measurement only.*  
Sets the measurement frequency range. Range: (Bin bandwidth)  $\times$  8 to set span. Refer to *Trace Compression* on page 3-200 for the bin bandwidth.

**OBW Power Ratio.** *For the OBW measurement only.*  
Specifies the power ratio of the carrier and span regions for calculating OBW.  
Range: 80 to 99.9% (default: 99% as defined in T-53 or IS-95 standard).

**EBW Meas. Level.** *For the EBW measurement only.*  
Specifies how far down from the peak level the bandwidth is measured.  
Range: -100 to -1 dB (default: -30 dB)

**Counter Resolution.** *For the Frequency Deviation measurement only.*  
Sets the frequency counter resolution. It is the same as in the Carrier Frequency measurement in the S/A mode (refer to page 3-10).  
Range: 1 mHz to 1 MHz in a tenfold sequence (default: 1 Hz)

**P-P Phase Time Offset.** *For the Pulse-Pulse Phase measurement only.*  
Sets the time offset for the measurement point.  
The default value is 0 (zero) second; the measurement point is at the beginning of the pulse-on time.

**Measurement Filter.** Selects the measurement filter applied to time domain I/Q data for each pulse.

- None (no filter)
- Gaussian

**Filter Bandwidth.** Sets the bandwidth for the Gaussian measurement filter.  
Range: Span/10 to full span (default: 3.6 MHz)

**Filter Parameter.** Sets the  $\alpha$ /BT value for the Gaussian measurement filter.  
Range: 0.0001 to 1.0 (default: 0.35)

**Frequency Recovery.** *For the Pulse-Pulse Phase and the Frequency Deviation measurements only.* Selects the frequency correction method.

- **1st.** Sets the correction value automatically, using the first pulse in the analysis range. The value is displayed in the **Frequency Offset** side key.
- **User.** Sets the correction value using the **Frequency Offset** side key described below.
- **Off. Default.** Disables the frequency correction.

**Frequency Offset.** Sets the frequency correction value when you select User in Frequency Recovery described above.

### Measurement Screen

The measurement waveform is displayed in the subview with the yellow lines (bold lines in Figure 3-85 on page 3-118) indicating the measurement points. Also, the pulse detection threshold (**Meas Setup > Detection Threshold**) is shown with the green arrow. These guidelines can be turned on or off by View: **Define > Guidelines**.

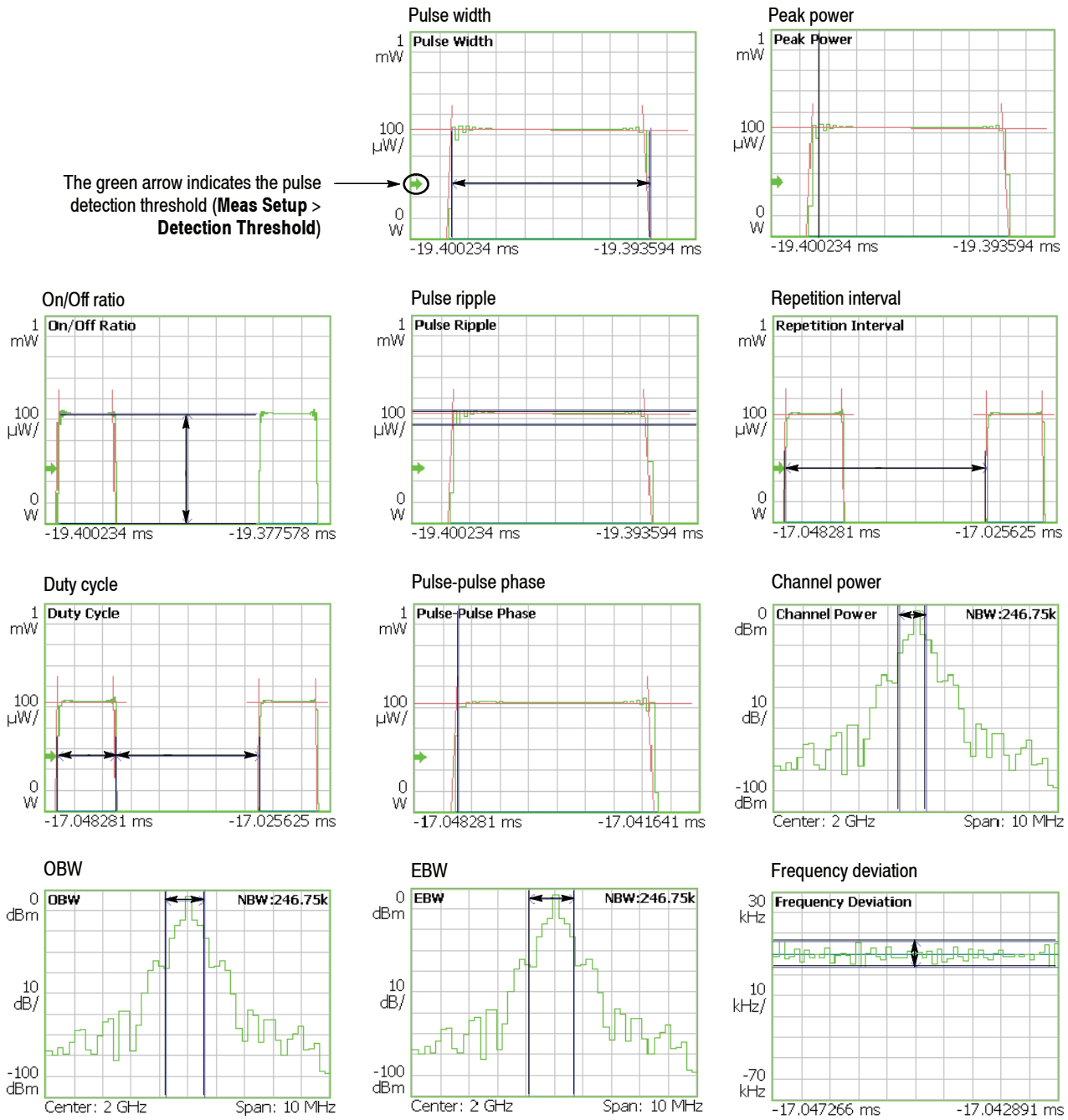


Figure 3- 85: Waveform display in the subview

## Signal Source Analysis (Option 21 Only)

The signal source analysis function allows you to measure phase noise, jitter, and settling time in a signal source such as a PLL (Phase-Locked Loop) system.

**Measurement Items** The following items are measured in the signal source analysis. (Select the items using the **Measure** key.)

**Table 3-21: Signal source measurement items**

Measure menu	Measurement items
Phase Noise	■ Carrier frequency ■ Channel power
Real-Time Phase Noise	■ Phase noise ■ Random jitter ■ Periodic jitter
Spurious	Spurious
Real-Time Spurious	
Frequency versus Time	Frequency settling time

For the “Real-Time” concept, refer to:  
Real-Time Analysis page 1-3  
Features of the Real-Time Mode page 3-23

### Basic Procedure

Use the following procedure to perform the signal source analysis.

---

**NOTE.** *If you use a signal input (Input > Signal Input Port...) other than RF, the measurements are not guaranteed.*

---

1. Press the **Time** key on the front panel.
2. Select **Signal Source Analysis** using the side keys.
3. Select a measurement item by pressing the side key.  
For example, press the **Phase Noise** side key to perform the phase noise measurement.
4. Adjust the amplitude and frequency to display the measurement waveform.  
  
Refer to page 3-135 for setting frequency and span.  
Refer to page 3-143 for setting amplitude.
5. Set the analysis range in the overview.  
(This is not necessary in the Phase Noise and the Spurious measurements.)  
  
Refer to page 3-34 for details of the analysis range settings.  
  
If you use the zoom function, do these steps:
  - Press the View: **Define** key.
  - Press the **Overview Content...** side key and select **Zoom**.Refer to *Zoom Function* on page 3-27 for setting the analysis area on the spectrogram with the zoom function.
6. Press the **Meas Setup** key and set the measurement parameters.  
  
Refer to *Meas Setup Menu* in each measurement description.
7. Press the **Analyze** side key and carry out the analysis.  
(This is for the Real-Time Phase Noise and Real-Time Spurious measurements only.)

**Selecting the Phase Unit.** The phase unit is set to degrees by default. It is possible to select degrees or radians as the unit using the following procedure:

1. Press the **System** key on the front panel.
2. Press the **Instrument Setup...** side key.
3. Press the **Angular Units** side key to select degrees or radians.

**Phase Noise Measurement**

C/N (Carrier to Noise ratio) is measured at the offset frequency from the carrier. Jitter is also calculated from the phase noise data.

**Meas Setup Menu.** The following items are provided in the Meas Setup menu for Phase Noise measurement (see Figure 3-86).

**Carrier Threshold Level.** Sets the threshold for carrier detection. A signal with amplitude above the threshold is detected as a carrier.

Setting range: -100 to +30 dBm (default: -20 dBm)

**Carrier Bandwidth.** Sets the carrier bandwidth.

Setting range: Span/100 to Span/2 (default: Span/100)

**C/N Sideband.** Selects the sideband for measuring phase noise.

- **Upper.** *Default.* Measures the upper sideband.
- **Lower.** Measures the lower sideband.

**Minimum Offset Frequency...** Sets the minimum frequency in the phase noise measurement range as the offset from carrier frequency.

Setting value:

10 Hz (default), 100 Hz, 1 kHz, 10 kHz, 100 kHz, 1 MHz, or 10 MHz.

**Maximum Offset Frequency...** Sets the minimum frequency in the phase noise measurement range as the offset from carrier frequency.

Setting value:

100 Hz, 1 kHz, 10 kHz, 100 kHz, 1 MHz, 10 MHz, or 100 MHz (default)

**Rj Start Offset Frequency.** Sets the random jitter measurement start frequency as the offset from carrier frequency.

Setting range: 10 Hz to Rj Stop Offset Frequency set value (default: 10 Hz)

**Rj Stop Offset Frequency.** Sets the random jitter measurement stop frequency as the offset from carrier frequency.

Setting range: Rj Start Offset Frequency set value to 100 MHz  
(default: 100 MHz)

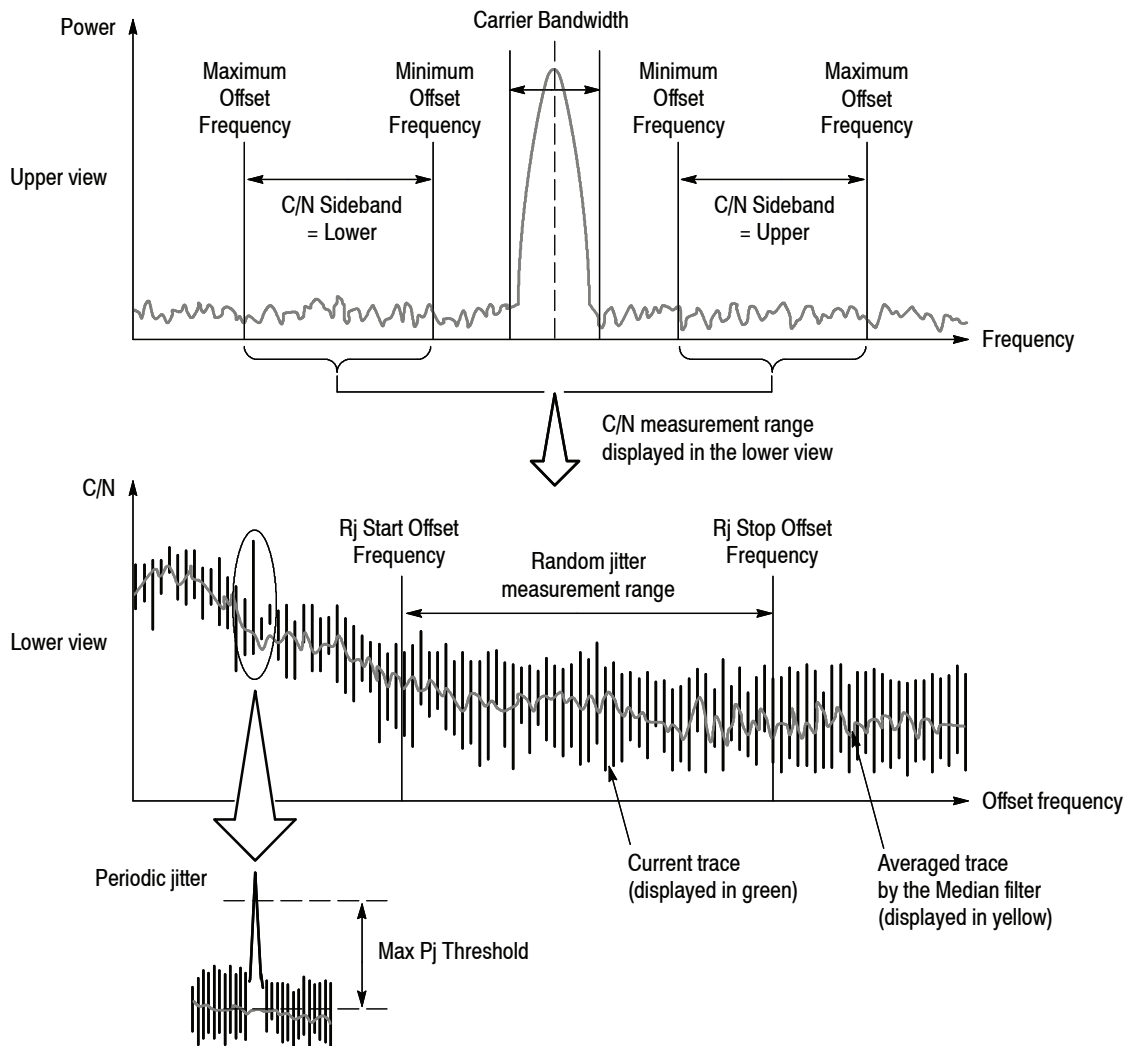
---

**NOTE.** *The integrated phase noise and random jitter will be calculated if the frequency range from Rj Start Offset Frequency to Rj Stop Offset Frequency is within the range from Minimum Offset Frequency to Maximum Offset Frequency.*

---

**Max Pj Threshold.** Sets the threshold level to determine periodic jitter by using the C/N value averaged by the Median filter (the yellow trace in the lower view) as the reference. A signal whose C/N value [dBc/Hz] is larger than the threshold is regarded as a periodic jitter. The maximum periodic jitter in the analysis range is shown in the measurement results (see Figure 3-87).

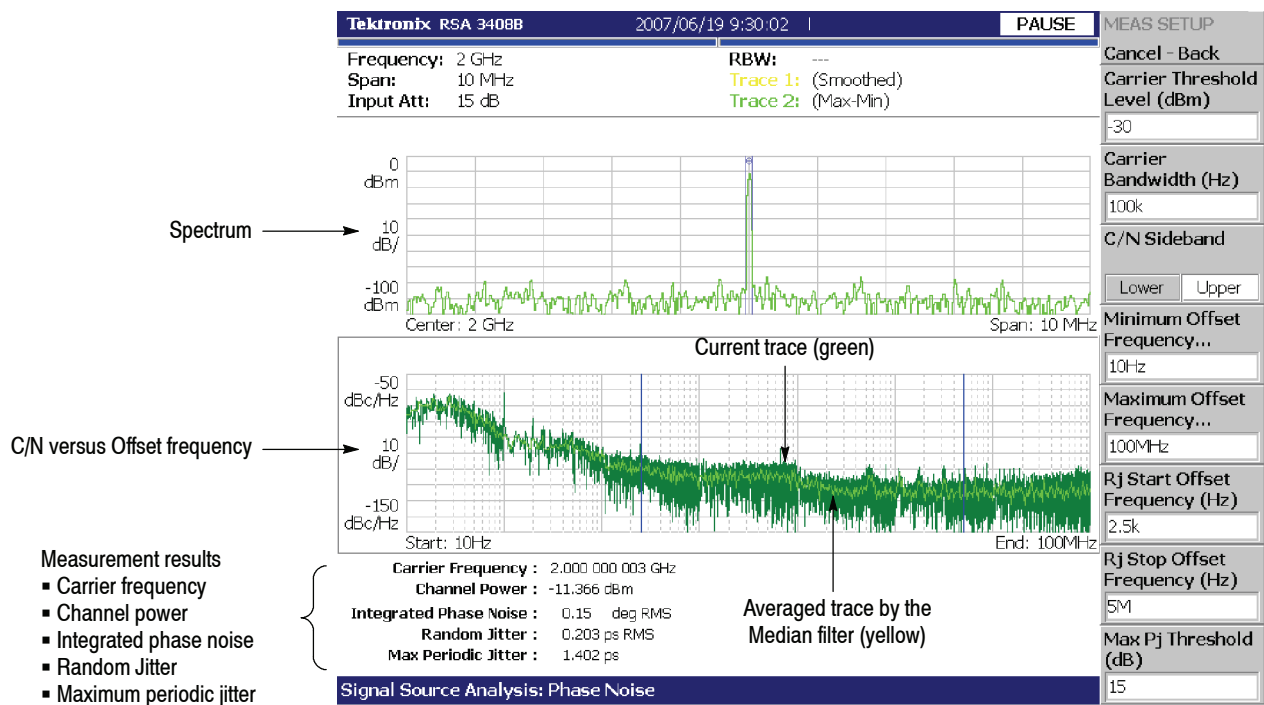
Setting range: 1 to 50 dB (default: 10 dB)



**Figure 3-86: Phase noise measurement parameters**



Figure 3-87 shows an example of the phase noise measurement. The *Integrated Phase Noise* in the measurement results indicates a phase noise value obtained by integrating C/N in the random jitter measurement range illustrated in Figure 3-86. The *Random Jitter* in the measurement results indicates a jitter value equivalent to the integrated phase noise.



**Figure 3-87: Phase noise measurement**

**Selecting Trace 2.** In the C/N versus Offset frequency graph, Trace 1 (yellow) represents a trace averaged by the Median filter and Trace 2 (green) represents a Max-Min waveform by default. You can change Trace 2 using the Trace/Avg menu.

To change Trace 2, press the **Trace/Avg** key and set the following items:

**Trace 2...** Selects Trace 2.

- **Max-Min.** *Default.* Shows the maximum and minimum C/N values at alternate frequency points; its advantage is its resemblance to an analog display.
- **Reference.** When loaded as Trace 2, displays the waveform as the reference, which has been saved using **Save Trace 1**.
- **Off.** Displays no waveform.

**Load Trace 2.** Loads the waveform that was saved using **Save Trace 1** for Trace 2 as the reference.

**Save Trace 1.** Saves Trace 1 waveform data as a reference waveform.

Refer to page 3-251 for file operations.

#### Hints for Taking Measurements.

- Widening the span expands carrier detection range, but loses accuracy. Narrowing the span increases measurement time.
- The phase noise measurement is performed within one of the four frequency bands listed in Table 3-22. A measurement outside the band is not performed.

**Table 3-22: Phase noise measurement frequency band**

Measurement band	Frequency range	Note
Baseband	0 Hz to 40 MHz	Set a value of $[(\text{center frequency}) \pm (\text{span}/2)]$ within the frequency range.
RF1	40 MHz to 3.5 GHz	Set a center frequency within the frequency range.
RF2	3.5 GHz to 6.5 GHz	
RF3	5 GHz to 8 GHz	

- Tables 3-23 and 3-24 show the bin width and the number of waveform points for C/N versus Offset frequency measurement.

**Table 3-23: Bin width for each decade**

Decade	Bin width
10 Hz to 100 Hz	0.195 Hz
100 Hz to 1 kHz	1.953 Hz
1 kHz to 10 kHz	1.953 Hz
10 kHz to 100 kHz	15.625 Hz
100 kHz to 1 MHz	156.25 Hz
1 MHz to 10 MHz	1.5625 kHz
10 MHz to 100 MHz	12.5 kHz

**Table 3-24: The number of waveform points**

Waveform	The number of points	Point placement
Averaged waveform	100 per decade	Linear on the logarithmic frequency axis.
Max-Min waveform	460 per decade	Linear on the linear frequency axis.

*Error messages*

- **Message: No Carrier.**

In this case, lower Carrier Threshold Level in the Meas Setup menu.

- **Message: Out of Span.**

In this case, decrease Carrier Bandwidth in the Meas Setup menu, or match the carrier frequency with the center frequency.

**Spurious Measurement**

Spurious measurements are made in the same way as in the S/A mode (refer to pages 3–12). However, for the spurious measurements in the signal source analysis, there is a filter function to extract symmetrical spurious signals only.

**Meas Setup Menu.** The next items are identical to those in the spurious measurement in the S/A mode. Refer to pages 3–12.

**Carrier Threshold Level** (“Signal Threshold” in the S/A mode)

**Ignore Region**

**Spurious Threshold**

**Excursion**

**Scroll Table**

The following items are added for the signal source analysis.

**Symmetrical Filter.** Selects and deselects the filter for extracting symmetrical spurious signals only.

- **On. Default.** Displays symmetrical spurious signals only.
- **Off.** Displays all spurious signals.

**Carrier Tracking.** Selects whether carrier tracking is executed or not. Carrier tracking ensures that the carrier frequency is always positioned centrally, even when the signal drifts (it does not affect the waveform display).

- **On. Default.** Carrier tracking is executed. The measurement is conducted with the carrier frequency always positioned centrally.
- **Off.** Carrier tracking is not executed. The measurement is conducted with the central frequency that was set using **Frequency/Channel > Center Freq.**

Figure 3-88 shows an example of the spurious measurement. Detected spurious signals are numbered sequentially from No. 1 in descending order of amplitude and spurious markers are displayed on the waveform. A maximum of 20 spurious signals are displayed. In addition, frequency difference (deltaF) and amplitude ratio (Ratio) in relation to the carrier are displayed in the measurement table at the bottom of the screen. You can save the table to a file (\*.csv) by **Save > Save Table**. For file operations, refer to page 3-251.

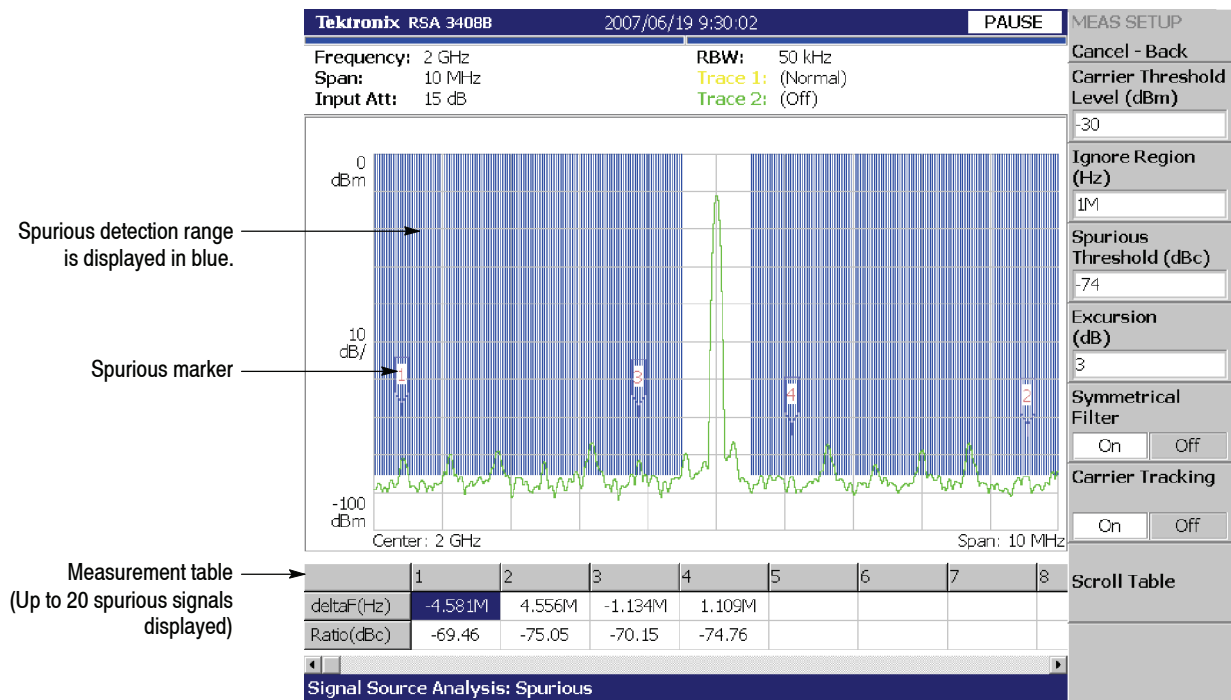


Figure 3-88: Spurious measurement

## Real-Time Phase Noise Measurement

Measures the phase noise in real time. The measurement results can be displayed in three dimensions like a spectrogram, called “Noisogram”: the color axis shows the C/N (dBc/Hz), the horizontal axis shows the offset frequency (Hz) and the vertical axis shows the time (frame number). Jitter equivalent to the RMS value of the phase noise and the settling time of the phase noise and jitter are also calculated from the phase noise data.

**Meas Setup Menu.** The following items are provided in the Meas Setup menu for the Real-Time Phase Noise measurement.

**Analyze.** Performs measurement for acquisition data in the analysis range.

---

**NOTE.** When you change settings in the Meas Setup menu, press the **Analyze** side key to perform the measurement for the modified settings.

---

The next items are the same as for the phase noise measurement. Refer to page 3-121.

**Carrier Threshold Level**  
**Carrier Bandwidth**  
**C/N Sideband**  
**Rj Start Offset Frequency**  
**Rj Stop Offset Frequency**  
**Max Pj Threshold**

The following items are added for the real-time measurement (see Figure 3-89). They depend on the subview content (refer to *Selecting the Subview Content* on page 3-129).

**Rj Settling Threshold.** Enabled when Random jitter versus Time is displayed in the subview. Sets the threshold value for obtaining the random jitter settling time.

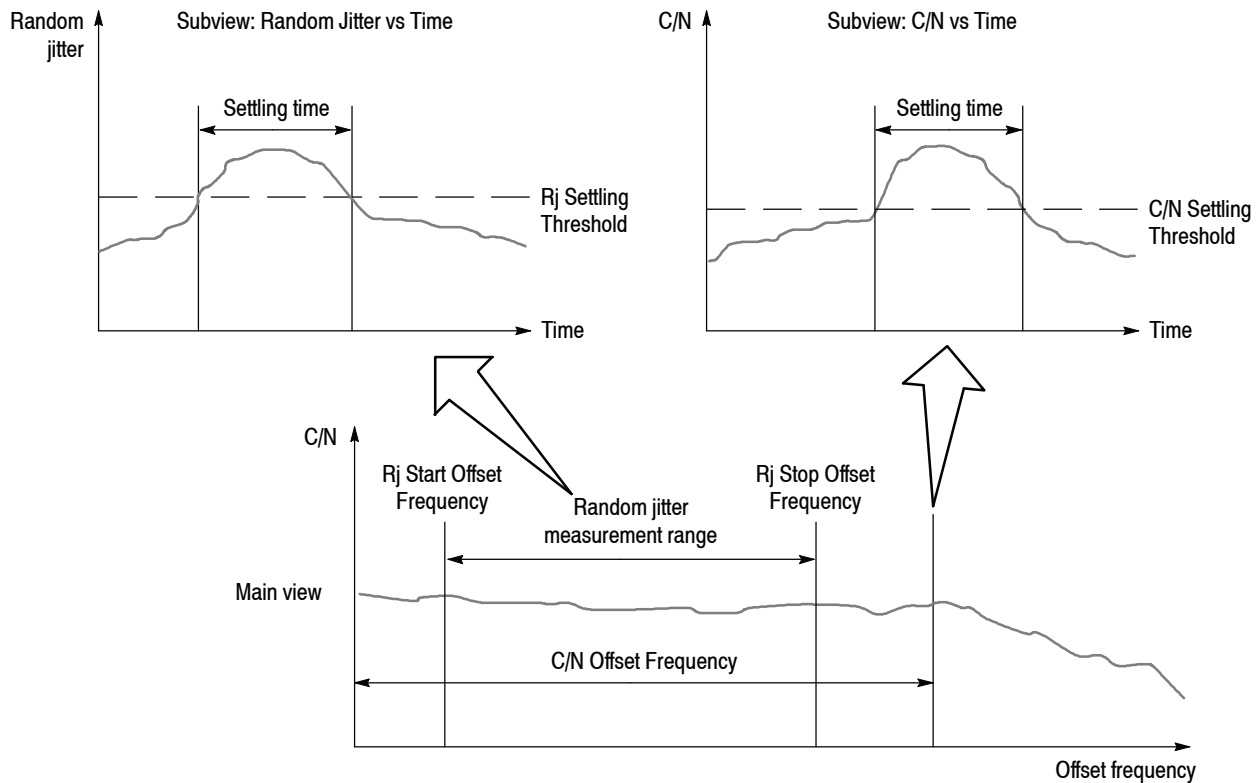
Setting range: 0 to 1 s (default: 0 s).

**C/N Offset Frequency.** Enabled when C/N versus Time is displayed in the subview. Sets the value of the frequency displaying the C/N versus Time in the subview as the offset from carrier frequency.

Setting range: The upper limit is Span/2. The lower limit is determined by the span and FFT Points for C/N (refer to *Setting the Number of FFT Points* on page 3-128) settings.

**C/N Settling Threshold.** Enabled when C/N versus Time is displayed in the subview. Sets the threshold value for obtaining the phase noise settling time.

Setting range: -200 to 0 dBc/Hz (default: 0 dBc/Hz).



**Figure 3-89: Real-time phase noise measurement parameters**

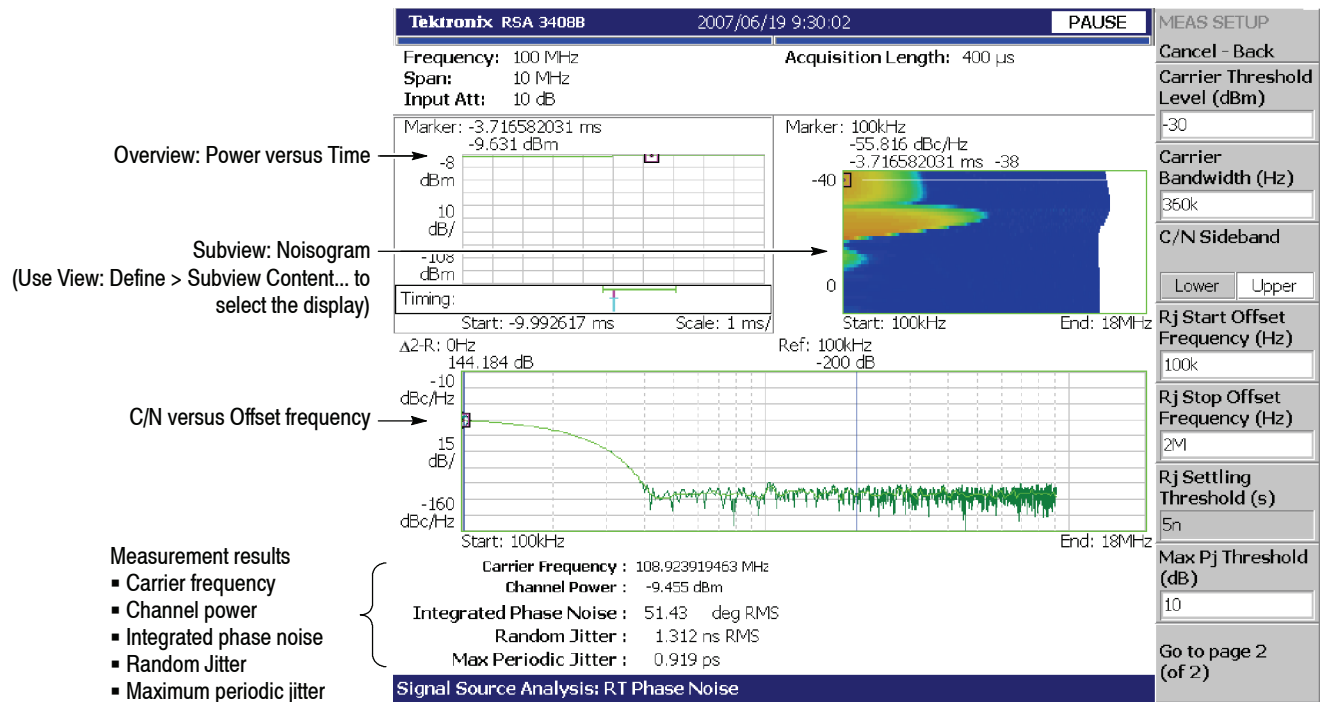
**Setting the Number of FFT Points.** The real-time phase noise measurement uses 1024 FFT sample points by default for the upper and lower side bands to obtain a C/N versus offset frequency graph. You can change the number of FFT sample points in **RBW/FFT > FFT Points for C/N**.

**FFT Points for C/N.** Sets the number of FFT sample points for the C/N versus offset frequency measurement.

Setting range: 64 to 65536 ( $2^n$ , default: 1024).

The more points, the higher the resolution. The fewer points, the faster the measurement.

Figure 3-90 shows an example of the real-time phase noise measurement. The subview displays the noisogram (Color axis: C/N in dBc/Hz, Horizontal axis: Frequency in Hz, Vertical axis: Time in frame number) selected in **View: Define > Subview Content...** The main view is the same as in the phase noise measurement (see Figure 3-87 on page 3-123), except that this main view is real time.

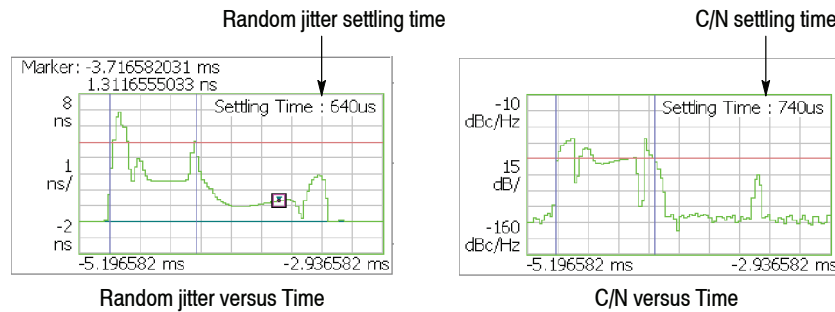


**Figure 3-90: Real-time phase noise measurement**

**Selecting the Subview Content.** The real-time phase noise measurement subview has displays that are specific to the signal source analysis. The subview is selected by pressing View: **Define > Subview Content...**

**Subview Content...** Selects the information that is displayed in the subview. Refer to *Setting Views* on page 3-203 for scaling a view.

- Spectrum
- Noisogram  
Color axis: C/N, Horizontal axis: Frequency, Vertical axis: Time (Frame No.)  
It is like a spectrogram but the color axis represents C/N in dBc/Hz.
- Random Jitter vs Time  
See Figure 3-91. The random jitter settling time is also indicated.
- Integrated Phase Noise vs Time
- C/N vs Time  
See Figure 3-91. The C/N settling time is also indicated.



**Figure 3-91: Settling time displayed in the subview**

**Hints for Taking Measurements.**

If the subview displays nothing, check the following:

- Subview: Random Jitter vs Time or Integrated Phase Noise vs Time  
 Make sure that the jitter measurement range set by Rj Start/Stop Offset Frequency in the Meas Setup menu is within the display range of the C/N versus Offset frequency in the main view.
- Subview: C/N vs Time  
 Make sure that C/N Offset Frequency in the Meas Setup menu is within the display range of the C/N versus Offset frequency in the main view.

*Error messages*

- Message: No Carrier.  
 In this case, lower Carrier Threshold Level in the Meas Setup menu.
- Message: Out of Span.  
 In this case, decrease Carrier Bandwidth in the Meas Setup menu, or match the carrier frequency with the center frequency.



## Real-Time Spurious Measurement

Spurious measurements are made in real time. The main view shows the spurious display the same as in the spurious measurement described on page 3-125, except that this spurious display is real time. You can observe the noisogram or C/N versus offset frequency in the subview.

---

**NOTE.** *In the real-time spurious measurement, the number of FFT points is fixed to 1024.*

---

**Meas Setup Menu.** The following items are provided in the Meas Setup menu for the Real-Time Spurious measurement.

**Analyze.** Performs measurement for acquisition data in the analysis range.

---

**NOTE.** *When you change settings in the Meas Setup menu, press the **Analyze** side key to perform the measurement for the modified settings.*

---

The following menu items are identical to those in the spurious measurement. Refer to page 3-125.

- Carrier Threshold Level**
- Ignore Region**
- Spurious Threshold**
- Excursion**
- Symmetrical Filter**
- Carrier Tracking**
- Scroll Table**

The following items are added for the real-time measurement. They depend on the subview content (refer to *Selecting the Subview Content* on page 3-132).

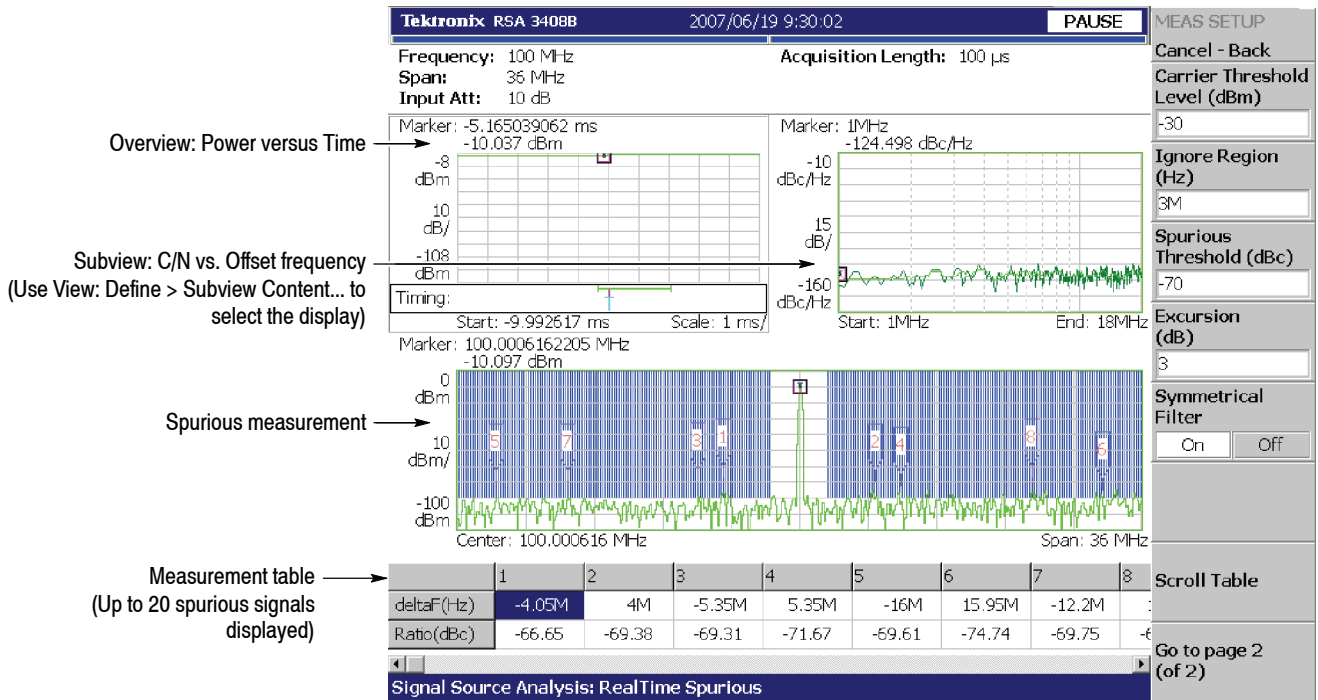
**Carrier Bandwidth.** This value is used to display C/N versus Offset frequency in the subview. Sets the frequency bandwidth for calculating channel power.

Setting range: Span/100 to Span/2 (default: Span/100).

**C/N Sideband.** This value is used to display C/N versus Offset frequency in the subview. Selects the sideband for measuring phase noise.

- **Upper.** *Default.* Measures upper sideband (half span).
- **Lower.** Measures lower sideband (half span).

Figure 3-92 shows an example of the real-time spurious measurement. The main view is the same as the spurious measurement (refer to page 3-125), except that this main view is real time.



**Figure 3-92: Real-time spurious measurement**

The main view displays the spurious measurement results when the carrier level exceeds Carrier Threshold Level in the Meas Setup menu. The subview displays the measurement results in C/N versus Offset frequency and Noisogram when the carrier channel power exceeds Carrier Threshold Level.

**Selecting the Subview Content.** The real-time spurious measurement subview includes displays specific to the signal source analysis. The subview is selected by pressing View: **Define > Subview Content...**

**Subview Content...** Selects the information displayed in the subview.

- Spectrum
- Noisogram  
Color axis: C/N, Horizontal axis: Frequency, Vertical axis: Time (Frame No.)  
This is like a spectrogram except that the color axis represents C/N in dBc/Hz.
- C/N vs Offset Freq  
This is the same as the main view in the real-time phase noise measurement (see Figure 3-90 on page 3-129).

## Frequency versus Time Measurement

Measures changes in frequency. A running average of the frequency versus time waveform is displayed in the main view and the frequency settling time is obtained. However, the measurement signal must meet the following conditions:

- The frequency shift does not exceed the threshold at the start and end of the analysis range.
- Frequency hopping occurs only once within the analysis range.

---

**NOTE.** The frequency versus time measurement requires at least 2048 samples. If the analysis length is set to less than 2048, an error message “Analysis Length is too short” is displayed. Also, 1024 samples stable in frequency are required at both the start and end of the analysis range to calculate the average frequency.

---

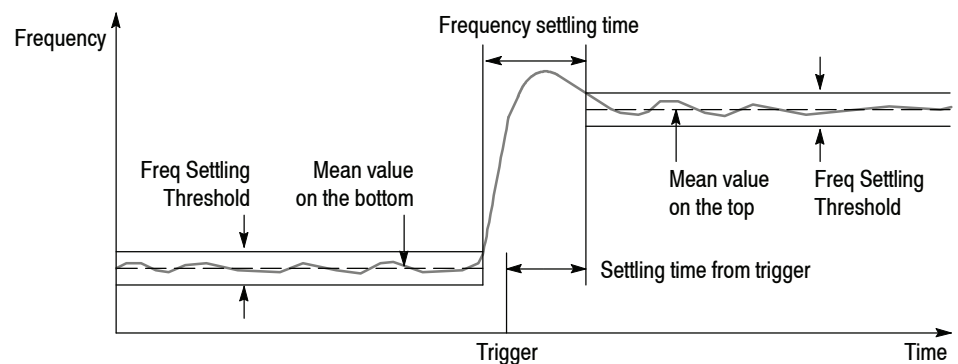
**Meas Setup Menu.** The following items are provided in the Meas Setup menu for the frequency versus time measurement.

**Freq Settling Threshold.** Sets the threshold for judging the frequency settling time (see Figure 3-93). When frequency deviation exceeds this value, hopping is considered to have occurred.

Setting range: 10 Hz to Span (default: 10 Hz).

**Smoothing Factor.** Sets the number of points from which the running average is calculated.

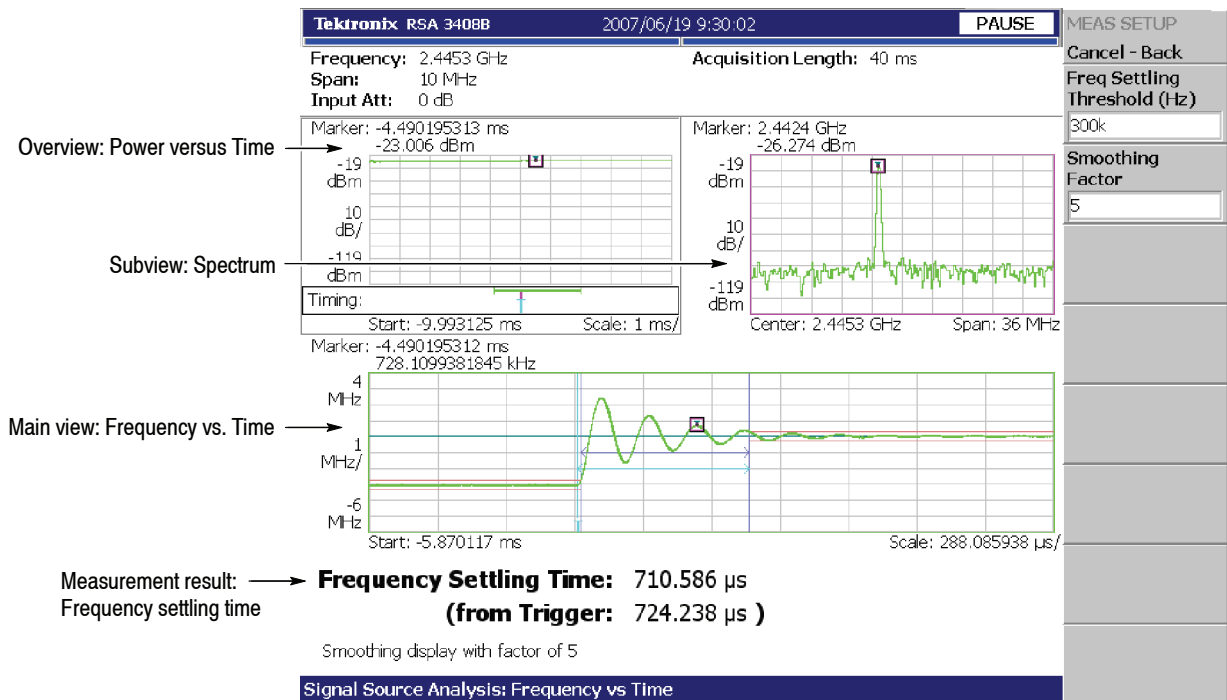
Setting range: 1 to (analysis range)/2 or 9999 points (default: 1).



**Figure 3-93: Frequency versus Time measurement parameters**

**NOTE.** In the frequency versus time measurement, the analysis range is approximately 500 frames (512,000 points) maximum. For example, it is about 40 ms for the span of 10 MHz.

Figure 3-94 shows an example of the frequency versus time measurement. The subview displays only spectrum. The frequency settling time is indicated on the bottom of the screen. The value from trigger is also indicated when the trigger occurs during or before the frequency settling time in the analysis range.



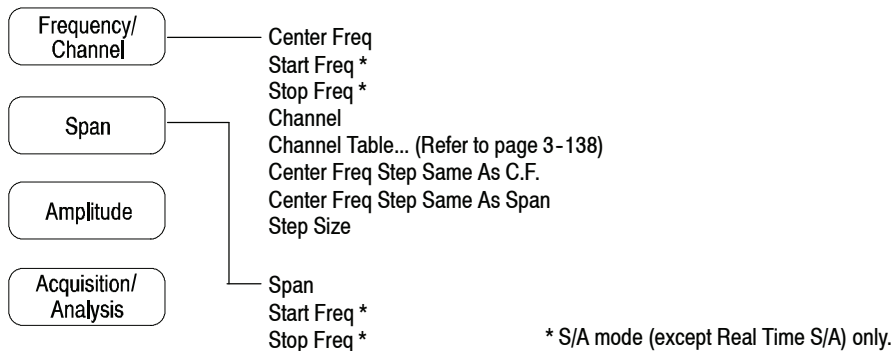
**Figure 3-94: Frequency versus Time measurement**



## Setting Frequency and Span

This section describes frequency and span, which are fundamental settings for observing the spectrum. These items are set using the general purpose knob and the numeric input keypad. You can also use the marker peak search function to set frequency.

## Frequency and Span Setting Menu



**Figure 3-95: Frequency and Span menu structure**

### Frequency/Channel

Sets frequency or channel.

**Center Freq.** Sets the center frequency. Numeric entry field.

Range: 0 Hz to 8 GHz

**Start Freq.** Sets the minimum value (left edge) of the horizontal axis. Numeric entry field.

Range: 0 Hz to 8 GHz

**Stop Freq.** Sets the maximum value (right edge) of the horizontal axis. Numeric entry field.

Range: 0 Hz to 8 GHz

---

**NOTE.** *Start Freq and Stop Freq are available when the measurement mode (Mode) is set to spectrum analysis (S/A except real-time).*

---

The values of Center Freq, Start Freq, Stop Freq, and Span are set in conjunction with each other. The relationship is described as  $(\text{Stop Freq}) - (\text{Start Freq}) = (\text{Span})$ . When one value is set, the other values are automatically changed accordingly.

**Channel.** Selects a channel number to set the center frequency from a channel table specified with the **Channel Table...** menu item.

**Channel Table...** Selects a communication standard to load the channel table. Select a channel number with the **Channel** menu item.

For using the channel tables, refer to page 3-138.

**Center Freq Step Same As C.F.** Sets the center frequency step size equal to the center frequency.

**Center Freq Step Same As Span.** Sets the center frequency step size equal to the span.

**Step Size.** Sets the step size (amount per press by which the up or down key (▲▼) changes the setting value) for setting frequency.

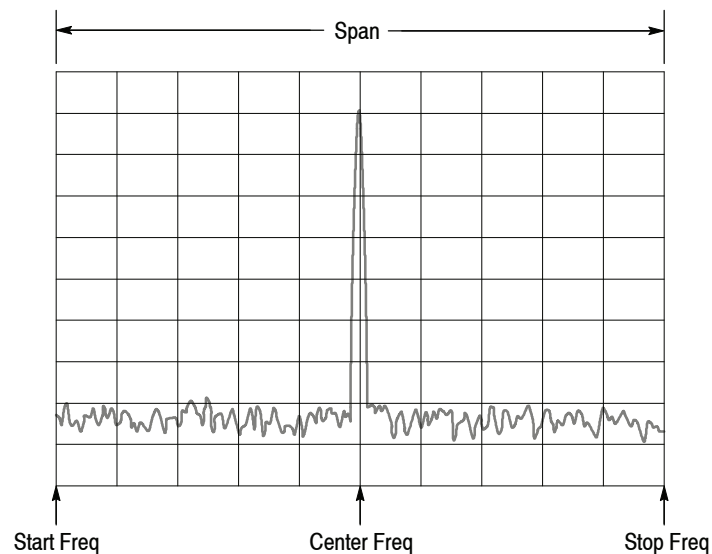
**Span** Controls span. Span and frequency settings are shown in Figure 3-96.

**Span.** Sets span. The available range depends on the measurement frequency band and mode as shown in Table 3-25 on page 3-140.

Turn the general purpose knob to set span in the specified sequence. In the S/A mode (except real-time), you can set an arbitrary span within the limit using the numeric keypad.

**Start Freq.** Same as *Start Freq* on page 3-136.

**Stop Freq.** Same as *Stop Freq* on page 3-136.



**Figure 3-96: Setting frequency and span**

## Using the Channel Table

The channel table contains channel numbers and the corresponding frequencies for a communication system. When you use W-CDMA standard signals, for example, you can set a center frequency by selecting a channel number from the W-CDMA table.

1. Press the **Frequency/Channel** key on the front panel.
2. Press the **Channel Table...** side key and select one of these items:

**None** selects no channel table.

You can select one of the following communication standards:

CDMA2000 EU PAMR400-FL	CDMA2000 NMT450 25k-FL
CDMA2000 EU PAMR400-RL	CDMA2000 NMT450 25k-RL
CDMA2000 EU PAMR800-FL	CDMA2000 SMR800-FL
CDMA2000 EU PAMR800-RL	CDMA2000 SMR800-RL
CDMA2000 GSM BAND 1-FL	CDMA2000 TACS BAND-FL
CDMA2000 GSM BAND 1-RL	CDMA2000 TACS BAND-RL
CDMA2000 GSM BAND 2-FL	DCS1800-DL
CDMA2000 GSM BAND 2-RL	DCS1800-UL
CDMA2000 IMT2000-FL	GSM850-DL
CDMA2000 IMT2000-RL	GSM850-UL
CDMA2000 JTACS BAND-FL	GSM900-DL
CDMA2000 JTACS BAND-RL	GSM900-UL
CDMA2000 KOREA PCS-FL	IEEE802.11a
CDMA2000 KOREA PCS-RL	IEEE802.11b/g
CDMA2000 N.A. 700MHz Cellular-FL	NMT450-DL
CDMA2000 N.A. 700MHz Cellular-RL	NMT450-UL
CDMA2000 N.A. Cellular-FL	PCS1900-DL
CDMA2000 N.A. Cellular-RL	PCS1900-UL
CDMA2000 N.A. PCS-FL	TD-SCDMA
CDMA2000 N.A. PCS-RL	W-CDMA-DL
CDMA2000 NMT450 20k-FL	W-CDMA-UL
CDMA2000 NMT450 20k-RL	

\* FL: Forward link; RL: Reverse link; UL: Uplink; DL: Downlink

3. Press the **Channel** side key and select a channel number.

For example, when selecting channel 10551 in the W-CDMA downlink table, the center frequency is automatically set to 2.1102 GHz.



## Using the Marker and Peak Search

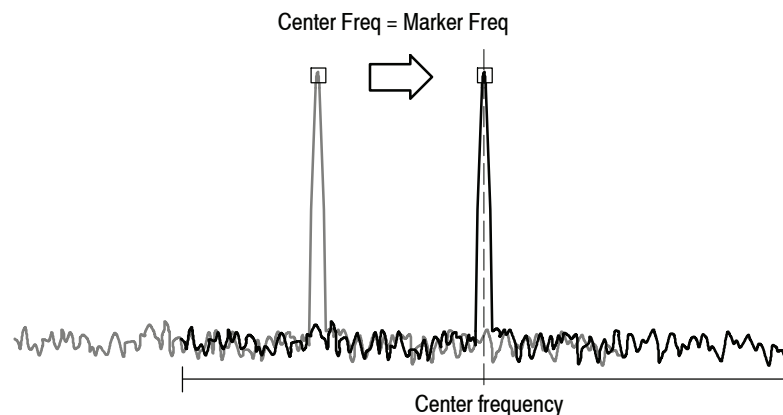
You can use the search function to position the marker on the spectrum peaks, and then set the center frequency to the frequency at the marker, as shown in Figure 3-97.

**In S/A Mode.** You can set the peak spectrum to the center frequency using the marker search functions when the measurement mode is S/A (spectrum analysis).

1. Display the spectrum on the screen.
2. Press the **Peak** key on the front panel. The maximum peak spectrum is detected and the marker is moved to that point.

Use the arrow keys (◀▶ ▲ ▼) to move the marker to another peak.

3. Press the **Marker** ➡ key and then the **Center Freq = Marker Freq** side key. The center frequency is set to the frequency at the marker position.



**Figure 3-97: Setting the center frequency using Marker ➡**

The frequency set in this procedure may not take effect with all span settings. Refer to *Frequency Setting Range* on page 3-140.

**In Demod and Time Modes.** The Marker ➡ key is used to set the analysis range when the measurement mode is Demod or Time (modulation and time analyses). Refer to *Setting the Analysis Range* on page 3-34 for details.

In the overview of spectrogram or the subview of spectrum, you can use the **Center Freq = Marker Freq** side key as in the S/A mode.

## Frequency Setting Range

Frequency bands are defined as shown in Table 3-25, based on the analyzer hardware architecture. The frequency band is switched automatically by a frequency setting. Span setting range depends on the frequency band and the measurement mode (S/A, Demod, or Time).

**Table 3-25: Frequency and span setting range**

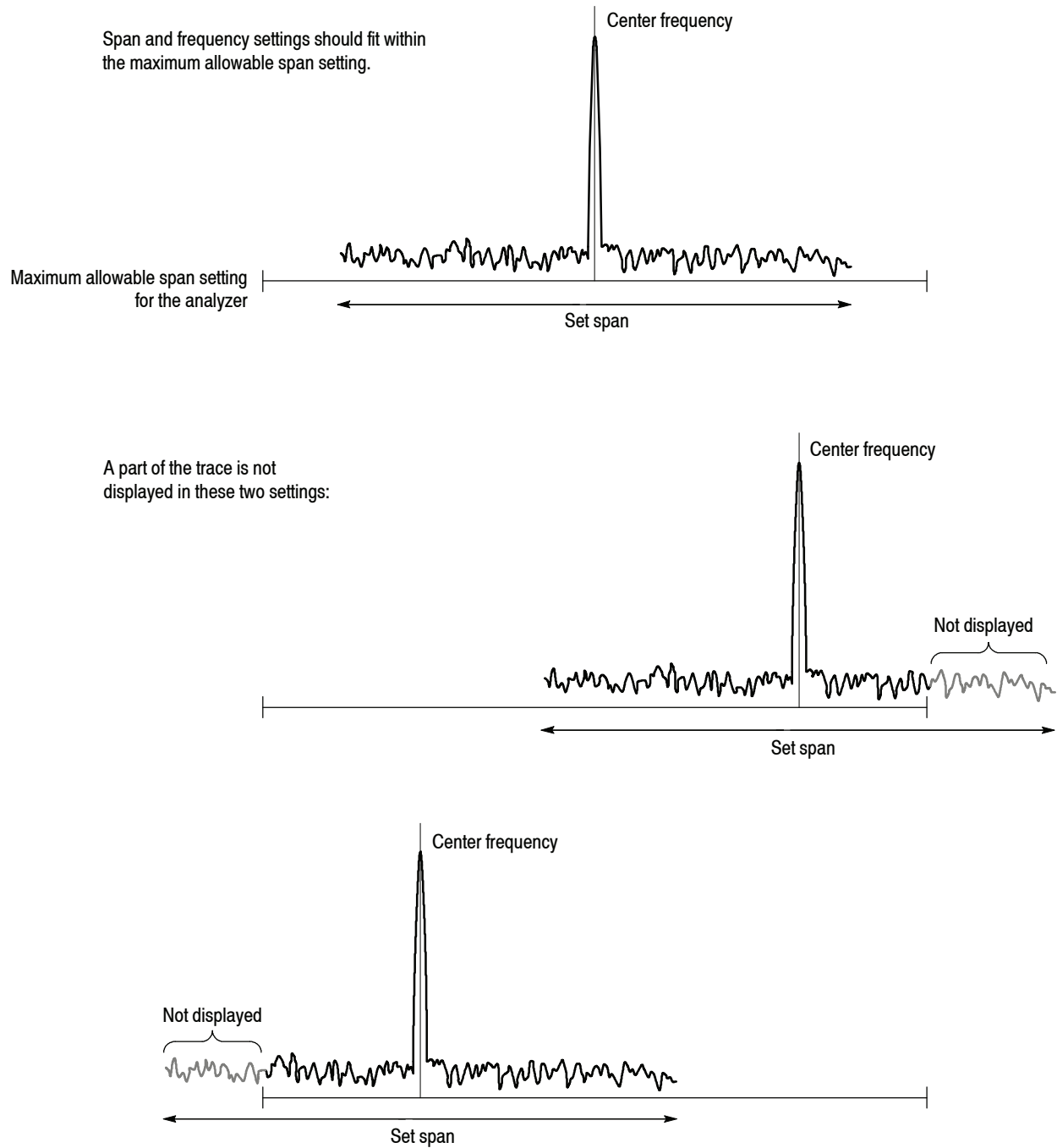
Measurement mode	Frequency band	Frequency range	Span setting range
S/A (except real-time)	Baseband	DC to 40 MHz	50 Hz to 40 MHz (1-1.2-1.5-2-2.5-3-4-5-6-8 sequence)
	RF	40 MHz to 8 GHz	50 Hz to 3 GHz (1-1.2-1.5-2-2.5-3-4-5-6-8 sequence)
Real Time S/A Demod, Time	Baseband	DC to 40 MHz	100 Hz to 40 MHz (1-2-5 sequence)
	RF	40 MHz to 8 GHz	100 Hz to 20 MHz (1-2-5 sequence) and 36 MHz

In Demod and Time modes, the frequency and span settings must meet the following conditions:

$$\begin{aligned} &(\text{Center frequency}) + (\text{Span})/2 \\ &\leq \text{Upper limit of the frequency setting range (RF mode)} \\ &\leq 40 \text{ MHz (Baseband)} \end{aligned}$$

$$\begin{aligned} &(\text{Center frequency}) - (\text{Span})/2 \\ &\geq \text{Lower limit of the frequency setting range (RF mode)} \\ &\geq 0 \text{ Hz (Baseband)} \end{aligned}$$

When you enter an out-of-range value, the value is limited based on these conditions. In spectrum analyzer mode, the out-of-range values are allowed, but part of the trace may not be displayed because the analyzer cannot acquire that part of the waveform (see Figure 3-98).



**Figure 3-98: Relationship between the frequency and span settings**

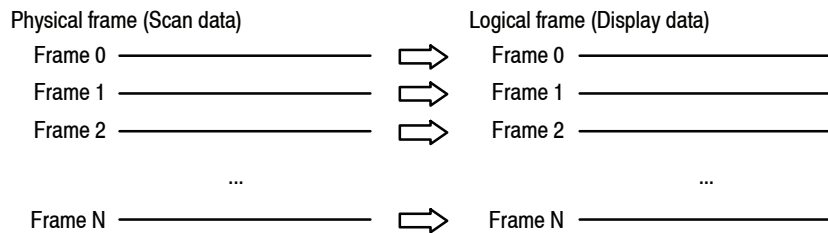
## Vector Span

The input signals are scanned in frame units (one frame = 1024 points). There are two frames: a physical frame to store scanned data and a logical frame to store display data, as illustrated in Figure 3-99.

In the baseband, one logical frame is acquired at one scan regardless of the span setting. You can acquire one logical frame with one scan of a span setting below 36 MHz in the RF band. In larger spans, one logical frame is built up by acquiring data with multiple physical frames. For example, when the span is 40 MHz, one logical frame is composed from two (40 MHz/20 MHz) scans.

When the span is below 36 MHz in the baseband and RF band, one physical frame corresponds to one logical frame; this is referred to as Vector mode, and the span in vector mode is called the Vector span. In the other cases, one logical frame is composed of multiple physical frames, and this is called Scalar mode.

### Span ≤ 36 MHz: Vector mode



### Span > 36 MHz: Scalar mode

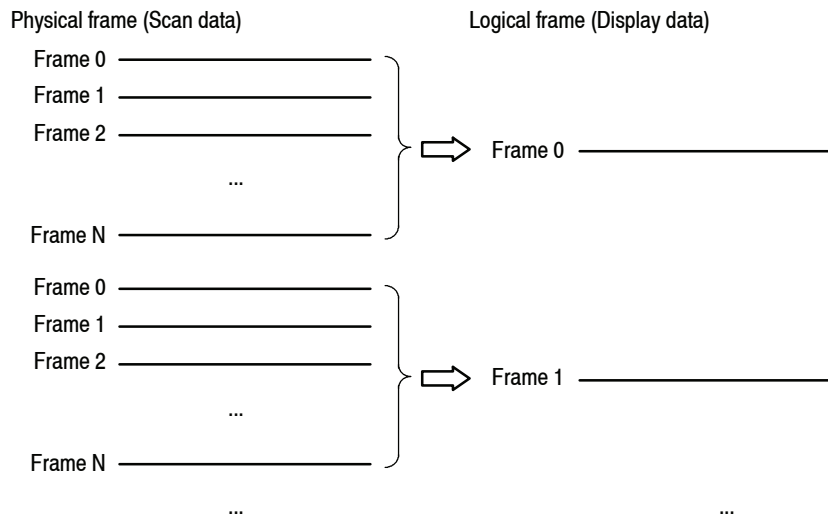


Figure 3-99: Vector mode and scalar mode

# Setting Amplitude

This section describes the fundamental amplitude settings for observing a spectrum. You can add correction to the waveform display by considering frequency characteristics of external devices such as antennas or preamplifiers.

## Amplitude Menu

Press the **Amplitude** key to set amplitude. Figure 3-100 shows the Amplitude menu structure.

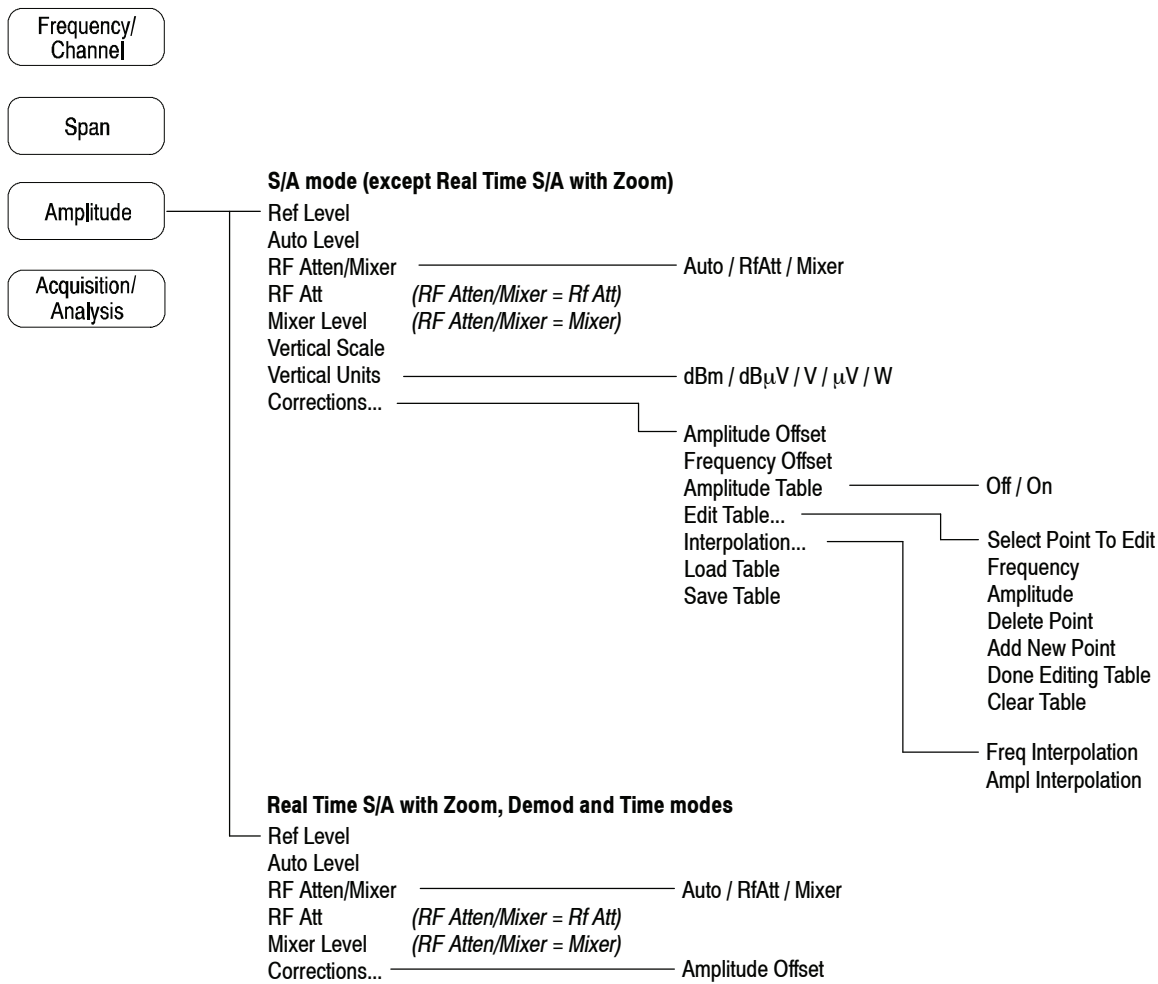


Figure 3-100: Amplitude menu structure

**Amplitude** Sets the scale of the amplitude of the displayed waveform.

**Ref Level.** Sets the maximum (top) edge of the vertical axis. The available range depends on the measurement frequency band as shown in Table 3-26.

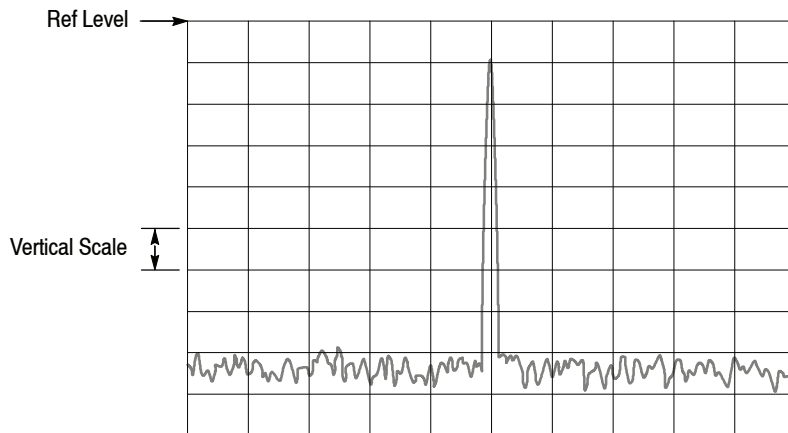
**Table 3-26: Reference level setting range**

Frequency band	Setting range
Baseband (DC to 40 MHz)	-30 to +20 dBm (5 dB step)
RF (40 MHz to 8 GHz)	-50 to +30 dBm (1 dB step)
IQ (Option 03 only)	-10 to +20 dBm (5 dB step)

**Auto Level.** Automatically adjusts reference level for the best system performance based on power measurement within the set span.

**NOTE.** An input signal within 10 MHz of the center frequency may cause Auto Level to choose the wrong reference level, even if the span setting does not make the signal appear on screen. To prevent nonlinear operation, the reference level may need to be adjusted manually.

Auto Level will force the analyzer to acquire new data, which will overwrite the existing data. To scale the existing displayed waveform, do not use Auto Level. Instead, use the View: Scale menu.



**Figure 3-101: Setting the amplitude**

**RF Atten/Mixer.** Input signals are attenuated through the attenuator and converted to IF signals through the mixer in the down-converter (refer to *Architecture* on page 1-7). The attenuation level and the mixer level are normally set automatically. Select **RF Att** or **Mixer** to manually set either parameter, if necessary.

- **Auto.** Sets the mixer level and the RF attenuation level automatically.
- **RF Att.** Sets the RF attenuation level with **RF Att** described below.
- **Mixer.** Sets the mixer level using the **Mixer Level** setting.

---

**NOTE.** *RF Atten/Mixer is set to Auto by default. In this setting, the mixer level is fixed to -15 dBm.*

---

**RF Att.** Changes the RF attenuation level when **RF Att** is selected in **RF Atten/Mixer** above.

Range: 0 to 55 dB in 5 dB steps (default: 15 dB)

Reducing the attenuation may increase the signal level compared to the noise floor, because the noise is generated after the RF attenuator.

**Mixer Level.** Selects the input level of the primary mixer when **Mixer** is selected in **RF Atten/Mixer**.

Range: -25 to 0 dBm in 5 dB steps (default: -15 dBm)

Select the level according to measurement type. The default value is -15 dBm. Use the default value in most cases. This level can be increased up to 0 dBm when a high dynamic range is required for measurements such as the ACPR (Adjacent Channel Leakage Power Ratio) measurement.

---

**NOTE.** *As the mixer level increases, the distortion also increases.*

---

**Vertical Scale.** *S/A mode only (except Real Time S/A with Zoom).*

Sets the vertical scale (per division). The setting range depends on Vertical Units described below, as shown in Table 3-27.

**Table 3-27: Vertical scale setting range**

Vertical units	Scale setting <sup>1</sup>
dBm, dB $\mu$ V	1 to 10
V	223.6 n to 22.36 m
$\mu$ V	223.6 m to 22.36 k
W	100 p to 100 $\mu$

<sup>1</sup> **1-2-5 sequence with the general purpose knob.**  
**Arbitrary value with the numeric keypad.**

**Vertical Units.** *S/A mode only (except Real Time S/A with Zoom).*

Selects the unit of amplitude scale: dBm, dB $\mu$ V, V,  $\mu$ V, or W.

**Corrections...** Sets amplitude correction. Refer to page 3-148 for details of amplitude correction.

## Basic Setting Procedure

To set amplitude, follow these steps:

1. Press the **Amplitude** key on the front panel.
2. Set the reference level using the **Ref Level** side key.
3. To best display the waveform automatically, press the **Auto Level** side key.
4. To set the attenuation level or the mixer level manually, use the **RF Atten/Mixer** side key to select **RF Att** or **Mixer**.

*When you select **RF Att**:*

Select the attenuation level with the **RF Att** side key.

*When you select **Mixer**:*

Select the first mixer input level using the **Mixer Level** side key.

5. *S/A mode (except Real Time) only.*  
Use the **Vertical Scale** side key to set the vertical scale (per division).  
Use the **Vertical Units** side key to select the unit.
6. To apply amplitude correction, press the **Corrections...** side key to set the parameters. Refer to *Amplitude Correction* on page 3-148 for details.



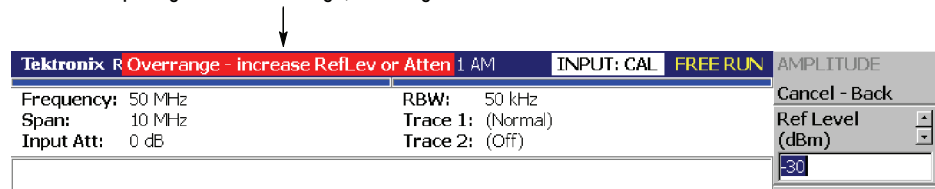
## Over-Voltage Input

Set the reference level (Ref Level) according to the input signal level. The default setting is 0 dBm. If the signal level gets too high or the reference level is set too low, over-voltage input may occur. If an over-voltage input occurs, the status indicator “Overrange - increase RefLev or Atten” is displayed in the red box (see Figure 3-102).



**CAUTION.** *If a signal exceeding +30 dBm (1 W) is applied, it can damage the analyzer. Be sure to limit input signals to +30 dBm or below.*

When the input signal level is too high, overrange is indicated in the red box.



**Figure 3-102: Overrange indicator**

**NOTE.** *If “Overrange - increase RefLev or Atten” is displayed, it indicates that the A/D converter in the subsequent part of the downconverter inside this instrument is overloaded. In this case, data display is distorted and the measurement is not accurate.*

*If a signal larger than the reference level set value by 20 dB or more is applied continuously, however, the limiter of the IF amplifier in the downconverter is automatically activated to prevent large level signals from passing through the A/D converter. Even if a signal exceeding the reference level is applied, therefore, “Overrange - increase RefLev or Atten” may not be displayed. Auto Leveling the signal can usually eliminate all overload conditions.*

*Take sufficient care about the input signal level.*

The overflow indicator is updated at every physical frame acquisition. When a high level signal is applied under a setting that uses multiple physical frames for one scan, “Overrange - increase RefLev or Atten” may be displayed for a moment and then turned off immediately. When a single high-level signal is applied under a setting using one physical frame in one scan, the same phenomenon may be observed.

## Amplitude Correction

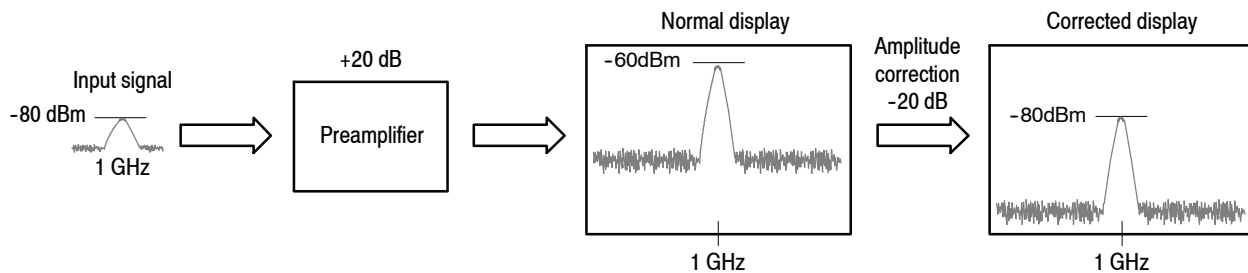
If an external device such as an antenna or preamplifier is connected to the analyzer, you can amplitude correct the waveform by considering the amplitude characteristics of the external device.

---

**NOTE.** *The amplitude correction function is fully controlled only in the S/A mode (except real-time mode). In the other modes (Real Time S/A, Demod, and Time), amplitude offset control is available. Refer to page 3-155 for setting the offset.*

---

Figure 3-103 shows the concept of amplitude correction. In this example, a signal with -80 dBm is sent to a preamplifier with a gain of +20 dB around 1 GHz. In the normal display, without any amplitude correction, the signal peak becomes  $-80+20 = -60$  dBm. If amplitude correction is performed, the peak becomes  $-60-20 = -80$  dBm to obtain the original peak value of the input signal.



**Figure 3- 103: The amplitude correction concept**

**Amplitude Correction  
Menu**

Press **Amplitude > Corrections...** to set the correction parameters.  
The correction menu has the following controls:

**Amplitude Offset.** Sets the amplitude offset. The amplitude of an entire waveform decreases by the offset value.

---

**NOTE.** *The following Corrections menu items are available in the S/A (spectrum analysis) mode except Real Time S/A.*

---

**Frequency Offset.** Sets the frequency offset. The effective correction range of the amplitude correction table shifts by the offset value.

**Amplitude Table.** Enables or disables amplitude correction. Select On to enable the correction.

**Edit Table...** Creates a correction table. Input pairs of frequency and amplitude correction value.

- **Select Point To Edit.** Selects a row to be edited.
- **Frequency.** Enters the frequency of a correction point.
- **Amplitude.** Enters an amplitude correction value for the specified frequency.
- **Delete Point.** Deletes the selected row.
- **Add New Point.** Adds a row with the values in the previous row copied as initial values.
- **Done Editing Table.** Confirms the input and adds a new row.
- **Clear Table.** Deletes the correction data from the memory.

**Interpolation...** Selects the horizontal and the vertical scale for interpolating correction data.

- **Freq Interpolation.** Selects the horizontal scale for interpolating correction data: Linear or Logarithmic.
- **Ampl Interpolation.** Selects the vertical scale for interpolating correction data: Linear or dB.

**Load Table.** Reads an amplitude correction table from a file.

**Save Table.** Writes a created correction table to a file.

### Amplitude Correction File

Before performing amplitude correction, you must describe the frequency characteristics of the external device in an amplitude correction file (\*.cor).

You can use word processing software to create the file on a computer and then use a disk or network to load the file into the analyzer. Alternatively, you can create correction data on the analyzer screen.

The rules for creating an amplitude correction file are given on page 3-151 and the procedures are given on page 3-152.

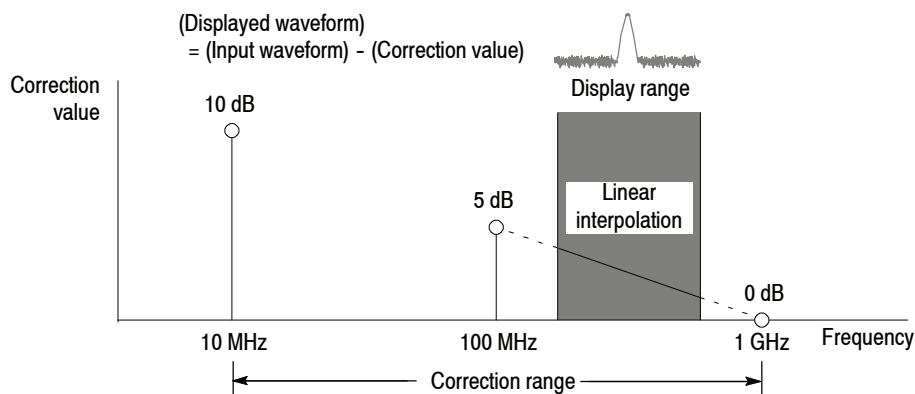
**File Format.** A correction file contains amplitude correction values at each frequency, in the following format:

```
<Frequency 1> = <Amplitude correction value 1>
<Frequency 2> = <Amplitude correction value 2>
<Frequency 3> = <Amplitude correction value 3>
...
```

*Example:* The following amplitude correction file has correction data for three points:

Correction data:	Correction file description:
10 dB at 10 MHz	10M=10
5 dB at 100 MHz	100M=5
0 dB at 1 GHz	1G=0

In this example, only the data from 10MHz to 1GHz is corrected (see Figure 3-104). The correction value in the display range is obtained using linear interpolation between input points. A waveform obtained by subtracting the correction value from the input waveform is displayed.



**Figure 3-104: Amplitude correction example**

Linear or Logarithmic (Log/dB) interpolation can be selected using the following menus:

- **Amplitude > Corrections... > Interpolation... > Freq Interpolation**

**Lin.** Linear interpolation of correction values is performed on the frequency axis using a linear scale.

**Log.** Linear interpolation of correction values is performed on the frequency axis using a logarithmic scale.

- **Amplitude > Corrections... > Interpolation... > Ampl Interpolation**

**Lin.** Linear interpolation of correction values is performed on the amplitude axis using a linear scale.

**dB.** Linear interpolation of correction values is performed on the amplitude axis using a logarithmic scale.

#### **Rules for Creating an Amplitude Correction File.**

- Create the file as a text file and save it with the extension “.cor”.
- The maximum number of input lines is 3000.
- The order of correction data input is unimportant because the file is sorted when it loads. However, it may be easier to follow if you enter data in the order of ascending frequency.
- Numeric values are described without the unit of frequency or amplitude (Hz, dB, W, etc.). For example, 5 MHz frequency is expressed as 5M.
- Frequency can be expressed as a floating point number or with the SI unit (k, M, or G). For example, the following lines show three different ways to express the same value:

```
1000, 1E+3, 1k
1230000, 1.23E+6, 1.23M
1000000000, 1.0E+9, 1.0G
```

- Amplitude is expressed as a decimal number or integer (such as 1.23 or 10).
- Do not use a space in a numeric value; however, you can space before and after “=”.

*Correct:* 10M = 10 (A space is inserted before and after “=”.)

*Incorrect:* 10 M=10 (A space is inserted between “10” and “M”.)

**Creating an Amplitude Correction File on a Computer.** Use word processing software on a computer to create a text file with the extension “.cor”.

Be sure to use the correct file format (refer to *File Format* on page 3-150) and follow the *Rules for Creating an Amplitude Correction File* on page 3-151.

For information about performing amplitude correction, refer to page 3-156.

**Creating Correction Data on the Analyzer Screen.** The procedure for entering new correction data or modifying existing data on the screen is as follows. Refer also to *Rules for Creating an Amplitude Correction File* on page 3-151.

1. Press the **Amplitude** key on the front panel.
2. Press the **Corrections...** side key.
3. *To edit an existing file:* Refer to page 3-251 for file handling.
  - a. Press the **Load Table** side key to load the file.
  - b. Press the **Edit Table...** side key.
4. *To enter new data:* See Figure 3-105.
  - a. Press the **Frequency** side key and enter the frequency of a correction point.
  - b. Press the **Amplitude** side key and enter the amplitude correction value at the correction point.
  - c. Press the **Add New Point** side key.

A new row is added, containing the same frequency and amplitude correction values as the previous row. Modify the values appropriately.

---

**NOTE.** *If you set the same frequency as the previous row, the amplitude correction value in the previous row will be overwritten the next time you press the Add New Point side key.*

*It is not necessary to enter correction data in order by frequency. The rows are automatically reordered in ascending order of frequency.*

---

- d. Repeat step c to enter the frequency and amplitude correction values for all points.
- e. Press the **Done Editing Table** side key.

The input is accepted and a new row is added.

5. To add correction data:

- a. Press the **Select Point To Edit** side key and turn the general purpose knob to move the cursor to the last row (empty) in the table.
- b. Perform step 4 to enter the frequency and amplitude correction values.

	Frequency (Hz)	Amplitude (dB)
1	10M	10
2	20M	12
3	30M	14
4		

Frequency      Amplitude correction value

**Edit Table**  
 Cancel - Back  
**Select Point To Edit (4)** ← **Select Point To Edit**  
 Selects a line.  
**Frequency (Hz)** ← **Frequency**  
 Inputs frequency of the point.  
**Amplitude** ← **Amplitude**  
 Inputs correction value.  
**Delete Point** ← **Delete Point**  
 Deletes a line.  
**Add New Point** ← **Add New Point**  
 Deletes all data in the table.  
**Done Editing Table** ← **Done Editing Table**  
 Registers the input values and adds a line.  
**Clear Table** ← **Clear Table**  
 Deletes all data in the table.

Spectrum Analyzer: Measurement Off      Frequency (Hz): 0

Figure 3-105: Amplitude correction data input

6. To modify input data: Press the **Select Point To Edit** side key and turn the general purpose knob to move the cursor to the row to be modified. Use the following side keys as needed:
  - To modify a frequency, use the **Frequency** side key.
  - To modify an amplitude, use the **Amplitude** side key.
  - To delete a row, press the **Delete Point** side key.
  - To delete all data in the table, press the **Clear Table** side key.
7. Repeat steps 5 and 6 as needed.

- 8.** When you have finished the data input, save the file as follows:
  - a.** Press the **Amplitude** key on the front panel.
  - b.** Press the **Corrections...** side key.
  - c.** Press the **Save Table** side key to specify the save file.  
Refer to page 3-251 for file handling.

For information about performing amplitude correction, refer to page 3-156.



## Setting the Offset

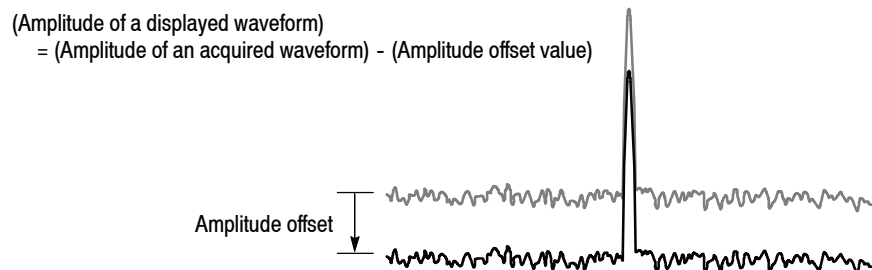
The amplitude correction function includes amplitude and frequency offset.

**NOTE.** The amplitude offset is available in all the measurement modes of S/A, Demod, and Time.

**Amplitude Offset.** Subtracts the specified offset from the original amplitude (see Figure 3-106). The offset value is set using the menu item **Amplitude > Corrections... > Amplitude Offset**.

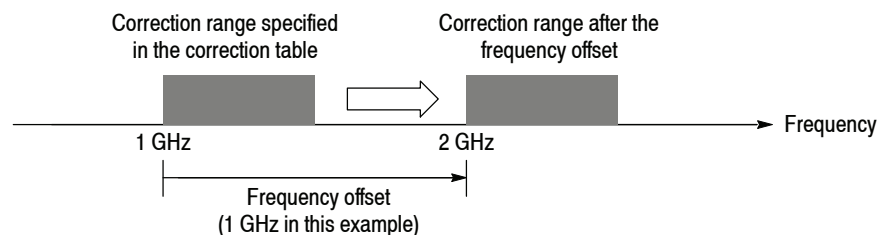
The operation varies slightly between the measurement modes as follows:

- *In the S/A mode (except real-time mode):* The amplitude offset is effective whenever the amplitude correction is turned on (**Amplitude > Corrections... > Amplitude Table > On**) even if the table is not set.
- *In the other modes (Real Time S/A, Demod, and Time):* The amplitude offset is always effective. The default value is zero. If you set the offset to a non-zero value, a waveform shifts vertically as shown in Figure 3-106.



**Figure 3-106: Amplitude offset**

**Frequency Offset.** Shifts the correction range by the specified offset with the same correction table (see Figure 3-107). The offset value is set using the **AMPLITUDE > Corrections... > Frequency Offset** menu item.



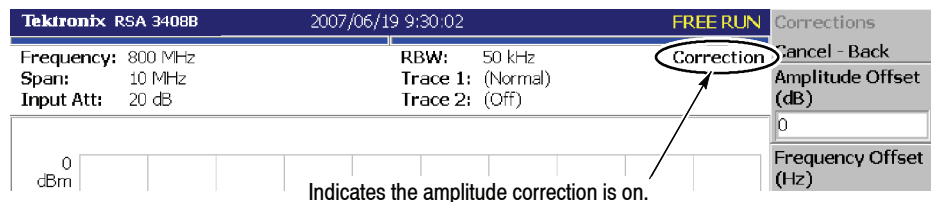
**Figure 3-107: Frequency offset**

### Performing Amplitude Correction

Load an amplitude correction file and acquire input signals:

1. Press the **Amplitude** key on the front panel.
2. Press the **Corrections...** side key.
3. Do either of these two steps:
  - Press the **Edit Table...** side key to create an amplitude correction file. Refer to page 3-150 for creating the correction file.
  - Press the **Load Table** side key to specify an amplitude correction file. Refer to page 3-251 for file operation.
4. Press the **Amplitude Offset** side key to set the amplitude offset, if necessary.
5. Press the **Frequency Offset** side key to set the frequency offset, if necessary.
6. Press the **Interpolation...** side key to select scaling for the interpolation:
  - a. Press the **Freq Interpolation** side key to select the scale for frequency interpolation: Lin (linear) or Log (logarithmic).
  - b. Press the **Ampl Interpolation** side key to select the scale for amplitude interpolation: Lin (linear) or dB (logarithmic).
7. Press the **Amplitude Table** side key to select **On**. The amplitude correction is now applied to the waveform.

The amplitude correction is applied to the acquired data and the corrected waveform is shown. When the amplitude correction is turned on, “Correction” is displayed in the setup display area at the upper right of the screen, as shown in Figure 3-108.



**Figure 3- 108: Amplitude correction setup display**

### Erasing Correction Data

The analyzer automatically saves the correction data in use when it is powered down. The data will be erased when you press these keys:

- **Amplitude > Corrections... > Edit Table... > Clear Table**
- **Preset**

# Setting Acquisition and Analysis Parameters

You can adjust the length of various time parameters and the relationship between them in the Real Time S/A, Demod, and Time modes using the Acquisition/Analysis menu.

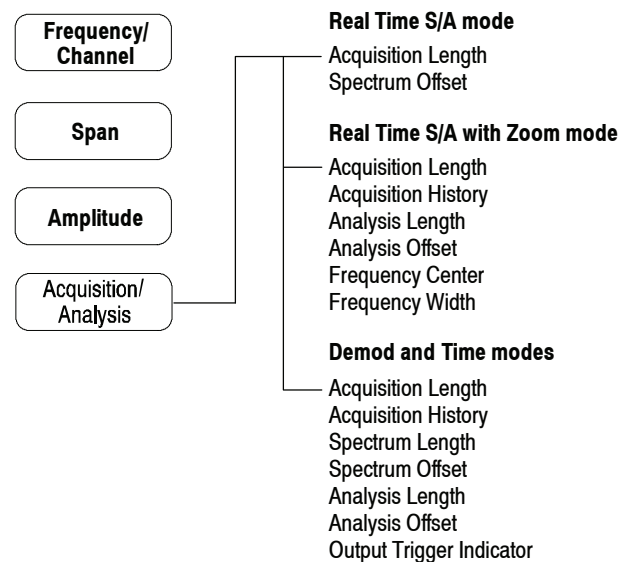
---

**NOTE.** The Acquisition/Analysis menu is not available in the S/A mode (except Real Time S/A).

---

## Acquisition/Analysis Menu

Figure 3-109 shows the Acquisition/Analysis menu structure.



**Figure 3-109: Acquisition/Analysis menu structure**

### Parameters in Demod and Time Modes

The Acquisition/Analysis menu in Demod (modulation analysis) and Time (time analysis) modes contains the following items (see Figure 3-110):

**Acquisition Length.** Sets the time length to acquire one block (= M frames). The acquisition length is calculated using this equation:

$$(\text{One block acquisition length}) = M \times (\text{One frame acquisition length})$$

where M is the number of frames in a block.

One frame acquisition length is determined by span internally. For details, refer to *Specifications* in the *RSA3408B Technical Reference*.

**Acquisition History.** Specifies the number of the block to display and analyze. The latest block is number zero. Older blocks have larger negative numbers. In most cases the analyzer retains previous acquisitions. You can view previous acquisitions by selecting the acquisition history by block number.

**Spectrum Length.** Displays the time length for FFT processing of the spectrum displayed in the subview. It is equivalent to one frame acquisition length determined by Span, RBW, and FFT points setting.

**Spectrum Offset.** Sets the beginning of Spectrum Length with respect to the trigger output point.

**Analysis Length.** Sets the time length of the analysis range in the block specified by Acquisition History.

**Analysis Offset.** Sets the beginning of Analysis Length with respect to the trigger output point.

**Output Trigger Indicator.** Determines whether to display the output trigger indicator (“O”) on the overview. Refer to *Trigger Point Indicator* on page 3-177.

For procedures to set these parameters, refer to *Setting the Analysis Range* on page 3-34 and *Setting FFT Processing Range for the Subview* on page 3-38.

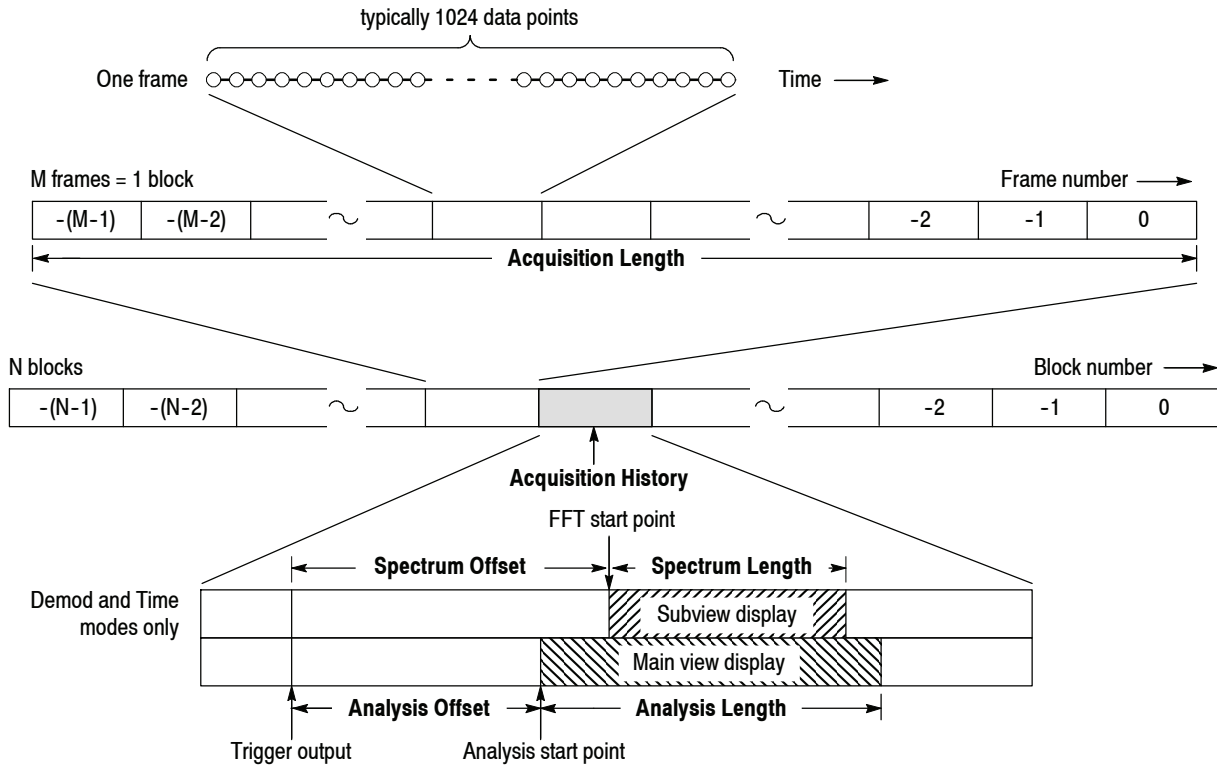


Figure 3-110: Acquisition and analysis parameters

**Parameters in Real Time S/A Mode**

The Acquisition/Analysis menu in the Real Time S/A (real-time spectrum analysis) mode contains the following items:

**Acquisition Length.** Same as in the Demod and Time modes.

**Spectrum Offset.** Specifies the number of the frame in the spectrogram to display the spectrum. The latest frame is number zero. Older frames have larger negative numbers.

**Parameters in Real Time S/A with Zoom Mode**

The Acquisition/Analysis menu in the Real Time S/A with Zoom mode contains the following items (see Figure 3-111):

**Acquisition Length.** Same as in the Demod and Time modes.

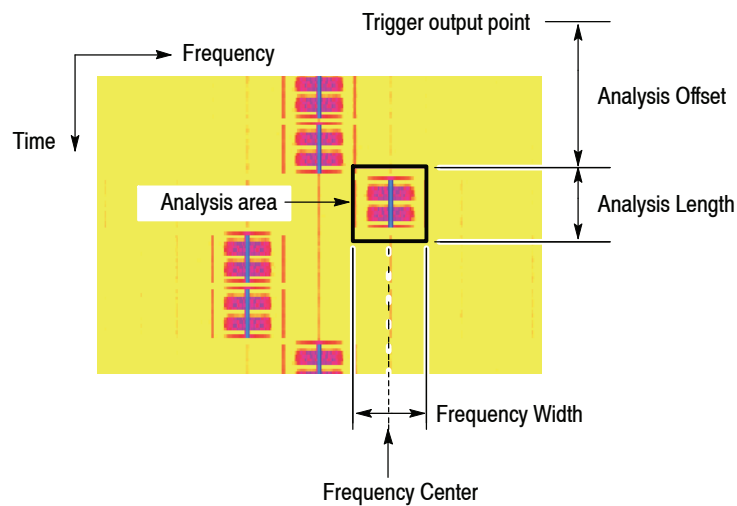
**Acquisition History.** Same as in the Demod and Time modes.

**Analysis Length.** Same as in the Demod and Time modes.

**Analysis Offset.** Same as in the Demod and Time modes.

**Frequency Center.** Sets the frequency of the center of analysis area.

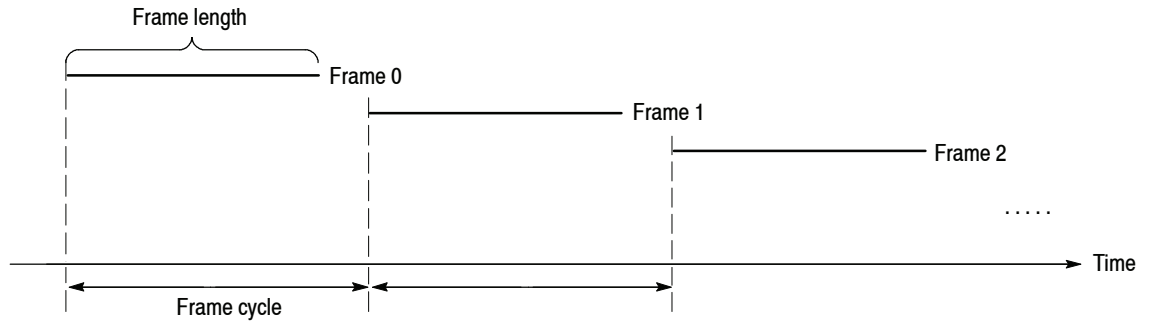
**Frequency Width.** Sets the frequency width of the analysis area.



**Figure 3- 111: Parameters in the zoom mode**

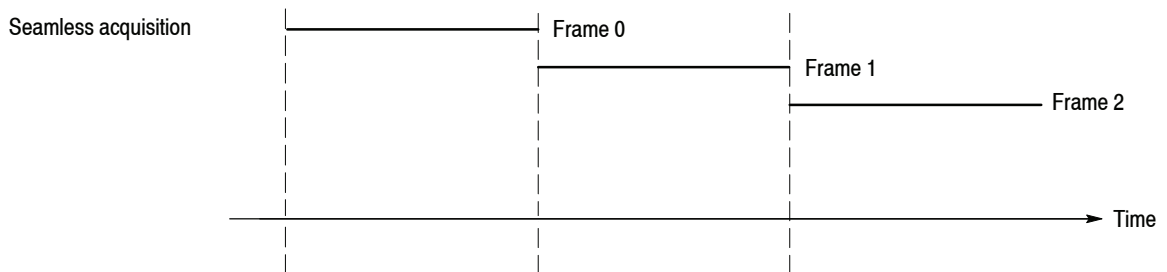
## Seamless Acquisition

The frame data is acquired every designated time. The interval between one acquisition and another is called a “frame cycle,” as shown in Figure 3-112.



**Figure 3-112: Frame cycle**

If the frame cycle is longer than the frame length, time gaps appear between frames. The shorter the frame cycle, the more precisely you can observe the spectrum waveform variation in time. You can acquire frames without gaps when the span setting is below 36 MHz. Acquiring frame data without a gap is called Seamless Acquisition. See Figure 3-113.



**Figure 3-113: Seamless acquisition**

When the span is set greater than 36 MHz, one display frame is reproduced from multiple acquired frames and the frame cycle becomes meaningless. Refer to *Vector Span* on page 3-142 for details.





# Trigger

Triggers determine when the analyzer stops acquiring an input signal and displays measurement results. To properly acquire data that you want to measure, you need to set up the trigger conditions. This section describes the following trigger parameters:

- **Mode:** Selects free run or triggered acquisition.
- **Repeat:** Determines whether to acquire data continuously or singly.
- **Source:** Selects a trigger signal source.
- **Level:** Sets a trigger level.
- **Slope:** Selects the rising or falling edge of a trigger signal.
- **Position:** Specifies a trigger position.

You must create a trigger mask when triggering in the frequency domain with Option 02. Refer to page 3-171 for creating a trigger mask.

A “T” mark (with “O” optionally) indicating a trigger point is displayed on the overview in the Demod and Time modes. Refer to page 3-177 for information about displaying the trigger point.

## Trigger Menu

Use the Trigger menu to set trigger conditions. Press the **Trig** key on the front panel and set the parameters using the following menu items.

**NOTE.** Except for the Repeat menu item, the Trigger menu is available when the measurement mode is set to Real Time S/A, Demod, or Time.

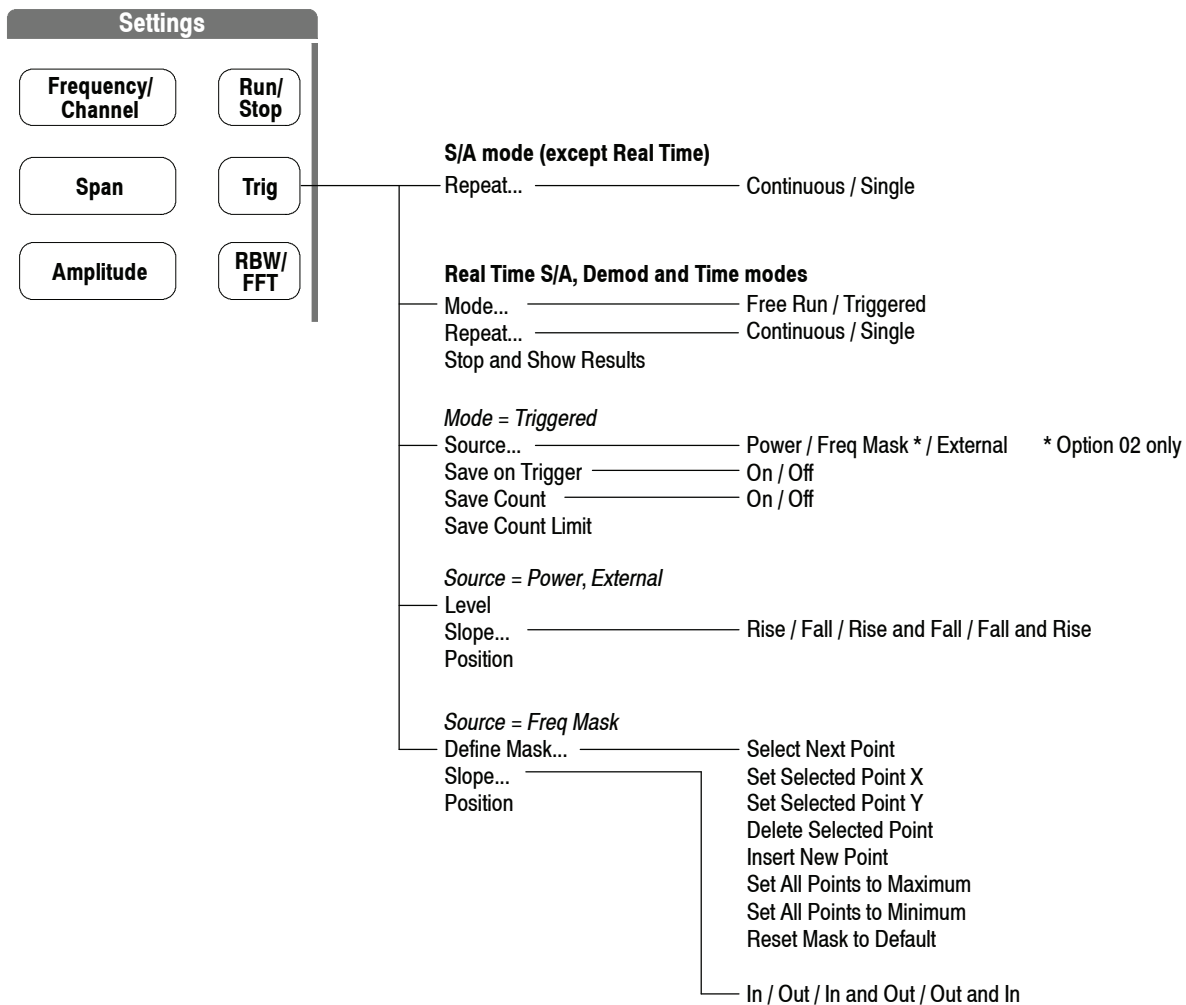


Figure 3- 114: Trigger menu structure

**Mode...** Selects the trigger mode. The trigger mode determines whether to acquire data with or without triggering.

- **Free Run.** Acquires and displays the waveform without triggering. Press the **Run/Stop** key to start data acquisition. To stop the acquisition, press the **Run/Stop** key again.
- **Triggered.** Set the trigger conditions (level, slope, and position) before starting data acquisition by pressing the **Run/Stop** key. When the trigger occurs, data is acquired and displayed. To stop data acquisition when the trigger does not occur, press the **Run/Stop** key again.

**Repeat...** Selects whether to acquire data continuously or singly.

- **Continuous.** Repeatedly acquires and displays the waveform. Acquisition data will be overwritten while waiting for a new trigger event. Use the Single setting if you will need to examine or reanalyze the measurement results.
- **Single.** Acquires and displays one waveform. After the first waveform display, you must press Run/Stop to acquire and display each waveform.

Table 3-28 shows the acquisition method with the trigger and repeat modes. The concept is illustrated in Figure 3-118 on page 3-169.

**Table 3-28: How to acquire a waveform**

Trigger mode (Trig → Mode)	Repeat mode (Trig → Repeat)	Description
Free run	Continuous	Press Run/Stop to acquire data repeatedly. Press this key again to stop acquisition.
	Single	Press Run/Stop to acquire one waveform.
Triggered	Continuous	Press Run/Stop to acquire data every trigger event.
	Single	Press Run/Stop to acquire one waveform every trigger event.

**Stop and Show Results.** Stops data acquisition and shows measurement results. Instead of the **Run/Stop** key, you can stop data acquisition by pressing the **Stop and Show Results** side key when the measurement mode is Real Time S/A, Demod, or Time. However, there is the following difference in function:

- Pressing the **Run/Stop** key to stop data acquisition: The block data acquired at the moment of pressing the key is discarded and the measurement results are shown for the previous block of data.
- Pressing **Trig → Stop and Show Results** to stop data acquisition: Shows measurement results even for the block of data acquired at the moment of pressing the side key, which might not fill a whole block.

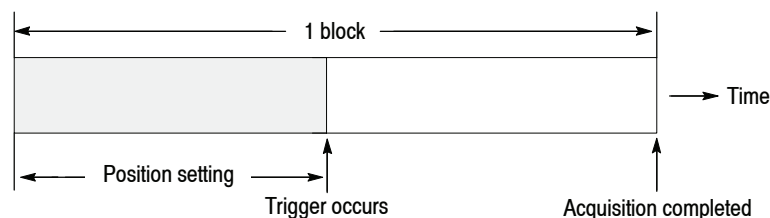
In either case, press **Run/Stop** again to restart acquisition.

**Source.** Selects a trigger source when the trigger mode is Triggered.

- **Power (Span BW).** *Default.* Uses time domain I/Q data of the input signal as the trigger source. You can set the trigger level, slope, and position.
- **Freq Mask.** *Option 02 only.* Uses a trigger mask as the trigger source. Refer to page 3-171 for information about creating the trigger mask.
- **External.** Uses the external signal input from the TRIG IN connector on the rear panel as the trigger source. You can set the trigger level, slope, and position. For specifications of the external trigger, refer to the *RSA3408B Technical Reference*.

**Position.** Available when the trigger mode is set to Triggered. Specifies the position of the trigger in a block as a percentage of all the frames in the block. For example, if you set the trigger position to 50%, the trigger occurs at the center of the block, as shown in Figure 3-115.

Range: 0 to 100% in 1% step.



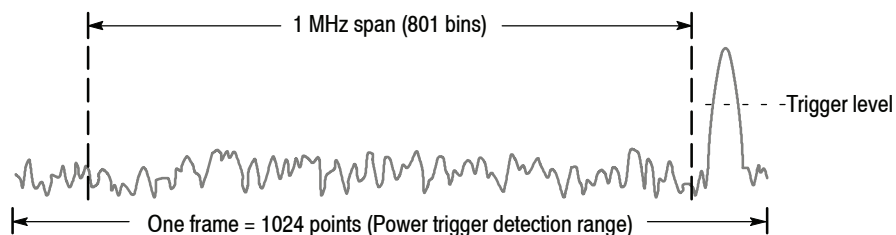
**Figure 3- 115: Trigger position**

**Level.** Sets the trigger level. Available when the trigger mode is set to Triggered and the source is set to Power or External. Table 3-29 shows the setting range.

**Table 3-29: Trigger level setting range**

Trigger source	Trigger level
Power (Span BW)	-40 to 0 dBfs in 1 dBfs steps (in time domain)
External	-1.5 to +1.5 V in 0.1 V steps

*Hint for the Power trigger.* An input signal is FFT-processed every frame (= 1024 points). However, the displayed data is less than 1024 points (refer to *Relation between Frame, Bin, and Pixel* on page 3-200). For example, 801 bins are displayed when the span is 1 MHz. The Power trigger always observes one whole frame (= 1024 points) to determine trigger generation. Note that, as shown in Figure 3-116, any signal exceeding the trigger level outside the range of 1 MHz of span activates the Power trigger even if no signal exceeds the trigger level within the range of 1 MHz of span.



**Figure 3-116: Power trigger detection range**

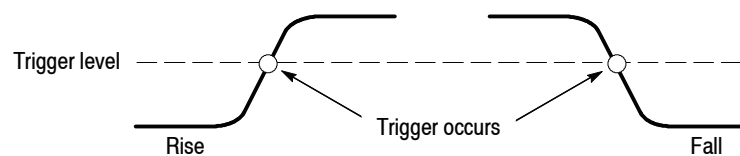
**Define Mask...** *Option 02 only.* Creates a trigger mask when the trigger mode is set to Triggered and the source is set to Freq Mask. The trigger mask is created in the spectrum view. Refer to page 3-171 for details on creating a trigger mask.

**Slope.** Selects the trigger slope when the trigger mode is Triggered and the trigger source is External.

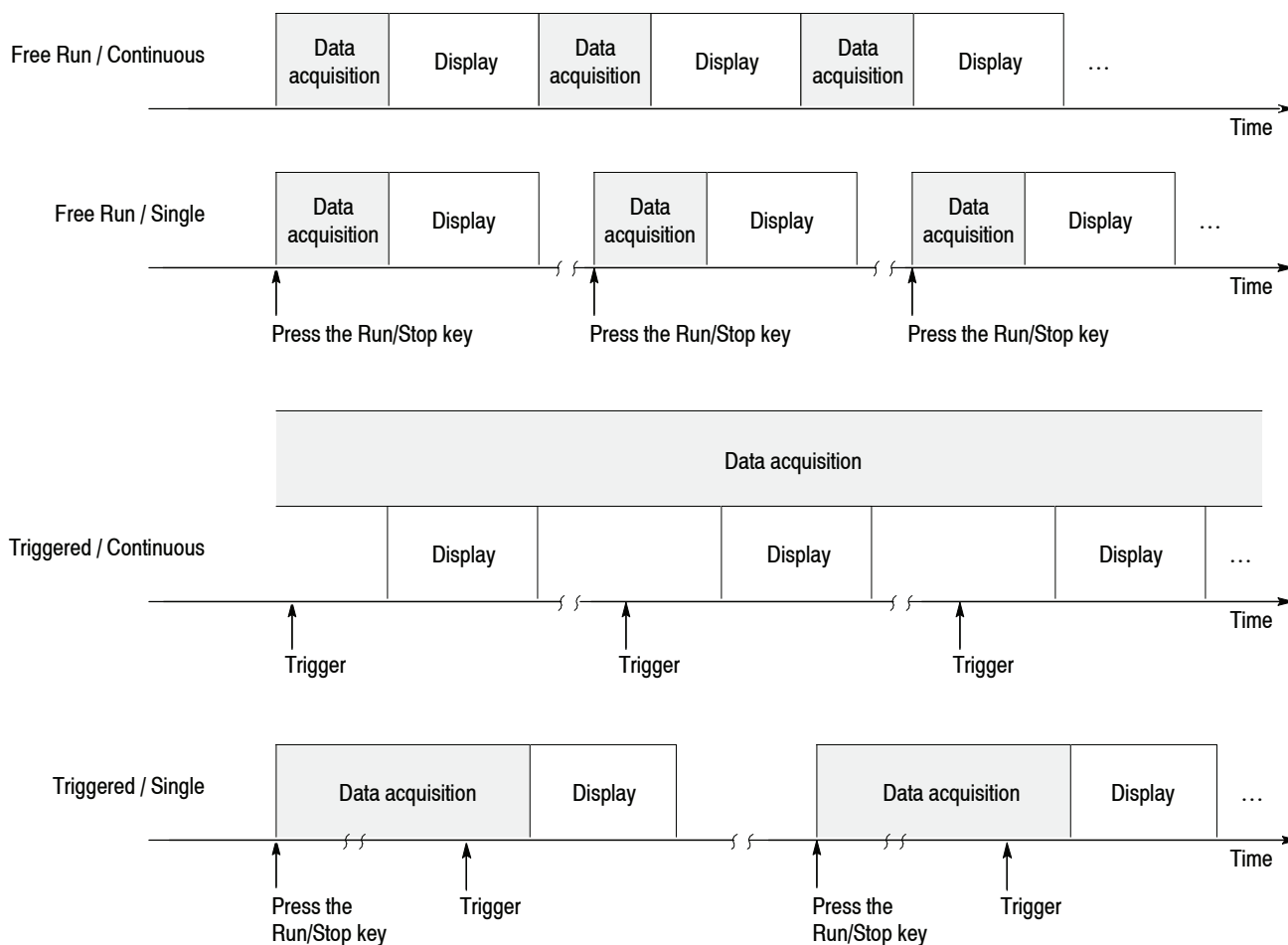
- **Rise.** The trigger occurs at the rising edge of the trigger signal.
- **Fall.** The trigger occurs at the falling edge of the trigger signal.
- **Rise and Fall.** The trigger occurs at the rising edge of the trigger signal to acquire the first block, and at the falling edge to acquire the next block. The rising and falling edges alternate at each block acquisition.
- **Fall and Rise.** The trigger occurs at the falling edge of the trigger signal to acquire the first block, and at the rising edge to acquire the next block. The rising and falling edges alternate at each block acquisition.

*When using a trigger mask (Option 02 only).* When the trigger source is set to Freq Mask for using a trigger mask, the following selection items are available:

- **In.** The trigger occurs when an input signal exits the blue area of a trigger mask and enters the black area.
- **Out.** The trigger occurs when an input signal exits the black area and enters the blue area of a trigger mask.
- **In and Out.** The analyzer triggers with In to acquire the first block, and Out to acquire the second. In and Out alternate at each block acquisition. Use the acquisition history control to view alternate In/Out blocks.
- **Out and In.** The analyzer triggers with Out to acquire the first block, and In to acquire the second. In and Out alternate at each block acquisition. Use the acquisition history control to view alternate In/Out blocks.



**Figure 3- 117: Trigger level and slope**



**Figure 3-118: Acquiring and displaying data by Trigger and Repeat modes**

## Data Saving on Trigger

A Save-on-Trigger function is provided to save one block of input data to the IQT file each time a trigger occurs. This function is enabled when the trigger mode is set to Triggered. For details of file operations, refer to page 3-251.

The file name and location are as follows:

- File name: `yyyymmdd-hhmmss-ticks.IQT`

Where

yyyy is the year, mm the month, and dd the date.

hh is the hour, mm the minutes, and ss the seconds.

*ticks* is the time stamp of the final frame.

(Refer to *unsigned long ticks* on page 3-271.)

Example: 20050721-140120-0000154761.IQT

- Directory:  
C:\Documents and Settings\<username>\My Documents\Save-on-Trigger\

Use the following Trigger menu items to control the Save-on-Trigger function:

**Save On Trigger.** Enables and disables the Save-on-Trigger function.

- **On.** Enables the Save-on-Trigger function
- **Off. Default.** Disables the Save-on-Trigger function

**Save Count.** Selects whether to set a limit on the number of times that data is saved.

- **On. Default.** When the number of data save operations reaches the Save Count Limit indicated below, data saving is halted.
- **Off.** No limit on data save operations is set. In this case, data saving is halted using the **Run/Stop** key on the front panel or the GPIB command.

---

**NOTE.** When the internal hard disk becomes full, data saving is halted and the “Media full” error message appears.

---

For deleting a file, refer to page 3-264.

**Save Count Limit.** Sets a limit on the number of times that data is saved. This setting is enabled when the above-mentioned Save Count is On.

Setting range: 1 to 16383 (default: 100)



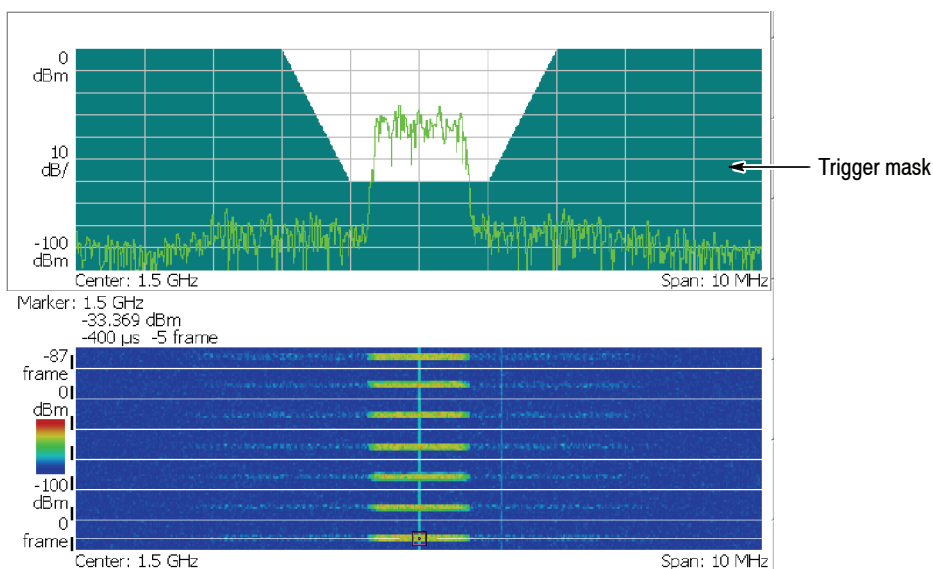
## Creating a Trigger Mask (Option 02 Only)

**NOTE.** The trigger mask function is available for Option 02 in the measurement mode (Mode) of the real-time spectrum analysis (Real Time S/A), the modulation analysis (Demod), and the time analysis (Time).

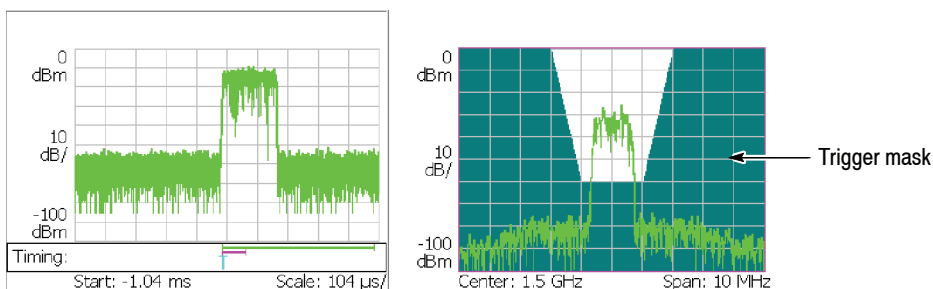
Trigger masks are limited to -60 dBfs.

The trigger mask (shown in Figure 3-119) is an area created on the graticule of the spectrum view (subview in the Demod and Time modes). The trigger occurs when the input signal exits or enters the area.

Real Time S/A mode



Demod and Time modes  
(upper screen)



**Figure 3-119: Trigger mask**

**Mask Creation Menu**

Use the **Trig > Define Mask** menu and the marker (○) to create the mask.

**Select Next Point.** Selects the marker to control. The active marker is displayed in red.

**Set Selected Point X.** Sets the horizontal position of the active marker.

**Set Selected Point Y.** Sets the vertical position of the active marker.

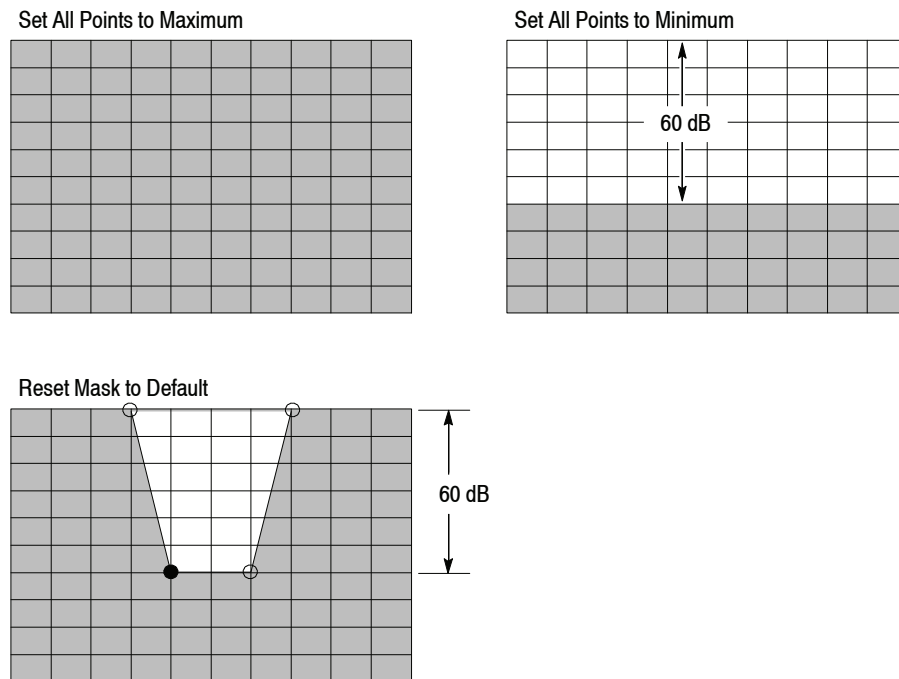
**Delete Selected Point.** Deletes the point at the active marker position.

**Insert New Point.** Inserts the new point halfway between the active marker and the next marker on the right side.

**Set All Points to Maximum.** Fills the area below the maximum line (the reference level). See Figure 3-120.

**Set All Points to Minimum.** Fills the area below the minimum line (the level lower than the reference level by 60 dB). See Figure 3-120.

**Reset Mask to Default.** Displays the default mask. See Figure 3-120.



**Figure 3- 120: Filling operation for creating a mask**

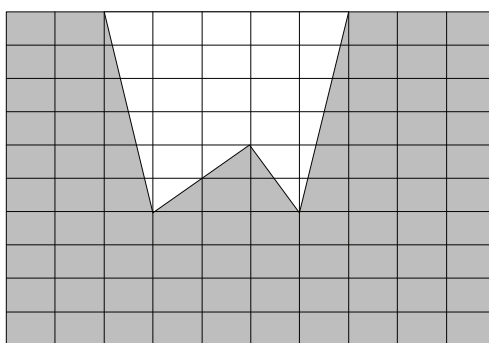
### Conditions for Creating a Mask

The required conditions for creating a trigger mask are as follows:

- Measurement mode (Mode): Real Time S/A, Demod, or Time
- Trigger mode (Trig > Mode): Triggered
- Trigger source (Trig > Source): Freq Mask

### Example of Mask Creation

The procedure shows you how to create the example mask shown in Figure 3-121.



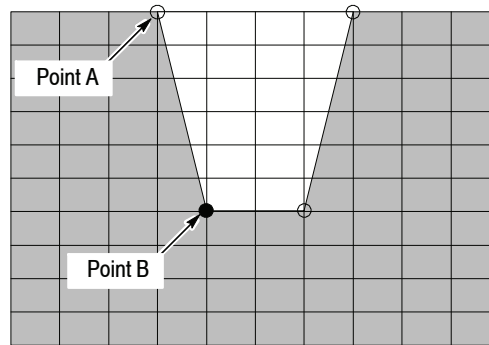
**Figure 3-121: Example mask**

1. Before you start creating a trigger mask, make sure that the requirements listed in *Conditions for Creating a Mask* above are satisfied.
2. Stop data acquisition using the **Run/Stop** key.
3. The trigger mask is created in the spectrum view. To display only the spectrum view on the screen, follow these steps:
  - a. Press the View: **Select** key on the front panel to select the spectrum view.
  - b. Press the View: **Define** key on the front panel.
  - c. Press the **Show Views** side key and select **Single**.
4. Press the **Trig** key on the front panel.
5. Press the **Define Mask...** side key.

The default setting is for the whole area to fill with blue on the graticule.

6. Press the **Reset Mask to Default** side key.

The default mask appears (see Figure 3-122).



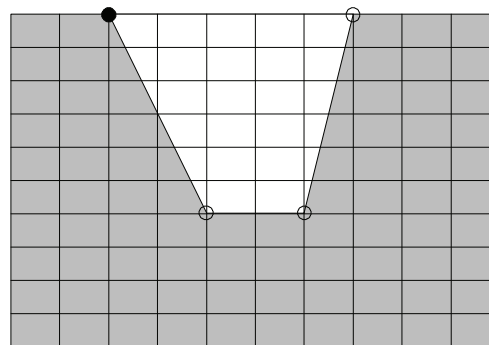
**Figure 3- 122: Default mask**

---

**NOTE.** In the following steps, use the general purpose knob or the numeric input keypad to move the points.

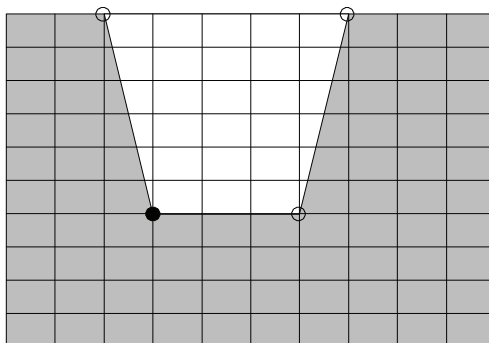
---

7. Change the position of Point A:
  - a. Press the **Select Next Point** side key until Point A is selected.
  - b. Press the **Set Selected Point X** side key and set the horizontal position of Point A to two divisions from the left edge (see Figure 3-123).



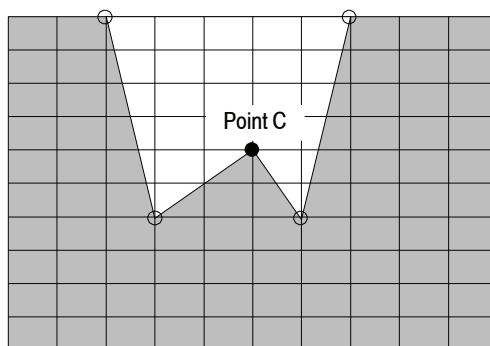
**Figure 3- 123: Changing the position of Point A**

8. Change the position of Point B:
  - a. Press the **Select Next Point** side key to select Point B.
  - b. Press the **Set Selected Point X** side key and set the horizontal position of Point B to three divisions from the left edge (see Figure 3-124).



**Figure 3-124: Changing the position of Point B**

9. Add Point C:
  - a. Press the **Insert New Point** side key with Point B active. The new point appears halfway between Point B and the next point in the right side.
  - b. Press the **Set Selected Point X** side key and set the horizontal position of Point C to five divisions from the left edge.
  - c. Press the **Set Selected Point Y** side key and set the vertical position of Point C to four divisions from the top edge (see Figure 3-125).



**Figure 3-125: Adding Point C**

The trigger mask is stored in the internal memory.

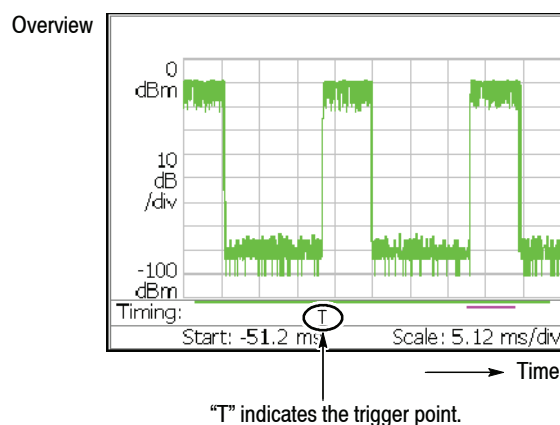
- 10.** If you started with a multi-view display, return using the following steps:
  - a.** Press the View: **Define** key on the front panel.
  - b.** Press the **Show Views** side key and select **Multi**.
- 11.** Set the trigger:
  - a.** Press the **Trig** key on the front panel.
  - b.** Set **Slope** and **Position** appropriately.
- 12.** Start data acquisition using the **Run/Stop** key.

The analyzer stops data acquisition when the trigger event occurs.

The trigger mask is stored in the internal memory for each measurement mode of S/A: Real Time S/A, Demod: Analog Demod, Digital Demod, Time: Transient, and CCDF. When you press the **Preset** key on the front panel, the instrument settings are reset to the default only for the currently active mode.

## Trigger Point Indicator

In the Demod (modulation analysis) and the Time (time analysis) modes, “T” is displayed in the Timing field on the overview. “T” indicates the trigger occurrence point in the Triggered mode, and is used as a reference point for setting the Timing parameters in the Free Run mode. However, “T” indicates the trigger output point when the trigger source is Power and the slope is *Rise and Fall* or *Fall and Rise*, or when the trigger source is Freq Mask.



**Figure 3-126: Trigger point display**

## Indicating Trigger Output

You can use the trigger output to synchronize the analyzer with other instruments. In the Demod (modulation analysis) and Time (time analysis) modes, “O” indicating the trigger output time can be also displayed in the Timing field on the overview. The default status for “O” is off. Follow these steps to display the indicator:

1. Press the **Acquisition/Analysis** key on the front panel.
2. Press the **Output Trigger Indicator** side key to select **On**.

“O” appears on the overview.

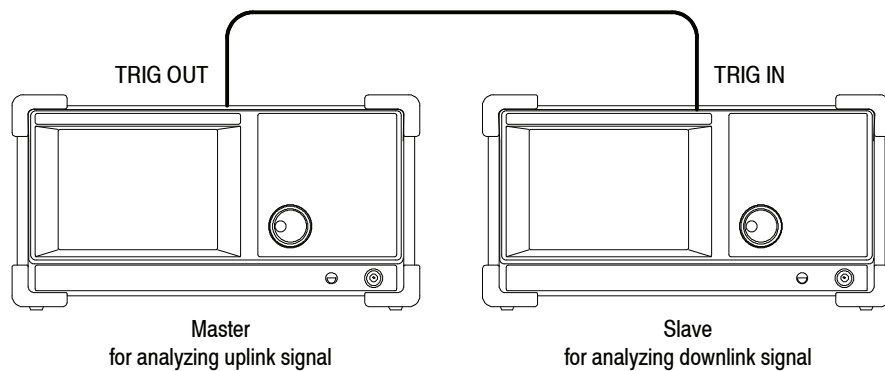
The trigger output timing is determined by the analyzer hardware so that you cannot change it. For the external trigger, the output timing coincides with the trigger occurrence. For other triggers, there is no relationship between the timing of the trigger occurrence and that of the trigger output.

To connect the trigger output to other instruments, use the TRIG OUT connector on the rear panel (see *Rear Panel* on page 2-4). The output specification is: H level >2.0 V, L level <0.4V, and output current <1 mA.

## Synchronous Operation with External Instruments

Use the external trigger input and output connectors on the rear panel (see Figure 2-2 on page 2-4) to synchronize the operation of the analyzer with an external instrument. By synchronizing two or more analyzers, you can acquire multiple signals in different span keeping the time correlation.

Figure 3-127 shows an example of two RSA3408B analyzers performing IMT2000 signal analysis. One analyzer is used as a master to acquire an uplink (or forward link) signal and the other is used as a slave to acquire a downlink (or reverse link) signal. The master trigger output is connected to the slave trigger input. If you trigger the master with a preamble in the first PRACH signal sent from the mobile terminal, then the slave starts data acquisition. You can seamlessly acquire the uplink and downlink communication data in the time-correlated manner for 10 seconds (with 5 MHz span) to analyze them.



**Figure 3- 127: Synchronous operation of two RSA3408B analyzers**



# FFT and RBW

An input signal is converted to the frequency domain data by FFT (Fast Fourier Transform) processing. RBW (Resolution Bandwidth) processing is then applied, for compatibility with measurement data from conventional swept spectrum analyzers (see Figure 3-128). Moreover, the Real Time S/A mode has FFT overlap capability.

---

**NOTE.** You can set the FFT and RBW parameters in the S/A (spectrum analysis) mode. In the Demod (modulation analysis) and Time (time analysis) modes, the number of FFT points is always 1024 and the window is always Blackman-Harris 4B type. However, for the pulse measurements in the Time mode, you can select Nyquist or Blackman-Harris 4B (refer to RBW/FFT Menu on page 3-113). The Demod and Time modes have no RBW process.

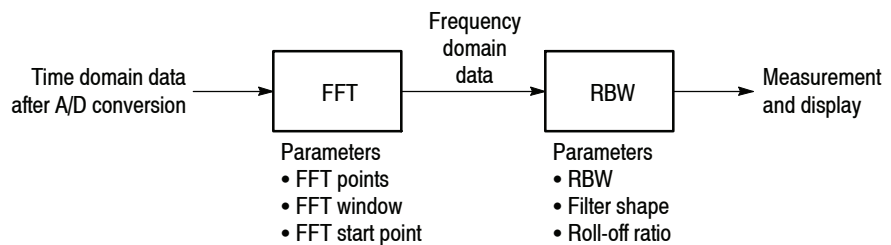
---

The adjustable parameters for FFT are:

- FFT points
- FFT window
- FFT start point (Real Time S/A only)

The adjustable parameters for RBW are:

- Resolution bandwidth (RBW)
- Filter shape
- Roll-off ratio (for the Nyquist or Root Nyquist filter)

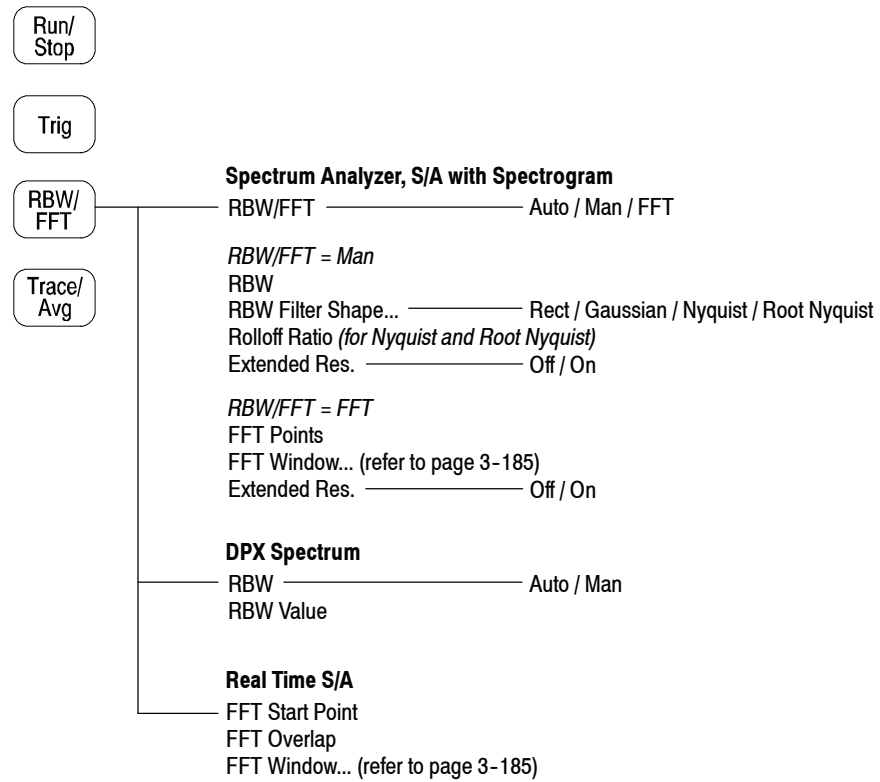


\* FFT points is normally set automatically with the RBW setting.  
RBW is normally set automatically with the span setting.

**Figure 3-128: FFT and RBW process**

## RBW/FFT Menu

Figure 3-129 shows the RBW/FFT menu structure.



**Figure 3- 129: RBW/FFT menu structure**

## Spectrum Analyzer and S/A with Spectrogram Modes

The RBW/FFT menu has the following controls in the Spectrum Analyzer and the S/A with Spectrogram modes:

**RBW/FFT.** Selects whether to set RBW and FFT parameters automatically or manually.

- **Auto.** Sets RBW automatically with the span setting. The filter shape is set to Gaussian.
- **Man.** Sets RBW and selects the filter manually with the **RBW** and **RBW Filter Shape...** side keys.
- **FFT.** Sets the FFT points and window manually with the **FFT Points** and **FFT Window...** side keys. The result of FFT processing is displayed as is, without RBW processing.

### When RBW/FFT is set to Man.

**RBW.** Sets RBW when Man is selected in RBW/FFT.

Range: 2 kHz to 2 MHz (the default is 80 kHz)

**RBW Filter Shape...** Selects the filter from the following four types when RBW/FFT is set to Man:

- Rect (Rectangular)
- Gaussian (default)
- Nyquist
- Root Nyquist

**Rolloff Ratio.** Enters roll-off ratio when RBW Filter Shape is set to Nyquist or Root Nyquist. Range: 0.0001 to 1 (the default is 0.5)

**Extended Res.** The FFT point number is normally limited internally. You can eliminate the limit using the On setting. Refer to *Limit on the FFT Points* on page 3-184 for detail.

---

**NOTE.** *It is recommended to keep Extended Res. Off as its default condition.*

*In the spectrum emission mask measurement, the menu items of RBW Filter Shape... and Rolloff Ratio are available. The RBW is set for each zone. Refer to page 3-14 for details.*

---

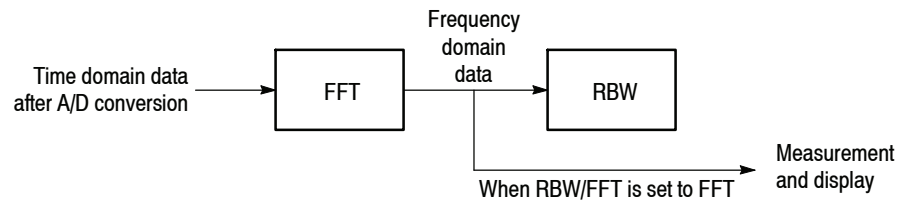
**When RBW/FFT is set to FFT.**

**FFT Points.** Selects FFT sample point numbers per frame when RBW/FFT is set to FFT. Range: 64 to 65536 in increments of  $2^n$ . Higher numbers provide higher resolution, and lower numbers provide faster measurements.

**FFT Window...** Selects the FFT window (window function) when RBW/FFT is set to FFT. For the window type, refer to Table 3-31 on page 3-187. The default is Blackman-Harris 4B.

**Extended Res.** Same as when RBW/FFT is set to Man.

When RBW/FFT is set to FFT, the waveform without RBW processing is displayed on screen (see Figure 3-130).



**Figure 3- 130: Process flow when RBW/FFT = FFT**

**DPX Spectrum Mode**

In the DPX spectrum mode, FFT is performed by the dedicated processor and the parameters cannot be controlled. The RBW has the following controls:

**RBW.** Selects whether to set RBW automatically or manually.

- **Auto.** Sets RBW automatically by the span setting using the Gaussian filter.
- **Manual.** Sets RBW manually using the **RBW Value** side key.

**RBW Value.** Sets the RBW when you select Manual in the **RBW** side key. Range: 1 to 10% of the span setting, rounded to the nearest settable value.

**Overlapped FFT  
(Real Time S/A Mode)**

The Real Time S/A mode has FFT overlap capability that computes FFT while overlapping 1024-point FFT frames by a specified number of samples to enhance time resolution. The RBW/FFT menu contains the following controls:

---

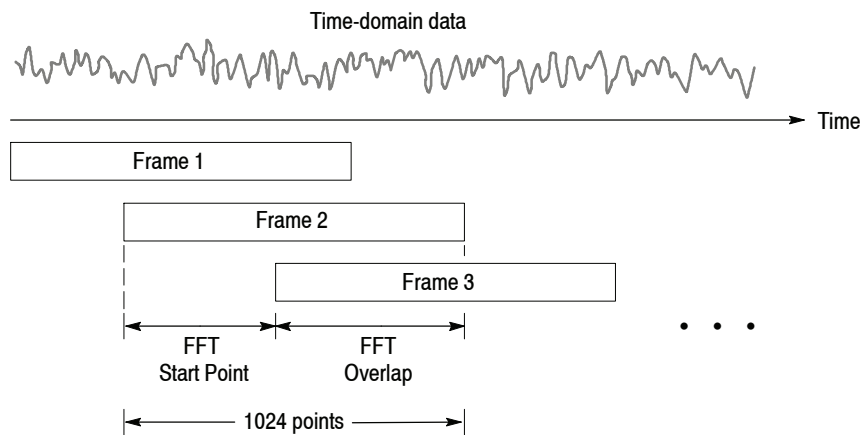
**NOTE.** *In the Real Time S/A mode, the FFT points is always 1024 and FFT-processed data does not go through RBW process (see Figure 3-130 on page 3-182).*

---

**FFT Start Point.** Sets the start point of the 1024-point FFT frame by the number of samples from the previous frame (see Figure 3-131).  
Range: 1 to 1024 samples in increments of  $2^n$ .

**FFT Overlap.** Displays the amount of overlap between frames used to calculate consecutive FFTs (see Figure 3-131). Not settable. The sum of FFT Overlap and FFT Start Point is always 1024.

**FFT Window...** Selects the FFT window (window function).  
For the window type, refer to Table 3-31 on page 3-187.  
The default is Blackman-Harris 4B.



**Figure 3-131: FFT overlap**

## FFT Points

The number of FFT points is normally set automatically by the RBW setting. The value is basically 1024. It can be set in powers of 2 from 64 to 8192. This value is the number of points in one physical frame in the time and frequency domains. If the number of points is reduced, the frame period is shortened and more spectrum variations can be observed in the spectrogram view. If the number of the points is increased, S/N ratio and frequency resolution are improved.

---

**NOTE.** Setting the number of FFT points greater than the limit (8192) causes the noise floor to go down and occasionally causes spurious signals to appear (see Figure 3-132). It cannot be determined whether the spurious signal comes from the input signal or the instrument.

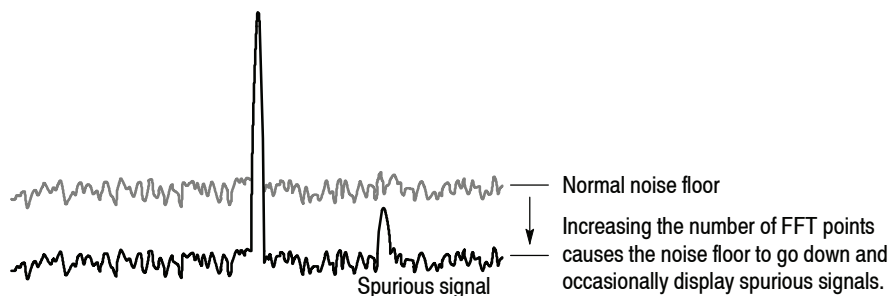
---

### Limit on the FFT Points

The number of FFT points is normally limited to 8192 internally to avoid displaying internally-generated spurious signals. However, you can remove this restriction and set the number of FFT points up to 65536 using the following steps:

1. Display the measurement signal on the screen.
2. Press the **RBW/FFT** key on the front panel.
3. Press the **RBW/FFT** side key to select **FFT**.
4. Press the **Extended Res.** side key to select **On**.
5. Press the **FFT Points** side key and select the value with the general purpose knob. The range extends up to 65536 in powers of 2.

The waveform after FFT is displayed with the selected number of points.



**Figure 3- 132: Generating spurious signals by increasing the number of FFT points**

## FFT Window

The phase of the waveform processed by FFT analysis is assumed to start at zero and end at zero, so the waveform data is an exact multiple of one cycle. If the phase at the start and end of the waveform are equal, there is no unnatural discontinuity in the signal waveform, and the frequency and the amplitude can be accurately calculated.

If the waveform data is not an exact multiple of one cycle, the amplitudes at the start and end of the waveform will be different. There will be a discontinuity of the waveform between the beginning and end, and a high-frequency transient phenomenon occurs. When this happens, inaccurate frequency information is recorded in the frequency domain.

If a window function is applied to the waveform, the start and end amplitudes will be closer, and the discontinuity is reduced. The frequency components that are calculated from the signal by FFT also become more accurate. Choose the FFT window according to your objective: accurate measurement of the frequency or accurate measurement of the amplitude of the frequency components.

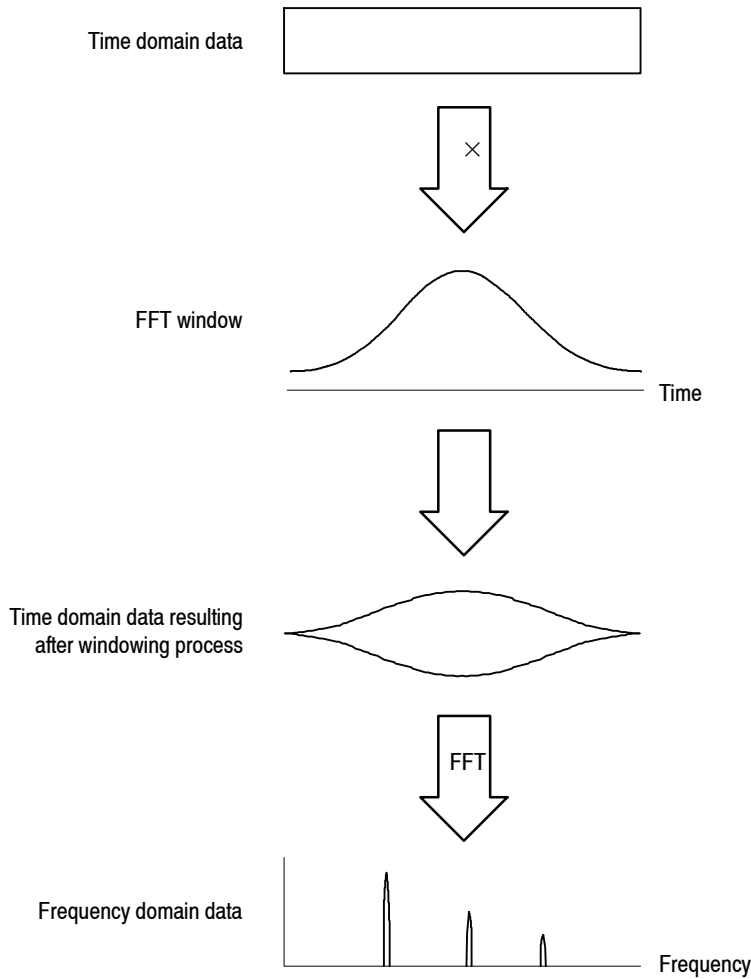
### Window Characteristics

In FFT windows, the frequency resolution is inversely proportional to the amplitude accuracy. Select a proper window according to the measurement items and characteristics of the signal source. Table 3-30 shows characteristics and usages of major windows.

**Table 3-30: Characteristics and usage of FFT windows**

FFT window	Characteristics	Usage
Rectangular	<ul style="list-style-type: none"> <li>■ Suitable for frequency measurement but not suitable for amplitude measurement.</li> <li>■ Same result as measurement without a window.</li> </ul>	<ul style="list-style-type: none"> <li>■ Transient phenomenon or burst; signal levels before and after the event are roughly same.</li> <li>■ Sinusoidal wave with little amplitude variation and stable frequency.</li> <li>■ Wide bandwidth irregular noise; spectrum changes slowly.</li> </ul>
Hamming, Hanning	<ul style="list-style-type: none"> <li>■ Suitable for frequency measurement.</li> <li>■ Inferior in accuracy of amplitude to the rectangular window.</li> <li>■ Frequency resolution of Hamming is slightly superior to that of Hanning.</li> </ul>	<ul style="list-style-type: none"> <li>■ Sinusoidal wave.</li> <li>■ Repeating narrow bandwidth irregular noise.</li> <li>■ Transient phenomenon or burst; signal levels before and after the event are remarkably different.</li> </ul>
Blackman-Harris	<ul style="list-style-type: none"> <li>■ Suitable for amplitude measurement but not suitable for frequency measurement.</li> </ul>	<ul style="list-style-type: none"> <li>■ Signal that has one-frequency ruling when a high order harmonic is detected.</li> </ul>

Figure 3-133 outlines how frequency domain data is generated from time domain data. The FFT window serves as a bandpass filter between time and frequency domain data. The FFT frequency resolution and amplitude accuracy of each frequency component depends on the window shape.



**Figure 3- 133: Windowing process of time domain data**

Generally, window frequency resolution is inversely proportional to the accuracy of measuring amplitude levels. For ordinal measurements, select the window capable of separating the desired frequency component. Such a window maximizes the accuracy of measuring amplitude levels and minimizes leakage error while separating each frequency component.



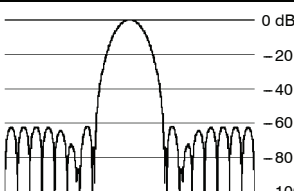
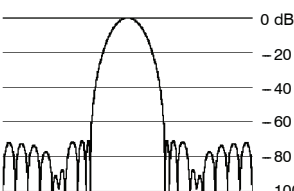
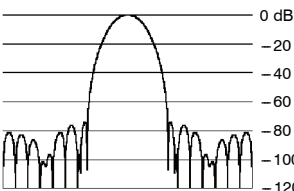
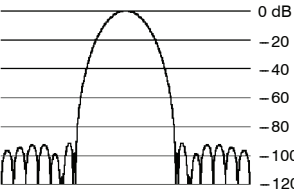
To select the proper window, first select the rectangular window, then sequentially switch to a window with less frequency resolution, such as Hamming, Hanning, or Blackman-Harris. Use the last window that still passes the frequency component to be separated. Suitable frequency resolution and amplitude accuracy are obtained by using the window immediately before the one from which the frequency component cannot be separated.

Consider the following characteristics when selecting a window for your purpose:

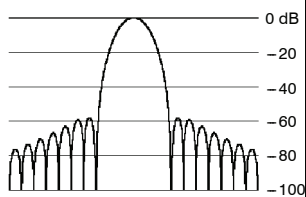
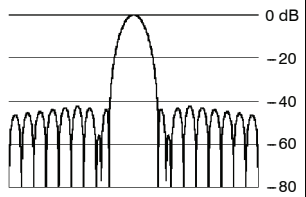
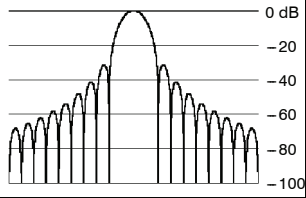
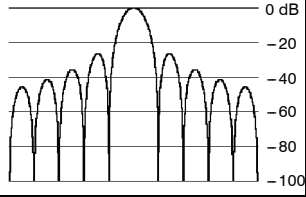
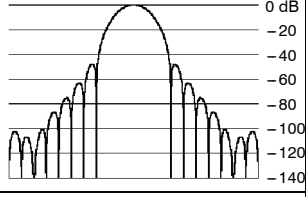
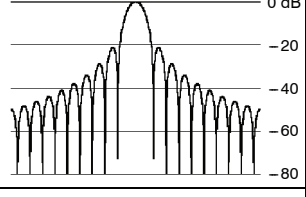
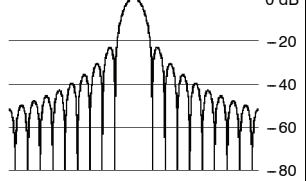
- Frequency resolution is improved by reducing the width of the main lobe window.
- Accuracy of the amplitude levels of frequency components is improved by reducing side lobe level relative to the main lobe.

**Window Type** The analyzer supports a total of 15 windows, including the major windows mentioned previously (refer to Table 3-31).

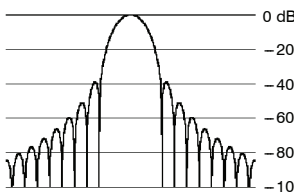
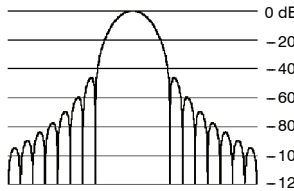
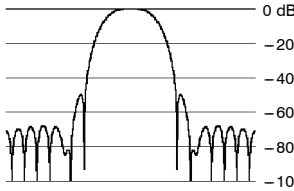
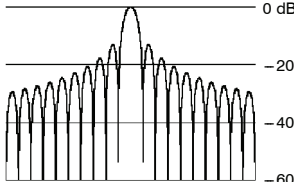
**Table 3-31: FFT window and bandpass filter**

Window	Bandpass filter	-3 dB bandwidth	Maximum side lobe	Equivalent noise bandwidth
Blackman-Harris 3 sample A type		1.53	-62 dB	1.61075
Blackman-Harris 3 sample B type		1.622	-71 dB	1.708538
Blackman-Harris 4 sample A type		1.698	-76 dB	1.793948
Blackman-Harris 4 sample B type (Default)		1.898	-92 dB	2.004353

**Table 3-31: FFT window and bandpass filter (Cont.)**

Window	Bandpass filter	-3 dB bandwidth	Maximum side lobe	Equivalent noise bandwidth
Blackman		1.642	-58 dB	1.726757
Hamming		1.302	-43 dB	1.362826
Hanning		1.438	-32 dB	1.5
Parzen		1.27	-27 dB	1.330747
Rosenfield		1.814	-48 dB	1.90989
Welch		1.15	-21 dB	1.197677
Sine Lobe		1.186	-23 dB	1.233702

**Table 3-31: FFT window and bandpass filter (Cont.)**

Window	Bandpass filter	- 3 dB bandwidth	Maximum side lobe	Equivalent noise bandwidth
Sine Cubed		1.654	-39 dB	1.734891
Sine to the 4 <sup>th</sup>		1.85	-47 dB	1.944444
Flat Top		3.182	-51 dB	3.196927
Rectangular		0.886	-13 dB	1



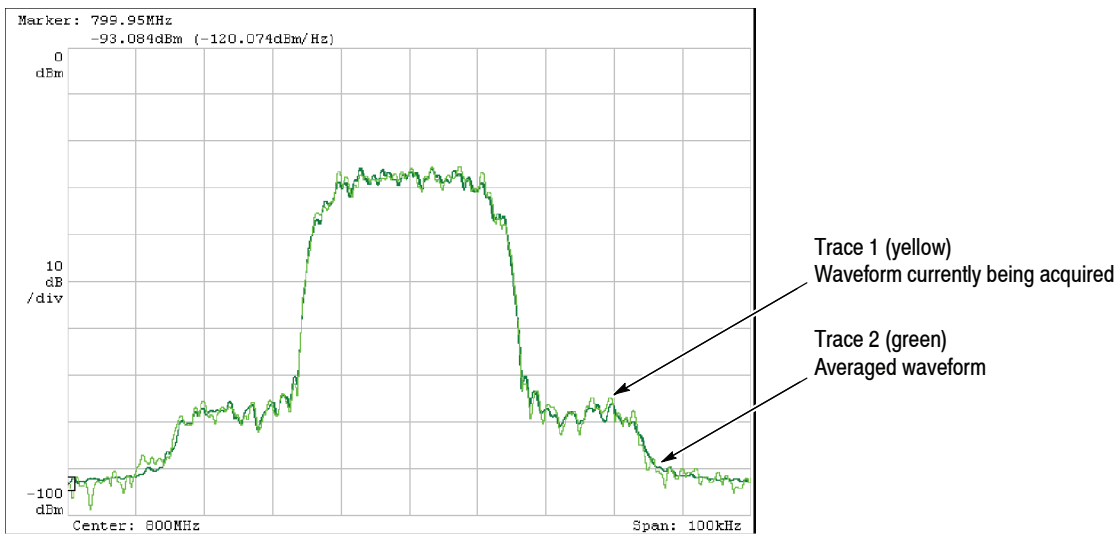
# Trace Comparison Display and Average Function

In the spectrum analysis (S/A mode), you can display two traces concurrently on screen. Trace 1 is displayed in yellow and Trace 2 in green (see Figure 3-134). The trace can be averaged for noise reduction. You can save waveform data in files, and load them as Trace 1 or 2.

---

**NOTE.** Trace comparison display is available in the spectrum analysis (S/A) mode except Real Time S/A.

---



**Figure 3-134: Comparison display of Trace 1 and 2**

The main topics in this section are:

- Trace/Avg menu
- Displaying Trace 1 and 2
- Averaging waveform
- Saving/Loading waveform data
- Trace compression display

## Trace/Avg Menu

Controls the trace display and averaging. The menu items vary according to the measurement mode: S/A, Demod, or Time.

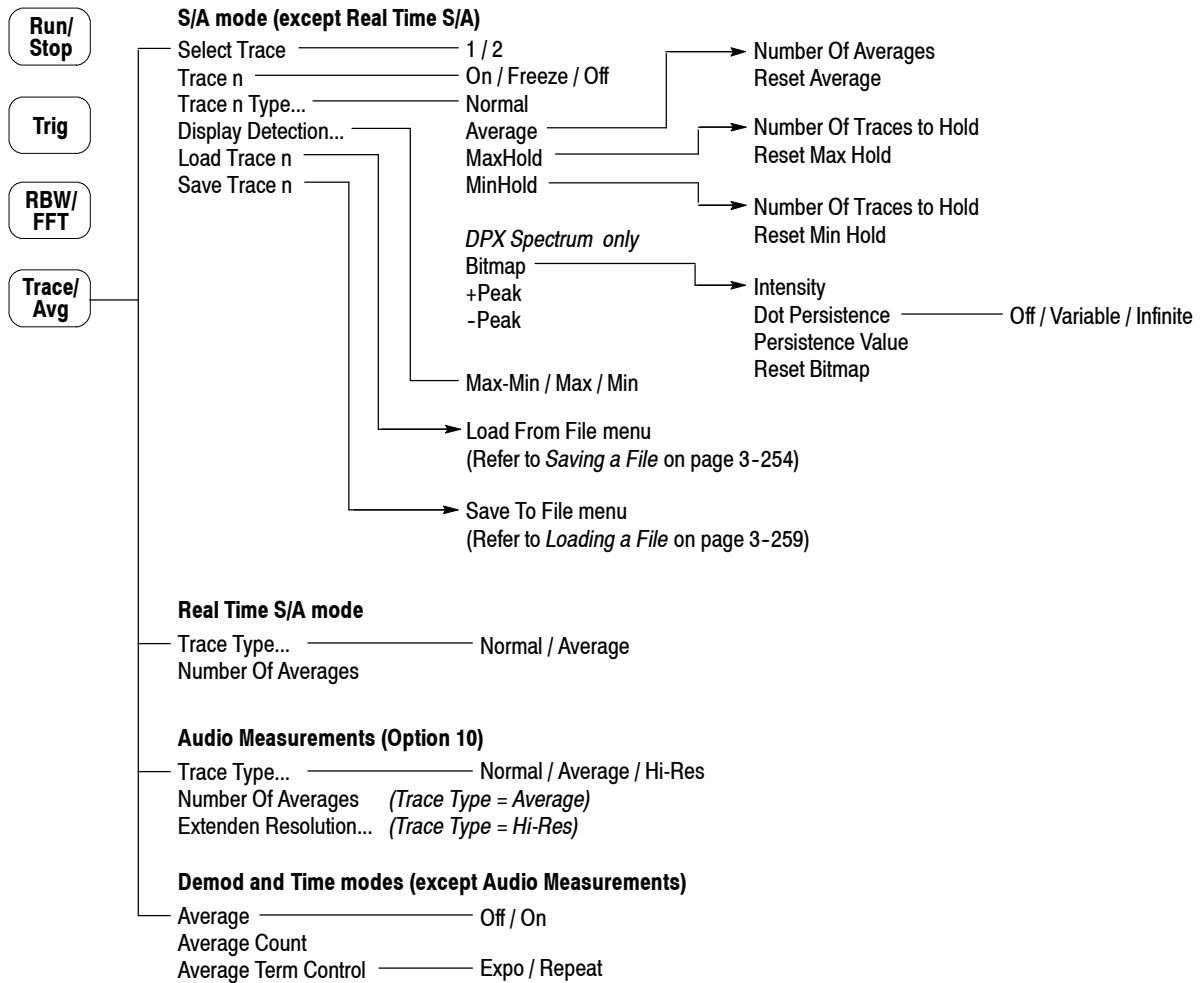


Figure 3- 135: Trace/Avg menu structure

**S/A Mode  
(Except Real Time S/A)**

The Trace/Avg menu has the following controls in the S/A mode (except Real Time S/A).

**Select Trace.** Selects the trace to control: trace 1 or 2.

**Trace 1/2.** Controls the selected trace.

- **On.** Turns on the selected trace.
- **Freeze.** Freezes display of the selected trace.
- **Off.** Turns off the selected trace.

**Trace 1/2 Type...** Selects the type of processing for the selected trace. This menu item appears when **Trace 1/2** is set to **On**.

**Table 3-32: Trace type**

Trace type	Description
Normal <sup>1</sup>	Displays normal spectrum without averaging.
Average	<i>DPX spectrum.</i> Computes the average amplitude of the spectrum points within each frequency bin to create a trace for each screen update, and then average the traces with the number set in the <b>Number Of Averages</b> side key to display.  <i>Other than DPX spectrum.</i> Averages the traces with the number set in the <b>Number Of Averages</b> side key.
Max Hold	Holds the maximum level at each frequency. Pressing the <b>Reset MaxHold</b> side key restarts the process.
Min Hold	Holds the minimum level at each frequency. Pressing the <b>Reset MinHold</b> side key restarts the process.
Bitmap <sup>2</sup>	Displays the density of acquired data. The number of data points acquired at each pixel is indicated by color.
+Peak <sup>2</sup>	Displays the maximum values acquired in each screen update.
-Peak <sup>2</sup>	Displays the minimum values acquired in each screen update.

<sup>1</sup> Available in the S/A mode except DPX spectrum.

<sup>2</sup> DPX spectrum only.

**Number Of Averages.** Specifies how many traces are accumulated to create the averaged value. Setting range: 1 to 100,000 (default: 20).

Averaging is controlled in two ways as shown in Table 3-33.

**Table 3-33: Averaging method**

Data acquisition	Average type	Number of Averages
Free run (Continuous mode only)	Exponential RMS	Continues the average with an exponential weighting applied to old values using Number of Averages as the weighting factor.
Triggered and Single mode	RMS	Averages traces accumulating up to Number of Averages, then stops the acquisition until the next trigger event occurs.

**Intensity.** *DPX spectrum only.* Sets the display intensity for the Bitmap trace. An increased intensity level allows a single, short event to be seen. This also allows the effect of variable persistence to be seen on infrequent events.

Range: 1 to 100% (default: 25%)

**Dot Persistence.** *DPX spectrum only.*

Selects the persistence mode for the Bitmap trace.

- **Off.** Turns off the persistence mode.  
All points are reset every screen update.
- **Variable.** Selects the variable persistence mode.  
Set a persistence time, that is how long a point in the display is visible before fading, using the **Persistence Value** side key.
- **Infinite.** Selects the infinite persistence mode that prevents a point in the display from fading. Once a point in the display has been written to, it will remain visible indefinitely.

**Persistence Value.** *DPX spectrum only.* Sets the persistence time for the variable persistence mode. Range: 1 to 1000 (no unit, default: 10).

**Reset Average.** *Available when Trace 1 or 2 Type is set to Average.*

Causes trace accumulation to start over for the average process.

**Reset MaxHold.** *Available when Trace 1 or 2 Type is set to MaxHold.*

Causes trace accumulation to start over for the Max Hold process.

**Reset MinHold.** *Available when Trace 1 or 2 Type is set to MinHold.*

Causes trace accumulation to start over for the Min Hold process.

**Reset Bitmap.** *Available when Trace 1 or 2 Type is set to Bitmap.*

Causes trace accumulation to start over for the Bitmap display.



**Display Detection...** *Available in the S/A mode except DPX spectrum.*

The bin data is compressed in the display because the number of pixels in the horizontal direction of the screen is generally smaller than the number of bins in the FFT. Display Detection selects the method to be used for decimating traces to fit the available space. It is related only to the decimation of displayed data.

- **Max-Min.** Draws a line connecting the maximum and the minimum values of data corresponding to each pixel.
- **Max.** Displays the maximum value of data corresponding to each pixel.
- **Min.** Displays the minimum value of data corresponding to each pixel.

The analyzer performs RMS detection using the linear A/D converter regardless of the Display Detection setting.

Refer to page 3-200 for details on compression of waveform display data.

**Load Trace 1/2.** Loads trace data from a file.

**Save Trace 1/2.** Saves trace data to a file.

Refer to *File Operations* on page 3-251 for details on saving/loading data to/from a file.

**Real Time S/A Mode**

The Trace/Avg menu has the following controls in the Real Time S/A mode.

**Trace Type...** Selects the trace type from the following two:

- **Normal.** Displays spectrum normally.
- **Average.** Displays averaged spectrum trace. Use the **Number Of Averages** side key to specify the average count. In each acquisition of a block of data, the analyzer takes traces as many as specified with Number Of Averages from the trigger point to perform the RMS averaging.

**Number Of Averages.** Specifies the average count.  
Setting range: 1 to 1000 (default: 20).

**Audio Measurements  
(Option 10 Only)**

The Trace/Avg menu has the following controls in the audio measurements.

**Trace Type...** Selects the trace type from the following three:

- **Normal.** Displays spectrum normally.
- **Average.** Displays averaged spectrum trace. Use the **Number Of Averages** side key to specify the average count. For each acquisition of a block of data, the analyzer takes traces as many as specified with Number Of Averages from the trigger point to perform the RMS averaging.

- **Hi-Res.** Selects the high-resolution FFT which allows you to set the number of FFT points from the basic 1024 (1024×1) up to 65536 (1024×64). Use the **Extended Resolution...** side key to specify the number of points that are FFT-processed from the trigger point.

**Number Of Averages.** Specifies the average count for the Trace Type of Average. Setting range: 1 to 1000 (default: 20).

**Extended Resolution...** Specifies the number of FFT points for the Trace Type of Hi-Res: ×1 (=1024), ×2, ×4, ×8, ×16, ×32, or ×64 (=65536, default).

### Demod and Time Modes (Except Audio Measure- ments)

The Trace/Avg menu has the following controls in the Demod and Time modes.

**Average.** Determines whether or not to perform averaging (On/Off).

---

**NOTE.** For Demod and Time modes, data is always acquired without averaging.

---

**Average Count.** Specifies the number of measurements to combine. Setting range: 1 to 10000 (default: 20).

**Average Term Control.** Specifies the action when more than Average Count measurement results are generated.

- **Expo.** Continues the average with an exponential weighting applied to old values.
- **Repeat.** Clears average data and counter, and restarts the average process.

## Displaying Trace 1 and 2

In the S/A mode (except Real Time S/A), only Trace 1 (yellow) is displayed by default. Use the following steps to select Trace 1 and 2:

1. Press the **Trace/Avg** key on the front panel.
2. Press the **Select Trace** side key to select the trace (1 or 2) to be controlled. For example, to control Trace 2, select **2**.
3. Press the **Trace 1** (or **2**) side key to select the display method: On, Freeze, or OFF.
4. Press the **Trace 1** (or **2**) **Type...** side key to select the trace type: Normal, Average, MaxHold or MinHold (refer to *Trace 1/2 Type* on page 3-193).
5. Repeat steps 2 through 4 for Trace 1 and 2.

## Averaging the Waveform

The averaging technique is generally used to average and reduce the noise of the waveform. The average function includes the peak hold which maintains the maximum and minimum values as well as the averaging process.

**Average Type** There are four averaging types as follows, where these variables are used:

$X(p)_n$ : Display data for the  $n^{\text{th}}$  frame  
 $x(p)_n$ : Active data for the  $n^{\text{th}}$  frame  
 $P$ : Frame point  
 $N$ : Value of “Number of Averages”

**RMS.** Root-mean-square. Used when acquiring data in single mode.  $N$  frames average, then the acquisition stops.

$$\begin{aligned} X(p)_n &= x(p)_n && \text{for } n = 1 \\ X(p)_n &= \frac{(n-1) \times X(p)_{n-1} + x(p)_n}{n} && \text{for } 2 \leq n \leq N \\ X(p)_n &= x(p)_N && \text{for } n > N \end{aligned}$$

**Exponential RMS.** Exponential root-mean-square. Used when acquiring data in continuous mode. Continuous averaging weights older sweeps so that they have a progressively smaller effect on the average.

$$\begin{aligned} X(p)_n &= x(p)_n && \text{for } n = 1 \\ X(p)_n &= \frac{(n-1) \times X(p)_{n-1} + x(p)_n}{n} && \text{for } 2 \leq n \leq N \\ X(p)_n &= \frac{(N-1) \times X(p)_{n-1} + x(p)_n}{N} && \text{for } n > N \end{aligned}$$

**Max Hold.** Displays only the maximum value at each data point.

$$\begin{aligned} X(p)_n &= x(p)_n && \text{for } n = 1 \\ X(p)_n &= \max(X(p)_{n-1}, x(p)_n) && \text{for } n \geq 2 \end{aligned}$$

**Min Hold.** Displays only the minimum value at each data point.

$$\begin{aligned} X(p)_n &= x(p)_n && \text{for } n = 1 \\ X(p)_n &= \min(X(p)_{n-1}, x(p)_n) && \text{for } n \geq 2 \end{aligned}$$

### Averaging Example

This section shows how to use averaging and the compared display in the S/A mode (except Real Time S/A).

#### Performing Averaging. Average and display Trace 1.

1. Display the spectrum of the measurement signal.
2. Pause data acquisition to simplify the operation. If you are acquiring the data in the continuous mode, press the **Run/Stop** key to stop the acquisition.
3. Press the **Trace/Avg** key on the front panel.
4. Press the **Select Trace** side key to select **1**.
5. Press the **Trace 1 Type** side key and select **Average** for example.
6. Press the **Number of Averages** side key and set **64** for example.
7. Press the **Run/Stop** key to acquire data.
8. Press the **Reset Average** side key to perform averaging again.

The averaged waveform is displayed on screen (see Figure 3-136). The average count is indicated in the right top portion of the screen.

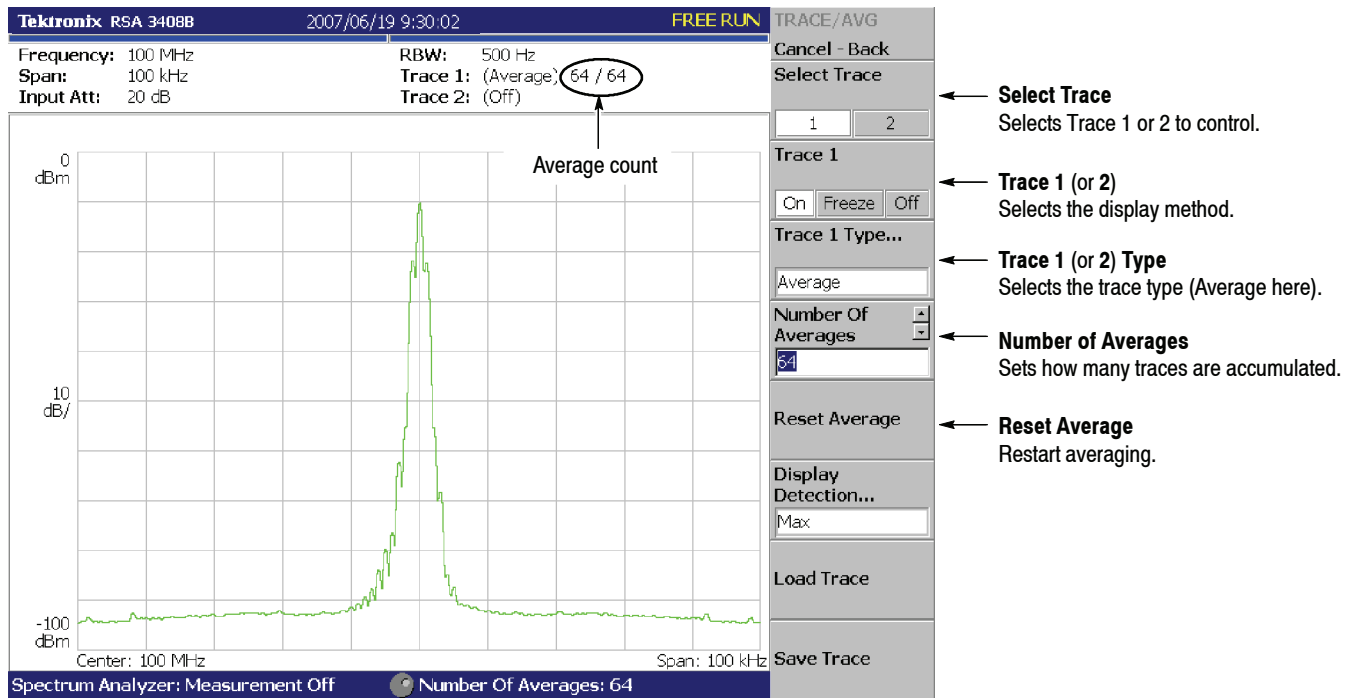


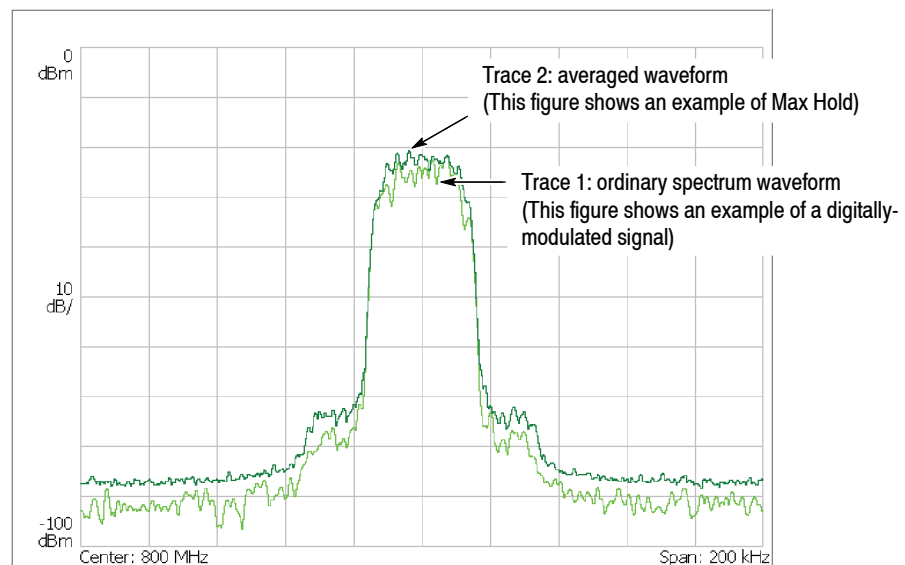
Figure 3- 136: Displaying an averaged waveform

**Compared Display.** Display Trace 1 as a normal spectrum and Trace 2 as the averaged waveform concurrently, and compare them.

1. Display the spectrum of the measurement signal.
2. Press the **Trace/Avg** key on the front panel.
3. Display Trace 1 as a normal spectrum.
  - a. Press the **Select Trace** side key to select 1.
  - b. Press the **Trace 1 Type...** side key and select **Normal**.
4. Display Trace 2 as the averaged waveform.
  - a. Press the **Select Trace** side key to select 2.
  - b. Press the **Trace 2 Type...** side key and select **Average, Max Hold** or **Min Hold**.

The waveform currently being acquired (trace 1 in yellow) and the averaged waveform (trace 2 in green) are displayed together.

Figure 3-137 shows an example of the concurrent display of the ordinal spectrum and its Max Hold waveform.



**Figure 3-137: Compared display**

## Saving/Loading Waveform Data

You can save and load waveform data using the Save/Load menu. For details, refer to *File Operations* on page 3-251.

In the S/A mode (except Real Time S/A), the Trace/Avg menu is also available for saving and loading data. You can load the saved waveform as Trace 1 or 2. Follow these steps:

### Saving a Trace

1. Press the **Trace/Avg** key on the front panel.
2. Press the **Select Trace** side key to select Trace 1 or 2.
3. Press the **Save Trace** side key and select the destination file. For information about file operations, refer to page 3-251 and subsequent pages.

### Loading a Trace

1. Press the **Trace/Avg** key on the front panel.
2. Press the **Select Trace** side key to select Trace 1 or 2.
3. Press the **Load Trace** side key and select the source file. (The trace is automatically frozen.) For information about file operations, refer to page 3-251 and subsequent pages.

Trace 1 or 2 loaded switches to Freeze automatically.

## Trace Compression

Although waveform data are acquired as 1024 points per frame, the acquired data are displayed after being compressed due to the limitation in the number of pixels on screen. The compression method and the procedure to select the method are described in the following section.

### Relation between Frame, Bin, and Pixel

One frame contains 1024 FFT output points. Part of the data in the frame is invalid for the calculation. The analyzer discards invalid data and displays only valid data. Valid data are placed into “bins”. The number of bins depends on the span, as shown in Table 3-34.

**Table 3-34: Number of bins (FFT points: 1024)**

Span	Number of bins
20 MHz or less	801
36 MHz	721
40 MHz (Baseband only)	801

The number of bins is valid in all modes except Scalar mode. The number of bins is meaningless in Scalar mode because it uses several physical frames to display data. Generally, the following calculations are used:

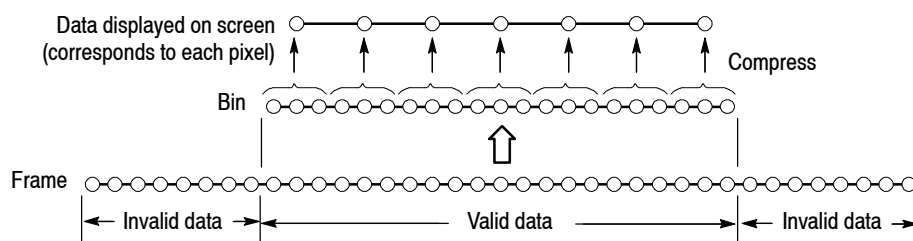
$$\text{Frequency bandwidth of one bin} = (\text{Sampling rate}) / (\text{Number of FFT points})$$

$$\text{Number of bins} = (\text{Specified span}) / (\text{Frequency bandwidth of one bin}) + 1$$

The sampling rate varies depending on span. Refer to *Specifications* in the *RSA3408B Technical Reference* for more details.

### Compression Method

Generally, because the number of horizontal pixels on screen is smaller than the number of bins, bin data is compressed according to the number of pixels on screen when they are displayed (see Figure 3-138).



**Figure 3-138: Relationships between frame, bin, and pixel**

There are three types of compression methods:  
Max, Min, and Max-Min (see Figure 3-139 on page 3-202).

### Selecting Compression Method

Max is the most commonly used compression method. Max-Min is used in the time domain waveform display in the DEMOD mode. (The compression method is always set to Max on the spectrogram view in three-dimensional modes.)

You can select the compression method using the following steps in S/A mode:

1. Press the **Trace/Avg** key on the front panel.
2. Press the **Select Trace** side key to select Trace 1 or 2.
3. Press the **Display Detection...** side key and select **Max**, **Min**, or **Max-Min**.

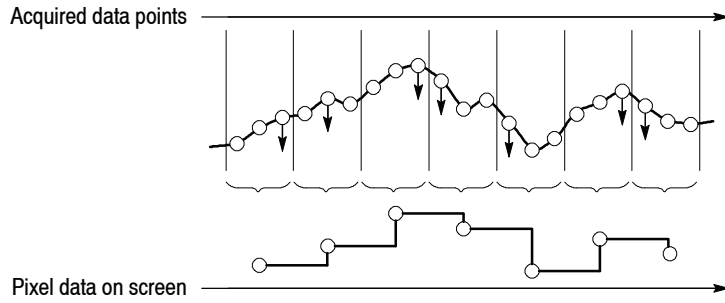
---

**NOTE.** *Display Detection determines how to deal with data between spectrum display points. The analyzer performs RMS detection using the linear A/D converter regardless of the Display Detection setting.*

---

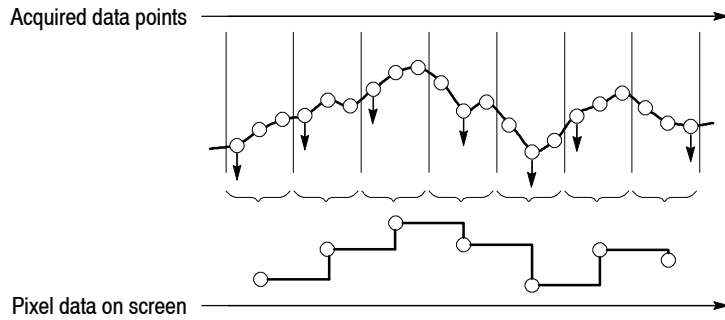
**Max**

Acquires the maximum value of data points corresponding to each pixel.



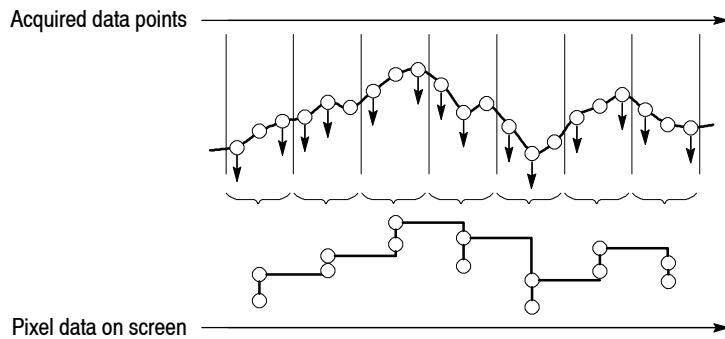
**Min**

Acquires the minimum value of data points corresponding to each pixel.



**Max-Min**

Acquires the minimum and maximum values of data points corresponding to each pixel.



**Figure 3- 139: Compression method for displaying the waveform**



# Setting Views

This section describes scaling and formatting for the following view types:

- Spectrum view
- DPX Spectrum view
- Spectrogram view
- Time domain view
- CCDF view

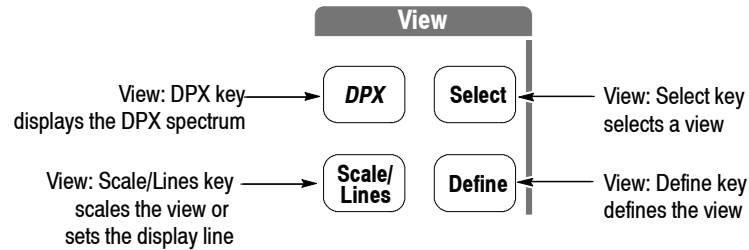
*For Option 21 only:*

- Constellation view
- EVM view
- Symbol table
- Eye diagram
- AM/AM view
- AM/PM view
- PDF view
- Noisogram view

For information on views specific to the other optional analyses, refer to each user manual.

## View Menu

Use the following View keys on the front panel to scale and format views:



**DPX** Displays the DPX spectrum view.

**Select** Selects a view when displaying two or three views on screen. The view switches each time you press this key. The selected view is surrounded with a white box.

**Define** Selects a view style, format, and content. The menu items depend on the measurement. Refer to each measurement description.

**Scale/Lines** Press this key and then select one of the following items:

- **View Scale...** Sets the horizontal and vertical axes for the view selected using the **Select** key.
- **View Lines...** Sets the display line for the view selected using the **Select** key. Refer to *Display Line* on page 3-227 for the details.

## Basic Procedure

The following procedures set the scale or format the view using the View keys in single view or multiple views.

**Procedure for Single View.** When you are displaying one view on screen, press View: **Scale/Lines** > **View Scale...** and set the scale. For the Scale menu of a specific view, refer to the following pages.

**Procedure for Multiple Views.** When you are displaying multiple views on the screen, follow these steps:

1. Select a view by pressing the View: **Select** key.  
The selected view is surrounded by a white frame.
2. If necessary, change a multiple view display to a single view display:
  - a. Press the View: **Define** key.
  - b. Press the **Show Views** side key to select **Single**.  
Only the selected view will be displayed.
3. Set the scale by pressing View: **Scale/Lines** > **View Scale...**
4. If necessary, return to the multiple view display:
  - a. Press the View: **Define** key.
  - b. Press the **Show Views** side key to select **Multi**.

Refer to page 3-38 for information about changing the overview and the subview using the Define menu.

## Spectrum View Setting

The spectrum view is the frequency domain representation of a signal. It indicates frequency along the horizontal axis and power along the vertical axis.

### View: Scale Menu

The Scale menu for the spectrum view contains the following controls (see Figure 3-140):

**Auto Scale.** Sets the start value and the scale of the vertical axis automatically to fit the waveform to the screen.

**Horizontal Scale.** Sets the range of the horizontal axis.

**Horizontal Start.** Sets the minimum value (left edge) of the horizontal axis.

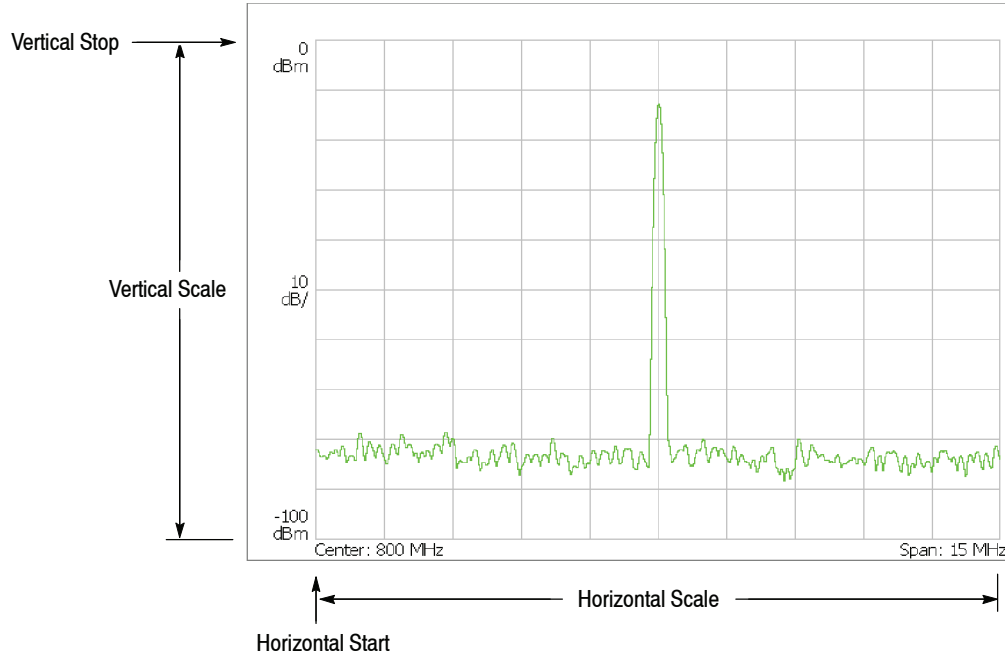
**Vertical Scale.** Sets the range of the vertical axis.

Range: 100 $\mu$  to 100 dB (default: 100 dB).

**Vertical Stop.** Sets the maximum value (top) of the vertical axis.

Range: -100 to 100 dBm (default: 0 dBm).

**Full Scale.** Sets the scale of the vertical axis to the default full-scale value.



**Figure 3-140: Setting the scale in spectrum view**

## DPX Spectrum View Setting

The DPX Spectrum indicates frequency along the horizontal axis and power along the vertical axis. The Bitmap trace displays the density of acquired data by color grading.

**Scale Menu** The Scale menu for the DPX spectrum view contains the following controls (see Figure 3-141):

**Vertical Scale.** Sets the full-scale of the vertical axis.  
Setting value: 20 or 100 dB (default: 100 dB).

**Vertical Stop.** Sets the maximum value (top) of the vertical axis.  
Range: -100 to 100 dBm (default: 0 dBm).

**Bitmap Color.** Selects the color scheme used for the Bitmap trace.

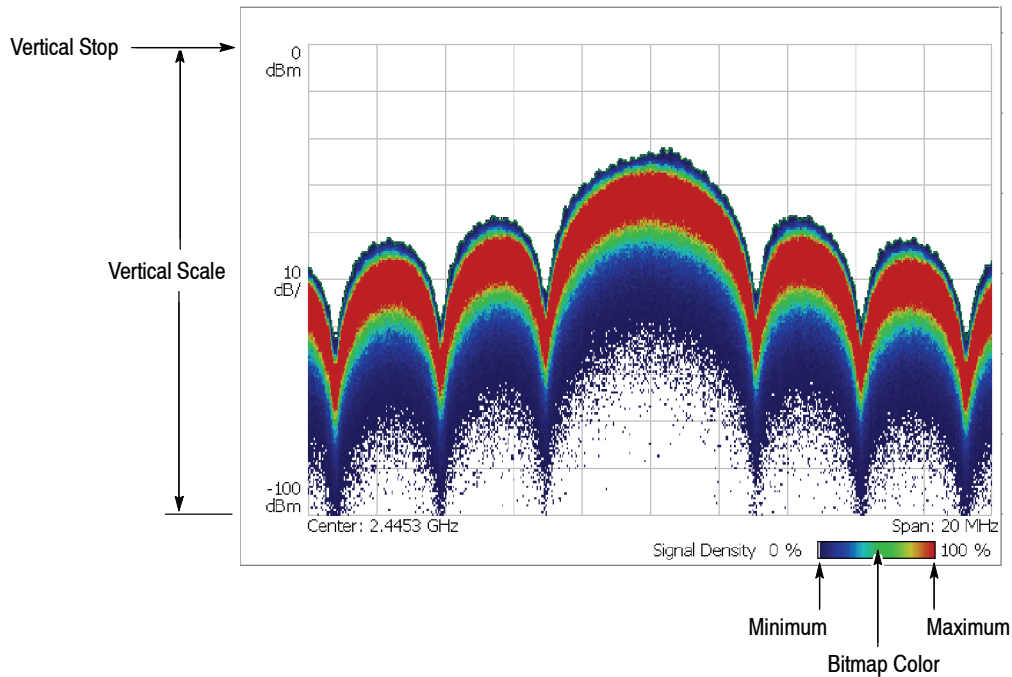
**Table 3-35: Bitmap color scheme**

Color scheme	Description
Temperature	Temperature color (low density in blue and high in red)
Spectral	Spectral color (low density in red and high in blue)
Gray	Gray scale (low density in black and high in white)
Binary Cyan	Binary cyan (lower density than the minimum value in black and higher in cyan)

**Maximum.** Sets the histogram value represented by the top color in the selected palette. Range: 1 to 100% in 1% steps (default: 100%)  
The Maximum value must be greater than Minimum.

**Minimum.** Sets the histogram value represented by the bottom color in the selected palette. Range: 0 to 99% in 1% steps (default: 0%)  
The Minimum value must be less than Maximum.

**Full Scale.** Sets Vertical Scale, Maximum and Minimum to default values.



**Figure 3- 141: Setting the scale in spectrum view**

## Spectrogram View Setting

The spectrogram view shows time-varying spectrum three-dimensionally. It indicates frequency along the horizontal axis, frame number along the vertical axis, and power level by using color. This view is used in the *S/A with Spectrogram* and *Real Time S/A* modes, or the Demod and Time modes as the overview content.

---

**NOTE.** When you select S/A with Spectrogram in the S/A mode, you cannot set the scale of the spectrogram.

---

### View: Scale Menu

The Scale menu for the spectrogram view contains the following controls (see Figure 3-142):

**Auto Scale.** Sets the start value and the scale of the color axis automatically to fit the spectrogram to the screen.

**Horizontal Scale.** Sets the range of the horizontal axis.

**Horizontal Start.** Sets the minimum value (left edge) of the horizontal axis.

**Vertical Size.** Sets the range of the vertical axis. Range: 87 to 89088 frames.

**Vertical Start.** Sets the start frame number for the vertical axis.

**Color Scale.** Sets the scale (value subtracting the minimum power value from the maximum power value) of the color axis. The level is represented in 100 steps (100 colors) from the minimum value (blue) to the maximum value (red) in the default state.

**Color Stop.** Sets the maximum value (top) of the color axis.

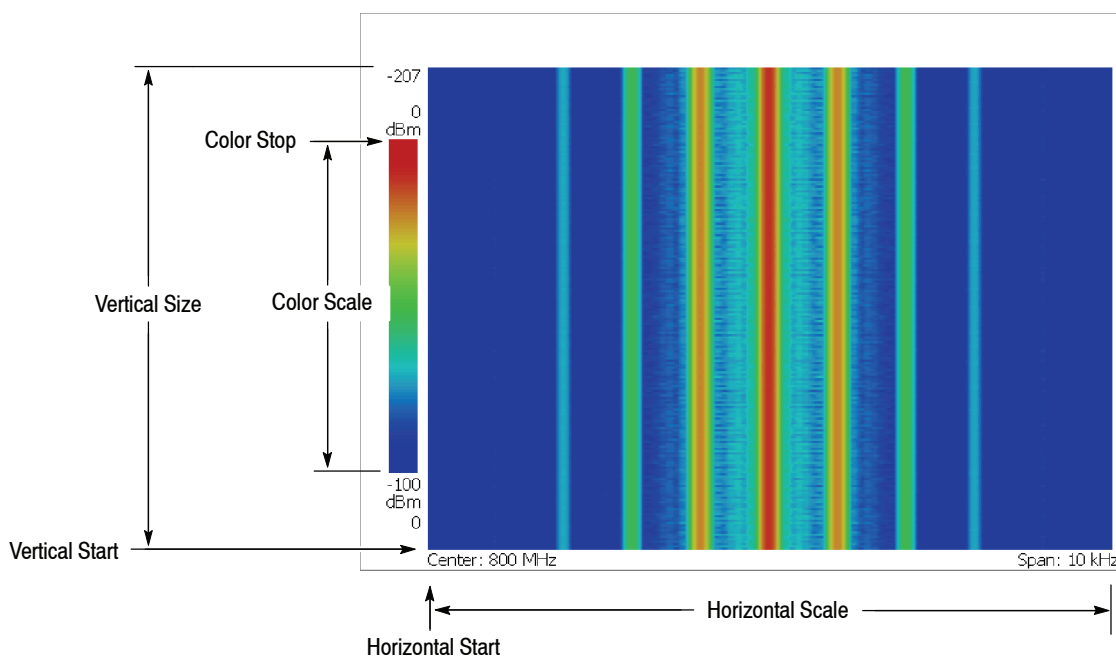
**Full Scale.** Sets the maximum value of the color axis to the reference level and the height to 100 dB.

The following menu items appear when the overview is a spectrogram in the Demod (modulation analysis) and the Time (time analysis) modes.

**Step to Spectrum Window.** Vertical Start is automatically set so that the frame displayed as a spectrum in the subview appears on the spectrogram.

**Step to Analysis Window.** Vertical Start is automatically set so that the frame analyzed and displayed in the main view appears on the spectrogram.

**Step to Trigger.** Vertical Start is automatically set so that the frame at the trigger position appears on the spectrogram.



**Figure 3-142: Scale and format settings in spectrogram view**

## Time Domain View Setting

The time domain view includes the following displays shown on the overview or the main view in the Demod and the Time modes:

- Power versus Time
- AM demodulation display (modulation factor versus time)
- FM demodulation display (frequency deviation versus time)
- PM demodulation display (phase deviation versus time)
- I/Q level versus Time

*For Option 21 only:*

- Random jitter versus Time
- Integrated phase noise versus Time
- C/N versus Time

### View: Scale Menu

The Scale menu for the time domain view contains the following controls (see Figure 3-143):

**Auto Scale.** Sets the start value and the scale of the vertical axis automatically to fit the waveform to the screen.

**Horizontal Scale.** Sets the range of the horizontal axis.

**Horizontal Start.** Sets the minimum value (left edge) of the horizontal axis.

**Vertical Scale.** Sets the range of the vertical axis.

**Vertical Stop.** Sets the maximum value (top) of the vertical axis.  
Available when the vertical axis represents:

- Power
- Random jitter
- Integrated phase noise
- C/N

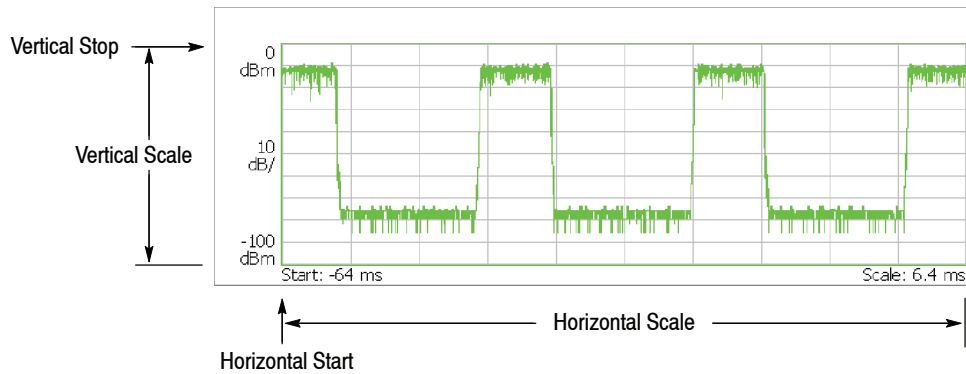
**Vertical Offset.** Sets the center value  $((\text{maximum} + \text{minimum}) / 2)$  of the vertical axis. Available when the vertical axis represents:

- AM modulation factor
- FM frequency deviation
- PM phase deviation
- IQ voltage.

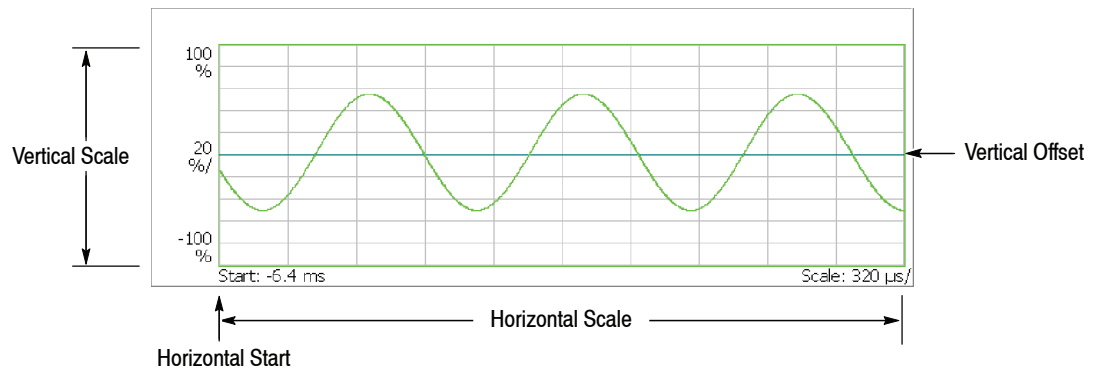
**Full Scale.** Sets the scale of the vertical axis to the default full-scale value.



Vertical axis: Power, Random jitter, Integrated phase noise, or C/N  
 (Power shown)



Vertical axis: AM modulation factor, FM frequency deviation, PM phase deviation, or IQ level  
 (AM modulation factor shown)



**Figure 3-143: Setting the scale in time domain view**

## CCDF View Setting

The CCDF view displays the CCDF measurement in the Digital Demod mode (digital modulation analysis, Option 21 only) and the Time mode (time analysis). The horizontal axis indicates amplitude and the vertical axis (logarithmic scale) indicates CCDF. Refer to page 3-104 for more information about the CCDF measurement.

### View: Scale Menu

The Scale menu for the CCDF view contains the following controls (see Figure 3-144):

**Auto Scale.** Sets the starting value and the scale of the vertical axis automatically to fit the waveform to the screen.

**Horizontal Scale.** Sets the range of the horizontal axis.

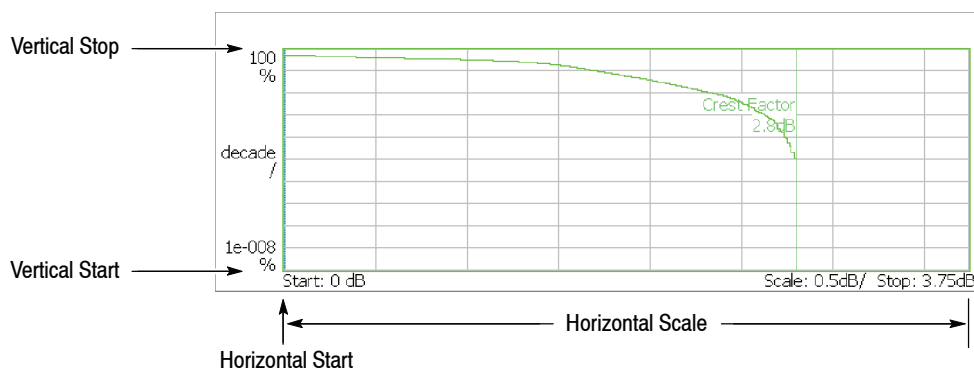
**Horizontal Start.** Sets the minimum value (left edge) of the horizontal axis.

**Vertical Stop.** Sets the maximum value (top) of the vertical axis.  
Range: Twice of Vertical Start value to 100% in a 1-2-5 sequence.

**Vertical Start.** Sets the minimum value (bottom) of the vertical axis.  
Range:  $10^{-9}$  to 1/2 of Vertical Stop value in a 1-2-5 sequence.

**Full Scale.** Sets the scale of the vertical axis to the default full-scale value.

**Sub Grid.** *Time mode only.* Determines whether to display the sub-grid.



**Figure 3-144: Setting the scale in CCDF view**

## Constellation View Setting

### Option 21 Only

The constellation view shows the signal represented by phase and amplitude in polar coordinate or IQ diagram. You can display it in the constellation analysis of the digital modulation analysis (refer to page 3-56).

The constellation displays I and Q components of the signal in two dimensions. As the overall signal level changes, both I and Q are automatically scaled to keep the size of the constellation relatively constant from one update to the next. This new scale is then normalized to a unitless scale.

#### View: Scale Menu

The Scale menu for the constellation view contains the following controls:

**Measurement Content...** Selects vector or constellation display. (see Figure 3-145).

- **Vector.** Selects the vector display. Signals represented by phase and amplitude (such as digitally modulated signals) are shown in a polar coordinate or IQ diagram. The red point indicates the symbol position of the measurement signal and the yellow trace indicates the locus of the signal between symbols. The magnitude of the error vector is evaluated by comparing the point where yellow traces are concentrated to the red point. The cross marks indicate symbol positions of the ideal signal.
- **Constellation.** Selects the constellation display. It is the same as the vector display, except that only symbols of the measurement signal are indicated in red, and the locus between symbols is not displayed.

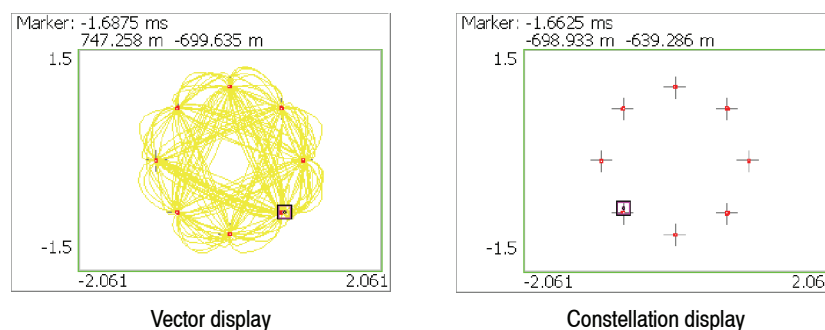


Figure 3-145: Vector and constellation displays

**Phase Multiplication...** For CPM (Continuous Phase Modulation) only.  
 Select the multiplication constant for the phase multiplication display:  
 ×1 (default), ×2, ×4, ×8, ×16, or ×32.

The *phase multiplication display* facilitates observation of noisy CPM signals by multiplying measurement signal phase by the constant to reduce the number of phase states and expand the phase difference between adjacent symbols (see Figure 3-146). The phase at a measurement symbol point is expressed by the following formula:

$$\theta_M = N \times \theta_I + \Delta\theta$$

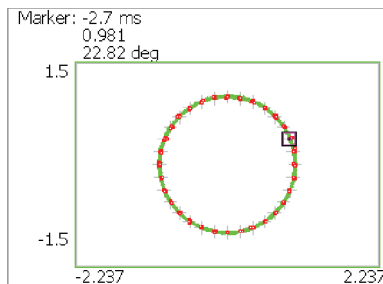
Where

$\theta_M$ : Phase at the measurement symbol point

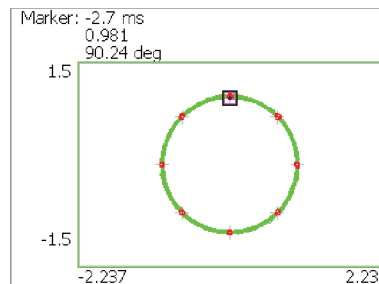
$\theta_I$ : Phase at the ideal symbol point

$\Delta\theta$ : Phase difference between the measurement and ideal symbol points  
 ( $= \theta_M - \theta_I$ )

N: Multiplication constant



Phase Multiplication = x1,  
 displaying 32 symbol points.



Phase Multiplication = x4,  
 displaying 8 symbol points.

**Figure 3- 146: Phase multiplication display for a CPM signal**

## EVM View Setting

### Option 21 Only

The horizontal axis indicates time, and the vertical axis indicates EVM, amplitude, or phase in the EVM view. You can display this view in EVM analysis of the digital modulation analysis (refer to page 3-57).

#### View: Scale Menu

The Scale menu for the EVM view contains the following controls (see Figure 3-147):

**Auto Scale.** Sets the starting value and the scale of the vertical axis automatically to size the waveform to the screen.

**Horizontal Scale.** Sets the range of the horizontal axis.

**Horizontal Start.** Sets the minimum value (left edge) of the horizontal axis.

**Vertical Scale.** Sets the range of the vertical axis.

**Vertical Start.** Available when the vertical axis represents EVM. Sets the minimum value (bottom) of the vertical axis.

**Vertical Offset.** Available when the vertical axis represents magnitude or phase error. Sets the center value  $((\text{maximum} + \text{minimum}) / 2)$  of the vertical axis.

**Full Scale.** Sets the scale of the vertical axis to the default full-scale value.

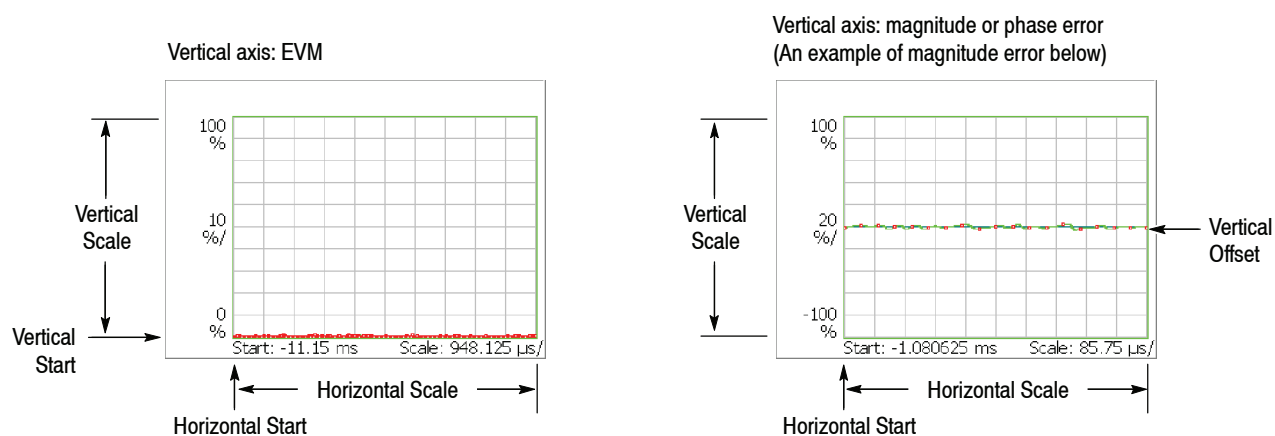
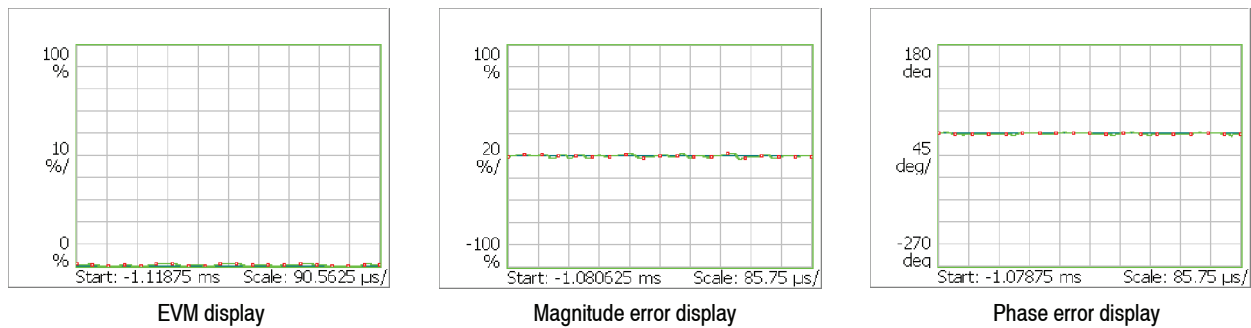


Figure 3-147: Setting the scale in EVM view

**Measurement Content...** Selects one of the following formats for view (see Figure 3-148).

- **EVM.** Displays changes of EVM (Error Vector Magnitude) in time series.
- **Mag Error.** Displays changes of magnitude error in time series.
- **Phase Error.** Displays changes of phase error in time series.



**Figure 3- 148: EVM, magnitude and phase error displays**

---

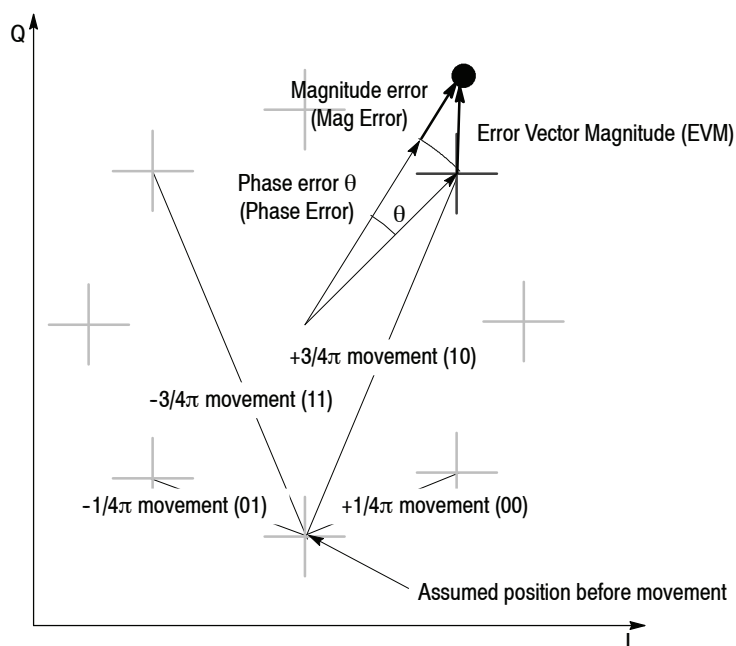
**NOTE.** *OQPSK-modulated signal only. When you select OQPSK in Modulation Type of the Meas Setup menu and set Q Data Half Symbol Shift (refer to page 3-53) of the View: Define menu to 0 (zero), only EVM is available in Measurement Content.*

---

You can select degree or radian for the angular unit by pressing **System > Instrument Setup... > Angular Units.**

See Figure 3-149 for EVM, Mag Error, and Phase Error. The figure is an example of the constellation view in  $1/4\pi$ QPSK modulation. The cross marks are referred to as symbols and indicate phase positions of the ideal signal (amplitude is fixed in this case). In this modulation, the bit pattern is determined by movements from each position. For example, if the actual signal has shifted from the ideal symbol position to the ● position, you can evaluate vector signal quality as magnitudes of error in radius direction (amplitude), error in phase direction, and total error vector. These three types of errors correspond to the three types of views in the EVM view:

- EVM (%RMS): Root-mean-square value of EVM (Error Vector Magnitude)
- Mag Error (%RMS): Root-mean-square value of magnitude error
- Phase Error (%RMS): Root-mean-square value of phase error



**Figure 3-149: Constellation view and error vectors in  $1/4\pi$  QPSK**

## Symbol Table Setting

### Option 21 Only

The symbol table shows modulated symbol stream. You can display this table in the symbol table analysis in the digital modulation analysis (refer to page 3-60).

#### View: Scale Menu

The Scale menu for the symbol table contains the following controls (see Figure 3-151):

**Radix.** Selects the radix for displaying the table from hexadecimal digit (Hex), octal digit (Oct), and binary digit (Bin).

**Rotate.** Sets the value start position. The setting range is 0 to 3. This item is invalid in  $1/4\pi$  QPSK and GMSK modulations because absolute coordinates have no meaning.

**Decoding Start Position.** Selects the decoding start position for the ASK, FSK, and GFSK signals with the decoding format of Manchester or Miller.

- **Auto.** Determines the decoding start position automatically.
- **0.** Starts decoding from the beginning of a symbol.
- **+1.** Delays the decoding start position by half a symbol.

**Sequence.** Selects how to determine the symbol value for the D8PSK signals. Valid when D8PSK is selected as Modulation Type in the Meas Setup menu.

- **Code.** Selects the code sequence that determines the symbol value by the phase difference between the current and the previous symbols using Gray code. For example, when the phase difference is  $\pi/2$ , the symbol value is 3.
- **Phase.** Selects the phase sequence that determines the symbol value by the phase angle directly. For example, when the phase angle is  $\pi/2$ , the symbol value is 2. See Figure 3-150.

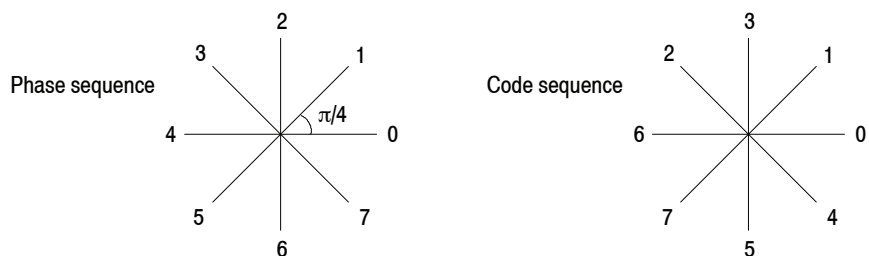


Figure 3- 150: D8PSK symbol value



```

Marker: 199sym
01
0: 01111010 01101110 01000101 00001010 11010011 11110110 01001001 01101111
32: 11001001 10101001 10011000 00001100 01100101 00011010 01011111 11010001
64: 01100011 10101100 10110011 11000111 11011101 00000110 10110110 11101100
96: 00010110 10111110 10101010 00000101 00101011 11001011 10111000 00011100
128: 11101001 00111101 01110101 00010010 00011001 11000010 11110110 11001101
160: 00001110 11110000 11111111 10000011 11011111 00010111 00110010 00001001
192: 01001110 11010001

```

**Figure 3-151: Symbol table**

For information on symbol mapping, refer to *Appendix B: Digital Demodulation Symbol Mapping*.

### Symbol Value of CPM

The symbol value of the CPM (Continuous Phase Modulation) signal is determined by the phase difference between the current and the previous symbols as shown in Table 3-36.

**Table 3-36: Symbol value of CPM**

Phase difference (Modulation index: $h_1, h_2$ )	Example (Modulation index: 4/16, 5/16)	Symbol value
$-3h_1$ or $-3h_2$	$-12/16 \pi$ or $-15/16 \pi$	3
$-h_1$ or $-h_2$	$-4/16 \pi$ or $-5/16 \pi$	2
$+h_1$ or $+h_2$	$+4/16 \pi$ or $+5/16 \pi$	1
$+3h_1$ or $+3h_2$	$+12/16 \pi$ or $+15/16 \pi$	0

## Eye Diagram Setting

### Option 21 Only

The eye diagram shows I or Q signal that is triggered on a clock signal aligned with the symbol rate, representing time along the horizontal axis and amplitude or phase along the vertical axis. You can display this diagram in the eye diagram analysis in the digital modulation analysis (refer to page 3-60).

**View: Scale Menu**

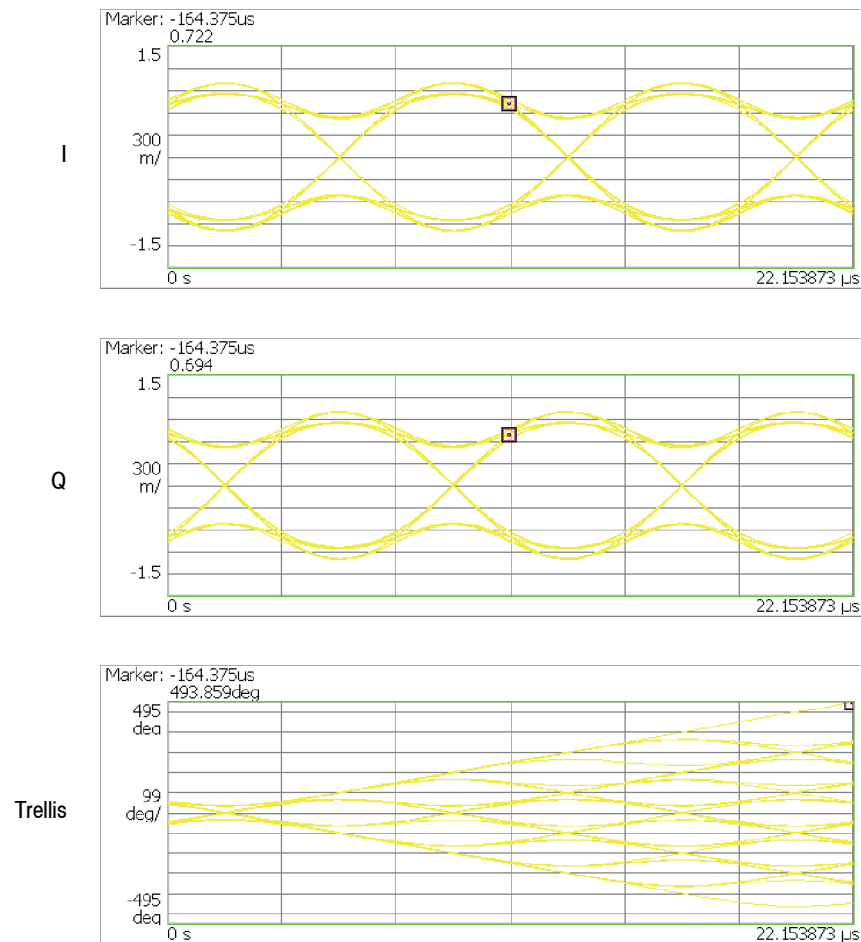
The Scale menu for the eye diagram contains the following controls:

**Measurement Content...** Selects the vertical axis of the eye diagram (see Figure 3-152).

- **I. Default.** Displays I signal level on the vertical axis.
- **Q.** Displays Q signal level on the vertical axis.
- **Trellis.** Indicates phase on the vertical axis.

**Eye Length.** Sets the number of symbols displayed on the horizontal axis. The time required for movement between symbols is defined as 1 (one).

Range: 1 to 16 (the default is 2)



**Figure 3- 152: Eye diagram view**

## AM/AM View Setting

### Option 21 Only

The AM/AM view shows non-linearity characteristics of a device under test (DUT) such as an RF amplifier, representing reference amplitude along the horizontal axis and measured signal amplitude along the vertical axis. Refer to *AM/AM Measurement* on page 3-61.

#### View: Scale Menu

The Scale menu for the AM/AM view contains the following controls:

**Measurement Content...** Selects a vector or dot display (see Figure 3-153).

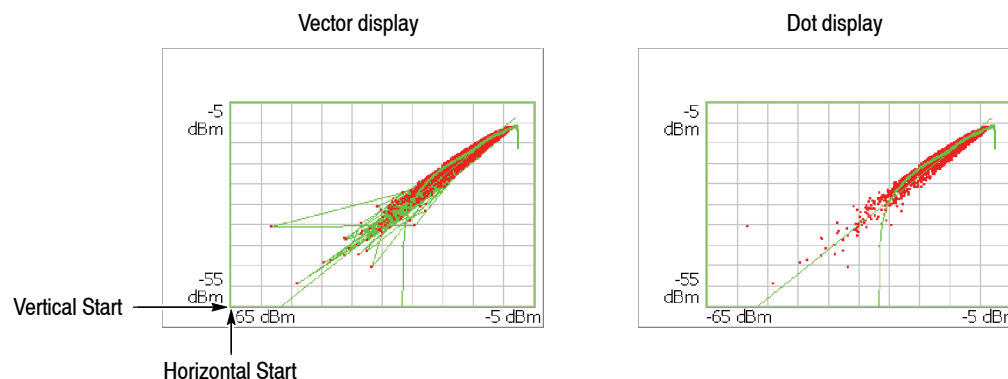
- **Vector.** Displays yellow lines between the dots (default).
- **Dot.** Displays the calculated result as a series of red dots.

By default, the measurement results are displayed with the horizontal and vertical axes scaled automatically to fit the graph to the screen.

**Horizontal Start.** Sets the minimum value (left edge) of the horizontal axis to expand the graph.

Range: The initial minimum value (left edge) to the maximum value (right edge)

**Vertical Start.** Shows the minimum value (bottom) of the vertical axis (not settable). Equal to the Horizontal Start value.



**Figure 3-153: Vector and dot displays for AM/AM view**

## AM/PM View Setting

### Option 21 Only

The AM/PM view shows non-linearity characteristics of a device under test (DUT) such as RF amplifier, representing reference amplitude along the horizontal axis and phase error along the vertical axis. Refer to *AM/PM Measurement* on page 3-63.

#### View: Scale Menu

The Scale menu for the AM/PM view contains the following controls:

**Measurement Content...** Selects a vector or dot display (see Figure 3-154).

- **Vector.** Displays yellow lines between the dots (default).
- **Dot.** Displays the calculated result as a series of red dots.

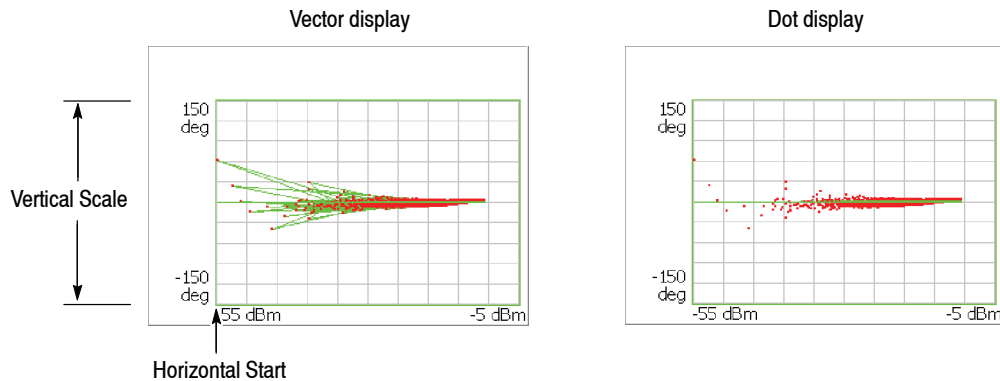
By default, the measurement results are displayed with the horizontal and vertical axes scaled automatically to fit the graph to the screen.

**Horizontal Start.** Sets the minimum value (left edge) of the horizontal axis to expand the graph horizontally.

Range: The initial minimum value (left edge) to the maximum value (right edge)

**Vertical Scale.** Sets the vertical full-scale value to expand the graph vertically.

Range: The initial maximum value  $\times 0.05$  to the maximum value



**Figure 3-154: Vector and dot displays for AM/PM view**

## PDF View Setting

### Option 21 Only

This view is displayed in the PDF (Probability Distribution Function) measurement in the digital modulation analysis (refer to page 3-65). The horizontal axis represents power level relative to the mean value at the center and the vertical axis represents occurrence probability.

#### View: Scale Menu

The Scale menu for the PDF view contains the following controls (see Figure 3-155):

**Auto Scale.** Sets the starting value and the scale of the vertical axis automatically to fit the waveform to the screen.

**Horizontal Scale.** Sets the range of the horizontal axis.

**Horizontal Start.** Sets the minimum value (left edge) of the horizontal axis.

---

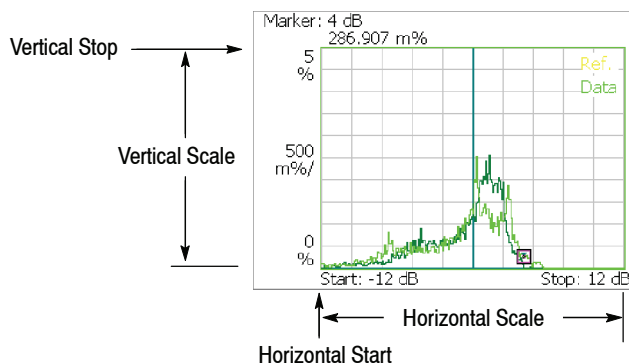
**NOTE.** By default, the horizontal axis is displayed in the range of  $\pm 12$  dB. If the amplitude exceeds 12 dB, the horizontal axis will be set automatically to fit the waveform to the screen.

---

**Vertical Scale.** Sets the range of the vertical axis.

**Vertical Stop.** Sets the maximum value (top) of the vertical axis.

**Full Scale.** Sets the scale of the horizontal and vertical axes to each full-scale value. You can change the scale of the horizontal and vertical axes within these full-scale values.



**Figure 3-155: Setting the scale in PDF view**

## Noisogram View Setting

### *Option 21 Only*

The noisogram provides a three dimensional representation of time-varying phase noise. It indicates frequency along the horizontal axis, frame number along the vertical axis, like a spectrogram, and C/N by using color. This view is used as the subview in the signal source analysis (refer to page 3-119).

#### **View: Scale Menu**

The Scale menu for the Noisogram contains the following controls (see Figure 3-156):

**Auto Scale.** Sets the start value and the scale of the color axis automatically to fit the noisogram to the screen.

**Horizontal Stop.** Sets the maximum value (right edge) of the horizontal axis. Range: (Horizontal Start) $\times$ 2 to (Span)/2.

**Horizontal Start.** Sets the minimum value (left edge) of the horizontal axis. Range: (The minimum offset frequency of the analyzed data) to (Horizontal Stop)/2.

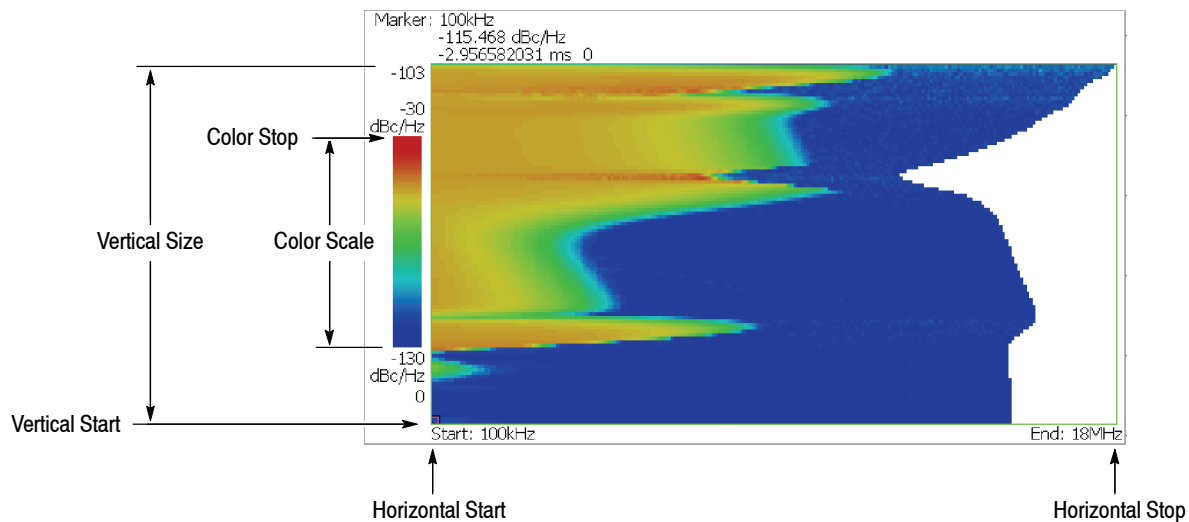
**Vertical Size.** Sets the range of the vertical axis. Range: 40 to 40960 frames.

**Vertical Start.** Sets the start frame number for the vertical axis. Range: - (the number of frames in the analysis range) to 0. Zero (0) represents the latest frame.

**Color Scale.** Sets the scale (value subtracting the minimum power value from the maximum power value) of the color axis. The level is represented in 100 steps (100 colors) from the minimum value (blue) to the maximum value (red) in the default state. Range: 10 to 100 dB in a 1-2-5 sequence.

**Color Stop.** Sets the maximum value (top) of the color axis. Range: [70 - (Color Scale)] to 70 dBc/Hz.

**Full Scale.** Sets the maximum value of the color axis to 0 and the height to 100 dBc/Hz.



**Figure 3-156: Setting the scale in noisogram view**





# Display Line

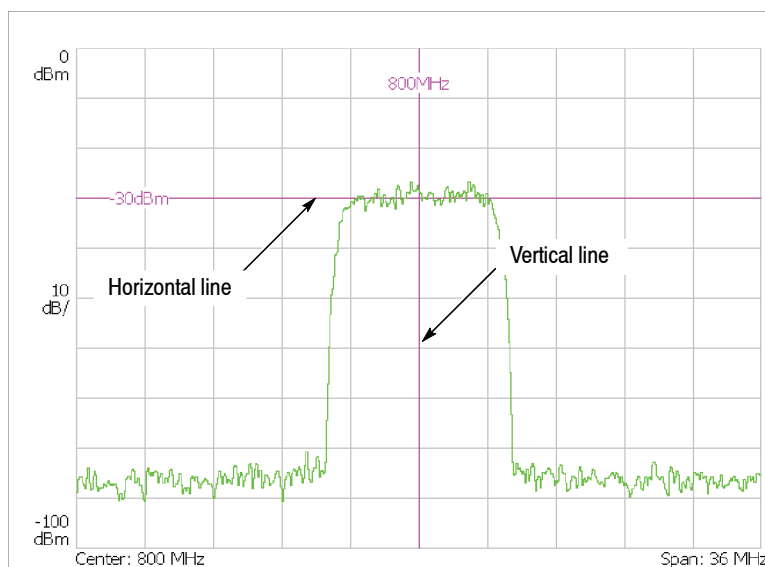
The analyzer provides a convenient method to determine whether a signal peak is higher or lower than a specified level, or whether it falls within a specified range. Use the Lines menu to control the display lines. The Display Line feature displays horizontal and/or vertical line(s) at the position you specify.

There are two types of lines: horizontal line and vertical line as shown in Figure 3-157. In the S/A mode other than Real Time S/A, you can display one or two of each line. You can display the horizontal and vertical lines concurrently. The Real Time S/A mode has multi display lines function that shows multiple horizontal and vertical lines.

---

**NOTE.** The display line is available only in the S/A (spectrum analysis) mode.

---



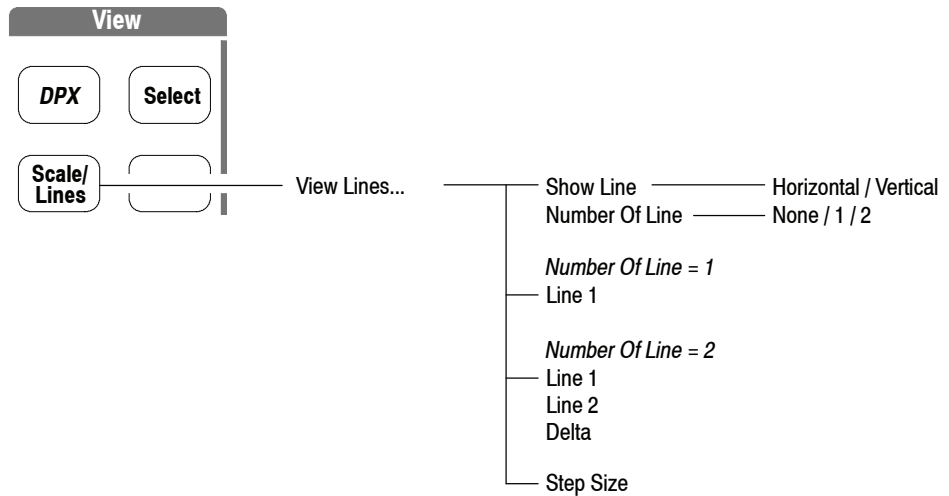
**Figure 3-157: Display line**

This section provides these two topics:

- Display Line Operation (Other than Real Time S/A)
- Multi Display Lines (Real Time S/A Only)

## Display Line Operation (Other than Real Time S/A)

Controls the display line. See Figure 3-158 for the Lines menu structure.



**Figure 3- 158: Lines menu structure (other than Real Time S/A)**

### Lines Menu

The Lines menu in the S/A mode other than the Real Time S/A has the following controls:

**Show Line.** Selects the display line to be controlled:

- Horizontal
- Vertical

**Number Of Line.** Selects how many horizontal lines are displayed on the graph:

- None
- 1
- 2

**Line 1.** Sets the position of the first line.

**Line 2.** Sets the position of the second line.

**Delta.** Sets the difference between the first line and the second:  
 (Value of Line 2) - (Value of Line 1)

**Horizontal Display Line**

1. Press the **Scale/Lines** key on the front panel, and then press the **View Lines...** side key.
2. Press the **Show Line** side key to select **Horizontal**.

---

**NOTE.** In the following steps, use the general purpose knob or the numeric input keypad to move the lines.

---

3. Perform one of the following options.

- *To display one horizontal line:*  
Press the **Number Of Line** side key to select **1**.

Press the **Line 1** side key and move the line.

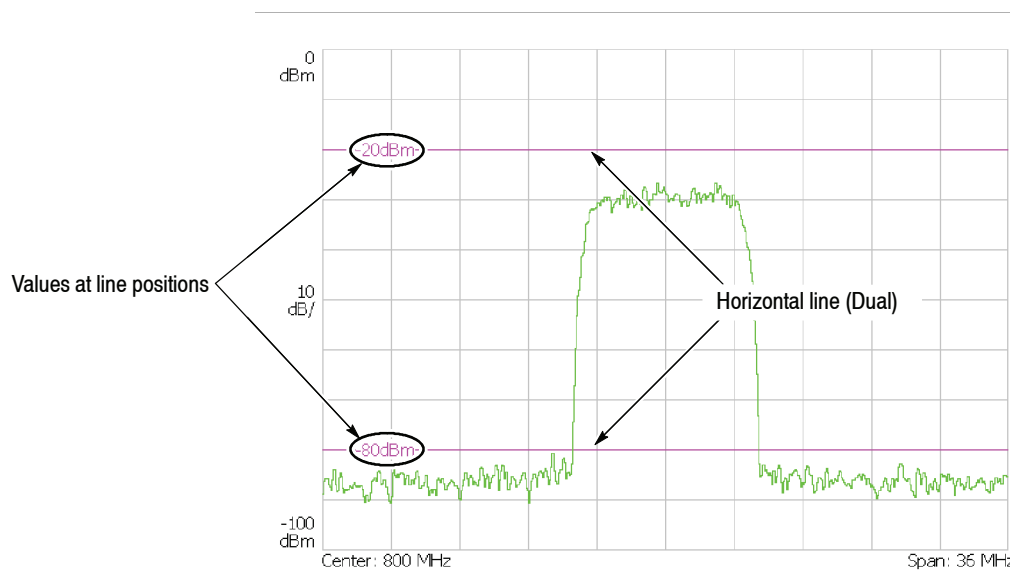
- *To display two horizontal lines:*  
Press the **Number Of Line** side key to select **2**.

Press the **Line 1** side key and move line 1. Line 2 moves in parallel.

Press the **Line 2** side key and move line 2.

Press the **Delta** side key and move line 2. The delta value indicates the following value: (value of Delta) = (value of line 2) - (value of line 1)

- *To turn off the horizontal line:*  
Press the **Number Of Line** side key to select **None**.



**Figure 3-159: Two horizontal lines**

**Vertical Display Line**

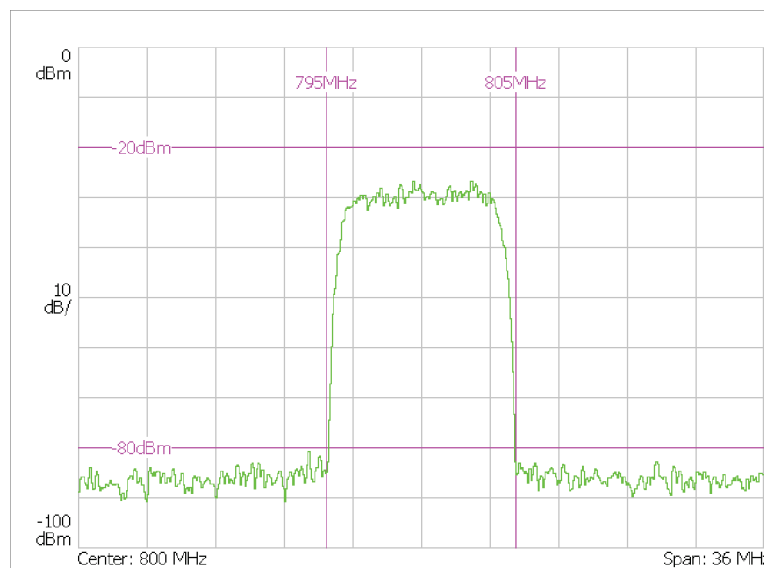
1. Press the **Scale/Lines** key on the front panel, and then press the **View Lines...** side key.
2. Press the **Show Line** side key to select **Vertical**.

---

**NOTE.** *In the following steps, use the general purpose knob or the numeric input keypad to move the lines.*

---

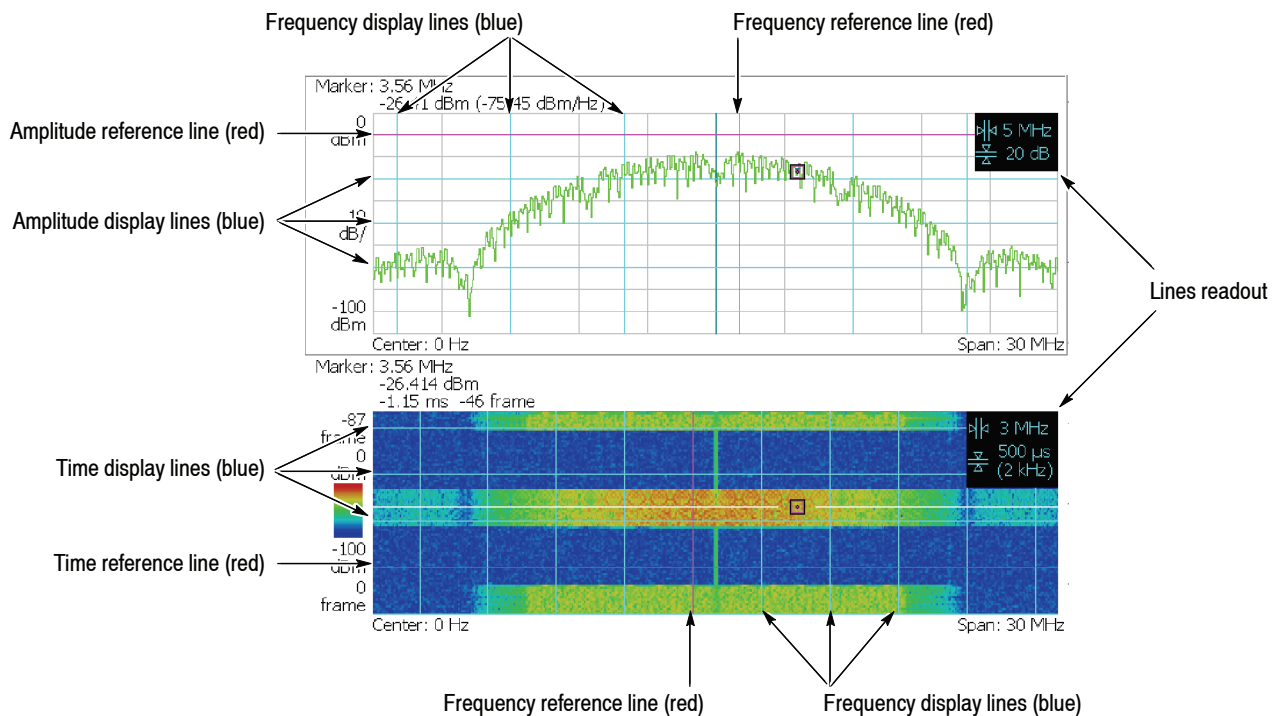
3. Perform one of the following options.
  - *To display one vertical line:*  
 Press the **Number Of Line** side key to select **1**.  
  
 Press the **Line 1** side key and move the line.
  - *To display two vertical lines:*  
 Press the **Number Of Line** side key to select **2**.  
  
 Press the **Line 1** side key and move line 1. Line 2 moves in parallel.  
  
 Press the **Line 2** side key and move line 2.  
  
 Press the **Delta** side key and move line 2. The delta value indicates the following value: (value of Delta) = (value of line 2) - (value of line 1)
  - *To turn off the vertical line:*  
 Press the **Number Of Line** side key to select **None**.



**Figure 3- 160: Two horizontal and two vertical lines**

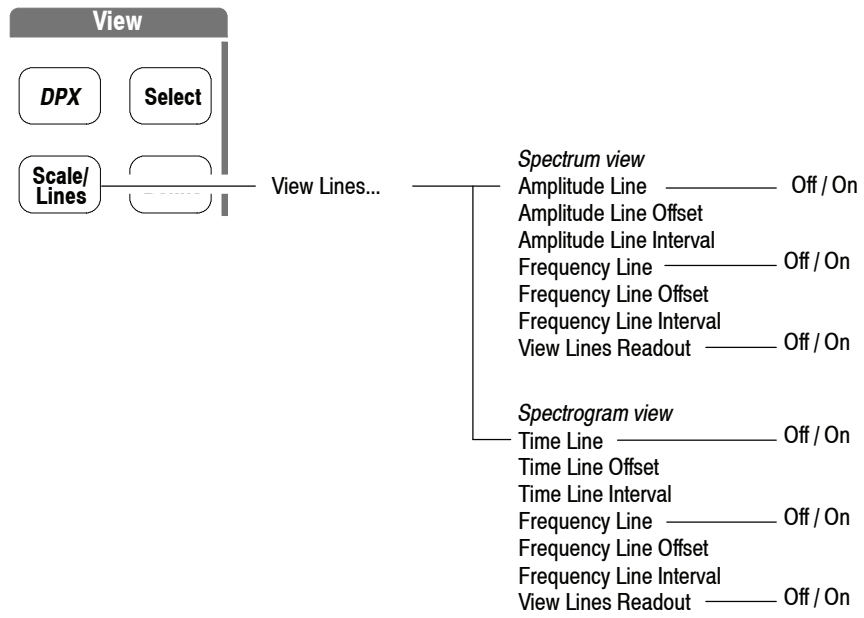
## Multi Display Lines (Real Time S/A Only)

The Real Time S/A mode has the multi display lines function that shows multiple horizontal and vertical lines as shown in Figure 3-161. The spectrum view uses the amplitude and frequency lines. The spectrogram uses the time and frequency lines. The display lines are placed at regular intervals from the reference line.



**Figure 3-161: Multi display lines (Real Time S/A mode)**

**Lines Menu** The Lines menu for the Real Time S/A mode has different controls between the spectrum and spectrogram view. The settings are shown in the lines readout at the upper right of the view (see Figure 3-161).



**Figure 3- 162: Lines menu structure (Real Time S/A)**

**Spectrum View.**

**Amplitude Line.** Determines whether to turn on or off the amplitude display lines. The default is Off.

**Amplitude Line Offset.** Sets the offset of the amplitude reference line.  
Range: -100 to 0 dBm (the default is 0 dBm)

**Amplitude Line Interval.** Sets the interval of the amplitude display lines.  
Range: 0 to 100 dB (the default is 0 dB)

**Frequency Line.** Determines whether to turn on or off the frequency display lines. The default is Off.

**Frequency Line Offset.** Sets the offset of the frequency reference line.  
Range: Center frequency  $\pm$  Span/2 (Hz).  
The default value is the center frequency; the reference line is at center screen.

**Frequency Line Interval.** Sets the interval of the frequency display lines.  
Range: 0 to full span (the default is 0 Hz)

**View Lines Readout.** Determines whether to turn on or off the display lines readout. The default is On.

**Spectrogram View.**

**Time Line.** Determines whether to turn on or off the time display lines.  
The default is Off.

**Time Line Offset.** Sets the offset of the time reference line.  
Range: 0 second maximum (Zero represents the latest frame.)  
The minimum value depends on acquired data quantity.

**Time Line Interval.** Sets the interval of the time display lines.  
Range: 0 second minimum.  
The maximum value depends on acquired data quantity.

The other menu items (Frequency Line, Frequency Line Offset, Frequency Line Interval, and View Lines Readout) are the same as the spectrum view.

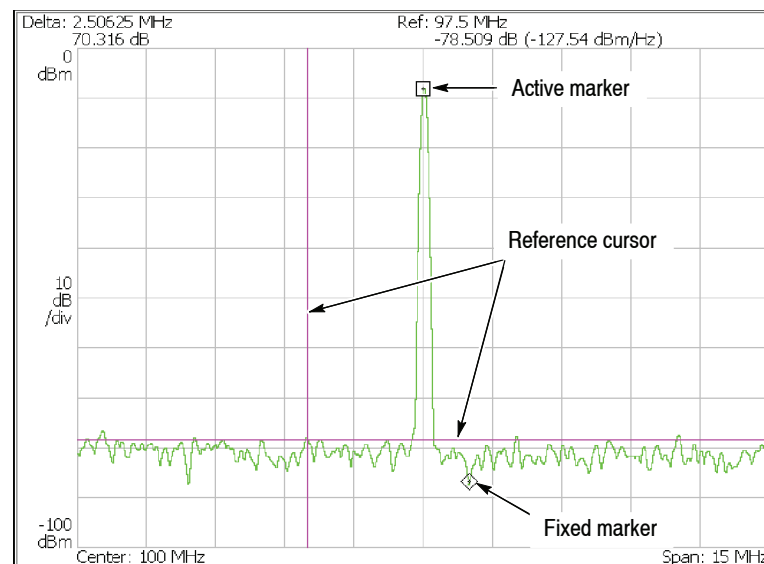




# Marker Operation and Peak Search

The marker moves on a waveform to measure amplitude or frequency. One or two markers can be displayed on the screen. You can also use the reference cursor together with the marker. The marker is also used for peak search. For information on the band power marker used in the spectrum analysis, refer to *Spectrum Analysis (S/A mode)* on page 3-1.

One or two markers (active and fixed) and/or a reference cursor can be displayed on the screen as shown in Figure 3-163.



**Figure 3-163: Marker display**

- **Single marker mode**  
One marker (called Marker 1) indicated by “□” moves on a waveform. It is used to measure absolute values.
- **Delta marker mode**  
Two markers (called Marker 1 and 2) indicated by “□” and “◇” move on a waveform. “□” and “◇” represent an active and a fixed marker, respectively. They are used to measure relative values.

## Markers Menu

The Markers menu controls the marker operation and peak search. Figure 3-164 shows the menu structure.

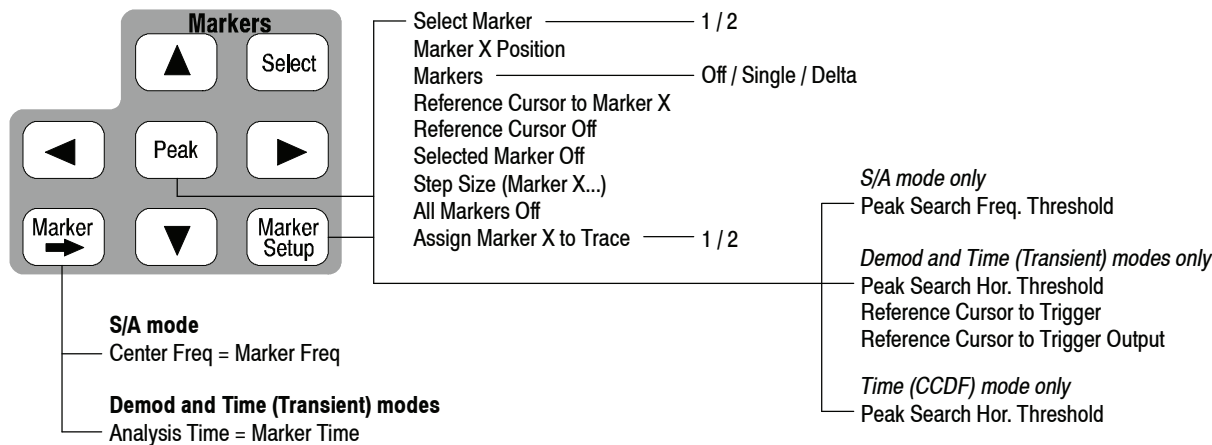


Figure 3- 164: Markers menu structure

**Select** Selects which marker is being controlled in the delta marker mode. If markers are disabled, pressing this key enables Marker 1.

**Marker →** Sets instrument parameters based on the marker position(s).

**Center Freq = Marker Freq.** Changes the center frequency to match the current marker position.

**Analysis Time = Marker Time.** *Demod and Time modes only.* Sets the origin of an analysis range with the marker in the overview. For the detail, refer to *Setting the Analysis Range* on page 3-34.

**Peak** Positions the marker to the highest peak signal.

**Marker Left (◀) / Right (▶)** Moves the marker lower or higher in frequency to the next signal, respectively.

**Marker Up (▲) / Down (▼)** Moves the marker higher or lower in amplitude to the next signal, respectively.

The definition of “next” can be set in the Marker Setup menu, using Peak Search Freq. Threshold or Hor. Threshold. Refer to *Setting the Minimum Jump of the Marker* on page 3-244.

**Marker Setup**

Set up the behavior of the markers.

**Select Marker.** Selects which marker is being controlled in the delta marker mode. Same as Markers: **Select**.

**Marker X Position.** Sets the horizontal position of the selected marker.

**Markers.** Selects the marker mode:

- **Off.** Displays no marker.
- **Single.** Displays one marker (Marker 1).
- **Delta.** Displays two markers (Marker 1 and 2).

**Reference Cursor to Marker X.** Enables the Reference Cursor, at the same position as the selected marker. Only available when the selected view can contain a reference cursor.

**Reference Cursor Off.** Turns off the Reference Cursor. Only available when the selected view can contain a reference marker.

**Selected Marker Off.** Turns off the selected marker.

**All Markers Off.** Turns off both markers, the reference cursor, and all their readouts.

**Assign Marker X to Trace.** When two traces are being displayed, moves the selected marker to another trace with the same horizontal position. Available only if two traces are being displayed.

**Peak Search Freq. Threshold.** *S/A mode only.* Sets the minimum frequency jump that should be made when selecting the next signal to the left/right/up/down.

**Peak Search Hor. Threshold.** *Demod and Time modes only.* Selects the minimum horizontal jump that should be made when selecting the next signal to the left/right/up/down.

**Marker X Vertical.** *Spectrogram view in the Real Time S/A mode only.* Specifies the number of the frame in the spectrogram to display the spectrum. The latest frame is number zero. Older frames have larger negative numbers. Same as Spectrum Offset in the Acquisition/Analysis menu.

**Reference Cursor to Trigger.** *Demod and Time modes only.* Enables the reference cursor at the same position as the trigger in the overview.

**Reference Cursor to Trigger Output.** *Demod and Time modes only.* Enables the reference cursor at the same position as the trigger output in the overview.

## Using Markers

This section shows some examples of marker operation.

**NOTE.** If multiple views are displayed on the screen, select the view to operate the markers using the View: **Select** key on the front panel. The selected view is shown with a white frame.

### Measuring with a Single Marker

To measure amplitude or frequency with a single marker, follow these steps:

1. Press the **Marker Setup** key on the front panel.
2. Press the **Markers** side key to select **Single**. Only Marker 1 is enabled.

Note that the **Marker X Position** menu item is already selected.

3. Rotate the general purpose knob (or enter the value using the numeric keypad) to move the marker to the measurement location.

The marker readout is displayed in the top left portion of the screen (see Figure 3-165).

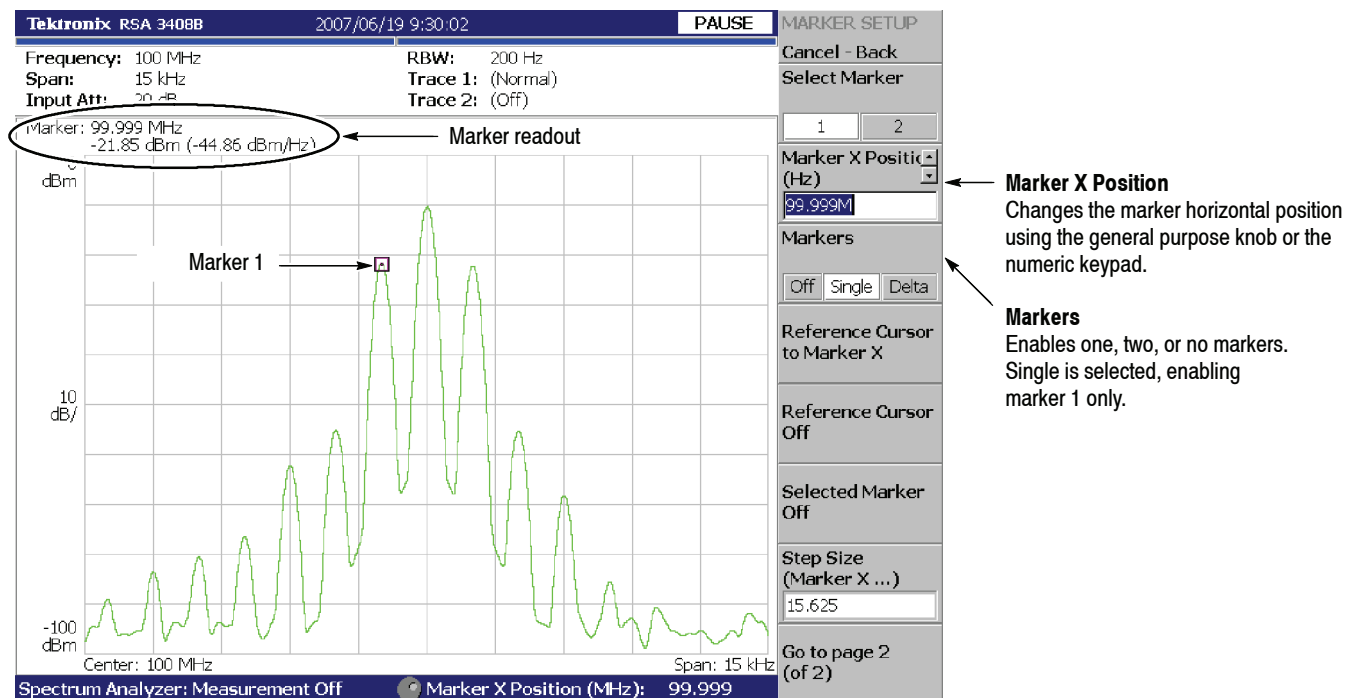


Figure 3- 165: Measurement with a single marker

### Measuring with the Delta Marker

To measure differences in amplitudes or frequencies using the delta marker, follow these steps:

1. Press the **Maker Setup** key on the front panel.
2. Press the **Makers** side key to select **Delta**.

Marker 1 and 2 are displayed, with the two markers overlapping each other. **Select Marker** is set to **1** (Marker 1) by default.

Note that the **Marker X Position** menu item is already selected.

3. Rotate the general purpose knob (or enter the value using the keypad) to move the active marker to the reference point.
4. Change the active marker by pressing the **Select Marker** side key to select **2**.
5. Rotate the general purpose knob (or enter the value using the keypad) to move the active marker to the measurement point.

As shown in Figure 3-166, the marker readout is shown in the top left portion of the screen:

$$(\text{Delta marker readout}) = (\text{Marker 1 readout}) - (\text{Marker 2 readout})$$

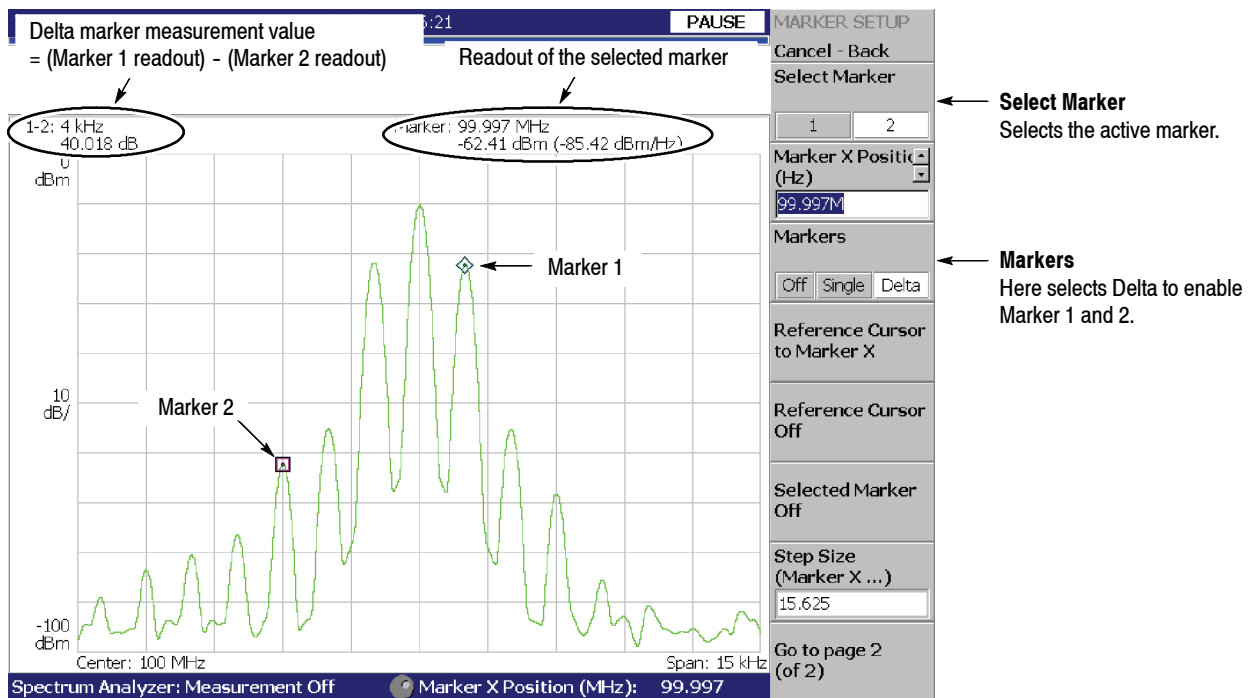


Figure 3-166: Using the delta marker to take measurements

### Measuring with the Reference Cursor

The reference cursor is another way to measure relative amplitude or frequency. The reference cursor is positioned with the marker and fixed on the screen.

1. Press the **Marker Setup** key on the front panel.
2. Press the **Makers** side key to select **Single** or **Delta**.
3. Press the **Marker X Position** side key and rotate the general purpose knob (or enter the value using the keypad) to move the marker to the reference point.
4. Press the **Reference Cursor to Marker X** side key to display the cursor at the marker position.

*Demod and Time modes only:*

On the overview, you can also place the reference cursor at a trigger output position with the **Reference Cursor to Trigger** side key.

5. Press the **Marker X Position** side key and rotate the general purpose knob (or enter the value using the keypad) to move the marker to the measurement point.

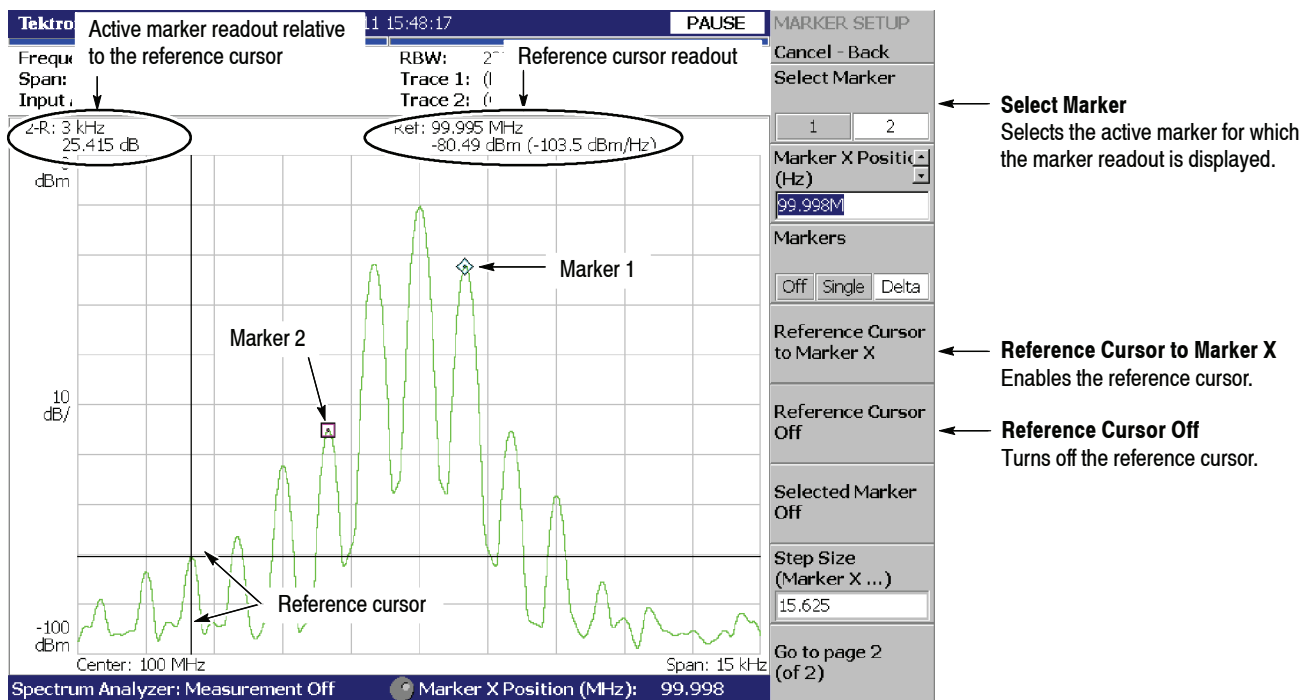


Figure 3- 167: Measurement with the reference cursor

As shown in Figure 3-167, the marker readout relative to the reference cursor is shown in the top left portion of the screen for the active marker selected using the **Select Marker** side key.

To turn off the reference cursor, press the **Reference Cursor Off** side key.

### Changing the Trace

Use the following steps to change the trace on which you operate the marker when displaying two traces on a view. Trace 1 is displayed in yellow and Trace 2 in green.

In the S/A (spectrum analysis) mode, two traces are shown when Trace 2 is turned on using the Trace/Avg menu.

In Demod (modulation analysis) mode and Time (time analysis) mode, two traces are shown in IQ vs. Time view (I level vs. time and Q level vs. time).

1. Press the **Marker Setup** key on the front panel.
2. Press the **Go to page 2 (of 2)** (bottom) side key to show the next menu page.
3. Press the **Assign Marker X to Trace** side key to select Trace 1 or 2, as shown in Figure 3-168.

The marker moves to another trace with the same horizontal position.

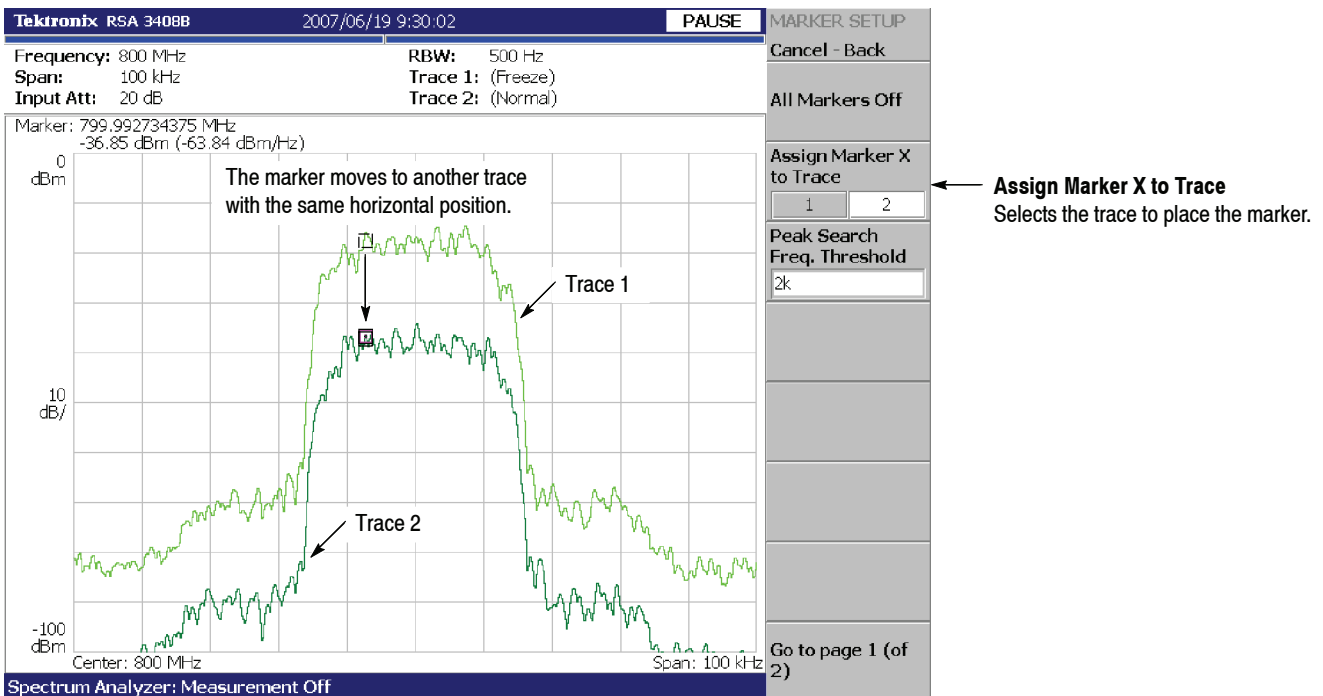
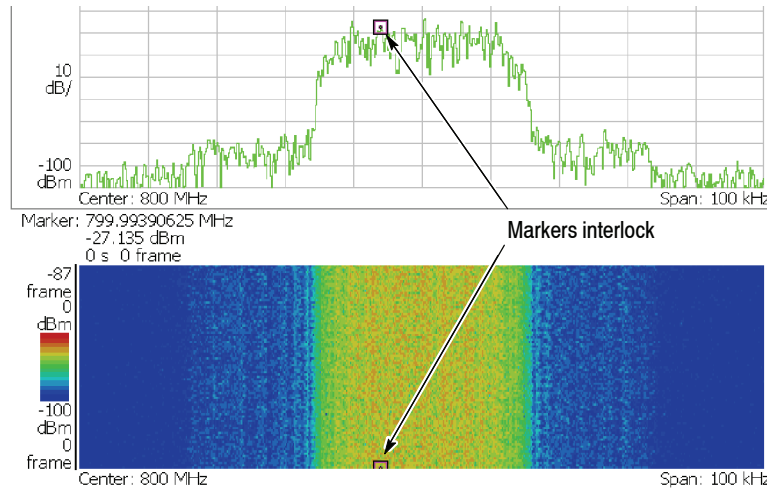


Figure 3-168: Changing the Trace

**Markers in Multiple Views**

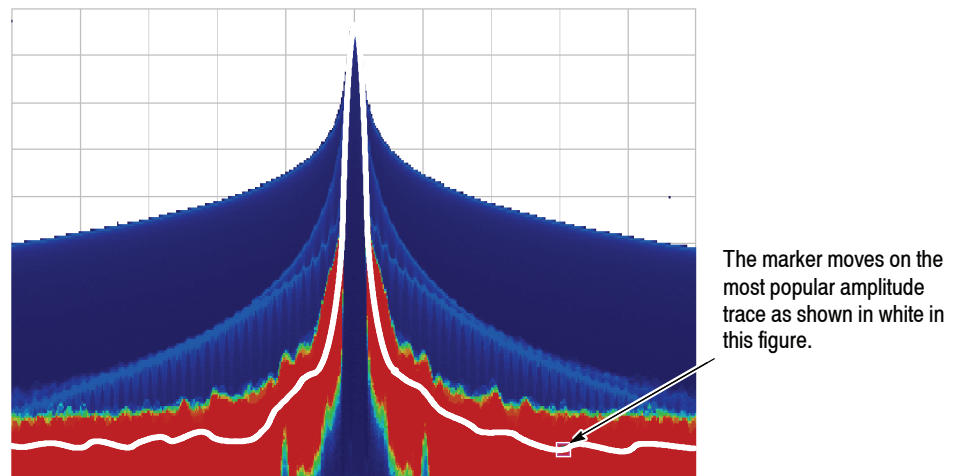
When you display multiple views on one screen, markers displayed in those views are locked together. Figure 3-169 shows a concurrent display example of the spectrum and the spectrogram. If you move the marker to the left on the spectrum, the marker on the spectrogram moves to the left in accordance with that movement. Conversely, if you move the marker on the spectrogram to the left, the marker on the spectrum moves to the left.



**Figure 3-169: Interlocked markers**

**Marker Operation in the DPX Spectrum**

The marker operation in the DPX spectrum is the same as in the normal spectrum display. But note that when a marker is on the Bitmap trace, it is placed on the most popular amplitude value (see Figure 3-170).

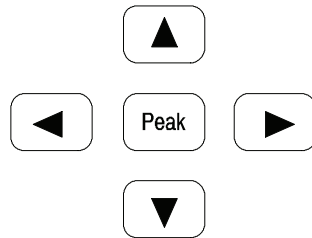


**Figure 3-170: Marker movement on the Bitmap trace**



## Peak Search

The peak search function searches for the peak on the waveform and moves the marker to the peak position. Use the **Peak** and marker left/right/up/down (◀▶▲▼) keys on the front panel for peak search.



### Using the Peak Search keys

The peak search keys have the following functions (see Figure 3-171):

- Peak** Positions the marker to the highest peak signal.
- ◀ Moves the marker lower in frequency to the next signal.
- ▶ Moves the marker higher in frequency to the next signal.
- ▲ Moves the marker higher in amplitude to the next signal.
- ▼ Moves the marker lower in amplitude to the next signal.

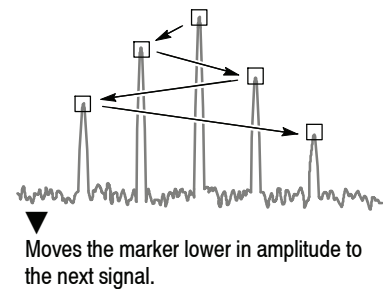
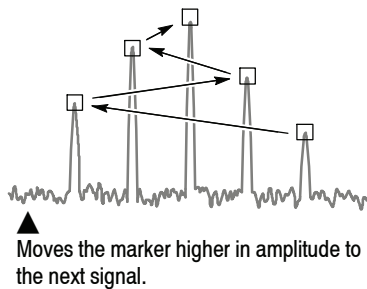
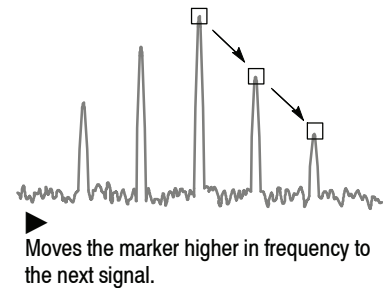
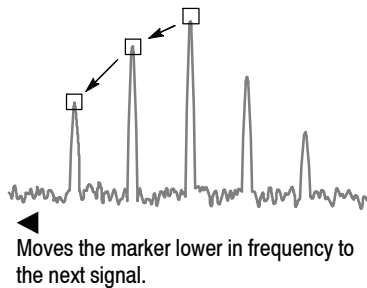
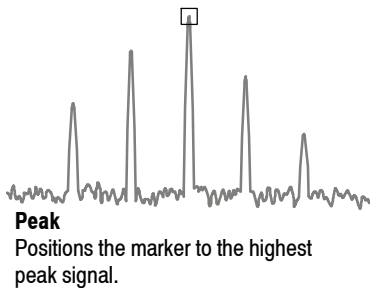


Figure 3-171: Functions of the peak search keys

### Setting the Minimum Jump of the Marker

The definition of “next” can be set in the Marker Setup menu using the following parameters:

**Peak Search Freq. Threshold.** *S/A mode only.*

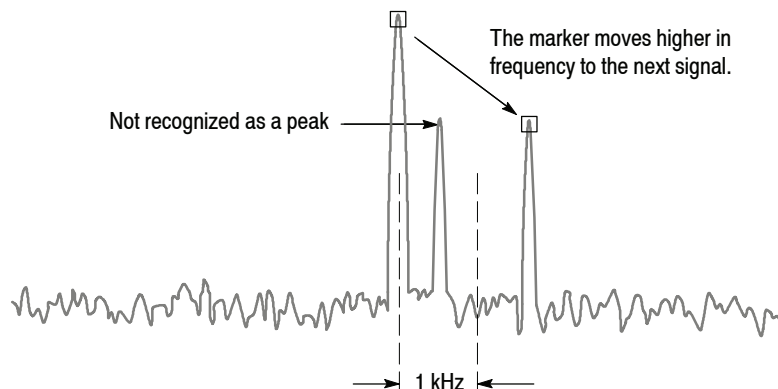
Sets the minimum frequency jump that will be made when selecting the next signal to the left/right/up/down.

**Peak Search Hor. Threshold.** *Demod and Time modes only.*

Sets the minimum horizontal jump that will be made when selecting the next signal to the left/right/up/down.

For example, when Peak Search Freq. Threshold is set to 1 kHz, the next peak is recognized only if it is 1 kHz or more distant from the first peak (see Figure 3-172).

Example: Peak Search Freq. Threshold = 1 kHz



**Figure 3- 172: Setting the minimum frequency jump**

Use the following steps to set the minimum jump:

1. Press the **Marker Setup** key on the front panel.
2. Press the **Go to page 2 (of 2)** (bottom) side key to show the next menu page.
3. Press either of the following side keys depending on the measurement mode and then set the minimum jump:
  - **Peak Search Freq. Threshold** in the S/A mode
  - **Peak Search Hor. Threshold** in the Demod and Time modes

# Using the Online Help

This section describes the analyzer help system and how to access it.

The online help system is integrated as part of the analyzer user interface, using the Windows help system. You can use the front-panel arrow keys (as in the following procedure), a mouse, or a keyboard to navigate through the help system. See page 3-248 for information about using a mouse or keyboard to navigate through the online help.

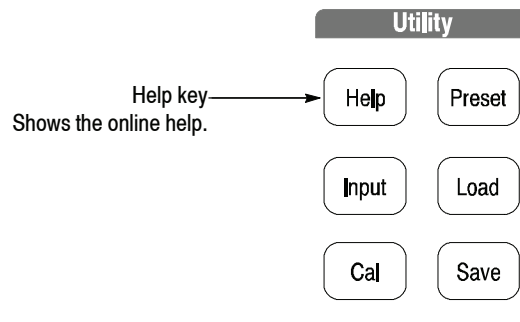
The help system provides information about operating this analyzer, providing the following help resources online:

- Front-panel key descriptions
- Online user manual

## Displaying the Online Help

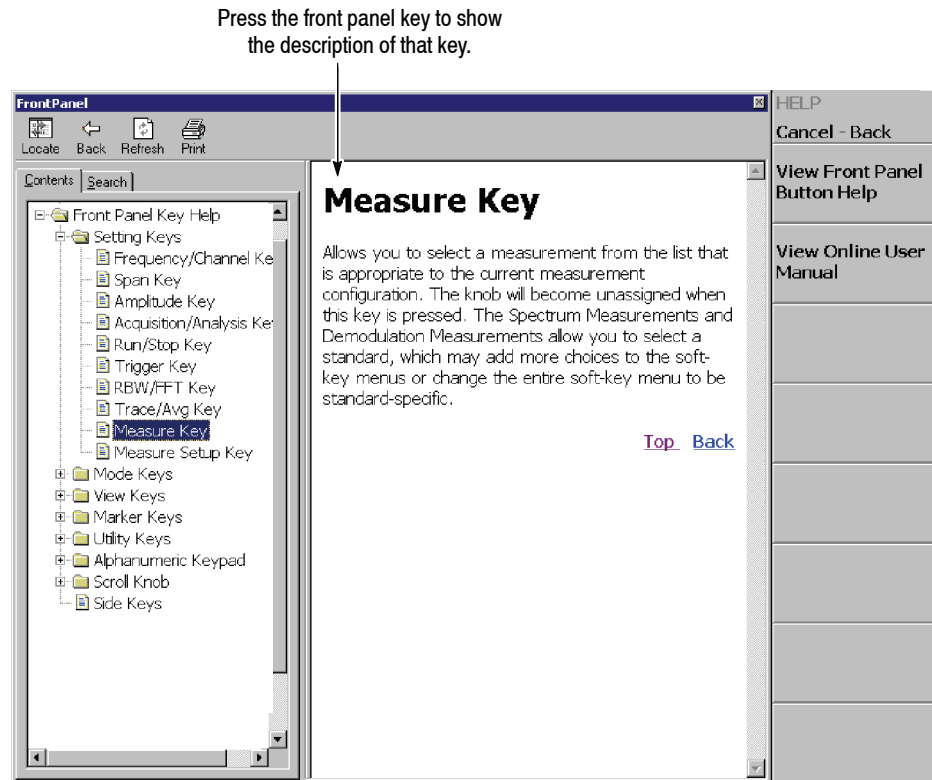
Use the following procedure to show the online help:

1. Press the **Help** key on the front panel.



2. Select the type of online help using the side keys:
  - **View Front Panel Button Help.** Provides descriptions of the front-panel keys.
  - **View Online User Manual.** Displays the analyzer user manual, formatted for online use.

3. Depending on the type of online manual you selected, use one of the following two procedures:
  - If you selected *View Front Panel Button Help*: Press the front-panel key about which you want to receive information. For example, press the **Measure** key to show information about that key (see Figure 3-173).

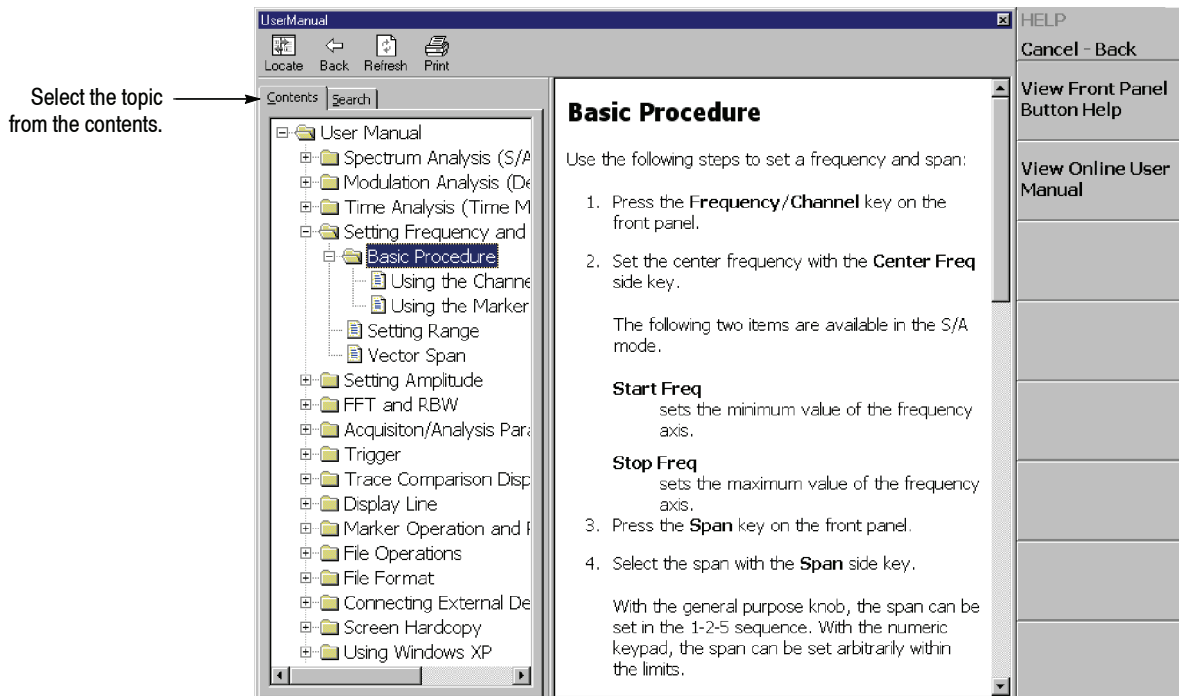


**Figure 3- 173: Online help for the front panel key**

- If you selected *View Online User Manual*: Using the front panel keys listed in Table 3-37, select the topic from the contents window on screen (see Figure 3-174). The key functions are different in the contents (left) window than in the descriptions (right) window.

**Table 3-37: Front panel keys for online help**

Front panel key	Function	
	Contents window	Descriptions window
General purpose knob	Selects a topic.	Scrolls the display up or down.
Up key (▲)	Selects a topic on top in the window.	Scrolls the display up.
Down key (▼)	Selects a topic on bottom in the window.	Scrolls the display down.
Markers: ▲	Selects the next topic up.	Scrolls the display up.
Markers: ▼	Selects the next topic down.	Scrolls the display down.
Markers: ◀	Moves to the next level up.	Scrolls the display to the left.
Markers: ▶	Moves to the next level down.	Scrolls the display to the right.
Peak	Switch the window to operate the cursor.	
Marker ➡	-	Selects a character string with hyperlink.
BKSP	Moves to the next level up.	Returns to the previous display.
Enter	Accepts the selection and displays the corresponding content.	

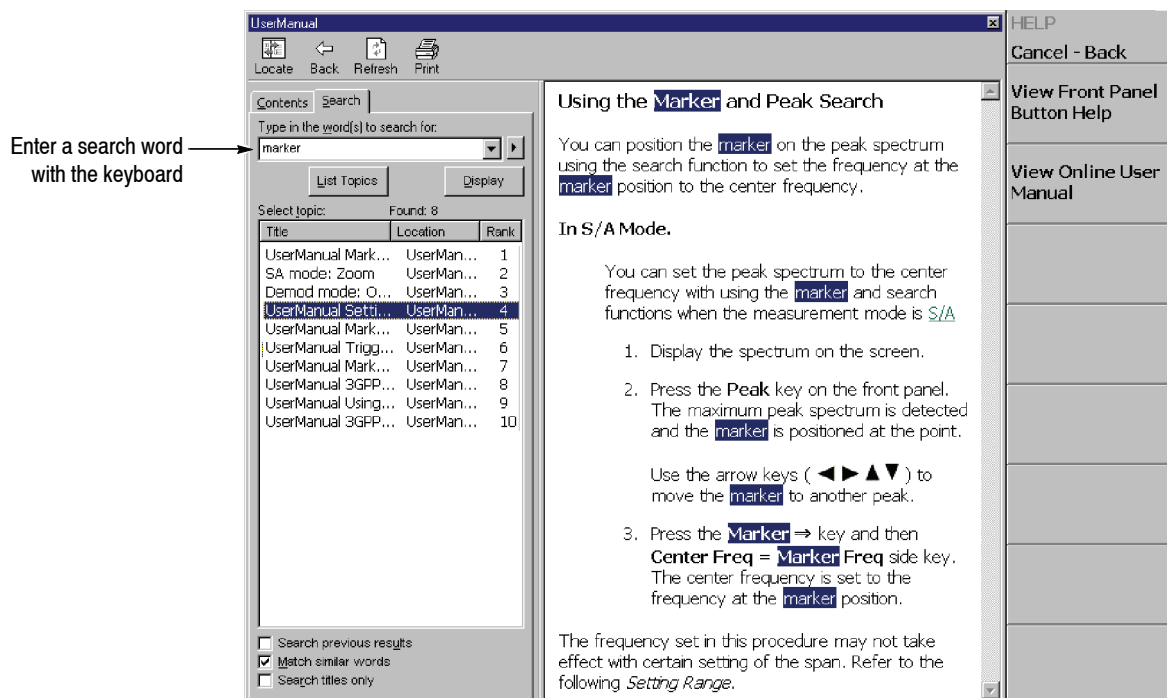
**Figure 3-174: Online user manual**

4. To exit the help system, press the **Cancel-Back** (top) side key.

## Using a Mouse and Keyboard

You can control the help system using a mouse and a keyboard instead of the front panel keys. Using a mouse, click the topic in the contents window to show the description. Using a keyboard, select a topic or enter a search word (see Figure 3-175). Use the arrow keys to move the cursor, and the enter key to accept the selection.

Refer to *Side-Panel Interface* on page 2-6 on connecting a USB mouse and keyboard to the analyzer.



**Figure 3-175: Word search using the keyboard**

# Selecting Input Source

You can select from three input sources in the Input menu: RF, IQ, and Cal.

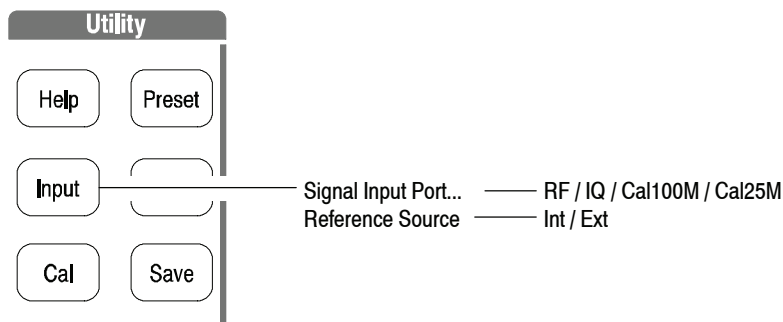


Figure 3-176: Input menu structure

## Input Menu

The Input menu contains the following controls:

**Signal Input Port...** Selects which input is used for signal connection.

- **RF.** *Default.* Uses the signal from the INPUT connector on the front panel. See Figure 2-1 on page 2-2 for the front panel connectors.
- **IQ.** *Option 03 only.* Uses the signal from the I INPUT and Q INPUT connectors on the rear panel. See Figure 2-2 on page 2-4 for the rear panel connectors.

---

**NOTE.** *IQ INPUT (Option 03 only).* The IQ input gain of the analyzer is set in 10 dB steps. To maximize the dynamic range, you may need to adjust the signal level externally, or insert attenuators in the I and Q signal paths.

*When you calibrate the IQ offset, set the IQ input signal level to zero externally. (The IQ offset calibration is included in the center offset calibration. Refer to Calibrating Center Offset on page 1-26.)*

---

- **Cal100M.** Uses the internal calibration signal (100 MHz, -20 dBm). The signal is connected internally. Refer to *Functional Check* on page 1-16 for using the cal signal to check the system performance.
- **Cal25M.** Uses the internal calibration signal (25 MHz, -20 dBm). The signal is connected internally.

**Reference Source.** Selects the source for reference frequency.

- **Int.** Uses the internal clock (10 MHz simulated sine wave).
- **Ext.** Uses the 10 MHz sine wave of -10 to +6 dBm from the REF IN connector on the rear panel when you want to synchronize the analyzer with other instrument(s).

The reference clock is available from the REF OUT connector on the rear panel.



# File Operations

The instrument settings and waveform data can be saved in or loaded from files on the hard disk or 3.5 inch disk. This section contains the following topics:

- File Type
- Load/Save Menu
- Saving and Loading Files
- Entering a File Name
- Deleting a File
- Making/Deleting a Directory

## File Type

The analyzer uses files listed in Table 3-38 to save and load measurement data and settings.

**Table 3-38: Type of files used in the analyzer**

File	Measurement	Description
Status file (.STA)	All	Saves all the current menu settings. You can save the settings you use frequently and reset the analyzer any time by loading the settings from this file.
Data file (.IQT)	Demod and Time modes	Saves time-domain waveform data acquired on the data memory. I, Q, and T stand for in-phase, quadrature phase, and time domain, respectively.
Trace file (.TRC)	S/A mode	Saves Trace 1 or 2. The data in this file is loaded, for example, as the reference waveform in comparison displays between Trace 1 and 2.
Bitmap trace file (.DPT)	DPX spectrum	Saves the Bitmap trace in the display.
Amplitude correction file (.COR)	S/A mode	Saves an amplitude correction table. The data in this file is loaded when the amplitude correction is performed. Refer to page 3-148 for the amplitude correction.
CSV file (.CSV)	Real Time S/A with Zoom, Demod and Time modes	Saves waveform data (IQ data in time domain) in the CSV (Comma Separated Values) format.
	Digital Demod mode	Saves a measurement or reference filter that user defined.
	Spectrum emission mask	Saves a limit mask.
MAT file (.MAT)	Real Time S/A with Zoom, Demod and Time modes	Saves waveform data (IQ data in time domain) in the MATLAB format.

## Load/Save Menu

Figure 3-177 shows the Load/Save menu structure.

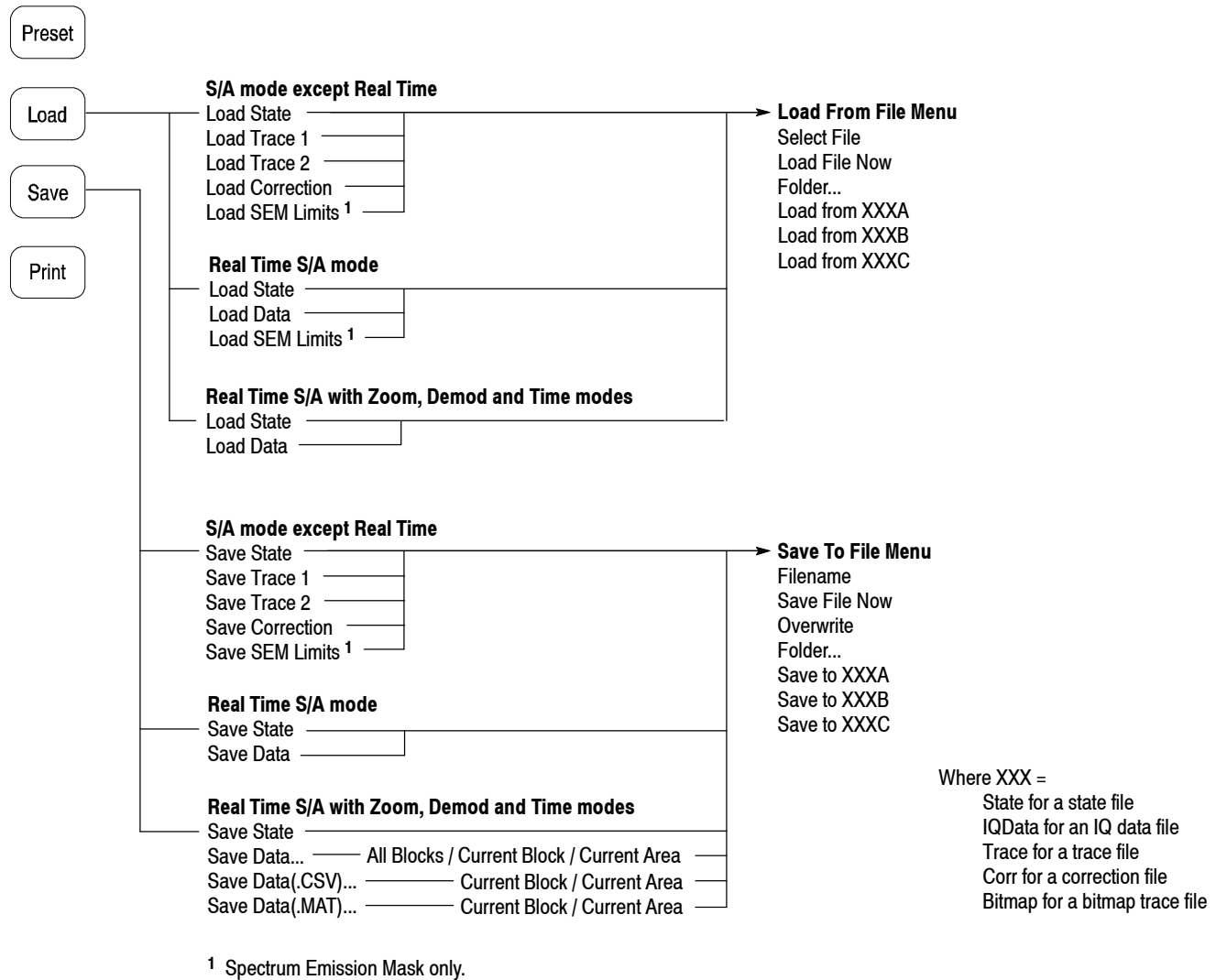


Figure 3- 177: Load/Save menu structure

**Load Menu** Loads waveform data or instrument settings from a file.

**Load State.** Loads the instrument settings.

**Load Data.** *Real Time S/A, Demod, and Time modes only.*  
Loads waveform data (IQ data in the time domain).

---

**NOTE.** *The following menu items (Load Trace 1, Load Trace 2, and Load Correction) are available in the S/A mode except Real Time S/A.*

---

**Load Trace 1.** Loads data for Trace 1 of a graph.

**Load Trace 2.** Loads data for Trace 2 of a graph.

**Load Correction.** Loads a correction table of Frequency/Amplitude pairs used for adjusting amplitude values.

**Load SEM Limits.** *Spectrum Emission Mask in the S/A mode only.*  
Loads a limit mask.

**Save Menu** Saves waveform data or instrument settings to a file.

**Save State.** Saves the instrument settings.

**Save Data.** *Real Time S/A only.*  
Saves waveform data (IQ data in the time domain) to a data file (.iqt).

**Save Data...** *Real Time S/A with Zoom, Demod and Time modes only.*  
Saves waveform data (IQ data in the time domain) to a data file (.iqt).

- **All Blocks.** Saves all the blocks.
- **Current Block.** Saves the block currently displayed.
- **Current Area.** Saves the data displayed in the main view.

**Save Data(.CSV)...** *Real Time S/A with Zoom, Demod and Time modes only.*  
Saves waveform data (IQ data in the time domain) to a file in the CSV (Comma Separated Values) format, allowing you to export the file into Microsoft Excel or other database systems.

- **Current Block.** Saves the block currently displayed.
- **Current Area.** Saves the data displayed in the main view.

**Save Data(.MAT)...** *Real Time S/A with Zoom, Demod and Time modes only.* Saves waveform data (IQ data in the time domain) to a file in the MATLAB format, allowing you to export the file into the MATLAB technical computing environment.

- **Current Block.** Saves the block currently displayed.
- **Current Area.** Saves the data displayed in the main view.

---

**NOTE.** *The data capacity for the .CSV and .MAT files is 256 MB maximum. If exceeding 256 MB, the **Save Data** side key is greyed out to disable saving data.*

---

---

**NOTE.** *The following menu items (Save Trace 1, Save Trace 2, and Save Correction) are available in the S/A mode except Real Time S/A.*

---

**Save Trace 1.** Saves data for Trace 1 of a graph.

**Save Trace 2.** Saves data for Trace 2 of a graph.

**Save Correction.** Saves a correction table of Frequency/Amplitude pairs used for adjusting amplitude values.

**Save SEM Limits.** *Spectrum Emission Mask in the S/A mode only.* Saves a limit mask.

## Saving and Loading Files

The following procedures show how to save and load files.

### Using a Disk

You can use a 2HD (1.44 M bytes) or 2DD (720 K bytes) 3.5-inch disk formatted for MS-DOS. The disk drive is on the side panel. See Figure 2-3 on page 2-6.

### Saving a File

Use the following steps to save settings or waveforms to a file. There are two ways to save data to a file: using the preset file name and entering a new file name. To return to the previous menu, press the **Cancel - Back** side key at any time.

1. Press the **Save** key on the front panel.

2. Press one of the following side keys, depending on the type of data to save.

**Table 3-39: File save operation**

Meas. mode	Side key	Save content	Extension	
S/A (except Real Time S/A)	Save State	Current instrument settings	.sta	
	Save Trace 1	Trace 1 waveform	.trc, .dpt <sup>1</sup>	
	Save Trace 2	Trace 2 waveform	.trc, .dpt <sup>1</sup>	
	Save Correction	Amplitude correction data	.cor	
	Save SEM Limits	Limit mask <sup>2</sup>	.csv	
Real Time S/A	Save State	Current instrument settings	.sta	
	Save Data	Acquired data in time domain	.iqt	
	Save SEM Limits	Limit mask <sup>2</sup>	.csv	
Real Time S/A with Zoom, Demod and Time	Save State	Current instrument settings	.sta	
	Save Data...	Acquired data in time domain	.iqt	
		All Blocks		Data of all blocks
		Current Block		Data of the block currently displayed
	Current Area	Data currently shown in the main view		
	Save Data(.CSV)...	Acquired data in time domain	.csv	
		Current Block		Data of the block currently displayed
		Current Area		Data currently shown in the main view
	Save Data(.MAT)...	Acquired data in time domain	.mat	
		Current Block		Data of the block currently displayed
Current Area		Data currently shown in the main view		

<sup>1</sup> .dpt is only for the Bitmap trace in the DPX spectrum.

<sup>2</sup> Spectrum emission mask only.

3. *To use a preset file name:* Press the **Save to file name** side key.  
(To enter a new file name, skip to step 4.)

There are three preset names for each file type as shown in Table 3-40.

**Table 3-40: Preset file names**

File type	Save file name
State (.sta)	StateA, StateB, StateC
IQ data (.iqt)	IQDataA, IQDataB, IQDataC
Trace (.trc)	TraceA, TraceB, TraceC
Bitmap trace (.dpt) <sup>1</sup>	BitmapA, BitmapB, BitmapC
Correction (.cor)	CorrA, CorrB, CorrC
Measurement table (.csv)	TableA, TableB, TableC

<sup>1</sup> **DPX spectrum only.**

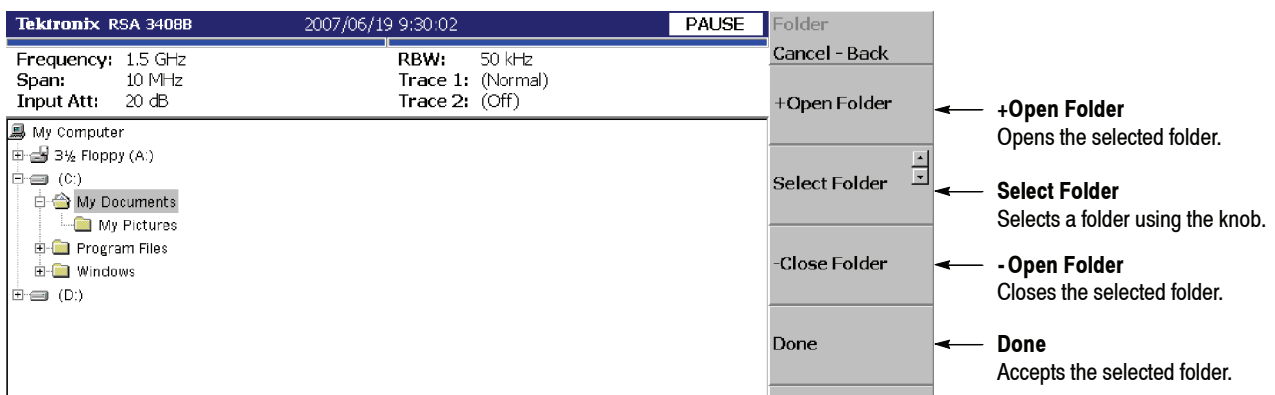
The file extension is automatically added according to the file type.

**NOTE.** *The preset files are always saved in the My Documents folder on the C: drive even if you select another folder.*



**Figure 3- 178: Save to the preset file (lower right of the screen)**

4. To enter a new file name:
  - a. Press the **Folder...** side key to select the destination folder using the following menu items (see Figure 3-179):
    - **+Open Folder** opens the selected folder.
    - **Select Folder** selects a folder.
    - **-Close Folder** closes the selected folder.
    - **Done** accepts the selected file.



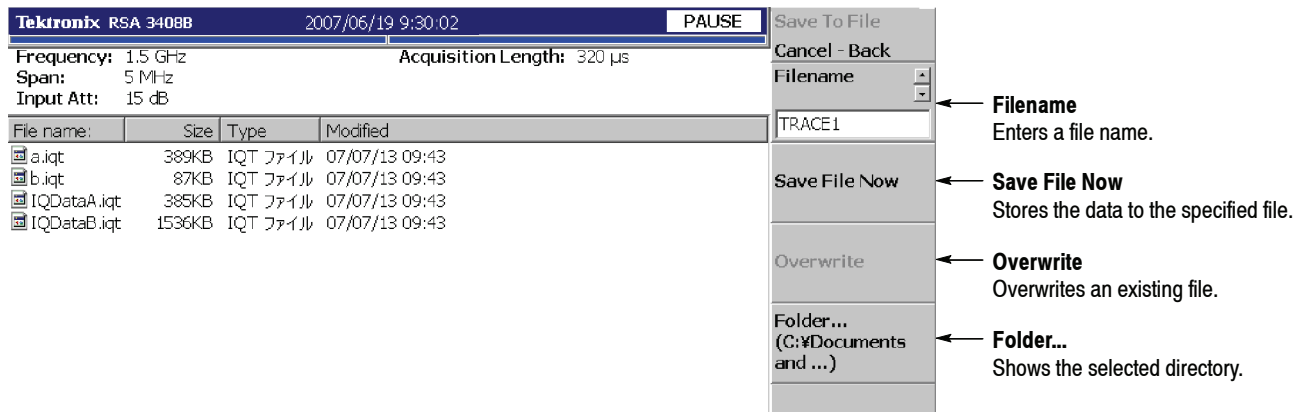
**Figure 3-179: Selecting the folder**

- b. After selecting the folder, press the **Done** side key to accept it. The list of files in the selected folder appears, displaying only files with the same extension as the file to be stored.

- c. Press the **Filename** side key (see Figure 3-180) and enter a file name using the front-panel keypad. The file extension is automatically added. Refer to *Entering a File Name* on page 3-262 for details about how to enter the name.

Here are instructions to input “TRACE1” for example, using the front-panel keypad.

- Press the **TUV** (number **2**) key once to select the letter “T”, and then press the **Enter** key.
- Press the **PQRS** (number **1**) key three times to select the letter “R”, and then press the **Enter** key.
- Press the **ABC** (number **8**) key once to select the letter “A”, and then press the **Enter** key.
- Press the **ABC** (number **8**) key three times to select the letter “C”, and then press the **Enter** key.
- Press the **DEF** (number **9**) key twice to select the letter “E”, and then press the **Enter** key.
- Press the **PQRS** (number **1**) key five times to select the letter “1”, and then press the **Enter** key.



**Figure 3- 180: Save to File menu**

- d. After entering the file name, press the **Save File Now** side key. The data is saved to the specified file.

*If the file already exists in the specified folder.*

The message “File already exists. Do you want to overwrite it?” appears at the bottom of the screen. When you overwrite the file, press the **Overwrite** side key. Otherwise go back to step c to enter another name.



**Loading a File**

Use the following steps to load settings or waveform from a file. There are two ways to load data from a file: selecting the preset file and selecting a file by name. When you want to return to the previous menu, press the **Cancel - Back** side key at any time.

1. Press the **Load** key on the front panel.
2. Press one of the side keys according to the type of data to load.

**Table 3-41: File load operation**

Meas. mode	Side key	Load content	Extension
S/A (except Real Time S/A)	Load State	Instrument settings	.sta
	Load Trace 1	Trace 1 waveform	.trc, .dpt <sup>1</sup>
	Load Trace 2	Trace 2 waveform	.trc, .dpt <sup>1</sup>
	Load Correction	Amplitude correction data	.cor
	Load SEM Limits	Limit mask <sup>2</sup>	.csv
Real Time S/A, Demod or Time	Load State	Instrument settings	.sta
	Load Data	Acquired data in time domain	.iqt
	Load SEM Limits	Limit mask <sup>2</sup>	.csv

<sup>1</sup> .dpt is only for the Bitmap trace in the DPX spectrum.

<sup>2</sup> Spectrum emission mask in the S/A mode only.

---

**NOTE.** In the Real Time S/A, Demod, and Time modes, when you abort data acquisition before it is completed, such as in a trigger-armed state, the last data block is empty. Therefore, when you save all the blocks to a file and then load the file, the waveform does not appear at first. If you have acquired multiple blocks, select an old block to display the waveform.

---

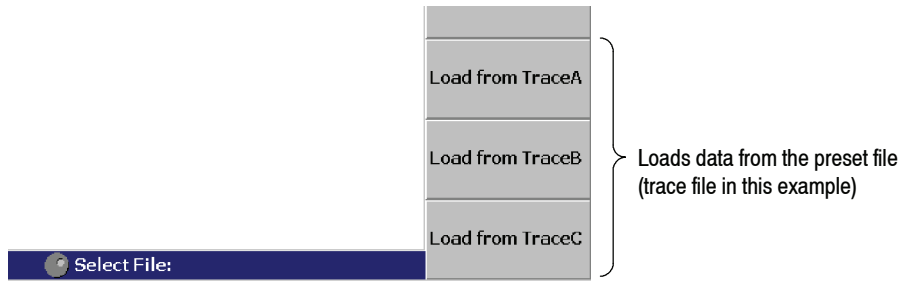
3. To select the preset file: (To select a file by name, skip to step 4.)  
To select the preset file to which you have saved data in step 3 on page 3-256, press the **Load from file name** to load the data (see Figure 3-181).

---

**NOTE.** The preset file must be in the My Documents folder on the C: drive.

If you have not saved any data to the preset file that you select, the error message “File name not found” appears on the bottom left of the screen.

---



**Figure 3- 181: Load from the preset file (lower right of the screen)**

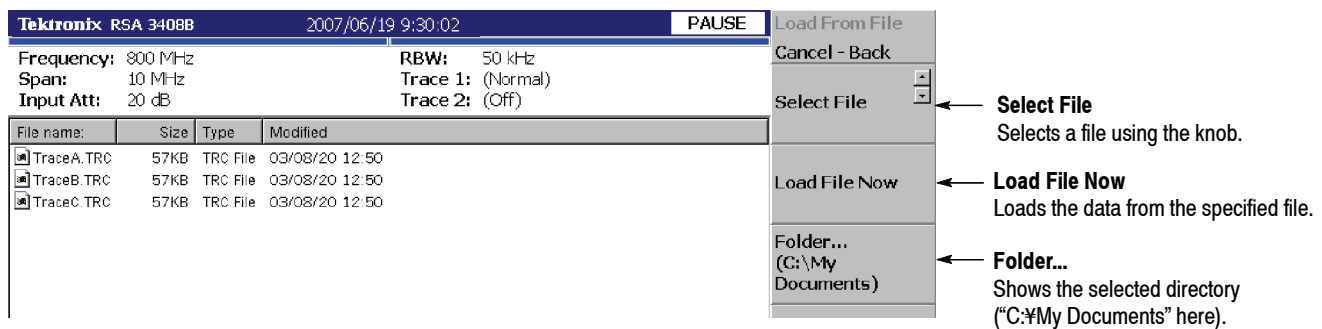
**4. To select an existing file:**

- a. Press the **Folder...** side key. Select the folder containing the file to load. (For a file select procedure, see step 4 on page 3-257.)
- b. After selecting the folder, press the **Done** side key to accept it.

The list of files in the selected folder appears, displaying only files with the same extension as the file to be loaded.

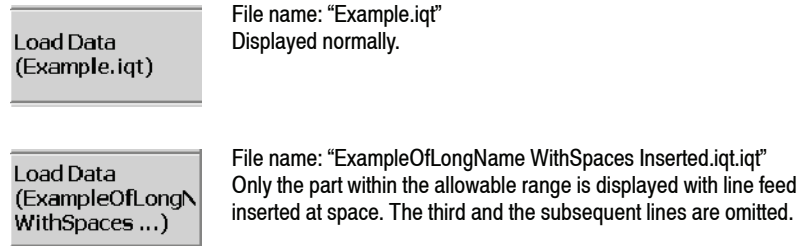
- c. Press the **Select File** side key and then select the file from the list using the general purpose knob.
- d. After selecting the file, press the **Load File Now** side key. See Figure 3-182.

The data is loaded from the specified file.



**Figure 3- 182: Load from File menu**

**Displaying the File Name on the Load Data Side Key.** *RFID analysis (Option 21) and WLAN analysis (Option 29) only.* In the RFID and WLAN analyses, when you load an .iqt file, the file name appears on the **Load Data** side key. Because of the limitation of display area, if the number of characters exceed the limit, only the part within the allowable range will be displayed with line feed inserted at space if any (see Figure 3-183).



**Figure 3-183: Displaying the file name on the Load Data side key**

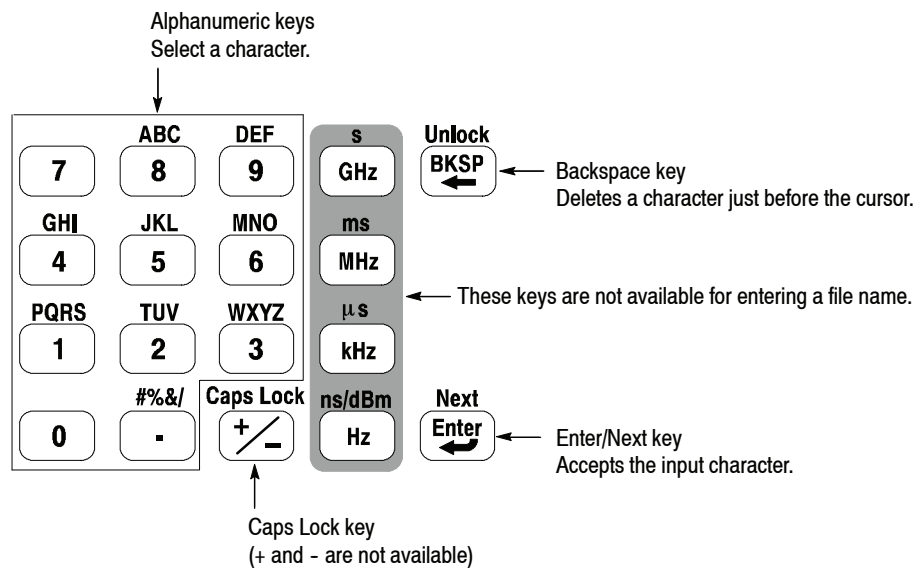
## Entering a File Name

This section shows how to enter a file name in the **Filename** side key for saving the file using the Save menu.

**NOTE.** You can overwrite an existing file; after entering the file name, press **Save File Now > Overwrite**.

Use the keypad on the front panel to input a file name (see Figure 3-184).

- **0** to **9** and **“.”** keys are used to enter alphabetic characters, numbers, punctuation and special characters indicated above each key. For example, the **8** key inputs A, B, and C, as well as 8. Each time you press the key, the selected character moves through the list: A → B → C → 8 ...
- **Caps Lock** key toggles a character between uppercase and lowercase.
- **BKSP** (backspace) key deletes the character just before the cursor.
- **Enter/Next** key accepts the input character.

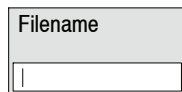


**Figure 3-184: Alphanumeric keypad**

**Procedure** To enter a new name, SAMPLE1, use the following steps:

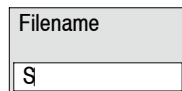
1. Press the **Filename** side key.

The cursor appears on the left end in the text box.



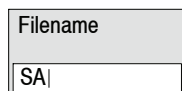
A screenshot of a rectangular text box with a light gray header labeled "Filename". Below the header is a white text input field with a vertical cursor (blinking line) at the left end.

2. Press the **PQRS** key on the keypad four times to enter "S".



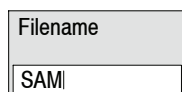
A screenshot of the "Filename" text box. The input field now contains the letter "S" and the cursor is positioned to the right of it.

3. Press the **ABC** key on the keypad once to enter "A".



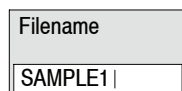
A screenshot of the "Filename" text box. The input field now contains the characters "SA" and the cursor is positioned to the right of them.

4. Press the **MNO** key on the keypad once to enter "M".



A screenshot of the "Filename" text box. The input field now contains the characters "SAM" and the cursor is positioned to the right of them.

5. Enter the remaining characters in the same way.



A screenshot of the "Filename" text box. The input field now contains the full filename "SAMPLE1" and the cursor is positioned to the right of the final character.

If you make a mistake, you can correct it any time before pressing the **Enter** key by repeatedly pressing **BKSP** (the backspace key) until the incorrect character disappears and then typing the correct value. If you want to restart from the beginning, press the **Cancel - Back** (top) side key. You can also move the insertion cursor using the general purpose knob or up/down keys.

## **Deleting a File**

You can delete a file using Windows, but not using the analyzer menu. Refer to page 2-27 for information about using Windows on the analyzer. Refer to Windows documentation for additional information about operating Windows.

## **Making/Deleting a Directory**

You can make or delete a directory using Windows, but not using the analyzer menu. Refer to page 2-27 for information about using Windows on the analyzer. Refer to Windows documentation for additional information about operating Windows.

# File Format

This section describes the structure of the following files:

- Data file (\*.IQT)
- Trace file (\*.TRC)
- DPX Bitmap trace (\*.DPT)
- CSV (Comma Separated Values) file (\*.CSV)
- MAT (MATLAB) file (\*.MAT)
- Limit mask file (\*.CSV)
- User filter file (\*.CSV)

## Data File Format

**File Structure** The data file normally consists of five blocks. The date and time may be added to the end for data logging (see Figure 3-185).

Data file (\*.IQT)

File header (text format)
Data block (binary format)
Correction data block (binary format)
Dummy header (text format)
Extended correction data block (binary format)
Date and time (text format)

**Figure 3- 185: Data file structure**

The file is normally created after data acquisition is complete. When logging data is acquired continuously, a data block is added each time the data is acquired.

In data logging, since the internal program adds data blocks while acquiring data, when the program creates the file header, the date and time for the last frame is not known. The program, therefore, adds date and time data to the end of the file. If you examine the file size and find the date and time at the end, use them in place of *DateTime* in the file header. Refer to *DateTime* on page 3-269 for the format of date and time.

The number of frames *ValidFrames* (refer to page 3-269) is not known at the time the program creates the file header, so the internal program temporarily writes *ValidFrames=0*. If the value of *ValidFrames* of the file header is 0, examine the file size and calculate the true value of *ValidFrames*. In this case, the correction data block, the dummy header, and the extended correction data block are always added.

The subsections below provide details on each block.



**File Header** The following is an example of the file header. Although Type is always written at the beginning, the order of the other items is not fixed and some new items may be added.

```
40416Type=RSA3408BIQT
FrameReverse=Off
FramePadding=Before
Band=RF3
MemoryMode=Zoom
FFTPoints=1024
Bins=801
MaxInputLevel=0
LevelOffset=0
CenterFrequency=7.9G
FrequencyOffset=0
Span=5M
BlockSize=40
ValidFrames=40
FramePeriod=160u
UnitPeriod=160u
FrameLength=160u
DateTime=2005/01/10@13:21:16
GainOffset=-82.3326910626668
MultiFrames=1
MultiAddr=0
IOffset=-0.0475921630859375
QOffset=0.12628173828125
```

The first character “4” indicates that the number of bytes of the file header is expressed with four characters after the second character.

In the preceding example:

Number of bytes of the file header = 1 + 4 + 0416 = 421

The number of bytes is therefore 421. Data starts from the 422<sup>nd</sup> byte.

Descriptions of the file header items follow.

**Type.** Shows the type of data. In the RSA3408B analyzer, only this type is used:

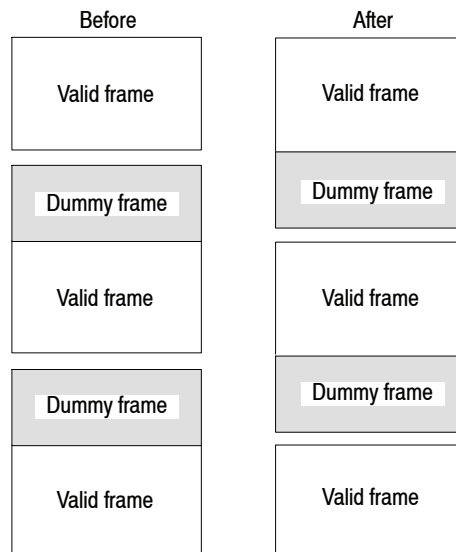
- **RSA3408BIQT.** The data block contains I and Q values in the time domain. It is upward compatible with the \*.IQT file of the WCA300 series.

**FrameReverse.** Shows the frame order. This item is always Off in the RSA3408B analyzer. The following parameters are provided:

- **Off.** Frames are stored in the order of acquisition. The last frame in the data block is the latest acquired frame.
- **On.** Frames are stored in the reverse order of acquisition. The first frame in the data block is the latest acquired frame.

**FramePadding.** The analyzer adds dummy frames when acquired frames do not fill BlockSize (block size). Figure 3-186 shows the dummy frames. The FramePadding parameter is always set to Before in the RSA3408B analyzer.

- **Before.** Adds dummy frames before valid frames, but not in the first block.
- **After.** Adds dummy frames after valid frames, but not in the last block.



**Figure 3- 186: Adding dummy frames**

**Band.** Shows the frequency band that was set when the analyzer acquired the data. It is necessary only when the analyzer reloads the data.

**MemoryMode.** Shows the memory mode that was set when the analyzer acquired the data. It is necessary only when the analyzer reloads the data.

**FFTPoints.** Shows the FFT point setting that was set when the analyzer acquired the data. This item is always 1024 in the RSA3408B analyzer.

**Bins.** Shows the number of bins. The same value is also entered in *bins* of each frame header of the data block (refer to *Frame Header* on page 3-270).

**MaxInputLevel.** Shows the reference level setting in dBm when the analyzer acquired the data.

**LevelOffset.** Shows the level offset setting in dB when the analyzer acquired the data.

**CenterFrequency.** Shows the center frequency setting in Hz when the analyzer acquired the data.

**FrequencyOffset.** Shows the frequency offset setting in Hz when the analyzer acquired the data.

**Span.** Shows the span setting in Hz when the analyzer acquired the data.

**BlockSize.** Shows the block size setting when the analyzer acquired the data.

**ValidFrames.** Shows the number of frames in the data block. This value divided by MultiFrames represents the number of frames that are scanned and synthesized into one frame.

**FramePeriod.** Shows the frame period setting in seconds. The actual period is obtained by multiplying UnitPeriod by the difference of time stamp ticks of each frame in the data block.

**UnitPeriod.** Shows the unit time in seconds of time stamp Ticks of each frame in the data block.

**FrameLength.** Shows the time in second necessary to acquire one frame.

**DateTime.** Shows the time when the analyzer acquired the last frame in a data block. You can change “@” to “ ” (space) for display because files may have many “@” characters.

**GainOffset.** Shows the gain offset. It is used for calculating the amplitude (refer to page 3-272).

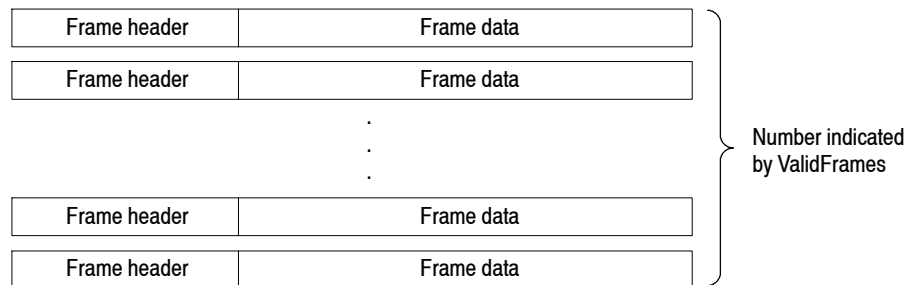
**MultiFrames.** Shows the number of frames in multi-frame mode. For example, when MultiFrames = 20, scanning 20 times with a span of 5 MHz makes a span of 100 MHz.

**MultiAddr.** Shows the last frame address in the multi-frame mode. The range is 0 to MultiFrames -1. MultiFrames -1 indicates that the data ends just at the end of scans.

**IOffset.** Shows the offset value of I data. It is used for calculating the data value (refer to page 3-272).

**QOffset.** Shows the offset value of Q data. It is used for calculating the data value (refer to page 3-272).

**Data Block** Each data block contains several pairs of frame header and frame data (see Figure 3-187). The number of pairs in a block is indicated by ValidFrames in the file header. The frame order is determined by FrameReverse in the file header.



**Figure 3- 187: Data block**

**Frame Header** The frame header is defined by the following structure:

```
struct frameHeader_st {
    short reserved1;
    short validA;
    short validP;
    short validI;
    short validQ;
    short bins;
    short reserved2;
    short triggered;
    short overLoad;
    short lastFrame;
    unsigned long ticks;
};
```

Descriptions of the frame header items follow.

**short reserved1.** Internal use only.

**short validA, validP, validI, validQ.** These parameters indicate whether data of amplitude, phase, I or Q (value converted into a two-byte signed integer) is written.

- **0.** Indicates that data is not written in the file.
- **-1.** Indicates that data is written in the file.

There are seven combinations as listed in Table 3-42.

**Table 3-42: Combinations of valid A, P, I and Q**

validA	validP	validI	validQ
0	0	0	0
-1	0	0	0
0	-1	0	0
-1	-1	0	0
0	0	-1	0
0	0	0	-1
0	0	-1	-1

**short bins.** Shows the number of bins. It is the same as Bins in the file header.

**short reserved2.** Internal use only.

**short triggered.** Indicates whether the frame is before or after the trigger.

- **0.** Indicates that the frame is before the trigger (pre-trigger).
- **-1.** Indicates that the frame is after the trigger (post-trigger).

**short overLoad.** Indicates whether an input overload occurred.

- **0.** Indicates that the MaxInputLevel value in the file header was correct.
- **-1.** Indicates that the MaxInputLevel value in the file header was too low.

**short lastFrame.** The analyzer can divide its memory into (100 frames) × (40 blocks), for example. LastFrame indicates the last frame in a block.

- **0.** Indicates that the frame is not the last in the block.
- **-1.** Indicates that the frame is the last in the block.

**unsigned long ticks.** Shows a time stamp using UnitPeriod in the file header (not FramePeriod) as a unit time.

**Frame Data** A frame contains 1024 pairs of I and Q data in the time domain in order of data acquisition.

**Definition of Bin.** The bin is defined by the following structure:

```
struct iqBin_st {  
    short q;  
    short i;  
};
```

**Definition of Frame.** The frame is defined by the following structure:

```
struct iqFrame1024_st {  
    struct iqBin_st iq[1024];  
};
```

**Calculation of Data** All the data of amplitude, phase, I and Q are transformed to 2-byte signed integers, and then written in the file.

**Amplitude.** The amplitude is calculated using i and q in the IQT file using these formulas:

```
i = i - IOffset  
q = q - QOffset  
Amplitude = 10 * ln(i * i + q * q) / ln(10)  
            + GainOffset + MaxInputLevel + LevelOffset [dBm]
```

**Phase.** The phase is calculated using i and q in the IQT file using these formulas:

```
i = i - IOffset  
q = q - QOffset  
Phase = atan2(q, i) * (180 / Pi) [degree]
```

**I, Q.** I and Q are calculated using i and q in the IQT file using these formulas.

```
i = i - IOffset  
q = q - QOffset  
IQScale = Sqrt(Power(10, (GainOffset + MaxInputLevel  
                    + LevelOffset) / 10) / 20 * 2)  
I = i * IQScale [V]  
Q = q * IQScale [V]
```

### Correction and Extended Correction Data Blocks

The correction data block contains gain and phase correction data as one frame of data block in the frequency domain. The extended correction data block contains the next lower byte of the correction data.

When these blocks are added, the amplitude and phase are calculated using the following formulas. Be careful about the sign for phase correction.

$$\text{Amplitude [dBm]} = (\text{Original data}) - (((\text{Gain correction data} \ll 8) \mid (\text{Extended gain correction data} \& 0x000000ff)) / (128 * 256))$$

$$\text{Phase [degrees]} = (\text{Original data}) + (((\text{Phase correction data} \ll 8) \mid (\text{Extended phase correction data} \& 0x000000ff)) / (128 * 256))$$

**Definition of Bin.** The bin is defined by the following structure:

```
struct apBin_st {
    short a;
    short p;
};
```

**Definition of Frame.** The frame is defined by the following structure:

```
struct apFrame1024_st {
    struct apBin_st ap[1024];
};
```

**Definition of Extended Correction Data Block.** The extended correction data block is defined by the following structure:

```
struct extendedCorrectionData_st {
    unsigned char a[1024];
    unsigned char p[1024];
};
```

**Dummy Header** The dummy header contains the ASCII codes of “40000” with no line feed code.

## Trace File Format

**File Structure** The trace file have two blocks in the text format as shown in Figure 3-188.

```

# XNum=641
# XRightLabel=Span
# XStart=1.9995G
# XScale=1.0015625M
# XUnit=Hz
# ZNum=1
# YStart=-100
# XLeftLabel=Center
# UpdateAreas=1
# YUnit=dBm
# NBW=3.13180146596413k
# YMiddleUnit=dB
# YScale=100
# UpdatePosition=640
-100.875531204    0
-111.253515034   0
-101.342080442   0
-96.7588947616   0
-98.5946571418   0
-101.68696219    0
-97.8503895777   0
-100.806522438   0
-100.274828469   0
-95.8906131833   0
-97.9340093534   0
-101.366985559   0
...

```

} File header (text format)

} Data block (text format)

**Figure 3- 188: Trace file (.TRC) structure**

### File Header

The file header contains the following information.

“*Required*” means that the item is prerequisite for displaying waveform.

**XNum.** *Required.* Represents the number of data in the data block.

**XRightLabel.** Represents the label displayed on the right of the horizontal axis: Span (span) when XLeftLabel is Center (center frequency), or Stop (stop frequency) when XLeftLabel is Start (start frequency).

**XStart.** *Required.* Represents the minimum (left) edge of the horizontal axis.

**XScale.** *Required.* Represents the scale of the horizontal axis.

**XUnit.** Represents the unit of the horizontal axis: fixed to Hz.

**ZNum.** *Required.* Internal use only: fixed to 1.

**YStart.** *Required.* Represents the minimum (bottom) edge of the vertical axis.



**XLeftLabel.** Represents the label on the left of the horizontal axis: Center (center frequency) when XLeftLabel is Span (span), or Start (start frequency) when XLeftLabel is Stop (stop frequency).

**UpdateAreas.** Internal use only.

**YUnit.** Represents the unit of the vertical axis: dBm, dB $\mu$ V, V, or W.

**NBW.** Specifies NBW (Noise Bandwidth) when setting FFT parameters, or RBW (Resolution Bandwidth) when setting RBW parameters.

**YMiddleUnit.** Represents the unit of the vertical axis scale. Specify dB when YUnit is dBm. For all other values of YUnit, the YUnit value is used.

**YScale.** *Required.* Represents the scale of the vertical axis.

**UpdatePosition.** Internal use only.

**Data Block** Pairs of a power value and a mask value are written in order, with a tab between the power and the mask (see the figure below). The number of lines is indicated by XNum in the file header.

Power 1	(tab)	Mask 1	}	Number indicated by XNum
Power 2	(tab)	Mask 2		
Power 3	(tab)	Mask 3		
.				
.				
Power N	(tab)	Mask N		

Part of the data block might look like this:

-100.875531204	0
-111.253515034	0
-101.342080442	0
-96.7588947616	0
-98.5946571418	0
...	

For example, the first line indicates that the power is -100.875531204 dBm and the mask value is 0.

**Mask Value.** The mask value represents whether to display the data.

- **0.** Indicates that the data is displayed.
- **-1.** Indicates that the data is not displayed.

## Bitmap Trace File Format

**File Structure** The Bitmap trace file have two blocks in the text format as shown in Figure 3-189.

```

# XNum=501
# XUnit=Hz
# XRightLabel=Span
# XLeftLabel=Center
# YUnit=dBm
# YMiddleUnit=dB
# ZNum=1
# XStart=1482000000.0
# XScale=36072000.0
# YStart=-100.0
# YScale=100.0
# NBW=500592.25
# Bitmap=1
# ROWS=201
# COLS=501
32572
3464
0
1638
1638
1638
0
0
4914
3276
0
3276
1638
...

```

} File header (text format)

} Data block (text format)

**Figure 3-189: Bitmap trace file (.DPT) structure**

**File Header** The file header contains the following information.  
“*Required*” means that the item is prerequisite for displaying waveform.

**XNum.** *Required.* Fixed to 501 (= COLS).

**XUnit.** Represents the unit of the horizontal axis: fixed to Hz.

**XRightLabel.** Represents the label displayed on the right of the horizontal axis:  
Span (span) when XLeftLabel is Center (center frequency), or  
Stop (stop frequency) when XLeftLabel is Start (start frequency).

**XLeftLabel.** Represents the label on the left of the horizontal axis:  
Center (center frequency) when XLeftLabel is Span (span), or  
Start (start frequency) when XLeftLabel is Stop (stop frequency).

**YUnit.** Represents the unit of the vertical axis: fixed to dBm.

**YMiddleUnit.** Represents the unit of the vertical axis scale: fixed to dB.

**ZNum.** *Required.* Internal use only: fixed to 1.

**XStart.** *Required.* Represents the minimum (left) edge of the horizontal axis.

**XScale.** *Required.* Represents the scale of the horizontal axis.

**YStart.** *Required.* Represents the minimum (bottom) edge of the vertical axis.

**YScale.** *Required.* Represents the scale of the vertical axis.

**NBW.** Specifies RBW (Resolution Bandwidth).

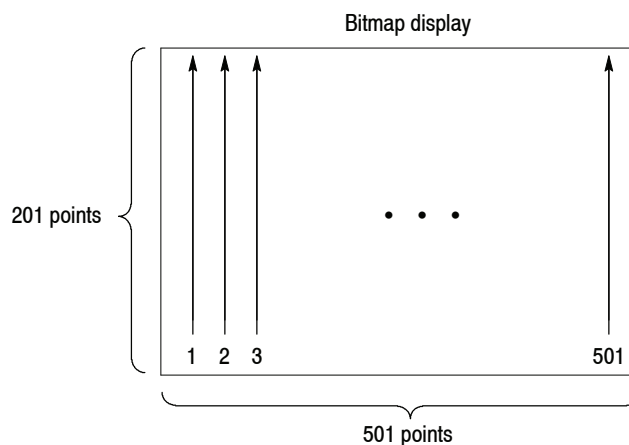
**Bitmap.** *Required.* Indicates that the trace is the bitmap: fixed to 1.

**ROWS.** Represents the number of data points along the vertical axis on the Bitmap display: fixed to 201.

**COLS.** Represents the number of data points along the horizontal axis on the Bitmap display: fixed to 501.

### Data Block

The normalized number of occurrences is written in integer values for each data point in the order shown in Figure 3-190: from bottom up for each column from left to right on the Bitmap display.



**Figure 3-190: Data sequence for writing to the Bitmap trace file**

## CSV File Format

The acquisition data files saved in CSV format have two sections.

At the top of the file is the following header information:

**SamplingFrequency.** The sampling frequency in Hertz.

**NumberSamples.** The number of IQ samples in the file.

**DateTime.** When the data was acquired.

**Frequency.** The center frequency in Hertz.

**AcquisitionBandwidth.** The acquisition bandwidth in Hertz.

Following the AcquisitionBandwidth are the data. The data are IQ pairs, in Volts.

## MAT File Format

The acquisition data files saved in MatLab format contain the following MatLab variables:

**InputCenter.** The center frequency in Hertz.

**XDelta.** The sample period in seconds.

**Y.** A complex array containing IQ pairs.

**InputZoom.** Always 1, and indicates complex data.

## Limit Mask File Format

This section describes the limit mask file used in the spectrum emission mask measurement (refer to page 3-14) in the S/A mode.

The limit mask file contains the limit setting values for each zone in the CSV format. The contents depends on the setting of Meas Setup > Measurement (Offset From Channel or Inband Spurious). Figure 3-191 shows an example of settings for Zone A, B, and C.

**Meas Setup > Measurement is set to Offset From Channel:**

```
Offset From Channel:A,Yes,750k,1.98M,30k,Both,Relative,0,0,-45,-45
Offset From Channel:B,Yes,1.98M,4M,30k,Both,Rel OR Abs,-27,-27,-55,-55
Offset From Channel:C,Yes,4M,20M,1M,Both,Absolute,-36,-36,0,0
```

**Meas Setup > Measurement is set to Inband Spurious:**

```
Inband Spurious:A,Yes,1G,3G,1M,Absolute,-36,-36,0,0
Inband Spurious:B,No,0,0,30k,Absolute,0,0,0,0
Inband Spurious:C,No,0,0,30k,Absolute,0,0,0,0
```

**Figure 3-191: Limit mask file example**

One row consists of 11 fields (Offset From Channel) or 10 fields (Inband Spurious). As shown in Table 3-43, the second and subsequent fields indicate the setting values of Meas Setup > Limits... Refer to Table 3-3 on page 3-17 for the Limits menu items.

**Table 3-43: Limit mask file format**

Field	Offset From Channel	Inband Spurious
1	Offset From Channel: (Zone number)	Inband Spurious: (Zone number)
2	Enable setting value	Enable setting value
3	Beginning Frequency setting value	Beginning Frequency setting value
4	Ending Frequency setting value	Ending Frequency setting value
5	Resolution Bandwidth setting value	Resolution Bandwidth setting value
6	Offset from Carrier setting value	Fail if signal exceeds setting value
7	Fail if signal exceeds setting value	Beginning Abs Limit setting value
8	Beginning Abs Limit setting value	Ending Abs Limit setting value
9	Ending Abs Limit setting value	Beginning Rel Limit setting value
10	Beginning Rel Limit setting value	Ending Rel Limit setting value
11	Ending Rel Limit setting value	NA

---

**NOTE.** If you omit setting for a field, the default value is used. If you omit settings for a zone, the default value is used for all fields.

---

## User Filter File Format

The user filter file is available in the digital modulation analysis (Digital Demod, Option 21 only). It stores the user-defined measurement or reference filter coefficient data in the CSV format. Figure 3-192 shows the file structure.

```
# Rate
10
# FilterI,FilterQ
0.97321,0.01947
0.89559,0.04051
0.77497,0.05942
0.62333,0.07202
0.45524,0.07438
0.28614,0.06354
...
0.13045,0.01947
```

**Figure 3-192: User filter file structure**

The filter file contains the following variables:

**Rate.** Specifies the oversampling rate (the number of samples per symbol). The filter coefficient data will be interpolated by the specified rate.

**FilterI,FilterQ.** Specifies IQ pairs (1 to 1024) of the filter coefficient in time domain.

### Rules for Creating a Filter File.

- A line beginning with “#” is a comment line.
- Enter a positive value for the oversampling rate.
- A decimal number can be expressed by fixed point or floating point. For example, 0.01 and 1.0E-2 are both valid.
- “0” (zero) and “,0” (comma zero) can be omitted. For example, “1.5,0”, “1.5,”, and “1.5” are equivalent.
- Lines with only a comma and blank lines are skipped.

**Example Filters.** For your reference, two example filters, Raised Cosine and Gaussian, are shown here, both containing 65 data points with the oversampling rate of 8.

**Raised Cosine ( $\alpha=0.3$ )**

(Row 1 to 18)	(Row 19 to 36)	(Row 37 to 54)	(Row 55 to 68)
# Rate	0.0383599,0	0.973215,0	0.0743803,0
8	0,0	0.895591,0	0.0720253,0
# FilterI,FilterQ	-0.047715,0	0.774975,0	0.0594205,0
0,0	-0.0984502,0	0.623332,0	0.0405144,0
-0.0062255,0	-0.143898,0	0.455249,0	0.0194761,0
-0.0136498,0	-0.174718,0	0.286147,0	0,0
-0.0209294,0	-0.181776,0	0.130455,0	-0.0151973,0
-0.0263419,0	-0.157502,0	0,0	-0.0246357,0
-0.0280807,0	-0.0971877,0	-0.0971877,0	-0.0280807,0
-0.0246357,0	0,0	-0.157502,0	-0.0263419,0
-0.0151973,0	0.130455,0	-0.181776,0	-0.0209294,0
0,0	0.286147,0	-0.174718,0	-0.0136498,0
0.0194761,0	0.455249,0	-0.143898,0	-0.0062255,0
0.0405144,0	0.623332,0	-0.0984502,0	0,0
0.0594205,0	0.774975,0	-0.047715,0	
0.0720253,0	0.895591,0	0,0	
0.0743803,0	0.973215,0	0.0383599,0	
0.063548,0	1,0	0.063548,0	

**Gaussian (BT=0.5)**

(Row 1 to 18)	(Row 19 to 36)	(Row 37 to 54)	(Row 55 to 68)
# Rate	0.00191127,0	0.978572,0	0.000401796,0
8	0.00390625,0	0.917004,0	0.000172633,0
# FilterI,FilterQ	0.00764509,0	0.822878,0	7.10E-05,0
2.33E-10,0	0.0143282,0	0.707107,0	2.80E-05,0
9.11E-10,0	0.0257149,0	0.581862,0	1.06E-05,0
3.42E-09,0	0.0441942,0	0.458502,0	3.81E-06,0
1.23E-08,0	0.0727328,0	0.345977,0	1.32E-06,0
4.21E-08,0	0.114626,0	0.25,0	4.37E-07,0
1.39E-07,0	0.172989,0	0.172989,0	1.39E-07,0
4.37E-07,0	0.25,0	0.114626,0	4.21E-08,0
1.32E-06,0	0.345977,0	0.0727328,0	1.23E-08,0
3.81E-06,0	0.458502,0	0.0441942,0	3.42E-09,0
1.06E-05,0	0.581862,0	0.0257149,0	9.11E-10,0
2.80E-05,0	0.707107,0	0.0143282,0	2.33E-10,0
7.10E-05,0	0.822878,0	0.00764509,0	
0.000172633,0	0.917004,0	0.00390625,0	
0.000401796,0	0.978572,0	0.00191127,0	
0.000895512,0	1,0	0.000895512,0	





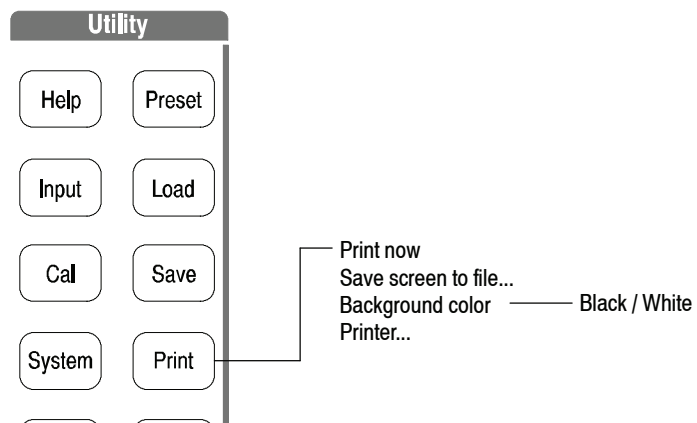
# Screen Copy

This section explains how to send a screen copy to a printer or a file. Use a printer that complies with USB specifications. For files, data in the bitmap format (.BMP) are created. The following topics are described in this section:

- Print Menu
- Printing a Screen Copy
- Creating a File

## Print Menu

The Print menu contains the following controls:



**Figure 3-193: Print menu structure**

**Print now.** Starts printing a copy of the analyzer screen to an attached printer.

**Save screen to file...** Opens the Save menu to save a bitmap file. For file operations, refer to page 3-251.

**Background color.** Selects the background color for printing.

- **Black.** Prints the background of screen in black.
- **White.** Reverses the background of screen to white.

**Printer...** Selects a destination printer.

## Printing a Screen Copy

You must connect the USB printer to the analyzer and install the printer driver before you can print.

### Connecting a Printer

Connect the USB cable of the printer to the USB port on the side panel of the analyzer. You can use either of two ports. Refer to *Side-Panel Interface* on page 2-6 for connecting the USB devices.

If the analyzer is connected to a network through a LAN interface, you can also use a network printer.

### Installing Printer Driver

Install the printer driver using the Windows XP printer wizard. Refer to the printer manual for the installation method. Refer to page 2-27 for using Windows XP.

### Print

To print a copy of the analyzer screen, follow these steps:

1. Press the **Print** key on the front panel, and select **Black** or **White** as the background color with the **Background color** side key.
2. Display the measurement to be printed and stop data acquisition.
3. Press the **Print** key again. The screen image data is captured on the internal memory with the background color set in step 1.
4. Press the **Printer...** side key and select a destination printer.
5. Press the **Print now** side key to start printing.

If the printer driver displays a message during printing, follow the instructions.

## Creating a File

You can save a screen image to a file as bitmap data and read the data into a word processor to create a report, for example.

To save the file to a floppy disk, insert it to the floppy disk drive.

1. Press the **Print** key on the front panel, and select **Black** or **White** of the background color with the **Background color** side key.
2. Display the measurement to be copied and stop data acquisition.
3. Press the **Print** key again. The screen image data is captured on the internal memory with the background color set in step 1.
4. Press the **Save screen to file...** side key. The file selection screen appears.
5. Do one of the following to output the screen image to a specified file:
  - *Using a preset file name:* Press the **Save to BitmapA**, **Save to BitmapB**, or **Save to BitmapC** side key. The image data is stored to the file *BitmapA.bmp*, *BitmapB.bmp*, or *BitmapC.bmp* in the *C:\My Documents* folder, respectively.
  - *Entering a new file name:* Enter a file name with the **Filename** side key, referring to *Entering a File Name* on page 3-262. The file extension **.BMP** is automatically assigned. When you have finished entering the name, press the **Save File Now** side key to store the copy in the file.

After the screen copy is saved in the file, the screen returns to the original waveform display.



# Appendices

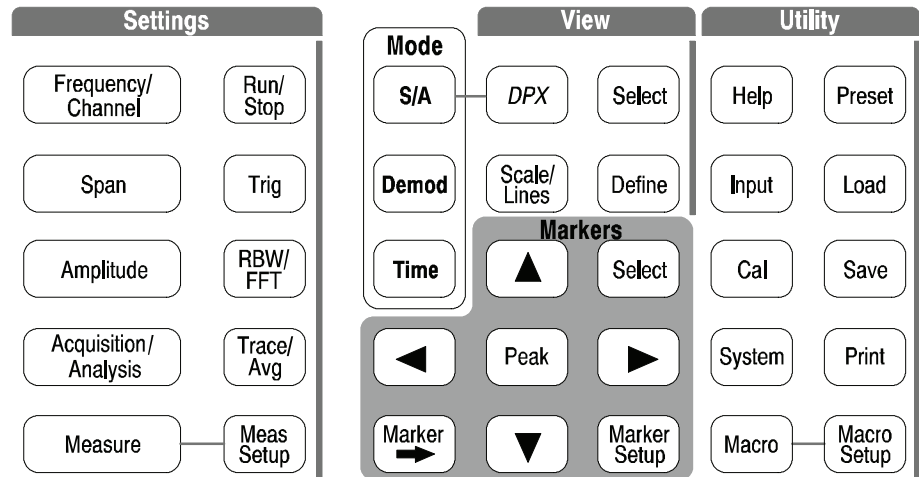


# Appendix A: Menu Tree

This section shows the structure of the menus and submenus displayed by pressing the menu keys as illustrated in Figure A-1. The menu keys are divided into the following groups:

- Settings
- Mode
- Markers
- View
- Utility

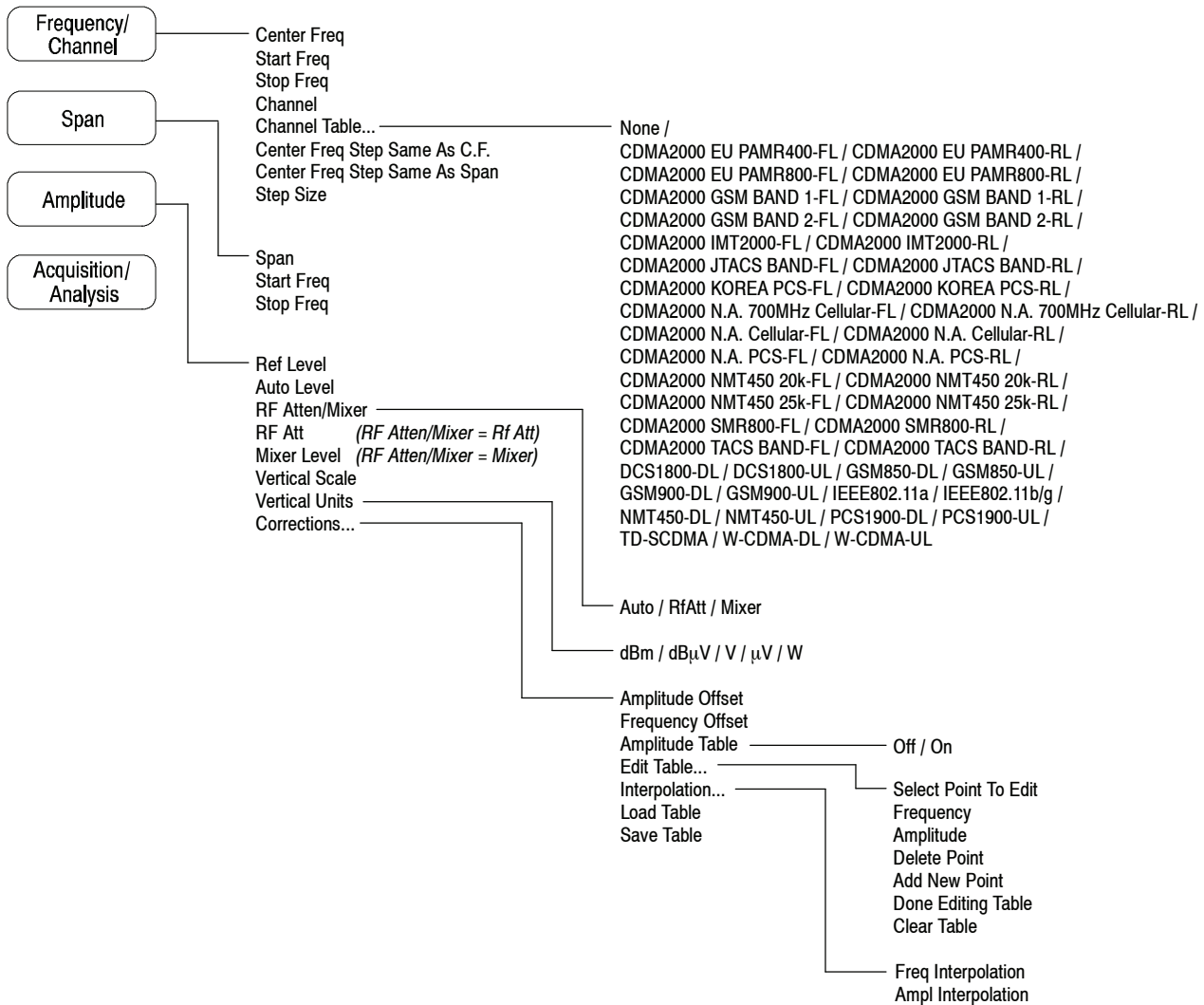
Some of the submenus are used for programming or servicing; information about these submenus is in the programmer or service manual (optional). See *Appendix F* for manual part number.



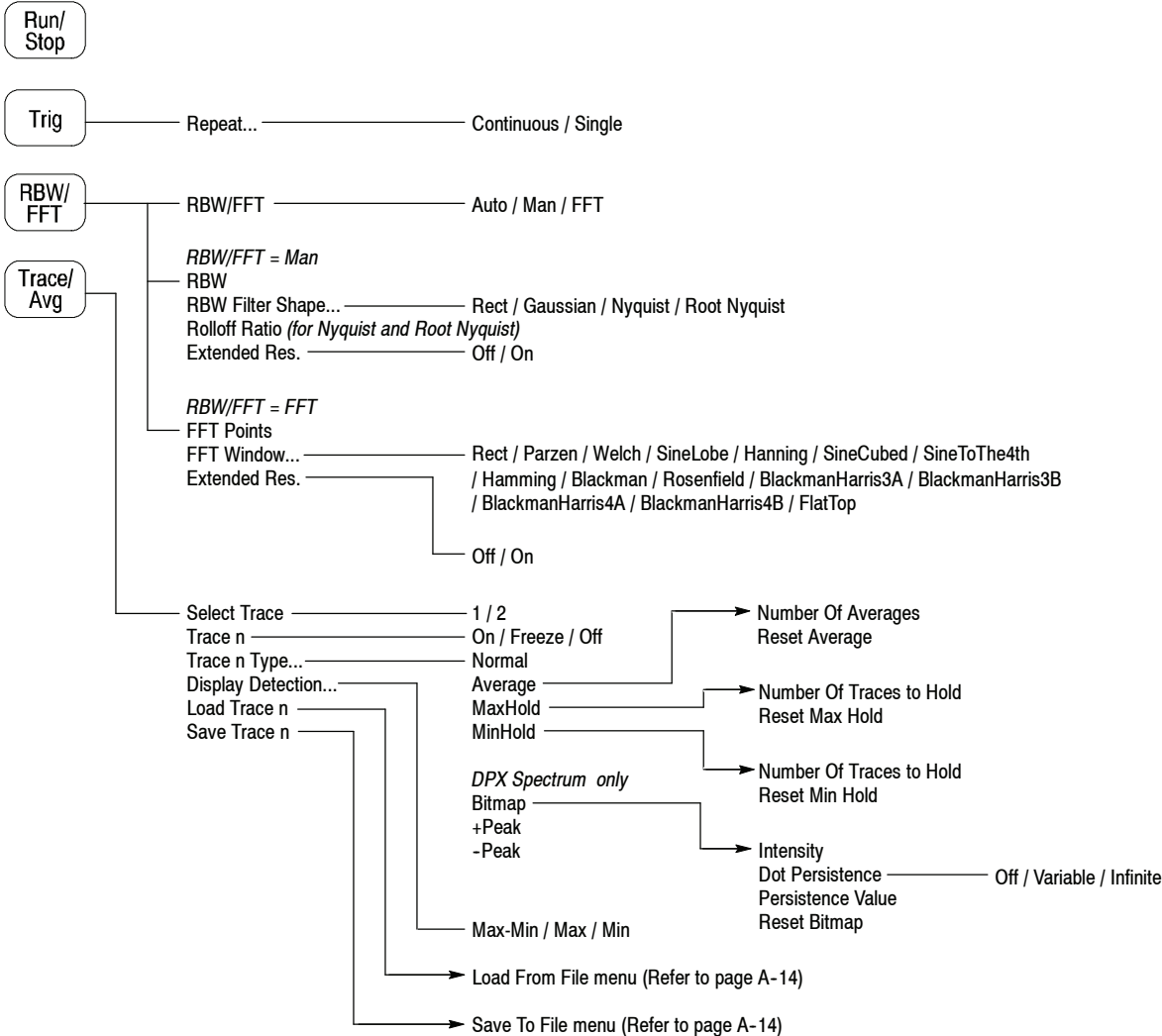
**Figure A-1: Menu keys**

## Settings Menu (1 of 3)

### S/A Mode except Real Time S/A

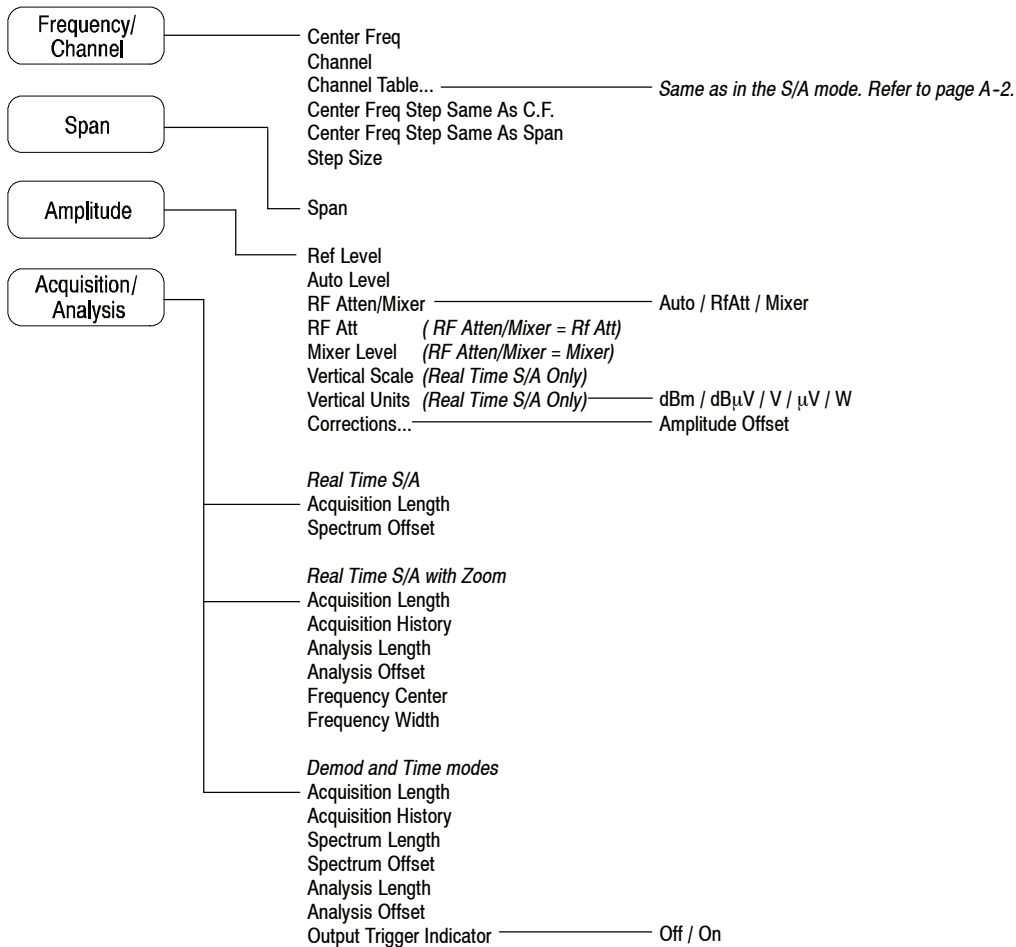


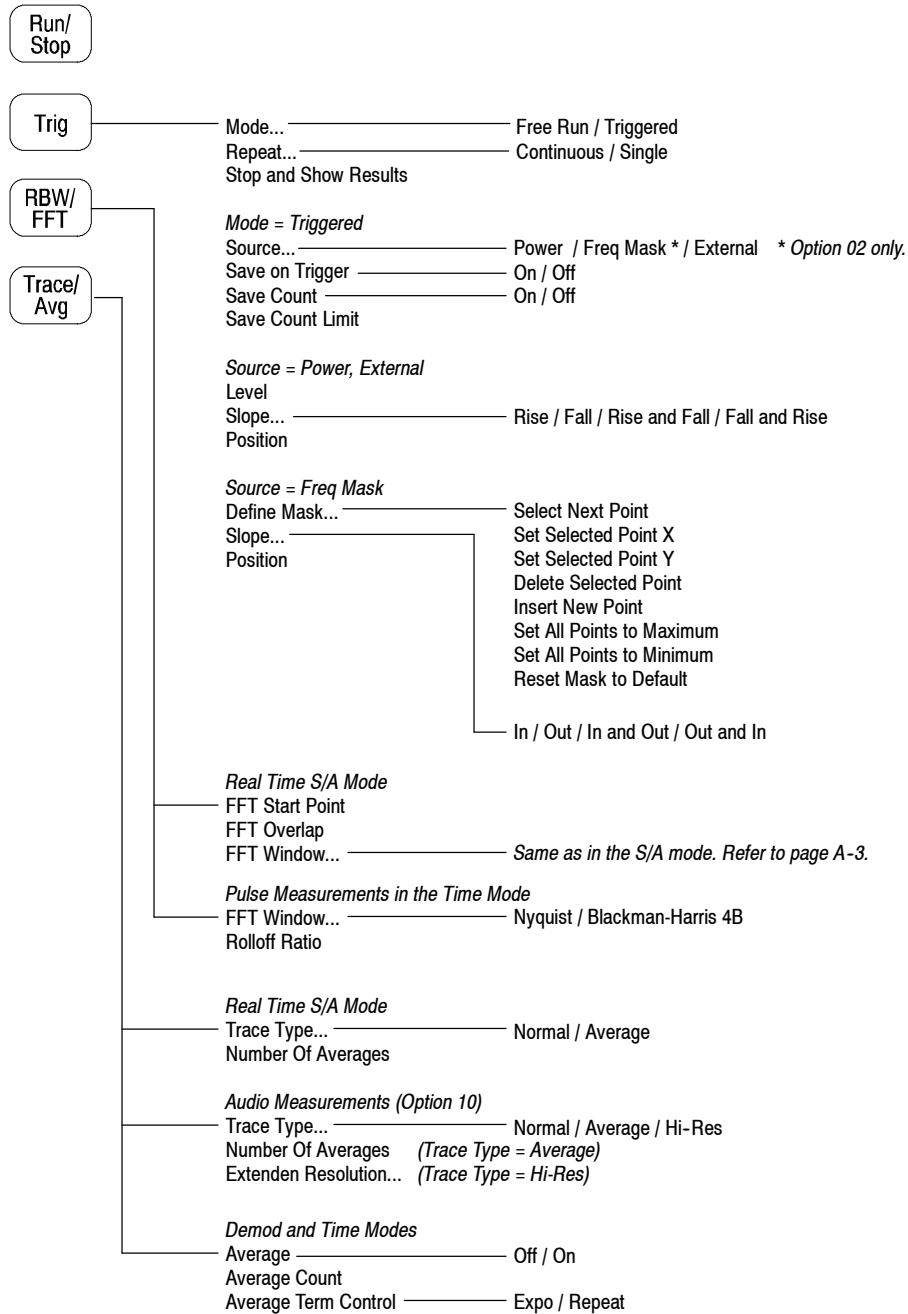




## Settings Menu (2 of 3)

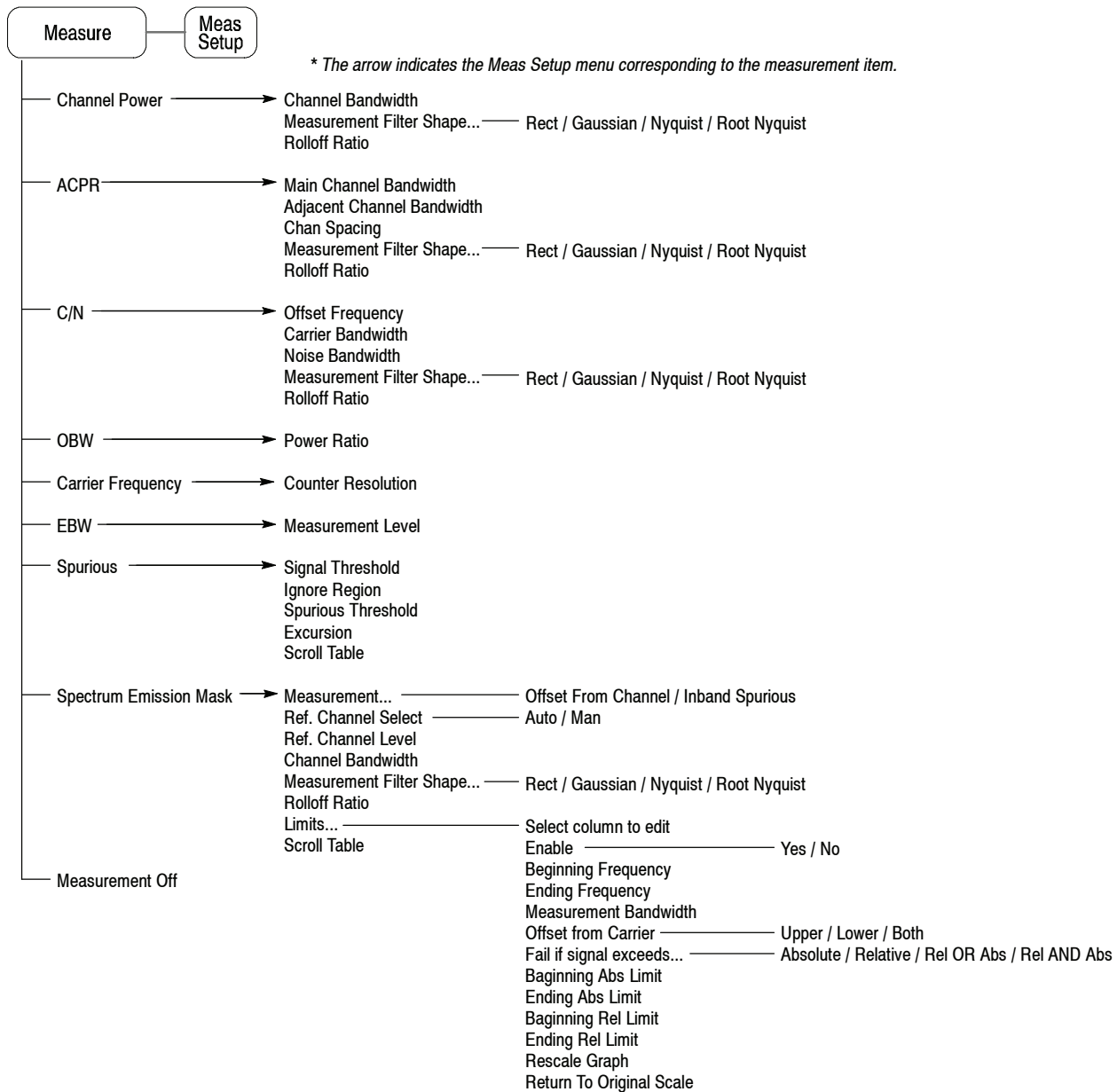
### Real Time S/A, Demod and Time Modes



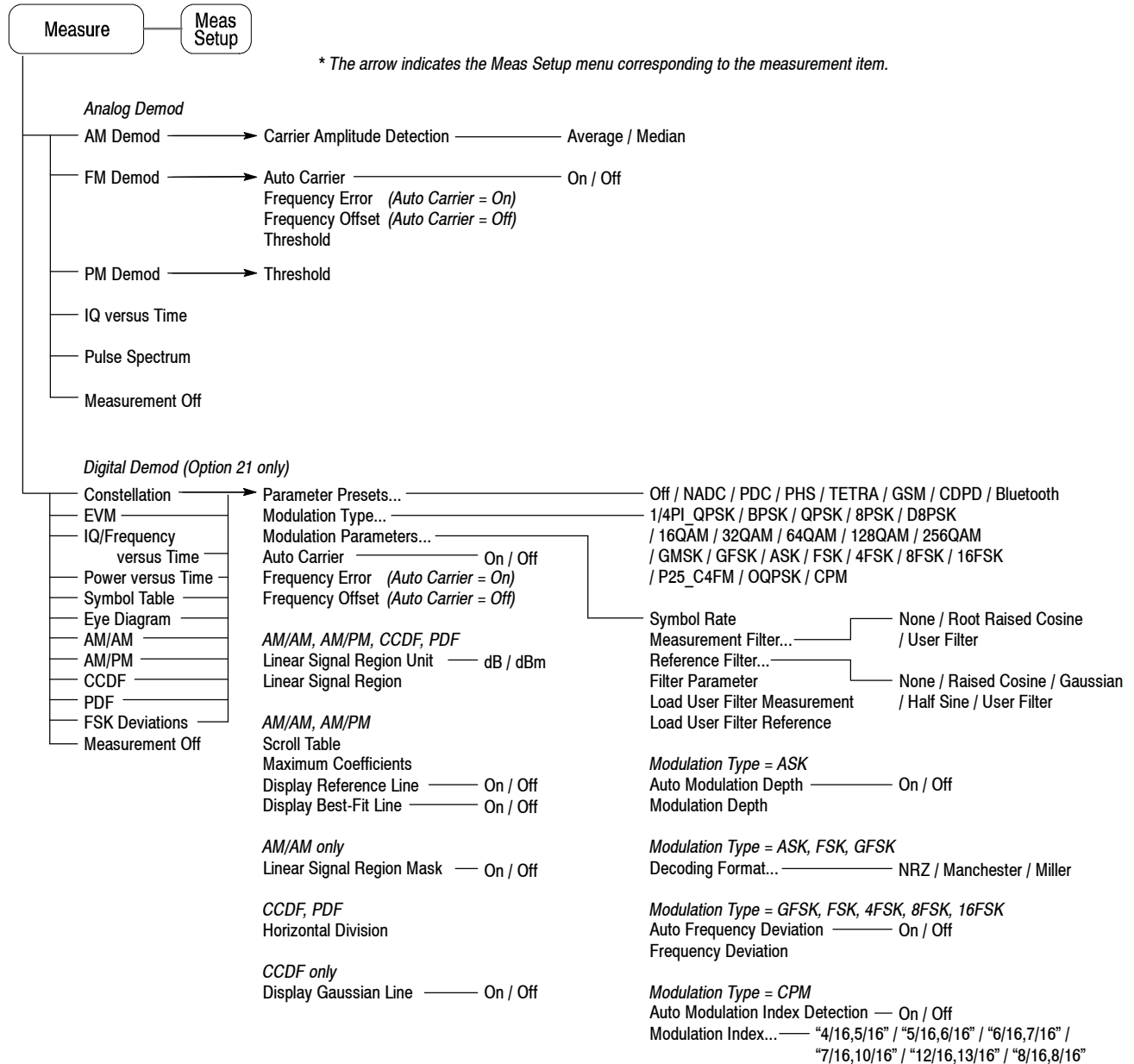


## Settings Menu (3 of 3)

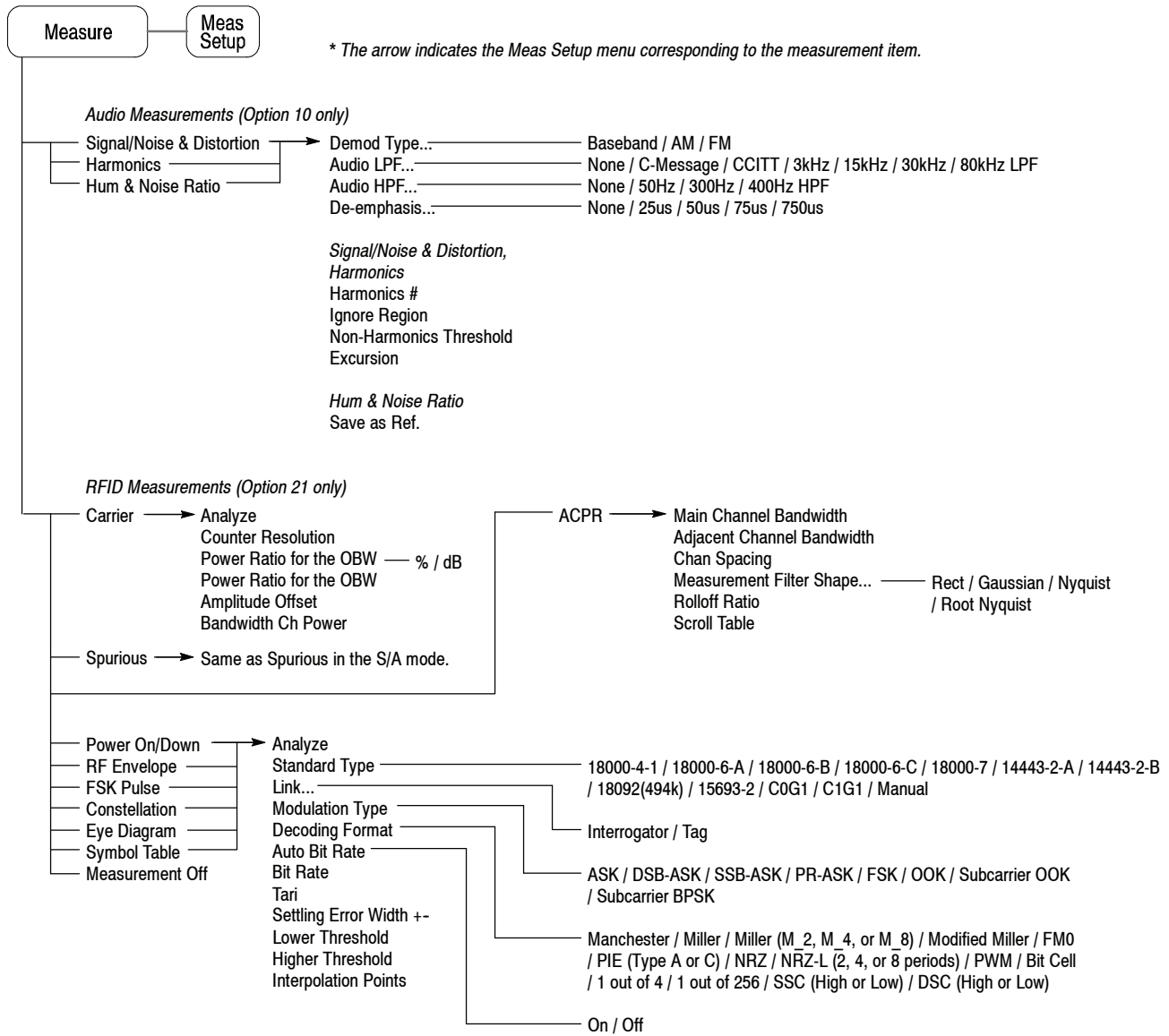
### S/A Mode



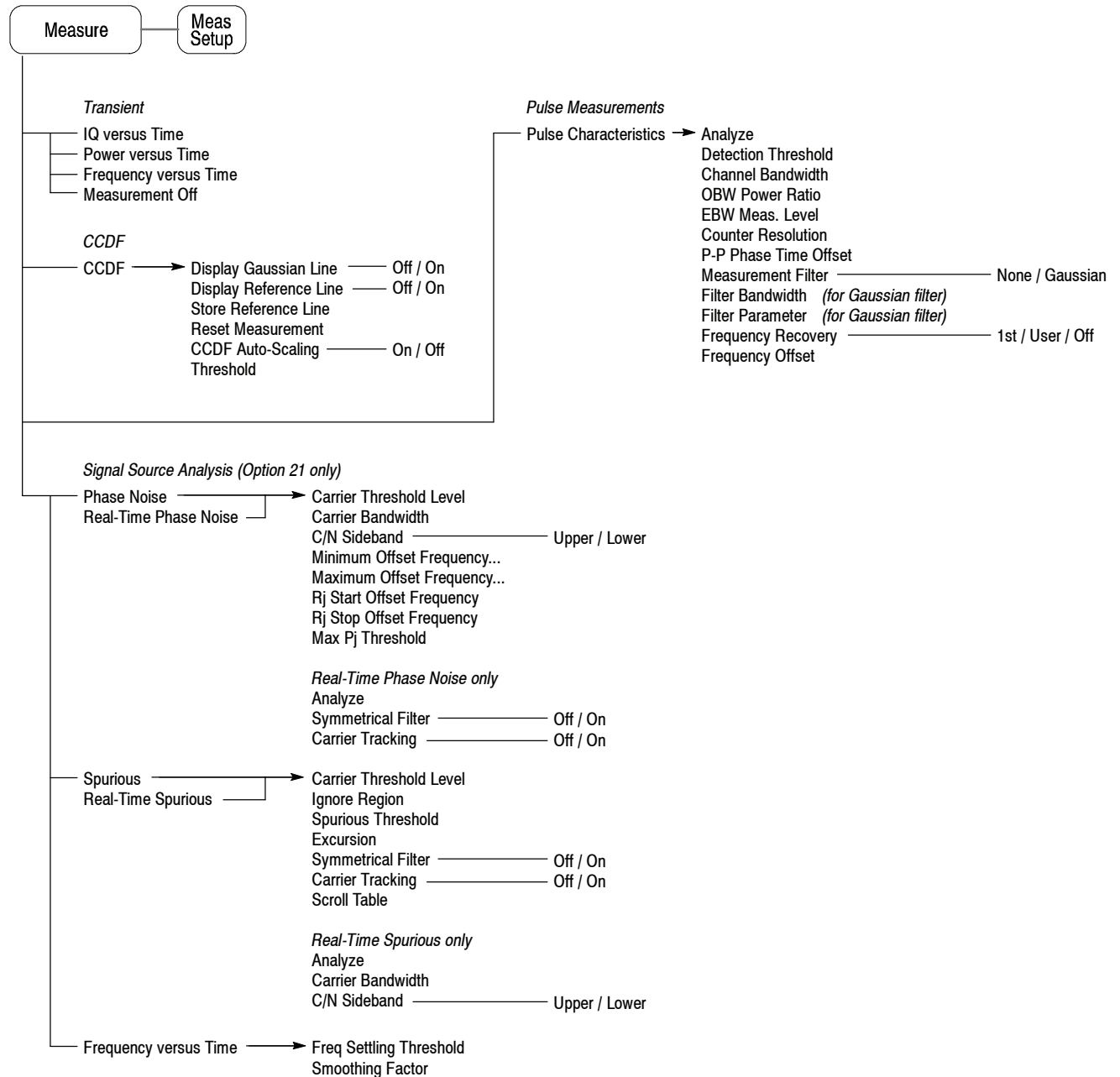
## Demod Mode



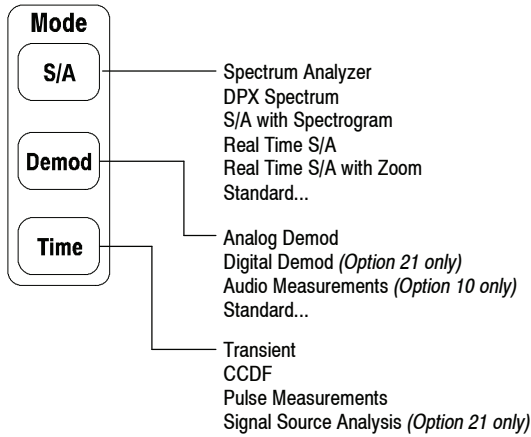
### Demod Mode



### Time Mode

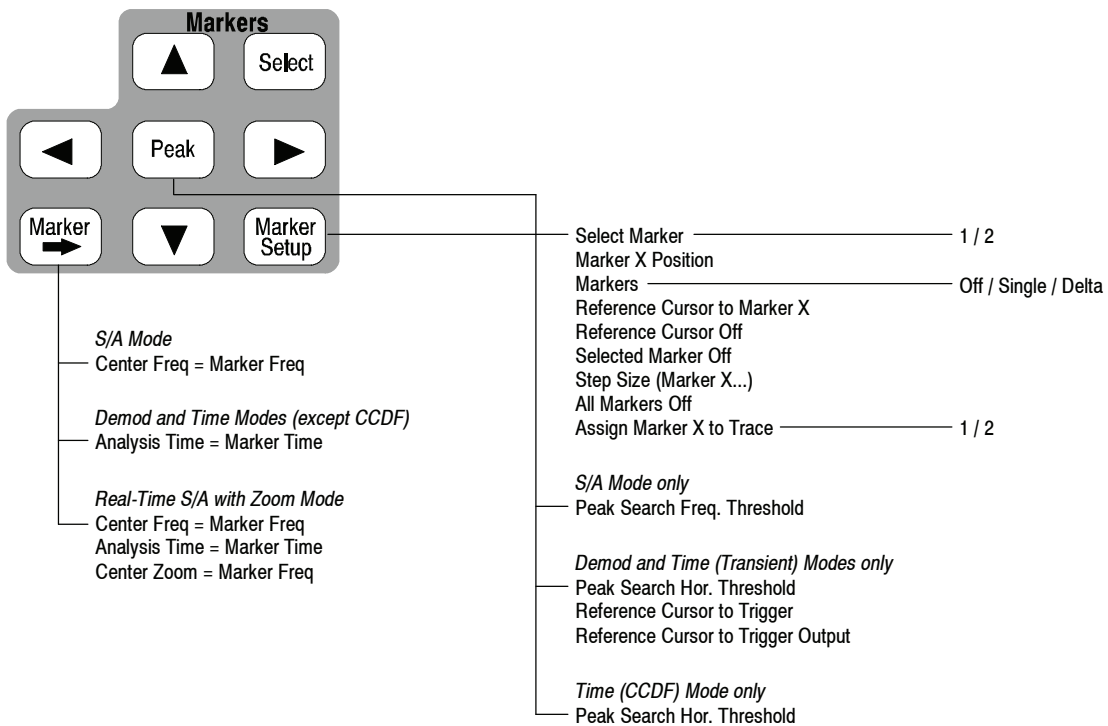


## Mode Menu



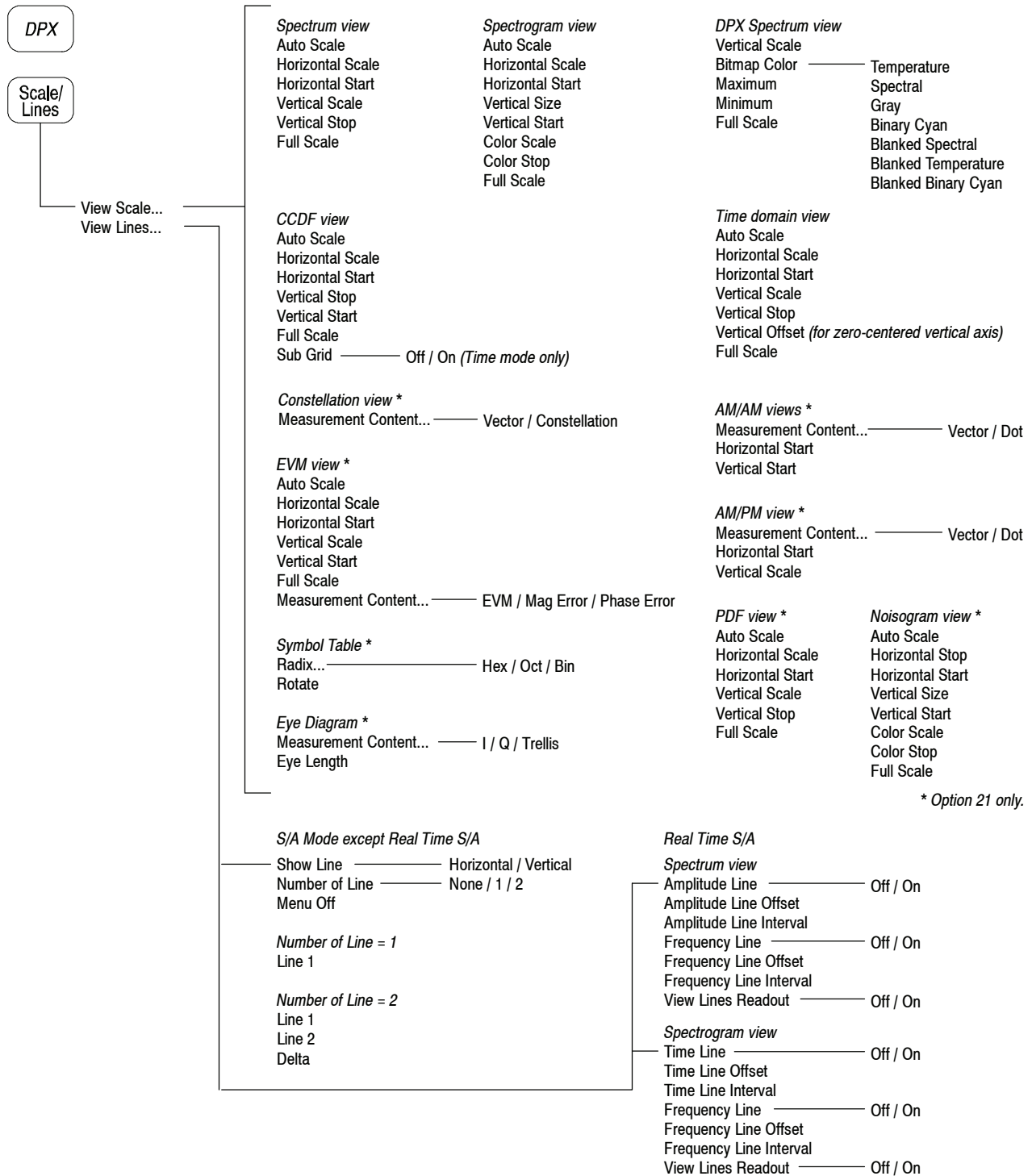
\* For details about the Standard... menu, refer to the optional software user manual.

## Markers Menu



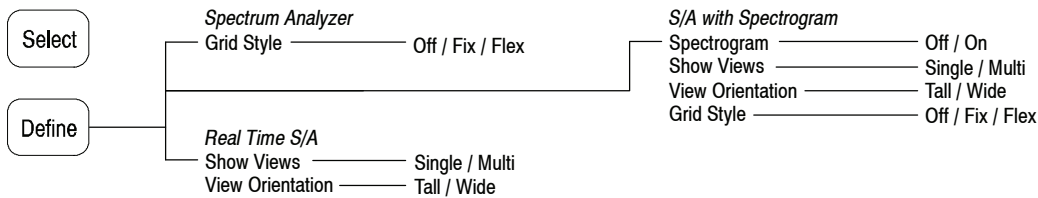


## Display: View Menu (1 of 2)

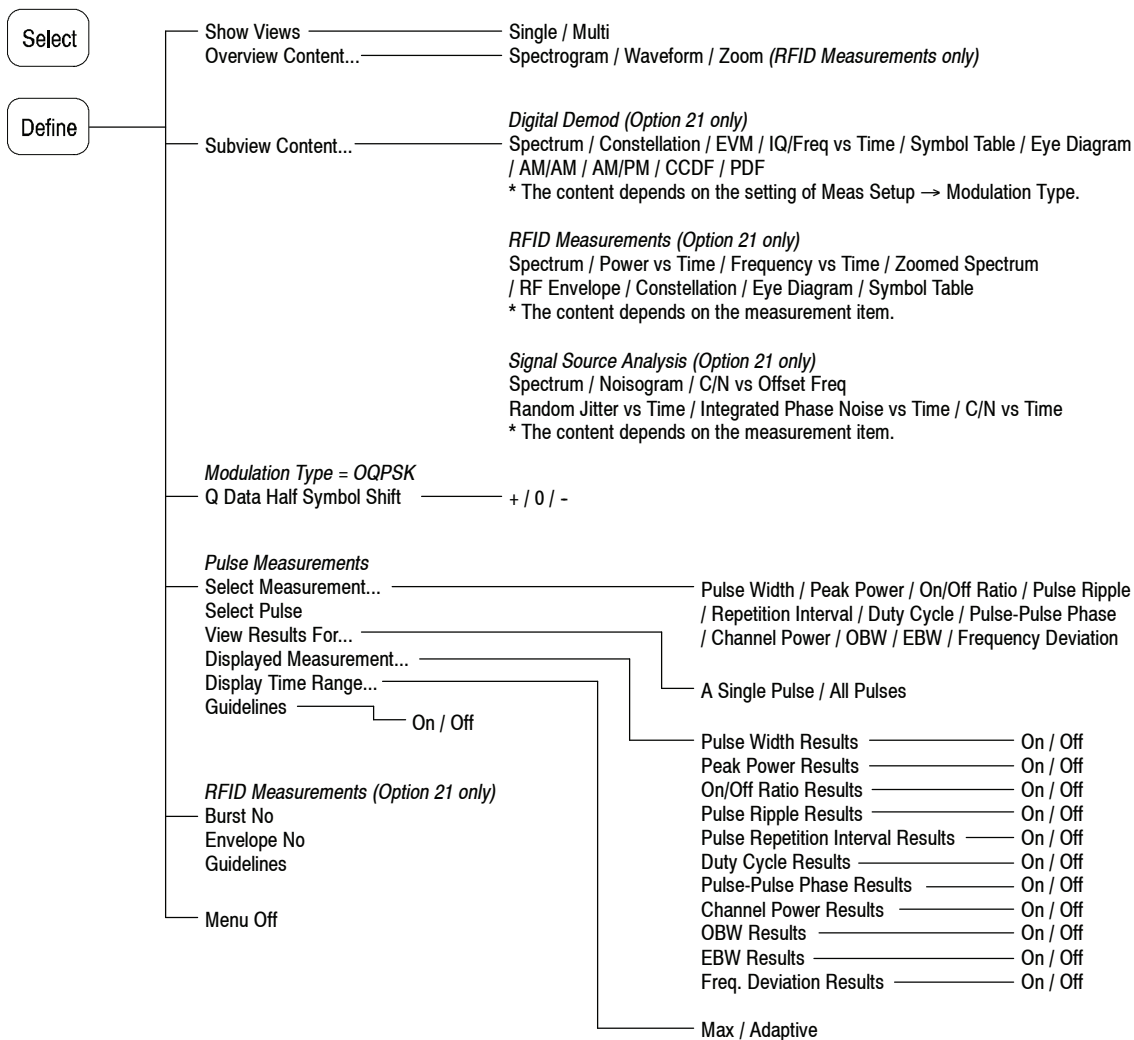


## Display: View Menu (2 of 2)

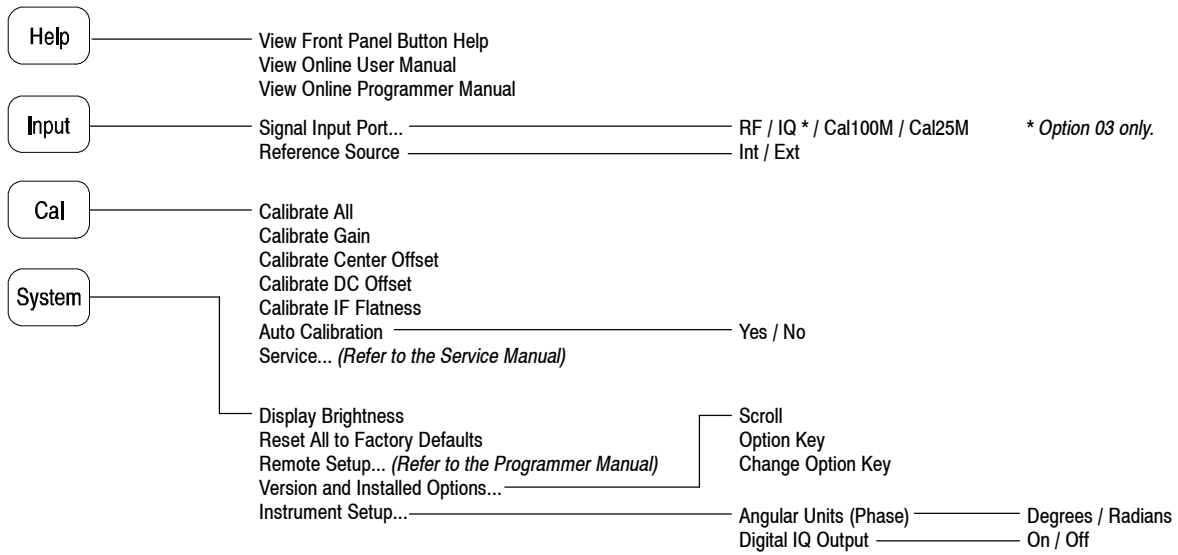
### S/A Mode



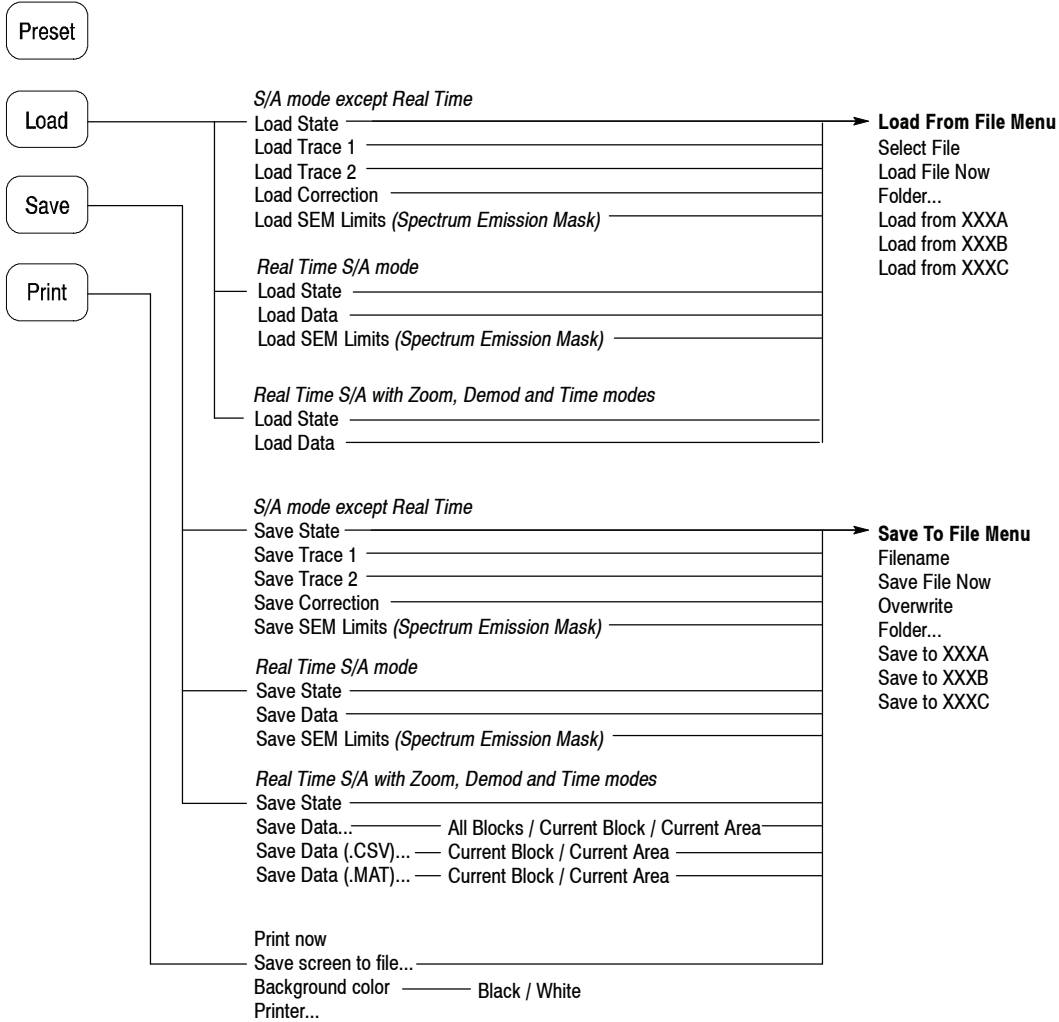
### Demod and Time Modes



## Utility Menu



# Appendix A: Menu Tree



Where XXX =  
 State for a state file  
 IQData for an IQ data file  
 Trace for a trace file  
 Corr for a correction file  
 Bitmap for a bitmap file

**MACRO** **MACRO SETUP**

\* Contact your local Tektronix distributor or sales office for installing user-specific macros.

# Appendix B: Digital Demodulation Symbol Mapping

This section shows the symbol mapping for each digital modulation technique.

## BPSK

Left	Right
1	0

## QPSK

Left	Right
1	3
0	2

## 8PSK

Left			Right	
		3		
	2		1	
6				0
	7		4	
		5		

## 16QAM

Left			Right
3	2	1	0
7	6	5	4
B	A	9	8
F	E	D	C

## 32QAM

Left					Right
	3	2	1	0	
9	8	7	6	5	4
F	E	D	C	B	A
15	14	13	12	11	10
1B	1A	19	18	17	16
	1F	1E	1D	1C	

## 64QAM

Left							Right
7	6	5	4	3	2	1	0
F	E	D	C	B	A	9	8
17	16	15	14	13	12	11	10
1F	1E	1D	1C	1B	1A	19	18
27	26	25	24	23	22	21	20
2F	2E	2D	2C	2B	2A	29	28
37	36	35	34	33	32	31	30
3F	3E	3D	3C	3B	3A	39	38

Figure B-1: Symbol mapping: BPSK, QPSK, 8PSK, 16QAM, 32QAM, and 64QAM

**256QAM**

Left														Right	
EF	FD	EB	F9	E7	F5	E3	F1	0F	3F	4F	7F	8F	BF	CF	FF
CE	DC	CA	D8	C6	D4	C2	D0	0C	3C	4C	7C	8C	BC	CC	FC
AF	BD	AB	B9	A7	B5	A3	B1	0B	3B	4B	7B	8B	BB	CB	FB
8E	9C	8A	98	86	94	82	90	08	38	48	78	88	B8	C8	F8
6F	7D	6B	79	67	75	63	71	07	37	47	77	87	B7	C7	F7
4E	5C	4A	58	46	54	42	50	04	34	44	74	84	B4	C4	F4
2F	3D	2B	39	27	35	23	31	03	33	43	73	83	B3	C3	F3
0E	1C	0A	18	06	14	02	10	00	30	40	70	80	B0	C0	F0
E1	D1	A1	91	61	51	21	11	01	13	05	17	09	1B	0D	1F
E2	D2	A2	92	62	52	22	12	20	32	24	36	28	3A	2C	3E
E5	D5	A5	95	65	55	25	15	41	53	45	57	49	5B	4D	5F
E6	D6	A6	96	66	56	26	16	60	72	64	76	68	7A	6C	7E
E9	D9	A9	99	69	59	29	19	81	93	85	97	89	9B	8D	9F
EA	DA	AA	9A	6A	5A	2A	1A	A0	B2	A4	B6	A8	BA	AC	BE
ED	DD	AD	9D	6D	5D	2D	1D	C1	D3	C5	D7	C9	DB	CD	DF
EE	DE	AE	9E	6E	5E	2E	1E	E0	F2	E4	F6	E8	FA	EC	FE

**GFSK**

Left	Right
1	0

**4FSK**

Left			Right	
0	1	3	2	

**8FSK**

Left							Right	
0	1	2	3	7	6	5	4	

**16FSK**

Left														Right	
0	1	2	3	4	5	6	7	15	14	13	12	11	10	9	8

**Figure B-2: Symbol mapping: 256QAM, GFSK, 4FSK, 8FSK, and 16FSK**

**Table B- 1:  $\pi/4$  shift DQPSK**

Rotation angle (degree)	Bit
+45	0
+135	1
-45	2
-135	3

**Table B- 2: GMSK**

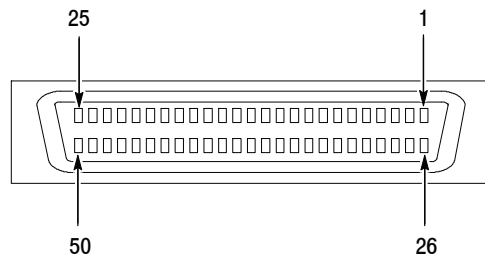
Rotation direction	Bit
Left	1
Right	0





# Appendix C: Digital IQ Output Connector Pin Assignment (Option 05)

This section shows the pin assignment of the digital IQ output connectors (I OUTPUT and Q OUTPUT) on the rear panel of the analyzer with Option 05. For details on the specifications, refer to the *RSA3408B Technical Reference*.



**Figure C-1: Digital IQ output connector pin assignment**

**Table C-1: I OUTPUT connector pin assignment**

Pin number	Signal name	Description
1	IQ_ENABLE*	IQ output enable signal input Open: IQ output disable Connect to GND: IQ output enable
26	GND	Ground
2	GND	Ground
27	GND	
3	EXT_I0-	I output data (bit 0), LVDS
28	EXT_I0+	
4	EXT_I1-	I output data (bit 1), LVDS
29	EXT_I1+	
5	EXT_I2-	I output data (bit 2), LVDS
30	EXT_I2+	
6	EXT_I3-	I output data (bit 3), LVDS
31	EXT_I3+	
7	GND	Ground
32	GND	

**Table C-1: I OUTPUT connector pin assignment (Cont.)**

Pin number	Signal name	Description
8	EXT_I4-	I output data (bit 4), LVDS
33	EXT_I4+	
9	EXT_I5-	I output data (bit 5), LVDS
34	EXT_I5+	
10	EXT_I6-	I output data (bit 6), LVDS
35	EXT_I6+	
11	EXT_I7-	I output data (bit 7), LVDS
36	EXT_I7+	
12	GND	Ground
37	GND	
13	EXT_I8-	I output data (bit 8), LVDS
38	EXT_I8+	
14	EXT_I9-	I output data (bit 9), LVDS
39	EXT_I9+	
15	EXT_I10-	I output data (bit 10), LVDS
40	EXT_I10+	
16	EXT_I11-	I output data (bit 11), LVDS
41	EXT_I11+	
17	GND	Ground
42	GND	
18	EXT_I12-	I output data (bit 12), LVDS
43	EXT_I12+	
19	EXT_I13-	I output data (bit 13), LVDS
44	EXT_I13+	
20	EXT_I14-	I output data (bit 14), LVDS
45	EXT_I14+	
21	EXT_I15-	I output data (bit 15), LVDS
46	EXT_I15+	
22	GND	Ground
47	GND	
23	GND	
48	GND	

**Table C- 1: I OUTPUT connector pin assignment (Cont.)**

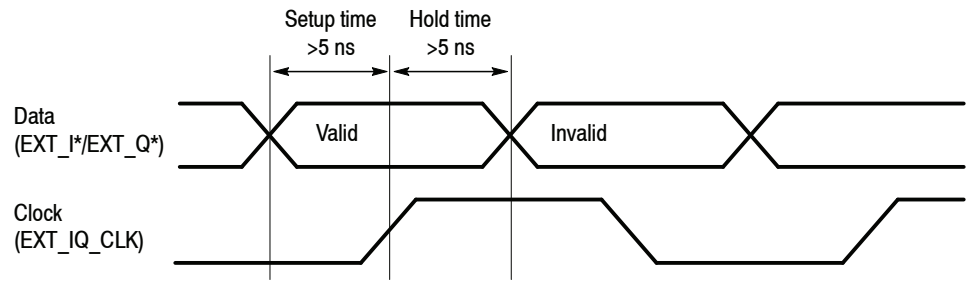
Pin number	Signal name	Description
24	EXT_IQ_DAV-	Not used
49	EXT_IQ_DAV+	
25	EXT_IQ_CLK-	IQ output clock, LVDS
50	EXT_IQ_CLK+	

**Table C-2: Q OUTPUT connector pin assignment**

Pin number	Signal name	Description
1	IQ_ENABLE*	IQ output enable signal input Open: IQ output disable Connect to GND: IQ output enable
26	GND	Ground
2	GND	
27	GND	
3	EXT_Q0-	Q output data (bit 0), LVDS
28	EXT_Q0+	
4	EXT_Q1-	Q output data (bit 1), LVDS
29	EXT_Q1+	
5	EXT_Q2-	Q output data (bit 2), LVDS
30	EXT_Q2+	
6	EXT_Q3-	Q output data (bit 3), LVDS
31	EXT_Q3+	
7	GND	Ground
32	GND	
8	EXT_Q4-	Q output data (bit 4), LVDS
33	EXT_Q4+	
9	EXT_Q5-	Q output data (bit 5), LVDS
34	EXT_Q5+	
10	EXT_Q6-	Q output data (bit 6), LVDS
35	EXT_Q6+	
11	EXT_Q7-	Q output data (bit 7), LVDS
36	EXT_Q7+	

**Table C-2: Q OUTPUT connector pin assignment (Cont.)**

Pin number	Signal name	Description
12	GND	Ground
37	GND	
13	EXT_Q8-	Q output data (bit 8), LVDS
38	EXT_Q8+	
14	EXT_Q9-	Q output data (bit 9), LVDS
39	EXT_Q9+	
15	EXT_Q10-	Q output data (bit 10), LVDS
40	EXT_Q10+	
16	EXT_Q11-	Q output data (bit 11), LVDS
41	EXT_Q11+	
17	GND	Ground
42	GND	
18	EXT_Q12-	Q output data (bit 12), LVDS
43	EXT_Q12+	
19	EXT_Q13-	Q output data (bit 13), LVDS
44	EXT_Q13+	
20	EXT_Q14-	Q output data (bit 14), LVDS
45	EXT_Q14+	
21	EXT_Q15-	Q output data (bit 15), LVDS
46	EXT_Q15+	
22	GND	Ground
47	GND	
23	GND	
48	GND	
24	NC	Not used
49	NC	
25	NC	
50	NC	



**Figure C-2: Definition of the setup and hold time**



## Appendix D: Using the Removable Hard Disk Drive (Option 06)

Option 06 provides a removable hard disk drive. All user-storable information including acquired signal data, instrument settings, screen images, and calibration data is stored on the removable hard disk drive. Remove the hard drive for storage or security. Once the drive is removed from the analyzer, no user data remains in the instrument. Replace the hard drive using the following steps.

---

**NOTE.** For an extra disk (RSA34RHD), refer to Optional Accessories on page G-3.

---

### Replacing the Hard Drive



---

**CAUTION.** Turn off the analyzer before you replace the removable hard drive.

---

Use the steps in Figure D-1 on page D-2 to detach the removable hard drive. To attach the hard drive, reverse these steps.

### Using the USB Flash Drive

Option 06 also supplies a USB flash drive that includes the analyzer name, serial number, a copy of the factory calibration data and other information.

Follow these instructions for using the flash drive:

- Plug the USB flash drive into the USB connector on the analyzer side panel before turning on the analyzer. Do not unplug the flash drive while operating the analyzer.

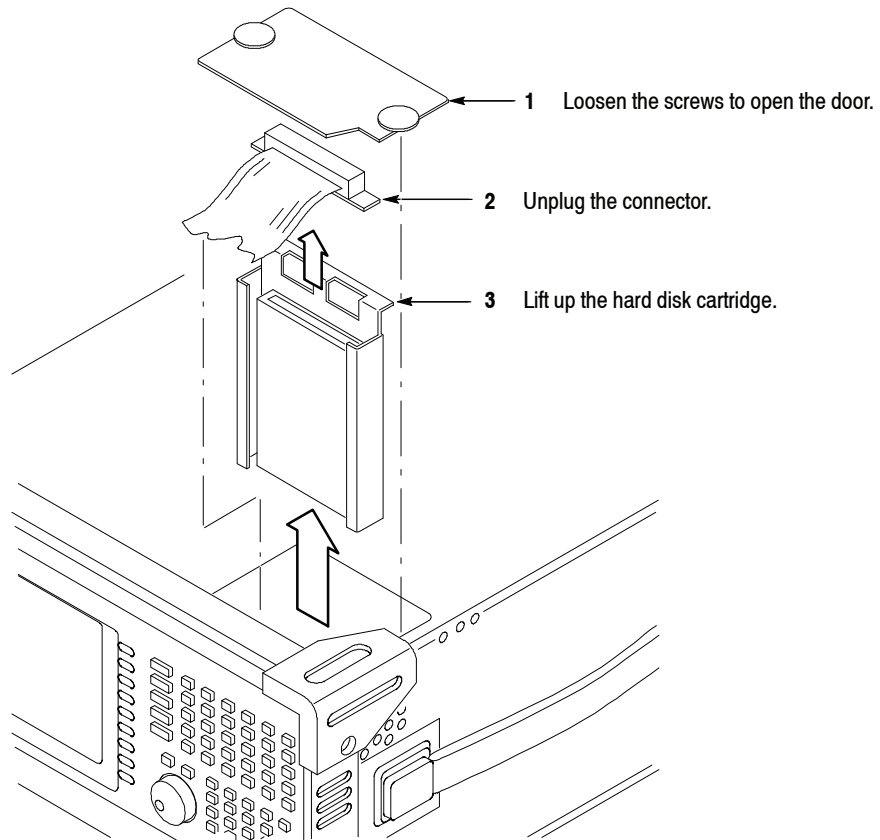
---

**NOTE.** If you use a USB flash drive that includes a different serial number, the error message “UNCAL” will be displayed in red on the screen.

---

- For repair or calibration, ship your instrument with the USB flash drive to Tektronix.

- After repair or calibration, run the *Backup.exe* program stored in the USB flash drive to back up the USB flash drive contents onto the analyzer's internal hard disk (on the Windows desktop of the analyzer, display the contents of the USB flash drive and then double-click *Backup.exe*).



**Figure D-1: Detaching the removable hard disk drive**



# Appendix E: Restoring the Instrument Operating System

You can restore the instrument operating system from a file on the instrument hard disk drive.



---

**CAUTION.** *Using the restore process reformats the hard drive and reinstalls the operating system. All saved data will be lost. If possible, save important files to external media before performing a system restore.*

---

## Restoring the Operating System from the Instrument Hard Disk

Perform the following steps to restore the operating system:

1. Restart the instrument. During the boot-up process you will see the following message at the bottom of the screen:

Starting Acronis Loader... press F5 for Acronis Startup Recovery Manager

2. Repeatedly press the F5 key until the Acronis True Image Tool opens.

There is a three-second time period from when the message appears until the instrument proceeds with the normal instrument startup. If the instrument does not open the Acronis application, power off the instrument, then power on the instrument and try again.

3. Click **Restore**.
4. In the Confirmation dialog box, click **Yes** to restore the instrument operating system, or **No** to exit the restore process.

The restore process takes approximately 30 minutes; the actual time depends on the instrument configuration.



# Appendix F: Inspection and Cleaning

Inspect and clean the exterior of the instrument as often as operating conditions require. Dirt acts as an insulating blanket, preventing efficient heat dissipation. Regular cleaning may prevent instrument malfunction and enhance reliability.



**WARNING.** To avoid personal injury, unplug the power cord from line voltage before cleaning the instrument. To avoid getting moisture inside the instrument during external cleaning, use only enough liquid to dampen the applicator.

## Inspecting the Exterior

Inspect the outside of the instrument for damage, wear, and missing parts, using Table F-1 as a guide. Instruments that appear to have been dropped or otherwise abused should be checked thoroughly to verify correct operation and performance. Immediately repair defects that could cause personal injury or lead to further damage to the instrument.

**Table F- 1: External inspection checklist**

Item	Inspect for	Repair action
Cabinet, front panel, and cover	Cracks, scratches, deformations, damaged hardware or gaskets.	Contact your local Tektronix distributor or sales office.
Front-panel knobs	Missing, damaged, or loose knobs.	
Connectors	Broken shells, cracked insulation, and deformed contacts. Dirt in connectors.	
Carrying handle	Correct operation.	
Accessories	Missing items or parts of items, bent pins, broken or frayed cables, and damaged connectors.	



---

**CAUTION.** *Avoid the use of chemical cleaning agents that might damage the plastics used in this instrument. Organic solvents such as benzene and acetone must never be used.*

---

## Cleaning the Exterior

Remove the power cord before cleaning the instrument. Clean the exterior surfaces of the instrument with a dry, lint-free cloth or a soft-bristle brush. If dirt remains, use a cloth or swab dampened with a 75% isopropyl alcohol solution. A swab is useful for cleaning in narrow spaces around the controls and connectors. Do not use abrasive compounds on any part of the instrument.



---

**CAUTION.** *Do not allow moisture inside the instrument. During exterior cleaning, use only enough solution to dampen the cloth or swab.*

---

## Lubrication

There is no periodic lubrication required for this instrument.

## Cleaning the Interior

Consult your Tektronix Service Center or representative for cleaning the analyzer interior.

# Appendix G: Options and Accessories

This appendix describes the options and standard and optional accessories that are available for the analyzer.

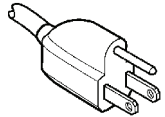
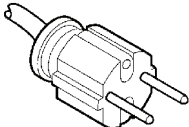
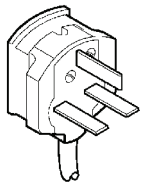
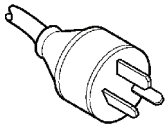
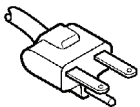
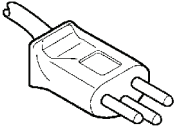
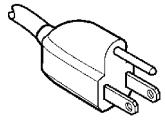
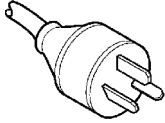
## Options

The following options can be ordered for the analyzer:

- Option 1A: External preamplifier (20 dB gain to 3 GHz)
- Option L5: Provides Japanese language user manual and programmer manual instead of English manuals
- Option 02: 256 MB data memory with frequency mask trigger
- Option 03: IQ input function
- Option 05: Digital IQ output function
- Option 06: Removable hard disk drive
- Option 10: Audio measurement function
- Option 21: Advanced measurement suite
- Option 24: GSM/EDGE analysis software
- Option 25: cdma2000 analysis software
- Option 26: cdma2000 1xEV-DO analysis software
- Option 28: TD-SCDMA analysis software
- Option 29: WLAN 802.11a/b/g/n analysis software
- Option 30: 3GPP Release 99 and Release 5 uplink and downlink analysis software
- Option 40: 3GPP Release 6 (HSUPA) analysis software
- Option C3: Calibration service, 3 years
- Option C5: Calibration service, 5 years
- Option D1: Calibration data report
- Option D3: Calibration data report, 3 years (requires Option C3)
- Option D5: Calibration data report, 5 years (requires Option C5)

- Option R3: Repair service, 3 years
- Option R5: Repair service, 5 years
- Power cord options listed in Table G-1

**Table G-1: Power cord identification**

Plug configuration	Normal usage	Option number
	North America 120 V	A0
	Universal Euro 230 V	A1
	United Kingdom 230 V	A2
	Australia 240 V	A3
	North America 240 V	A4
	Switzerland 220 V	A5
	Japan 100 V	A6
	China 240 V	A10
	No power cord supplied.	A99

## Standard Accessories

All analyzers in this series are shipped with the accessories listed in Table G-2.

**Table G-2: Standard accessories**

<b>Accessory</b>	<b>Part number</b>
English language user manual	071-2364-XX
English language programmer manual (PDF only) <sup>1</sup>	077-0111-XX
English language technical reference (PDF only) <sup>1</sup>	077-0113-XX
U.S. power cord	161-0066-XX
USB mouse	119-6936-XX
USB keyboard	119-B146-XX
BNC-N adapter	103-0045-XX
Front cover	200-A524-50
Documents CD	063-4089-XX

<sup>1</sup> **PDF documents are stored on the Documents CD.**

## Optional Accessories

You can order the accessories listed in Table G-3 to use with your analyzer.

**Table G-3: Optional accessories**

<b>Accessory</b>	<b>Part number</b>
Japanese language user manual	071-2365-XX
Japanese language programmer manual (PDF)	077-0112-XX
English language service manual	071-2366-XX
Accessory bag	016-A330-00
Preamplifier (20 dB gain to 3 GHz)	650-A900-XX
RTPA2A real-time probe adapter (P7000 series probes recommended)	
RSA34RHD extra 40 GB removable hard drive for use with Option 06	
RSA3KR rackmount kit (user installable)	

**Optional Software  
User Manuals**

Optional software includes the user manual listed in Table G-4.

**Table G-4: Accessories for optional software**

<b>Accessory</b>	<b>Part number</b>
Option 24 GSM/EDGE analysis software user manual	071-2398-XX
Option 25 cdma2000 analysis software user manual	071-2400-XX
Option 26 1xEV-DO analysis software user manual	071-2402-XX
Option 28 TD-SCDMA analysis software user manual	071-2404-XX
Option 29 WLAN 802.11a/b/g/n analysis software user manual	071-2405-XX
Option 30 3GPP Release 99 and Release 5 uplink and downlink analysis software user manual	071-2396-XX
Option 40 3GPP Release 6 (HSUPA) analysis software user manual	071-2060-XX



# Glossary



# Glossary

**Accuracy**

The closeness of the indicated value to the true value.

**Acquisition**

A series of time-contiguous frames. This is also called a Block.

**Acquisition Time**

The length of time contained in one acquisition.

**Amplitude**

The magnitude of an electrical signal.

**Amplitude Modulation (AM)**

The process, or result of a process, in which the amplitude of a sine wave (the carrier) is varied in accordance with the instantaneous voltage of a second electrical signal (the modulating signal).

**Analysis Time**

A subset of time-contiguous samples from one Block Time, used as input to an Analysis View.

**Analysis View**

Any view which produces measurement results except for Spectrum, Power versus Time, and Spectrogram.

**ASK**

Acronym for Amplitude Shift Keying. The process, or result of a process, in which the amplitude of the carrier is varied in accordance with the state of a digital input signal.

**Block**

See *Acquisition*.

**Calibrator**

A signal generator producing a specified output used for calibration purposes.

**Carrier, Carrier Signal**

The electrical signal, typically a sine wave, upon which modulation is impressed.

**Carrier Frequency**

The frequency of the carrier signal.

**Carrier-to-Noise Ratio (C/N)**

The ratio of carrier signal power to average noise power in a given bandwidth surrounding the carrier; usually expressed in decibels.

**Center Frequency**

That frequency which corresponds to the center of a frequency span, expressed in hertz.

**Clear (Erase)**

Presets memory to a prescribed state, usually that denoting zero.

**Controls**

User-accessible mechanisms to modify setup parameters.

**dBm**

A unit of expressed power level in decibels referenced to 1 milliwatt.

**dBmV**

A unit to express voltage levels in decibels referenced to 1 millivolt.

**dB $\mu$ V**

A unit to express voltage levels in decibels referenced to 1 microvolt.

**Decibel (dB)**

Ten times the logarithm of the ratio of one electrical power to another.

**Depth of Modulation**

The difference between the maximum and the minimum of the RF envelope amplitude expressed as a percentage of the maximum RF envelope level.

**Display Law**

The mathematical law that defines the input-output function of the instrument. The following cases apply:

**Linear**

A display in which the scale divisions are a linear function of the input signal voltage.

**Square Law (Power)**

A display in which the scale divisions are a linear function of the input signal power.

**Logarithmic**

A display in which the scale divisions are a logarithmic function of the input signal voltage.

**Display Line**

A horizontal or vertical line on a waveform display, used as a reference for visual (or automatic) comparison with a given level, time, or frequency.

**Display Reference Level**

A designated vertical position representing a specified input level. The level may be expressed in dBm, volts, or any other units.

**Distortion**

Degradation of a signal, often a result of nonlinear operations, resulting in unwanted signal components. Harmonic and intermodulation distortion are common types.

**Dynamic Range**

The maximum ratio of the levels of two signals simultaneously present at the input which can be measured to a specified accuracy.

**Export**

Save data to a file in a format other than application-native.

**FFT Time**

The length of time covered by one frame, whether or not an RBW filter is applied to the FFT. This was previously called a “multi-frame”.

**Filter**

A circuit which separates electrical signals or signal components based on their frequencies.

**Frame**

A series of time-contiguous samples, long enough in duration and at a sufficient sample rate to produce a spectrum view of a specified span and RBW.

**Frequency**

The rate at which a signal oscillates, or changes polarity, expressed as hertz or number of cycles per second.

**Frequency Band**

The continuous range of frequencies extending between two limiting frequencies, expressed in hertz.

**Frequency Domain Representation**

The portrayal of a signal in the frequency domain; representing a signal by displaying its sine wave components; the signal spectrum.

**Frequency Drift**

Gradual shift or change in displayed frequency over the specified time due to internal changes in the spectrum analyzer, where other conditions remain constant. Expressed in hertz per second.

**Frequency Modulation (FM)**

The process, or result of a process, in which the frequency of an electrical signal (the carrier) is varied in accordance with some characteristic of a second electrical signal (the modulating signal or modulation).

**Frequency Range**

The range of frequencies over which the performance of the instrument is specified.

**Frequency Span (Dispersion)**

The magnitude of the frequency band displayed; expressed in hertz or hertz per division.

**FSK**

Acronym for Frequency Shift Keying. The process, or result of a process, in which the frequency of the carrier is varied in accordance with the state of a digital input signal.

**GPIB**

Acronym for General Purpose Interface Bus, the common name for the communications interface system defined in IEEE Std 488.

**Graticule**

The calibrated grid overlaying the display screen of spectrum analyzers, oscilloscopes, and other test instruments.

**Grayed Out**

An on-screen control is “grayed out” if it is not adjustable.

**Import**

Bring data into the application from a file of some format other than application-native.

**Input Impedance**

The impedance at the desired input terminal. Usually expressed in terms of VSWR, return loss, or other related terms for low impedance devices and resistance-capacitance parameters for high impedance devices.

**Intermediate Frequency (IF)**

In a heterodyne process, the sum or difference frequency at the output of a mixer stage which will be used for further signal processing.

**Key Contacts**

A pattern of interlaced fingers on the front-panel circuit board that form a contact closure when mated with a conductive pad under a mechanical front panel button.

**Link**

Connect to a file containing settings or other data to be used by the application. Maintain the connection.

**Live Trace**

Any combination of the A trace and/or the B trace when SAVE A is off.

**Load**

Copy settings or other data from a file, but don't maintain any connection with that file.

**Local Oscillator (LO)**

An oscillator which produces the internal signal that is mixed with an incoming signal to produce the IF signal.

**Marker**

A visually identifiable point on a waveform trace, used to extract a readout of domain and range values represented by that point.

**MAX HOLD**

Digitally stored display mode which, at each frequency address, compares the incoming signal level to the stored level and retains the greater level. In this mode, the display indicates the peak level at each frequency after several successive sweeps.

**MIN HOLD**

A spectrum analyzer feature which captures the minimum signal amplitude at all displayed frequencies over a series of sweeps.

**Modulate**

To regulate or vary a characteristic of a signal.

**Modulating Signal**

The signal which modulates a carrier. The signal which varies or regulates some characteristic of another signal.

**Modulation**

The process of varying some characteristic of a signal with a second signal.

**Noise**

Unwanted random disturbances superimposed on a signal which tend to obscure it.

**Noise Floor**

The self-noise of an instrument or system that represents the minimum limit at which input signals can be observed. The spectrum analyzer noise floor appears as a "grassy" baseline in the display, even when no signal is present.

**Open (Recall, Restore)**

Bring data into the application from a file of application-native format.

**OQPSK**

Acronym for Offset QPSK (Quadrature Phase Shift Keying).

**PDF**

Acronym for Probability Distribution Function.

**Peak Detection**

A detection scheme wherein the peak amplitude of a signal is measured and displayed. In spectrum analysis,  $20 \log(\text{peak})$  is often displayed.

**Platform Utility**

User-available software applications provided with the instrument.

**Primary Marker**

The marker displayed in the Single Marker mode whose frequency and/or position is changed when tuning with the general purpose knob.

**PSK**

Acronym for Phase Shift Keying. The process, or result of a process, in which the carrier phase is varied discretely in accordance with a digital code.

**QAM**

Acronym for Quadrature Amplitude Modulation. The process, or result of a process, in which the amplitude and phase of the carrier are varied concurrently by synthesizing two orthogonal ASK waves (see ASK).

**Reference Level**

The signal level required to deflect the CRT display to the top graticule line.

**Residual FM (Incidental FM)**

Short term displayed frequency instability or jitter due to instability in the spectrum analyzer local oscillators. Given in terms of peak-to-peak frequency deviation and expressed in hertz or percent of the displayed frequency.

**Residual Response**

A spurious response in the absence of an input signal. (Noise and zero pip are excluded.)

**Resolution Bandwidth (RBW)**

The width of the narrowest filter in the IF stages of a spectrum analyzer. The RBW determines how well the analyzer can resolve or separate two or more closely spaced signal components.

**Save**

Commit data to memory in application-native format.

**Secondary Marker**

The “second” marker displayed only in the Delta Marker mode.

**Sensitivity**

Measure of a spectrum analyzer’s ability to display minimum level signals, expressed in volts or decibels. Internal frequency (IF) bandwidth, display mode, and any other influencing factors must be given.



**Shape Factor (Skirt Selectivity)**

The ratio of the frequency separation of the two (60 dB/6 dB) down points on the response curve to the static resolution bandwidth.

**Single Sweep**

Operating mode in which the sweep generator must be reset for each sweep. Especially useful for obtaining single examples of a signal spectrum.

**Span Per Division, Span/Div**

Frequency difference represented by each major horizontal division of the graticule.

**Spectrum**

The frequency domain representation of a signal wherein it is represented by displaying its frequency distribution.

**Spectrum Analysis**

The technique or process of determining the frequency distribution of a signal.

**Spectrum Analyzer**

A device for determining the frequency components of a signal.

**Spectrum Length**

The amount of time required to acquire one frame.

**Spurious Response**

A response to a spectrum analyzer wherein the displayed frequency is not related to the input frequency.

**Vertical Scale Factor, Vertical Display Factor**

The number of units (such as dB or V), represented by one vertical division of a spectrum analyzer display screen.

**View**

An area or window of the display screen which contains information all of the same type (such as a Spectrum View or a Power versus Time View).



# Index



# Index

## A

- A/D overflow, 3-147
- AC line frequency, 1-12
- Accessories, G-1
  - optional, G-3
  - standard, G-3
- ACPR measurement, 3-6
  - RFID analysis (Option 21 only), 3-84
- Acquisition
  - history, 3-158
  - length, 3-158
- Acquisition/Analysis menu, 3-157
  - zoom, 3-27
- AM signal measurement, 3-43
- AM/AM
  - measurement, 3-61
  - view setting, 3-221
- AM/PM
  - measurement, 3-63
  - view setting, 3-222
- Amplitude
  - correction, 3-148
  - menu, 3-143, 3-144
  - setting, 3-143
- Analog modulation analysis, 3-41
  - basic procedure, 3-41
- Analysis
  - length, 3-158
  - offset, 3-158
- Analysis range, setting, 3-34
- Angular units, System menu, 2-25
- Architecture, 1-7
- Arrow keys, Markers menu, 3-236
- ASK
  - Modulation Type, 3-49
  - note for measurements, 3-55
- Audio measurements (Option 10 only), 3-67
- Auto level, 3-144
- Average, 3-191
  - Demod mode, 3-196
  - DPX spectrum, 3-193
  - menu, 3-192
  - Time mode, 3-196
  - type, 3-197

## B

- Backing up user files, 1-22

- Bin, relation between frame, bin, and pixel, 3-200
- Block diagram, 1-7
- Bluetooth, 3-49
- Brightness
  - adjusting, 1-28
  - uneven, 1-21

## C

- C/N measurement, 3-7
- C4FM, 3-49
- Cal menu, 1-24
- Calibration, 1-23
- Carrier frequency measurement, 3-10
- Carrier measurement, RFID analysis (Option 21 only), 3-80
- Carrier tracking, Signal source analysis (Option 21 only), 3-125
- Caution, RF INPUT, 1-14
- CCDF
  - Demod mode, 3-64
  - Time mode, 3-104
  - view setting, 3-212
- Center offset calibration, 1-26
- Changing
  - overview, 3-38
  - subview, 3-38
- Channel power measurement, 3-5
- Channel table, using, 3-138
- Cleaning, F-1
- Compression, trace data, 3-200
- Constellation
  - measurement, 3-56
  - RFID analysis (Option 21 only), 3-96
  - view setting, 3-213
- Continuous, trigger, 3-165
- Conventions, xxiii
- Copy, screen, 3-283
- Correction, amplitude
  - description, 3-148
  - menu, 3-149
- CPM
  - Modulation Type, 3-49
  - symbol value, 3-219
- CSV file format, 3-278

**D**

- DC offset calibration, 1-27
- Decoding format, RFID analysis (Option 21 only), 3-87
- Default settings, restoring, 2-24
- Demod mode, 3-31
- Digital IQ output (Option 05)
  - pin assignment, C-1
  - rear panel connectors, 2-5
  - turning on or off, 2-25
- Digital modulation analysis, 3-48
  - basic procedure, 3-55
  - symbol mapping, B-1
- Display, dead pixel, 1-21
- Display line, 3-227
  - multi display lines (Real Time S/A only), 3-231
  - operation, 3-228
- Documentation list, xxii
  - PDF, xxii
- DPX spectrum
  - average, 3-193
  - displaying, 3-18
  - marker operation, 3-242
  - view setting, 3-207

**E**

- EBW measurement, 3-10
- Ethernet connector, side panel, 2-6
- EVM
  - measurement, 3-57
  - view setting, 3-215
- Extended Res, 3-181
- Eye diagram
  - analysis, 3-60
  - RFID analysis (Option 21 only), 3-96
  - setting, 3-219

**F**

- Features, 1-1
- FFT
  - description, 3-179
  - Extended Res., 3-181
  - menu, 3-180
  - overlap, 3-183
  - points, 3-184
  - window, 3-185
- File
  - Bitmap trace file format, 3-276
  - data file format, 3-266

- entering a name, 3-262
  - format, 3-265
  - loading, 3-254
  - operation, 3-251
  - overwrite, 3-258
  - saving, 3-254
  - trace file format, 3-274
  - type, 3-251
- Floppy disk
    - drive, side panel, 2-6
    - using, 3-254
  - FM signal measurement, 3-44
  - Frame, relation between frame, bin, and pixel, 3-200
  - Free Run, trigger mode, 3-165
  - Frequency
    - menu, 3-136
    - setting, 3-135
  - Frequency versus Time measurement, 3-103
    - Signal source analysis (Option 21 only), 3-133
  - Frequency/Channel, 3-136
  - FSK
    - Modulation Type, 3-49
    - note for measurements, 3-55
  - FSK deviations measurement, 3-66
  - Functional check, 1-16

**G**

- Gain calibration, 1-25
- General purpose knob, 2-3
- GPIO, rear panel connector, 2-5

**H**

- Hard copy, screen, 3-283
- Harmonics, 3-73
- Help, menu, 3-245
- How to adjust
  - center offset, 1-26
  - DC offset, 1-27
  - display brightness, 1-28
  - gain, 1-25
  - IF flatness, 1-27
- How to create
  - amplitude correction files, 3-151
  - directory, 3-264
  - files, 3-285
  - trigger mask, 3-171
- How to delete
  - directories, 3-264
  - files, 3-264
- How to display

- averaged waveforms, 3-198
  - data by trigger and repeat modes, 3-169
  - DPX spectrum, 2-46
  - horizontal display line, 3-229
  - multiple views, 3-205
  - online help, 3-245
  - options, 2-26
  - spectrogram, 2-48
  - spectrum, 2-33
  - trace 1 and 2, 3-196
  - trigger point, 3-177
  - versions, 2-26
  - vertical display line, 3-230
  - Windows desktop, 2-27
- How to enter
- file name, 3-262
  - numeric data, 2-19
- How to install
- keyboard, 2-7
  - mouse, 2-7
  - printer driver, 3-284
  - USB printer connection, 3-284
- How to load
- files, 3-254
  - menu settings, 3-254
  - trace, 3-200
- How to save
- amplitude correction table, 3-148, 3-251
  - data to a PC via a network, 1-22, 2-6
  - files, 3-254
  - menu settings, 3-254
  - preset files, 3-256
  - screen copy to a disk, 3-285
  - trace, 3-200
- How to set, zoomed area, 3-28
- Hum and Noise Ratio, 3-75
- I**
- IF flatness calibration, 1-27
- Input
- menu, 3-249
  - over-voltage, 3-147
  - source, 3-249
- Inspection, F-1
- Installation, 1-11
- Integrated phase noise, description, 3-123
- Interface, maps, 2-1
- IQ
- digital IQ output (Option 05), 2-5
  - input, note, 3-249
  - IQ versus Time measurement, 3-46, 3-101
  - IQ/Frequency versus Time measurement, 3-58
- K**
- Key, lock, 2-12
- Keyboard, operation, 2-8
- Keypad, 2-3
- entering a file name, 3-262
  - using, 2-21
- L**
- LAN Ethernet connector, side panel, 2-6
- Limit mask, file format, 3-279
- Lines
- menu, 3-228
  - menu (Real Time S/A), 3-232
- Load, menu, 3-252
- M**
- Main view, modulation analysis screen, 3-33
- Manuals list, xxii
- PDF, xxii
- Map, interface, 2-1
- Marker
- Bitmap trace, 3-242
  - menu, 3-236
  - operation, 3-235
- Marker Setup, 3-237
- MAT file format, 3-278
- Max Hold, description, 3-197
- Meas Setup menu
- digital modulation analysis, 3-49
  - FM Demod measurement, 3-43, 3-44
  - PM Demod measurement, 3-45
  - pulse measurement, 3-116
- Measurement, mode, 2-23
- Measurements
- ACPR, 3-6
  - AM demod, 3-43
  - AM/AM, 3-61
  - AM/PM, 3-63
  - analog modulation analysis, 3-41
  - C/N, 3-7
  - carrier frequency, 3-10
  - CCDF, 3-64, 3-104
  - channel power, 3-5
  - constellation, 3-56
  - digital modulation analysis (Option 21 only), 3-48
  - EBW, 3-10

- EVM, 3-57
- eye diagram, 3-60
- FM demod, 3-44
- frequency versus time, 3-103
- FSK deviations, 3-66
- IQ versus time, 3-46, 3-101
- IQ/frequency versus time, 3-58
- modulation analysis (Demod mode), 3-31
- OBW, 3-8
- PDF, 3-65
- PM demod, 3-45
- power versus time, 3-59, 3-102
- pulse, 3-109
- pulse spectrum, 3-47
- real-time analysis, 3-23
- spectrum analysis (S/A mode), 3-1
- spurious signal, 3-12
- symbol table, 3-60
- time analysis (Time mode), 3-99

Menu

- Acquisition/Analysis, 3-157
- Amplitude, 3-143
- amplitude correction, 3-149
- Average, 3-192
- basic operation, 2-18
- FFT, 3-180
- Frequency, 3-136
- front panel keys, 2-3
- Help, 3-245
- Input, 3-249
- Lines, 3-228
- Lines (Real Time S/A), 3-232
- Load, 3-252
- Markers, 3-236
- Print, 3-283
- RBW, 3-180
- Save, 3-252
- Span, 3-136
- System, 2-25
- Trace, 3-192
- tree, A-1
- Trigger, 3-164
- View, 3-204

Min Hold, description, 3-197

Minimum jump, setting, 3-244

Mode, selecting, 2-22

Modulation analysis (Demod mode), 3-31

Mouse, operation, 2-8

Mult display lines (Real Time S/A only), 3-231

## N

- NBW, setup display, 2-13
- Noisogram
  - Signal source analysis (Option 21 only), 3-127
  - view setting, 3-224
- Numeric input, 2-19

## O

- OBW measurement, 3-8
- Online help, using, 3-245
- Option, displaying, 2-26
- Option key, 2-27
- Optional accessories, G-3
- Options, G-1
- OQPSK, shifting Q data, 3-53
- Overlap, FFT, 3-183
- Overrange, 3-147
- Overview
  - changing, 3-38
  - modulation analysis screen, 3-33
- Over-voltage input, 3-147

## P

- P25 C4FM, 3-49
- PDF
  - measurement, 3-65
  - view setting, 3-223
- PDF manuals, xxii
- Peak, 3-236
- Peak search, 3-235
  - operation, 3-243
  - setting minimum jump, 3-244
- Phase noise measurement, Signal source analysis (Option 21 only), 3-121
- Pin assignment, digital IQ output connectors (Option 05), C-1
- Pixel, relation between frame, bin, and pixel, 3-200
- PM signal measurement, 3-45
- Power
  - AC requirements, 1-12
  - applying, 1-12
  - connecting the cord, 1-12
  - powering off, 1-20
  - principal power switch, 1-13
  - switch, 1-13



Power on/down measurement, RFID analysis  
 (Option 21 only), 3-85  
 Power versus Time measurement, 3-102  
 Demod mode, 3-59  
 Preset, 2-24  
 Principal power switch, 1-13  
 Print  
 menu, 3-283  
 screen copy, 3-283  
 Product description, 1-1  
 Programmer Manual, related documents, xxii  
 Pulse measurements, 3-109  
 Pulse spectrum, 3-47

## Q

Q Data Half Symbol Shift, 3-53

## R

Random jitter, description, 3-123  
 RBW  
 description, 3-179  
 menu, 3-180  
 Real Time S/A, operation, 3-23  
 Real-time phase noise measurement, Signal source  
 analysis (Option 21 only), 3-127  
 Real-time spurious measurement, Signal source  
 analysis (Option 21 only), 3-131  
 Real-time analysis, 1-3  
 S/A mode, 3-23  
 Rear panel, 2-4  
 Removable hard disk drive (Option 06), using, D-1  
 Repeat, trigger, 3-165  
 Restart, 1-21  
 Restoring the operating system, E-1  
 RF envelope measurement, RFID analysis  
 (Option 21 only), 3-92  
 RF INPUT, Caution, 1-14  
 RFID analysis (Option 21 only), 3-77  
 ACPR measurement, 3-84  
 carrier measurement, 3-80  
 constellation, 3-96  
 eye diagram, 3-96  
 Power on/down measurement, 3-85  
 RF envelope measurement, 3-92  
 spurious measurement, 3-82  
 symbol table, 3-96  
 RMS, description, 3-197  
 RMSE<sub>Expo</sub>, description, 3-197  
 Run/Stop key, 2-24

## S

S/A mode, 3-1  
 S/A with Spectrogram, operation, 3-21  
 Save, menu, 3-252  
 Save on trigger, 3-170  
 Scalar mode, span, 3-142  
 Scale menu  
 AM/AM, 3-221  
 AM/PM, 3-222  
 CCDF, 3-212  
 Constellation, 3-213  
 DPX spectrum, 3-207  
 EVM, 3-215  
 eye diagram, 3-219  
 noisogram, 3-224  
 PDF, 3-223  
 spectrogram, 3-208  
 spectrum, 3-206  
 symbol table, 3-218  
 time domain view, 3-210  
 Scan Disk, 1-21  
 Screen, elements, 2-9  
 Screen copy, 3-283  
 Seamless acquisition, 3-161  
 Select, Markers, 3-236  
 Setting, analysis range, 3-34  
 Setup, display, 2-13  
 Shifting Q data (OQPSK), 3-53  
 Side keys, 2-3  
 Side panel, 2-6  
 Signal amplitude limit, 1-14  
 Signal processing, 1-7  
 Signal source analysis (Option 21 only), 3-119  
 frequency versus time measurement, 3-133  
 phase noise measurement, 3-121  
 real-time phase noise measurement, 3-127  
 real-time spurious measurement, 3-131  
 spurious measurement, 3-125  
 Signal/Noise and Distortion, 3-69  
 Single, trigger, 3-165  
 Single view, 3-40  
 Span, 3-137  
 menu, 3-136  
 setting, 3-135  
 vector span, 3-142  
 Spectrogram  
 S/A with Spectrogram, 3-21  
 view setting, 3-208  
 Spectrum  
 analysis, S/A mode, 3-1  
 length, 3-158

- offset, 3-159
- view setting, 3-206
- Spectrum emission mask measurement, S/A mode, 3-14
- Spurious measurement
  - RFID analysis (Option 21 only), 3-82
  - S/A mode, 3-12
  - Signal source analysis (Option 21 only), 3-125
- Stand, setting up, 1-15
- Standard accessories, G-3
- Status, display, 2-11
- Step size
  - center frequency, 2-22
  - setting, 2-22
- Stop and Show Results, 3-166
- Subview
  - changing, 3-38
  - modulation analysis screen, 3-33
- Symbol mapping, B-1
- Symbol table
  - analysis, 3-60
  - RFID analysis (Option 21 only), 3-96
  - setting, 3-218
- Symmetrical filter, Signal source analysis (Option 21 only), 3-125
- Synchronous operation, external trigger, 3-178
- System menu, 2-25

## T

- Tari, RFID analysis (Option 21 only), 3-86
- Technical Reference, related documents, xxii
- Time analysis (Time mode), 3-99
- Time domain, view setting, 3-210
- Time variation measurement, 3-100
  - basic procedure, 3-100
- Trace
  - comparison, 3-191
  - displaying, 3-196
  - menu, 3-192
  - saving/loading, 3-200
- Trigger, 3-163
  - creating a mask, 3-171
  - level, 3-167
  - menu, 3-164

- mode, 3-165
- position, 3-166
- save on trigger, 3-170
- slope, 3-168
- source, 3-166
- synchronous operation, 3-178
- trigger output, indicating, 3-177
- trigger point indicator, 3-177
- Triggered, trigger mode, 3-165
- Troubleshooting, 1-21
- Tutorial, 2-29

## U

- UNCAL, 1-14
- Unpacking, 1-11
- USB connectors, side panel, 2-7
- USB flash drive, using (Option 06), D-1
- User filter
  - file format, 3-280
  - menu, 3-51

## V

- Vector mode, span, 3-142
- Vector span, 3-142
- Version, displaying, 2-26
- VGA output connector, side panel, 2-7
- Video filter, RFID analysis (Option 21 only), 3-83
- View
  - menu, 3-204
  - setting, 3-203

## W

- Windows XP, using, 2-27

## Z

- Zoom
  - Acquisition/Analysis menu, 3-27
  - function, 3-27
  - setting a zoomed area, 3-28