

VibroOne

The Polytec VibroOne laser Doppler vibrometer is the one-box solution for non-contact vibration measurement. With VibroOne you analyze acoustics, dynamics and vibration issues in both R&D and industrial quality control with laser precision. The VibroOne comprises an all-in-one front-end with integrated laser and a fiber-coupled, compact sensor head. Integrated with the VibroLink digital interface and the VibSoft data acquisition and analysis software, this vibration measurement system is ready to point, shoot and measure in an instant.

VibroOne is specifically designed for tightly packed setups, whether in research laboratories, challenging production environments or for non-contact analysis of tiny details on microstructures or biomedical probes. The optional inline HD+ camera helps positioning the laser precisely and provides proper test documentation. An optical filter adjusts for a perfect contrast. Optional microscope lenses focus to a 1.5 μm laser spot, allowing the inspection of fine details.



Highlights

- Non-contact measurement of vibration with laser precision
- Compact design for simple handling in labs and production
- Easy setup and documentation with integrated HD+ camera
- From DC to 3 MHz with highest time resolution
- Synchronous output of displacement, velocity and acceleration
- VibroLink digital interface for convenient setup, data transfer and best SNR

VibroOne

One-box solution for laser vibration sensing

Preliminary datasheet

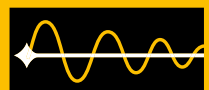

Technical data



General specifications

Model	VibroOne VIO-130		
Component	Sensor VIO-130-STA	Sensor VIO-130-CAM	Front-end
HD+ camera	no	yes	–
Dimensions (L x W x H)	183 x 67 x 41 mm (7.2 x 2.64 x 1.61 in)	183 x 67 x 61 mm (7.2 x 2.64 x 2.40 in)	463 x 430 x 140 ¹ mm (18.2 x 16.9 x 5.5 ¹ in)
Weight	1.0 kg (2.2 lbs)	1.1 kg (2.4 lbs)	14.7 kg (32.4 lbs) ²
Protection class	IP40	IP40	IP20
Interface/display	signal level display	signal level display	7" color touchscreen with interactive menu guidance for setup of front-end and sensor
Cable length	3 m (Sensor to front-end, not separable, optional: 5 m)		
Operating temperature	+5 °C ... +40 °C (41 °F ... 104 °F)		
Storage temperature	+10 °C ... +65 °C (14 °F ... 149 °F)		
Relative humidity	max. 80%, non-condensing		
Power supply	100...240 VAC ± 10 %, 50/60 Hz		
Power consumption	max. 150 VA		

¹ Height of front-end housing with sensor tray and cord wrap: 166 mm (6.54 in)

² For weight of 3 m fiber cable add 300 g (0.66 lbs), for 5 m fiber cable add ca. 600 g (1.3 lbs)

Metrological specifications

Analog signal outputs	3 BNC connectors (± 1 V @ 50 Ω ; ± 2 V @ 1M Ω) for simultaneous and phase synchronized output of: <ul style="list-style-type: none"> • Velocity • Displacement¹ • Acceleration¹
Digital signal outputs	VibroLink digital interface for measurement data (velocity) and signal level, requires VibSoft 5.5 data acquisition and analysis software
Frequency bandwidth	DC to 3 MHz ¹ (12 selectable frequency bandwidths)
Max. velocity	± 12 m/s
High pass filters	Can be chosen individually for velocity, displacement and acceleration signal: 1 Hz, 2 Hz, 4 Hz, 8 Hz, 15 Hz, 30 Hz, 60 Hz, 120 Hz, 250 Hz, 500 Hz, 1 kHz, 2 kHz, 4 kHz, 8 kHz (depending on selected frequency bandwidth)
Low pass filters	Can be chosen individually for displacement and acceleration signals: 1 kHz, 2 kHz, 5 kHz, 10 kHz, 20 kHz, 50 kHz, 100 kHz, 200 kHz, 500 kHz, 1 MHz, 1.5 MHz, 3 MHz (depending on selected frequency bandwidth for the velocity signal)
Tracking filter	Slow, medium, fast
Signal level	<ul style="list-style-type: none"> • Bargraph on touchscreen and on sensor • Output as DC voltage signal (BNC, 0 ... 2 V)
Analog input signals	CLEAR IN: resets displacement signal to zero (BNC); Analog mode and digital mode (TTL)
PC interface	Via integrated VibroLink connector and data cable (Ethernet): remote control of the instrument settings and digital transfer of measured velocity data to the VibSoft data acquisition and analysis software (requires VibSoft 5.5 or newer) or remote control of the instrument settings with web browser

¹ Depending on configuration

Optical specifications	
Laser type	Helium Neon (HeNe)
Laser class	Class 2, < 1 mW
Laser wavelength	633 nm, visible red laser beam
Focus	Manual focus
Minimum stand-off distance ¹	204 mm with standard objective lens, 20 mm with microscope objective
Maximum stand-off distance	Surface dependent
Visibility maxima ¹	44 mm + n · 204 mm; n = 0; 1; 2; ...

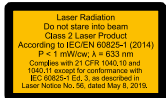

¹ Measured from the front edge of the front lens

HD+ camera specifications (integrated in VIO-130-CAM)	
Camera type	CMOS color camera
Resolution (H x V)	1920 x 1920 pixel (1.8 x HD resolution)
Lens aperture	F 4.5
Contrast adjustment	Polarization filter for adjusting the brightness of the laser spot in the video image, can be adjusted by the user
Video output	USB 3.0 (Micro-B/A), requires camera cable VFX-C-100-C0x (length 3 m, 5 m or 8 m)

Working distance and laser spot size			
Stand-off distance [mm] ¹	Laser spot diameter (1/e ²) [μm]	Laser depth-of-field [mm]	Camera field of view [mm x mm]
20 ²	1.5	-	0.8 x 0.8
33.5 ³	3.0	-	1.6 x 1.6
204	31	±1	16 x 16
300	46	±3	24 x 24
400	62	±5	32 x 32
500	77	±7	40 x 40
600	93	±11	48 x 48
700	109	±15	57 x 57
800	124	±19	65 x 65
900	139	±24	73 x 73
1000	154	±30	81 x 81
1500	230	±66	121 x 121
2000	306	±116	162 x 162
5000	-	-	403 x 403
Each m plus	+ 150	-	-

¹ Measured from the front edge of the front lens (respectively from the front of the microscope objective).

² with VIB-A-20xLENS microscope objective

³ with VIB-A-10xLENS microscope objective

Configurable options

The VibroOne Laser Vibrometer offers a lot of flexibility: thanks to its various options for frequency bandwidth, output signals for measurands (velocity, displacement and acceleration), signal enhancement capabilities and accessories, which can be combined freely with each other, it fits perfectly to your application.

Frequency bandwidth

Choose between different maximum frequency bandwidths from 100 kHz to 3 MHz covering the acoustic and the ultrasonic range.

i	Option	Description	
	VIO-BW-100kHz	100 kHz maximum frequency bandwidth	S
	VIO-BW-500kHz	500 kHz maximum frequency bandwidth	O
	VIO-BW-1MHz	1 MHz maximum frequency bandwidth	O
	VIO-BW-3MHz	3 MHz maximum frequency bandwidth	O

S = Standard / O = Option

Velocity output

VibroOne allows measuring vibrational velocities up to ± 12 m/s (see also page 9). For extending the velocity resolution, the option VIO-VelResS offers additional measurement ranges down to ± 1 mm/s (peak).

Maximum velocity options

Option	Description	
VIO-Vel-12m/s	Maximum velocity ± 12 m/s	S

S = Standard / O = Option

Velocity resolution options

Option	Description	
VIO-VelResH	High resolution Most sensitive measurement range ± 0.01 m/s (peak)	S
VIO-VelResS	Super fine resolution Extra fine resolution thanks to additional velocity measurement ranges. Most sensitive measurement range ± 0.001 m/s (peak)	O

S = Standard / O = Option

Displacement output

In addition to the velocity output, the displacement output option VIO-DispOut can be added, providing a maximum displacement of ± 200 mm (peak). For resolving smallest movements, super fine measurement ranges can be chosen (see also page 10).

Maximum displacement options		
VIO-DispL	Standard Displacement Range Allows displacement measurements up to ± 200 mm (peak)	S



S = Standard / O = Option

Displacement resolution options		
Option	Description	
VIO-DispResH	High resolution Most sensitive measurement range ± 1 μ m (peak) with a resolution of 31 pm.	S
VIO-DispResS	Super fine resolution Most sensitive measurement range ± 10 nm (peak) with a resolution of 0.3 pm.	O

S = Standard / O = Option

Acceleration output

Adding the acceleration output option VIO-AccOut enables measuring accelerations up to 100×10^6 m/s² at frequencies up to 3 MHz (see also page 12). Recommended for measuring frequencies up to 100 kHz.

Signal enhancement

For reliable measurement results with best signal-to-noise ratio even under difficult conditions, the included tracking filter with three ranges is available.



Option	Description	
VIO-TRACK	Tracking Filter 3 steps: slow, medium, fast	S

S = Standard



Options and accessories







Sensor head options

VIO-I-130-STA	Compact sensor head with smallest form factor	S	
VIO-I-130-CAM	Compact sensor head with integrated HD+ camera (USB 3.0) for easy targeting, especially when measuring with a microscope objective on a small object. Also includes adjustable contrast filter for clearly visible laser spot with varying surface reflectivity.	O	
VFX-A-001 Sensor tray with cord wrap	Sensor tray and cord wrap for easy handling and transport in the lab	O	







General accessories



Option	Description		
VFX-C-100-D02 Data Cable	Data cable (length 2 m) for connecting VibroOne to a computer. Industrial grade connector M12 and RJ45 (Ethernet, x-coded). Allows configuration via web browser and data transfer via VibroLink.	S	
A-RMK-0002 Rack Mounting Kit	Rack Mounting Kit with two handles on the front and additional flanges for mounting the VibroOne front-end in a 19" rack (Dimensions: 19", 84 HP/3 U).	O	

Optical accessories

VIB-A-10xLENS Microscope Objective	10x microscope objective providing a laser spot diameter of 3 μm at 33.5 mm stand-off distance, requires VIB-A-203 Front Lens Adapter for usage with VibroOne	O	
VIB-A-20xLENS Microscope Objective	20x microscope objective providing a laser spot diameter of 1.5 μm at 20 mm stand-off distance, requires VIB-A-203 Front Lens Adapter for usage with VibroOne	O	
VIB-A-203 Front Lens Adapter	Adapter for mounting VIB-A-10xLENS or VIB-A-20xLENS microscope objectives on VibroOne	O	
VIB-A-511 Illumination Unit	LED light source providing a coaxial illumination of the test object. The illumination unit is highly recommended in conjunction with the microscope objectives	O	
VIB-A-532 90° Deflection Unit	90° deflection of the laser beam (video image not fully visible). Can be rotated freely in any direction.	O	

S = Standard / O = Option

Optical accessories and transportation cases			
VIB-A-210 90° Deflection Unit	Allows 90° deflection of laser beam and video image. Can be rotated in any direction. Must be combined with VIB-A-220 or VIB-A-221 Protective Window or a VIB-A-230 Air purge unit.	○	
VIB-A-220 Protective Window with tube	Protects the objective lens of the laser vibrometer from dust, oil and contamination. Tube around window for additional protection.	○	
VIB-A-221 Protective Window flat	Protects the objective lens of the laser vibrometer from dust, oil and contamination. Flat design for easy cleaning.	○	
VIB-A-230 Air Purge Unit	For improved protection of the protective window from oil mist and dust. Includes a Protective window with tube (similar to VIB-A-220) and VIB-A-202 Lens adapter with compressed air connection for mounting on sensor head. Requires oil-free compressed air.	○	
VIB-A-240 Pneumatic Beam Shutter	For mounting on VIB-A-220 Protective window with tube or VIB-A-230 Air purge unit. Mechanically protects protective window from dust and contamination. Requires compressed air for opening.	○	
VIB-A-CAS17 Transp. Case (VibroOne VIO-130)	Robust transportation case for the laser vibrometer front-end and the sensor	○	
VIB-A-CAS13 Transp. Case (VibroFlex Compact Accessories)	Robust transportation case providing space for VIB-A-203 Front Lens Adapter, VIB-A-511 Illumination Unit and the microscope objectives VIB-A-10xLENS and VIB-A20xLENS	○	



Tripods			
VIB-A-T02 Standard Tripod	Easy targeting on the object under test	○	
VIB-A-T05 Tripod with Geared Pan/Tilt Head	For precise pointing of the sensor head. The geared pan/tilt head allows quick coarse adjustment and fine adjustment in 3 axes	○	

S = Standard / O = Option

Options and accessories



Positioning stages

VIB-A-P01 Tilt Stage	Allows fine adjustment of the sensor head by tilting. The tilt travel is $\pm 9^\circ$. Quick release plates to interface with VIB-A-T02 and VIB-A-T05 tripods are included.	<input type="radio"/>	
VIB-A-P02 2-Axes Stage: X plus Tilt	Allows fine adjustment of the sensor head in 2 axes. The travel of the traverse stage is 105 mm and the tilt travel is $\pm 9^\circ$. Quick release plates to interface with VIB-A-T02 and VIB-A-T05 tripods are included.	<input type="radio"/>	
VIB-A-P06 3-Axes Stage: XY plus Tilt	Allows fine adjustment of the sensor head in 3 axes. The travel of the x & y traverse is 100 mm along and across laser beam and the tilt stage is $\pm 9^\circ$. Quick release plates to interface with VIB-A-T02 and VIB-A-T05 tripods are included.	<input type="radio"/>	

S = Standard / O = Option

VibSoft data acquisition and analysis software

VibSoft is a comprehensive and easy-to-use software package for digital vibration data acquisition and analysis. VibSoft closes the gap between raw signal acquisition and profound analysis of vibration measurement data. The VibroLink interface allows direct and fully digital data acquisition of the velocity signal via Ethernet for the full frequency bandwidth. Alternatively, the multi-channel DAQ units permit connecting additional analog inputs like other sensors, processing data up to 40 MHz. Further options like the powerful SignalProcessor (a Polytec math library for post-processing) and a scripting engine for individual post-processing and control make VibSoft an extremely powerful tool.

Polytec offers a wide range of accessories for setting up and performing measurements. Please contact your local vibrometer sales engineer or visit our website www.polytec.com/vibroone for more detailed information.

Velocity performance specifications

Measurement range (peak)	Maximum frequency range ¹	Typical resolution ²	Maximum acceleration	
m/s	kHz	$\frac{\text{nm/s}}{\sqrt{\text{Hz}}}$	m/s ²	
0.001	100	1.5 @ 1 kHz	628	O ³
0.01	3,000	3 @ 10 kHz	188,000	S ⁴
0.1	3,000	18 @ 100 kHz	1,880,000	S ⁴
1	3,000	150 @ 1,000 kHz	18,800,000	S ⁴
6	3,000	400 @ 3,000 kHz	113,000,000	S ⁴
10	3,000	400 @ 3,000 kHz	188,000,000	S ⁴
12	100	300 @ 50 kHz	7,530,000	S ⁴

S = Standard / O = Option

Maximum linearity error: 0.5% for all measurement ranges.

¹ Frequency range from 0 Hz to the given value. Maximum frequency bandwidth depending on system configuration.

² The noise-limited resolution is defined as the signal amplitude (rms) at which the signal-to-noise ratio is 0 dB and with 1 Hz spectral resolution.

³ Requires option VIO-VelResS

⁴ Standard: included with configuration VIO-VEL-12m/s and VIO-VelResH.

Frequency bandwidth	Signal delay
1 MHz .. 3 MHz	20 μs
200 kHz, 500 kHz	40 μs
50 kHz, 100 kHz	400 μs
5 kHz .. 20 kHz	900 μs
1 kHz, 2 kHz	2.5 ms

The signal delay is independent of the selected measurement range and the switched on filters. It is identical for velocity, displacement and acceleration.

Displacement performance specifications ¹

i	Measurement range (peak)	Maximum frequency range ²	Resolution ³	available with the following options	
	μm	kHz	pm	VIO-DispResS	VIO-DispResH / VIO-DispL
	0.01	3,000	0.31	○	
	0.1	3,000	3.13	○	
	1	3,000	31.25		S
	10	3,000	312.5		S
	100	3,000	3,125		S
	1,000	3,000	31,250		S
	10,000	3,000	312,500		S
	100,000	3,000	3,125,000		S
	200,000	3,000	6,250,000		S

S = Standard / ○ = Option

¹ Displacement output requires option VIO-DispOut

² Frequency range from 0 Hz to the given value. Maximum frequency bandwidth depending on system configuration.

³ The resolution corresponds to the quantization step at the analog output. Noise limited resolution: < 30 fm/SQRT(Hz) in the smallest measurement range. The noise-limited resolution is defined as the signal amplitude (rms) at which the signal-to-noise ratio is 0 dB with an 1 Hz spectral resolution.

Dimensions

Front-end

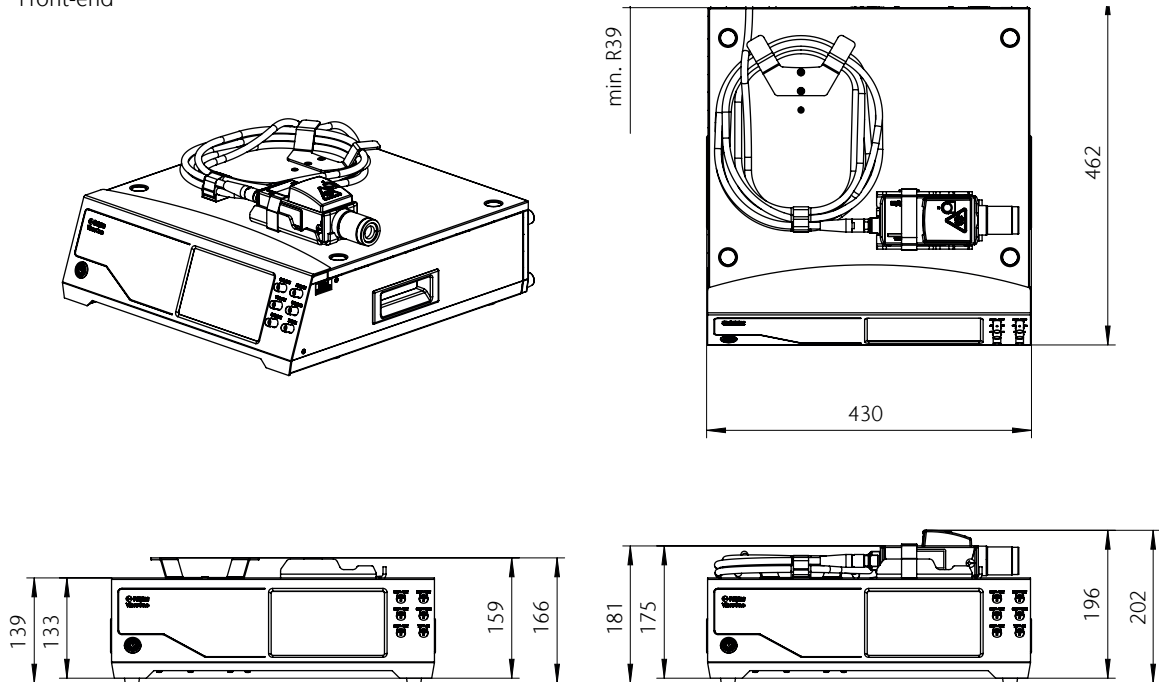

Sensor

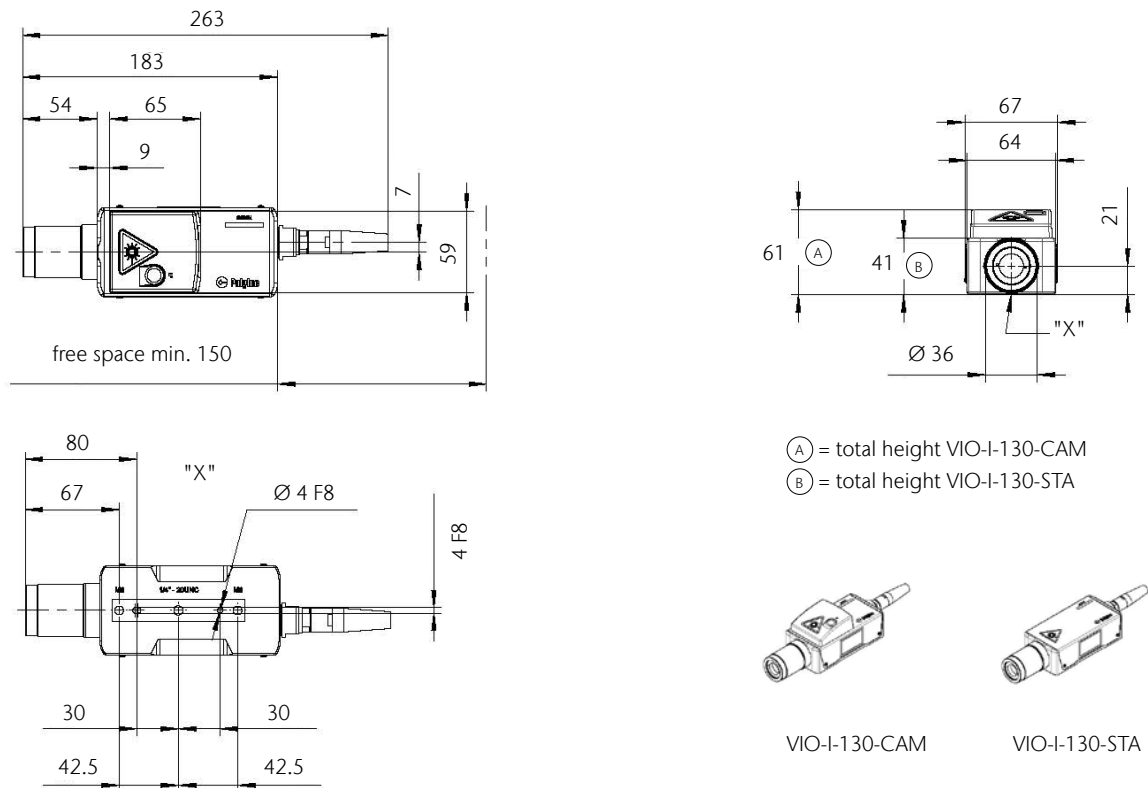

All dimensions in mm if not marked otherwise

Acceleration performance specifications ¹

Measurement range (peak)	Maximum frequency range ²	i
m/s ²	kHz	
10	3,000	
100	3,000	
1,000	3,000	
10,000	3,000	
100,000	3,000	
1,000,000	3,000	
10,000,000	3,000	
100,000,000	3,000	

¹ Acceleration output requires option VIO-AccOut

² Frequency range from 0 Hz to the given value. Maximum frequency bandwidth depending on system configuration. For acceleration measurements a maximum frequency bandwidth of 100 kHz is recommended.

Compliance with standards

Laser safety	IEC/EN 60825-1	
Electrical safety	IEC/EN 61010-1	
EMC	IEC/EN 61326-1	
	Emission:	Limit class B IEC/EN 61000-3-2 and 61000-3-3
	Immunity:	IEC/EN 61000-4-2 to 61000-4-6 and IEC/EN 61000-4-11

Shaping the future since 1967

High tech for research and industry.
Pioneers. Innovators. Perfectionists.

Find your Polytec representative:
www.polytec.com/contact

Polytec GmbH · Germany
Polytec-Platz 1-7 · 76337 Waldbronn