

Identical User Interfaces

New ! 30V, 40V and 50V models - 15kW

New ! 800V, 1000V, 1250V and 1500V models - 10kW/15kW

Genesys™

**Programmable DC Power Supplies
10kW/15kW in 3U
Built in RS-232 & RS-485 Interface
Advanced Parallel Operation**

**Optional Interfaces:
IEEE 488.2 Compliant LAN
GPIB (IEEE 488.2 & SCPI Compliant)
Isolated Analog Program/Monitor**



Genesys™ Family

GEN H 750W Half-Rack

GEN 1U 750W/1500W/2400W Full-Rack

GEN 2U 3.3kW/5kW

GEN 3U 10kW/15kW

TDK-Lambda

www.us.tdk-lambda.com/hp

The Genesys™ family of programmable power supplies sets a new standard for flexible, reliable, AC/DC power systems in OEM, Industrial and Laboratory applications.

Features include:

- High Power Density 10kW/15kW in 3U package
- High Output Current up to 1000ADC
- Wide Range of popular worldwide 3Φ AC inputs, (208VAC, 400VAC, 480VAC)
- Power Factor 0.88 (Passive PFC on all AC Inputs)
- Output Voltage up to 1500V; Output Current up to 1000A
- Built-in RS-232/RS-485 Interface Standard
- Last Setting Memory; Front Panel Lockout
- “Advanced Parallel” configuration reports total system current (up to four identical units)
- Global Commands for Serial RS-232/RS-485 Interface
- Continuous Encoders for Voltage and Current Adjustment
- Independent Remote ON/OFF and Remote ENABLE/DISABLE
- Reliable Modular and SMT Design
- 19” Rack Mounted for ATE and OEM Applications, zero-stack
- Optional Interfaces
 - LXI Compliant LAN (Class C)
 - GPIB (IEEE 488.2 & SCPI Compliant) w/ Multi-Drop capability
 - Isolated Analog Programming and Monitoring Interface (0-5V/0-10V & 4-20mA)
- LabView™ and LabWindows™ Software Drivers
- Worldwide Safety Agency Approvals; UL Recognized and CE Mark for LVD and EMC Regulation (208VAC, 400VAC and select 480VAC models)
- Five Year Warranty



Applications

Genesys™ power supplies are designed for demanding applications.

Test & Measurement systems using GPIB control save significant costs by incorporating the optional IEEE Multi-Drop Interface (IEMD) in the Master unit. Then up to 30 Slave units may be used with the standard RS-485 Multi-Drop interface.

Automated System designers will appreciate new, standard, remote programming features such as Global commands. Also, new high-speed status monitoring is available for the RS-485 bus as well as the optional LAN (LXI compliant) Interface.

Industrial & Military high power systems can be configured with up to four identical units in parallel (up to 60kW). No space is required above or below each power supply (zero stack). The Master unit can be configured by the user to report the total Output current of the combined system. Applications include Heaters, Magnets and Laser Diodes.

Aerospace & Satellite Testing systems use the complete Genesys™ Family: **1U**-750W Half-Rack, **1U**-750W/1.5kW/2.4kW Full-Rack, **2U**-3.3kW/5kW Full-Rack and **3U**-10kW/15kW Full-Rack. All are identical in Front Panel, Rear Panel Analog and Digital Interface Commands. A wide variety of Outputs (voltage and current) allows testing of many different user configurations.

Component Device Testing is simplified because of the many user-friendly control options in the Analog and Digital interfaces. Lamps, capacitors, motors and actuators are typical devices tested.

Medical Imaging and Treatment systems require reliable power. Modular construction, SMT and thoroughly proven designs assure continuous performance at full rated power.

Semiconductor Processing & Burn-in equipment designers appreciate the wide variety of worldwide AC Inputs and Outputs from which to select, depending on application. Selectable Safe-Start and Auto Re-Start protects loads and process integrity. Typical applications include Magnets, Filaments and Heaters.

Front Panel Description

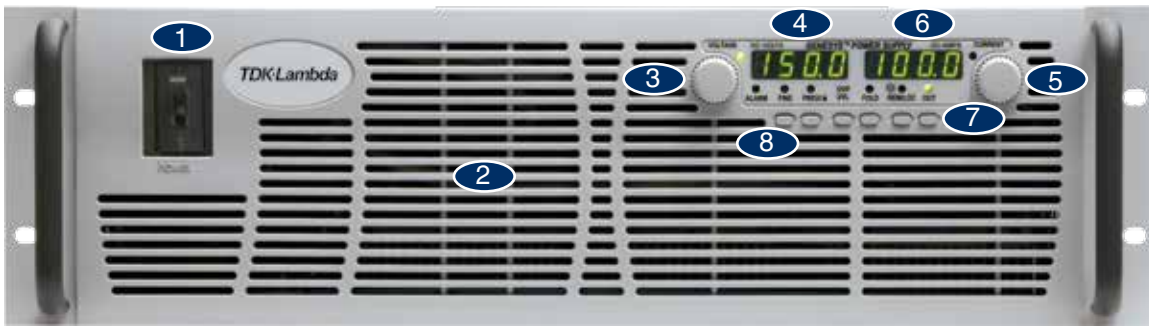

1. AC ON/OFF Switch
2. Air Intake allows zero stacking for maximum system flexibility and power density.
3. Continuous encoder controls Output Voltage, Address, OVP and UVL settings.
4. Voltage Display shows Output Voltage and directly displays OVP, UVL and Address settings.
5. Continuous encoder controls Output Current, sets Baud rate and Advanced Parallel mode.
6. Current Display shows Output Current and displays Baud rate. Displays total current in Parallel Master/Slave Mode.
7. Function/Status LEDs:
 - Alarm
 - Foldback Mode
 - Fine Control
 - Remote Mode
 - Preview Settings
 - Output On
8. Pushbuttons allow flexible user configuration
 - Coarse and Fine adjustment of Output Voltage/Output Current and Advanced Parallel Master or Slave select.
 - Preview Settings and set Voltage/Current with Output OFF, Front Panel Lock.
 - Parallel Master/Slave (Basic and Advanced).
 - Set OVP and UVL Limits.
 - Set Current Foldback Protection.
 - Go to Local Mode and select Address and Baud rate.
 - Output ON/OFF and Safe-Start/Auto Re-Start mode.

Rear Panel Description

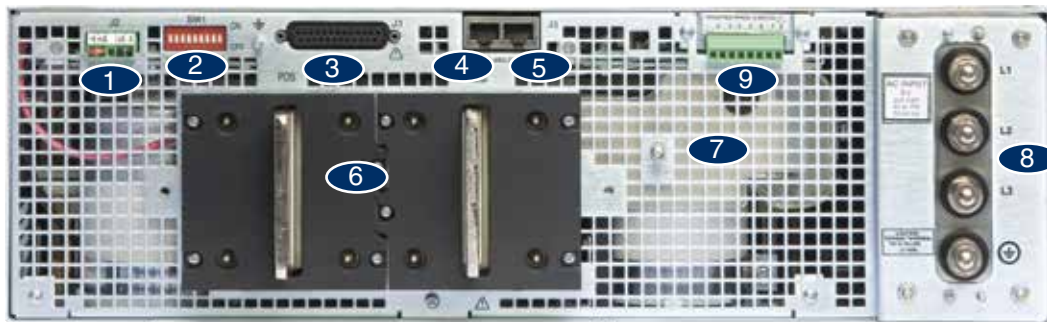

1. Remote/Local Output Voltage Sense Connections.
2. DIP Switches select 0-5V or 0-10V Programming and other functions.
3. DB25 (Female) connector allows Analog Program and Monitor (non-isolated) and other functions.
4. RS-485 OUT to other Genesys™ Power Supplies.
5. RS-232/RS-485 IN Remote Serial Programming.
6. Output Connectors: Rugged 2 hole busbars (shown) for models < 30V Output, single hole busbars for 30V to 300V Output, and threaded-stud terminals for models > 300V Output.
7. Exit air assures reliable operation when zero stacked.
8. Input Terminals L1, L2, L3, and Ground (threaded studs).
9. Optional Interface Position for LAN (LXI Class C), GPIB (IEEE 488.2 SCPI) or Isolated Analog Interface.

LAN Interface complies with **LXI** Class C Specification

Genesys™ 3U 10kW Specifications

10kW

1.0 MODEL	GEN	7.5-1000	10-1000	12.5-800	20-500	25-400	30-333	40-250	50-200	60-167	80-125	100-100	125-80	X
1. Rated Output Voltage	VDC	7.5	10	12.5	20	25	30	40	50	60	80	100	125	X
2. Rated Output Current	ADC	1000	1000	800	500	400	333	250	200	167	125	100	80	X
3. Rated Output Power	kW	0.75	10.0	10.0	10.0	10.0	10.0	10.0	10.0	10.0	10.0	10.0	10.0	X
4. Efficiency (min) at low AC line, 100% Rated Load	%	77	83											X
Contact Factory for other models														

1.1 CONSTANT VOLTAGE MODE (CV)															
1. Max. Line Reg (0.1% - Vor ≤ 30V; 0.01% - 30V < Vor ≤ 600V; 0.05% - 600V < Vor ≤ 1500V)	mV	7.5	10	12.5	20	25	30	4	5	6	8	10	12.5	X	
2. Max. Load Reg (0.1% - Vor ≤ 30V; 0.02% - 30V < Vor ≤ 600V; 0.1% - 600V < Vor ≤ 1500V)	mV	7.5	10	12.5	20	25	30	8	10	12	16	20	25	X	
3. Ripple, rms, 5Hz-1MHz, CV (*1)	mV	20	20	20	20	20	20	20	20	20	25	25	25	X	
4. Output Noise, p-p, (20MHz), CV (*1)	mV	60	60	60	60	60	60	60	75	75	100	100	125	X	
5. Remote Sense Compensation / Wire	V	1	1	1	1	1	1.5	2	3	3	4	5	5	X	
6. Temperature Stability	---	± 0.05% of Vo(rated) over 8 hours after 30 minute warm up (constant Line, Load & Temperature)													X
7. Temperature Coefficient	ppm / °C	± 200 (± 0.02% of Vo Rated) / °C													X
8. Up-Prog. Response Time, 0 - Vomax, full-load	ms	100													X
9. Up-Prog. Response Time, 0 - Vomax, no-load	ms	50													X
10. Transient Response Time (CV mode) (*2)	ms	Less than 3													X

1.2 CONSTANT CURRENT MODE (CC)															
1. Max. Line Reg. (0.1% - Ior ≥ 333A; 0.050% - 17A < Ior < 333A; 0.15% - Ior < 17A)	mA	1000	1000	800	500	400	333	125	100	83.5	62.5	50	40	X	
2. Max. Load Reg (0.1% - Ior ≥ 333A; 0.075% - 17A ≤ Ior < 333A; 0.2% - Ior < 17A) (*3)	mA	1000	1000	800	500	400	333	188	150	125	94	75	60	X	
3. Ripple rms, 5Hz-1MHz, CC	mA	5300	4000	2560	1000	640	444	250	160	67	50	40	32	X	
4. Temperature Stability	---	± 0.05% of Io(rated) over 8 hours after 30 minute warm up (constant Line, Load & Temperature)													X
5. Temperature Coefficient	ppm/°C	± 300 (± 0.03% of Io Rated) / °C													X

1.3 PROTECTIVE FUNCTIONS															
1. OCP	%	0 ~ 100													X
2. OCP type	---	Constant current													X
3. Foldback Protection (FOLD)	---	Output shutdown; Manual reset by front panel OUT button or Digital communication, user-selectable													X
4. Foldback Response Time	S	Less than 1 (Min = 0.25 / Max = 25 / Default = 0.25); Settable via "FBD" command													X
5. OVP type	---	Inverter shut-down; Manual reset by AC On/Off recycle, OUT button, Remote Analog or Digital communication													X
6. OVP Programming Accuracy	%	± 5% of Vo(rated)													X
7. OVP Trip Point	V	5% to 105% of Vo(rated) - for Vor ≤ 600V; 10% to 105% of Vo(rated) - 600V < Vor ≤ 1500V; Shall always be greater than 105% of Vo(setting); Default = 105% of Vo(rated).													X
8. OVP Response Time	ms	Less than 10 (for Output to begin to drop) for Vor ≤ 600V; Less than 2.0 (for Output to begin to drop) for 600V < Vor ≤ 1500V.													X
9. Max. OVP Reset Time	s	7 (from AC On/Off switch turn On)													X
10. Over-Temperature Protection (OTP)	---	Shut down if internal temperature exceeds safe operating levels (Latched: Safe-mode / Unlatched: Auto-mode)													X
11. Phase-Loss Protection	---	Yes, power supply shutdown (Latched: Safe-mode / Unlatched: Auto-mode)													X

1.4 REMOTE ANALOG CONTROLS & SIGNALS															
1. Vout Voltage Programming		0-100%, 0 ~ 5V or 0 ~ 10V, user-selectable., Accuracy & Linearity: ±1% of Vo(rated)													X
2. Iout Voltage Programming		0-100%, 0 ~ 5V or 0 ~ 10V, user-selectable, Accuracy & Linearity: ± 1% of Io(rated)													X
3. Vout Resistor Programming		0-100%, 0 ~ 5/10kohm full-scale, user-selectable, Accuracy & Linearity: ± 1% of Vo(rated)													X
4. Iout Resistor Programming		0-100%, 0 ~ 5/10kohm full-scale, user-selectable, Accuracy & Linearity: ± 1% of Io(rated)													X
5. Shut-Off (SO) Control (rear panel)		By Voltage: 0.6V = Disable, 2-15V = Enable (default) or Dry Contact: Open = EN, Short = DIS (user-selectable logic)													X
6. Output Current Monitor		0 ~ 5V or 0 ~ 10V, Accuracy: ± 1% of Io(rated), user-selectable													X
7. Output Voltage Monitor		0 ~ 5V or 0 ~ 10V, Accuracy: ± 1% of Vo(rated), user-selectable													X
8. Power Supply OK (PS_OK) Signal		Yes. TTL High = OK, 0V = Fail (500ohm series impedance)													X
9. CV/CC Signal		CV: TTL High (4 ~ 5V), Max source current = 10mA; CC: TTL Low (0 ~ 0.4V), Max sink current = 10mA													X
10. Enable/Disable		Dry contact; Open = Off, Short = On; Max. voltage across Enable/Disable contacts = 6V													X
11. Remote/Local Selection		Selects Remote or Local operation by voltage: 0 ~ 0.6V = Local / 2 ~ 15V = Remote													X
12. Remote/Local Signal		Signals operating mode; Open collector: Local = Open (Max voltage = 30V), Remote = On (Max sink current = 10mA)													X

1.5 FRONT PANEL															
1. Control Functions		Vout/ Iout manual adjust by separate encoders (coarse and fine adjustment selectable)													X
		OVP/UVL manual adjust by Voltage Adjust encoder, Front Panel Lock/Unlock													X
		Address selection by Voltage Adjust encoder. # of addresses = 31													X
		AC ON/OFF, Output On/Off, Restart Modes (Auto/Safe), Foldback Control (CV to CC), Go-to-Local													X
		RS-232/RS-485, IIEEE (IEMD) and LAN selection by rear panel DIP-switch													X
2. Display		Baud rate selection (RS-232/RS-485 only): 1200, 2400, 4800, 9600 and 19,200 (by current adjust encoder)													X
		Advanced Parallel Master/Slave: Hx = Master unit, where x = # of Slave units (0 to 4), S = Slave unit(s)													X
		Voltage: 4 digits, Accuracy: ± 0.5% of Vo(rated) ± 1 count													X
3. Indications		Current: 4 digits, Accuracy: ± 0.5% of Io(rated) ± 1 count													X
		Voltmeter displays voltage at power supply (Local sense) or at load (Remote sense)													X
		Green LED's: PREVIEW, FOLD, REM/LOCAL, OUT ON/OFF, CV/CC, FINE													X
	Red LED: ALRM (OVP, OTP, FOLD, AC FAIL, ENA, SO)													X	

1.6 DIGITAL PROGRAMMING & READBACK															
1. Vout Programming Accuracy		± 0.5% of rated Output voltage													X
2. Iout Programming Accuracy		± 0.5% of rated Output current for units with Io < 187.5A; ± 0.7% of rated Output current for Io ≥ 187.5A													X
3. Vout Programming Resolution		0.02% of Vo(rated)													X
4. Iout Programming Resolution		0.04% of Io(rated)													X
5. Vout Readback Accuracy		± (0.1% of Vo(actual) + 0.2% of Vo(rated))													X
6. Iout Readback Accuracy		± (0.1% of Io(actual) + 0.4% of Io(rated))													X
7. Vout Readback Resolution		0.02% of Vo(rated)													X
8. Iout Readback Resolution		0.02% of Io(rated)													X
9. OV Response Time		20ms maximum (between Vout exceeding IEEE Limit and supply Inhibit turning On)													X
10. Other Functions		Set OVP/UVL limits; Set Local/Remote, Operating parameters and Status, Get Identity													X

*1. Ripple and Noise at Vo(rated) and rated Load, Ta = 25C and nominal AC input, per EIJ R9002A.
 *2. Time for the Output voltage to recover within 2% of rating for a load current change of 50-100% or 100-50% of Io(rated).
 *3. From 20% - 100% for models with Ior < 17A.
 All specifications subject to change without notice.

Genesys™ 3U 10kW Specifications

		10kW
1.0 MODEL	GEN	150-66 200-50 250-40 300-33 400-25 500-20 600-17 800-12.5 1000-10 1250-8 1500-6.7
1. Rated Output Voltage	VDC	150 200 250 300 400 500 600 800* 1000* 1250* 1500*
2. Rated Output Current	ADC	66 50 40 33 25 20 17 12.5 10 8.0 6.7
3. Rated Output Power	kW	9.9 10.0 10.0 9.9 10.0 10.0 10.2 10.0 10.0 10.0 10.0
4. Efficiency (min) at low AC line, 100% Rated Load	%	83 93.5
1.1 CONSTANT VOLTAGE MODE (CV)	Contact Factory for other models	
1. Max. Line Reg (0.1% - Vor ≤ 30V; 0.01% - 30V < Vor ≤ 600V; 0.05% - 600V < Vor ≤ 1500V)	mV	15 20 25 30 40 50 60 400 500 625 750
2. Max. Load Reg (0.1% - Vor ≤ 30V; 0.02% - 30V < Vor ≤ 600V; 0.1% - 600V < Vor ≤ 1500V)	mV	30 40 50 60 80 100 120 800 1000 1250 1500
3. Ripple, r.m.s, 5Hz-1MHz, CV (*1)	mV	25 35 35 60 60 60 60 80 100 120 140
4. Output Noise, p-p (20MHz), CV (*1)	mV	150 175 200 200 300 350 350 700 800 1000 1400
5. Remote Sense Compensation / Wire	V	5 5 5 5 5 5 5 5 5 5 5
6. Temperature Stability	---	± 0.05% of Vo(rated) over 8 hours after 30 minute warm up (constant Line, Load & Temperature)
7. Temperature Coefficient	ppm / °C	± 200 (0.02% of Vo Rated) / °C
8. Up-Prog. Response Time, 0-Vomax, full-load	mS	100 17
9. Up-Prog. Response Time, 0-Vomax, no load	mS	50 17
10. Transient Response Time (CV mode) (*2)	mS	Less than 3 Less than 1
1.2 CONSTANT CURRENT MODE (CC)		
1. Max. Line Reg (0.1% - Ior ≥ 333A; 0.050% - 17A < Ior < 333A; 0.15% - Ior < 17A)	mA	33 25 20 17 13 10 9 19 15 12 10
2. Max. Load Reg (0.1% - Ior ≥ 333A; 0.075% - 17A ≤ Ior < 333A; 0.2% - Ior < 17A) (*3)	mA	50 38 30 25 19 15 13 25 20 15 14
3. Ripple rms, 5Hz-1MHz, CC	mA	26 20 16 13 10 8 7 15 10 6 4
4. Temperature Stability	---	± 0.05% of Io Rated over 8 hours after 30 minute warm up (constant Line, Load & Temperature)
5. Temperature Coefficient	ppm / °C	± 300 (0.03% of Io Rated) / °C
1.3 PROTECTIVE FUNCTIONS		
1. OCP	%	0 ~ 100
2. OCP type	---	Constant current
3. Foldback Protection (FOLD)	---	Output shut down; Manual reset by front panel OUT button or Digital communication, user-selectable
4. Foldback Response Time	S	Less than 1 (Min = 0.25 / Max = 25 / Default = 0.25); Settable via "FBD" command
5. OVP type	---	Inverter shut-down; Manual reset by AC On/Off recycle, OUT button, Remote Analog or Digital comm.
6. OVP Programming Accuracy	%	± 5% of Vo(rated)
7. OVP Trip Point	V	5% to 105% of Vo(rated) - for Vor ≤ 600V; 10% to 105% of Vo(rated) - 600V < Vor ≤ 1500V; Shall always be greater than 105% of Vo(setting); Default = 105% of Vo(rated).
8. OVP response time	mS	Less than 10 (for Output to begin to drop) for Vor ≤ 600V; Less than 2.0 (for Output to begin to drop) for 600V < Vor ≤ 1500V.
9. Max. OVP reset time	S	7 (from AC On/Off switch turn On)
10. Over-Temperature Protection (OTP)	---	Shut down if internal temperature exceeds safe operating levels. (Latched: Safe / Unlatched: Auto)
11. Phase-Loss Protection	---	Yes, power supply shutdown (Latched: Safe-mode / Unlatched: Auto-mode)
1.4 REMOTE ANALOG CONTROLS & SIGNALS		
1. Vout Voltage Programming		0~100%, 0 ~ 5V or 0 ~ 10V, user-selectable, Accuracy & Linearity: ± 1% of Vo(rated)
2. Iout Voltage Programming		0 ~ 100%, 0-5V or 0 ~ 10V, user-selectable, Accuracy & Linearity ± 1% of Io(rated)
3. Vout resistor programming		0~100%, 0-5/10kohm full-scale, user-selectable, Accuracy & Linearity ± 1% of Vo(rated)
4. Iout Resistor Programming		0~100%, 0-5/10kohm full-scale, user-selectable, Accuracy & Linearity ± 1% of Io(rated)
5. Shut-Off (SO) Control (rear panel)		By Voltage: 0.6V = Disable, 2-15V = Enable (default) or Dry Contact : Open = ENA, Short = DIS (user-selectable logic)
6. Output Current Monitor		0 ~ 5V or 0 ~ 10V, Accuracy: ± 1% of Io(rated), user-selectable
7. Output Voltage Monitor		0 ~ 5V or 0 ~ 10V, Accuracy: ± 1% of Vo(rated), user-selectable
8. Power Supply OK (PS_OK) Signal		Yes, TTL high = OK, 0V = Fail (500ohm series impedance)
9. CV/CC Signal		CV: TTL High (4 ~ 5V), Max source current = 10mA; CC: TTL Low (0 ~ 0.4V), Max sink current = 10mA
10. Enable/Disable		Dry contact; Open = Off, Short = On; Max. voltage across Enable/Disable contacts = 6V
11. Remote/Local Selection		Selects Remote or Local operation by voltage: 0 ~ 0.6V = Local / 2 ~ 15V = Remote
12. Remote/Local Signal		Signals operating mode; Open collector: Local = Open (Max voltage = 30V), Remote = On (Max sink current = 10mA)
1.5 FRONT PANEL		
1. Control Functions		Vout/ Iout manual adjust by separate encoders (coarse and fine adjustment selectable) OVP/UVL manual adjust by Voltage Adjust encoder, Front Panel Lock/Unlock Address selection by Voltage Adjust encoder. # of addresses = 31 AC ON/OFF, Output On/Off, Restart Modes (Auto/Safe), Foldback Control (CV to CC), Go-to-Local RS-232/RS-485, IEEE (IEMD) and LAN selection by rear-panel DIP-switch Baud rate selection (RS-232/RS-485 only): 1200, 2400, 4800, 9600 and 19,200 (by current adjust encoder) Advanced Parallel Master/Slave: Hx = Master unit, where x = # of Slave units (0 to 4), Slave = Slave unit(s)
2. Display		Voltage: 4 digits, Accuracy: ± 0.5% of Vo(rated) ± 1 count Current: 4 digits, Accuracy: ± 0.5% of Io(rated) ± 1 count Voltmeter displays voltage at power supply (Local sense) or at load (Remote sense)
3. Indications		Green LED's: PREVIEW, FOLD, REM/LOCAL, OUT ON/OFF, CV/CC, FINE Red LED: ALRM (OVP, OTP, FOLD, AC FAIL, ENA, SO)
1.6 DIGITAL PROGRAMMING & READBACK		
1. Vout Programming Accuracy		± 0.5% of rated Output voltage
2. Iout Programming Accuracy		± 0.5% of rated Output current for units with Io < 187.5A; ± 0.7% of rated Output current for Io ≥ 187.5A
3. Vout Programming Resolution		0.02% of Vo(rated)
4. Iout Programming Resolution		0.04% of Io(rated)
5. Vout Readback Accuracy		± (0.1% of Vo(actual) + 0.2% of Vo(rated))
6. Iout Readback Accuracy		± (0.1% of Vo(actual) + 0.4% of Vo(rated))
7. Vout Readback Resolution		0.02% of Vo(rated)
8. Iout Readback Resolution		0.02% of Io(rated)
9. OV Response Time		20mS maximum (between Vout exceeding IEEE Limit and supply Inhibit turning On)
10. Other Functions		Set OVP/UVL limits; Set Local/Remote, Operating Parameters and Status; Get Identity

*800V - 1500V models (10kW) only available with 400VA and 480VAC input. For 208VAC Input models please contact the factory.

*1. Ripple and Noise at Vo(rated) and rated Load, Ta = 25C and nominal AC input, per EIJ R9002A

*2. Time for the Output voltage to recover within 2% of rating for a load current change of 50~100% or 100~50% of Io(rated).

*3. From 20% - 100% for models with Ior < 17A.

All specifications subject to change without notice.

Genesys™ 3U 15kW Specifications

														15kW	
1.0 MODEL	GEN	N/A	N/A	N/A	N/A	N/A	N/A	30-500	40-375	50-300	60-250	80-187.5	100-150	125-120	X
1. Rated Output Voltage	VDC	---	---	---	---	---	---	30*	40*	50*	60	80	100	125	X
2. Rated Output Current	ADC	---	---	---	---	---	---	500	375	300	250	187.5	150	120	X
3. Rated Output Power	KW	---	---	---	---	---	---	15.0	15.0	15.0	15.0	15.0	15.0	15.0	X
4. Efficiency (min) at low AC line, 100% Rated Load	%	---	---	---	---	---	---	---	---	---	88	---	---	---	X
Contact Factory for other models															
															X

1.1 CONSTANT VOLTAGE MODE (CV)															
1. Max. Line Reg (0.1% - Vor ≤ 30V; 0.01% - 30V < Vor ≤ 600V; 0.05% - 600V < Vor ≤ 1500V)	mV	---	---	---	---	---	---	30	4	5	6	8	10	12.5	X
2. Max. Load Reg (0.1% - Vor ≤ 30V; 0.02% - 30V < Vor ≤ 600V; 0.1% - 600V < Vor ≤ 1500V)	mV	---	---	---	---	---	---	30	8	10	12	16	20	25	X
3. Ripple, rms, 5Hz-1MHz, CV (*1)	mV	---	---	---	---	---	---	20	20	20	20	25	25	25	X
4. Output Noise, p-p, (20MHz), CV (*1)	mV	---	---	---	---	---	---	60	60	75	75	100	100	125	X
5. Remote Sense Compensation / Wire	V	---	---	---	---	---	---	1.5	2	3	3	4	5	5	X
6. Temperature Stability	---	± 0.05% of Vo(rated) over 8 hours after 30 minute warm up (constant Line, Load & Temperature)													X
7. Temperature Coefficient	ppm / °C	± 200 (± 0.02% of Vo(rated)) / °C													X
8. Up-Prog. Response Time, 0 - Vomax, full-load	ms	100													X
9. Up-Prog. Response Time, 0 - Vomax, no load	ms	50													X
10. Transient Response Time (CV mode) (*2)	ms	Less than 3													X

1.2 CONSTANT CURRENT MODE (CC)															
1. Max. Line Reg. (0.1% - Ior ≥ 333A; 0.050% - Ior < 333A)	mA	---	---	---	---	---	---	500	375	334	125	94	75	60	X
2. Max. Load Reg (0.1% - Ior ≥ 333A; 0.075% - 25A ≤ Ior < 333A; 0.2% - Ior < 25A) (*3)	mA	---	---	---	---	---	---	500	375	334	188	141	113	90	X
3. Ripple, rms, 5Hz-1MHz, CC	mA	---	---	---	---	---	---	350	200	150	100	100	100	50	X
4. Temperature Stability	---	± 0.05% of Io(rated) over 8 hours after 30 minute warm up (constant Line, Load & Temperature)													X
5. Temperature Coefficient	ppm/°C	± 300 (± 0.03% of Io(rated)) / °C													X

1.3 PROTECTIVE FUNCTIONS															
1. OCP	%	0 - 100													X
2. OCP type	---	Constant current													X
3. Foldback Protection (FOLD)	---	Output shutdown; Manual reset by front panel OUT button or Digital communication, user-selectable													X
4. Foldback Response Time	s	Less than 1 (Min = 0.25 / Max = 25 / Default = 0.25); Settable via "FBD" command													X
5. OVP type	---	Inverter shut-down; Manual reset by AC On/Off recycle, OUT button, Remote Analog or Digital communication													X
6. OVP Programming Accuracy	%	± 5% of Vo(rated)													X
7. OVP Trip Point	V	5% to 105% of Vo(rated) - for Vor ≤ 600V; 10% to 105% of Vo(rated) - 600V < Vor ≤ 1500V; Shall always be greater than 105% of Vo(setting); Default = 105% of Vo(rated)													X
8. OVP Response Time	ms	Less than 10 (for Output to begin to drop) for Vor ≤ 600V; Less than 2.0 (for Output to begin to drop) for 600V < Vor ≤ 1500V													X
9. Max. OVP Reset Time	s	7 (from AC On/Off switch turn On)													X
10. Over-temperature Protection (OTP)	---	Shut down if internal temperature exceeds safe operating levels (Latched: Safe-mode/ Unlatched: Auto-mode)													X
11. Phase-Loss Protection	---	Yes, power supply shutdown (Latched: Safe-mode / Unlatched: Auto-mode)													X

1.4 REMOTE ANALOG CONTROLS & SIGNALS															
1. Vout Voltage Programming		0-100%, 0 ~ 5V or 0 ~ 10V, user-selectable., Accuracy & Linearity: ±1% of Vo(rated)													X
2. Iout Voltage Programming		0-100%, 0 ~ 5V or 0 ~ 10V, user-selectable, Accuracy & Linearity: ± 1% of Io(rated)													X
3. Vout Resistor Programming		0-100%, 0 ~ 5/10kohm full-scale, user-selectable, Accuracy & Linearity: ± 1% of Vo(rated)													X
4. Iout Resistor Programming		0-100%, 0 ~ 5/10kohm full-scale, user-selectable, Accuracy & Linearity: ± 1% of Io(rated)													X
5. Shut-Off (SO) Control (rear panel)		By Voltage: 0.6V = Disable, 2-15V = Enable (default) or Dry Contact: Open = EN, Short = DIS (user-selectable logic)													X
6. Output Current Monitor		0 ~ 5V or 0 ~ 10V, Accuracy: ± 1% of Io(rated), user-selectable													X
7. Output Voltage Monitor		0 ~ 5V or 0 ~ 10V, Accuracy: ± 1% of Vo(rated), user-selectable													X
8. Power Supply OK (PS_OK) Signal		Yes. TTL High = OK, 0V = Fail (500ohm series impedance)													X
9. CV/CC Signal		CV: TTL High (4 ~ 5V), Max source current = 10mA; CC: TTL Low (0 ~ 0.4V), Max sink current = 10mA													X
10. Enable/Disable		Dry contact; Open = Off, Short = On; Max. voltage across Enable/Disable contacts = 6V													X
11. Remote/Local Selection		Selects Remote or Local operation by voltage: 0 ~ 0.6V = Local / 2 - 15V = Remote													X
12. Remote/Local Signal		Signals operating mode; Open collector: Local = Open (Max voltage = 30V), Remote = On (Max sink current = 10mA)													X

1.5 FRONT PANEL															
1. Control Functions	Vout/ Iout manual adjust by separate encoders (coarse and fine adjustment selectable)														X
	OVP/UVL manual adjust by Voltage Adjust encoder, Front Panel Lock/Unlock														X
	Address selection by Voltage Adjust encoder. # of addresses = 31														X
	AC ON/OFF, Output On/Off, Restart Modes (Auto/Safe), Foldback Control (CV to CC), Go-to-Local														X
	RS-232/RS-485, IEEE (IEMD) and LAN selection by rear panel DIP-switch														X
	Baud rate selection (RS-232/RS-485 only): 1200, 2400, 4800, 9600 and 19,200 (by current adjust encoder)														X
2. Display	Advanced Parallel Master/Slave: Hx = Master unit, where x = # of Slave units (0 to 4); S = Slave unit(s)														X
	Voltage: 4 digits, Accuracy: ± 0.5% of Vo(rated) ± 1 count														X
	Current: 4 digits, Accuracy: ± 0.5% of Vo(rated) ± 1 count														X
3. Indications	Voltmeter displays voltage at power supply (Local sense) or at load (Remote sense)														X
	Green LED's: PREVIEW, FOLD, REM./LOCAL, OUT ON/OFF, CV/CC, FINE Red LED: ALRM (OVP, OTP, FOLD, AC FAIL, ENA, SO)														X

1.6 DIGITAL PROGRAMMING & READBACK															
1. Vout Programming Accuracy		± 0.5% of rated Output voltage													X
2. Iout Programming Accuracy		± 0.5% of rated Output current for units with Io < 187.5A; ± 0.7% of rated Output current for Io ≥ 187.5A													X
3. Vout Programming Resolution		0.02% of Vo(rated)													X
4. Iout Programming Resolution		0.04% of Io(rated)													X
5. Vout Readback Accuracy		± (0.1% of Vo(actual) + 0.2% of Vo(rated))													X
6. Iout Readback Accuracy		± (0.1% of Io(actual) + 0.4% of Io(rated))													X
7. Vout Readback Resolution		0.02% of Vo(rated)													X
8. Iout Readback Resolution		0.02% of Io(rated)													X
9. OV Response Time		20mS maximum (between Vout exceeding IEEE Limit and supply Inhibit turning On)													X
10. Other Functions		Set OVP/UVL limits, Set Local/Remote, Operating parameters and Status, Get Identity													X

*30V, 40V and 50V models (15kW) only available with 400VAC and 480VAC. For 208VAC Input models please contact the factory.

*1. Ripple and Noise at Vo(rated) and rated Load, Ta = 25C and nominal AC input, per EIJ R9002A.

*2. Time for the Output voltage to recover within 2% of rating for a load current change of 50-100% or 100-50% of rated Output.

*3. From 20% - 100% for models with Ior < 25A.

All specifications subject to change without notice.

Genesys™ 3U 15kW Specifications

15kW

1.0 MODEL	GEN	150-100	200-75	250-60	300-50	400-37.5	500-30	600-25	800-18.8	1000-15	1250-12	1500-10	X
1. Rated Output Voltage	VDC	150	200	250	300	400	500	600	800*	1000*	1250*	1500*	X
2. Rated Output Current	ADC	100	75	60	50	37.5	30	25	18.8	15	12	10	X
3. Rated Output Power	kW	15.0	15.0	15.0	15.0	15.0	15.0	15.0	15.04	15.0	15.0	15.0	X
4. Efficiency (min) at low AC line, 100% Rated Load	%	88						93.5					X
1.1 CONSTANT VOLTAGE MODE (CV)													X
Contact Factory for other models													
1. Max. Line Reg (0.1% - Vor ≤ 30V; 0.01% - 30V < Vor ≤ 600V; 0.05% - 600V < Vor ≤ 1500V)	mV	15	20	25	30	40	50	60	400	500	625	750	X
2. Max. Load Reg (0.1% - Vor ≤ 30V; 0.02% - 30V < Vor ≤ 600V; 0.1% - 600V < Vor ≤ 1500V)	mV	30	40	50	60	80	100	120	800	1000	1250	1500	X
3. Ripple r.m.s. 5Hz~1MHz, CV (*1)	mV	25	35	35	60	60	60	60	80	100	120	140	X
4. Output Noise p-p (20MHz), CV (*1)	mV	150	175	200	200	300	350	350	700	800	1000	1400	X
5. Remote Sense Compensation / Wire	V	5	5	5	5	5	5	5	5	5	5	5	X
6. Temperature Stability	---	± 0.05% of Vo Rated over 8 hours, after 30 minute warm up, constant Line, Load & Temperature											X
7. Temperature Coefficient	ppm / °C	200 (0.02% of Vo Rated) / °C											X
8. Up-Prog. Response Time, 0-Vomax, full-load	mS	100						17					X
9. Up-Prog. Response Time, 0-Vomax, no load	mS	50						17					X
10. Transient Response Time (CV mode) (*2)	mS	Less than 3						Less than 1					X
1.2 CONSTANT CURRENT MODE (CC)													X
1. Max. Line Reg (0.1% - Ior ≥ 333A; 0.050% - Ior < 333A)	mA	50	38	30	25	19	15	13	28	23	18	15	X
2. Max. Load Reg (0.1% - Ior ≥ 333A; 0.075% - 25A ≤ Ior < 333A; 0.2% - Ior < 25A) (*3)	mA	75	57	45	38	28	23	19	38	30	24	20	X
3. Ripple r.m.s. 5Hz~1MHz, CC	mA	50	20	20	20	10	10	10	15	10	6	4	X
4. Temperature Stability	---	± 0.05% of Io(rated) over 8 hours after 30 minute warm up (constant Line, Load & Temperature)											X
5. Temperature Coefficient	ppm / °C	± 300 (± 0.03% of Io(rated)) / °C											X
1.3 PROTECTIVE FUNCTIONS													X
1. OCP	%	0 ~ 100											X
2. OCP type	---	Constant current											X
3. Foldback Protection	---	Output shut down; Manual reset by front panel OUT button or Digital communication, user-selectable											X
4. Foldback Response Time	s	Less than 1 (Min = 0.25 / Max = 25 / Default = 0.25); Settable via "FBD" command											X
5. OVP type	---	Inverter shut-down; Manual reset by On/Off recycle, OUT button, Remote Analog or Digital communication											X
6. OVP Programming Accuracy	%	± 5% of Vo(rated)											X
7. OVP Trip Point	V	5% to 105% of Vo(rated) - for Vor ≤ 600V; 10% to 105% of Vo(rated) - 600V < Vor ≤ 1500V; Shall always be greater than 105% of Vo(setting); Default = 105% of Vo(rated)											X
8. OVP response time	ms	Less than 10 (for Output to begin to drop) for Vor ≤ 600V; Less than 2.0 (for Output to begin to drop) for 600V < Vor ≤ 1500V											X
9. Max. OVP reset time	s	7 (from AC On/Off switch turn On)											X
10. Over temperature Protection	---	Shut down if internal temperature exceeds safe operating levels (Latched: Safe/ Unlatched: Auto)											X
11. Phase Loss Protection	---	Yes, power supply shutdown (Latched: Safe-mode / Unlatched: Auto-mode)											X
1.4 REMOTE ANALOG CONTROLS & SIGNALS													X
1. Vout Voltage Programming		0~100%, 0 ~ 5V or 0 ~ 10V, user-selectable, Accuracy & Linearity: ± 1% of Vo(rated)											X
2. Iout Voltage Programming		0 ~ 100%, 0~5V or 0 ~ 10V, user-selectable, Accuracy & Linearity ± 1% of Io(rated)											X
3. Vout resistor programming		0~100%, 0~5/10kohm full-scale, user-selectable, Accuracy & Linearity ± 1% of Vo(rated)											X
4. Iout Resistor Programming		0~100%, 0~5/10kohm full-scale, user-selectable, Accuracy & Linearity ± 1% of Io(rated)											X
5. Shut-Off (SO) Control (rear panel)		By Voltage: 0.6V = Disable, 2-15V = Enable (default) or Dry Contact: Open =EN, Short-DIS (user-selectable logic)											X
6. Output Current Monitor		0 ~ 5V or 0 ~ 10V, Accuracy: ± 1% of Io(rated), user-selectable											X
7. Output Voltage Monitor		0 ~ 5V or 0 ~ 10V, Accuracy: ± 1% of Vo(rated), user-selectable											X
8. Power Supply OK (PS_OK) Signal		Yes, TTL High = OK, 0V = Fail (500ohm series impedance)											X
9. CV/CC Signal		CV: TTL High (4 ~ 5V), Max source current = 10mA; CC: TTL Low (0 ~ 0.4V), Max sink current = 10mA											X
10. Enable/Disable		Dry contact; Open = Off, Short = On; Max. voltage across Enable/Disable contacts = 6V											X
11. Remote/Local Selection		Selects Remote or Local operation by voltage: 0 ~ 0.6V = Local / 2 ~ 15V = Remote											X
12. Remote/Local Signal		Signals operating mode; Open collector: Local = Open (Max voltage = 30V), Remote = On (Max sink current = 10mA)											X
1.5 FRONT PANEL													X
1. Control Functions		Vout/ Iout manual adjust by separate encoders (coarse and fine adjustment selectable) OVP/UVL manual adjust by Voltage Adjust encoder, Front Panel Lock/Unlock Address selection by Voltage Adjust encoder. # of addresses = 31 AC ON/OFF, Output On/Off, Restart Modes (Auto/Safe), Foldback Control (CV to CC), Go-to-Local RS232/RS-485, IEEE (IEMD) and LAN selection by rear panel DIP-switch Baud rate selection (RS-232/RS-485 only): 1200, 2400, 4800, 9600 and 19,200 (y current adjust encoder) Advanced Parallel Master/Slave: Hx = Master unit, where x = # of Slave units (0 to 4); S = Slave unit(s)											X
2. Display		Voltage: 4 digits, Accuracy: ± 0.5% of Vo(rated) ±1 count Current: 4 digits, Accuracy: ± 0.5% of Io(rated) ±1 count Voltmeter displays Voltage at power supply (Local sense) or at load (Remote sense)											X
3. Indications		Green LED's: PREVIEW, FOLD, REM./LOCAL, OUT ON/OFF, CV/CC, FINE Red LED's: ALRM (OVP, OTP, FOLD, AC FAIL, ENA, SO)											X
1.6 DIGITAL PROGRAMMING & READBACK													X
1. Vout Programming Accuracy		± 0.5% of rated Output voltage											X
2. Iout Programming Accuracy		±0.5% of rated Output current for units with Io < 187.5A; +/-0.7% of rated Output current for Io ≥ 187.5A											X
3. Vout Programming Resolution		0.02% of Vo(rated)											X
4. Iout Programming Resolution		0.04% of Io(rated)											X
5. Vout Readback Accuracy		± 0.1% + 0.2% of rated Output voltage											X
6. Iout Readback Accuracy		± 0.1% + 0.4% of rated Output current											X
7. Vout Readback Resolution		0.02% of Vo(rated)											X
8. Iout Readback Resolution		0.02% of Io(rated)											X
9. OV Response Time		20mS maximum (between Vout exceeding OVP Limit and supply inhibit turning On)											X
10. Other Functions		Set OVP/UVL limits, Set Local/Remote, Operating parameters and Status, Get Identity											X

*800V - 1500V models (15kW) only available with 400VA and 480VAC input. For 208VAC Input models please contact the factory.

*1. Ripple and Noise at Vo(rated) and rated Load, Ta = 25C and nominal AC input, per EIJ R9002A.

*2. Time for the Output voltage to recover within 2% of rating for a load current change of 50~100% or 100~50% of Io(rated).

*3. From 20% - 100% for models with Ior < 25A.

All specifications subject to change without notice.

General Specifications, Genesys™ 3U 10kW/15kW

2.1 INPUT CHARACTERISTICS		
1. Input Voltage / Frequency (range)	---	208VAC (180-253), 400VAC (360-440 , 342-440 (select 10kW/15kW models)), 480VAC (432-528); 47-63Hz (all)
2. No. of phases	---	3-Phase (Wye or Delta) 4 wire total (3-Phase and 1 protective Earth ground)
3. Dropout Voltage	V	180 / 360, 342 (select models) / 432; select models (10kW): 800V-1500V, select models (15kW): 30V-50V, 800V-1500V
4. Input Current (180VAC/360 or 342VAC/432VAC)	Arms	10kW - 45/23/20 (Vout ≤ 600V); N/A/23/20 (800V ≤ Vout ≤ 1500V) - at full rated Output power 15kW - 64/32/27 (Vout ≤ 600V); N/A/32/27 (800V ≤ Vout ≤ 1500V) - at full rated Output power
5. Inrush Current	A	Not to exceed full rated Input current (see para. above)
6. Power Factor	---	0.88 Passive (typical)
7. Leakage Current	mA	3.5 (EN60950) max.
8. Input Protection	---	208VAC: circuit breaker (Vout ≤ 600V); 400VAC/480VAC (all models) - line fuse
9. Input Overvoltage Protection	---	Unit shall not be damaged by line overvoltage of 120% nominal AC input voltage with maximum duration of 100usec.
10. Phase Imbalance	%	≤ 5% on Three-Phase Input

2.2 POWER SUPPLY CONFIGURATION	
1. Parallel Operation	Up to four (4) identical units may be connected in Master/Slave Mode with single wire connection (*3). In Advanced-Parallel feature, the current of Master unit multiplied by number of units connected in parallel, is available via digital interface and displayed on the front panel display of the Master unit. Remote Analog current monitor of the Master is scaled to the Output current of the Master unit (only).
2. Series Operation	Possible (with external diodes); Up to two identical units with total Output voltage not to exceed ± 600V from Chassis ground (for Vor ≤ 600V); not to exceed ± 1500V from Chassis ground (for 600V < Vor ≤ 1500V).

2.3 ENVIRONMENTAL CONDITIONS	
1. Operating Temperature	0 ~ +50°C, 100% load
2. Storage Temperature	-20 ~ +70°C
3. Operating Humidity	20 ~ 80% RH (non-condensing)
4. Storage Humidity	10 ~ 90% RH (non-condensing)
5. Vibration & Shock	ASTM D4169, Standard Practice for Performance Testing of Shipping Containers and Systems, Shipping Unit: Single Package Assurance Level: Level II; Acceptance Criteria: Criterion 1 - No product damage Criterion 2 - Packaging is intact, Distribution Cycle: 12 - Air (intercity) and motor freight (local), unitized is used.
6. Altitude	Operating: +50°C up to 7500 ft. (2500m), +45°C from 7501 to 10,000ft (2501m - 3000m), Non-Operating 40,000 ft (12,000m)
7. Audible Noise	65dBA at lo(rated) (measured 1m from front panel)

2.4 EMC (*4)	
1. 208VAC Input	
CE Mark	
1. ESD	EN61000-4-2 (IEC 801-2): Air-discharge ± 8kV , Contact-discharge ± 4kV
2. Fast Transients	EN61000-4-4 (IEC 1000-4-3)
3. Surge Immunity	EN61000-4-5 (IEC 1000-4-5)
4. Conducted Immunity	EN61000-4-6 (IEC 1000-4-6)
5. Radiated Immunity	EN61000-4-3 (IEC 1000-4-3)
6. Power Frequency Magnetic Field	EN61000-4-8
7. Conducted Emissions	EN55011A, FCC part 15J-A
8. Radiated Emissions	EN55011A, FCC part 15J-A
2. 400VAC/480VAC (*4) Input	
CE Mark	
1. ESD	EN61000-4-2 (IEC 801-2): Air-discharge ± 8kV , Contact-discharge ± 4kV
2. Fast Transients	EN61000-4-4 (IEC 1000-4-3)
3. Surge Immunity	EN61000-4-5 (IEC 1000-4-5)
4. Conducted Immunity	EN61000-4-6 (IEC 1000-4-6)
5. Radiated Immunity	EN61000-4-3 (IEC 1000-4-3)
6. Power Frequency Magnetic Field	EN61000-4-8
7. Voltage Dips, Short Interruptions and Voltage Variations Immunity Test (400VAC Only).	IEC 61000-4-11
8. Conducted Emissions	EN55011A, FCC part 15J-A
9. Radiated Emissions	EN55011A, FCC part 15J-A

2.5 SAFETY	
1. Applicable Standards:	UL/cUL 60950-1, EN60950-1 recognized, CB Scheme, CE Mark (208VAC & 400VAC inputs only) 7.5V ≤ Vout ≤ 400V: Output is Hazardous; LAN/IEEE/Isolated Analog/USB are SELV 400V < Vout ≤ 600V: Output is Hazardous; LAN/IEEE/Isolated Analog/USB are not SELV 600V < Vout ≤ 1500V: Output is Hazardous; LAN/IEEE/Isolated Analog/USB are SELV
2. Withstand Voltage	Vout ≤ 300V models: Input - Ground: 2900VDC for 1min, Input-Hazardous Output: 3500VDC for 1min, Input - SELV: 2900VDC for 1min Hazardous Output - SELV: 2121VDC for 1min, Hazardous Output - Ground: 2121VDC for 1min 300 < Vout ≤ 600V models: Input-Ground: 2900VDC for 1min, Input-Hazardous Output: 3900VDC for 1min, Input-SELV: 2900VDC for 1min. Hazardous Output - SELV: 2688VDC for 1min, Hazardous Output - Ground: 2688VDC for 1min 600 < Vout ≤ 1500V models: Input-Ground: 2900VDC for 1min, Input-Hazardous Output: 5040VDC for 1min, Input-SELV: 2900VDC for 1min. Hazardous Output - SELV: 2500VDC for 1min, Hazardous Output - Ground: 2500VDC for 1min
3. Insulation Resistance	> 100Megohms at 500VDC, +25°C

2.6 MECHANICAL CONSTRUCTION	
1. Cooling	Fan-driven, Airflow from front to rear. Fan speed control on 10kW (800V-1500V models) and 15kW (30V-50V, and 800V-1500V models). "Zero Stackable" top and bottom. Vents on side shall not be blocked. Chassis slides or suitable rear support required. EIA rack mounting.
2. Dimensions (W x H x D)	Width: 429mm / 16.9", Height: 3U - 133mm / 5.22", Depth - 564mm / 22.2" (excluding connectors, encoders, handles, etc.)
3. Weight	43kg / 97 lbs (Vout < 600V); 32kg / 70lbs (600V < Vout < 1500V)
4. AC Input connector (with Protective Cover)	3 x M6 x 1" threaded studs (L1, L2, L3 and Chassis GND) and terminal cover.
5. Output Connectors	Up to and including 300V models: bus-bars (one and two-hole). Greater than 300V models: M6 x 0.5" threaded-stud terminals.
6. Control Connectors	Analog Programming: DB25, plastic connector, AMP747461-5, Female on Supply; Male on Mating connector, 747321, 25 pin Sub-D connector.
7. Mounting Method	Standard 19" Rack-Mount, provision for standard chassis slides. Side/Rear Support is required; Do not mount by front panel only.
8. Output Ground Connection	M5 x 1.0" threaded-stud

2.7 WARRANTY	
1. Warranty	5 years

*3 GENESYS™ 30V-50V (15kW) and 800V-1500V (10kW/15kW) models require a Two-Wire Parallel Master-Slave connection. See the Product User's Manual for details.

*4. 30V-50V (15kW) and 800V-1500V (10kW/15kW) models with 480VAC Input have CE Mark.

All specifications subject to change without notice



Genesys™ Power Parallel and Series Configurations

Parallel operation - Master/Slave:

Active current sharing allows up to four identical units to be connected in an Auto-parallel configuration for four times the Output power. In Advanced Parallel Master/Slave Mode, total current is programmed and reported by the Master, Up to four supplies act as one.



Series operation

Up to two units may be connected in series to increase the Output voltage or to provide bipolar output. (Max 600V to Chassis GND for $V_{or} \leq 600V$; Max 1500V to Chassis GND for $600V < V_{or} \leq 1500V$).

Remote Programming via RS-232 & RS-485 Interface

Standard Serial Interface allows daisy-chain control of up to 31 power supplies on the same communication bus with built-in RS-232 & RS-485 Interface.

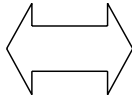

Programming Options (Factory installed)

IEEE Multi-Drop Interface

- Allows IEEE Master to control up to 30 (Standard) slaves over RS-485 daisy-chain
- Only the Master needs be equipped with IEEE Interface
- IEEE 488.2 & SCPI Compliant
- Program Voltage
- Measure Voltage
- Over-Voltage setting and shutdown
- Error and Status Messages
- Program Current
- Measure Current
- Current Foldback shutdown

P/N: IEMD

Multi-Drop Slave Option is Standard

- Standard Units are equipped with the Multi-Drop Slave (RS-485) function
- Allows RS-485 Master to control up to 30 (standard) Slaves over RS-485 Daisy-chain

P/N: "-----"

Isolated Analog Programming

- Four Channels total (Two to Program Voltage and Current; Two to Monitor Voltage and Current)
- Isolation allows operation with floating references in harsh electrical environments.
- Choose between programming with Voltage or Current.
- Connection via removable terminal block: Phoenix MC1,5/8-ST-3.81
- Voltage Programming, User-selectable 0-5V or 0-10V signal.
Power supply Voltage and Current Programming Accuracy: $\pm 1\%$
Power supply Voltage and Current Monitoring Accuracy: $\pm 1.5\%$
- Current Programming with 4-20mA signal.
Power supply Voltage and Current Programming Accuracy: $\pm 1\%$

P/N: IS510

P/N: IS420

LAN Interface

LXI Compliant to Class C

- Meets all LXI Class C Requirements
- Address Viewable on Front Panel
- Fixed and Dynamic Addressing
- Fast Startup
- VISA & SCPI Compatible
- LAN Fault Indicators
- Auto-detects LAN Cross-over Cable
- Compatible with most standard Networks

P/N: LAN

Outline Drawings: Genesys™ 10kW (All - 208VAC), 10kW/15kW (60V to 600V - 208/400/480VAC)

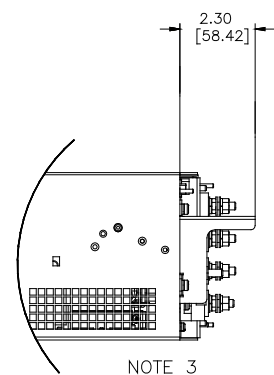
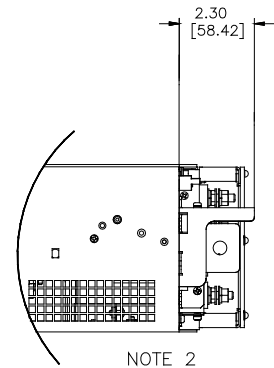
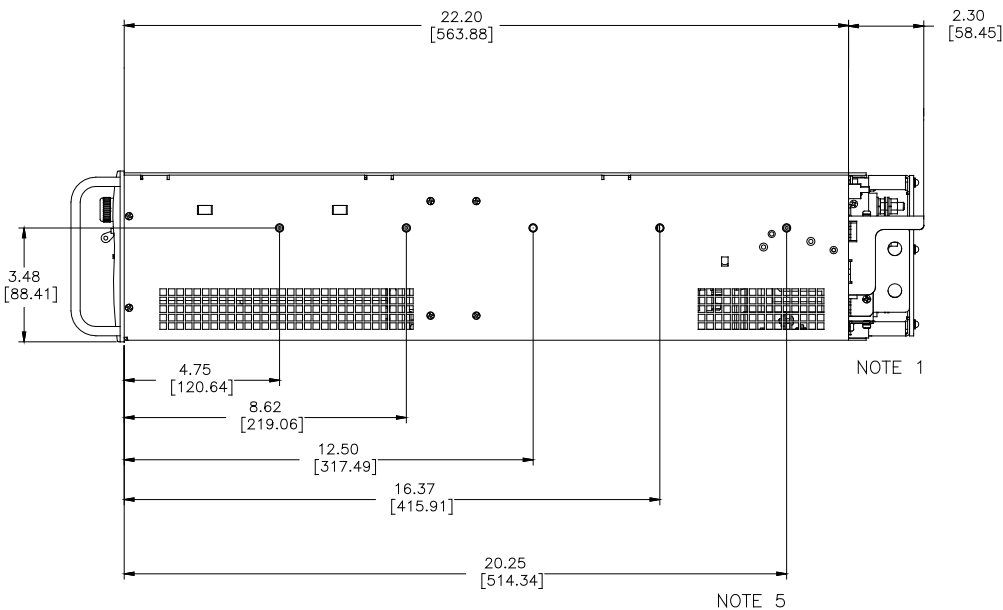
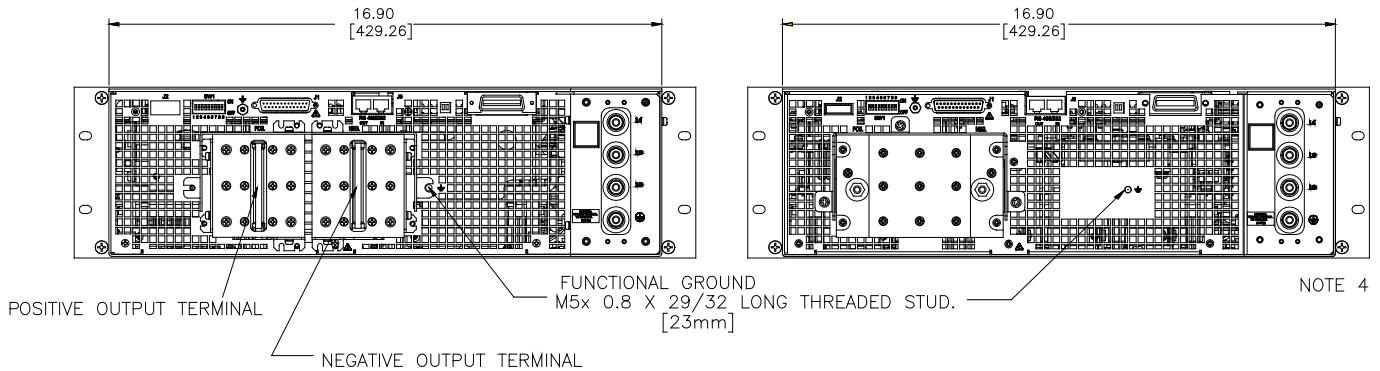
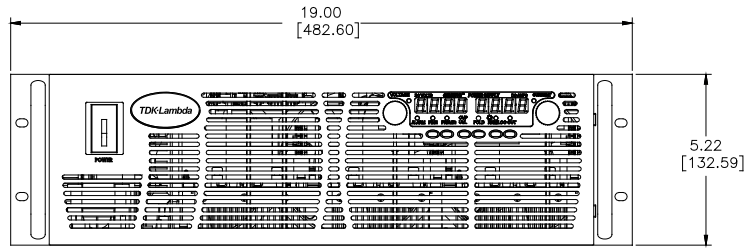

NOTES:

1. Busbars for models up to 30V Output: two holes 0.42" (10.72mm) diameter.
2. Busbars for models 40-300V (10kW) and 60-300V (15kW) Output: one hole 0.42" (10.72mm) diameter.
3. Threaded stud terminal for models above 300V Output.
4. Input Terminals M6 x 1" (3) + Ground M5 x 1" (2).
5. Mounting for Slide Mounts (not included).
Recommend General Devices, Chassis Trak P/N C230-S-122.
Secure with pan head screw M5 x 0.8-8mm long (max).

Outline Drawings: Genesys™ 15kW (30V to 50V - 400VAC/480VAC)

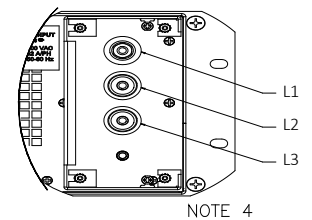
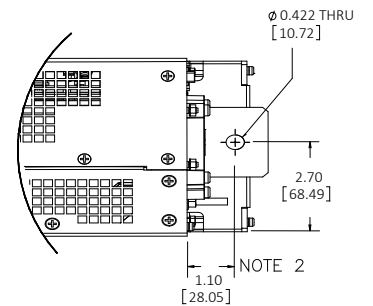
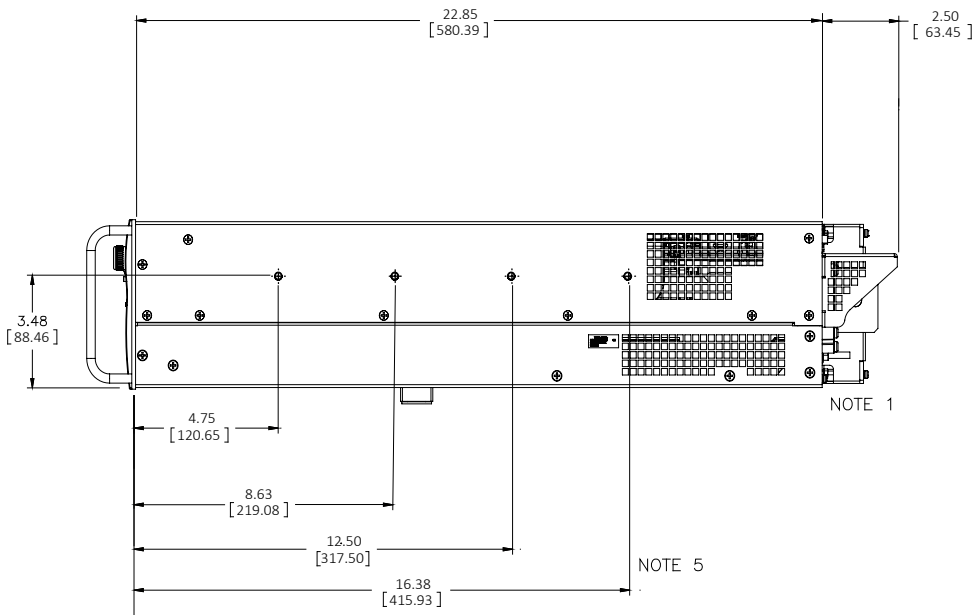
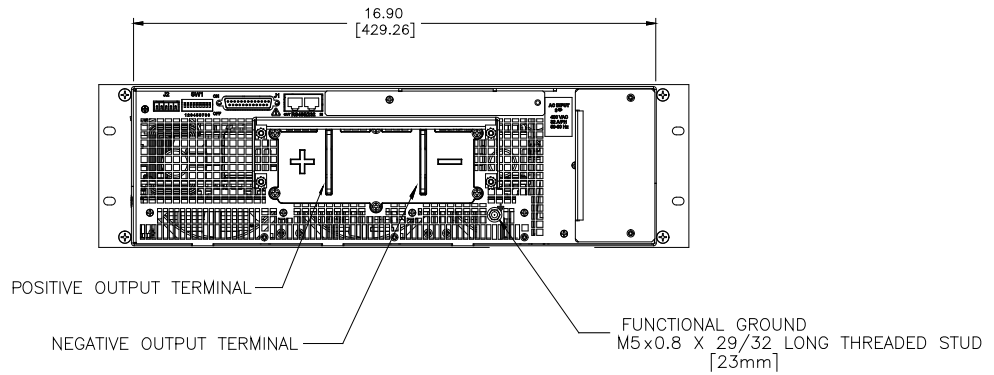
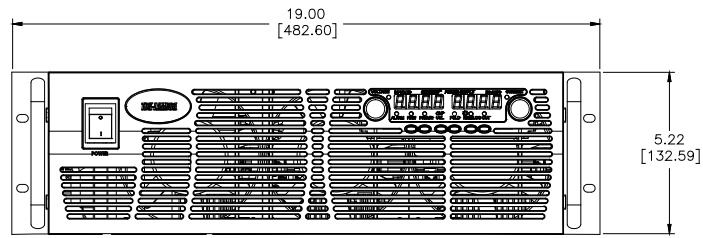

NOTES:

1. N/A
2. Bus bars for models 30-50V Output (15kW): one hole 0.42" (10.72mm) diameter.
3. N/A
4. Input Terminals M6 x 1" (3) + Ground M5 x 1" (2)
5. Mounting for Slide Mounts (not included).
Recommend General Devices, Chassis Trak P/N C230-S-122.
Secure with pan head screw M5 x 0.8-8mm long (max).

Outline Drawings: Genesys™ 15kW (800V to 1500V - 400VAC/480VAC)

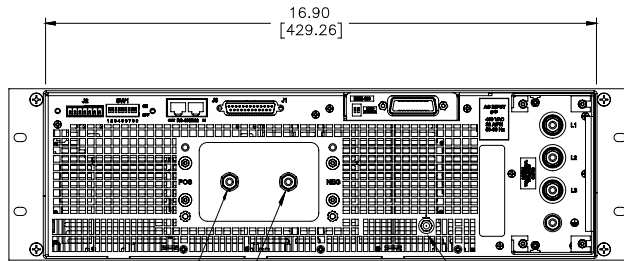
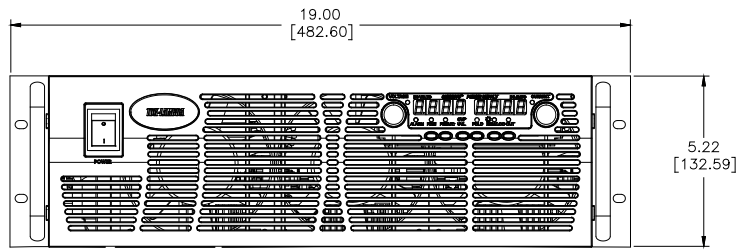

POSITIVE OUTPUT TERMINAL
 NEGATIVE OUTPUT TERMINAL
 FUNCTIONAL GROUND
 M5x0.8 X 29/32 LONG THREADED STUD
 [23mm]

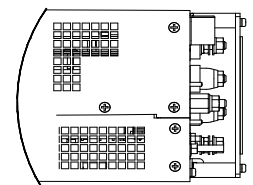
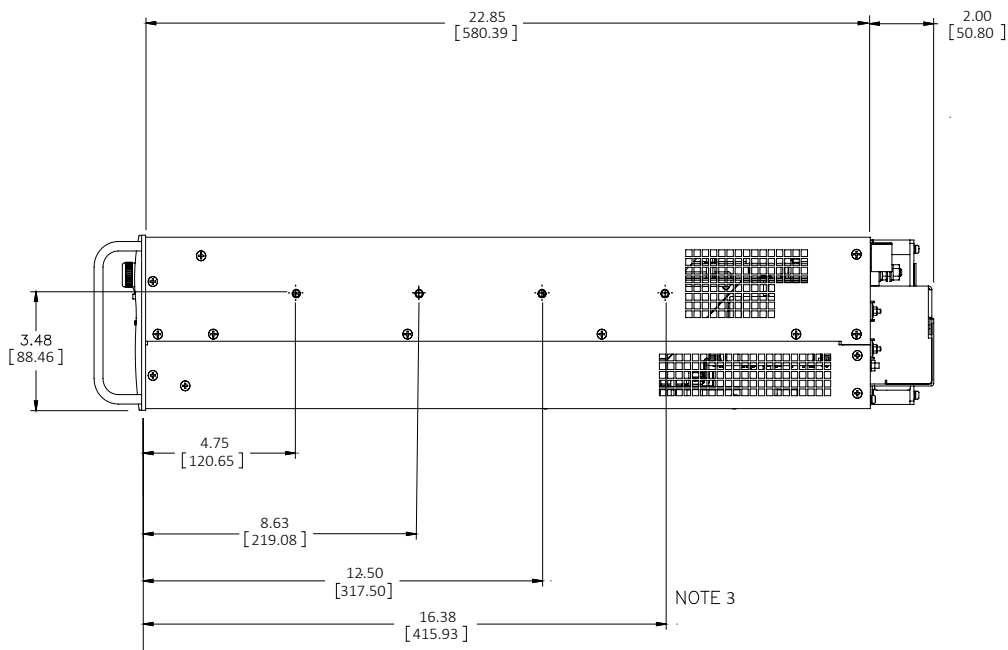

NOTE 1

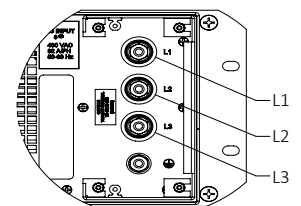

NOTE 2

NOTES:

1. Threaded stud terminals for 800V - 1500V Output; M5 x 1"
2. Input Terminals M6 x 1" (3) + Ground M5 x 1" (2)
3. Mounting for Slide Mounts (not included).
 Recommend General Devices, Chassis Trak P/N C230-S-122.
 Secure with pan head screw M5 x 0.8-8mm long (max).

Power Supply Identification / Accessories (Genesys™ 3U 10/15kW)

How to Order:

GEN **10** - **1000** - **LAN** - **3P208**

Series Name Output Voltage (0~10V) Output Current (0~1000A) Factory Options Option: "-----" AC Input Options

LAN 3P208 (Three-Phase 208VAC)
 IEMD 3P400 (Three-Phase 400VAC)
 IS510 3P480 (Three-Phase 480VAC)
 IS420

Model	Output Voltage (Vdc)	Output Current (A dc)	Output Power (kW)
GEN 7.5-1000	0~7.5	0~1000	7.5
GEN 10-1000	0~10	0~1000	10
GEN 12.5-800	0~12.5	0~800	10
GEN 20-500	0~20	0~500	10
GEN 25-400	0~25	0~400	10
GEN 30-333	0~30	0~333	10
GEN 30-500		0~500	15
GEN 40-250	0~40	0~250	10
GEN 40-375		0~375	15
GEN 50-200	0~50	0~200	10
GEN 50-300		0~300	15
GEN 60-167	0~60	0~167	10
GEN 60-250		0~250	15
GEN 80-125	0~80	0~125	10
GEN 80-187.5		0~187.5	15
GEN 100-100	0~100	0~100	10
GEN 100-150		0~150	15
GEN 125-80	0~125	0~80	10
GEN 125-120		0~120	15
GEN 150-66	0~150	0~66	10
GEN 150-100		0~100	15

Model	Output Voltage (Vdc)	Output Current (A dc)	Output Power (kW)
GEN 200-50	0~200	0~50	10
GEN 200-75		0~75	15
GEN 250-40	0~250	0~40	10
GEN 250-60		0~60	15
GEN 300-33	0~300	0~33	10
GEN 300-50		0~50	15
GEN 400-25	0~400	0~25	10
GEN 400-37.5		0~37.5	15
GEN 500-20	0~500	0~20	10
GEN 500-30		0~30	15
GEN 600-17	0~600	0~17	10
GEN 600-25		0~25	15
GEN 800-12.5	0~800	0~12.5	10
GEN 800-18.8		0~18.8	15
GEN 1000-10	0~1000	0~10	10
GEN 1000-15		0~15	15
GEN 1250-8	0~1250	0~8	10
GEN 1250-12		0~12	15
GEN 1500-6.7	0~1500	0~6.7	10
GEN 1500-10		0~10	15

Factory options

RS-232/RS-485 Multi-Drop Interface (built-in Standard)
 LAN Interface (**LXI** Class C compliant)
 GPIB (Multi-Drop Master) Interface
 Voltage Programming Isolated Analog Interface
 Current Programming Isolated Analog Interface

P/N

"-----"
 LAN
 IEMD
 IS510 (standard on 800-1500V models)
 IS420

Accessories

1. Serial Communication cable

RS-232/RS-485 cable is used to connect the power supply to the Host PC.

Mode	RS-485	RS-232	RS-232
PC Connector	DB-9F	DB-9F	DB-25F
Communication Cable	Shield Ground, L=2m	Shield Ground, L=2m	Shield Ground, L=2m
Power Supply Connector	EIA/TIA-568A (RJ-45)	EIA/TIA-568A (RJ-45)	EIA/TIA-568A (RJ-45)
P/N	GEN/485-9	GEN/232-9	GEN/232-25

2. Serial Link cable*

Daisy-chain up to 31 Genesys™ power supplies.

Mode	Power Supply Connector	Communication Cable	P/N
RS-485	EIA/TIA-568A (RJ-45)	Shield Ground, L=50cm	GEN/RJ45

* Included with GENESYS™-1U, -2U power supply only.

Genesys™ Family - Output Voltage / Output Current

Model	GENH	GEN-1U		GEN-2U		GEN 3U		
Rated Power	750W	750W	1500W	2400W	3300W	5000W	10kW	15kW
Voltage Range	Output Current Range							
0-6V	0-100A	0-100A	0-200A					
0-7.5V							0-1000A	
0-8V	0-90A	0-90A	0-180A	0-300A	0-400A	0-600A		
0-10V				0-240A	0-330A	0-500A	0-1000A	
0-12.5V	0-60A	0-60A	0-120A				0-800A	
0-15V					0-220A			
0-16V				0-150A		0-310A		
0-20V	0-38A	0-38A	0-76A	0-120A	0-165A	0-250A	0-500A	
0-25V							0-400A	
0-30V	0-25A	0-25A	0-50A	0-80A	0-110A	0-170A	0-333A	0-500A ^{(3), (4)}
0-40V	0-19A	0-19A	0-38A	0-60A	0-85A	0-125A	0-250A	0-375A ^{(3), (4)}
0-50V			0-30A				0-200A	0-300A ^{(3), (4)}
0-60V	0-12.5	0-12.5A	0-25A	0-40A	0-55A	0-85A	0-167A	0-250A
0-80V	0-9.5A	0-9.5A	0-19A	0-30A	0-42A	0-65A	0-125A	0-187.5A
0-100V	0-7.5A	0-7.5A	0-15A	0-24A	0-33A	0-50A	0-100A	0-150A
0-125V							0-80A	0-120A
0-150V	0-5A	0-5A	0-10A	0-16A	0-22A	0-34A	0-66A	0-100A
0-200V							0-50A	0-75A
0-250V							0-40A	0-60A
0-300V	0-2.5A	0-2.5A	0-5A	0-8A	0-11A	0-17A	0-33A	0-50A
0-400V							0-25A	0-37.5A
0-500V							0-20A	0-30A
0-600V	0-1.3A	0-1.3A	0-2.6A	0-4A	0-5.5A	0-8.5A	0-17A	0-25A
0-800V							0-12.5A	*0-18.8A ^{(3), (4)}
0-1000V							0-10A	*0-15A ^{(3), (4)}
0-1250V							0-8A	*0-12A ^{(3), (4)}
0-1500V							0-6.7A	*0-10A ^{(3), (4)}
Weight (kg/lb)	4.5 / 9.9	7.0 / 15.0	8.5 / 18.0	10.0 / 22.0	13.0 / 29.0	16.0 / 35.0	43.0 / 97.0	43.0 / 97.0 *32.0 / 70.0

(4) Available in 400VAC and 480VAC input. For 208VAC input please contact the factory.

AC Inputs

85-265Vac, 1Ø	• (1)	• (1)	• (1)					
230Vac, 1Ø				• (1)	• (1)			
208Vac, 3Ø				• (1)	• (1)	• (1)	• (2)	• (2)
400Vac, 3Ø					• (1)	• (1)	• (2)	• (2)
480Vac, 3Ø							• (3)	• (3)

(1) UL Listed; CE Mark , **RoHS** (2) UL Recognized; CE Mark (3) UL Recognized only (CE Mark for select 10kW (800V-1500V) and 15kW (30V-50V and 800V-1500V) models.

Options (All Models)

“-----”	Standard (with Multi-Drop Slave installed)
LAN	LXI Compliant LAN Interface (Class C)
IEMD	IEEE Master (IEEE 488.2 & SCPI compliant) with Multi-Drop Slave installed
IS510	Isolated Analog Programming (0-5V or 0-10V, User-selectable); standard on 800-1500V Outputs
IS420	Isolated Analog Programming (4-20mA)

(All options are factory installed and limited to one per power supply).
All specifications subject to change without notice.

USA

TDK-Lambda Americas Inc.
405 Essex Rd. Neptune, NJ 07753
Tel: +1-732-922-9300 Fax: +1-732-922-1441
E-mail: sales@us.tdk-lambda.com
www.us.tdk-lambda.com/hp

CANADA

ACA TMetrix
5805 Kennedy Road, Mississauga, Ontario, L4Z 2G3
Tel: +1-800-665-7301 Fax: +1-905-890-1959
Email: lambda@aca.ca
Web: tmetrix.com

MEXICO

AcMax de Mexico
39 Poniente 3515 Piso 5 Col. Las Animas
Puebla, Pue. C.P. 72400
Tel: 01-800-211-0060 / (222) 891-8484 Fax: 222-264-1445
Email: info@acmax.mx, Web: www.acmax.mx

BRAZIL

Suplitech
Rua Sena Madureira 455, Belo Hte - 31340-000
Tel: +55-31-3498 1177 Fax: +55-31-3441 0841
Email: vendas@suplitech.com.br, Web: www.suplitech.com.br

UK

TDK-Lambda UK
Kingsley Avenue
Ilfracombe, Devon EX 34 8ES
Tel: +44-1271-856666 Fax: +44-1271-864894
E-mail: powersolutions@uk.tdk-lambda.com
Web: www.uk.tdk-lambda.com

IRELAND

FRANCE

TDK-Lambda France
ZAC des Delaches, CS 41077
9 rue Thuillere, 91978 Villebon Courtaboeuf
Tel: +33 1 60 12 71 65 Fax: +33 1 60 12 71 66
Email: france@fr.tdk-lambda.com, Web: www.fr.tdk-lambda.com

NETHERLANDS

SPAIN

GERMANY

TDK-Lambda Germany
Karl-Bold-Str.40, D-77855 Achern
Tel: +49-7841-666-0 Fax: +49-7841-500-0
E-mail: info@de.tdk-lambda.com,
Web: www.de.tdk-lambda.com

AUSTRIA

SWITZERLAND

ITALY

TDK-Lambda Italy
Via dei Lavoratori 128/130
IT 20092 Cinisello Balsamo (MI)
Tel: +39-02-6129-3863 Fax: +39-02-6129-0900
E-mail: info.italia@it.tdk-lambda.com
Web: www.it.tdk-lambda.com

SCANDINAVIA

BALTICS

TDK-Lambda Germany
Karl-Bold-Str.40, D-77855 Achern
Tel: +49-7841-666-0 Fax: +49-7841-500-0
E-mail: info@de.tdk-lambda.com
Web: www.de.tdk-lambda.com

JAPAN

TDK-Lambda Corporation
International Sales Division,
3-9-1, Shibaura, Minato-ku,
Tokyo 108-0023
Tel: +81 3-6852-7136 Fax: +81 3-6852-7148
E-mail: momata@jp.tdk-lambda.com
Web: www.jp.tdk-lambda.com

CHINA

TDK-Lambda Shanghai Office
28F, Xingyuan Technology Building No.418, Guiping Road,
Shanghai, 200233 P.R. CHINA
Tel: +86-21-6485-0777 Fax: +86-21-6485-0666
E-mail:sales-sh@cn.tdk-lambda.com, Web: www.cn.tdk-lambda.com

TDK-Lambda Beijing Office
Room 12B11-12B12, Unit 7 DACHENG SQUARE,
No.28 Xuanwumenxi Street, Xuanwu District Beijing,
100053, P.R. CHINA
Tel: +86-10-6310-4872 Fax: +86-10-6310-4874
E-mail:sales-bj@cn.tdk-lambda.com, Web: www.cn.tdk-lambda.com

TDK-Lambda Hong Kong Office
1 / F. SAE Technology Centre, 6 science Park East Avenue,
HongKong Science Park, Shatin, NT.,
Tel: +852-23766658 Fax: +852-23172150
E-mail:sales-hk@hk.tdk-lambda.com, Web: www.cn.tdk-lambda.com

KOREA

TDK-Lambda Corporation
(Seocho-Dong, 8F. Songnam Bldg.) 273, Gangnam-Daero,
Seocho-Gu, Seoul 137-862, Republic of Korea 137-862
Tel: 82-2-3473-7051~4, Fax: 82-2-3472-9137
Email: BS.Bang@kr.tdk-lambda.com, Web: www.tdk-lambda.co.kr

MALAYSIA

TDK-Lambda Malaysia
Lot 709, Nilai Industrial Estate
71800 Nilai, Negeri Sembilan
Tel: +60-6-799-1130 Fax: +60-6-799-3277
www.my.tdk-lambda.com

SINGAPORE

PHILIPPINES

THAILAND

TDK-Lambda Singapore
1008 Toa Payoh North # 06-01/08
Singapore 318996
Tel: +65-6251-7211 Fax: +65-6250-9171
Email: anthony.lau@sg.tdk-lambda.com, Web: www.sg.tdk-lambda.com

INDIA

TDK-Lambda India
No.989, 1st Cross, 2nd Floor, 13th Main,
HAL 2nd Stage, Bangalore, Karnataka, India – 560 008
Tel: +91-80-43550500, Fax: +91-80-43550501
Email: mathew.philip@in.tdk-lambda.com, Web: www.in.tdk-lambda.com

ISRAEL

RUSSIA

Kibbutz Givat Hashlosha Tel-Aviv 48800
Tel: +972-3-9024-333 Fax: +972-3-9024-777
E-mail: info@tdk-lambda.co.il
Web: www.tdk-lambda.co.il



TDK-Lambda Americas Inc. 405 Essex Road, Neptune, NJ 07753 USA
Tel: +1 732 922 9300 Fax: +1 732 922 1441
www.us.tdk-lambda.com/hp