

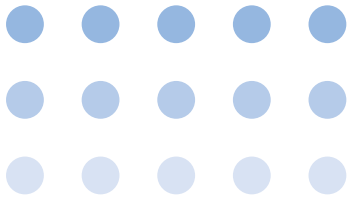

**Advanced Test Equipment Rentals**  
**www.atecorp.com 800-404-ATEC (2832)**



## **OPERATION MANUAL**

---

**EARTH CONTINUITY TESTER**

# **TOS6200**

# **TOS6210**

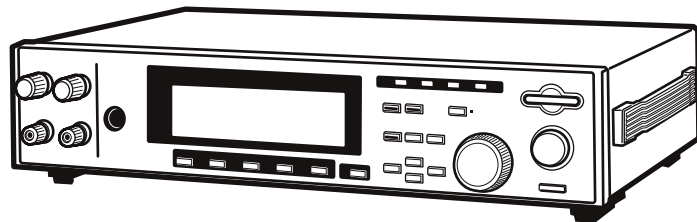

## Use of Operation Manual

Please read through and understand this Operation Manual before operating the product. After reading, always keep the manual nearby so that you may refer to it as needed. When moving the product to another location, be sure to bring the manual as well.

If you find any incorrectly arranged or missing pages in this manual, they will be replaced. If the manual gets lost or soiled, a new copy can be provided for a fee. In either case, please contact Kikusui distributor/agent, and provide the "Part No." given on the cover.

This manual has been prepared with the utmost care; however, if you have any questions, or note any errors or omissions, please contact Kikusui distributor/agent.

## Disposing of used Kikusui products in the EU

Under a law adopted by member nations of the European Union (EU), used electric and electronic products carrying the symbol below must be disposed of separately from general household waste.

This includes the power cords and other accessories bundled with the products. When disposing of a product subject to these regulations, please follow the guidance of your local authority, or inquire with your Kikusui distributor/agent where you purchased the product.

The symbol applies only to EU member nations.



## Disposal outside the EU

When disposing of an electric or electronic product in a country that is not an EU member, please contact your local authority and ask for the correct method of disposal.

Microsoft and Windows are registered trademarks of Microsoft Corp., U.S.A.











Trade names, product names, and company names occurring in this manual are trademarks or registered trademarks of their respective holders.

The contents of this Operation Manual may not be reproduced, in whole or in part, without the prior consent of the copyright holder.

The specifications of this product and the contents of this Operation Manual are subject to change without prior notice.

## Safety Symbols

For the safe use and safe maintenance of this product, the following symbols are used throughout this manual and on the product. Understand the meanings of the symbols and observe the instructions they indicate (the choice of symbols used depends on the products).

	<p>Indicates that a high voltage (over 1000 V) is used here. Touching the part causes a possibly fatal electric shock. If physical contact is required by your work, start work only after you make sure that no voltage is output here.</p>
<p><b>DANGER</b></p>	<p>Indicates an imminently hazardous situation which, if ignored, will result in death or serious injury.</p>
	<p>Indicates a potentially hazardous situation which, if ignored, could result in death or serious injury.</p>
	<p>Indicates a potentially hazardous situation which, if ignored, may result in damage to the product and other property.</p>
	<p>Shows that the act indicated is prohibited.</p>
	<p>Is placed before the sign “DANGER,” “WARNING,” or “CAUTION” to emphasize these. When this symbol is marked on the product, see the relevant sections in this manual.</p>
	<p>Protective conductor terminal.</p>
	<p>Chassis (frame) terminal.</p>
	<p>On (supply)</p>
	<p>Off (supply)</p>
	<p>In position of a bi-stable push control</p>
	<p>Out position of a bi-stable push control</p>



# Safety Precautions

The following safety precautions must be observed to avoid fire hazard, electrical shock, accidents, and other failures. Keep them in mind and make sure that all of them are observed properly.

Use of the product in a method not specified in this manual may impair the protection functions of the product.



## Users

- This product must be used only by qualified personnel who understand the contents of this operation manual.
- If it is handled by disqualified personnel, personal injury may result. Be sure to handle it under supervision of qualified personnel (those who have electrical knowledge.)

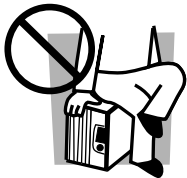

## Purposes of use

- Do not use the product for purposes other than those described in the operation manual.
- This product is not designed or manufactured for household use or for general consumers.

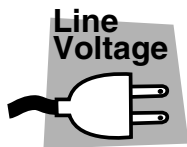

## Input power

- Always connect the product to an electrical outlet meeting the input rating of the product.
- For applying power, use the AC power cord provided.
- The product is designed as equipment of Overvoltage Category II in the IEC Standards (energy-consuming equipment to be supplied from fixed installation).



## Fuse

- The fuse can be replaced with a new one. When replacing a fuse, use the one which has appropriate shape, ratings, and specifications.

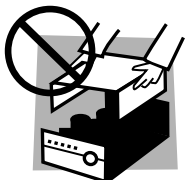

## Cover

- There are parts inside the product which may cause physical hazards. Do not remove the external cover.

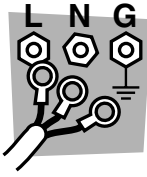

## Grounding

- The product is equipment of Safety Class I of the IEC Standards (equipment with a protective conductor terminal). To avoid electrical shock, connect the protective conductor terminal to electrical ground (safety ground).



## Installation

- The product is designed to be safe when used indoors. Be sure to use it indoors only.
- When installing products be sure to observe 2.2, "Precautions for Installation" described in this manual.



## Relocation

- Turn off the power switch and then disconnect all cables when relocating the product.
- Be sure the operation manual be included when the product is relocated.



## Operation

- Check that the AC input voltage setting and the fuse rating are satisfied and that there is no abnormality on the surface of the power cord. Be sure to unplug the power cord before checking.
- If any abnormality or failure is detected in the products, stop using it immediately. Unplug the power cord or disconnect the power cord from the switchboard. Be careful not to allow the product to be used before it is completely repaired.
- For output wiring, use connection cables with larger current capacity.
- Do not disassemble. If it must be modified, contact Kikusui distributor/agent.



## Maintenance and checking

- To avoid electrical shock, be absolutely sure to unplug the power cord before performing maintenance or checking.
- Do not remove the cover when performing maintenance or checking.
- To maintain performance and safe operation of the product, it is recommended that periodic maintenance, checking, cleaning, and calibration be performed.



## Service

- Internal service is to be done by Kikusui service engineers. If the product must be adjusted or repaired, contact Kikusui distributor/agent.

# Contents

Safety Symbols	I
Safety Precautions	II
<b>Chapter 1 General</b>	<b>1-1</b>
1.1 Overview of the Manual	1-2
1.2 Introduction and Features	1-2
1.3 Options	1-5
<b>Chapter 2 Installation and Preparation for Use</b>	<b>2-1</b>
2.1 Unpacking Checks	2-2
2.2 Precautions for Installation	2-3
2.3 Precautions for Moving	2-4
2.4 Checking the Line Voltage	2-5
2.5 Connecting the AC Power Cord	2-6
2.6 Grounding	2-7
2.7 Connecting the Test Leads	2-8
2.7.1 Supplied Test Lead TL11-TOS/TL12-TOS	2-8
2.7.2 Optional Test Probe LP01-TOS/LP02-TOS	2-10
2.7.3 Other Leads	2-11
2.7.4 Measurements Using Four Terminals	2-12
2.7.5 Measurements Using Two Terminals	2-12
2.7.6 Connecting to the DUT	2-13
2.8 Preliminary Inspection	2-14
<b>Chapter 3 Part Names and Functions</b>	<b>3-1</b>
3.1 Front Panel	3-2
3.2 Rear Panel	3-6
<b>Chapter 4 Basic Operation</b>	<b>4-1</b>
4.1 Turning on the power	4-2
4.2 Setting the Test Conditions	4-3
4.2.1 Test Current	4-4
4.2.2 Test Frequency	4-5
4.2.3 Upper Reference Value	4-5
4.2.4 Lower Reference Value	4-8
4.2.5 Test Time	4-10
4.2.6 Offset Canceling Function	4-11
4.3 Starting and Ending Test	4-13
4.3.1 Starting a Test	4-13
4.3.2 Ending the Test	4-14
4.4 System Setup	4-16
4.5 Interface Setup	4-20

4.5.1	GPIB Address	4-20
4.5.2	RS-232C Protocol	4-21
4.6	Panel Memory	4-22
4.6.1	Storing in the Panel Memory	4-22
4.6.2	Recalling the Panel Memory	4-23
4.7	Program	4-24
4.7.1	Recalling the Program	4-25
4.7.2	Creating or Editing the Program	4-25
4.7.3	Running the Program	4-27
4.7.4	Suspending the Program	4-27
4.7.5	PASS/FAIL Judgment During Program Execution	4-27
4.7.6	Ending the Program	4-27
4.8	Key Lock	4-28
4.9	Checking the Test Conditions	4-28
4.9.1	Setting Output out of the Operation Range	4-28
4.9.2	Upper Reference Value $\leq$ Lower Reference Value (UP $\leq$ LOW)	4-30
4.10	Protection Function	4-31
4.10.1	Time Limitation with Respect to Output (OVER HEAT)	4-31
4.10.2	Overheating Protection (OVER HEAT)	4-32
4.10.3	Overload Protection (OVER LOAD)	4-32
4.10.4	Output Voltage Limitation (VOLT LIMIT)	4-33
4.10.5	Change in ENABLE Signal (SIGNAL I/O)	4-33
4.11	Initialize	4-34
<b>Chapter 5 REMOTE and SIGNAL I/O</b>		<b>5-1</b>
5.1	REMOTE Terminal	5-2
5.2	SIGNAL I/O Connector	5-3
5.2.1	SIGNAL I/O Connector Specifications	5-4
5.2.2	Starting a Test	5-6
5.2.3	Recalling a Panel Memory and Program	5-7
5.2.4	Examples of Use	5-8
<b>Chapter 6 GPIB and RS-232C</b>		<b>6-1</b>
6.1	Interface	6-2
6.1.1	GPIB Interface	6-2
6.1.2	RS-232C Interface	6-2
6.2	Message and Terminator	6-4
6.2.1	Messages	6-4
6.2.2	Terminator	6-6
6.2.3	Special Symbols and Characters	6-6
6.3	Device Messages	6-7
6.3.1	Register-Related and General-Purpose Messages	6-7
6.3.2	System-Related Messages	6-13
6.3.3	Messages Relating to Test Conditions and Test Execution	6-18

6.3.4	Messages Relating to the Tester Status	6-26
6.3.5	Memory-Related Messages	6-29
6.3.6	Program-Related Messages	6-32
6.4	Registers	6-36
6.5	List of Device Messages	6-40
6.6	Example Programs	6-45
<b>Chapter 7 Maintenance</b>		<b>7-1</b>
7.1	Cleaning	7-2
7.2	Inspection	7-2
7.3	Checking and Replacing the Fuse	7-3
7.4	Replacing the Cooling Fan and Backup Battery	7-4
7.5	Calibration	7-4
7.6	In Case of Problems	7-5
<b>Chapter 8 Specifications</b>		<b>8-1</b>
8.1	Basic Performance	8-2
8.2	Interface and Other Functions	8-4
8.3	General Specifications	8-6
8.4	External Dimensions	8-8
<b>Appendix</b>		<b>A-1</b>
A.1	Operational Principle	A-1
A.2	ASCII Codes 20H to 7EH	A-2
A.3	Initial Settings of the Memory	A-3
A.4	Summary of the Safety Standards for Earth Continuity Testing	A-4
<b>Index</b>		<b>I- 1</b>



# 1

## Chapter 1 General

Gives an overview of the tester and describes its features and various options.

## 1.1 Overview of the Manual

This operation manual is for the TOS6200/6210 earth continuity tester.

### ■ Firmware version of products applied

This Operation Manual applies to products with version 1.0x firmware installed.

The ROM version number is displayed in the opening screen displayed immediately after power is switched ON. You can also obtain the ROM version number with the \*IDN? message. For information on the \*IDN? message, see 6.3.1, "Register-Related and General-Purpose Messages."

Before making product inquiries, please have ready the tester ROM version number and serial number indicated on the rear panel of your tester.

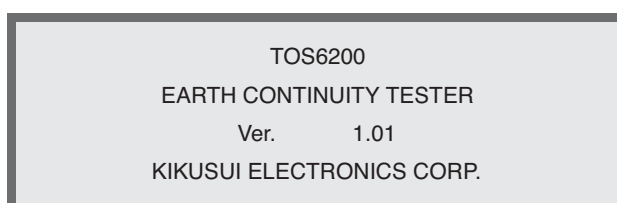

Fig.1-1 Opening screen for firmware version 1.01 (Example of TOS6200)

## 1.2 Introduction and Features

This tester is used to perform earth continuity tests required for class-I devices for various safety standards, including the IEC, EN, UL, VDE, BS, JIS, and the Electrical Appliance and Material Control Law of Japan.

The tester must be used under the following conditions:

	TOS6200	TOS6210
Test current value	3A to 30 A AC	6A to 60 A AC
Output terminal voltage	5.4 V or less	
Resistance value	1.2 $\Omega$ or less	0.6 $\Omega$ or less
Maximum power	150 VA or less	220 VA or less

### 1. Making test current constant

The test current for earth continuity tests has been made constant. This eliminates the need to alter the test current, even if the resistance of the DUT (device under test) changes.

### 2. Safety output voltage

The constant current/constant voltage circuit provides fast response, preventing generation of excessive output voltage even when output is interrupted during testing. The tester complies with the limitations on no-load output voltages (6 V or less,

12 V or less, and so on) required by many safety standards.

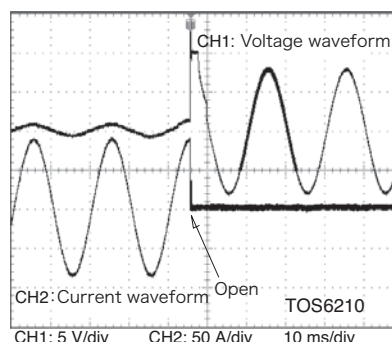
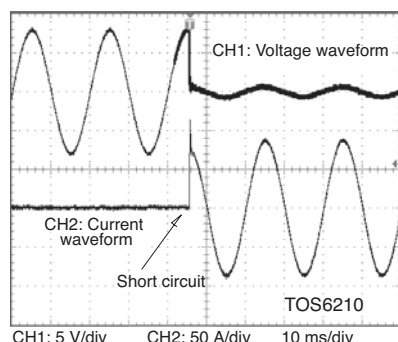

### 3. Reduced cycle time

A test current is a constant current value set within approximately 100 ms.

Earth continuity tests can be conducted even at 1-second intervals. This enables the instrument to perform tests in production lines that require reduced cycle times.

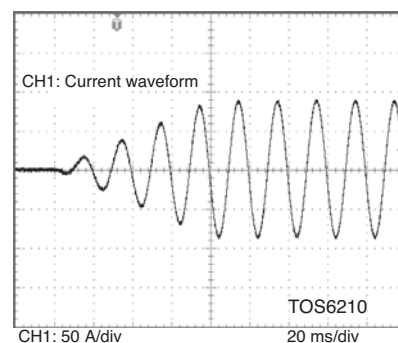

### 4. Compact and lightweight

A new high-efficiency power supply (achieving a power conversion efficiency of 65%) and large output (TOS6200: 150 VA, TOS6210: 220 VA) makes possible a tester that is remarkably compact and lightweight, about half the size and weight of our conventional testers.

### 5. Excellent measurement accuracy

The tester is equipped with an ohmmeter of  $\pm(2\% \text{ of reading} + 0.003 \Omega)$  that calculates resistance values based on measured current and voltage.

### 6. Offset canceling function

The tester has an offset canceling function that cancels values for contact resistance at alligator clip connections, the contact resistance of measuring leads in measurements using two terminals, and other resistance components.

## **7. Contact check function**

The tester is provided with a contact check function that verifies the connection of the DUT (by current detection) before initiating testing.

## **8. Voltage judgment function (TOS6210 only)**

This function allows either a resistance value or a voltage drop value (voltage between the SAMPLING terminals) to be selected as the reference value for judgment criteria.

It also allows voltage drop value-based testing to be conducted, which is required by safety standards such as UL 60950-1 and IEC 60950-1.

## **9. Simple operations**

Tester functions are fast and easily controlled, with an intuitive control method that's easy to pick up, even for first-time users.

For example, test conditions are set simply by selecting an item displayed on the LCD with the cursor keys and turning the rotary knob to set/select a value.

Any items you wish to set up can be assigned to the function keys.

## **10. Stores up to 100 types of test conditions**

The tester allows you to store and name up to 100 test conditions involving parameters such as test current, determined resistance value, and test time. For example, you can store test conditions for a specific safety standard under the name of the standard, or store test conditions under the name of the destination of the DUT.

When test conditions need to be modified due to changes in the destination of the product or revised safety standards, you can recall a set of test conditions simply by entering a memory number, making necessary modifications to the pre-existing standard.

Assigning specific names allows test conditions to be called up by name. This function is available through both the front panel and the remote control.

## **11. Programming of test conditions**

A combination of stored test conditions allows automatic execution of tests consisting of several programs of up to 100 steps each.

Although the total number of steps is limited to 500, 100 types of programs can be stored and recalled from the front panel or the remote control.

## **12. GPIB and RS-232C interfaces**

The tester is provided with standard GPIB and RS-232C interfaces. It is therefore not necessary to buy additional GPIB and RS-232C boards.

An interface cable and PC or sequencer allows remote control of test conditions such as test current, determined resistance value, and testing time. Measured values and test results can also be read back.

## **13. Supplied test leads**

The tester comes with alligator clip test leads, letting you start testing immediately.

## **14. Memo function**

The tester has a memo function that can store up to 20 characters per line on 3 lines, which can be used to store serial numbers, calibration dates, and/or comments.

## 1.3 Options

The following options are available for the tester.

### ■ RC01-TOS/RC02-TOS Remote Control Box

When connected to the REMOTE terminal on the front panel, remote control boxes are used to control tester start/stop functions.

The RC01-TOS has one START switch, while the RC02-TOS has two START switches. For the RC02-TOS, a test starts only when both switches are pressed simultaneously.

#### Functions

##### OPERATE switch

Test switches are enabled only when this switch is set to the ON position.

When it is set to the OFF position, a test in progress will be stopped.

##### START switch

With the OPERATE switch set to ON and the tester in ready status, press this switch to start testing.

##### STOP switch

Used to shut off output voltage or cancel a FAIL status; has the same function as the STOP switch located on the tester.

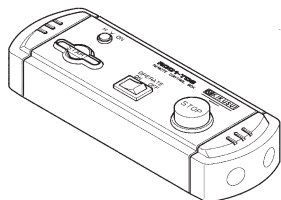

RC01-TOS:  
200mm(W) x 70mm(H) x 39mm(D)

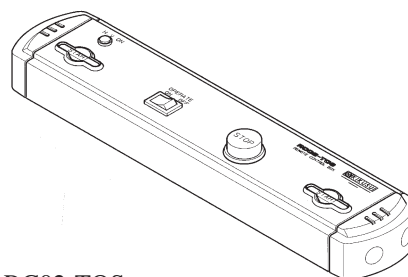

RC02-TOS:  
330mm(W) x 70mm(H) x 39mm(D)

## ■ LP01-TOS/LP02-TOS Test Probe

This probe lets you use the switches located on the probe to control tester starting test/stopping test operations. Connect it to the OUTPUT and REMOTE terminals on the tester's front panel.

Maximum rating: LP01-TOS 30 A  
LP02-TOS 60 A

Cable length: 2 m

Accessory: LOW Test Lead (LP01-TOS/LP02-TOS) 2 m

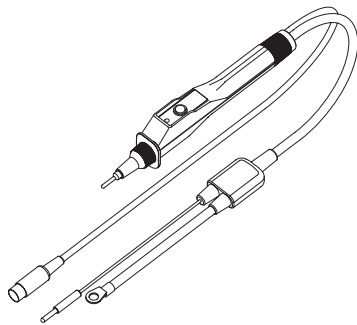

LP01-TOS:  
28 mm(W) x 45.5 mm(H) x 226 mm(D)

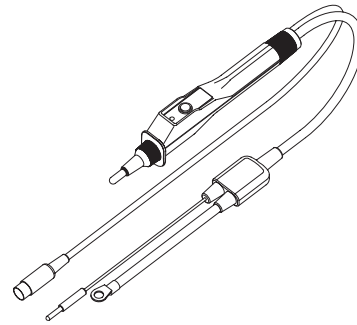

LP02-TOS:  
28 mm(W) x 45.5 mm(H) x 226 mm(D)

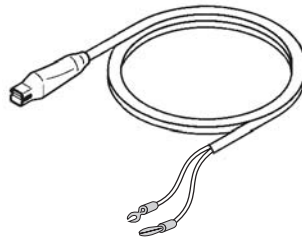

LOW Test Lead

# 2

## **Chapter 2 Installation and Preparation for Use**

Describes the steps from unpacking to installation to preparation required before switching on POWER.

## 2.1 Unpacking Checks

Upon receiving the product, make sure the package contains the necessary accessories, and that the product has not been damaged during transportation.

If any damage or imperfection is found, contact Kikusui distributor/agent.

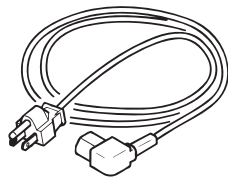

or

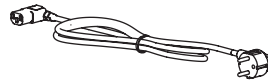

or

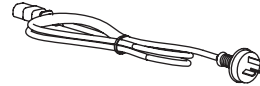

PLUG: NEMA5-15  
[85-AA-0003]

PLUG: CEE7/7  
[85-10-0840]

PLUG: GB1002  
[85-10-0790]

AC power cord, 1

The power cord that is provided varies depending on the destination for the product at the factory-shipment.

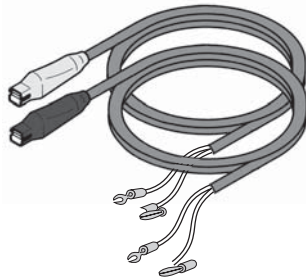

Test leads, 1 set  
TOS6200: TL11-TOS 1.5 m  
TOS6210: TL12-TOS 1.5 m



Spare fuse, 1  
6.3A 250V  
[99-02-0019]

Inserted in the  
AC LINE connector

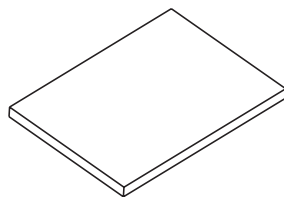

Operating Manual, 1  
[Z1-003-302]

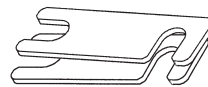

Short-circuit bars, 2  
[E3-300-032]

Installed between  
the OUTPUT and  
SAMPLING terminals

Fig.2-1 List of Accessories

SIGNAL I/O, GPIB interface, and RS-232C interface cables are not supplied with the product and must be purchased separately.

For information on connecting those cables, see 5.2, "SIGNAL I/O Connector" and Chapter 6, "GPIB and RS-232C."

**NOTE**

- Packing materials may be used for later transport of the product, so it is recommended that they be retained.



## 2.2 Precautions for Installation

The product should be installed indoors, observing the following precautions.

### Precautions for installation location

#### ■ Do not use the product in a flammable atmosphere.

To prevent explosion or fire, do not use the product near alcohol, thinner, or other combustible materials, or in an atmosphere containing such vapors.

#### ■ Avoid locations where the product is exposed to high temperatures or direct sunlight.

Do not locate the product near a heater or in areas subject to drastic temperature changes.

Operating temperature range: 5°C to 35°C (41 °F to 95 °F )

Storage temperature range: -20°C to +70°C (-4 °F to +158 °F)

#### ■ Avoid humid environments.

Do not locate the product in a high-humidity environment - near a boiler, humidifier, or water supply.

Operating humidity range: 20% to 80% R.H (no dew condensation is allowed)

Storage humidity range: 90% R.H or less (no dew condensation is allowed)

Condensation may occur even within the operating humidity range. In that case, do not start using the product until condensation dries up completely.

#### ■ Do not place the product in a corrosive atmosphere.

Do not locate the product in a corrosive atmosphere or one containing sulfuric acid mist or the like. This may cause corrosion of various conductors and imperfect contact with connectors, leading to malfunction and failure, or in the worst case, a fire.

#### ■ Do not locate the product in a dusty environment.

Dirt and dust in the product may cause electrical shock or fire.

#### ■ Do not use the product where ventilation is poor.

The product employs a forced-air cooling system. Provide sufficient space around the product so that air is able to flow through the intake ports on the sides and the exhaust port at the rear.

#### ■ Do not place any object on the product.

Particularly a heavy one, as doing so could result in a malfunction.

#### ■ Do not place the product on a tilted surface or in a location subject to vibrations.

The product may fall or tip over causing damages and injuries.

---

- **Do not use the product in locations affected by strong magnetic or electric fields.**

Operation in a location subject to magnetic or electric fields may cause the product to malfunction, resulting in electrical shock or fire.

- **Secure adequate space around the power plug.**

Do not insert the power plug to an outlet where accessibility to the plug is poor. And, do not place objects near the outlet that would result in poor accessibility to the plug.

## Use of the feet

Used to raise the front panel of the meter to get a better view of the LCD screen or improve the operability of the keys.

Pull the provided feet forward onto the floor until you hear them click.

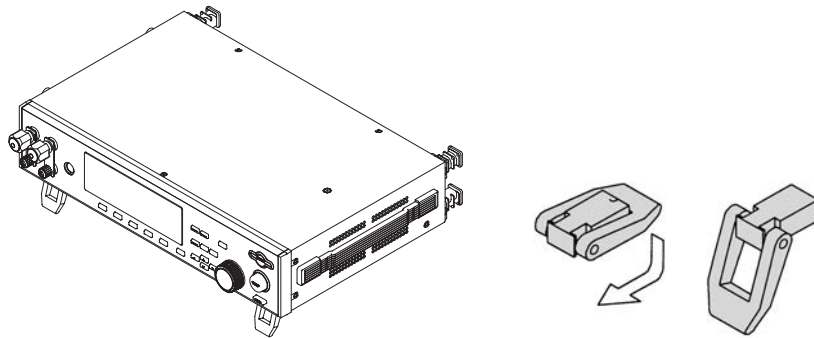

Fig. 2-2 How to use the feet

---

**CAUTION** • Do not use the rubber strips on the sides as feet. Use of the product in an upright position with a rubber strip at the bottom may cause the product to fall down, resulting in damage to the tester or injury to the user.

---

## 2.3 Precautions for Moving

When moving or transporting the product to an installation site, observe the following precautions.

- **Turn the POWER switch off.**

Moving the product with the power on may result in electrical shock or damage.

- **Remove all wirings connected.**

Moving the product with cables connected may break the cables or cause the product to fall, resulting in injury.

■ **For transportation, use the special packing material for the product.**

Transport the product in its original package to prevent vibration and falls, which may damage the product.

## 2.4 Checking the Line Voltage

The product is designed as equipment of Overvoltage Category II in the IEC Standards (energy-consuming equipment to be supplied from fixed installation).

Before connecting the AC power cord, check the tester's line voltage.

Its input rating is indicated on the rear panel.

- 
- ⚠ CAUTION** • Using the tester outside the permitted range will result in erratic function or failure. Operate the product with the supply voltage within the voltage range required.
- 

### TOS6200

LINE VOLTAGE RANGE		FREQUENCY RANGE	FUSE (250V)		VA MAX
			UL198G	IEC60127	
●	85-132V	47-63Hz	6.3A SLOW	6.3A (T)	450
	170-250V				330

The ● symbol indicates the allowable line voltage range. If this symbol is placed by both line voltage ranges, the tester may be used at either line voltage.

The line voltage range for the table above is as follows:

Allowable line voltage range: 85 V to 132 V AC

Allowable frequency range: 47 to 63 Hz

### TOS6210

LINE VOLTAGE RANGE		FREQUENCY RANGE	FUSE (250V)		VA MAX
			UL198G	IEC60127	
85-250V		47-63Hz	6.3A SLOW	6.3A (T)	420

## 2.5 Connecting the AC Power Cord

The power cord that is provided varies depending on the destination for the product at the factory-shipment.

- 
- ⚠ WARNING**
- The AC power cord for 100 V system shown in Fig. 2-3 has a rated voltage of 125 VAC. If this AC power cord is used at the line voltage of a 200 V system, replace the AC power cord with that satisfying that line voltage. An appropriate AC power cord must be selected by qualified personnel. If it is difficult to obtain the AC power cord, consult your Kikusui distributor/agent.
- 

- NOTE**
- The AC power cord incorporates a disconnecting device capable of isolating the product from the AC power line should such become necessary. Connect it to an easily accessible electrical outlet.
  - Do not use the AC power cord provided with the product as a AC power cord for other instruments.
- 

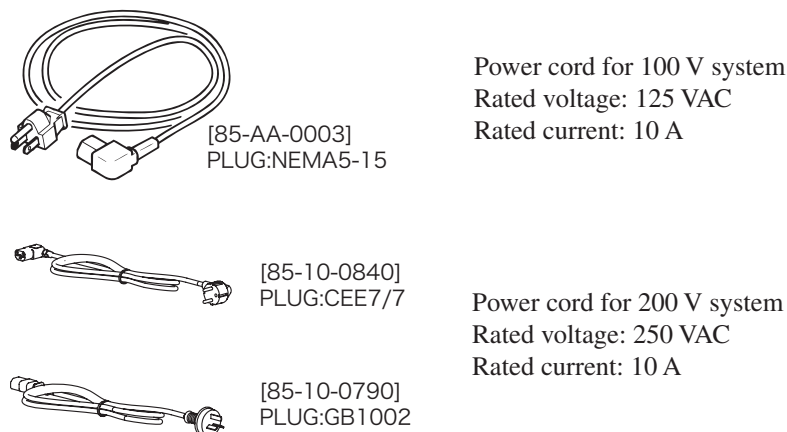

Fig. 2-3 AC power cord

### Procedure

1. Check that the power supply falls within the input line voltage range indicated on the tester.
2. Check that the POWER switch of the tester is set to OFF.
3. Connect the AC power cord to the AC LINE connector on the rear panel of the tester.  
Use the provided power code or power code that is selected by qualified personnel.
4. Connect the other end of the AC power cord to an electrical outlet.

For details on the rear panel, see 3.2, “Rear Panel.”

## 2.6 Grounding

- 
- ⚠ WARNING** • The product is equipment of Safety Class I of the IEC Standards (equipment with a protective conductor terminal). Be sure to connect the protective conductor terminal of the product to an electrical ground (safety ground) to prevent electric shock.
- ⚠ CAUTION** • If no grounding is provided, a malfunction may result from external noise and/or the product may generate a large amount of noise.
- 

There are two ways to ground the tester, as given below.

- Connect the AC power cord to a three-contact grounded electrical outlet.

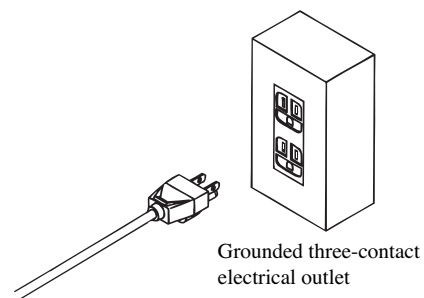

- Connect the protective conductor terminal on the rear panel of the tester directly to ground.  
Selection, preparation, and installation of grounding leads must be performed by qualified personnel.

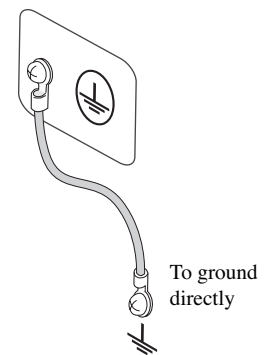

## 2.7 Connecting the Test Leads

- 
- ⚠ WARNING** • While this product generates voltages as low as 6 V or less AC, it carries a maximum current flow of 30 A. Always check to make sure that no connections are loose. Loose connection will result in overheating of the OUTPUT terminals or the DUT (Device Under Test), which may then result in burns or injury.
- Never connect the voltage measurement cable (thin wire) of the supplied test leads or optional test probe to the OUTPUT terminals. The nominal sectional area of this wire is inadequate for such currents, and burning may result.
- ⚠ CAUTION** • This product carries a large current and consequently generates a strong magnetic field. Make sure that no articles that may be affected by magnetic fields are located near the test leads or current output lines.
- For example, images on a CRT positioned close by may be significantly distorted.
- 

### 2.7.1 Supplied Test Lead TL11-TOS/TL12-TOS

1. Remove the short-circuit bars connecting the OUTPUT and SAMPLING terminals.

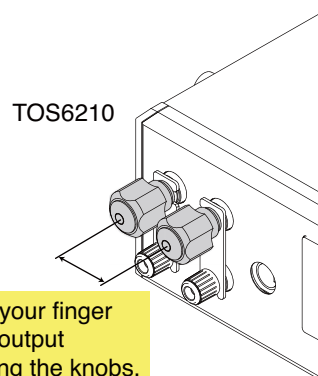
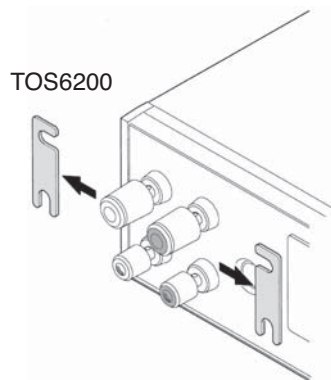

2. Connect the current output line on the crimp terminal side of the test lead (black or white) to the LOW side of the OUTPUT terminals; connect the voltage measurement line on the banana plug side to the LOW side of the SAMPLING terminals. Check that the connections are secure.
3. Connect the current output line on the crimp terminal side of the test lead (red) to the HIGH side of the OUTPUT terminals; connect the voltage measurement line on the banana plug side to the HIGH side of the SAMPLING terminals. Check that the connections are secure.

---

**⚠ WARNING** • Improper terminal connections can result in inaccurate measurements and burns or injury resulting from heat generated by contact resistance at the terminals.

---

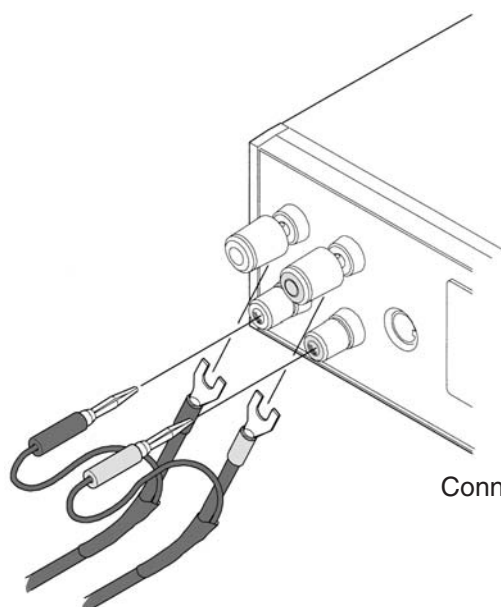

Connecting example of TOS6200

4. Connect the alligator clip of the test lead (black or white) to the protective conductor terminal of the DUT.
5. Connect the alligator clip of the test lead (red) to a test point of the DUT. For details, see 2.7.6, “Connecting to the DUT.”

---

**⚠ CAUTION** • Make sure that the alligator clip connections are secure. Improper connections may result in clip disconnection, causing sparking and potentially damaging the DUT.

---

## 2.7.2 Optional Test Probe LP01-TOS/LP02-TOS

- ⚠ WARNING**
- Never connect the voltage measurement cable (thin wire) of the optional LP01/LP02-TOS test probe to the OUTPUT terminals. Its nominal sectional area is inadequate for such currents, and burning may occur.
  - The rated current of the LP01-TOS and LP02-TOS test probes are up to 30 A and 60 A, respectively. Do not attempt to pass a current exceeding the rated current.
  - Improper terminal connections can result in inaccurate measurements and burns or injury resulting from heat generated by contact resistance at the terminals.

1. Turn off the POWER switch of the Tester.
2. Remove the short-circuit bars connecting the OUTPUT and SAMPLING terminals.
3. Connect the LOW test lead to the LOW terminal of the Tester.
4. Connect the each cable of the test probe to the HIGH and REMOTE terminal of the Tester.

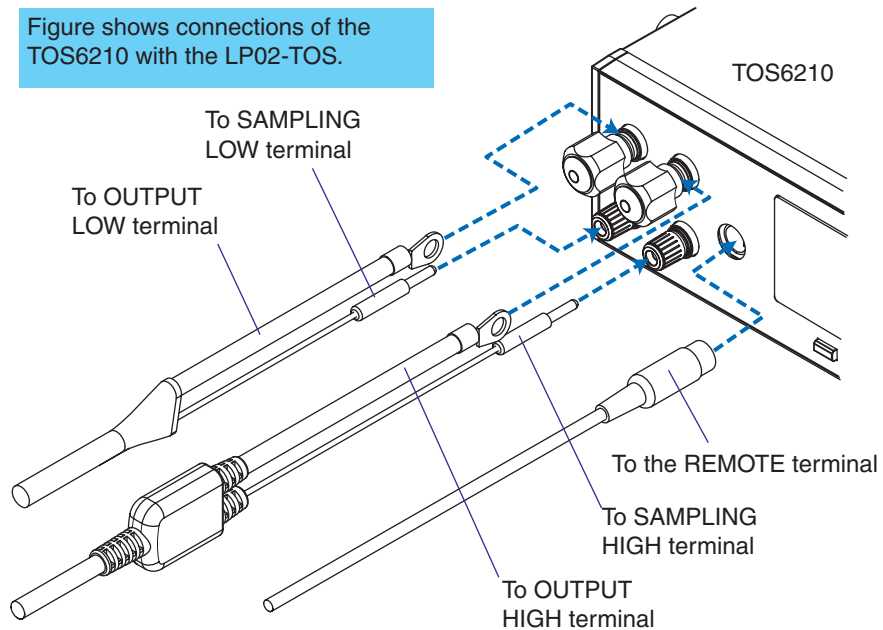



## 2.7.3 Other Leads

- 
- ⚠ WARNING** • If you use a lead wire other than those supplied with the product, select wires of the nominal sectional areas meeting the test current.
- ⚠ CAUTION** • To avoid generating excessive heat at the connections, use crimp terminals appropriate for the sectional area of the current output line.
- 

Select wires on the basis of the following criteria.

Test Current (I)	Required Nominal Sectional Areas of Wire
$I \leq 30 \text{ A}$	5.5 mm <sup>2</sup> or more
$30 < I \leq 60 \text{ A}$	14 mm <sup>2</sup> or more

Resistance values with respect to the nominal sectional areas of wires are as follows:

Use lead wires within a total lead length of 10 m or less.

Nominal Sectional Areas of Wire	Resistance Value per Meter
5.5 mm <sup>2</sup>	3.5 mΩ
14 mm <sup>2</sup>	1.5 mΩ

## 2.7.4 Measurements Using Four Terminals

Four-terminal measurements allow the tester to measure the resistance of the DUT, excluding the minute resistance of the leads, contact resistance of the OUTPUT terminals, and other non-essential characteristics.

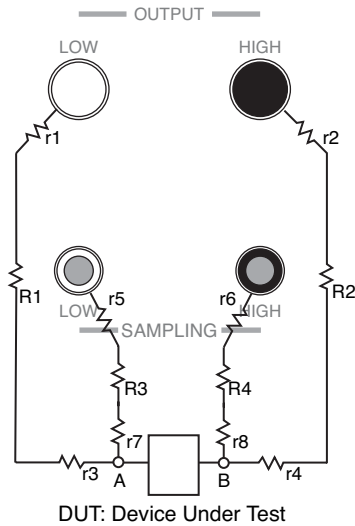

Remove the short-circuit bars connecting the OUTPUT and SAMPLING terminals and connect the leads as shown in Fig. 2-4.

Sampling the voltage between A and B allows the tester to measure the resistance between A and B without interference from the effects of contact resistance  $r1$  to  $r8$  and resistance components  $R1$  to  $R4$  of the leads.

$r1$  to  $r8$ : Contact resistance  
 $R1$  to  $R4$ : Resistance of the leads

Fig. 2-4 Four-Terminal Connection

## 2.7.5 Measurements Using Two Terminals

Perform two-terminal measurements if four-terminal measurements can't be made. Note that measurements using two terminals will include the resistance components of the leads and the contact resistance of the OUTPUT terminals.

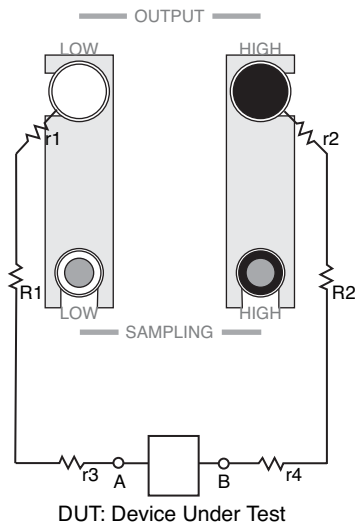

Install the short-circuit bars between the OUTPUT and SAMPLING terminals and connect the leads as shown in Fig. 2-5. The tester measures the total resistance value of contact resistance  $r1$  to  $r4$ , resistance components  $R1$  and  $R2$  of the leads, and the resistance between A and B.

$r1$  to  $r4$ : Contact resistance  
 $R1$  to  $R2$ : Resistance of the leads

Fig. 2-5 Two-Terminal Connection

Two-terminal measurements can be performed with the resistance components ( $R1$ ,  $R2$ ) of the leads and the contact resistances ( $r1$  to  $r4$ ) of the OUTPUT terminals subtracted beforehand. For more information, see 4.2.6, "Offset Canceling Function."

## 2.7.6 Connecting to the DUT

Connect to the DUT when the tester status is either of the following:

- Ready (“READY” displayed on the LCD)
- Waiting during a contact check (TEST LED blinking)

---

**⚠ WARNING** • To avoid burns, do not inadvertently touch the testing point or the end of the test probe or lead during the test or immediately after test, since they are at high temperature.

---

### ■ Testing from the protective conductor terminal of the AC power inlet

Connect one of the test leads to the protective conductor terminal of the AC power inlet of the DUT; connect the other test lead to a test point.

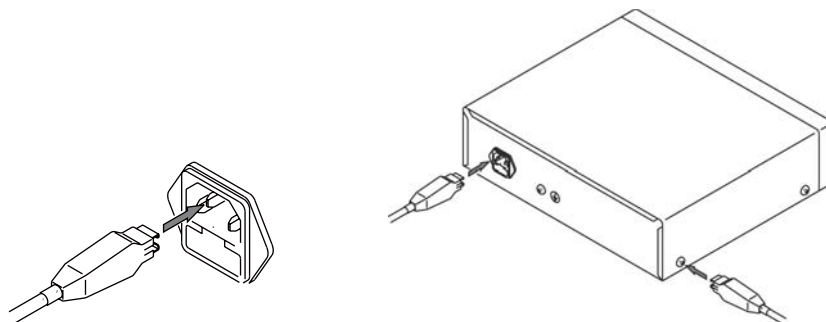

### ■ Testing from the protective conductor terminal on the enclosure

Connect one of the test leads to the protective conductor terminal of the DUT; connect the other test lead to a test point.

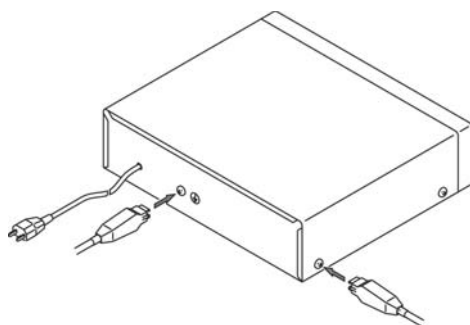

### ■ Testing from the ground contact of the AC power cord

Connect one of the test leads to the ground contact of the AC power cord of the DUT; connect the other test lead to a test point.

**NOTE**

- Some safety standards specify excluding the resistance value of the AC power cord protective ground wire from testing. Check the appropriate safety standard to determine if this is the case.

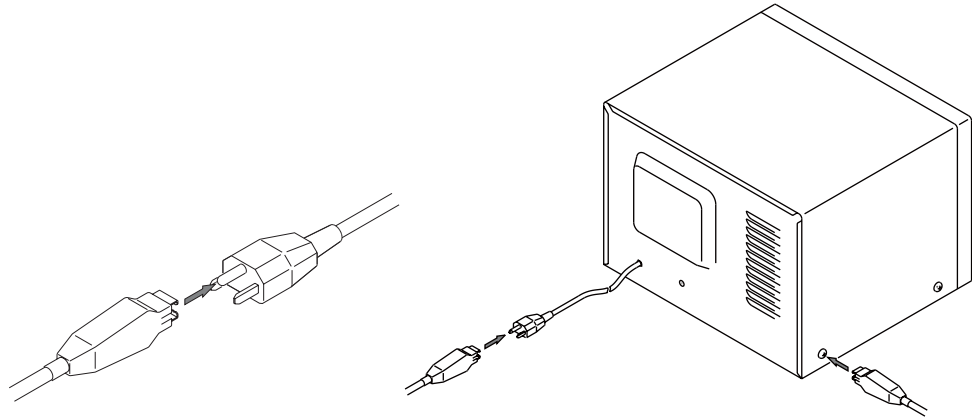

## 2.8 Preliminary Inspection

Always inspect the following four points before testing.

- Check that the test lead covers are free of cracks or tears.
- Check that there are no breaks in the test leads.
- Short-circuit the ends of the test leads and test at a specified current to check for abnormalities.
- Perform the test with the OUTPUT terminals opened. This test must result in a FAIL judgement.

# 3



## **Chapter 3 Part Names and Functions**

Gives the names and functions of switches, keys, indications, connectors, and other parts on the front and rear panels.

## 3.1 Front Panel

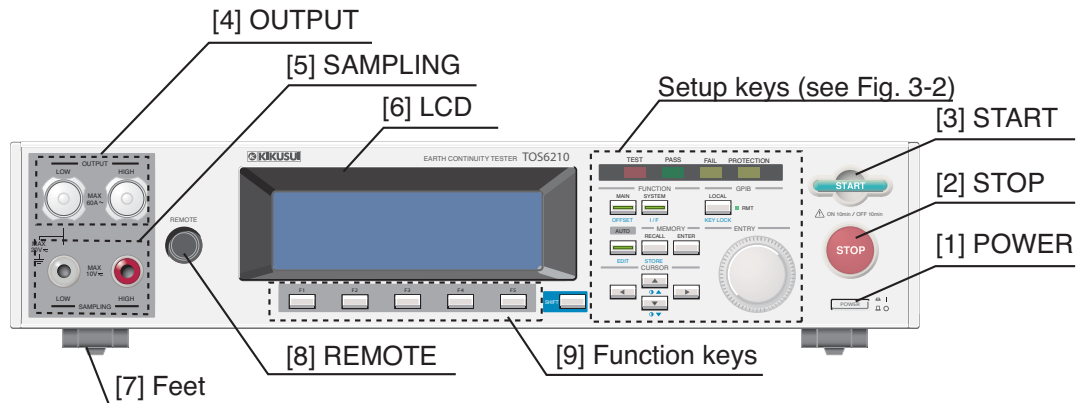

Fig.3-1 Front Panel (example of TOS6210)

### [1] POWER

Turns the tester power ON/OFF. When power is turned ON ( | ), the tester starts under the test conditions set when power was turned OFF ( O ).

Turning the power ON with the SHIFT key held down initializes the tester to factory-set settings. For initialization, see 4.11, "Initialize," and for turning the power ON, see 4.1, "Turning on the Power."

---

**NOTE**

- Initializing clears the contents of all panel memories and programs stored. Check all data in memories and programs before initializing.
- 

### [2] STOP

This switch is used to stop a test.

Press this switch to cancel a PASS, FAIL, or PROTECTION status.

Pressing this switch places the tester in ready status.

### [3] START

This switch is used to start a test.

Press this switch when "READY" is displayed on the LCD to begin testing.

During testing, the TEST LED indicator lights and a "TEST" indication appears on the LCD.

---

#### [4] OUTPUT

These current output terminals are used to connect current output wires for testing.

- 
- ⚠ CAUTION** • The maximum input voltage between the OUTPUT terminals and chassis is 20 V AC/DC or less. Do not apply an external voltage exceeding this limit.
- 

#### [5] SAMPLING

These voltage input terminals are used to connect voltage measuring wires for four-terminal measurements.

- 
- ⚠ CAUTION** • The maximum input voltage between the SAMPLING terminals is 10 V AC/DC or less. Do not apply external voltage exceeding this limit.
- 

#### [6] LCD

Displays information, including the range of set values and measured values.

#### [7] Feet

Used to raise the front panel of the tester to get a better view of the LCD screen or improve the operability of the keys.

For usage of the feet, see 2.2, "Precautions for Installation."

#### [8] REMOTE

This terminal is used to connect an optional remote control box or dedicated test probe.

#### [9] Function keys

Provide functions corresponding to the F1 to F5 menus displayed on the LCD.

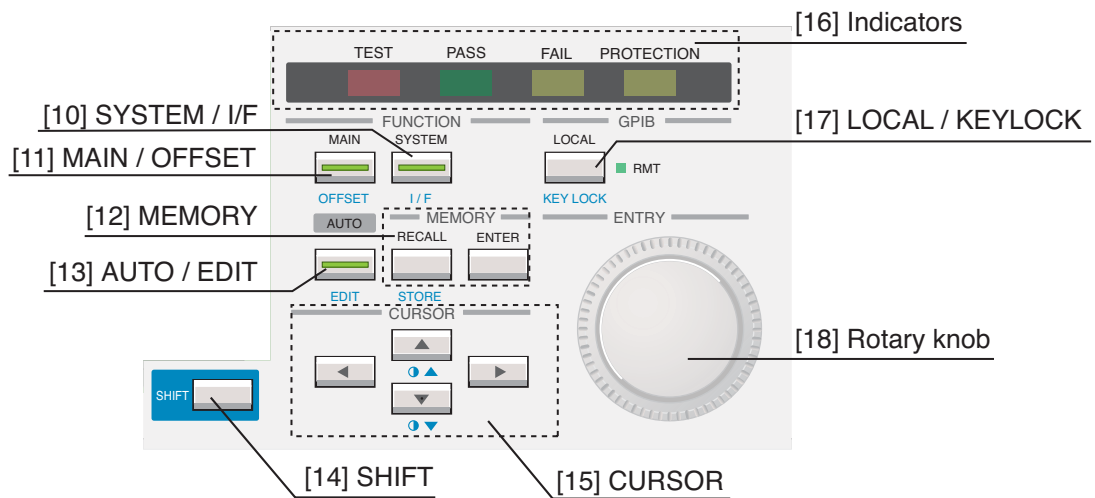

Fig. 3-2 Setup keys (example of TOS6210)

### [10] SYSTEM / I/F

This key is used to make the system settings of the tester.

Pressing this key causes its LED lights up and displays the system setup screen on the LCD (SYSTEM).

Pressing this key with the SHIFT key held down displays the interface setup screen (INTERFACE) on the LCD.

### [11] MAIN / OFFSET

Pressing this key causes its LED lights up and displays the test conditions setup screen (MAIN) on the LCD. Generally, testing is performed from this screen.

Pressing this key with the SHIFT key held down displays the offset measurement screen (OFFSET).

### [12] MEMORY

- RECALL/STORE key

Press this key to recall panel memory.

Change the memory number using the rotary knob, then press the ENTER key next to this key. This recalls the contents of the specified memory number.

Pressing this key with the SHIFT key held down enables test conditions to be stored to memory. The procedure is the same as for recall.

- ENTER key

Used to accept an entered memory number when recalling panel memory or when saving test conditions to panel memory.



### [13] AUTO / EDIT

Pressing this key causes its LED lights up and displays the program execution screen on the LCD (AUTO READY).

Pressing this key with the SHIFT key held down displays the program editing screen (AUTO EDIT) to enable program editing.

### [14] SHIFT

Switches the function of each key. Pressing a key without the SHIFT key held down activates the function indicated on the upper part of that key, while pressing the key with the SHIFT key held down activates the function indicated (in blue) on the lower part of that key.

### [15] Cursor keys

Used to move the cursor when setting test conditions or other parameters.

Pressing the ▲▼ key with the SHIFT key held down allows you to change the LCD contrast.

For TOS6210, pressing the ◀▶ key with the SHIFT key held down activates a function moving the system screen backward (PREV) or one page forward (NEXT).

### [16] Indicators

- TEST

This LED indicates that testing is underway.

Blinks for contact checks when the contact check is set to ON standby.

- PASS

This LED gives the test result.

When the test result has been judged as PASS, this LED lights up.

For tests that do not use the timer function, a pass/fail judgement is not made.

- FAIL

This LED gives the test result.

When the test result has been judged as FAIL, this LED lights up.

- PROTECTION

This LED indicates that an internal protection function has been tripped.

For the protection function, see 4.10, "Protection Function."

### [17] LOCAL / KEYLOCK

Pressing this key while the tester is being controlled remotely through the GPIB or RS-232C interface restores local control.

Pressing this key with the SHIFT key held down under local control activates the key lock function. In the key lock status, "KEYLOCK" appears on the LCD. Under remote control, the LED to the right of this key lights.

### [18] Rotary knob

In ready status: Used to set test conditions and other parameters displayed on the LCD.

During testing: Used to change the test current.

## 3.2 Rear Panel

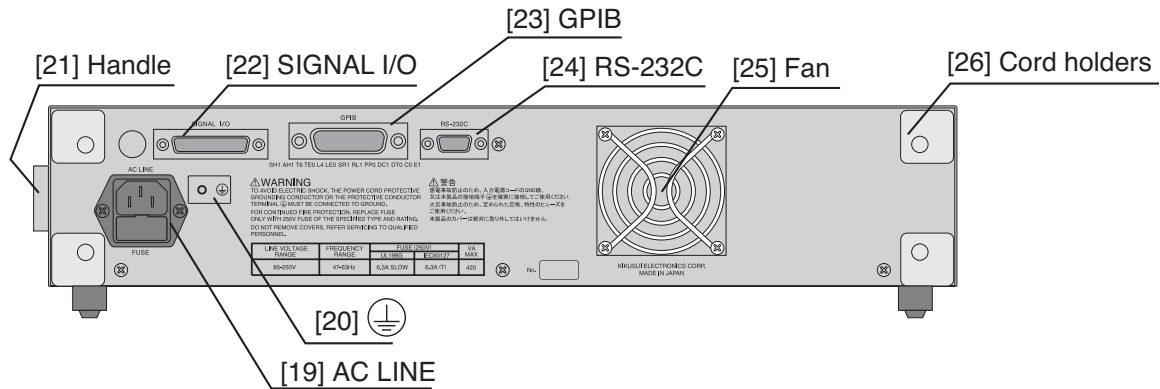

Fig. 3-3 Rear Panel (example of TOS6210)

### [19] AC LINE

This is the connector for AC power cord that supplies power to the tester.

Connect the supplied AC power cable here. The fuse holder is also found here.

For connection of the AC power cord, see, 2.5 “Connecting the AC Power Cord,” and for fuse replacement, see, 7.3 “Checking and Replacing the Fuse.”

### [20]

This is the protective conductor terminal.

For more information regarding grounding, see 2.6, “Grounding.”

### [21] Handle

Used to carry the tester.

### [22] SIGNAL I/O

This D-sub 25-pin connector is used for remote control of testing start and stop operations, or to check the tester status according to an output signal.

For more information, see 5.2, “SIGNAL I/O Connector.”

### [23] GPIB

This connector is used to connect a GPIB cable for remote control of the tester through a PC via the GPIB interface.

### [24] RS-232C

This connector connects an RS-232C cable for remote control of the tester is remote through a PC via the RS-232C interface.

---

[25] Fan

Used to cool the tester interior.

- 
- ⚠ CAUTION** • Provide adequate space at the air intakes on the side panels and fan exhaust port to allow sufficient air flow.
- 

[26] Cord holders

Used to wind the AC power cord when the tester is not in use.

- 
- ⚠ CAUTION** • Never use the tester in an upright position. Use of the product with the cord holders serving as feet causes the tester to fall down, which may result in damage to the tester or injury to the user.
-



# 4

## **Chapter 4 Basic Operation**

Describes basic operations such as setting test conditions and starting a test.

## 4.1 Turning on the power

**⚠ CAUTION** • Once you have turn off the POWER switch, wait several seconds before turning it back on. Rapidly turning it off and on may damage the tester.

1. Check that the AC power cord is connected properly.  
To check it, see 2.4, “Checking the Line Voltage” and 2.5, “Connecting the AC Power Cord.”
2. Connect the AC power cord to an electrical outlet.
3. Turn on the tester POWER switch.

Following the opening screen that displays the ROM version and other information on the LCD, the screen displayed when you last turned the POWER switch off appears. When the switch is turned on for the first time after purchase, the following test conditions setup screen (MAIN) is displayed.

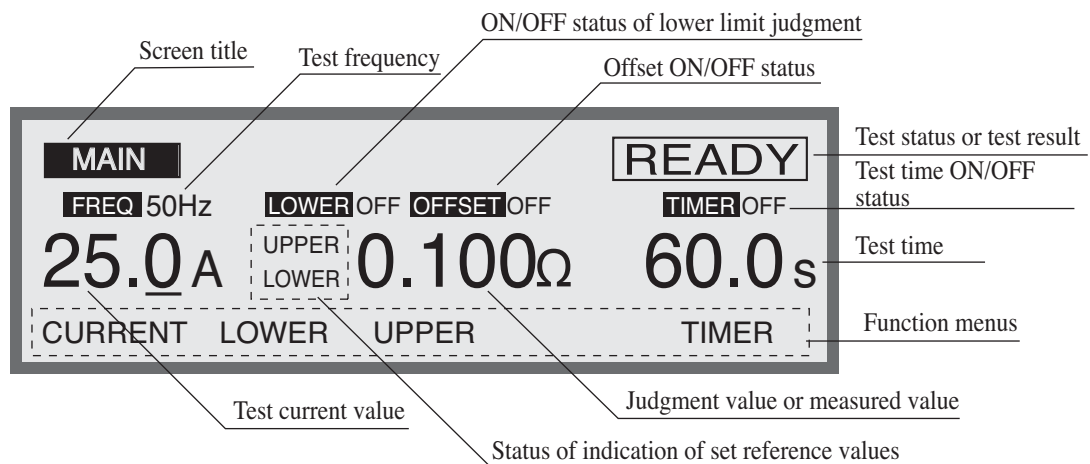

## 4.2 Setting the Test Conditions

### ■ Test Conditions setup screen

The test conditions are set in the test conditions setup screen (MAIN).

If another screen is displayed, press the MAIN key. The MAIN screen appears on the LCD, and the LED on the MAIN key lights.

### ■ Moving to a desired item

Use the ▲▼◀▶ keys to move the cursor to a desired item.

If functions are displayed above the F1 to F5 keys, they may be used to move a cursor directly to a desired item. Holding down with the SHIFT key, press any of keys F1 to F5 to activate the operation indicated above the key.

### ■ Settings corresponding to safety standards

At factory shipment, settings corresponding to various safety standards are written to memory. For the memory, see 4.6, “Panel Memory” and Appendix A.3, “Initial Settings of the Memory.” Also, for the safety standards, see A.4, “Summary of the Safety Standards for Earth Continuity Testing.”

---

**NOTE**

- “A.4 Summary of the Safety Standards for Earth Continuity Testing” is a summary of the safety standards. Before performing actual testing, check the test conditions match your appropriate safety standard.
-

## 4.2.1 Test Current

Set the maximum current value flowing through the DUT as follows:

TOS6200: 3.0 to 30.0 A AC

TOS6210: 6.0 to 62.0 A AC (resolution: 0.1A)

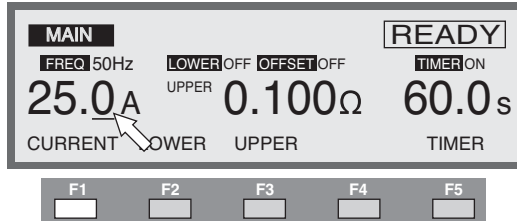

1. Press the F1 (CURRENT) key to move the cursor to the test current value if it is not already there (you can also move the cursor using the  $\blacktriangle$   $\blacktriangledown$   $\blacktriangleleft$   $\blacktriangleright$  keys).
2. Use the  $\blacktriangleleft$   $\blacktriangleright$  keys to move the cursor below a digit to be set.
3. Set a test current value with the rotary knob.

### “OVER VOLT” blinks on the LCD.

A value obtained by multiplying the test current value by the upper reference value has exceeded 5.4 V. Test cannot begin under the current conditions. Change the setting referring to “OVER VOLT” in 4.9.1, “Setting Output out of the Operation Range.”

### “OVER VA” blinks on the LCD.

The setting has exceeded the maximum rated output. Test cannot begin under the current conditions. Change the setting referring to “OVER VA” in 4.9.1, “Setting Output out of the Operation Range.”

### “OVER RESI” blinks on the LCD. (TOS6210 only)

A value obtained by dividing the upper reference value by the test current value has exceeded 0.6  $\Omega$ . Test cannot begin under the current conditions. Change the setting referring to “OVER RESI (TOS6210 only)” in 4.9.1, “Setting Output out of the Operation Range.”

### The current value may be changed even during testing.

To avoid rapid changes, current value must be changed by increasing or decreasing the least significant digit (the cursor is fixed at the least significant digit).

If the test current is changed when the resistance value is close to the upper reference value, a FAIL status may occur.

### “OVER LOAD” blinks on the LCD during testing.

If the output power exceeds a maximum power rating, the power limitation safety function is tripped and protection status occurs.

Change the setting referring to 4.10.3, “Overload Protection (OVER LOAD).”



## 4.2.2 Test Frequency

Select the frequency of the test current, 50 or 60 Hz.

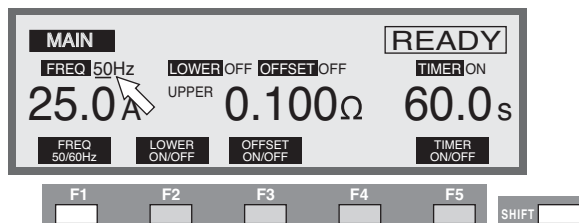

You can set the test frequency using the SHIFT + F1 key combination (pressing the F1 key while holding down the SHIFT key.) Pressing SHIFT + F1 toggles between 50 Hz and 60 Hz settings.

You can also use the ▲▼◀▶ keys to move the cursor to the test frequency indication.

With the cursor at the test frequency indication, use the rotary knob to set.

Turning the knob clockwise: 60 Hz

Turning the knob counterclockwise: 50 Hz

## 4.2.3 Upper Reference Value

If the measured value exceeds the set reference value, the test is judged FAIL.

The following judgment methods are available:

Judgment Method	TOS6200	TOS6210
Resistance value-based judgment	Available	Available (either may be selected)
Sampled voltage value-based judgment	Not available	

### ■ Selection of the judgment method (TOS6210 only)

The TOS6210 allows you to select resistance value-based judgment or sampled voltage value-based judgment.

Press the SHIFT and F4 keys together to switch between judgment methods. Each time you press the SHIFT and F4 keys, the upper reference value alternates between a resistance value and voltage value.

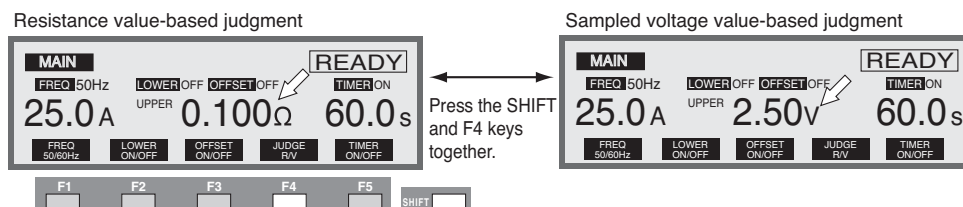

## Resistance value-based judgment

Set an upper reference value as follows:

TOS6200: 0.001 to 1.200  $\Omega$  (resolution: 0.001  $\Omega$ )

TOS6210: 0.001 to 0.600  $\Omega$  (resolution: 0.001  $\Omega$ )

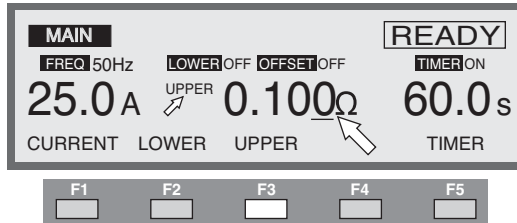

1. Press the F3 (UPPER) key if the upper reference value is not displayed on the LCD. (You can also use the  $\blacktriangle$   $\blacktriangledown$   $\blacktriangleleft$   $\blacktriangleright$  keys to move the cursor when the upper reference value is displayed.)
2. Use the  $\blacktriangleleft$   $\blacktriangleright$  keys to move the cursor to the desired digit.
3. Use the rotary knob to set an upper reference value.

### “UP $\leq$ LOW” blinks on the LCD.

If an upper reference value less than the lower reference value is set when lower limit judgment is ON, the “READY” indication in the upper right of the LCD changes to blink “UP  $\leq$  LOW,” informing you that testing cannot begin under the current conditions. In this case, increase the upper reference value or reduce the lower reference value.

### “OVER VOLT” blinks on the LCD.

A value obtained by multiplying the test current value by the upper reference value has exceeded 5.4 V. Test cannot begin under the current conditions. Change the setting referring to “OVER VOLT” in 4.9.1, “Setting Output out of the Operation Range.”

### “OVER VA” blinks on the LCD.

The setting has exceeded the maximum rated output. Test cannot begin under the current conditions. Change the setting referring to “OVER VA” in 4.9.1, “Setting Output out of the Operation Range.”

### “OVER LOAD” blinks on the LCD during testing.

If the output power exceeds a maximum power rating, the power limitation safety function is tripped and protection status occurs.

Change the setting referring to 4.10.3, “Overload Protection (OVER LOAD).”

## Sampled voltage value-based judgment (TOS6210 only)

Set the upper reference value in the range of 0.01 V to 5.40 V (resolution: 0.01 V).

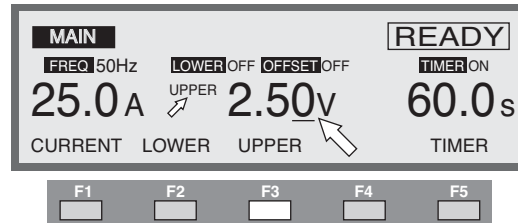

1. Press the F3 (UPPER) key if the upper reference value is not displayed on the LCD. (You can also use the ▲▼◀▶ keys to move the cursor when the upper reference value is displayed.)
2. Use the ◀▶ keys to move the cursor to the desired digit.
3. Use the rotary knob to set an upper reference value.

### “UP <= LOW” blinks on the LCD.

If an upper reference value less than the lower reference value is set when lower limit judgment is ON, the “READY” indication in the upper right of the LCD changes to blink “UP <= LOW,” informing you that testing cannot begin under the current conditions. In this case, increase the upper reference value or reduce the lower reference value.

### “OVER VA” blinks on the LCD.

The setting has exceeded the maximum rated output. Test cannot begin under the current conditions. Change the setting referring to “OVER VA” in 4.9.1, “Setting Output out of the Operation Range.”

### “OVER RESI” blinks on the LCD. (TOS6210 only)

A value obtained by dividing the upper reference value by the test current value has exceeded 0.6 Ω. Test cannot begin under the current conditions. Change the setting referring to “OVER RESI (TOS6210 only)” in 4.9.1, “Setting Output out of the Operation Range.”

### “OVER LOAD” blinks on the LCD during testing.

If the output power exceeds a maximum power rating, the power limitation safety function is tripped and protection status occurs.

Change the setting referring to 4.10.3, “Overload Protection (OVER LOAD).”

## 4.2.4 Lower Reference Value

If the measured value is less than the set reference value, the test is judged FAIL. You can select whether to make lower limit judgment. To perform lower limit judgment, set the LOWER indication to ON in the lower reference value setup screen. The following judgment methods are available:

Judgment Method	TOS6200	TOS6210
Resistance value-based judgment	Available	Available (either may be selected)
Sampled voltage value-based judgment	Not available	

### ON/OFF of Lower Limit Judgment

To also use the lower reference value for judgment of the test results, set the LOWER indication to ON.

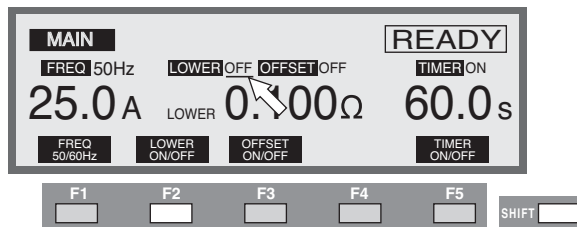

Pressing the SHIFT and F2 keys together allows you to toggle the lower limit judgment function ON/OFF. Pressing SHIFT + F2 toggles between ON and OFF.

You can also use the ▲▼◀▶ keys to move the cursor to the ON/OFF indication for the lower limit judgment function. With the cursor at the LOWER indication, use the rotary knob to set.

Turning the knob clockwise: ON

Turning the knob counterclockwise: OFF

### ■ Selection of the judgment method (TOS6210 only)

The TOS6210 allows you to select resistance value-based judgment or sampled voltage value-based judgment.

Press the SHIFT and F4 keys together to switch between judgment methods. Each time you press the SHIFT and F4 keys, the judgment reference value alternates between a resistance value and voltage value.

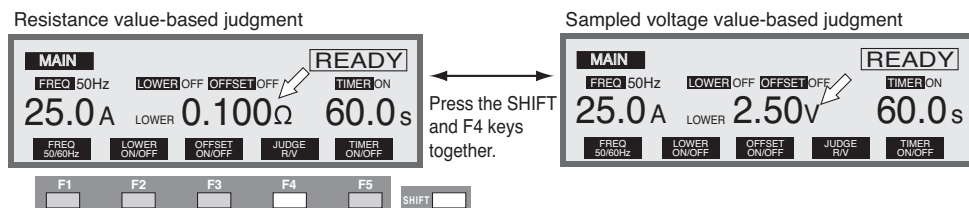

## Resistance value-based judgment

Set a lower reference value as follows:

TOS6200: 0.001 to 1.200  $\Omega$  (resolution: 0.001  $\Omega$ ).

TOS6210: 0.001 to 0.600  $\Omega$  (resolution: 0.001  $\Omega$ ).

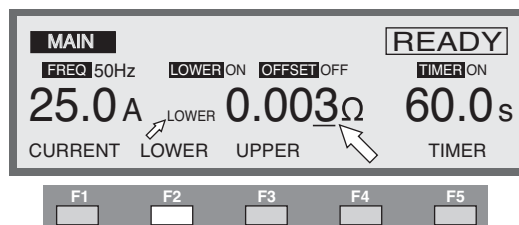

1. Press the F2 (LOWER) key if the lower reference value is not displayed on the LCD. (You can also use the  $\blacktriangle$   $\blacktriangledown$   $\blacktriangleleft$   $\blacktriangleright$  keys to move the cursor when the lower reference value is displayed.)
2. Use the  $\blacktriangleleft$   $\blacktriangleright$  keys to move the cursor to the desired digit.
3. Use the rotary knob to set a lower reference value.

**“UP <= LOW” blinks on the LCD.**

If a lower reference value more than the upper reference value is set when lower limit judgment is ON, the “READY” indication in the upper right of the LCD changes to blink “UP <= LOW,” informing you that testing cannot begin under the current conditions. In this case, increase the upper reference value or reduce the lower reference value.

## Sampled voltage value-based judgment (TOS6210 only)

Set the lower reference value in the range of 0.01 V to 5.40 V (resolution: 0.01 V).

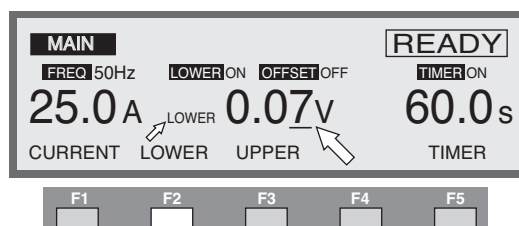

1. Press the F2 (LOWER) key if the lower reference value is not displayed on the LCD. (You can also use the  $\blacktriangle$   $\blacktriangledown$   $\blacktriangleleft$   $\blacktriangleright$  keys to move the cursor when the lower reference value is displayed.)
2. Use the  $\blacktriangleleft$   $\blacktriangleright$  keys to move the cursor to the desired digit.
3. Use the rotary knob to set a lower reference value.

**“UP <= LOW” blinks on the LCD.**

If a lower reference value more than the upper reference value is set when lower limit judgment is ON, the “READY” indication in the upper right of the LCD changes to blink “UP <= LOW,” informing you that testing cannot begin under the current conditions. In this case, increase the upper reference value or reduce the lower reference value.

## 4.2.5 Test Time

If the measured value is within the range of the lower reference and upper reference values after the specified time has elapsed from the start of test, the test result will be judged PASS, completing the test.

Whether or not to set a test duration is selectable. To set a test duration, set the TIMER indication to ON in the test duration setup screen. If no test duration is set, testing will continue until the test result is judged FAIL or you press the STOP switch.

### Timer ON/OFF Settings

To run the test with a specified test duration, set the TIMER indication to ON.

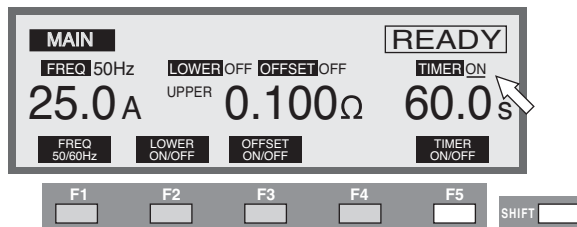

Pressing the SHIFT and F5 keys together allows you to toggle the timer function ON/OFF. Pressing SHIFT + F5 toggles between ON and OFF.

You can also use the ▲▼◀▶ keys to move the cursor to the timer function ON/OFF indicator. With the cursor at the TIMER indication use the rotary knob to set.

Turning the knob clockwise: ON

Turning the knob counterclockwise: OFF

### Setting the Test Time

You can set a testing duration anywhere in the range 0.3 s to 999 s (resolution of 0.1 s for 0.3 s to 99.9 s and 1s for 100 s to 999 s).

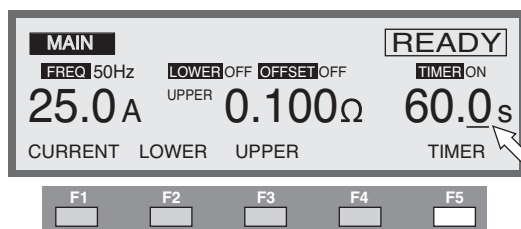

1. Press the F5 (TIMER) key to move the cursor if the cursor is not below the timer (you can also move the cursor using the ▲▼◀▶ keys).
2. Use the ◀▶ keys to move the cursor to the desired digit.
3. Use the rotary knob to set the test duration.

## 4.2.6 Offset Canceling Function

The offset canceling function displays the measured value after subtracting a pre-stored offset value from it. This function is useful for cases where a surplus resistance component (such as a test-lead resistance component or the OUTPUT terminal's contact resistance) is to be canceled from the measured value in two-terminal measurements.

To use the offset canceling function, you need to measure the surplus resistance component (offset value) in advance using this tester.

### Offset Canceling Function ON/OFF Settings

To use the offset canceling function, set the OFFSET indication to ON.

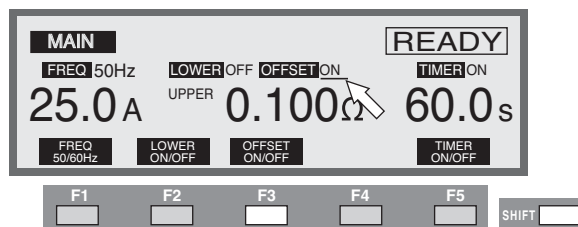

Pressing the SHIFT and F3 keys together allows you to toggle the offset canceling function ON/OFF. Pressing the SHIFT + F3 toggles between ON and OFF.

You can also use the ▲▼◀▶ keys to move the cursor to the offset function ON/OFF indicator. With the cursor at the OFFSET indication use the rotary knob to set.

Turning the knob clockwise: ON

Turning the knob counterclockwise: OFF

### Measurement of an offset value

1. Connect the lead wires whose resistance components are to be measured to the OUTPUT terminals.
2. Short-circuit the ends of the leads connected to the LOW and HIGH terminals of the OUTPUT terminals.
3. Press the SHIFT + MAIN/OFFSET keys (press the MAIN key while holding down the SHIFT key) to invoke the offset measurement screen (OFFSET).

In the OFFSET screen, the test current, test frequency, and timer indicate the values shown before switching screens.

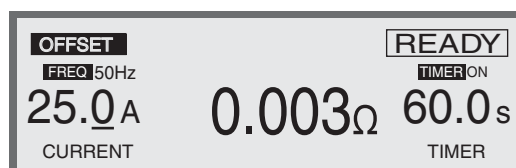

4. If necessary, set test current, test frequency, and timer values.

5. When "READY" (ready status) is displayed in the OFFSET screen, press the START switch. This begins offset measurement.

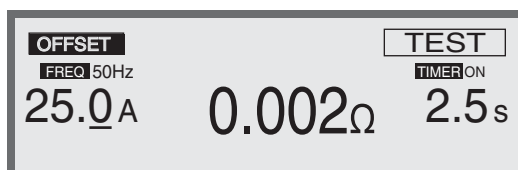

When you press the STOP switch or when the time set in the timer elapses, the tester stores the offset value of that time in memory. When offset measurement ends, the tester reverts to ready status.

Press the MAIN key to display the MAIN screen. Check that the offset function is ON, then begin the test.

To check the offset value, display the OFFSET screen by pressing the MAIN/OFFSET key again while holding down the SHIFT key.

#### **To adjust OFFSET (TOS6210 only)**

A measured OFFSET value can be finely adjusted using either the SHIFT and F2 (ADJ+) keys or the SHIFT and F3 (ADJ-) keys together.

#### **“OVER VOLT” blinks on the LCD.**

A value obtained by multiplying the test current value by the upper reference value has exceeded 5.4 V. Test cannot begin under the current conditions. Change the setting referring to “OVER VOLT” in 4.9.1, “Setting Output out of the Operation Range.”

#### **“OVER VA” blinks on the LCD.**

The setting has exceeded the maximum rated output. Test cannot begin under the current conditions. Change the setting referring to “OVER VA” in 4.9.1, “Setting Output out of the Operation Range.”



## 4.3 Starting and Ending Test

### NOTE

- No test can begin when the tester is in protection status. For more information on the protection function, see 4.10, “Protection Function.”
- If the STOP switch has been pressed, a test cannot be started. (This includes stop signals sent from the remote control.)
- When DOUBLE ACTION is set to ON, you can begin the test by pressing the STOP switch, then pressing the START switch within approximately a half-second. Otherwise, the test cannot be started. For information on DOUBLE ACTION, see 4.4, “System Setup.”
- When MOMENTARY is set to ON, the tester performs the test only while the START switch is being held down. For more information on MOMENTARY, see 4.4, “System Setup.”

### 4.3.1 Starting a Test

#### To begin the test:

To begin testing, press the START switch while the MAIN screen indicates ready. In the ready status, the upper right part of the LCD indicates “READY”.

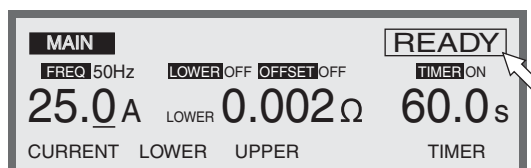

#### When the test starts:

When the test starts, the LCD screen changes to display the following:

During testing, "TEST" appears in the upper right part of the LCD and the TEST LED lights up.

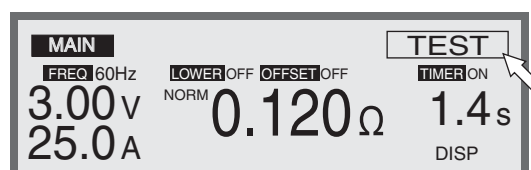

The time indicated after start of the test differs with the timer function set to ON or OFF.

When the timer is ON: The time remaining of the set time is indicated.

When the timer is OFF: The elapsed test duration is indicated.

(Note: When the time exceeds 999 seconds, “999” blinks.)

### Changing the test current during the test:

You can change the test current with the rotary knob during a test. Note that the value should fall within the upper and lower limits.

The test current cannot be changed if the key lock function is activated.

#### NOTE

- Changing the test current when the resistance value is close to the upper reference value may precipitate a FAIL status.

### Switching the screen during the test:

During testing, you can change the screen display as follows using the F5 (DISP) key.

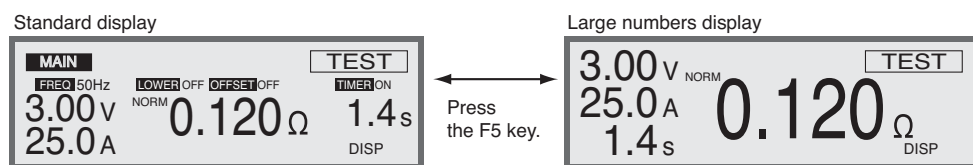

### To stop the test:

To stop the test, press the STOP switch.

## 4.3.2 Ending the Test

Test will be terminated if any of the following conditions is established:

- A test time has elapsed (with the timer ON) [PASS judgment].
- A measured value out of the range of the set reference values has been detected [FAIL judgment].
- The STOP switch was pressed.
- The tester has entered protection status.

### ■ PASS judgment

When the lower limit judgment function is ON and the measured value falls between the upper and lower reference values, the tester returns a PASS judgment.

When the lower limit judgment function is OFF, the tester returns a PASS judgment for the measured value if the value is less than the upper reference value.

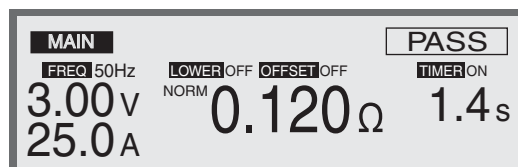

When a PASS judgment is returned for the measured value, "PASS" appears in the upper right part of the LCD, the PASS LED indicator lights, and the buzzer sounds. The PASS judgment is generally displayed for about 0.2 seconds (default value). You can set the PASS judgment display time in the range 0.2 s to 10.0 s or to HOLD. For information on altering this setting, see 4.4, "System Setup."

### When the timer is ON

After the time set in the timer elapses, the tester returns a PASS judgment and reverts to ready status. The measurement result is displayed while "PASS" is displayed.

### When the timer is OFF

The test continues as long as the measured value meets the conditions set for a PASS judgment.

To stop the test, press the STOP switch. If the test is terminated by pressing the STOP switch, no judgment is returned for the measured value, and "PASS" is not displayed.

### ■ FAIL judgment

If the lower limit judgment function is ON and the measured value falls outside the range between the upper and lower reference values, the tester returns a FAIL judgment.

When the lower limit judgment function is OFF, the tester returns a FAIL for the measured value if the value exceeds the upper reference value.

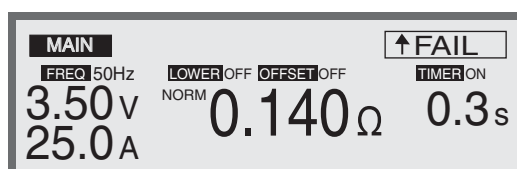

The "↓ FAIL" appears in the upper right part of the LCD when the measured value is below the lower reference value, and the "↑ FAIL" appears in the same part of the LCD when the measured value is above the upper reference value. The FAIL LED indicator also lights, and the buzzer sounds.

To remove a FAIL judgment, press the STOP switch.

The measurement result is displayed until you press the STOP switch.

In case of FAIL, the test duration indicates the elapsed time regardless of the timer ON/OFF setting.

## 4.4 System Setup

Press the SYSTEM key to display the system setup screen (SYSTEM). The LED on the SYSTEM key will also light.

You can set or enter the following nine items in the SYSTEM screen.

- Setting the measurement mode (MAX., NORMAL)
- Setting the PASS hold time
- ON/OFF for momentary
- ON/OFF for fail mode
- ON/OFF for double action
- ON/OFF for contact check
- Setting the buzzer volume
- Setting the contrast
- Entering comments

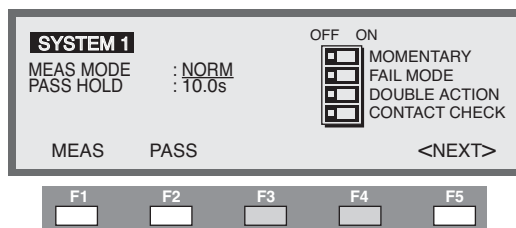

### Setting the Measurement Mode (MAX, NORM)

Select a measurement mode for resistance:

NORM: Normal measurement mode

MAX: Retains a peak value

1. Press the F1 (MEAS) key, or use the ▲▼◀▶ keys to move the cursor to MEAS MODE.
2. Use the rotary knob to select either MAX or NORM.  
Turning the knob clockwise: MAX  
Turning the knob counterclockwise: NORM

### Setting the PASS Hold Time

Set a hold time for PASS judgment between 0.2 s and 10.0 s (resolution: 0.1 s), or set to HOLD.

When PASS HOLD is set to HOLD, the tester retains the PASS judgment until you press the STOP switch.

1. Press the F2 (PASS) key, or use the ▲▼◀▶ keys to move the cursor to PASS HOLD.
2. Use the rotary knob to set a hold time for a PASS judgment.

## ON/OFF for Momentary

When **MOMENTARY** is set to **ON**, the tester performs a test only as long as the **START** switch remains depressed. Pressing the **SHIFT** and **F1** keys together allows you to set the momentary setting. Pressing the **SHIFT** + **F1** keys toggles between **ON** and **OFF** settings. Here, **▶** appears to the left of **MOMENTARY**.

When **▶** is displayed to the left of **MOMENTARY**, you can also use the rotary knob to enter **ON/OFF** settings.

Turning the knob clockwise: **ON**

Turning the knob counterclockwise: **OFF**

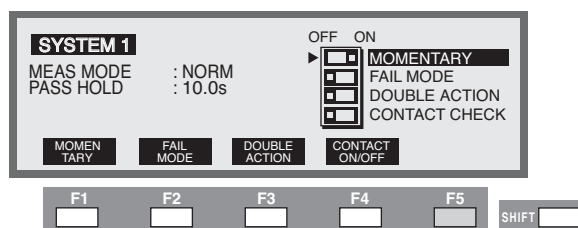

- NOTE**
- Releasing the **START** switch when **MOMENTARY** is set to **ON** is the same as pressing the **STOP** switch. If the step interval has been set to **HOLD** for programmed automatic testing, the program cannot proceed to the next step.

## ON/OFF for Fail Mode

With **FAIL MODE** set to **ON**, **FAIL** judgment and protection status cannot be cancelled by a stop signal from the remote control (you can still cancel by pressing the front panel **STOP** switch).

Pressing the **SHIFT** and **F2** keys together allows you to set the fail mode. Pressing the **SHIFT** + **F2** keys toggles between **ON** and **OFF** settings. Here, **▶** appears to the left of **FAIL MODE**. When **▶** is displayed to the left of **FAIL MODE**, you can also use the rotary knob to enter **ON/OFF** settings.

Turning the knob clockwise: **ON**

Turning the knob counterclockwise: **OFF**

---

## ON/OFF for Double Action

When DOUBLE ACTION is set to ON, you must press the START key within approximately a half-second after the STOP key is pressed to start testing. (The "READY" indication will go out approximately a half-second after the STOP key is pressed.)

Pressing the SHIFT and F3 keys together allows you to set double action. Pressing the SHIFT + F3 keys toggles between ON and OFF settings. Here, ► appears to the left of DOUBLE ACTION.

When ► is displayed to the left of DOUBLE ACTION, you can also use the rotary knob to enter ON/OFF settings.

Turning the knob clockwise: ON

Turning the knob counterclockwise: OFF

## ON/OFF for Contact Check

With CONTACT CHECK set to ON, the tester can start testing by monitoring current flow through the OUTPUT terminals.

When you press the START switch with the OUTPUT terminals opened, a "TEST" indication appears on the LCD, and the TEST LED on the front panel blinks, and the tester enters current monitoring status. When the probe contacts the DUT and causes current to flow, the TEST LED on the panel lights and the tester begins testing, continuing the test until the set time elapses or the STOP switch is pressed.

Pressing the SHIFT and F4 keys together allows you to set the contact check. Pressing the SHIFT + F4 keys toggles between ON and OFF settings. Here, ► appears to the left of CONTACT CHECK.

When ► is displayed to the left of CONTACT CHECK, you can also use the rotary knob to enter ON/OFF settings.

Turning the knob clockwise: ON

Turning the knob counterclockwise: OFF

---

**⚠ CAUTION** • After testing starts, sparking will occur if the probe is separated from the DUT and then recontacts it, potentially damaging the DUT or probe. Separate the probe from the DUT only after pressing the STOP switch.

---

## Setting the Buzzer Volume

You can set the volume for the buzzer that sounds in case of a FAIL judgment in the range from 0 to 10 (resolution: 1). The volume of the buzzer for a PASS judgment is approximately half that of a FAIL judgment.

1. If BUZZER VOL is not indicated on the LCD, press the F4 (NEXT) or F5 (PREV) function key to display the SYSTEM2 screen.

For the TOS6210, the display can also be switched by pressing the SHIFT and ◀ ▶ keys together.

2. Press the F1 (BUZZER) key, or use the ▲▼ keys to move the cursor to BUZZER VOL. Press the F1 (BUZZER) key to hear the buzzer sound set.
3. Use the rotary knob to set the buzzer volume.

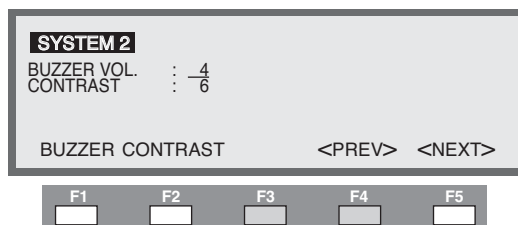

## Setting the Contrast

You can set the LCD screen contrast in the range from 0 to 10 (resolution: 1).

1. If CONTRAST is not indicated on the LCD, press the F4 (NEXT) or F5 (PREV) function key to display the SYSTEM2 screen.  
For the TOS6210, the display can also be switched by pressing the SHIFT and ◀ ▶ keys together.
2. Press the F2 (CONTRAST) key, or use the ▲▼ keys to move the cursor to CONTRAST.
3. Use the rotary knob to set contrast.

You can set contrast with the SHIFT + ▲▼ key combination (pressing the ▲ or ▼ key with the SHIFT key held down) in any screen.

## Entering Comments

You can enter up to 20 characters per line x 3 lines worth of comments (ASCII codes 20H to 7EH; see Appendix A.2).

1. If COMMENT is not indicated on the LCD, press the F4 (NEXT) or F5 (PREV) function key to display the SYSTEM3 screen.  
For the TOS6210, the display can also be switched by pressing the SHIFT and ◀ ▶ keys together.
2. Use the ▲▼◀ ▶ keys to move the cursor to the position where you wish to enter a comment.
3. Use the rotary knob to select characters.

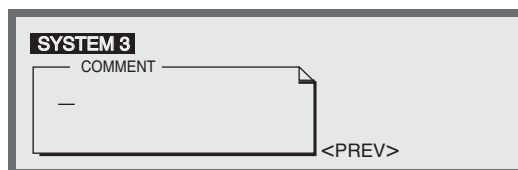

## 4.5 Interface Setup

Press the SHIFT + SYSTEM / I/F key combination (pressing the SYSTEM key with the SHIFT key held down) turns on the LED for the SYSTEM / I/F key lights up and displays the interface setup screen (INTERFACE).

You can set the following items in the INTERFACE screen.

### GPIB address

### RS-232C protocol

- Communication rate
- Data length
- Parity bit
- Stop bit

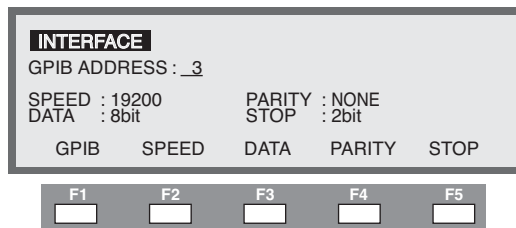

### 4.5.1 GPIB Address

Set the GPIB address of the tester in the range from 0 to 30.

---

**NOTE**

- The GPIB address set is not effective until the tester is restarted.
- 

1. Press the F1 (GPIB) key, or use the ▲▼◀▶ keys to move the cursor to GPIB ADDRESS.
2. Use the rotary knob to set the GPIB address.



## 4.5.2 RS-232C Protocol

### Setting the communications rate

Select a communications rate from the three following choices.

- 38400 bps
- 19200 bps
- 9600 bps

1. Press the F2 (SPEED) key, or use the ▲▼◀▶ keys to move the cursor to SPEED.
2. Use the rotary knob to select 38400, 19200, or 9600 bps.

### Setting the Data Length

Select a data length from the following two choices:

- 7 bit
- 8 bit

1. Press the F3 (DATA) key, or use the ▲▼◀▶ keys to move the cursor to DATA.
2. Use the rotary knob to select either 7 or 8.

### Setting the Parity Bit

Select a parity bit from the following three choices:

- NONE
- ODD
- EVEN

1. Press the F4 (PARITY) key, or use the ▲▼◀▶ keys to move the cursor to PARITY.
2. Use the rotary knob to select NONE, ODD, or EVEN.

### Setting the Stop Bit

Select a stop bit from the following two choices:

- 1 bit
- 2 bit

1. Press the F5 (STOP) key, or use the ▲▼◀▶ keys to move the cursor to STOP.
2. Use the rotary knob to select either 1 or 2.

## 4.6 Panel Memory

The tester can store up to 100 currently set test conditions in its internal memory, allowing you to store test conditions for the following six items.

- Test current
- Frequency
- Lower reference value (including ON/OFF setting)
- Upper reference value
- Timer (including ON/OFF setting)
- Measured offset value (including ON/OFF setting)

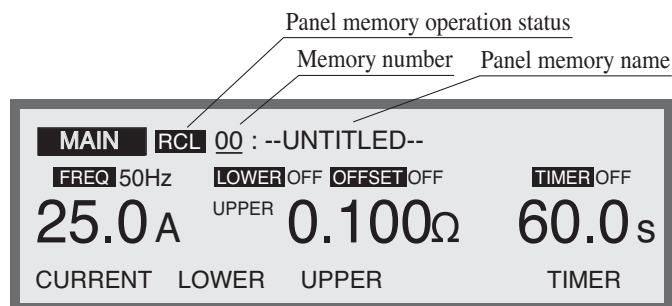

On shipment from the factory, settings corresponding to a variety of safety standards are written to memory. For these settings, see Appendix A.3, “Initial Settings of the Memory.”

### 4.6.1 Storing in the Panel Memory

#### NOTE

- To store test conditions, first determine the memory number, then enter the name as shown below. Moving the cursor to the memory number after setting a name restores the entered name to the previous name.

1. Press the MAIN key to display the MAIN screen and set test conditions.
2. Press the RECALL/STORE key with the SHIFT key held down. This displays the indication "STO \*\*: --UNTITLED--" to the right of the screen title.
3. Use the rotary knob to set the memory number (from 00 to 99) to which test conditions are to be stored.
4. Press the ► key to move the cursor to "--UNTITLED--".
5. Use the rotary knob to enter a memory name.  
ASCII code characters from 20 H to 7EH are valid. (See Appendix A.2.)

6. Press the ENTER key to store the test conditions to this memory number.

After the conditions are stored, the letters "STO" will change on the LCD to "MEM."

Moving the cursor to another area before pressing the ENTER key will abort the storage operation.

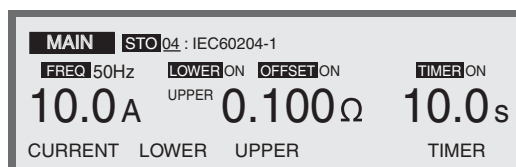

## 4.6.2 Recalling the Panel Memory

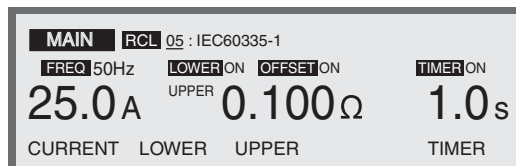

1. Press the RECALL key to display "RCL memory number: memory name" to the right of the screen title.
2. Use the rotary knob to specify the memory number to be recalled (00 to 99).
3. Press the ENTER key. This recalls the test conditions for that memory number.

Moving the cursor to another area of the screen before pressing the ENTER key aborts the recall operation. Modifying the test conditions recalled causes the memory number to disappear. It will not be redisplayed even if the original test conditions are restored.

## 4.7 Program

A combination of test conditions stored in memory allows you to set 100 programs. Up to 100 steps may be set as a single program. Note that the number of steps that can be set for programs is up to 500 in total. For additional information on memory, see 4.6, "Panel Memory."

Press the AUTO key to turn on the AUTO key LED and display the program screen (AUTO).

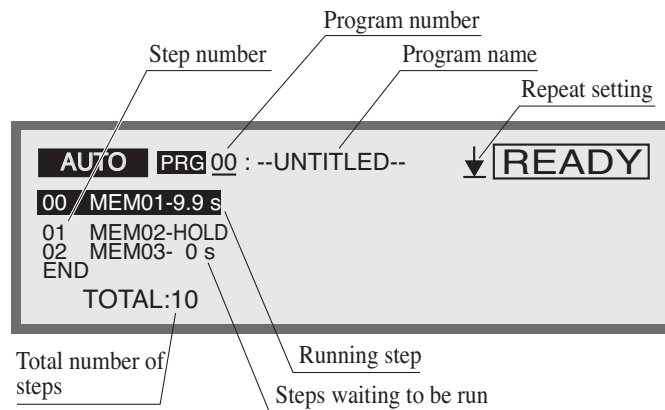

### Program example:

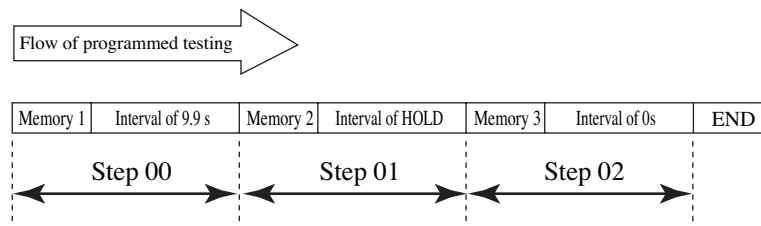

Enter the following settings to create a program like the one above:

```
00 MEM01-9.9 s
01 MEM02-HOLD
02 MEM03-0s
END
```

### Description of the program example:

The program performs a test of memory 01 in step 00 and then that of memory 02 in step 01 9.9 seconds after that. Because the interval time of step 01 is set to HOLD, the test of memory 3 in step 02 does not start unless you press the START switch. After the START switch is pressed and the test in step 02 is complete, the tester enters the ready status.

Replacing END at the end of the program with RET instructs the program to repeat testing from step 00.

## 4.7.1 Recalling the Program

Use the rotary knob to specify the program number to be recalled on the AUTO screen.

(A program number is displayed to indicate that the program has been called up.)

## 4.7.2 Creating or Editing the Program

Call up the number of the program you wish to create or edit in the program (AUTO) screen. Press the SHIFT + AUTO/EDIT key combination (pressing the AUTO key with the SHIFT key held down) to display the program edit screen. "EDIT" appears in the upper right portion of the LCD. Changes are saved as soon as the program is edited or created.

The program requires that the following items be set.

- Program name
- Memory number (step setting)
- Interval time
- Repeat setting

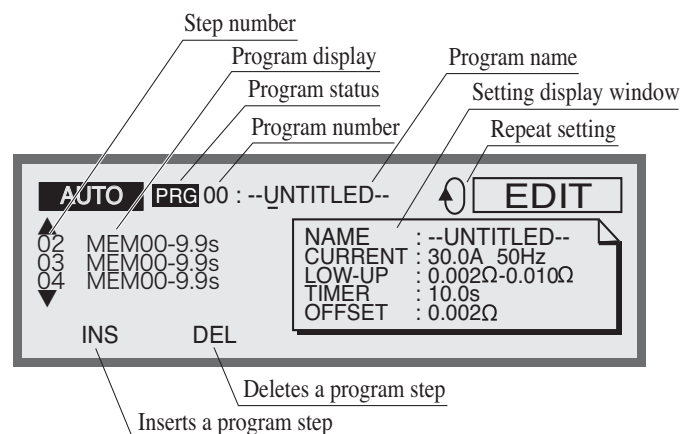

### Setting a Program Name

Enter the name of a program to create (up to 12 characters) as follows:

1. Press the SHIFT + F1 key combination (pressing the F1 key with the SHIFT key held down) to move the cursor to the program name.
2. Use the ◀ ▶ keys to move the cursor to a location below the field where a character is to be entered.
3. Use the rotary knob to select the desired characters. You can enter ASCII codes 20H to 7EH as characters (see Appendix A.2).
4. Press the SHIFT and F1 keys together to complete setting a program name.

## Setting a Memory Number and Interval

---

**NOTE**

- When TIMER in test conditions of the set memory number is set to OFF, the programmed testing is not completed. The step is completed by pressing the STOP switch, but the program cannot proceed to the next step.
- 

For each step, set the memory number of the test conditions to use and the interval time up to the next step. The program will perform testing in the order of the step numbers.

Once the cursor is positioned at the step number, scroll through values with the rotary knob. You can also scroll using the ▲▼ keys if possible regardless of cursor position.

END or RET is displayed at the end of the steps.

1. Press the SHIFT + F1 key combination (pressing the F1 key with the SHIFT key held down) to move the cursor to the step indication.
2. Move the cursor to the step immediately below the position of a step to be inserted.
3. Press the F1 (INS) key to add the step. (MEM00-1.0s is added to the end of the list.)
4. Press the ► key to move the cursor to MEM to the right of the step number.
5. Use the rotary knob to set a memory number.
6. Use the ► key to move the cursor to the interval time to the right of the memory number.
7. Use the rotary knob to set an interval time (0 to 9.9 s, HOLD).

When HOLD is specified for a certain interval time, pressing the START key while the specified step is in HOLD status starts the next step.

To delete a step, move the cursor to the appropriate step number and press the F2 (DEL) key.

To change a memory number or interval time for a step, move the cursor to the appropriate location and enter a new value with the rotary knob.

## Repeat Setting

You can set program repeat using the SHIFT + F2 key combination (pressing the F2 key with the SHIFT key held down) regardless of cursor position.

Press the SHIFT + F2 keys toggles between END and RET.

↓ END: Ends the program; the program enters ready status at the beginning of the steps.

↺ RET: Causes the program to return to the beginning of the steps and repeat the test.

### 4.7.3 Running the Program

**NOTE**

- Releasing the START switch when momentary is ON is equivalent to pressing the STOP switch. If a step interval has been set to HOLD in programmed automatic testing, the program cannot proceed to the next step.

Program execution is performed in the program screen (AUTO).

In the program screen, the cursor cannot be moved to any item other than the program number.

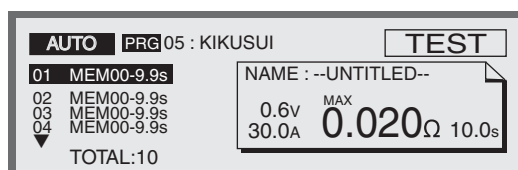

- Press the AUTO key to display the program screen (AUTO).
- Specify the number of a program to recall (run) using the rotary knob. In this case, the name of the selected program is displayed to the right of the program number.
- Press the START switch to run the program.

During the test, the tester indicates "TEST" on the upper right corner of the LCD, and the TEST LED indicator lights up. A running step will be displayed in reverse video.

### 4.7.4 Suspending the Program

Press the STOP switch to halt testing during program execution.

Press the START switch again to run the program from the beginning.

### 4.7.5 PASS/FAIL Judgment During Program Execution

#### ■ PASS judgment

PASS judgment is made with respect to the entire program only when the setting for program repeat is END.

At the end of the programmed test, the tester returns a PASS judgment and reverts to ready status.

#### ■ FAIL judgment

If the tester returns a value FAIL judgment during program execution, it halts the program. Check the step where the problem occurred and press the STOP switch.

Press the START switch to run the program again from the beginning.

### 4.7.6 Ending the Program

To exit the program mode and return to normal status, press the MAIN key.

This turns off the LED for the AUTO key and redispays the MAIN screen.

## 4.8 Key Lock

The key lock function protects accidental changing of the test conditions.

Press the SHIFT + LOCAL/KEY LOCK key combination (pressing the LOCAL key with the SHIFT key held down) to lock the panel settings.

In this case, only the START and STOP switches are available on the front panel.

When key lock is in effect, "KEY LOCK" is indicated on the LCD. To cancel key lock, press the SHIFT + LOCAL/KEY LOCK keys again.

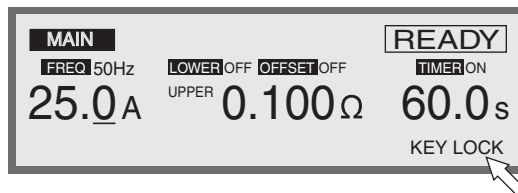

## 4.9 Checking the Test Conditions

This tester checks if the values set as the test conditions are valid or not. If an invalid value is set, the tester displays the cause of it on the LCD, informing you that testing cannot be conducted unless it is changed.

The following four causes are displayed:

LCD Indication in the Event of Invalid Setting	Cause of Invalid Value
OVER VOLT	Setting of output out of the operation range
OVER VA	
OVER RESI*	
UP <= LOW	Upper reference value $\leq$ lower reference value

\*: TOS6210 only

### 4.9.1 Setting Output out of the Operation Range

The testers meet the following test current setting range when the output is within the maximum rated output and the resistance is such that voltage at the output terminal is 5.4 V or below.

TOS6200: 3.0 A to 30.0 A AC

TOS6210: 6.0 A to 62.0 A AC

The following figures show the operation range of the testers.

If a test condition out of this range is set, the LCD displays the cause of it.



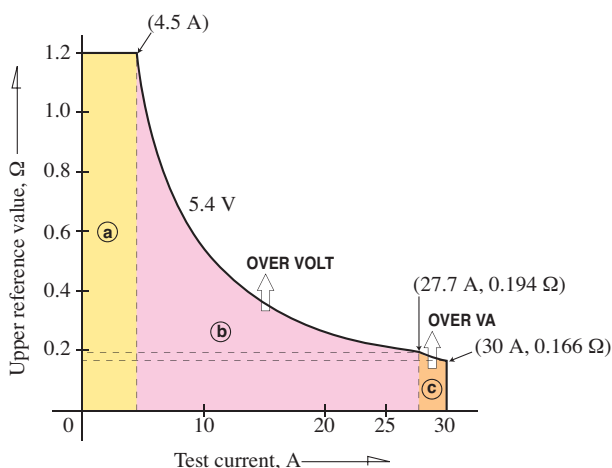

TOS6200 Operation Range

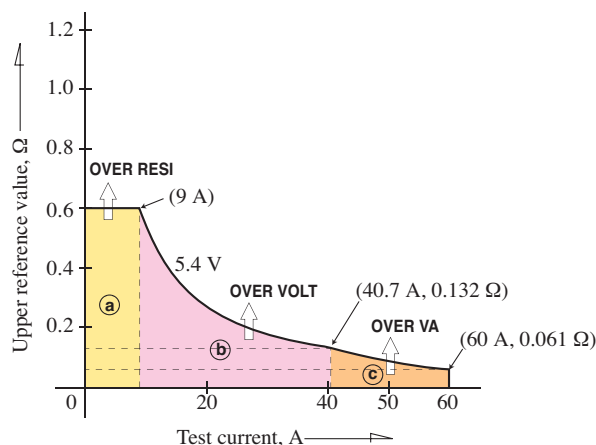

TOS6210 Operation Range

## OVER VOLT

If a setting meeting the following equation (a setting exceeding the operation range (b)) is made, the “READY” indication in the upper right of the LCD changes to blink “OVER VOLT,” informing you that testing cannot be conducted under the current conditions.

$$\text{Test current value} \times \text{upper reference value (resistance value)} > 5.4 \text{ V}$$

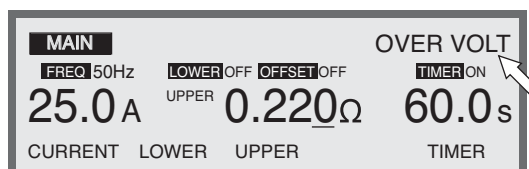

In such a case, set the test current value and upper reference value so that the setting falls within the operation range (b).

If the offset canceling function is ON, the upper reference value inclusive of the offset value is checked. If a sampled voltage value is set to the upper reference value in the TOS6210, OVER VOLT check is not performed.

## OVER VA

If a setting meeting the following equation (setting exceeding the operation range (c)) is made, the “READY” indication in the upper right of the LCD changes to blink “OVER VA,” informing you that testing cannot be conducted under the current conditions.

TOS6200

$$(\text{Test current value})^2 \times \text{upper reference value (resistance value)} > 150 \text{ VA}$$

TOS6210

$$(\text{Test current value})^2 \times \text{upper reference value (resistance value)} > 220 \text{ VA}$$

$$\text{Test current value} \times \text{upper reference value (voltage value)} > 220 \text{ VA}$$

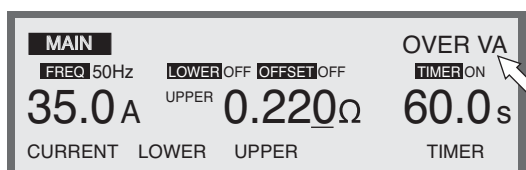

In such a case, set the test current value and upper reference value so that the setting falls within the operation range ㉔. If the offset canceling function is ON, the upper reference value inclusive of the offset value is checked.

## OVER RESI (TOS6210 only)

If a setting meeting the following equation (a setting exceeding the operation range ㉔) is made, the “READY” indication in the upper right of the LCD changes to blink “OVER RESI,” informing you that testing cannot be conducted under the current conditions.

$$\text{Upper reference value (voltage value) / test current value} > 0.6 \Omega$$

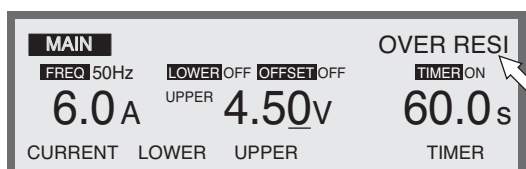

In such a case, set the test current value and upper reference value so that the setting falls within the operation range ㉔. If a resistance value is set to the upper reference value, OVER RESI check is not made.

## 4.9.2 Upper Reference Value <= Lower Reference Value (UP <= LOW)

If a lower reference value more than the upper reference value is set when lower limit judgment is ON, the “READY” indication in the upper right of the LCD changes to blink “UP <= LOW,” informing you that testing cannot begin under the current conditions.

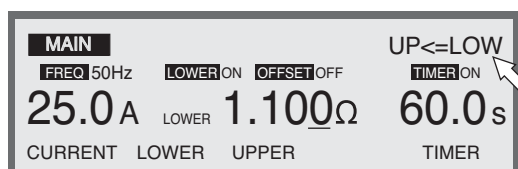

In this case, increase the upper reference value or reduce the lower reference value.

## 4.10 Protection Function

In the following five cases, the tester activates an internal protection circuit and enters protection status.

When it enters protection status, the PROTECTION LED indicator lights and the test is halted. The LCD displays the cause of bringing the tester to protection status.

LCD Indication Given in Protection Status	Cause of Bringing the Tester to Protection Status
OVER HEAT	Time limit with respect to output
	Overheat protection
OVER LOAD	Overload protection
VOLT LIMIT	Output voltage limitation
SIGNAL I/O	ENABLE signal change

### 4.10.1 Time Limitation with Respect to Output (OVER HEAT)

The heat radiation capacity at the output section of the tester is designed to be one-third of the rated output by taking into account size, weight, cost, and other factors.

Use the tester within the limitations given in the table below. If the tester is used in a way that causes the tester to exceed the limitations, the output section temperature will rise, which may cause the tester to enter protection status.

If protection status is triggered and the “OVER HEAT” indication blinks on the LCD, stop testing for approximately the pause time specified in the table below and then press the STOP key. If the output section temperature has returned to the normal level, the tester will return to ready status.

	Output Time Limitation			
	Ambient Temp. t (°C)	Test Current I (A)	Pause Time	Max. Test Time
TOS6200	At t ≤ 40°C	15 < I ≤ 30	Equal to or longer than test time	30 minutes or less
		I ≤ 15	Not required	Continuous output available
TOS6210		40 < I ≤ 60	Equal to or longer than test time	10 minutes or less
		20 < I ≤ 40	Equal to or longer than test time	30 minutes or less
		I ≤ 20	Not required	Continuous output available

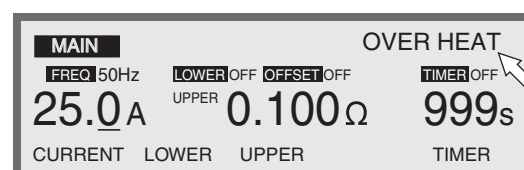
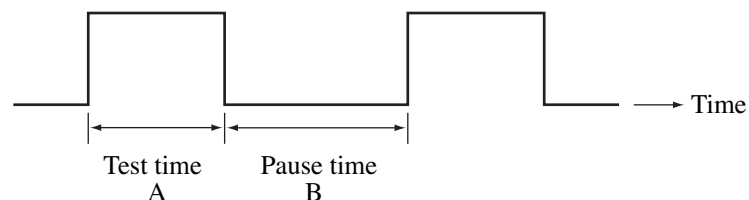

## 4.10.2 Overheating Protection (OVER HEAT)

If the tester's internal temperature rises to unusual levels due to a blocked air intake or exhaust port, broken fan, use in hot conditions, or other reasons, the overheating protection function is tripped and an "OVER HEAT" indication blinked on the LCD.

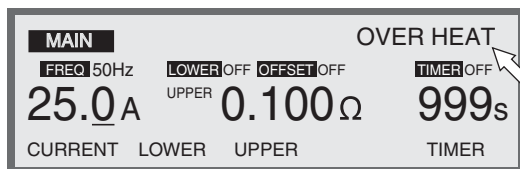

Internal temperatures will fall to normal levels in approximately 10 minutes if no parts are failure. Once temperatures return to normal, press the STOP switch to cancel overheating protection.

If the overheating protection function is set off frequently, the fan or some other unit component may be failure.

## 4.10.3 Overload Protection (OVER LOAD)

This protective function limits output power. Even for settings for which the product of the test current and upper reference value (including offset value) is 5.4 V or less and a test can be performed, the overload protection function is tripped if the output power exceeds the following maximum rated output during testing. This causes the "OVER LOAD" indication to blink on the LCD.

TOS6200: 150 VA

TOS6210: 220 VA

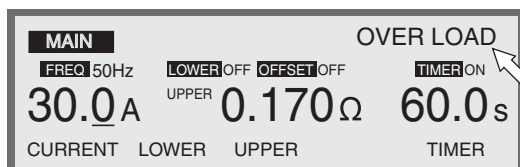

For example, when the test current of TOS6200 is 30 A, if the load resistance (including the resistance of the DUT, the test leads, and any other associated items) from the perspective of the output terminals exceeds  $0.166 \Omega (\cong 150/30^2)$ , the output power exceeds 150 VA, causing an overload. This disables testing.

Similarly, if the test current exceeds 27.7 A ( $\cong 150/5.4$ ), an overload may occur, disabling testing.

The test current and resistance to be measured should fall within the power limitations.

Press the STOP switch to cancel overload protection.

## 4.10.4 Output Voltage Limitation (VOLT LIMIT)

This protective function limits the output voltage. If the output terminal voltage exceeds 5.6 V when the measured value is not judged FAIL during a test, the output voltage limitation function is tripped and the "VOLT LIMIT" indication is blinked on the LCD.

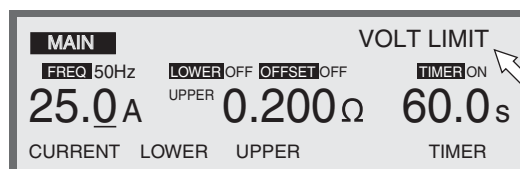

Since no test can be performed for settings for which the product of the test current and upper reference value (including offset value) exceeds 5.4 V, the output terminal voltage will generally not exceed 5.6 V and the output voltage limitation function is rarely tripped. However, for measurements using four terminals that use high-resistance lead wires, or for two-terminal measurements with the offset canceling function activated, the output terminal voltage may exceed 5.6 V in some cases, tripping this function. This causes the tester to enter protection status.

For example, assume that the DUT with 0.190 Ω is tested with the test current set to 25 A and upper reference value set to 0.200 Ω. If the leads connected to the DUT are long and four-terminal measurements are made using leads exceeding 0.034 Ω both coming and going, the combined resistance from the perspective of the output terminals becomes 0.224 Ω or greater, tripping the output voltage limit function for 5.6 V and disabling the test.

If the product of the test current and a combined resistance from the perspective of the output terminals is closer to 5.6 V, use leads with lower resistance values.

Press the STOP switch to cancel output voltage limitation.

## 4.10.5 Change in ENABLE Signal (SIGNAL I/O)

If the level of the ENABLE signal of the SIGNAL I/O connector's pin 23 changes, the signal I/O is tripped and the "SIGNAL I/O" indication blinked on the LCD.

To clear this protection, press the STOP switch.

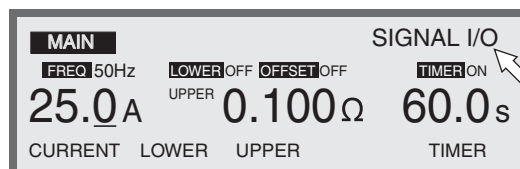

## 4.11 Initialize

**NOTE**

- Initializing clears the contents of the programs stored in memory. Before initialization, make sure that the data in memory can be erased safely.

Settings corresponding to the various safety standards are stored in memory. For information on these settings, see Appendix A.3, "Initial Settings of the Memory."

To initialize, press the POWER switch with the SHIFT key held when starting the tester. This restores tester settings to factory-set values. (Press the SHIFT key until the characters "KIKUSUI ELECTRONICS CORP." disappear.)

### ■ Factory-shipped settings

	TOS6200	TOS6210
Test conditions set up screen (MAIN)		
Test current (CURRENT)	3.0 A	6.0 A
Frequency (FREQ)	50 Hz	
Lower limit judgment (LOWER)	OFF	
Lower reference value (LOWER)	0.001 Ω	
	—	0.01 V
Upper reference value (UPPER)	0.100 Ω	
	—	0.60 V
Offset (OFFSET)	OFF	
Timer (TIMER)	OFF	
Timer set value (TIMER)	1.0 s	
Offset screen (OFFSET)		
Offset value (OFFSET)	0.000 Ω	
System screen (SYSTEM)		
MEAS MODE	NORM	
PASS HOLD	0.2 s	
MOMENTARY	OFF	
FAIL MODE	OFF	
DOUBLE ACTION	OFF	
CONTACT CHECK	OFF	
BUZZER VOL	4	
CONTRAST	6	
COMMENT	cleared	
Interface screen (INTERFACE)		
GPIB ADDRESS	3	
SPEED	19200	
DATA	8 bit	
PARITY	NONE	
STOP	2 bit	

# 5

## **Chapter 5 REMOTE and SIGNAL I/O**

Describes the REMOTE terminal (for connecting optional equipment) and the SIGNAL I/O connector (for input/output signals).

## 5.1 REMOTE Terminal

The REMOTE terminal is a 5-pin DIN connector located on the front panel.

This connector is used to connect the optional RC01-TOS or RC02-TOS remote control boxes or the LP01-TOS or LP02-TOS test probe.

When you connect an option, the START and STOP switches on the option and those on the front panel are both available.

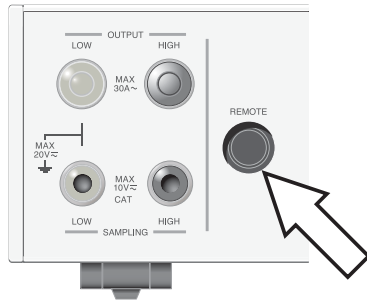

Fig.5-1 REMOTE Terminal



## 5.2 SIGNAL I/O Connector

- 
- WARNING** • To avoid electric shocks, always turn off the power supply of the related equipment when connecting or disconnecting a cable from the SIGNAL I/O connector.
- 

The SIGNAL I/O connector is a D-SUB 25-pin connector located on the rear panel used to control testing start and stop or to monitor the status of the tester.

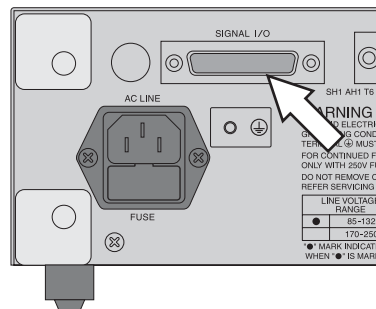

Fig. 5-2 SIGNAL I/O Connector

### Connector on the tester side

Omron Corp. XM3B-2522 D-SUB 25-pin female connector, Screw M2.6 x 0.45

### Connection cable

D-SUB 25-pin male to D-SUB 25-pin male, straight cable

### Controller-side connector

Omron Corp. XM3D-2521 D-SUB 25-pin female connector or equivalent

- 
- NOTE** • To avoid malfunctions caused by noise, use a shielded D-SUB 25-pin connector and cable less than 3 m in length.
-

## 5.2.1 SIGNAL I/O Connector Specifications

### ■ Input signal

Active-low control input

High-level input voltage: 11 to 15 V

Low-level input voltage: 0 to 4 V

Low-level input current: -5 mA maximum

Input time width: 5 ms minimum

### ■ Output signal

Open collector output

Output withstand voltage: 30 V DC

Output saturation voltage: Approximately 1.1 V (at 25°C)

Maximum output current: 400 mA (total )

### ■ Pin configuration

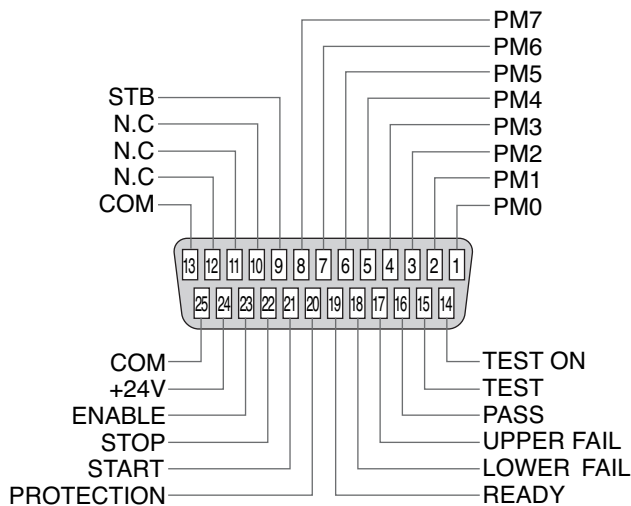

Fig. 5-3 SIGNAL I/O Pin Configuration

---

**CAUTION** • To avoid damage to internal circuits, take care to avoid short circuiting +24 V at pin 24 to the chassis or circuit common.

---

Table 5-1 SIGNAL I/O Pin Configuration

No.	Signal name	I/O	Description of signal		
1	PM0	I	LSB	LSD	2-digit BCD active-low input Panel memory or program select signal input terminal. This select signal is latched at the rise of a strobe signal to recall the panel memory or program.
2	PM1	I			
3	PM2	I			
4	PM3	I			
5	PM4	I			
6	PM5	I			
7	PM6	I			
8	PM7	I	MSB		
9	STB	I	Panel memory or program strobe signal input terminal.		
10	N.C				
11	N.C				
12	N.C				
13	COM		Circuit common		
14	TEST ON	O	ON during test.		
15	TEST	O	ON during test (not including the period of a current/voltage rise.)		
16	PASS	O	ON for approximately 0.2s or more when a measured value is judged PASS. It is continuously ON when PASS HOLD is set to ON.		
17	UPPER FAIL	O	Continuously ON if a measured value is the upper reference value or greater and judged FAIL.		
18	LOWER FAIL	O	Continuously ON if a measured value is the lower reference value or less and judged FAIL.		
19	READY	O	ON while the tester is in ready status.		
20	PROTECTION	O	ON if PROTECTION status arises.		
21	START	I	Start signal input terminal.		
22	STOP	I	Stop signal input terminal.		
23	ENABLE	I	Start signal's ENABLE signal input terminal.		
24	+24 V	O	+24V internal power output terminal. Maximum output current is 100 mA.		
25	COM		Circuit common		

## Internal configuration

The input and output signal circuits share the same common.

Because the input signal circuit is pulled up to +12 V, opening the input terminals is equivalent to inputting a high-level signal.

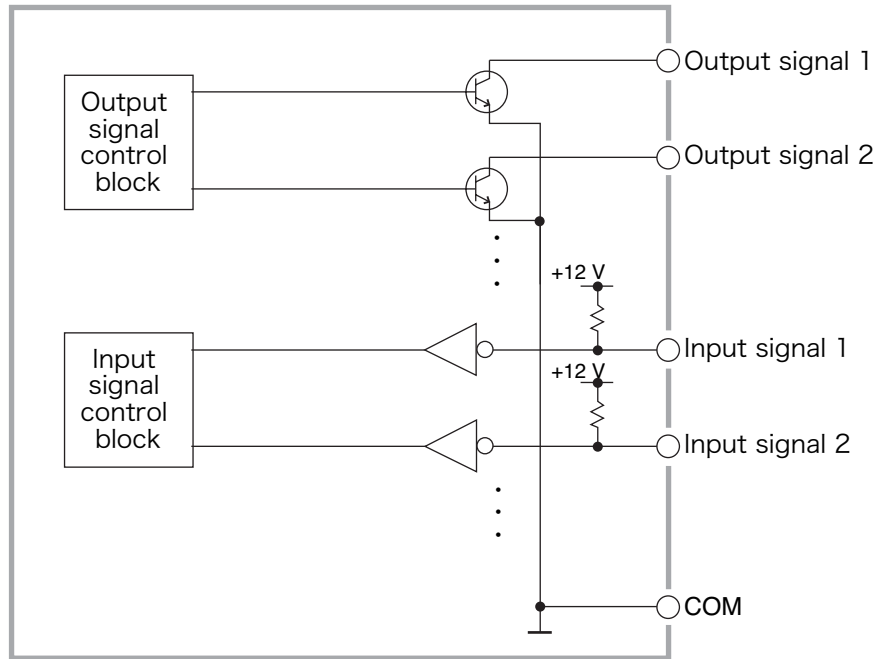

Fig. 5-4 Internal Configuration of the SIGNAL I/O Connector

## 5.2.2 Starting a Test

To start a test by using the SIGNAL I/O connector, set the ENABLE signal to a low level first. After a lapse of 10 ms or more from the READY signal has turned to a low level, set the START signal to a low level for 5 ms or more. The READY signal turns to a high level after the effective START signal has been detected.

When the ENABLE signal is the low level, the START signal for the SIGNAL I/O connector and the START input for the REMOTE terminal is enabled. At the same time, the START switch on the panel are disabled.

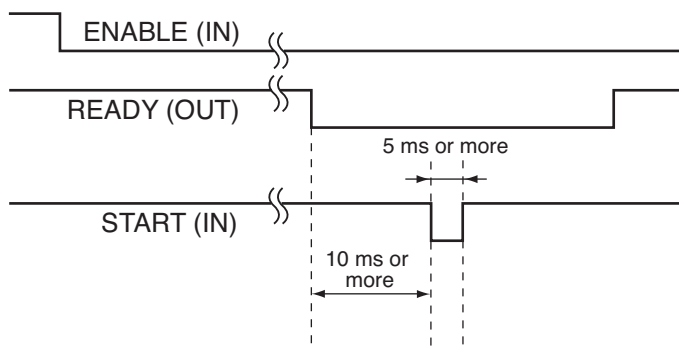

Fig. 5-5 START Signal

### 5.2.3 Recalling a Panel Memory and Program

Ready status, PM, and STB signals are handled according to the following timing. Be sure that a READY signal set LOW.

Table 5-2 gives the relation of PM0 to PM7 signals to the panel memory number or program number to be recalled:

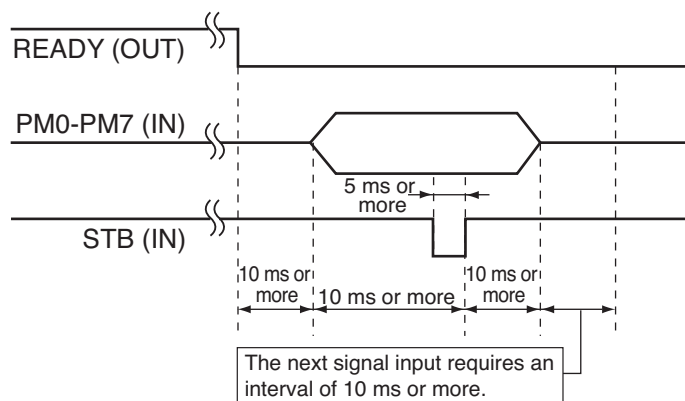

Fig. 5-6 Strobe Signal

Table 5-2 PM Signals and Panel Memory or Program Number to be Recalled

MSD				LSD				MAIN	AUTO
PM7	PM6	PM5	PM4	PM3	PM2	PM1	PM0		
H	H	H	H	H	H	H	H	Recalls panel memory 0	Recalls program 0
H	H	H	H	H	H	H	L	Recalls panel memory 1	Recalls program 1
H	H	H	H	H	H	L	H	Recalls panel memory 2	Recalls program 2
.	.	.	.	.	.	.	.	.	.
L	H	H	L	L	H	H	H	Recalls panel memory 98	Recalls program 98
L	H	H	L	L	H	H	L	Recalls panel memory 99	Recalls program 99

## 5.2.4 Examples of Use

### ■ Input signal

#### Example of control with a make contact

This example makes the input terminal level Low using a make contact such as a relay, switch, or another element.

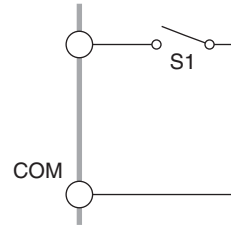

#### Example of control with logic element

This example uses a logic element such as transistors instead of a switch in the above example.

Configure the circuit so that a collector current  $i_c$  of 5 mA or greater passes through the transistor.

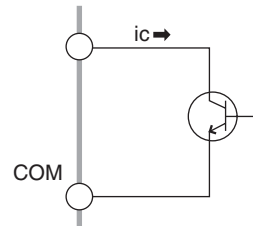

### ■ Output signal

#### Example of driving a relay

This example drives a relay with an output signal.

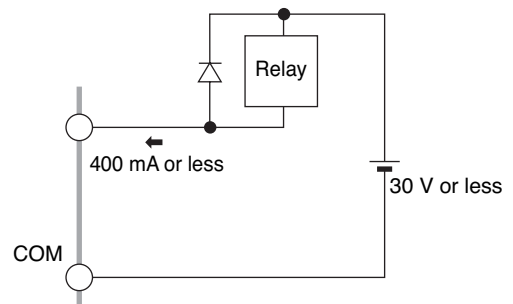

#### Example of getting the "L" level of digital signal

This example gets the "L" level of digital signal with respect to an output signal.

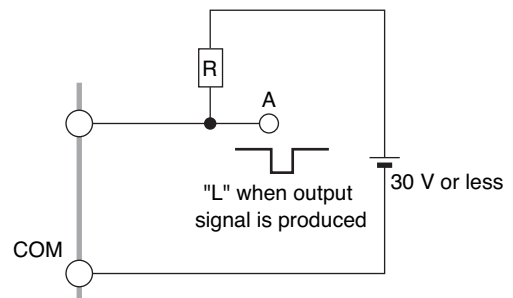

# 6

---

## Chapter 6 GPIB and RS-232C

Describes the device messages used to create a program for remote control of the tester via GPIB or RS-232C.

- 
- ⚠ WARNING** • To avoid electric shocks, always turn off the power supply of the related equipment when connecting or disconnecting a cable from the interface connector.
-

## 6.1 Interface

This tester is provided with two interfaces: GPIB and RS-232C. If the tester is to be remotely controlled, one of them must be used.

### 6.1.1 GPIB Interface

To use the GPIB interface, set a GPIB address on the tester. To set a GPIB address, see 4.5, “Interface Setup.”

GPIB cables are available from Kikusui. Contact Kikusui distributor/agent.

GPIB cable 1 m (code: 92080)

GPIB cable 2 m (code: 92070)

GPIB cable 4 m (code: 92090)

### 6.1.2 RS-232C Interface

To use the RS-232C interface, make the following settings:

For settings, see 4.5, “Interface Setup.”

- Communications rate
- Data length
- Parity bit
- Stop bit

Control communication via RS-232C using flow control or acknowledgment messages. One-way transmission may make proper communication difficult. For acknowledgment messages, see 6.2.1, “Messages.”

For an RS-232C interface cable, use a D-sub 9-pin female-female AT cross type.



## RS-232C pin configuration

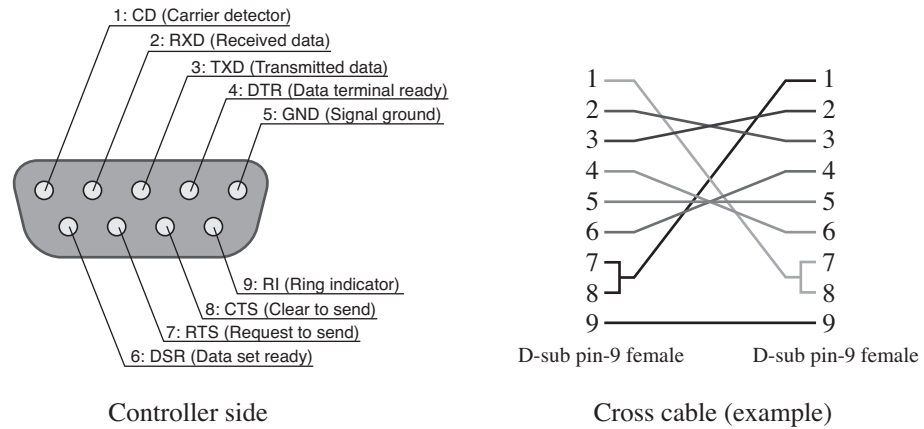

Fig.6-1 Pin-9 AT-type connector

## RS-232C flow control

By executing Xon/Xoff, communication among the tester can be controlled. For control, DC (device control) codes are used.

	Function	ASCII code
DC1	Request transmission	11 h
DC3	Request termination of transmission	13 h

### Control of transmission from the RS-232C terminal to the tester

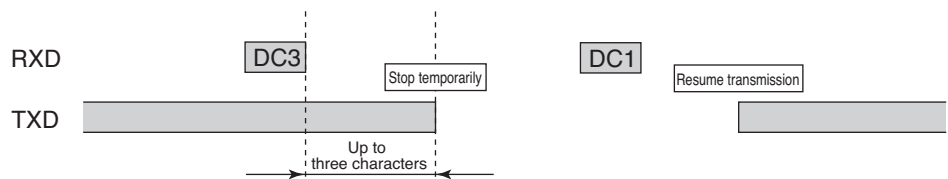

The tester temporarily stops transmission within three characters after receiving a DC3.

### Control of transmission from the tester to the RS-232C terminal

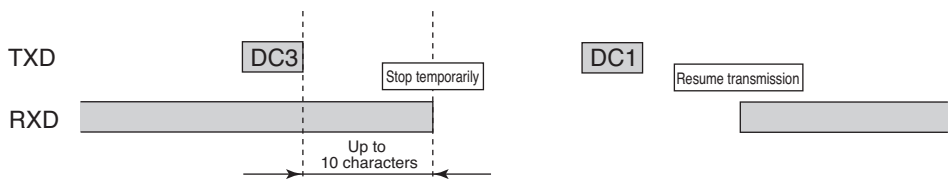

The RS-232C terminal must temporarily stop transmission within 10 characters after receiving a DC3.

Fig. 6-2 Control of transmission between the RS-232C terminal and the tester

## 6.2 Message and Terminator

This section provides terminology and details concerning communication between the personal computer (controller) and the tester (devices).

### 6.2.1 Messages

Information sent and received between the controller and the device is referred to as a “device message.” Device messages include commands sent from the controller to the device and responses sent from the device to the controller.

Each message consists of a message header and data sections.

#### Command

Commands include settings and queries.

##### Setting

Used to execute a specified function of a device and to alter settings.

##### Query

Used to inquire about the settings and status of a device.

A query ends its message with the question mark (?) at the end.

#### Response

Messages sent from the device to the controller or another device are responses.

A response tells the controller the status of the device or a measured value.

## Writing messages

- Provide a space (ASCII: 20h) between the message header and the data.

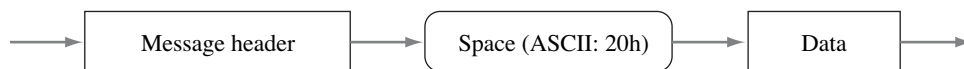

- When there is more than one piece of data, connect them using “;” (ASCII: 2Ch).

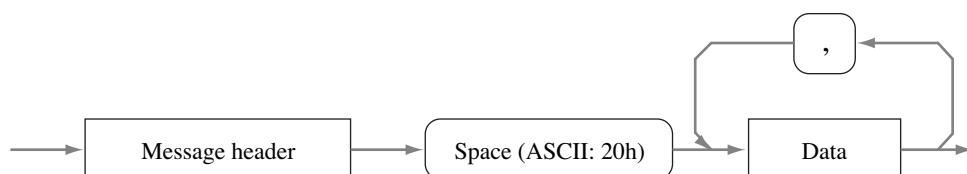

- To connect one message to another, use “;” (ASCII: 3Bh).

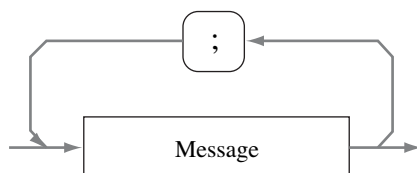

### NOTE

- To describe data using hexadecimal numbers, add “#H.”  
Example: To describe the decimal number “10” using a hexadecimal number, write “#H0A.”
- When “@” is added to the end of a message, the hold-off status is retained until execution of the message is completed.  
However, in the event of a message terminator with only EOI, use '@@'.

## Acknowledgment messages (RS-232C)

The acknowledgment message is peculiar to the RS-232C interface. This message is sent from the tester to a controller. It indicates that a program message has been processed.

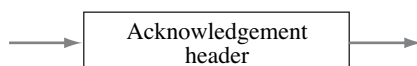

An acknowledgment message is a character string of ASCII code which is composed only of a header. There are two types such messages:

- OK: Normally terminated
- ERROR: Abnormality occurring, such as a syntax error

Through the use of a SILENT command, it can be specified whether to return an acknowledgment message.

## 6.2.2 Terminator

A terminator indicating the end of a message is called a “command terminator.” A terminator indicating the end of a response is referred to as a “response terminator.”

### Command terminators

One of the following may be used. No preliminary settings are required.

- LF
- LF+EOI
- EOI
- CR+EOI

### Response terminators

CR+LF+EOI is set by default. Using a TRM command message, it can be changed to one of the following:

- CR+LF+EOI
- LF+EOI
- EOI
- CR+EOI

## 6.2.3 Special Symbols and Characters

The special symbols and characters used throughout this manual for describing messages are defined as follows:

Symbol/Character	Description
<>	A character string within these brackets represents program data. Do not use these brackets when writing comments.
{ }	Characters or numbers separated by “ ” within these brackets indicate that you can choose between/among them. Do not use these brackets when writing comments.
<NR1>	This represents an integer. It is described in “IEEE Standards 488.2 Standard Digital Interface for Programmable Instrumentation” in detail.
<NR2>	This represents a real number. It is described in “IEEE Standards 488.2 Standard Digital Interface for Programmable Instrumentation” in detail.
<NR3>	This represents an exponent. It is described in “IEEE Standards 488.2 Standard Digital Interface for Programmable Instrumentation” in detail.
<HEX>	This represents a hexadecimal. It is described in “IEEE Standards 488.2 Standard Digital Interface for Programmable Instrumentation” in detail.

## 6.3 Device Messages

This section describes each device message supported by the tester. An item enclosed within parentheses beside a device message name is the abbreviation of that device message.

### 6.3.1 Register-Related and General-Purpose Messages

The following describes the device messages used to set, clear, or inquire about each register and general-purpose device messages used to specify of a terminator and other items.

#### **\*CLS**

Clears of the status byte register, event status register, device status register, protection register, fail register, invalid setting register and error register.

For details on each register, see 6.4, “Registers.”

#### **Message**

Setting:                   \*CLS

#### **\*ESR?**

Returns the value of the event status register, then clears it.

For details on the event status register, see 6.4, “Registers.”

#### **Message**

Query:                    \*ESR?

#### **Response**

Returns the contents of the event status register to \*ESR?.

(Example) If Bit 5 of the event status register is set, “32” is returned.

## \*IDN?

Inquiries about the model name and firmware version of the tester.

### Message

Query: \*IDN?

### Response

Returns the model name of the tester to \*IDN? in the following manner:

KIKUSUI ELECTRONICS CORP., TOS6200, 0, 1.00

Company name      Model name      Serial No. (not used)      Version No.

## \*RST

Initializes the tester (to original factory-set settings). Note that settings in the INTERFACE screen will not be initialized.

For details on initializes, see 4.11, “Initialize”

### Message

Setting: \*RST

## \*SRE

Used to set or reset each bit of the service request enable register.

Also used to inquire about the contents of the service request enable register.

For details on the service request enable register, see 6.4, “Registers.”

### Message

Setting: \*SRE <NR1>

\*SRE <HEX>

Query: \*SRE?

Program data

Set value: 0 to 255 (default is 112)  
00H to FFH (default is 70H)

Resolution: 1

(Example) \*SRE #H01

### Response

Returns the contents of the service request enable register to \*SRE?.

(Example) If Bit 5 of the service request enable register is set, “32” is returned.

## \*STB?

Used to inquire about the contents of the status byte register.  
For details on the status byte register, see 6.4, “Registers.”

### Message

Query:                   \*STB?

### Response

Returns the contents of the status byte register to \*STB?.  
(Example) If Bit 4 of the status byte register is set, “16” is returned.

## CLR

Clears the all registers exclusive of enable register and sets STOP flag.  
The same processing is performed as when the GPIB bus line message DCL or SDC has been received. Also used to perform the same processing as is performed by a DCL message from the RS-232C.

### Message

Set value:               CLR

## DSE

Used to set or reset each bit of the device status enable register.  
Also used to inquire about the contents of the device status enable register.  
For details on the device status enable register, see 6.4, “Registers.”

### Message

Setting:                 DSE <NR1>  
                           DSE <HEX>

Query:                   DSE?

Program data

Set value:               0 to 255     (default is 128)  
                           00H to FFH (default is 80H)

Resolution:             1

(Example) DSE #H01

### Response

Returns the contents of the device status enable register to DSE?.  
(Example) If Bit 5 of the device status enable register is set, “32” is returned.

## DSR?

Used to inquire about the contents of the device status register.  
For details on the device status register, see 6.4, “Registers.”

### Message

Query:                    DSR?

### Response

Returns the current test status in response to DSR?.

1	Ready	8	Test on	64	Stop
2	Inv Set	16	Pass	128	Protection
4	Test	32	Fail		

(Example) When the current status is ready  
A value of 1 is returned.

(Example) When a test is being made  
A value of 12 is returned. (4:Test + 8:Test on)

(Example) When contact check is ON  
A value of 8 is returned.

## ERR?

Used to inquire about the contents of the error register.  
For details on the error register, see 6.4, “Registers.”

### Message

Query:                    ERR?

### Response

Returns the contents of the error register to ERR?.

(Example) If Bit 1 of the error register is set, “2” is returned.



## FAIL?

Used to inquire about the contents of the fail register.

For details on the fail register, see 6.4, “Registers.”

### Message

Query:               Fail?

### Response

Returns the contents of the fail register to FAIL?.

(Example) If Bit 2 (UPPER FAIL) of the fail register is set, “4” is returned.

## INVALID? (INV?)

Used to inquire about the contents of the invalid setting register.

For details on the invalid setting register, see 6.4, “Registers.”

### Message

Query:               INV?

### Response

Returns the contents of the invalid setting register to INV?.

(Example) If Bit 0 (OVER VOLT) of the invalid setting register is set, “1” is returned.

## PROTECTION? (PROT?)

Used to inquire about the contents of the protection register.

For details on the protection register, see 6.4, “Registers.”

### Message

Query:               PROT?

### Response

Returns the contents of the protection register to PROT?.

(Example) If Bit 2 (OVER LOAD) of the protection register is set, “4” is returned.

## SILENT (SIL)

Used in control via RS-232C to specify whether to return an acknowledgment message to a message divided by the response terminator. Also used to inquire about the set value that specifies whether to return an acknowledgment message.

As an acknowledgment message, either “OK” or “ERROR” is returned.

If an acknowledgment message is to be received, the RS-232C must be set at full duplex communication.

Full duplex communication: The transmission of data in two directions simultaneously. For full duplex settings, see the manual for your PC.

### Message

Setting:	SIL	{ 0   1 }
Query:	SIL?	
Program data		
Set value:	0	Return an acknowledgement message.
	1	Do not return an acknowledgement message (default).

### Response

The set value for the SILENT message is returned to SIL?.

(Example) If settings are made so that an acknowledgment message will not be returned, the message “1” is returned.

## TRM

Used to set the response terminator, then inquire about the set value it. Note that the GPIB uni-line message “EOI” is effective only in GPIB communication.

### Message

Setting:	TRM	{ 0   1   2   3 }
Query:	TRM?	
Program data		
Set value:	0	CR/LF + EOI (default)
	1	LF + EOI
	2	EOI
	3	CR + EOI

### Response

The response terminator currently set is returned to TRM?.

(Example) If the response terminator is set at LF+EOI, the message “1” is returned.

## 6.3.2 System-Related Messages

This subsection explains the device messages for items to be set on the tester SYSTEM screen.

### BUZZERVOL (BVOL)

Sets or inquires about the buzzer volume.

#### Message

Setting: BVOL <NR1>

Query: BVOL?

Program data

Set value: 1 to 10 (default is 4)

Resolution: 1

(Example) BVOL 2

#### Response

Returns the buzzer set volume in response to BVOL?.

(Example) When the volume is set to 3

A value of 3 is returned.

## COMMENT (COM)

Inputs comments or inquires about its contents.

This message is cleared by the \*RST command.

### Message

Setting: COM "<DATA>" , "<DATA>" , "<DATA>"

Query: COM?

Program data

Set value: 20, maximum number of characters

ASCII code 20H to 7EH

22H ("), 27H ('), 2CH (,), and 40H (@) cannot be used.

For more information, see A.2, "ASCII Codes 20H to 7EH."

(Example) COM "KIKUSUI" , "TOS6210" , "!#\$%&()\*+ "

### Response

Returns the contents of the comments in response to COM?.

This fills blank entries with spaces so that each line has 20 characters, then returns this as the result.

(Example) If "KIKUSUI" is entered in the 1st line, no data is entered in the 2nd line, and "123456789ABCDEFGHIJK" is in the 3rd line, the response message returns the following result: (\_ = space)

```
KIKUSUI _____ , _____ , 1
23456789ABCDEFGHIJK
```

## CONTACTCHECK (CCH)

Sets the contact check function to ON/OFF, or inquires about its ON/OFF status.

### Message

Setting: CCH { 0 | 1 | OFF | ON }

Query: CCH?

Program data

Set value: 0, OFF      Contact check function OFF (default)

1, ON          Contact check function ON

### Response

Returns the ON/OFF status of the contact check function in response to CCH?.

(Example) When the contact check function is ON

A value of 1 is returned.

## CONTRAST (CON)

Sets the contrast or inquires about the value set for contrast.

### Message

Setting: CON <NR1>

Query: CON?

Program data

Set value: 0 to 10 (default is 6)

Resolution: 1

(Example) CON 5

### Response

Returns the set value of contrast in response to CON?.

(Example) When contrast is set to 3  
A value of 3 is returned.

## DOUBLEACTION (DAC)

Sets ON/OFF for start double action or inquires about ON/OFF status.

### Message

Setting: DAC { 0 | 1 | OFF | ON }

Query: DAC?

Program data

Set value: 0, OFF Start double action OFF (default)

1, ON Start double action ON

(Example) DAC 0

### Response

Returns the set value of start double action in response to DAC?.

(Example) When the start double action has been set to ON  
A value of 1 is returned.

## FAILMODE (FMOD)

Sets ON/OFF for the fail mode or inquires about ON/OFF status.

### Message

Setting:	FMOD	{ 0   1   OFF   ON }
Query:	FMOD?	
Program data		
Set value:	0, OFF	Fail mode OFF (default)
	1, ON	Fail mode ON

### Response

Returns the ON/OFF status of the fail mode in response to FMOD?.

(Example) When fail mode is ON

A value of 1 is returned.

## MEASMODE (MMOD)

Sets or inquires about the measurement mode.

### Message

Setting:	MMOD	{ NORM   MAX }
Query:	MMOD?	
Program data		
Set value:	NORM	Normal measurement mode (NORMAL) (default)
	MAX	Measurement mode that holds the maximum value

### Response

Returns the measurement mode in response to MMOD?.

(Example) When the measurement mode is NORM

A value of NORM is returned.

## MOMENTARY (MOM)

Sets ON/OFF for the momentary or inquires about ON/OFF status.

### NOTE

- Releasing the START switch when momentary is ON is equivalent to pressing the STOP switch. If the interval of a step has been set to HOLD in a programmed automatic test, the program cannot proceed to the next step.

### Message

Setting: MOM {0 | 1 | OFF | ON}

Query: MOM?

### Program data

Set value: 0, OFF      Momentary OFF (default)  
1, ON              Momentary ON

### Response

Returns the ON/OFF status of the momentary in response to MOM?.

(Example) When the momentary is ON  
A value of 1 is returned.

## PASSHOLD (PHOL)

Sets the PASS hold time or inquires about the value set for PASS hold time.

### Message

Setting: PHOL {<NR2> | HOLD}

Query: PHOL?

### Program data

Set value: 0.2 to 10.0 (default is 0.2)  
HOLD      Sets the PASS hold time to HOLD.  
Resolution: 0.1  
Unit: s

### Response

Returns the set value of PASS hold time in response to PHOL?.

(Example) When the PASS hold time has been set to 2 seconds  
A value of 2.0 is returned.

(Example) When the PASS hold time has been set to HOLD  
A value of HOLD is returned.

### 6.3.3 Messages Relating to Test Conditions and Test Execution

This subsection describes device messages associated with test condition settings and testing start/stop.

#### CURRENT (CUR)

Sets the test current of the tester or inquires about its set value.

##### Message

Setting:	CUR <NR2>
Query:	CUR?
Program data	
Set value:	TOS6200 3.0 to 30.0 (default is 3.0)
	TOS6210 6.0 to 62.0 (default is 6.0)
Resolution:	0.1
Unit:	A

##### Response

Returns the set value of test current in response to CUR?.

(Example) When the set test current is 10.0 A  
A value of 10 . 0 is returned.

##### **“OVER VOLT” blinks on the LCD.**

A value obtained by multiplying the test current value by the upper reference value has exceeded 5.4 V. Test cannot begin under the current conditions. Change the setting referring to “OVER VOLT” in 4.9.1, “Setting Output out of the Operation Range.”

##### **“OVER VA” blinks on the LCD.**

The setting has exceeded the maximum rated output. Test cannot begin under the current conditions. Change the setting referring to “OVER VA” in 4.9.1, “Setting Output out of the Operation Range.”

##### **“OVER RESI” blinks on the LCD. (TOS6210 only)**

A value obtained by dividing the upper reference value by the test current value has exceeded 0.6  $\Omega$ . Test cannot begin under the current conditions. Change the setting referring to “OVER RESI (TOS6210 only)” in 4.9.1, “Setting Output out of the Operation Range.”

##### **The current value may be changed even during testing.**

To avoid rapid changes, current value must be changed by increasing or decreasing the least significant digit (the cursor is fixed at the least significant digit).

If the test current is changed when the resistance value is close to the upper reference value, a FAIL status may occur.



**“OVER LOAD” blinks on the LCD during testing.**

If the output power exceeds a maximum power rating, the power limitation safety function is tripped and protection status occurs.

Change the setting referring to “4.10.3 Overload Protection (OVER LOAD).”

**FREQUENCY (FREQ)**

Sets the test frequency or inquires about its set value.

**Message**

Setting: FREQ { 50 | 60 }

Query: FREQ?

**Program data**

Set value:	50	50 Hz (default)
	60	60 Hz

**Message**

Returns the set value of test frequency in response to FREQ?

(Example) When the test frequency is 50 Hz

A value of 50 is returned.

**RJUDGE (RJUD) (TOS6210 only)**

Sets ON/OFF of resistance value-based judgment or inquires about its ON/OFF status.

**Message**

Setting: RJUD { 0 | 1 | OFF | ON }

Query: RJUD?

**Program data**

Set value:	0, OFF	Resistance value-based judgment OFF (Sampled voltage value-based judgment)
	1, ON	Resistance value-based judgment ON (default)

**Response**

Returns the ON/OFF status of resistance value-based judgment to RJUD?.

(Example) When resistance value-based judgment is ON

“1” is returned.

**NOTE**

- RJUD ON and VJUD OFF are the same setting.  
RJUD OFF and VJUD ON are the same setting.

## VJUDGE (VJUD) (TOS6210 only)

Sets ON/OFF of sampled voltage value-based judgment or inquires about its ON/OFF status.

### Message

Setting:	VJUD	{ 0   1   OFF   ON }
Query:	VJUD?	
Program data		
Set value:	0, OFF	Sampled voltage value-based judgment OFF (Default: resistance value-based judgment)
	1, ON	Sampled voltage value-based judgment ON

### Response

Returns the ON/OFF status of sampled voltage value-based judgment to VJUD?.

(Example) When sampled voltage value-based judgment is ON  
“1” is returned.

---

**NOTE**

- RJUD ON and VJUD OFF are the same setting.  
RJUD OFF and VJUD ON are the same setting.
- 

## LOWER (LOW)

Sets a resistance value-based lower reference value and ON/OFF of the lower limit judgment function or inquires about the ON/OFF status of the lower limit judgment function.

When you perform sampled voltage value-based judgment in TOS6210, use of this setting command causes resistance value-based judgment to be automatically selected.

### Message

Setting:	LOW	<NR2>, { 0   1   OFF   ON }
Query:	LOW?	
Program data	<NR2>	Lower reference value
Set value:	0.001 to 1.200 (TOS6200) (default is 0.001)	0.001 to 0.600 (TOS6210) (default is 0.001)
Resolution:	0.001	
Unit:	OHM	
Program data	{ 0   1   OFF   ON }	Lower limit judgment function
Set value:	0, OFF	Lower limit judgment function OFF (default)
	1, ON	Lower limit judgment function ON

(Example) When the lower reference value is 0.5 Ω and the lower limit judgement is ON

LOW 0.5, 1

**Response**

Returns the lower reference value and ON/OFF status for the lower limit judgement function in response to LOW?.

(Example) When the lower reference value is 0.5  $\Omega$  and the lower limit judgement is OFF

A value of 0.500, 0 is returned.

**“UP <= LOW” blinks on the LCD.**

If a lower reference value more than the upper reference value is set when lower limit judgment is ON, the “READY” indication in the upper right of the LCD changes to blink “UP <= LOW,” informing you that testing cannot begin under the current conditions. In this case, increase the upper reference value or reduce the lower reference value.

**VLOWER (VLOW) (TOS6210 only)**

Sets a sampled voltage value-based lower reference value and ON/OFF of the lower limit judgment function or inquires about the ON/OFF status of the lower limit judgment function.

When you perform resistance value-based judgment, use of this setting command causes sampled voltage value-based judgment to be automatically selected.

**Message**

Setting:	VLOW <NR2>, {0   1   OFF   ON}	
Query:	VLOW?	
Program data	<NR2>	Lower reference value
Set value:	0.01 to 5.40 (default is 0.01)	
Resolution:	0.01	
Unit:	V	
Program data	{0 1 OFF ON}	Lower limit judgment function
Set value:	0, OFF	Lower limit judgment function OFF (default)
	1, ON	Lower limit judgment function ON

(Example) When setting the lower reference value to 3.0 V and the lower limit judgment function to ON

VLOW 3.0, 1

**Response**

Returns the lower reference value and the ON/OFF status of the lower limit judgement function to VLOW?.

(Example) When the lower reference value is 3.0 V and the lower limit judgment function is ON

“3.00, 0” is returned.

**“UP <= LOW” blinks on the LCD.**

If a lower reference value more than the upper reference value is set when lower limit judgment is ON, the “READY” indication in the upper right of the LCD changes to blink “UP <= LOW,” informing you that testing cannot begin under the current conditions. In this case, increase the upper reference value or reduce the lower reference value.

## UPPER (UPP)

Sets a resistance value-based upper reference value or inquires about its set value.

When you perform sampled voltage value-based judgment in TOS6210, use of this setting command causes resistance value-based judgment to be automatically selected.

### Message

Setting: UPP <NR2>

Query: UPP?

### Program data

Set value: 0.001 to 1.200 (TOS6200) (default is 0.001)

0.001 to 0.600 (TOS6210) (default is 0.001)

Resolution: 0.001

Unit: OHM

### Response

Returns the upper reference value to UPP?

(Example) When the upper reference value is 0.1  $\Omega$

“0.100” is returned.

### “UP <= LOW” blinks on the LCD.

If an upper reference value less than the lower reference value is set when lower limit judgment is ON, the “READY” indication in the upper right of the LCD changes to blink “UP <= LOW,” informing you that testing cannot begin under the current conditions. In this case, increase the upper reference value or reduce the lower reference value.

### “OVER VOLT” blinks on the LCD.

A value obtained by multiplying the test current value by the upper reference value has exceeded 5.4 V. Test cannot begin under the current conditions. Change the setting referring to “OVER VOLT” in 4.9.1, “Setting Output out of the Operation Range.”

### “OVER VA” blinks on the LCD.

The setting has exceeded the maximum rated output. Test cannot begin under the current conditions. Change the setting referring to “OVER VA” in 4.9.1, “Setting Output out of the Operation Range.”

### “OVER LOAD” blinks on the LCD during testing.

If the output power exceeds a maximum power rating, the power limitation safety function is tripped and protection status occurs.

Change the setting referring to 4.10.3, “Overload Protection (OVER LOAD).”

## VUPPER (VUPP) (TOS6210 only)

Sets a sampled voltage value-based upper reference value or inquires about its set value.

When you perform resistance value-based judgment, use of this setting command causes sampled voltage value-based judgment to be automatically selected.

### Message

Setting: VUPP <NR2>  
Query: VUPP?

### Program data

Set value: 0.01 to 5.40 (default is 0.60)  
Resolution: 0.01  
Unit: V

### Response

Returns the upper reference value to UPP?.

(Example) When the upper reference value is 0.6V  
“0.60” is returned.

### “UP <= LOW” blinks on the LCD.

If an upper reference value less than the lower reference value is set when lower limit judgment is ON, the “READY” indication in the upper right of the LCD changes to blink “UP <= LOW,” informing you that testing cannot begin under the current conditions. In this case, increase the upper reference value or reduce the lower reference value.

### “OVER VA” blinks on the LCD.

The setting has exceeded the maximum rated output. Test cannot begin under the current conditions. Change the setting referring to “OVER VA” in 4.9.1, “Setting Output out of the Operation Range.”

### “OVER RESI” blinks on the LCD. (TOS6210 only)

A value obtained by dividing the upper reference value by the test current value has exceeded 0.6  $\Omega$ . Test cannot begin under the current conditions. Change the setting referring to “OVER RESI (TOS6210 only)” in 4.9.1, “Setting Output out of the Operation Range.”

### “OVER LOAD” blinks on the LCD during testing.

If the output power exceeds a maximum power rating, the power limitation safety function is tripped and protection status occurs.

Change the setting referring to 4.10.3, “Overload Protection (OVER LOAD).”

## OFFSET (OFF)

Sets ON/OFF for offset cancel function or inquires about ON/OFF status.

### Message

Setting:	OFF	{ 0   1   OFF   ON }
Query:	OFF?	
Program data		
Set value:	0, OFF	Offset cancel function OFF (default)
	1, ON	Offset cancel function ON

### Response

Returns the ON/OFF status of the offset cancel function in response to OFF?.

(Example) When offset cancel function is ON

A value of 1 is returned.

## TIMER (TIM)

Sets or inquires about the test time and the timer ON/OFF setting.

### Message

Setting:	TIM <timer> ,	{ 0   1   OFF   ON }
Query:	TIM?	
Program data	<timer NR2>	Test time
Set value:	0.3 to 999	(default is 1.0)
Resolution:	0.3 to 99.9	0.1
	100 to 999	1
Unit:	s	
Program data	{ 0   1   OFF   ON }	Timer function's ON/OFF
Set value:	0, OFF	Timer function OFF (default)
	1, ON	Timer function ON

Even when the timer function is set to OFF, you must enter a test time.

In this case, enter any value (Example: maximum value).

(Example) TIM 999,0

### Response

Returns the test time and ON/OFF status for the timer function in response to TIM?.

(Example) When the test time is 60 s and the timer function is ON

A value of 60.0,1 is returned.

---

## START(STAR)

Starts testing. While a test program is running, it shifts the program from the step suspended due to a HOLD setting in the interval to the next step.

This command message is valid only in the test conditions set up (MAIN), offset measurement (OFFSET), or program (AUTO) screens. Switch screens using the FUNCTION message.

### Message

Setting: STAR

## STOP

Stops a test or cancels fail, pass (hold) and protection status.

### Message

Setting: STOP

## 6.3.4 Messages Relating to the Tester Status

This subsection describes device messages used to check the status of the tester or measured values.

### FUNCTION (FUN)

Shifts the LCD to each mode (setting screen) or inquires about the current mode (displayed screen).

#### Message

Setting:	Fun{ 0   1   2   3   4 }
Query:	FUN?
Program data	
Set value:	0            Test conditions setup screen (MAIN)
	1            Program screen (AUTO)
	2            Program edit screen (AUTO EDIT)
	3            System setup screen (SYSTEM1)
	4            Offset screen (OFFSET)
	5            Those other than 1 to 4 above (not available)

#### Response

Returns the current mode (displayed screen) in response to FUN?.

(Example) When the current mode (displayed screen) is any figure other than 0 to 4  
A value of 5 is returned.

### IDATA? (IDAT?)

Inquires about the present measured current value.

#### Message

Query:            IDAT?

#### Response

Returns the present measured current value in response to IDAT?

It returns the current value being measured during a test or the measured current value obtained immediately before when the test was completed.

(Example) When the present measured current value is 25.0 A  
A value of 25 . 0 is returned.



## MON?

Inquires about the current monitored values.

It returns the current measured value during a test or the measured value obtained immediately before when the test was completed.

### Message

Query: MON?

### Response

Returns the monitored values of the tester in response to MON? in the following order.

#### For resistance value-based judgment

Values of device status register (DSR?)

Measured voltage value (VDATA?): unit: V

Measured current value (IDATA?): unit: A

Maximum measured resistance value (RDATA?): unit:  $\Omega$

Normal measured resistance value (RDATA?): unit:  $\Omega$

Elapsed time or Remaining time (TIME?): unit: s

Returns the elapsed time if the timer is OFF.

Returns the remaining time if the timer is ON.

(Example) When the device status register: TEST and TEST ON (bit 2, 3 are 1), measured voltage value: 4.50 V, measured current value: 25.0 A, maximum measured resistance value: 0.182  $\Omega$ , measured resistance value: 0.180  $\Omega$ , and elapsed time: 5.0 s

A value of 12, 4.50, 25.0, 0.182, 0.180, 5.0 is returned.

#### For sampled voltage value-based judgment (TOS6210 only)

Values of device status register (DSR?)

Measured resistance value (RDATA?): unit:  $\Omega$

Measured current value (IDATA?): unit: A

Maximum measured voltage value (VDATA?): unit: V

Normal measured voltage value (VDATA?): unit: V

Elapsed time or Remaining time (TIME?): unit: s

Returns the elapsed time if the timer is OFF.

Returns the remaining time if the timer is ON.

(Example) When the device status register: TEST and TEST ON (bit 2, 3 are 1), measured resistance value: 0.180  $\Omega$ , measured current value: 25.0 A, maximum measured voltage value: 4.55 V, measured resistance value: 4.50  $\Omega$ , and elapsed time: 5.0 s

A value of 12, 0.180, 25.0, 4.55, 4.50, 5.0 is returned.

## RDATA? (RDAT?)

Inquires for the present measured resistance value.

If the measurement mode is MAX in resistance value-based judgment, it returns the maximum measured resistance value.

It returns the resistance value measured during a test, or the measured resistance value obtained immediately before when the test has been completed.

### Message

Query: RDAT?

### Response

Returns the present measured resistance value in response to RDAT?

(Example) When the present measured resistance value is 0.003  $\Omega$   
A value of 0 . 003 is returned.

## TIME?

Inquires about the elapsed test time if the timer is OFF or the remaining time if the timer is ON.

### Message

Query: TIME?

### Response

Returns the elapsed or remaining time of the test in response to TIME?

(Example) When the timer function is ON and the remaining time is 10 seconds  
A value of 10 is returned.

## VDATA? (VDAT?)

Inquires for the present measured voltage value.

If the measurement mode is MAX in sampled voltage value-based judgment, it returns the maximum measured voltage value. (TOS6210 only)

It returns the voltage value measured during a test, or the measured voltage value obtained immediately before when the test has been completed.

### Message

Query: VDAT?

### Response

Returns the present measured voltage value in response to VDAT?

(Example) When the present measured voltage value is 3.50 V  
A value of 3 . 50 is returned.

## 6.3.5 Memory-Related Messages

This subsection describes device messages associated with memory for test conditions and their storage in memory.

On shipment from the factory, settings corresponding to various safety standards are written to memory. For information on these settings, see Appendix A.3, "Initial Settings of the Memory."

### MEMORY (MEM)

Sets memory contents according to resistance value-based judgment or inquires about memory contents.

#### Messages

Setting: MEM <memory no.>, "<memory name>," <test current value>, <upper reference value>, <lower reference value>, <test time>, <test frequency>, <lower limit judgment>, <offset>, <timer>

Query: MEM? <memory no.>

Program data Sets the memory contents in the following order.

Parameter	Set value		Resolution	Unit	
	TOS6200	TOS6210			
Memory no.	0 to 99		1		<NR1>
Memory name*1	20H to 7EH				ASCII code, maximum number of characters: 12
Test current value	3.0 to 30.0	6.0 to 62.0	0.1	A	<NR2>
Upper reference value	0.001 to 1.200	0.001 to 0.600	0.001	OHM	<NR2>
Lower reference value	0.001 to 1.200	0.001 to 0.600	0.001	OHM	<NR2>
Test time	0.3 to 99.9		0.1	s	<NR2>
	100 to 999		1	s	
Test frequency	50, 60			Hz	
lower limit judgment	0, OFF				OFF of lower limit judgment
	1, ON				ON of lower limit judgment
Offset	0, OFF				OFF of offset
	1, ON				ON of offset
Timer	0, OFF				OFF of timer
	1, ON				ON of timer

\*1: 22H "", 27H "", 2CH "", and 40H "@" may not be used.

#### NOTE

- All parameters must be entered, even when the lower limit judgment is set to OFF. Enter any value into the lower reference value field (the minimum value, for example).

(Example) To set memory name TEST1, test current 10 A, upper reference value 0.100 Ω, lower reference value 0.001 Ω, test time 0.3 s, test frequency 50 Hz, lower limit judgment OFF, offset OFF, and timer OFF to memory no. 01:  
**MEM 1, "TEST1", 10.0, 0.100, 0.001, 0.3, 50, 0, 0, 0**

### Response

Returns the memory contents in response to MEM? <memory no.>

(Example) When memory contents 10 is memory name TEST1, test current 30.0 A, upper reference value 1.200 Ω, lower reference value 0.001 Ω, test time 999 s, test frequency 50 Hz, lower limit judgment ON, offset ON, and timer ON in "MEM? 10"

A value of the TEST1, 30.0, 1.200, 0.001, 999, 50, 1, 1, 1 is returned.

## VMEMORY (VMEM) (TOS6210 only)

Sets memory contents in sampled voltage value-based judgment.

### NOTE

- VMEMORY (VMEM) has no query.  
 To inquire about the memory contents set using VMEM, use MEMORY? (MEM?). In this case, the voltage value is returned to the upper and lower reference values.

### Messages

Setting: VMEM <memory no.>, "<memory name>," <test current value>, <upper reference value>, <lower reference value>, <test time>, <test frequency>, <lower limit judgment>, <offset>, <timer>

Program data: Set the memory contents in the following order.

Parameter	Set value	Resolution	Unit	
Memory no.	0 to 99	1		<NR1>
Memory name *1	20H to 7EH			ASCII code, maximum number of characters: 12
Test current value	6.0 to 62.0	0.1	A	<NR2>
Upper reference value	0.01 to 5.40	0.01	V	<NR2>
Lower reference value	0.01 to 5.40	0.01	V	<NR2>
Test time	0.3 to 99.9	0.1	s	<NR2>
	100 to 999	1	s	
Test frequency	50,60		Hz	
lower limit judgment	0,OFF			OFF of lower limit judgment
	1,ON			ON of lower limit judgment
Offset	0,OFF			OFF of offset
	1,ON			ON of offset
Timer	0,OFF			OFF of timer
	1,ON			ON of timer

\*1: 22H "", 27H "", 2CH ",", and 40H "@" may not be used.

**NOTE**

- All parameters must be entered, even when the lower limit judgment is set to OFF. Enter any value into the lower reference value field (the minimum value, for example).

(Example) To set memory name TEST1, test current 10 A, upper reference value 5.00 V, lower reference value 0.05 V, test time 0.3 s, test frequency 50 Hz, lower limit judgment OFF, offset OFF, and timer OFF to memory no. 01:

```
VMEM 1, "TEST1", 10.0, 5.00, 0.05, 0.3, 50, 0, 0, 0
```

**Response**

Returns the memory contents in response to MEM? <memory no.>

(Example) When memory contents 10 is memory name TEST1, test current 62.0 A, upper reference value 5.4 V, lower reference value 0.05 V, test time 999 s, test frequency 50 Hz, lower limit judgment ON, offset ON, and timer ON in "MEM? 10".

A value of the TEST1, 60.0, 5.40, 0.05, 999, 50, 1, 1, 1 is returned.

**RECALL (REC)**

Recalls memory contents.

**Message**

Setting: REC <NR1>

Program data

Set value: 0 to 99

Resolution: 1

(Example) REC 5

**STORE(STOR)**

Saves the present test conditions to memory.

Note that the memory name is not stored. (Memory names at storage destinations will not be changed.)

**Message**

Setting: STOR <NR1>

Program data

Set value: 0 to 99

Resolution: 1

(Example) STOR 5

## 6.3.6 Program-Related Messages

This subsection explains device messages associated with items set in the program screen (AUTO).

### PRGDEL(PDEL)

Deletes a program step.

This device message is the equivalent to the F2 (DEL) key on the program edit screen.

#### Message

Setting:	PDEL <program number>, <step number>
Program data	<program number NR1>, <step number NR1>
Set value:	0 to 99
Resolution:	1

(Example) To delete step 10 in program number 1:

```
PDEL 1,10
```

### PRGEDIT(PED)

Overwrites a currently set step with a new step, adds a step in a program, or inquires about the contents of the step.

#### Message

Setting:	PED <program number>, <step number>, <memory number>,<interval time>
Query:	PED? <program number>, <step number>
Program data	<program number NR1>, <step number NR1>, <memory number NR1>
Set value:	0 to 99
Resolution:	1
Program data	<interval time NR2>
Set value:	0 to 9.9
	HOLD      Sets the interval time to HOLD.
Resolution:	0.1
Unit:	s

**NOTE**

- All parameters must be entered. Enter even values that do not need to be changed.
- You cannot skip numbers while setting step numbers. You must either overwrite a currently set step with a new step or add it to the end of a list of steps.
- Sending a PRGEDIT (PED) command while the AUTO TEST screen is displayed automatically brings up the AUTO EDIT screen.
- Up to 500 steps can be allotted to a program. For example, if 100 steps each are allotted to programs 0 to 4, no steps can be allotted to program 5.

(Example) To assign memory number 5 to step 10 in program number 1 and set the interval time to HOLD:

```
PED 1,10,5,HOLD
```

**Response**

Returns the contents of the step in response to PED? <program number>, <step number>.

(Example) When "PED? 5,1" inquires about the contents of step 1 in program 5 and step 1 is configured as memory 11 and an interval time of 5 seconds  
A value of the 11, 5 is returned.

**PRGINS(PIN)**

Inserts a step in a program and sets a memory number for the step.  
During step insertion, the interval time is set to 1.0 s.

**Message**

Setting:	PIN <program number>, <step number>, <memory number>
Program data	<program number NR1>, <step number NR1>, <memory number NR1>
Set value:	0 to 99
Resolution:	1

**NOTE**

- You cannot skip numbers while setting step numbers. You must either insert a new step in a program or add it to the end of a list of steps.
- Up to 500 steps can be allotted to a program. For example, if 100 steps each are allotted to programs 0 to 4, no steps can be allotted to program 5.

(Example) To assign memory number 5 to step between 9 and 10 in program number 1

```
PIN 1,10,5
```

## PRGNAME(PNAM)

Assigns a name to a program (up to 12 characters), or inquires about the program name.

### Message

Setting:	PNAM <program number>,"<program name>"
Query:	PNAM? <program number>
Program data	<program number NR1>
Set value:	0 to 99
Resolution:	1
Program data	<program name>
Set value:	Maximum number of characters, 12 ASCII Code 20H to 7EH 22H "", 27H "", 2CH ",", and 40H "@" may not be used. See Appendix A.2, "ASCII Codes 20H to 7EH."

(Example) To assign a name of TEST1 to program number 1  
PNAM 1, "TEST1"

### Response

Returns the name of the program in response to PNAM? <program number>

(Example) When program 1 named TEST1 is inquired about with a "PNAM? 1"  
A value of the TEST1 is returned.

## PRGNEW (PNEW)

Clears the contents of the program corresponding to a program number.

### Message

Setting:	PNEW <NR1>
Program data	
Set value:	0 to 99
Resolution:	1

(Example) To clear the contents of program 5  
PNEW 5

## PRGRETURN (PRET)

Sets ON/OFF for the repeat setting, or inquires about its ON/OFF status. (IF RET is set to OFF, END is assigned to the end of the program.)

### Message

Setting:	PRET <program number>,{0 1 OFF ON}
Query:	PRET? <program number>



Program data	<program number NR1>	
Set value:	0 to 99	
Resolution:	1	
Program data		
Set value:	0,OFF	OFF of RET (END) : End the program
	1,ON	ON of RET: Causes the program to return to the beginning of the steps and repeat the test.

(Example) PRET 5, 1

### Response

Returns the ON/OFF setting for repeat setting in response to PRET? <program number>.

(Example) When program 5 with RET set to ON is inquired about by a "PRET? 5"  
A value of the 1 is returned.

## PRGTEST (PTES)

Recalls program contents.

### Message

Setting:	PTES <NR1>	
Program data		
Set value:	0 to 99	
Resolution:	1	

## PRGTOTAL?(PTOT?)

Inquires about the number of steps corresponding to the program number.

### Message

Query:	PTOT? <NR1>	
Program data		
Set value:	0 to 99	Program number
Resolution:	1	

### Response

Returns the number of steps in the program in response to PTOT? <NR1>.

(Example) When a program 1 with 50 steps is inquired about by a "PTOT? 1"  
A value of the 50 is returned.

The total number of steps for programs is limited to 500. To check the total number of steps, get the number of steps for each program with a PTOT? and sum the numbers of steps.

# 6.4 Registers

The following shows the structure of status data:

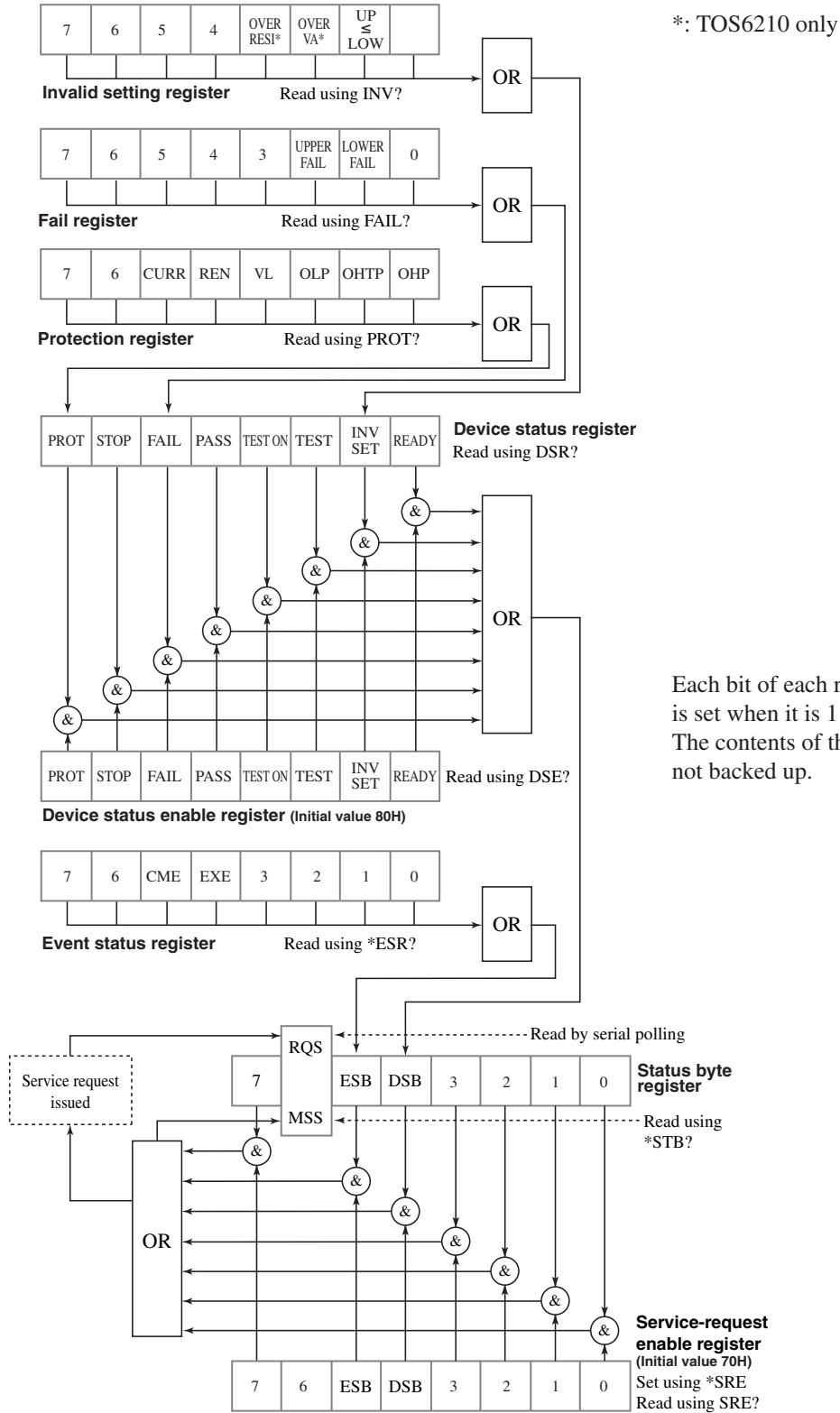

Fig. 6-3 Structure of status data

## Status Byte Register, Service Request Enable Register

Bit	Description	
7	Not used in the tester	
6	RQS(Request) MSS (Master Summary Status)	Indicates that a service request has been issued. Reset when read using a serial poll. ORed result of the status byte register and service request enable register, which is ready by running *STB.
5	ESB (Standard Event Status Bit)	Indicates that a bit of the event status register has been set.
4	DSB(Device Status Bit)	Indicates that a bit of the device status register has been set.
3		Not used in the tester
2		Not used in the tester
1		Not used in the tester
0		Not used in the tester

## Event Status Register

Bit	Description	
7	Not used in the tester	
6	Not used in the tester	
5	CME(Command Error)	Indicates that a syntax, data, or out-of-range error has occurred.
4	EXE(Execution Error)	Indicates that an invalid device message has been received during testing or while in protection status.
3		Not used in the tester
2		Not used in the tester
1		Not used in the tester
0		Not used in the tester

## Device Status Register, Device Status Enable Register

Bit	Description	
7	PROT(Protection)	Protection status
6	STOP	Stop the test
5	FAIL	FAIL judgment
4	PASS	PASS judgment
3	TEST ON	Status in which the contact check is set to ON standby and a test current flows.
2	TEST	Status in which a test current is flowing.
1	INV SET(Invalid setting)	Status in which the LCD indicates "UP $\leq$ LOW", "OVER VOLT", "OVER VA"* or "OVER RESI."*
0	READY	Ready status

\*: TOS6210 only

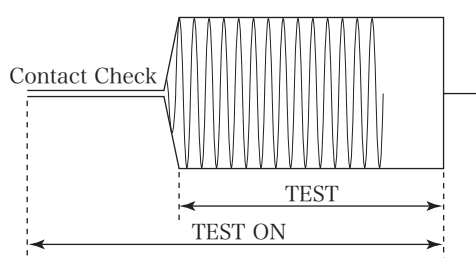

Fig. 6-4 Relation of TEST (Bit 2) to TEST ON (Bit 3)

## Protection Register

Bit	Description	
7	Not used in the tester	
6	Not used in the tester	
5	CURR(Current Error)*1	When output current is more than $\pm 10\%$ of the set value for current
4	REN(Remote Enable)	Change in the ENABLE signal of the SIGNAL I/O connector
3	VL(Voltage Limit)	Output voltage limitation (5.6 V limitation)
2	OLP(Over Load Protection)	Overload protection *2
1	OHTP(Over Heat Timer Protection)	Overheat protection *3
0	OHP(Over Heat Protection)	Overheat protection (abnormal internal temperature)

\*1: TOS6210 only

\*2: Limit based on the maximum rated output

TOS6200: 150 VA

TOS6210: 220 VA

\*3: Time limitation with respect to the output

TOS6200: 15 A for 30 minutes

TOS6210: 10 minutes for > 40 A or 30 minutes for > 20 A

## Fail Register

Bit		Description
7		Not used in the tester
6		Not used in the tester
5		Not used in the tester
4		Not used in the tester
3		Not used in the tester
2	UPPER FAIL	Indicates that the result has been judged as FAIL, exceeding the upper reference limit.
1	LOWER FAIL	Indicates that the result has been judged as FAIL, exceeding the lower reference limit.
0		Not used in the tester

## Invalid Setting Register

Bit		Description
7		Not used in the tester
6		Not used in the tester
5		Not used in the tester
4		Not used in the tester
3	OVER RESI(Over Resistance)*	Indicates that the setting exceeds the resistance measurement range.
2	OVER VA(Over Volt-Amp)*	Indicates that setting exceeds the power limit.
1	UP ≤ LOW	Indicates that the set value for lower limit judgement exceeds the upper reference value.
0	OVER V(Over Voltage)	Indicates that the test voltage has exceeded 5.4 V.

\*: TOS6210 only

## Error Register

Bit		Description
7		Not used in the tester
6		Not used in the tester
5		Not used in the tester
4		Not used in the tester
3	Invalid device message	Indicates that an invalid device message was generated.
2	Out-of-range error	Indicates occurrence of out-of-range error.
1	Data error	Indicates occurrence of data error.
0	Syntax error	Indicates occurrence of header error.

## 6.5 List of Device Messages

About 1 and 2 at the right end of the List of Device Messages

- 1: Device messages available even during testing are indicated by a check (✓); those not available are indicated by a cross (✗).
- 2: Device messages available even in the protection status are indicated by a check (✓); those not available are indicated by a cross (✗).

	Header	Data			Function and response data	1	2	
		Set value	Resolution	Unit				
1	*CLS				Clears the status byte register, event status register, device status register, protection register, fail register, invalid setting register, and error register.	✓	✓	
2	*ESR?				Returns the value of the event status register, then clears it.	✓	✓	
3	*IDN?				Returns the tester model name and ROM version.	✓	✓	
4	*RST				Initializes the tester (to factory-shipped settings. Note that interface settings are not initialized.)	✓	✓	
5	*SRE	0 to 255			Setting for the service request enable register	✗	✗	
6	*SRE?				Returns the value of the service request enable register.	✓	✓	
7	*STB?				Returns the value of the status byte register.	✓	✓	
8	BUZZERVOL (BVOL)	1 to 10	1		Setting for the buzzer volume	✗	✗	
9	BUZZERVOL? (BVOL?)				Returns the value set for the buzzer volume.	✓	✓	
10	CLR				Clears the input buffer and has it wait for a device message. Equivalent to DCL and SDC.	✓	✓	
11	COMMENT(COM)	20H to 7EH			1st comment (memo) line	ASCII codes "", "", ",", and "@" cannot be used in comments; 20 characters maximum.	✗	✗
		20H to 7EH			2nd comment (memo) line			
		20H to 7EH			3rd comment (memo) line			
12	COMMENT?				Returns the comment (memo) contents.	✓	✓	
13	CONTACTCHECK (CCH)	0 1 OFF ON			Setting for contact check. (Test starts when a load is connected.)	✗	✗	
14	CONTACTCHECK? (CCH?)				Returns the ON/OFF status for the contact check.	✓	✓	
15	CONTRAST(CON)	0 to 10	1		Setting for contrast.	✗	✗	
16	CONTRAST?(CON)				Returns the value set for contrast.	✓	✓	
17	CURRENT(CUR)	3.0 to 30.0	0.1	A	Setting for test current	✓	✗	
18	CURRENT?(CUR?)				Returns the value set for test current.	✓	✓	
19	DOUBLEACTION (DAC)	0 1 OFF ON			Setting for start double action.	✗	✗	
20	DOUBLEACTION? (DAC?)				Returns the ON/OFF status for start double action.	✓	✓	
21	DSE	0 to 255			Setting for device status enable register.	✗	✗	
22	DSE?				Returns the value of the device status enable register.	✓	✓	
23	DSR?				Returns the value of the device status register.	✓	✓	
24	ERR?				Returns the value of the error register.	✓	✓	
25	FAIL?				Returns the value of the fail register	✓	✓	

	Header	Data			Function and response data	1	2
		Set value	Resolution	Unit			
26	FAILMODE(FMOD)	0 1 OFF ON			Setting for fail mode. (To clear a FAIL or PROTECTION condition, press the STOP switch.)	X	X
27	FAILMODDE? (FMOD?)				Returns the ON/OFF status for fail mode.	✓	✓
28	FREQUENCY (FREQ)	50 60		Hz	Setting for test frequency	X	X
29	FREQUENCY? (FREQ?)				Returns the value set for test frequency.	✓	✓
30	FUNCTION(FUN)	0 1 2 3 4			Mode switching 0:MAIN 1:AUTO 2:AUTO EDIT 3:SYSTEM 1 4:OFFSET	X	X
31	FUNCTION? (FUN?)				Returns the current mode (displayed screen)	✓	✓
32	IDATA?(IDAT?)				Returns a measured current value.	✓	✓
33	INVALID?(INV?)				Returns the value of the invalid setting register.	✓	✓
34	LOWER(LOW)	0.001 to 1.200 (TOS6200) 0.001 to 0.600 (TOS6210)	0.001	OHM	Setting for the lower reference value.	X	X
		0 1 OFF ON			ON/OFF setting for the lower limit judgment function.		
35	LOWER?(LOW?)				Returns the value set for the lower reference value. Returns the ON/OFF status for the lower limit judgment function.	✓	✓
36	MEASMODE (MMOD)	NORM MAX			Setting for the measurement mode.	X	X
37	MEASMODE? (MMOD?)				Returns the setting status of the measured result indication.	✓	✓
38	MEMORY(MEM)	0 to 99	1		Memory number	X	X
		20H to 7EH			Memory name (maximum of 12 characters; ASCII codes "", "", ", ", and "@" cannot be used.)		
		3.0 to 30.0	0.1	A	Current value		
		0.001 to 1.200	0.001	OHM	Upper reference value		
		0.001 to 1.200	0.001	OHM	Lower reference value		
		0.3 to 999	0.1, 1	s	Test time Resolution: "0.1" if the set value is from 0.3 to 99.9 "1" if the set value is from 100 to 999		
		50 60		Hz	Frequency		
		0 1 OFF ON			ON/OFF for the lower reference value		
		0 1 OFF ON			ON/OFF for the offset function		
0 1 OFF ON			ON/OFF for the timer function				
39	MEMORY?(MEM?)	0 to 99	1		Reads the contents of a corresponding memory and returns the memory name, current value, upper reference value, lower reference value, test time, frequency set value, ON/OFF status for the lower limit judgment function, ON/OFF status for the offset function, and ON/OFF status for the timer function.	✓	✓

	Header	Data			Function and response data	1	2
		Set value	Resolution	Unit			
40	MOMENTARY (MOM)	0 1 OFF ON			Setting for the start momentary function.	✗	✗
41	MOMENTARY? (MOM?)				Returns the ON/OFF status for the start momentary function.	✓	✓
42	MON?				For resistance value-based judgment, returns the value of the device status register, measured voltage and current values, the peak and normal values of a measured resistance value, and elapsed (or remaining) time. For sampled voltage value-based judgment, returns the value of the device status register, measured resistance and current values, the peak and normal values of a measured voltage value, and elapsed (or remaining) time.	✓	✓
43	OFFSET(OFF)	0 1 OFF ON			ON/OFF for the offset function	✗	✗
44	OFFSET?(OFF?)				Returns the ON/OFF status for the offset function.	✓	✓
45	PASSHOLD (PHOL)	0.2 to 10 HOLD	0.1	s	Setting for PASS holding time	✗	✗
46	PASSHOLD? (PHOL?)				Returns the value set for PASS holding time.	✓	✓
47	PRGDEL(PDEL)	0 to 99	1		Program number	✗	✗
		0 to 99	1		Step number		
48	PRGEDIT(PED)	0 to 99	1		Program number	✗	✗
		0 to 99	1		Step number		
		0 to 99	1		Memory number		
		0 to 9.9 HOLD	0.1	s	Interval time up to the next step		
49	PRGEDIT?(PED?)	0 to 99	1		Program number	✓	✓
		0 to 99	1		Step number		
					Returns the contents of the step corresponding to the step number in program number.		
50	PRGINS(PIN)	0 to 99	1		Program number	✓	✓
		0 to 99	1		Step number		
		0 to 99	1		Memory number		
51	PRGNAME(PNAM)	0 to 99	1		Program number	✗	✗
		20H to 7EH			Setting for program name (maximum of 12 characters; "''", "''", " ", and "@" cannot be used.)		
52	PRGNAME? (PNAM?)	0 to 99	1		Returns the program name corresponding to the program number.	✓	✓
53	PRGNEW(PNEW)	0 to 99	1		Clears the program corresponding to the program number.	✗	✗
54	PRGRETURN (PRET)	0 to 99	1		Program number	✗	✗
		0 1 OFF ON			Setting for program return OFF, 0: END ON, 1: RET		
55	PRGRETURN? (PRET?)	0 to 99	1		Returns the setting status corresponding to the program number.	✓	✓
56	PRGTEST(PTES)	0 to 99	1		Recalls a program.	✗	✗
57	PRGTOTAL? (PTOT?)	0 to 99	1		Returns the number of steps in the program corresponding to the program number.	✓	✓
58	PROTECTION? (PROT?)				Returns the value of the protection register.	✓	✓



	Header	Data			Function and response data	1	2
		Set value	Resolution	Unit			
59	RDATA?(RDAT?)				Returns a measured resistance value.	✓	✓
60	RECALL(REC)	0 to 99	1		Recalls memory contents.	✗	✗
61	RJUDGE(RJUD) TOS6210 only	0 1 OFF ON			ON/OFF of resistance value-based judgment	✗	✗
62	RJUDGE?(RJUD?) TOS6210 only				Returns the ON/OFF status of resistance value-based judgment (TOS6210 only).	✓	✓
63	SILENT(SIL)	0 1			Switching of acknowledge message during RS-232C communications	✗	✗
64	SILENT?(SIL?)				Returns the value specified by SILENT.	✓	✓
65	START(STAR)				Starts a test.	✗	✗
66	STOP				Stops a test.	✓	✓
67	STORE(STOR)	0 to 99	1		Saves the current test conditions to memory. (Note that the memory name is not changed)	✗	✗
68	TIME?				Returns the elapsed test time when TIMER is set to OFF. Returns the remaining test time when TIMER is set to ON.	✓	✓
69	TIMER(TIM)	0.3 to 999	0.1,1	s	Setting for the test time value. Resolution: 0.1 for 0.3 to 99.9 1 for 100 to 999	✗	✗
		0 1 OFF ON			ON/OFF for the timer function		
70	TIMER?(TIM?)				Returns the test time and the ON/OFF status for the timer function.	✓	✓
71	TRM	0 to 3	1		Setting for response message terminator	✗	✗
72	TRM?				Returns a current response message terminator.	✓	✓
73	UPPER(UPP)	0.001 to 1.200 (TOS6200)	0.001	OHM	Setting for upper reference value	✗	✗
		0.001 to 0.600 (TOS6210)					
74	UPPER?(UPP?)				Returns the upper reference value.	✓	✓
75	VDATA?(VDAT?)				Returns a measured voltage value.	✓	✓
76	VJUDGE(VJUD) TOS6210 only	0 1 OFF ON			ON/OFF of sampled voltage value-based judgment	✗	✗
77	VJUDGE?(VJUD?) TOS6210 only				Returns the ON/OFF status of sampled voltage value-based judgment.	✓	✓
78	VLOWER(VLOW) TOS6210 only	0.01 to 5.40	0.01	V	Setting for lower reference value	✗	✗
		0 1 OFF ON					
79	VLOWER? (VLOW?) TOS6210 only				Returns the set value of the lower reference value and the ON/OFF status of the lower limit judgment function.	✓	✓

	Header	Data			Function and response data	1	2
		Set value	Resolution	Unit			
80	VMEMORY (VMEM) TOS6210 only	0 to 99	1		Memory number	X	X
		20H to 7EH			Memory name (ASCII codes; 12 characters maximum; “, ‘, ,, and @ are unavailable)		
		3.0 to 30.0	0.1	A	Current value		
		0.01 to 5.40	0.01	V	Upper reference value		
		0.01 to 5.40	0.01	V	Lower reference value		
		0.3 to 999	0.1, 1	s	Test time Resolution: 0.1 when the set value is 0.3 to 99.9 1 when the set value is 100 to 999		
		50 60		Hz	Frequency		
		0 1 OFF ON			ON/OFF of lower limit judgment		
		0 1 OFF ON			ON/OFF of offset		
		0 1 OFF ON			ON/OFF of timer		
81	VUPPER(VUPP) TOS6210 only	0.01 to 5.40	0.01	V	Sets the upper reference value.	X	X
82	VUPPER?(VUPP?) TOS6210 only				Returns the upper reference value.	✓	✓

## 6.6 Example Programs

This section shows remote programming examples that use GPIB or RS-232C interface.

The example programs introduced here require the following environment.

- Windows 98/NT/2000/XP and Microsoft Visual Basic (VER6.0)
- GPIB board (one of the following boards)
  - National Instruments NI-488.2M-compatible board
  - Agilent Technologies HP-IB board
  - CONTEC GPIB board
  - Interface GPIB board
- VISA (Virtual Instrument Software Architecture) library

To use VISA library with Visual Basic, the following steps are needed.

**1.** Obtain a copy of VISA library.

**KI-VISA** This library can be downloaded from the Kikusui website (<http://www.kikusui.co.jp>).

It is recommended that the TOS6200/6210 ActiveX driver also be downloaded. Note that the sample program does not use the TOS6200/6210 ActiveX driver. If you use this ActiveX driver, refer to the guidebook available at the same download page.

**NI-VISA** 2.6 or later

Agilent VISA 2.x

**2.** Install the VISA Library.

**3.** Add VISA32.BAS and VPPTYPE.BAS to your Visual Basic project. Normally these files are placed in the c:\%vxipnp%\winnt\%include folder (though winnt portion differs depending on OS version).

Although the examples use GPIB, you can replace the string passed to viOpen function with "ASRL1" or "ASRL2" to switch the programs using serial COM1 or COM2 port respectively.

## Sample program 1

This program sets test conditions for the TOS6200/6210 via the GPIB interface, performs testing, and displays test results on the message box. Commands used with the RS-232C interface are given as comments.

```
Private Sub Command1_Click()
    'Writing style is based on VISA 1.20 or 2.01
    '-----
    Dim vi As Long, tos As Long
    Dim vs As Long

    'Initialize VISA library
    vs = viOpenDefaultRM(vi)

    'Open GPIB or COM1 port for tos
    vs = viOpen(vi, "GPIB::3", vbNull, 10, tos)
    'vs = viOpen(vi, "ASRL1", vbNull, 10, tos)

    'Sets attributes if RS232
    Dim lIntfType As Long
    vs = viGetAttribute(tos, VI_ATTR_INTF_TYPE, lIntfType)
    If lIntfType = VI_INTF_ASRL Then
        vs = viSetAttribute(tos, VI_ATTR_ASRL_BAUD, 9600)
        vs = viSetAttribute(tos, VI_ATTR_ASRL_PARITY, VI_ASRL_PAR_NONE)
        vs = viSetAttribute(tos, VI_ATTR_ASRL_DATA_BITS, 8)
        vs = viSetAttribute(tos, VI_ATTR_ASRL_STOP_BITS, VI_ASRL_STOP_TWO)
        vs = viSetAttribute(tos, VI_ATTR_ASRL_FLOW_CNTRL, VI_ASRL_FLOW_XON_XOFF)
    End If

    Const DSR_READY = 1: Const DSR_INVSET = 2: Const DSR_TEST = 4: Const DSR_TESTON = 8
    Const DSR_PASS = 16: Const DSR_FAIL = 32: Const DSR_STOP = 64: Const DSR_PROTECTION = 128
    Const LOWER_FAIL = 2: Const UPPER_FAIL = 4
    Const OHP = 1: Const OHTP = 2: Const OVLD = 4: Const VL = 8
    Const REN = 16

    Dim r As Long, c As Long
    Dim strCommand As String, strRdBack As String, DSR As Integer, Result As String
    strRdBack = Space(255)

    'Device Clear
    vs = viClear(tos)

    'strCommand = "SILENT 1" + vbCrLf: vs = viWrite(tos, strCommand, Len(strCommand), r)
    'strCommand = "CLR" + vbCrLf: vs = viWrite(tos, strCommand, Len(strCommand), r)

    'FREQUENCY 50Hz,CURRENT 25A,UPPER 0.1ohm LOWER 0.015ohm ON,OFFSET OFF TOMER 60sec ON
    '-----

    strCommand = "FUNCTION 0" + vbCrLf: vs = viWrite(tos, strCommand, Len(strCommand), r)
    strCommand = "FREQ 50" + vbCrLf: vs = viWrite(tos, strCommand, Len(strCommand), r)
    strCommand = "CURRENT 25.0" + vbCrLf: vs = viWrite(tos, strCommand, Len(strCommand), r)
    strCommand = "UPPER 0.100" + vbCrLf: vs = viWrite(tos, strCommand, Len(strCommand), r)
    strCommand = "LOWER 0.015,1" + vbCrLf: vs = viWrite(tos, strCommand, Len(strCommand), r)

    strCommand = "OFFSET OFF" + vbCrLf: vs = viWrite(tos, strCommand, Len(strCommand), r)
    strCommand = "TIMER 60.0,1" + vbCrLf: vs = viWrite(tos, strCommand, Len(strCommand), r)
    strCommand = "PASSHOLD HOLD" + vbCrLf: vs = viWrite(tos, strCommand, Len(strCommand), r)
    strCommand = "DSE #HFF" + vbCrLf: vs = viWrite(tos, strCommand, Len(strCommand), r)

```

'Initializes the VISA library.

'Opens the port.  
'Opens the GPIB port. Address 3  
'Opens the COM1 port. When  
'using the RS-232C interface,  
'remove the comment from this  
'line and add it to the line  
of 'GPIB.

'Enter communication settings  
'for the RS-232C interface.

'Definition of the device  
'status register.  
'Definition of the fail register.  
'Definition of the protection  
'register.

'Device clear.  
'Device clear performed when  
'using GPIB.  
'RS-232C command.  
'The RS-232C interface uses  
'the CLR command.

'Switches to the MAIN screen.  
'Test frequency 50 Hz.  
'Test current 25.0 A.  
'Upper reference value 0.100Ω.  
'Lower reference value 0.015Ω  
, ON.  
'Offset function OFF.  
'Timer function 60.0s, ON.  
'PASS holding function HOLD.  
'Sets the device enable status  
'enable register to FFH.

<pre> Do     strCommand = "DSR?" + vbCrLf: vs = viWrite(tos, strCommand, Len(strCommand), r)     vs = viRead(tos, strRdBack, 255, c) Loop While (Val(strRdBack) &lt;&gt; DSR_READY)  strCommand = "START" + vbCrLf: vs = viWrite(tos, strCommand, Len(strCommand), r)  Do     strCommand = "MON?" + vbCrLf: vs = viWrite(tos, strCommand, Len(strCommand), r)     vs = viRead(tos, strRdBack, 255, c)     DSR = Val(Left\$(strRdBack, InStr(1, strRdBack, ",") - 1))     Result = Left\$(strRdBack, c - 2)      If DSR = DSR_STOP Then Exit Do  Loop While (DSR = DSR_READY Or DSR = DSR_TESTON Or DSR = DSR_TEST + DSR_TESTON)  Select Case DSR     Case DSR_STOP         MsgBox ("USER CANCEL! " + Result)      Case DSR_PASS         MsgBox ("PASS! " + Result)      Case DSR_FAIL         strRdBack = Space(255)         strCommand = "FAIL?" + vbCrLf: vs = viWrite(tos, strCommand, Len(strCommand), r)         vs = viRead(tos, strRdBack, 255, c)          If Val(strRdBack) = LOWER_FAIL Then MsgBox ("LOWER FAIL! " + Result)          If Val(strRdBack) = UPPER_FAIL Then MsgBox ("UPPER FAIL! " + Result)      Case DSR_PROTECTION         strRdBack = Space(255)         strCommand = "PROT?" + vbCrLf: vs = viWrite(tos, strCommand, Len(strCommand), r)         vs = viRead(tos, strRdBack, 255, c)          If Val(strRdBack) = OHP Then MsgBox ("OVER HEAT PROTECTION! " + Result)          If Val(strRdBack) = OHTP Then MsgBox ("OVER HEAT TIMER PROTECTION! " + Result)          If Val(strRdBack) = OVLD Then MsgBox ("OVER LOAD PROTECTION! " + Result)          If Val(strRdBack) = VL Then MsgBox ("VOLT LIMIT PROTECTION! " + Result)          If Val(strRdBack) = REN Then MsgBox ("SIGNAL I/O PROTECTION! " + Result)      Case Else         MsgBox ("ERROR!!") End Select strCommand = "STOP" &amp; vbCrLf: vs = viWrite(tos, strCommand, Len(strCommand), r)  'Closes the port vs = viClose(tos) 'Finalize VISA library vs = viClose(vi)  End Sub </pre>	<pre> 'Checks the device enable 'register and awaits a "Ready" 'status.  'Starts the test on receiving a "Ready."  'Uses the MON? command to read 'out a DSR value, measured 'values, and other parameters. 'Extracts a DSR value. 'Places other measured values 'into variables. 'Exits loop when the STOP 'switch is pressed. 'Repeats steps until the test 'ends. 'Displays the test result.  'STOP switch was pressed 'during testing.  'Displays the PASS test result.  'Reads the contents of the fail 'register to determine which 'reference value was violated. 'Displays the LOWER FAIL test 'result. 'Displays the UPPER FAIL test 'result.  'Reads the protection register 'to determine the reason for 'protection.  'Overheat protection was 'tripped. 'A current greater than 15 A 'was detected for 30 minutes. 'The overload protection (150 'VA) was tripped. 'The voltage limitation was 'tripped. 'The ENABLE signal for the 'SIGNAL I/O connector varied.  'Check results and press the 'STOP switch.  'Closes the port.  'Closes the VISA library. </pre>
---	---

- The protection circuit is activated at 150 VA for TOS6200 or 220 VA for TOS6210.

## Sample program 2

This program sets test conditions for three TOS6200/6210 memory addresses via the GPIB interface, sets memory numbers to program memory, and prepares for AUTO execution of testing.

Option Explicit

```
Private Sub Command1_Click()
    'Writing style is based on VISA 1.2
    '-----
    Dim vi As Long, tos As Long
    Dim vs As Long

    'Initialize VISA library
    vs = viOpenDefaultRM(vi)

    'Open GPIB or COM1 port for tos
    vs = viOpen(vi, "GPIB::3", vbNull, 10, tos)

    'vs = viOpen(vi, "ASRL1", vbNull, 10, tos)

    'Sets attributes if RS232
    Dim lIntfType As Long
    vs = viGetAttribute(tos, VI_ATTR_INTF_TYPE, lIntfType)
    If lIntfType = VI_INTF_ASRL Then
        vs = viSetAttribute(tos, VI_ATTR_ASRL_BAUD, 9600)
        vs = viSetAttribute(tos, VI_ATTR_ASRL_PARITY, VI_ASRL_PAR_NONE)
        vs = viSetAttribute(tos, VI_ATTR_ASRL_DATA_BITS, 8)
        vs = viSetAttribute(tos, VI_ATTR_ASRL_STOP_BITS, VI_ASRL_STOP_TWO)
        vs = viSetAttribute(tos, VI_ATTR_ASRL_FLOW_CNTRL, VI_ASRL_FLOW_XON_XOFF)
    End If

    Dim r As Long
    Dim strCommand As String

    'Device Clear
    vs = viClear&(tos)

    'strCommand = "silent 1" & vbCrLf: vs = viWrite(tos, strCommand, Len(strCommand), r)
    'strCommand = "CLR" & vbCrLf: vs = viWrite(tos, strCommand, Len(strCommand), r)

    strCommand = "FUNCTION 0" & vbCrLf: vs = viWrite(tos, strCommand, Len(strCommand), r)

    strCommand = "MEMORY 20," & Chr$(34) & "TEST1" & Chr$(34) & ",25.0,0.1,0.020,60.0,50,ON,OFF,ON" & vbCrLf
    vs = viWrite(tos, strCommand, Len(strCommand), r)

    strCommand = "MEMORY 21," & Chr$(34) & "TEST2" & Chr$(34) & ",10.0,0.1,0.020,4.0,50,ON,OFF,ON" & vbCrLf
    vs = viWrite(tos, strCommand, Len(strCommand), r)

    strCommand = "MEMORY 22," & Chr$(34) & "TEST3" & Chr$(34) & ",10.0,0.2,0.020,4.0,50,ON,OFF,ON" & vbCrLf
    vs = viWrite(tos, strCommand, Len(strCommand), r)

    strCommand = "FUNCTION 2" & vbCrLf: vs = viWrite(tos, strCommand, Len(strCommand), r)

    strCommand = "PRGNEW 10" & vbCrLf: vs = viWrite(tos, strCommand, Len(strCommand), r)

    strCommand = "PRGNAME 10," & Chr$(34) & "TEST_SAMPLE" & Chr$(34) & vbCrLf
    vs = viWrite(tos, strCommand, Len(strCommand), r)

```

'Initializes the VISA library.

'Opens the port.  
'Opens the GPIB port.  
'Address 3.  
'Opens the COM1 port.  
'When using the RS-232C interface, remove the comment from this line and add it to the line of GPIB.  
'Enter communication settings for the RS-232C interface.

'Device clear.  
'Device clear performed when using GPIB.  
'RS-232C command.  
'The RS-232C interface uses the CLR command.

Sets test conditions to 'MEM20.

Sets test conditions to 'MEM21.

Sets test conditions to 'MEM22.

'Switches to AUTO EDIT screen.  
'Clears the 10th program.

'Names the 10th program.



```
strCommand = "PRGEDIT 10,0,20,0.5" + vbCrLf: vs = viWrite(tos, strCommand, Len(strCommand), r) 'Stores MEM20, MEM21, and
strCommand = "PRGEDIT 10,1,21,1.5" + vbCrLf: vs = viWrite(tos, strCommand, Len(strCommand), r) 'MEM22 into the 10th
strCommand = "PRGEDIT 10,2,22,2.5" + vbCrLf: vs = viWrite(tos, strCommand, Len(strCommand), r) 'program.

'Close the port
vs = viClose(tos) 'Closes the port.
'Finalize VISA library
vs = viClose(vi) 'Closes the VISA library.

End Sub
```

## Sample program 3

This program runs AUTO execution of the 10th program created in sample program 2 and displays the results in the message box.

Option Explicit

```
Private Sub Command1_Click()  
    'Writing style is based on VISA 1.20 or 2.01  
    '-----  
    Dim vi As Long, tos As Long  
    Dim vs As Long  
  
    'Initialize VISA library  
    vs = viOpenDefaultRM(vi)                                     'Initializes the VISA library.  
  
    'Open GPIB or COM1 port for tos  
    vs = viOpen(vi, "GPIB::3", vbNull, 10, tos)                'Opens the port.  
    'vs = viOpen(vi, "ASRL1", vbNull, 10, tos)                 'Opens the GPIB port. Address 3  
                                                                'Opens the COM1 port. When  
                                                                'using the RS-232C interface,  
                                                                'remove the comment from this  
                                                                'line and add it to the line of  
                                                                'GPIB.  
  
    'Sets attributes if RS232  
    Dim lIntfType As Long  
    vs = viGetAttribute(tos, VI_ATTR_INTF_TYPE, lIntfType)  
    If lIntfType = VI_INTF_ASRL Then  
        vs = viSetAttribute(tos, VI_ATTR_ASRL_BAUD, 9600)  
        vs = viSetAttribute(tos, VI_ATTR_ASRL_PARITY, VI_ASRL_PAR_NONE)  
        vs = viSetAttribute(tos, VI_ATTR_ASRL_DATA_BITS, 8)  
        vs = viSetAttribute(tos, VI_ATTR_ASRL_STOP_BITS, VI_ASRL_STOP_TWO)  
        vs = viSetAttribute(tos, VI_ATTR_ASRL_FLOW_CNTRL, VI_ASRL_FLOW_XON_XOFF)  
    End If  
                                                                'Enter communication settings  
                                                                'for the RS-232C interface.  
  
    Const DSR_READY = 1: Const DSR_INVSET = 2: Const DSR_TEST = 4: Const DSR_TESTON = 8  
                                                                'Definition of the device  
                                                                'status register.  
  
    Const DSR_PASS = 16: Const DSR_FAIL = 32: Const DSR_STOP = 64: Const DSR_PROTECTION = 128  
    Const LOWER_FAIL = 2: Const UPPER_FAIL = 4  
                                                                'Definition of the fail  
                                                                'register.  
  
    Const OHP = 1: Const OHTP = 2: Const OVLD = 4: Const VL = 8  
    Const REN = 16  
                                                                'Definition of the protection  
                                                                'register.  
  
    Dim r As Long, c As Long  
    Dim strCommand As String, strRdBack As String, DSR As Integer, Result As String  
    strRdBack = Space(255)  
  
    'Device Clear  
    vs = viClear&(tos)                                         'Device clear.  
                                                                'Device clear performed when  
                                                                'using GPIB.  
  
    'strCommand = "SILENT 1" + vbCrLf: vs = viWrite(tos, strCommand, Len(strCommand), r) 'RS-232C command.  
  
    'strCommand = "CLR" + vbCrLf: vs = viWrite(tos, strCommand, Len(strCommand), r) 'The RS-232C interface uses  
                                                                'the CLR command.  
  
    strCommand = "FUNCTION 1" & vbCrLf: vs = viWrite(tos, strCommand, Len(strCommand), r) 'Switches to AUTO screen.  
    strCommand = "PRGTEST 10" & vbCrLf: vs = viWrite(tos, strCommand, Len(strCommand), r) 'Recalls the 10th program.  
    strCommand = "PASSHOLD HOLD" + vbCrLf: vs = viWrite(tos, strCommand, Len(strCommand), r) 'Sets PASS HOLD time to HOLD.  
    strCommand = "DSE #HFF" + vbCrLf: vs = viWrite(tos, strCommand, Len(strCommand), r) 'Sets the device status enable  
                                                                'register to FFH.  
  
    Do  
        strCommand = "DSR?" + vbCrLf: vs = viWrite(tos, strCommand, Len(strCommand), r) 'Checks the device status  
        vs = viRead(tos, strRdBack, 255, c) 'register and awaits a "Ready"  
                                                                'setting.
```



```

Loop While (Val(strRdBack) <> DSR_READY)

strCommand = "START" + vbCrLf: vs = viWrite(tos, strCommand, Len(strCommand), r)

Do
    strCommand = "MON?" + vbCrLf: vs = viWrite(tos, strCommand, Len(strCommand), r)
    vs = viRead(tos, strRdBack, 255, c)
    DSR = Val(Left$(strRdBack, InStr(1, strRdBack, ",") - 1))
    Result = Left$(strRdBack, c - 2)

    If DSR = DSR_STOP Then Exit Do

Loop While (DSR = DSR_READY Or DSR = DSR_TESTON Or DSR = DSR_TEST + DSR_TESTON)

Select Case DSR
    Case DSR_STOP
        MsgBox ("USER CANCEL! " + Result)

    Case DSR_PASS
        MsgBox ("PASS! " + Result)

    Case DSR_FAIL
        strRdBack = Space(255)
        strCommand = "FAIL?" + vbCrLf: vs = viWrite(tos, strCommand, Len(strCommand), r)
        vs = viRead(tos, strRdBack, 255, c)

        If Val(strRdBack) = LOWER_FAIL Then MsgBox ("LOWER FAIL! " + Result)

        If Val(strRdBack) = UPPER_FAIL Then MsgBox ("UPPER FAIL! " + Result)

    Case DSR_PROTECTION
        strRdBack = Space(255)
        strCommand = "PROT?" + vbCrLf: vs = viWrite(tos, strCommand, Len(strCommand), r)
        vs = viRead(tos, strRdBack, 255, c)

        If Val(strRdBack) = OHP Then MsgBox ("OVER HEAT PROTECTION! " + Result)

        If Val(strRdBack) = OHTP Then MsgBox ("OVER HEAT TIMER PROTECTION! " + Result)

        If Val(strRdBack) = OVLD Then MsgBox ("OVER LOAD PROTECTION! " + Result)

        If Val(strRdBack) = VL Then MsgBox ("VOLT LIMIT PROTECTION! " + Result)

        If Val(strRdBack) = REN Then MsgBox ("SIGNAL I/O PROTECTION! " + Result)

    Case Else
        MsgBox ("ERROR!!")
End Select
strCommand = "STOP" & vbCrLf: vs = viWrite(tos, strCommand, Len(strCommand), r)

'Closes the port
vs = viClose(tos)
'Finalize VISA library
vs = viClose(vi)

End Sub

```

```

'Starts the test because
'Ready" was received.
'Uses MON? command to read out
'the DSR value, measured
'values, and other parameters.
'Extracts the DSR value.
'Places the other measured
'values into variables.
'Exits the loop when STOP
'switch is pressed.
'Repeats steps until the test
'ends.
'Displays the test result.

'STOP switch was pressed
'during testing.

'Displays the PASS test result.

'Reads the contents of the fail
'register to determine which
'reference value was violated.
'Displays the LOWER FAIL test
'result.
'Displays the UPPER FAIL test
'result.

'Reads the protection register
'to determine the reason for
'protection.
'The overheat protection was
'tripped.
'A current greater than 15 A
'was detected for 30 minutes.*

'The overload protection (150
'VA) was tripped.*
'The voltage limitation was
'tripped.
'The ENABLE signal for the
'SIGNAL I/O connector varied.

'Check the result and press the
'STOP switch.

'Closes the port.

'Closes the VISA library.

```

- The protection circuit is activated at 150 VA for TOS6200 or 220 VA for TOS6210.





## **Chapter 7 Maintenance**

Explains tester maintenance and inspection of the tester.

To maintain high performance for an extended period, perform maintenance and inspect the tester regularly.

---

## 7.1 Cleaning

If the panel surface is stained, lightly wipe the stain using a soft cloth with a water-diluted neutral detergent.

---

**⚠ WARNING** • Before cleaning, be sure to turn OFF the POWER switch and to unplug the power cord.

**⚠ CAUTION** • Do not use volatile substances such as thinner or benzene for cleaning, as they may cause discoloration or erase printed characters, clouded display and so on.

---

## 7.2 Inspection

---

**⚠ WARNING** • Any break or cracking in the covering greatly increases the risk of electric shock or fires. If you find any breaks or cracks, immediately discontinue any use of the tester.

---

To purchase accessories, please contact your Kikusui distributor/agent.

### ■ AC power cord

Check for tears in the cable coating, looseness and fracture of the plug, and breakage of the cable.

### ■ Test leads

Check the cable coating for tears, fissures, and breakage.

## 7.3 Checking and Replacing the Fuse

- ⚠ WARNING**
- To avoid electric shock, always turn off the POWER switch and unplug the AC power cord from an electrical outlet before performing inspections or replacing the fuse.
  - To avoid electric shock, make sure that the replacement fuse is of the correct shape, rating, and characteristics for tester specifications. Never use a fuse having a different rating; never short-circuit the fuse holder.

1. Turn off the POWER switch and unplug the AC power cord from the electrical outlet.
2. Disconnect the AC power cord from the AC LINE connector on the rear panel.
3. Use a screwdriver to remove the fuse holder, as shown in Fig. 7-1.

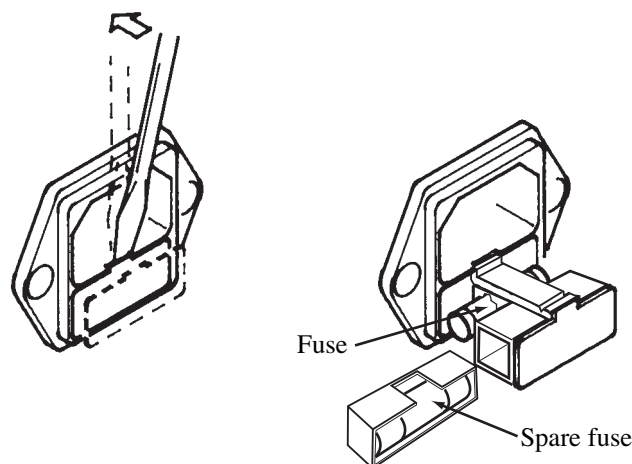

Fig. 7-1 Removing the Fuse Holder

### TOS6200

LINE VOLTAGE RANGE	FREQUENCY RANGE	FUSE (250 V)		VA MAX
		UL198G	IEC60127	
● 85-132 V	47-63 Hz	6.3 A SLOW	6.3 A (T)	450
170-250 V				330

### TOS6210

LINE VOLTAGE RANGE	FREQUENCY RANGE	FUSE (250 V)		VA MAX
		UL198G	IEC60127	
85-250 V	47-63 Hz	6.3 A SLOW	6.3 A (T)	420

- NOTE**
- UL and IEC standards provide different designations for pre-arcing time-current characteristics of fuses. Use a fuse that complies with one or both of these standards.

## 7.4 Replacing the Cooling Fan and Backup Battery

- 
- ⚠ WARNING** • Since replacement of the cooling fan or backup battery involves removing the cover, all such work should be performed by our service personnel. If replacement is necessary, please contact Kikusui distributor/agent.
- 

### ■ Cooling fan

The cooling fan within the tester is rated for a service life of 60,000 hours.

(The cooling fan adjusts its rotational rate depending on the internal temperatures of the tester, and actual service life will vary depending on the tester's service conditions.)

However, we recommend replacing the fan roughly every 60,000 hours. We also recommend regular internal inspections and cleaning at the same interval.

### ■ Backup battery

The tester uses a lithium battery for memory backup.

If the battery is exhausted, the memory is unable to retain test conditions and other data.

(The battery life varies depending on the operating environment.)

We recommend that the battery be replaced every three years from the purchase date as a guide, taking the opportunity to conduct an internal inspection and cleaning.

## 7.5 Calibration

Regular calibration is required to maintain long-term accuracy of any measurement instrument.

Please request our calibration service to have calibration performed.

## 7.6 In Case of Problems

The following problems do not necessarily indicate failures. Please make the following inspections before requesting repairs.

Symptom	Check Item	Chapter/section to be referred to	Page number
The tester does not start when the POWER switch is pressed.	Check that the AC power cord is connected.	2.5, "Connecting the AC Power Cord"	2-6
	Check that the fuse is blown.	7.3, "Checking and Replacing the Fuse"	7-3
The LCD screen does not appear even when the POWER switch is pressed.	Make sure that the contrast adjustment is correct.	4.4, "System Setup"	4-16
	Make sure that ambient temperatures are not below the recommended operational limits.	8.3, "General Specifications"	8-6
The keys on the front panel do not work.	Make sure that the key lock function is off.	4.8, "Key Lock"	4-28
	Make sure that the tester is not being controlled remotely via the GPIB or RS-232C interface.	LOCAL key	3-5
The START key does not function.	Check that no stop signal is being input.	Chapter 5 "REMOTE and SIGNAL I/O"	5-1
	Check that the tester is not in PROTECTION, PASS, or FAIL status.	4.10, "Protection Function"	4-31
	Check that the tester is not in the midst of system setup, interface setup, or program editing.		
	Check that the tester is not currently saving or recalling information from panel memory.		
	Make sure that the double action function is off.	"ON/OFF for Double Action"	4-18
	Check that the "READY" indication is displayed on the LCD.		
	Check that "OVER VOLT" is not blinking in the upper right of the LCD.	"OVER VOLT" in 4.9.1, "Setting Output out of the Operation Range"	4-29
	Check that "OVER VA" is not blinking in the upper right of the LCD.	"OVER VA" in 4.9.1, "Setting Output out of the Operation Range"	4-29
	Check that "OVER RESI" is not blinking in the upper right of the LCD.	"OVER RESI (TOS6210 only)" in 4.9.1, "Setting Output out of the Operation Range"	4-30
Check that "UP<= LOW" is not blinking in the upper right of the LCD.	4.9.2, "Upper Reference Value <= Lower Reference Value (UP <= LOW)"	4-30	
The fan does not run.	The fan adjusts its rotational rate depending on the tester's internal temperatures; if the internal temperatures are sufficiently low, the fan will not run. If "OVER HEAT" appears on the LCD and the fan is not running, the tester is defective.		





# 8

## Chapter 8 Specifications

Gives electrical and mechanical specifications for the product.

Unless otherwise specified, the specifications contained in this chapter are based on the following settings and conditions:

- Warm-up time: 30 minutes
- Temperature: 5°C to 35°C
- Humidity: 20% to 80% R.H (no condensation)
- “xx% of reading” represents xx% of the meter reading.
- “xx% of setting” represents xx% of the set value.

## 8.1 Basic Performance

Item	TOS6200	TOS6210
<b>Output block</b>		
Current setting range *1	3.0 to 30.0 A AC (With respect to resistance resulting in output power of the maximum rated Output or less and an output terminal voltage of 5.4 V or less)	6.0 to 62.0 A AC (With respect to resistance resulting in output power of the maximum rated Output or less and an output terminal voltage of 5.4 V or less)
Resolution	0.1 A	
Accuracy	± (1% of setting + 0.2A)	± (1% of setting + 0.4A)
Maximum rated output	150 VA (at output terminals)	220 VA (at output terminals)
Distortion factor	2% or less (with respect to 0.1 Ω pure resistance load of 10 A or greater)	2% or less (with respect to 0.1 Ω pure resistance load of 20 A or greater)
Frequency	50/60 Hz, sine wave (selectable)	
Accuracy	± 200 ppm	
Open terminal voltage	6 Vrms or less	
Output method	PWM switching method	
<b>Output ammeter</b>		
Measurement range	0.0 to 33.0 A AC	0.0 to 66.0 A AC
Resolution	0.1 A	
Accuracy	± (1% of reading + 0.2 A)	± (1% of reading + 0.4 A)
Response	Mean value response/rms value display (response time: 200 ms)	
Hold function	The current measured at the end of test is held during the PASS or FAIL interval	
<b>Output voltmeter</b>		
Measurement range	0.00 to 6.00 V AC	
Resolution	0.01 V	
Offset cancel function	Not provided	0.00 to 5.40 V (Offset ON/OFF function provided)
Accuracy	± (1 % of reading + 0.02 V)	
Response	Mean value response/rms value display (response time: 200 ms)	
Hold function	The voltage measured at the end of test is held during the PASS or FAIL interval	
<b>Ohmmeter *2</b>		
Measurement range	0.001 to 1.200 Ω	0.001 to 0.600 Ω
Resolution	0.001 Ω	
Offset cancel function	0.000 to 1.200 Ω (Offset ON/OFF function provided)	0.000 to 0.600 Ω (Offset ON/OFF function provided)
Accuracy	± (2 % of reading + 0.003 Ω)	
Hold function	The resistance measured at the end of test is held during the PASS or FAIL interval	
<b>Pass/fail judgment function *3</b>		
Resistance value-based judgment	<p>Window comparator system</p> <p>If a resistance value equal to or greater than the upper reference value is detected, a FAIL determination is returned.</p> <p>If a resistance value equal to or less than the lower reference value is detected, a FAIL determination is returned.</p> <p>If a resistance value has been judged as FAIL, the tester shuts off the output and generates a FAIL signal.</p> <p>If the set time elapses without abnormalities, the tester shuts off the output and generates a PASS signal.</p>	
Setting range for the upper reference value (UPPER)	0.001 to 1.200 Ω	0.001 to 0.600 Ω
Setting range for the lower reference value (LOWER)	0.001 to 1.200 Ω	0.001 to 0.600 Ω
Resolution	0.001 Ω	
Judgment accuracy	± (2% of UPPER + 0.003 Ω)	

Item		TOS6200	TOS6210
Pass/fail judgment function (continued) *3			
Sampled voltage value-based judgment		Not provided	Window comparator system If a voltage value equal to or greater than the upper reference value is detected, a FAIL determination is returned. If a voltage value equal to or less than the lower reference value is detected, a FAIL determination is returned. If a voltage value has been judged as FAIL, the tester shuts off the output and generates a FAIL signal. If the set time elapses without abnormalities, the tester shuts off the output and generates a PASS signal.
		Setting range for the upper reference value (UPPER)	0.01 to 5.40 V
		Setting range for the lower reference value (LOWER)	0.01 to 5.40 V
		Resolution	0.01 V
		Judgment accuracy	± (2% of setting + 0.05 V)
Calibration		Calibration is performed with the rms value of the sine wave, using a pure resistance load.	
LED	PASS	Lights for approximately 0.2 sec when the measured value has been judged as PASS. It is lit continuously when the PASS holding time is set to HOLD.	
	UPPER FAIL	Lights if a resistance value equal to or greater than the upper reference value is detected and judged FAIL.	Lights if a resistance or voltage value equal to or greater than the upper reference value is detected and judged FAIL.
	LOWER FAIL	Lights if the resistance value equal to or less than the lower reference value is detected and judged FAIL.	Lights if the resistance or voltage value equal to or less than the lower reference value is detected and judged FAIL.
Buzzer		The buzzer sounds for the pass holding time has been set if the measured value has been judged as PASS. The buzzer sounds continuously under the following condition: The measured value has been judged as PASS when the PASS holding time is set to HOLD. The measured value has been judged as UPPER FAIL. The measured value has been judged as LOWER FAIL. The buzzer volume for FAIL or PASS judgment are adjustable. Note that it cannot be adjusted individually since setting is shared with the setting for PASS.	
Time			
Test time	Setting range	0.3 to 999 s Timer ON/OFF function is available.	
	Accuracy	± (100 ppm of setting + 20 ms)	

\*1 Time limitation with respect to output

The heat radiation capacity at the output block of the tester is designed to be one-third of the rated output, accounting for size, weight, cost, and other factors. Always use the tester within the limitation values given below. Use of the tester beyond these limits will cause the temperature of the output block to rise excessively, potentially tripping the internal protection circuit. In this case, suspend testing for approximately 30 minutes, then press the STOP switch. When temperatures fall to normal levels, the tester will revert to ready status.

	Output time limitation			
	Ambient temperature (°C)	Test current I (A)	Pause time	Maximum allowable continuous test time
TOS6200	$t \leq 40^\circ\text{C}$	$15 < I \leq 30$	Equal to or greater than the test time	≤ 30 minutes
		$I \leq 15$	Not required	Continuous output possible
TOS6210		$40 < I \leq 60$	Equal to or greater than the test time	≤ 10 minutes
		$20 < I \leq 40$	Equal to or greater than the test time	≤ 30 minutes
		$I \leq 20$	Not required	Continuous output possible

\*2 About ohmmeter's response time

A resistance value is instantaneously obtained, calculated using the measured voltage and current values. The response time of the ohmmeter complies with the response times of the voltmeter and ammeter.

\*3 Resistance value-based and sampled voltage value-based judgments cannot be simultaneously conducted.

## 8.2 Interface and Other Functions

Item		Specifications	
REMOTE		5-pin DIN connector on the front panel	
		Function	An option may be connected to provide remote-controlled tester start/stop functions.
		Connectable options	Remote controller: RC01-TOS or RC02-TOS Test probe: LP01-TOS or LP02-TOS
SIGNAL I/O		D-SUB 25-pin connector on the rear panel For connector pin configuration, see Table 1 (attached).	
Input specifications	High-level input voltage	11 to 15 V	All input signals are controlled in active Low. The input terminal is pulled up to +12 V with a resistor. Leaving the input terminals open is equivalent to inputting a high-level signal.
	Low-level input voltage	0 to 4 V	
	Low-level input current	-5 mA maximum	
	Input time width	5 ms minimum	
Output specifications	Output method	Open collector output (4.5 to 30 V DC)	
	Output withstand voltage	30 V DC	
	Output saturation voltage	Approximately 1.1 V (at 25°C)	
	Maximum output current	400 mA (TOTAL)	
RS-232C		D-SUB 9-pin connector on the rear panel (compliant with EIA-232-D)	
		Function	All functions except for the POWER switch and KEY LOCK function may be controlled remotely.
		Baud rate	9600, 19200, or 38400 bps
GPIB		Complies with IEEE Std.488-1978	
		Function	All functions except for the POWER switch and KEY LOCK function may be controlled remotely. For the interface function, see Table 2 (attached).
Display		240 x 64 dots LCD, which displays set values, measured values, judgment results, and other information.	
Test function	AUTO	Performs testing (maximum 100 steps) under different test conditions.	
	MAIN	Performs a single earth continuity test.	
Memory function	AUTO	Provides programming of up to 100 different tests, each consisting of a maximum of 100 steps. (Note that the total number of steps is 500.)	
	MAIN	100 maximum	
Backup battery life		3 years or more (at 25°C)	
TEST MODE	PASS HOLD	Allows a PASS judgment to be held for a specified holding time.	
	MOMENTARY	Allows testing only while the START switch is pressed.	
	FAIL MODE	Disables cancellation of FAIL or PROTECTION status using a stop signal from the remote control.	
	DOUBLE ACTION	Allows testing only when the START switch is pressed within a half-second after the STOP switch is released.	
	CONTACT CHECK	Enables the tester to detect a current flowing through the output terminals to begin testing.	

**Table 1 SIGNAL I/O Connector Pin Configuration**

No.	Signal name	I/O	Description of signals	
1	PM0	I	LSB	2-digit BCD active-low input Input terminal of a panel memory/program select signal This select signal is latched at the rise of a strobe signal to recall the panel memory or program.
2	PM1	I	LSD	
3	PM2	I		
4	PM3	I		
5	PM4	I		
6	PM5	I	MSD	
7	PM6	I		
8	PM7	I		
9	STB	I	Input terminal of a panel memory/program strobe signal	
10	N.C			
11	N.C			
12	N.C			
13	COM		Circuit common	
14	TEST ON	O	ON during testing	
15	TEST	O	ON during testing (not including the period of a current/voltage rise)	
16	PASS	O	ON for approximately 0.2 sec when a measured value has been judged as PASS. It is ON continuously when the PASS holding time is set to HOLD.	
17	U FAIL	O	Continuously ON if a measured value equal to or greater than the upper reference value is detected and judged FAIL.	
18	L FAIL	O	Continuously ON if a measured value equal to or below the lower reference value is detected and judged FAIL.	
19	READY	O	ON while the tester is in ready status	
20	PROTECTION	O	ON when PROTECTION status is in effect	
21	START	I	Start signal input terminal	
22	STOP	I	Stop signal input terminal	
23	ENABLE	I	Start signal's ENABLE signal input terminal	
24	+24 V	O	+24 V internal power output terminal. Maximum output current is 100 mA.	
25	COM		Circuit common	

**Table 2 GPIB Interface Function**

Function	Subset	Description
Source handshake	SH1	All functions operable
Acceptor handshake	AH1	All functions operable
Talker	T6	All functions operable, except for the talk-only function
Extended talker	TE0	No functions operable
Listener	L4	All functions operable, except for the listen-only function
Extended listener	LE0	No functions operable
Service request	SR1	All functions operable
Remote local	RL1	All functions operable
Parallel poll	PP0	No functions operable
Device clear	DC1	All functions operable
Device trigger	DT0	No functions operable
Controller	C0	No functions operable
Electrical interface	E1	Open collector

## 8.3 General Specifications

Item		TOS6200	TOS6210
<b>Environment</b>			
Operating environment		Indoor use, Overvoltage Category II	
Warranty range	Temperature	5 to 35 °C (41 to 95 °F)	
	Humidity	20 to 80 %RH (non condensing)	
Operating range	Temperature	0 to 40 °C (32 to 104 °F)	
	Humidity	20 to 80 %RH (non condensing)	
Storage range	Temperature	-20 to +70 °C (-4 to +158 °F)	
	Humidity	90 %RH or less (non condensing)	
Altitude		Up to 2000 m	
<b>Power requirement</b>			
Allowable voltage range		100 V model: 85 to 132 V AC 100 V/200 V model: 85 to 132 V AC/ 170 to 250 V AC	85 to 250 V AC
Power consumption	At no load (READY)	100 V model: 70 VA or less 100 V/200 V model: 60 VA or less	60 VA or less
	At rated load	100 V model: 450 VA max. 100 V/200 V model: 330 VA max.	420 VA max.
Allowable frequency range		47Hz to 63Hz	
Insulation resistance		30MΩ min. (500 V DC), between AC line and chassis	
Withstanding voltage		1390 V AC (2 seconds), between AC line and chassis	
Earth continuity		25 A AC/0.1Ω max.	
Safety *4		Conforms to the requirements of the following directive and standard. Low Voltage Directive 2006/95/EC EN 61010-1 Class I Pollution degree 2	
Electromagnetic compatibility (EMC) *4, *5		Conforms to the requirements of the following directive and standard. EMC Directive 2004/108/EC EN 61326-1 EN 61000-3-2 EN 61000-3-3  Under following conditions 1. Used test leadwire (TL11-TOS for TOS6200, TL12-TOS for TOS6210) which is supplied. 2. Used the shielded cable which length is less than three meters when the SIGNAL I/O is used.	

\*4 Not applicable to custom order models.

\*5 Only on models that have CE marking on the panel.

Item	TOS6200	TOS6210
Physical dimensions (maximum)	See 8.4, "External Dimensions"	
Weight	Approx. 9 kg (19.84 lbs)	Approx. 11 kg (24.25 lbs)
Accessories		
AC power cord	1 piece	
Test leadwire	TL11-TOS 1 set	TL12-TOS 1 set
Short bar	2 pieces. (These are inserted between the OUTPUT and SAMPLING terminals.)	
AC power fuse	2 pieces (2, including one spare in the fuse holder)	
Operation manual	1 copy	

## 8.4 External Dimensions

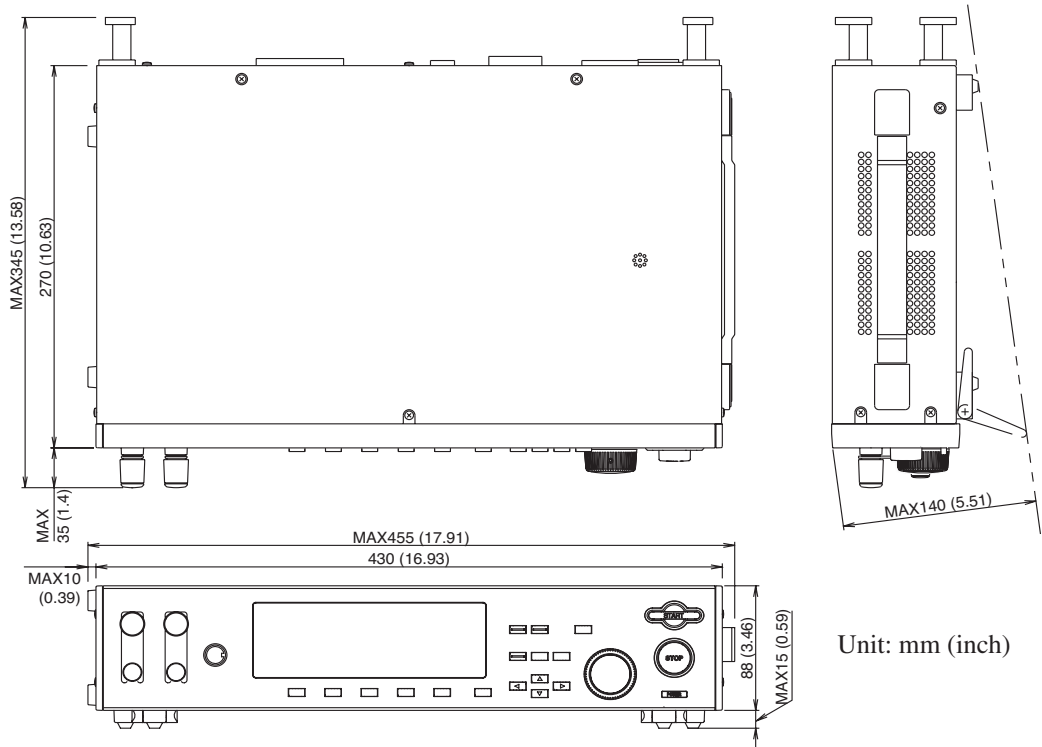

Fig. 8-1 TOS6200 external dimensions

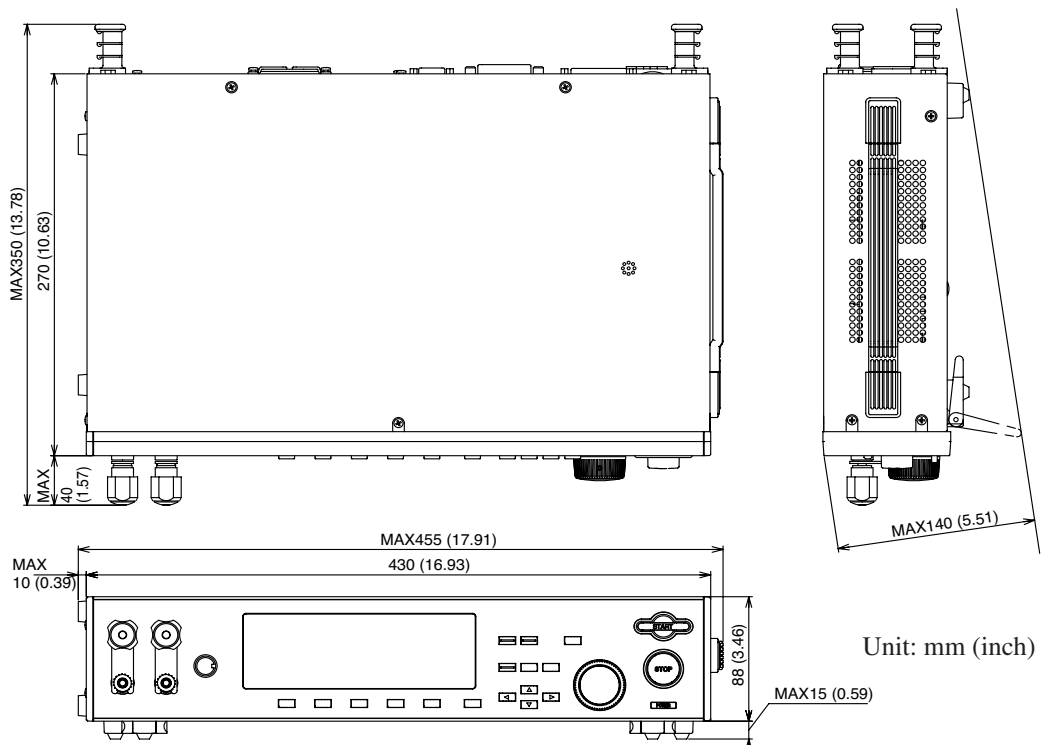

Fig. 8-2 TOS6210 external dimensions



# Appendix

Explains basic tester principles; provides a table for ASCII codes 20H to 7EH and excerpts from various earth continuity test safety standards.

## A.1 Operational Principle

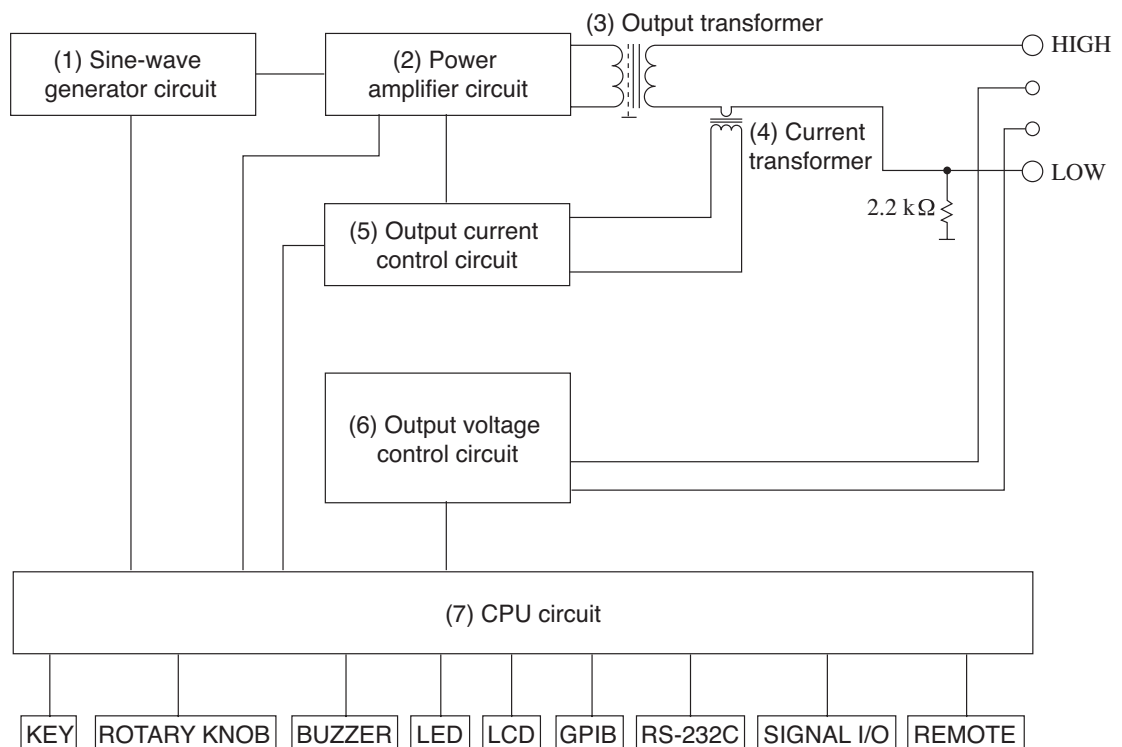

Table A-1 Block Diagram

### (1) Sine-wave generator circuit

Generates a reference sine wave of 50 or 60 Hz, controlled according to output voltage.

### (2) Power amplifier circuit

Power-amplifies the reference sine wave in response to output.

This compact, lightweight PWM sine-wave inverter is capable of a maximum output of 150 VA (TOS6200)/220 VA (TOS6210), achieving a power conversion efficiency of 90%.

### (3) Output transformer

This step-down transformer generates a rated output of 6 V/25 A (TOS6200)/6 V, 40A (TOS6210), for which the secondary side is approximately 6 V when the primary side is 30 V.

#### (4) Current transformer

This transformer voltage-converts the output current and delivers the converted output to the current control circuit.

#### (5) Output current control circuit

Sends detected output current information to the power amplifier circuit for constant current flow at the output terminals. It also DC-converts the detected output current and displays averaged data as measurement values on the LCD.

#### (6) Output voltage control circuit

Sends the detected output voltage to the power amplifier circuit for constant voltage at the output terminals. It also DC-converts the detected output voltage and displays averaged data as measured values on the LCD.

#### (7) CPU circuit

Controls the output current, output voltage, resistance value, pass/fail judgment, test duration, buzzer, and others based on input information through panel key operations, the REMOTE terminal, SIGNAL I/O connector, GPIB connector, or RS-232C connector. Also handles signal output to and communications with external devices.

## A.2 ASCII Codes 20H to 7EH

---

**NOTE**

- In the tester, 22H“””, 27H“””, 2CH“,” and 40H“@” are unavailable.
- 

```
! " # $ % & ' ( ) * + , - . /
0 1 2 3 4 5 6 7 8 9 : ; < = > ?
@ A B C D E F G H I J K L M N O
P Q R S T U V W X Y Z [ \ ] ^ _
` a b c d e f g h i j k l m n o
p q r s t u v w x y z { | } ~
```

## A.3 Initial Settings of the Memory

Memory number		Memory name	CURRENT	UPPER	LOWER	TIMER	FREQ	LOWER ON	OFFSET ON	TIMER ON
TOS 6200	TOS 6210									
-	1	UL60950-1(1)	40 A	2.50 V	0.03 V	120 s	60 Hz	0	0	1
-	2	UL60950-1(2)	60 A	2.50 V	0.03 V	120 s	60 Hz	0	0	1
1	3	IEC60065(1)	25 A	0.1 $\Omega$	0.001 $\Omega$	60 s	50 Hz	0	0	1
2	4	IEC60065(2)	10 A	0.1 $\Omega$	0.001 $\Omega$	1 s	50 Hz	0	0	1
3	5	IEC60065(3)	10 A	0.2 $\Omega$	0.001 $\Omega$	1 s	50 Hz	0	0	1
4	6	IEC60204-1	10 A	0.1 $\Omega$	0.001 $\Omega$	10 s	50 Hz	0	0	1
5	7	IEC60335-1	25 A	0.1 $\Omega$	0.001 $\Omega$	1 s	50 Hz	0	0	1
6	8	IEC60601-1	25 A	0.1 $\Omega$	0.001 $\Omega$	5 s	50 Hz	0	0	1
7	9	IEC60950	25 A	0.1 $\Omega$	0.001 $\Omega$	1 s	50 Hz	0	0	1
8	10	IEC61010-1	25 A	0.1 $\Omega$	0.001 $\Omega$	60 s	50 Hz	0	0	1
9	11	UL1492	20 A	0.1 $\Omega$	0.001 $\Omega$	1 s	60 Hz	0	0	1
10	12	UL1950	25 A	0.1 $\Omega$	0.001 $\Omega$	1 s	60 Hz	0	0	1
11	13	UL2601-1(1)	25 A	0.1 $\Omega$	0.001 $\Omega$	5 s	60 Hz	0	0	1
12	14	UL2601-1(2)	25 A	0.2 $\Omega$	0.001 $\Omega$	5 s	60 Hz	0	0	1
13	15	UL3111-1	25 A	0.1 $\Omega$	0.001 $\Omega$	60 s	60 Hz	0	0	1
14	16	UL6500	25 A	0.1 $\Omega$	0.001 $\Omega$	60 s	60 Hz	0	0	1
15	17	EAMCL	15 A	0.1 $\Omega$	0.001 $\Omega$	1 s	50 Hz	0	0	1
16	18	JIS T 1001	25 A	0.1 $\Omega$	0.001 $\Omega$	5 s	50 Hz	0	0	1
17	19	JIS T 1002	25 A	0.1 $\Omega$	0.001 $\Omega$	5 s	50 Hz	0	0	1
18	20	JIS T 1022	25 A	0.1 $\Omega$	0.001 $\Omega$	1 s	50 Hz	0	0	1

The preceding initial set values for memory are examples of test conditions set under the following conditions, based on each safety standard.

- Test current: The maximum value of the standardized range
- Frequency: 60 Hz for UL standard or 50 Hz for other standards
- Test duration: The minimum value of the standardized range (1 sec if not specified in the standard)

## A.4 Summary of the Safety Standards for Earth Continuity Testing

Standard	Type test/routine test	Main test points (between A and B)	
		A	B
IEC 60065 1998 Audio, Video, and similar electronic apparatus - Safety requirements	Type test (Test certifying conformity to the standard)	Between the following sections of class-I devices requiring grounding 1. Accessible conducting parts 2. Protective shielding 3. Metal barriers	Protective conductor terminal or protective grounding pin
	Routine test (100% test conducted in the production process)		Protective grounding pin for AC inlet on the device side (for devices with removable AC power cords) Protective grounding pin for the power plug (for devices with fixed AC power cords)
IEC 60204-1 1997 Safety of machinery - Electrical equipment of machines - Part 1: General requirement	No distinction	Between all accessible conducting parts of class-I devices requiring grounding	External protective conductor terminal
IEC 60335-1 1994 Household and similar electrical appliances - Safety - Part 1: General requirements	No distinction	Between class-0 and -I devices and all accessible conducting parts of class-I devices	Protective conductor terminal or protective grounding pin
IEC 60601-1 1995 Medical electrical equipment - Part 1: General requirements for safety	No distinction	Between all accessible conducting parts of class-I devices requiring grounding	Protective conductor terminal or protective grounding pin
IEC 60950 1997 Safety of Information Technology Equipment	No distinction	Between the following sections of class-I devices requiring grounding 1. Accessible conducting parts 2. Protective shielding 3. Metal barriers	Protective conductor terminal or protective grounding pin
IEC 60950-1 2001 Information technology equipment - Safety - Part 1: general requirements	No distinction	Between the following sections of class-I devices requiring grounding 1. Accessible conducting parts 2. Protective shielding 3. Metal barriers	Protective conductor terminal or protective grounding pin
IEC 61010-1 2001 Safety requirements for electrical equipment for measurement, control and laboratory use - Part 1: General requirements	Type test	Between the following sections of class-I devices requiring grounding 1. Accessible conducting parts 2. Protective shielding 3. Metal barriers	Protective conductor terminal or protective grounding pin
	Routine test	Between all accessible conducting parts of class-I devices requiring grounding	Grounding pin for an AC inlet or power plug on the device side or protective grounding terminal of permanently installed equipment

Test current	Allowable resistance value	Test time	Remarks
25 A AC or DC (30 A in Canada)	0.1 Ω or less	1 minute	<ul style="list-style-type: none"> <li>• Test voltage must be 12 V or less.</li> <li>• Calculate a resistance value from the flowing current and voltage drop.</li> <li>• In measurements of resistance, do not include the value for the AC power cord's protective grounding wire.</li> </ul>
Order of 10 A AC	0.1 Ω or less 0.2 Ω or less	1 to 4 sec	<ul style="list-style-type: none"> <li>• Use a power supply with a no-load voltage of 12 V or less.</li> <li>• Exercise care so that test results are not affected by the contact resistance between a tester's probe and the metal part being tested.</li> </ul>
10 A or greater (50 or 60 Hz)	See Remarks (0.1Ω or equivalent provided that the test current is 10 A).	10 sec or longer	<p>The measured voltage value at a test point must not exceed the following values.</p> <p>When the effective sectional area of protective conductor is</p> <ul style="list-style-type: none"> <li>1.0 mm<sup>2</sup> or less: 3.3 V maximum</li> <li>1.5 mm<sup>2</sup> or less: 2.6 V maximum</li> <li>2.5 mm<sup>2</sup> or less: 1.9 V maximum</li> <li>4.0 mm<sup>2</sup> or less: 1.4 V maximum</li> <li>6.0 mm<sup>2</sup> or less: 1.0 V maximum</li> </ul>
1. 25 A DC or 25 A AC or 2. 1.5 times the rated device current, whichever is greater.	0.1 Ω or less	Not specified	<ul style="list-style-type: none"> <li>• Use an AC or DC power supply with a no-load voltage of 12 V or less.</li> <li>• In case of doubts, continue testing until a steady state is attained.</li> <li>• Resistance measurements should not include the value for the AC power cord.</li> <li>• Exercise care so that the test results are not affected by the contact resistance between the end of a measuring probe and a metal part.</li> </ul>
1. 25 A (50 or 60 Hz) or 2. 1.5 times the rated device current, whichever is greater.	0.1 Ω or less	5 to 10 sec	<ul style="list-style-type: none"> <li>• The no-load voltage must be 6 V or less.</li> </ul>
1.5 times the current capacity of circuits generating dangerous voltages. Note that this should be 25 A or less AC or DC.	0.1 Ω or less	Not specified	<ul style="list-style-type: none"> <li>• The test voltage must be 12 V or less.</li> <li>• In measurements of resistance, do not include the value for the AC power cord's protective grounding wire.</li> </ul>
If the rating of the test circuit is 16 A or less, 1.5 times the test circuit rating.	0.1 Ω or less	60 sec	<ul style="list-style-type: none"> <li>• The test voltage must be 12 V or less.</li> <li>• Calculate a resistance value from the voltage drop.</li> <li>• In measurements of resistance, do not include the value for the AC power cord's protective grounding wire.</li> </ul>
If the rating of the test circuit is more than 16 A, 2 times the test circuit rating.	See Remarks.	2 minutes	<ul style="list-style-type: none"> <li>• The test voltage must be 12 V or less.</li> <li>• The voltage drop in the protective bonding conductor must not exceed 2.5 V.</li> <li>• In measurements of resistance, do not include the value for the AC power cord's protective grounding wire.</li> </ul>
1. 25 A DC or 25 A AC (at the rated frequency of the power supply) 2. 2 times the rated device current, whichever is greater.	0.1 Ω or less	1 minute	<ul style="list-style-type: none"> <li>• In measurements of resistance, do not include the value for the AC power cord's protective grounding wire.</li> </ul>
For permanently installed equipment, a current twice that of the overcurrent prevention means specified by the installation manual.	See Remarks.	1 minute	<ul style="list-style-type: none"> <li>• The voltage drop should not exceed 10 V DC or AC.</li> </ul>
Not specified	See Remarks.	Not specified	<ul style="list-style-type: none"> <li>• Continuity should be detected during earth continuity testing.</li> </ul>

Standard	Type test/routine test	Main test points (between A and B)	
		A	B
UL1492 1993 Audio-Video Products and accessories (UL1492 1993 will be withdrawn on Jan. 01, 2006; it will replace to UL6500 1999)	Type test	Between accessible conducting parts of class-I devices requiring grounding	Method of protective grounding for a product The part of the device to which the grounding wire of the AC power cord is connected
	Routine test	Between all accessible conducting parts of class-I devices requiring grounding	AC power plug grounding pin
UL1950 1998 Safety of Information Processing Equipment	No distinction	Between the following sections of class-I devices requiring grounding 1. Accessible conducting parts 2. Protective shielding 3. Metal barriers	Protective conductor terminal or protective grounding pin
UL60950-1 2003 Information Technology Equipment - Safety - Part1: General requirements	No distinction	Between the following sections of class-I devices requiring grounding 1. Accessible conducting parts 2. Protective shielding 3. Metal barriers	Protective conductor terminal or protective grounding pin
UL2601-1 1997 Medical Electrical Equipment - Part 1: General Requirement for Safety	No distinction	Between accessible metal parts of class-I devices	Protective conductor terminal (devices without AC power cords)
			Grounding pin for AC inlet on the device side (for equipment with removable AC power cords)
			Protective grounding pin for the power plug (for equipment with a fixed AC power cord)
UL3111-1 1994 Electrical Measuring and Test Equipment - Part 1: General Requirements	Type test	Between the following sections of class-I devices requiring grounding 1. Accessible conducting parts 2. Protective shielding 3. Metal barriers	Protective conductor terminal or protective grounding pin
	Routine test	Between all accessible conducting parts of class-I devices requiring grounding	Grounding pin for an AC inlet or power plug on the device side or the protective grounding terminal of permanently installed equipment
Electrical Appliance and Material Safety Law	No distinction	Between all accessible conducting parts requiring grounding	Grounding terminal or grounding pin for a power plug

Test current	Allowable resistance value	Test time	Remarks
Not specified	0.1 $\Omega$ or less	Not specified	<ul style="list-style-type: none"> <li>If resistance exceeds 0.1 <math>\Omega</math>, perform the test at 60 Hz, 20 A.</li> </ul>
60 Hz, 20 A	0.1 $\Omega$ or less	Not specified	<ul style="list-style-type: none"> <li>The no-load voltage must be 12 V or less.</li> <li>Obtain a resistance value by the dividing voltage drop by flowing current.</li> <li>In measurements of resistance, do not include the value for the AC power cord's protective grounding wire.</li> </ul>
Not specified	See Remarks.	Not specified	<ul style="list-style-type: none"> <li>Continuity should be detected during earth continuity testing using an ohmmeter, or a combination of battery and buzzer.</li> </ul>
1.5 times the current capacity of a circuit generating dangerous voltages. Note that this should be 25 A or less AC or DC.	0.1 $\Omega$ or less	Not specified	<ul style="list-style-type: none"> <li>The test voltage must be 12 V or less.</li> <li>Calculate a resistance value from the flowing current and voltage drop.</li> <li>In measurements of resistance, do not include the value for the AC power cord's protective grounding wire.</li> <li>Exercise care so that the test results are not affected by the contact resistance between the end of a measuring probe and the metal part being tested.</li> </ul>
Test current: 500 A or less Twice the rating of the circuit under test	<p>If the rating of the circuit under test is 16 A or less:</p> <ul style="list-style-type: none"> <li>0.1 <math>\Omega</math> or less</li> <li>A resistance value is calculated from a voltage drop.</li> </ul> <p>If the rating of the circuit under test exceeds 16 A:</p> <ul style="list-style-type: none"> <li>The voltage drop of protective bonding conductors must not exceed 2.5 V.</li> </ul>	See Remarks.	<ul style="list-style-type: none"> <li>The test voltage should be 12 V or less.</li> <li>In measurements of resistance, do not include the value for the AC power cord's protective grounding wire.</li> <li>Exercise care so that the test results are not affected by the contact resistance between the end of a measuring probe and the metal part being tested.</li> </ul> <p>Test time:</p> <p>Rating of the circuit under test is 30 A or less: 2 minutes  Rating of the circuit under test is over 30 A to 60 A inclusive: 4 minutes  Rating of the circuit under test is over 60 A to 100 A inclusive: 6 minutes  Rating of the circuit under test is over 100 A to 200 A inclusive: 8 minutes  Rating of the circuit under test is over 200 A to 500 A inclusive: 10 minutes</p>
25 A (50 or 60 Hz) or current 1.5 times the rated device current	0.1 $\Omega$ or less	5 sec or more to 10 sec inclusive	<ul style="list-style-type: none"> <li>The no-load voltage must be 6 V or less.</li> </ul>
	0.2 $\Omega$ or less		
<ol style="list-style-type: none"> <li>25 A DC or 25 A AC (at power supply's rated frequency) or</li> <li>2 times the rated device current, whichever is greater.</li> </ol>	0.1 $\Omega$ or less	1 minute	<ul style="list-style-type: none"> <li>In measurements of resistance, do not include the value for the AC power cords protective grounding wire.</li> </ul>
For permanently installed equipment, a current twice that of the overcurrent prevention means specified by the installation manual	See Remarks.	1 minute	<ul style="list-style-type: none"> <li>Voltage drop should not exceed 10 V DC or AC.</li> </ul>
Not specified	See Remarks.	Not specified	<ul style="list-style-type: none"> <li>Continuity should be detected in earth continuity testing.</li> </ul>
15 A	See Remarks. (0.1 $\Omega$ or equivalent, provided that the test current is 15 A)	Not specified	<ul style="list-style-type: none"> <li>The test voltage must be 30 V or less.</li> <li>The measured voltage drop must be 1.5 V or less.</li> </ul>

Standard	Type test/routine test	Main test points (between A and B)	
		A	B
JIS T 1001 1992 General Requirements for Safety of Medical Electrical Equipment JIS T 1002 1992 General Rules of Testing Methods for Safety of Medical Electrical Equipment	No distinction	Between all accessible conducting parts requiring grounding	Protective grounding terminal (for equipment without AC power cord)
			Protective grounding pin for AC inlet on the device side (for equipment with removable AC power cord)
			Protective grounding pin for the power plug (for equipment with fixed AC power cord)
JIS T 1022 1996 Safety Requirements of Electrical Installations for Medically Used Rooms in Hospitals and Clinics	—	Between a grounding pin receiver of medical electrical outlet or terminal block of medical grounding terminals	Medical grounding center
		Between a conducting part provided with equivalent potential grounding	

Type test: Test certifying conformity to the standard

Routine test: 100% test conducted in the production process

Class-I devices: Devices or equipment with primary insulation  
Devices or equipment that prevent electric shock by connecting parts with potentially dangerous voltages to the protective conductor terminals of indoor wiring in the event of breakage of primary insulation

Protective conductor terminal: Protective bonding conductor

---

**NOTE** • The table A.4 provides a summary of safety standards. Before performing actual testing, check the latest version of the applicable safety standard.

---



Test current	Allowable resistance value	Test time	Remarks
50 or 60 Hz, 10 A or greater to 25 A, inclusive	0.1 $\Omega$ or less	5 sec or more	<ul style="list-style-type: none"> <li>The no-load voltage must be 6 V or less.</li> <li>Measure current and voltage by a voltage drop method to calculate a resistance value.</li> <li>For measurement conductors, use conductors with a sectional area of 3.5 mm<sup>2</sup> or greater; make them as short as possible.</li> <li>For connections between the measuring circuit, accessible metal parts, and protective grounding terminals, crimp or fix the connections to ensure adequately low contact resistance.</li> </ul>
	0.2 $\Omega$ or less		
10 A to 25 A	0.1 $\Omega$ or less	Not specified	—



# Index

## A

AC LINE 3-6  
AC power cord 2-2  
Accessories 2-2  
ASCII codes 20H to 7EH A-2  
AUTO 4-25  
AUTO / EDIT 3-5

## B

Backup battery 7-4  
Buzzer volume 4-18

## C

Calibration 7-4  
Change in ENABLE signal 4-33  
Cleaning 7-2  
Comments 4-19  
Communications rate 4-21  
Connecting to the DUT 2-13  
Contact check 4-18  
Contrast 4-19  
Cooling fan 7-4  
Cord holders 3-7  
Creating or editing the program 4-25  
Cursor keys 3-5

## D

Date length 4-21  
DISP1 4-14  
DISP2 4-14  
Double Action 4-18

## E

Ending the test 4-14  
Excerpts from the safety standards A-4

## F

FAIL judgment 4-15, 4-27  
Fail Mode 4-17  
Fan 3-7, 7-4

Feet 3-3  
Firmware version 1-2  
Firmware version of products applied 1-2  
Front panel 3-2  
Function keys 3-3  
Fuse 2-2, 7-3

## G

GPIB 3-6  
GPIB Address 4-20  
GPIB interface 8-5  
Grounding 2-7

## H

Handle 3-6

## I

Indicators 3-5  
Initial settings of the memory 4-34  
Initialize 4-34  
Inspection 7-2  
Installation 2-3  
Interface 4-20  
Interval 4-26

## J

Judgment method 4-5, 4-8

## K

KEY LOCK 4-28  
Key lock 4-28

## L

LCD 3-3  
Line voltage 2-5  
LOCAL / KEYLOCK 3-5  
Lower limit judgment 4-8  
Lower reference value 4-8  
LP01-TOS 1-6, 2-10  
LP02-TOS 1-6, 2-10

## **M**

MAIN 4-2  
MAIN / OFFSET 3-4  
Measurement mode 4-16  
Measurement of an offset value 4-11  
Measurements using four terminals 2-12  
Measurements using two terminals 2-12  
MEMORY 3-4  
Momentary setting 4-17  
Moving 2-4

## **O**

Offset 4-11  
Opening screen 4-2  
Operation range 4-28  
Options 1-5  
OUTPUT 3-3  
Output voltage limitation 4-33  
OVER HEAT 4-31, 4-32  
OVER LOAD 4-32  
OVER RESI 4-30  
OVER VA 4-29  
OVER VOLT 4-29  
Overheating protection 4-32  
Overload protection 4-32

## **P**

Panel memory 4-3, 4-22  
Parity 4-21  
PASS hold time 4-16  
PASS judgment 4-14, 4-27  
PASS/FAIL Judgment During Program Execution 4-27  
Pause time 4-31  
POWER 3-2  
Preliminary inspection 2-14  
Program 4-24  
Program name 4-25  
Program screen 4-25  
Protection function 4-31  
Protection status 4-31

## **R**

RC01-TOS 1-5, 1-6

RC02-TOS 1-5  
Ready status 4-13  
Rear panel 3-6  
Recalling a panel memory and program 5-7  
Recalling the memory 4-23  
Recalling the program 4-25  
REMOTE 3-3, 5-1  
Remote control box 1-5  
REMOTE terminal 5-2  
Repeat setting 4-26  
Rotary knob 3-5  
RS-232C 3-6  
Running the program 4-27

## **S**

SAMPLING 3-3  
Safety standards 4-3  
Setting the test conditions 4-3  
Setting the test current value 4-4  
SHIFT 3-5  
SIGNAL I/O 3-6, 4-33, 5-1  
START 3-2  
START signal 5-6  
Starting a test 4-13, 5-6  
STOP 3-2  
Stop Bit 4-21  
Storing in the memory 4-22  
Strobe signal 5-7  
Suspending the program 4-27  
SYSTEM 4-16  
SYSTEM / I/F 3-4  
System setup 4-16

## **T**

Test conditions setup screen 4-2  
Test current 4-4  
Test frequency 4-5  
Test leads 2-8  
Test probe 1-6, 2-10  
Test time 4-10  
Time limitation with respect to output 4-31  
Timer 4-10  
TL11-TOS 2-2, 2-8  
TL12-TOS 2-8

---

Turning on the power 4-2

## **U**

Unpacking 2-2

Upper reference value 4-5

UP<=LOW 4-30

## **V**

VOLT LIMIT 4-33