



Advanced Test Equipment Corp.

www.atecorp.com

800-404-ATEC (2832)



KONICA MINOLTA

New Auto Mode increases accuracy at low luminance levels

# CHROMA METER

# CS-200

Suitable for measurement of optical devices such as LCDs, PDPs, organic ELs, FEDs and LEDs. **24**

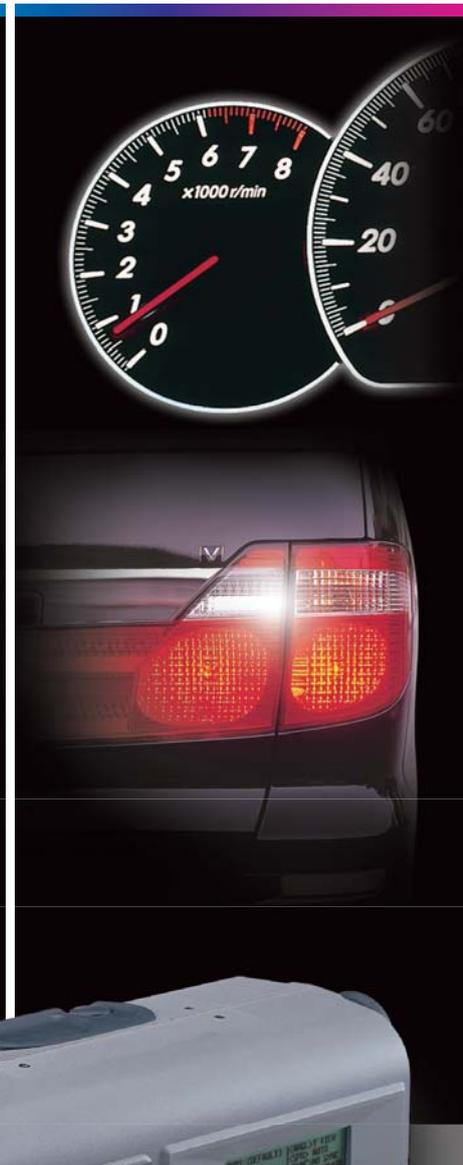
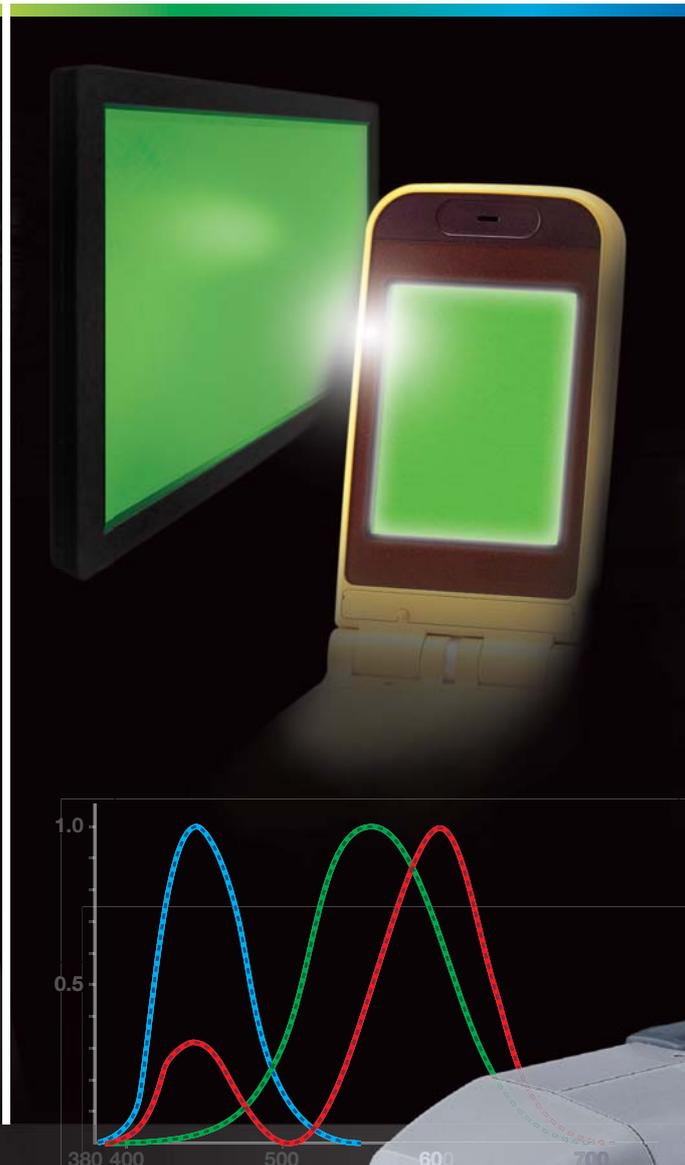

*High-Accuracy Luminance & Chromaticity Measurement Comparable to Many Spectroradiometers*



The Standard in Measuring Color & Light

Giving Shape to Ideas

# Performance Comparable to Many Spectroradiometers Ease of Use and Simplicity Equal to Tristimulus Meters

The technological innovation of displays such as FPDs and LCDs as well as LED products in recent years requires high-quality production, resulting in the need for accurate measuring instruments. The CS-200 is a new type of colorimeter achieving high accuracy while maintaining the simple operation of tristimulus-type colorimeters.

Three selectable angles of 1°, 0.2°, and 0.1° make it easy to measure large and very small objects in a wide measuring range from low luminance of 0.01 cd/m<sup>2</sup> to high luminance of 20,000,000 cd/m<sup>2</sup> (with a measuring angle of 0.1°).

The CS-200 can be used for luminance and chromaticity measurement of various optical devices such as displays like LCDs, PDPs, organic ELs and FEDs, as well as light sources such as LEDs and lamps.

## Accurate measurement

Konica Minolta's newly-developed spectral fitting method enables luminance and chromaticity measurement of single colors in various displays with an accuracy comparable to many spectroradiometers.

### New Auto Mode

#### Wide measuring range from low to high luminance

- The new Auto Mode adjusts the measurement speed according to the luminance of the measurement subject.
- Measurement is available from a low luminance of 0.01 cd/m<sup>2</sup> to a high luminance of 20,000,000 cd/m<sup>2</sup> (with a measuring angle of 0.1°).
- Use of the spectral fitting method and precise analog circuitry achieves stable measurement even for low luminance.

#### Compact and lightweight. Battery power is also possible.

- The compact, lightweight and stylish body allows hand-held operation. The CS-200 can be operated with either four AA batteries (battery indicator function provided) or a special AC adapter.

Measurement button

Finder and Diopter adjustment ring

Objective lens and Focus adjustment ring

Hand strap

LCD screen

Measuring angle selector

USB connector

Power switch

AC adapter input terminal

### Additional Functions

- Measurements can be synchronized with the display device by numerical input of the frequency.
- Selectable measurement speed (AUTO, LTD. AUTO, MANU, superFAST, FAST, SLOW and superSLOW)
- Large LCD display with backlight
- USB 1.1 communication
- Data storage: 101 measured values (9-letter ID assignment possible) and 20 reference values
- User calibration: 20 channels

### Selectable measuring angle

- While checking the actual subject, you can select the measuring angle easily according to the application (1°, 0.2° and 0.1°).
- The aperture mirror eliminates misalignment between the finder target and the actual measuring spot, ensuring accurate aiming.



# "Spectral fitting method" for accurate luminance & chromaticity measurement.

Konica Minolta's newly-developed spectral fitting method provides tristimulus values (XYZ = red, green, blue) with significantly higher accuracy than that of conventional tristimulus colorimeters. This is achieved by using the output from 40 sensors to calculate the spectral response corresponding to human eye sensitivity (CIE 1931 color-matching functions).

The CS-200 uses 40 sensors for sensitivity covering the entire visible region and multiplies each sensor output by appropriate coefficients. This adjusts the spectral response of the instrument to close to the CIE 1931 color-matching functions.

In addition to the 2° Standard Observer, the 10° Standard Observer (for object-color measurements) can also be selected, which is impossible with conventional tristimulus colorimeters.

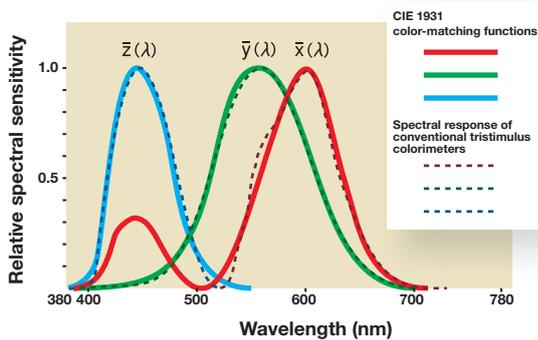

CIE 1931 color-matching functions and spectral response of a conventional tristimulus colorimeter

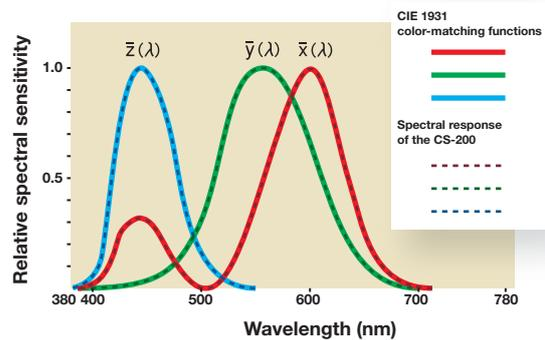

CIE 1931 color-matching functions and spectral response of the CS-200

## KONICA MINOLTA's Chroma Meter for accurate light-source measurement allows building of a color management network both internally and externally.

### In R&D and design departments

There is no need for calibration work to determine a value of each light source by using a reference spectroradiometer. For displays like LCDs or organic ELs in particular, user calibration for the reference panel using a spectroradiometer can be eliminated \*1.

\*1 If higher accuracy is required, user calibration can be used.

### In quality management and incoming inspection departments

Since individual errors are minimized compared to conventional tristimulus colorimeters, the inspection of various devices such as panels does not require individual error correction.

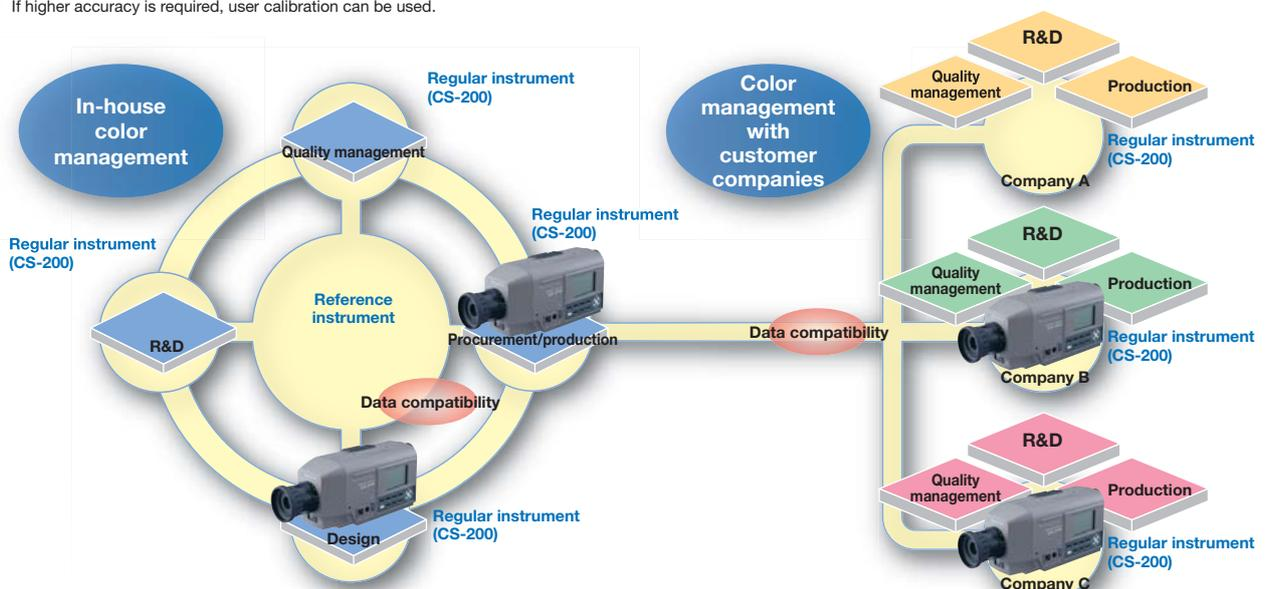



## 1° aperture

For measurement of general-size areas such as medium and large displays

- LCD, PDP, or EL display panels
- LCD panels of mobile phones or digital cameras
- Light sources such as lamps or fluorescent-tube backlights
- Radar or other instrument panels in aircraft cockpits
- Large outdoor display screens

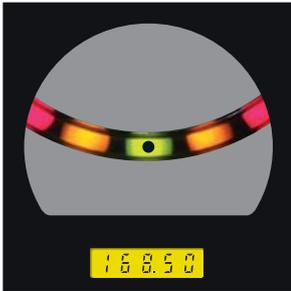

## 0.2° aperture

For measurement of small areas such as product LEDs

- Sub-display of mobile phones
- Car audio equipment
- Automobile instrument panels

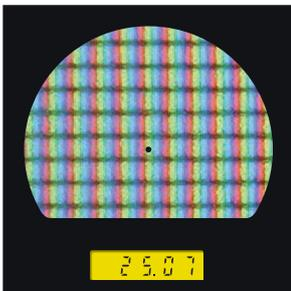

## 0.1° aperture

For measurement of very small areas or of a distant light source

- Pixels of a PDP or LCD
- Cold cathode tube
- Automobile lamps
- Signal lights



## Evaluation applications

- Evaluation of the luminance and chromaticity of light sources
- Evaluation of luminance and chromaticity uniformity
- Contrast evaluation
- $\gamma$ -characteristic evaluation
- Simple measurement of object colors  
(The optional white calibration plate is required.)



## Measuring distance and measuring area

(Unit: mm)

(Measuring angle)	Minimum measuring area			Maximum measuring area			Minimum measuring distance			Maximum measuring distance			Measuring area at 500 mm			Measuring area at 1000 mm		
	1°	0.2°	0.1°	1°	0.2°	0.1°	1°	0.2°	0.1°	1°	0.2°	0.1°	1°	0.2°	0.1°	1°	0.2°	0.1°
Without a Close-Up Lens	φ 4.7	φ 1.0	φ 0.5	∞	∞	∞	296		∞	φ 8.5	φ 1.7	φ 0.9	φ 17.7	φ 3.6	φ 1.8			
Close-up lens No. 122	φ 2.2	φ 0.5	φ 0.3	φ 4.6	φ 1.0	φ 0.5	128		240	—	—	—	—	—	—			
Close-up lens No. 107	φ 0.8	φ 0.2	φ 0.1	φ 1.1	φ 0.3	φ 0.2	43		52	—	—	—	—	—	—			

\* Measuring distance is the distance from the front edge of the metal lens barrel or close-up lens ring.

## Data Management Software CS-S10w Standard (Standard accessory)

CS-S10w Standard Edition allows users to control the CS-200 with a PC to display the list of measured data or to transfer the data to spreadsheet software.

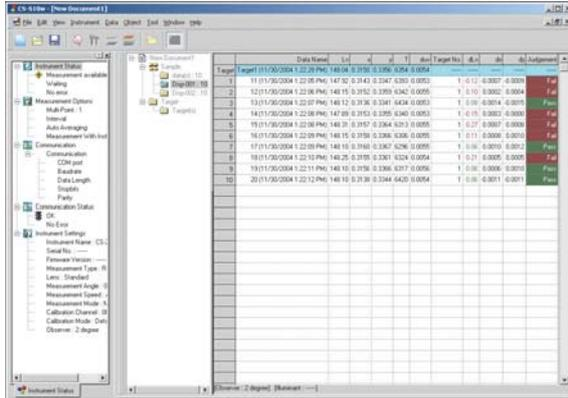

List display

### <Functions common to Standard and Professional Editions>

**Color space :**  $L_v$  x  $y$ ,  $L_v$  u' v',  $L_v T \Delta u v$   
XYZ, dominant wavelength

**Mode selection :** Normal mode  
Object color mode

**Instrument control :** Average measurement  
Interval measurement  
User calibration

**Data management :** Reading and saving files  
Data management with folders

**Data evaluation :** Observer/Illuminant settings  
Statistics display for each folder  
Box tolerance setting

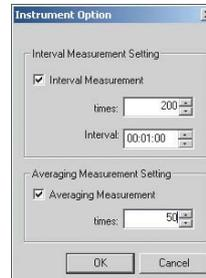

Interval and average measurements

## Data Management Software CS-S10w Professional (Optional accessory)

In addition to the functions of Standard Edition, optional CS-S10w Professional Edition enables various data management, analysis and evaluation functions useful for R&D or quality control.

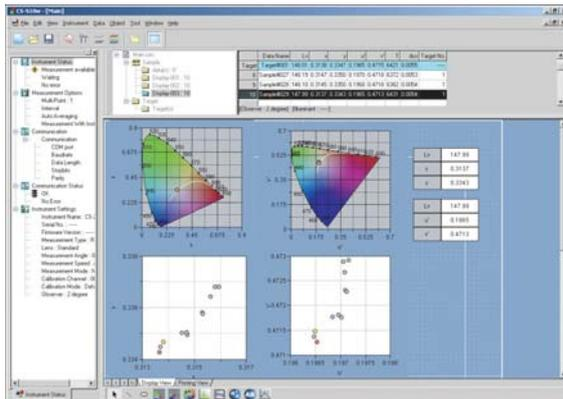

Template showing xy and u'v' chromaticity diagrams

### <Functions available only with Professional Edition>

**Mode selection :** Contrast mode  
RGB mode  
RGB & contrast mode

**Data management :** Creating, saving and loading templates (customizable design/layouts for various graphs)  
Various graph displays

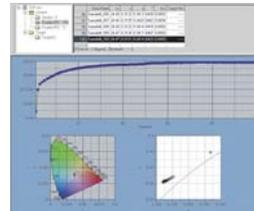

Trend graph display

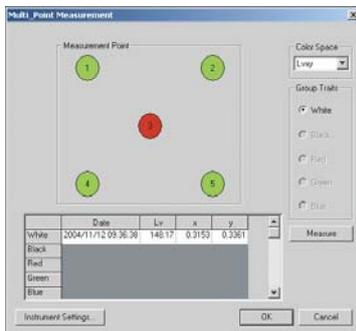

Multiple-point measurement

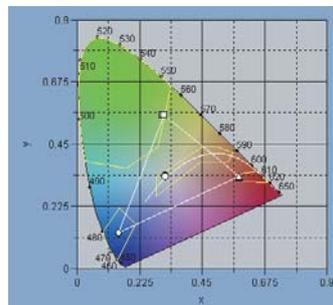

Pass/fail judgment using polygon tolerance (limit values) setting on a chromaticity diagram

**Data evaluation :** Multiple-point measurement, uniformity display, contrast display and polygon tolerance setting for display evaluation

**Other :** Creating reports in customizable screen layouts

	Data Name	$L_v$	$x$	$y$	$T$	dist	Target No.
	Max	140.20	0.3153	0.3361	0.0056		
	Min	147.30	0.3143	0.3340	0.0053		
	Mean	148.10	0.3149	0.3354	0.0054		
	Std Dev	0.0940	0.00042951	0.00056680	25.00000963		
	Non-Uniformity	0.15	0.31	0.30	0.50	5.00	
2	Display_001_P02	147.98	0.3143	0.3349	0.0054		
3	Display_001_P03	148.17	0.3153	0.3361	0.0056		
4	Display_001_P04	148.20	0.3147	0.3353	0.0054		
5	Display_001_P05	148.03	0.3145	0.3340	0.0053		

Uniformity list

### System requirements (common to Standard and Professional Editions)

<b>OS</b>	Windows® 7 Professional 32-bit, 64-bit; Windows® 8.1 Pro 32-bit, 64-bit; Windows® 10 Pro 32-bit, 64-bit • The hardware of the computer system to be used must meet or exceed the greater of the recommended system requirements for the compatible OS being used or the following specifications.
<b>CPU</b>	Pentium®III 600 MHz equivalent or higher
<b>Memory</b>	128 MB min. (256 MB or more recommended)
<b>Hard disk</b>	60 MB or more space required for installation
<b>Display</b>	1,024 X 768, 256 colors or more
<b>Other</b>	CD-ROM drive, USB port

- Windows® is a trademark of Microsoft Corporation in the USA and other countries.
- Pentium® is a trademark of Intel Corporation in the USA and other countries.

## CS-200 specifications

<b>Model</b>	CS-200		
<b>Display range</b>	0.01 - 200,000 cd/m <sup>2</sup> (Measuring angle 1°)		
	0.01 - 5,000,000 cd/m <sup>2</sup> (Measuring angle 0.2°)		
	0.01 - 20,000,000 cd/m <sup>2</sup> (Measuring angle 0.1°)		
<b>Accuracy</b> (Measuring angle 1°)*1 (Standard Illuminant A; Temperature: 23 C±2 C, Relative humidity: 65% max.)	150 cd/m <sup>2</sup>	L <sub>v</sub> ± 2 % ± 1digit	xy ± 0.002
	0.01 to 0.5 cd/m <sup>2</sup>	L <sub>v</sub> ± 0.02 cd/m <sup>2</sup> ± 1digit	---
	0.5 to 1 cd/m <sup>2</sup>	L <sub>v</sub> ± 0.02 cd/m <sup>2</sup> ± 1digit	xy ± 0.007
	1 to 10 cd/m <sup>2</sup>	L <sub>v</sub> ± 2 % ± 1digit	xy ± 0.004
	10 to 200,000 cd/m <sup>2</sup>	L <sub>v</sub> ± 2 % ± 1digit	xy ± 0.003
	Light source at 5000 cd/m <sup>2</sup> + color filter (R, G, B)		xy ± 0.006
<b>Repeatability</b> (Measuring angle 1°)*2 (Standard Illuminant A)	0.01 to 1 cd/m <sup>2</sup>	L <sub>v</sub> 0.01 cd/m <sup>2</sup> + 1digit	---
	1 to 2 cd/m <sup>2</sup>	L <sub>v</sub> 0.5 % + 1digit	xy 0.002
	2 to 4 cd/m <sup>2</sup>	L <sub>v</sub> 0.5 % + 1digit	xy 0.001
	4 to 8 cd/m <sup>2</sup>	L <sub>v</sub> 0.5 % + 1digit	xy 0.0005
	8 to 200,000 cd/m <sup>2</sup>	L <sub>v</sub> 0.1 % + 1digit	xy 0.0004
<b>Measurement time</b>	AUTO (Automatically set between approx. 1s and 60s)		
	LTD.AUTO (Automatically set to approx. 1s or 3s)		
	Super-FAST (approx. 0.5 sec/meas.)		FAST (approx. 1 sec/meas.)
	SLOW (approx. 3 sec/meas.)		Super-SLOW (approx. 12 sec/meas.)
<b>Measurement method</b>	Spectral method, Grating + linear photo diode array		
<b>Measuring angle</b>	1°, 0.2°, 0.1° (selectable)		
<b>Minimum measuring area</b>	φ 0.5 mm		
<b>Minimum measuring distance</b>	φ 0.1 mm (close up lens)		
<b>Observer</b>	2° or 10° Standard Observer		
<b>Color space</b>	L <sub>v</sub> x y, L <sub>v</sub> u' v', L <sub>v</sub> TΔuv, XYZ, dominant wavelength		
<b>Measurement synchronization setting range</b>	Vertical synchronization frequency : 40.00 to 200.00Hz		
<b>Interface</b>	USB 1.1		
<b>Power source</b>	AC Adapter or 4 AA-Size Batteries		
<b>Battery performance</b>	Approx. 3 hours (continuous measurement / Fast mode / AA-size alkaline cells)		
<b>Size (WxHxD)</b>	95 mm x 127 mm x 334 mm		
<b>Weight</b>	1.8 kg (without battery)		
<b>Operation temperature /humidity range</b>	0°C to 40°C, relative humidity 85% or less (at 35°C) with no condensation		
<b>Storage temperature /humidity range</b>	0°C to 45°C, relative humidity 85% or less (at 35°C) with no condensation		

\*1 23°C ± 2°C L<sub>v</sub> = 0.01-10 cd/m<sup>2</sup>, SLOW, average of 30 measurements  
L<sub>v</sub> = 10 cd/m<sup>2</sup> and higher, SLOW, average of 10 measurements

\*2 At 0.2° measuring angle, the amount of received light is approx. 1/25 of that for 1°. Therefore, the repeatability becomes the same as that for 1° with 25 times lower luminance. At 0.1° measuring angle, the amount of received light is approx. 1/100 of that for 1°. Therefore, the repeatability becomes the same as that for 1° with 100 times lower luminance.



Certificate No.: JQA-QMA15888  
Registration Date: October 26, 2018

KONICA MINOLTA, Inc., Sakai Site

Product design, manufacture/manufacturing management, calibration, and service



Certificate No.: JQA-E-80027  
Registration Date: March 12, 1997

KONICA MINOLTA, Inc., Sakai Site

### SAFETY PRECAUTIONS



For correct use and for your safety, be sure to read the instruction manual before using the instrument.

- Always connect the instrument to the specified power supply voltage. Improper connection may cause a fire or electric shock.
- Be sure to use the specified batteries. Using improper batteries may cause a fire or electric shock.

## System Diagram

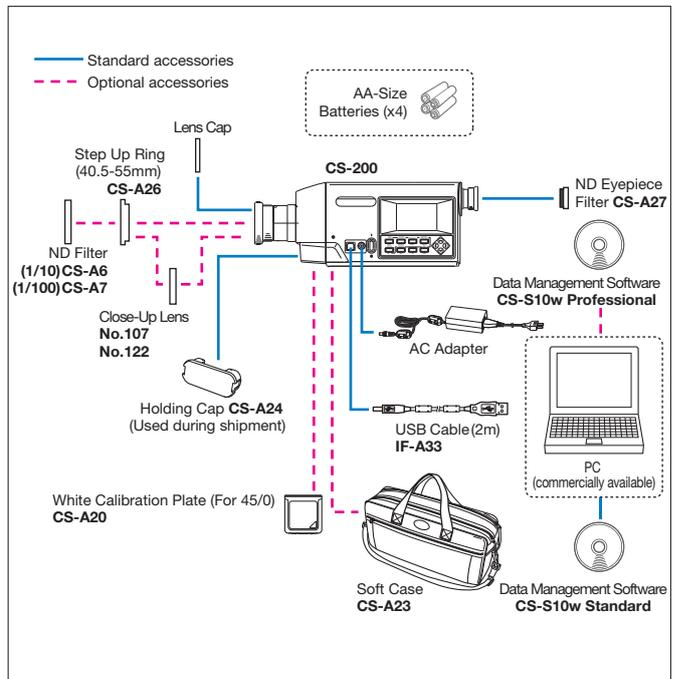

## Dimensions (Unit: mm)

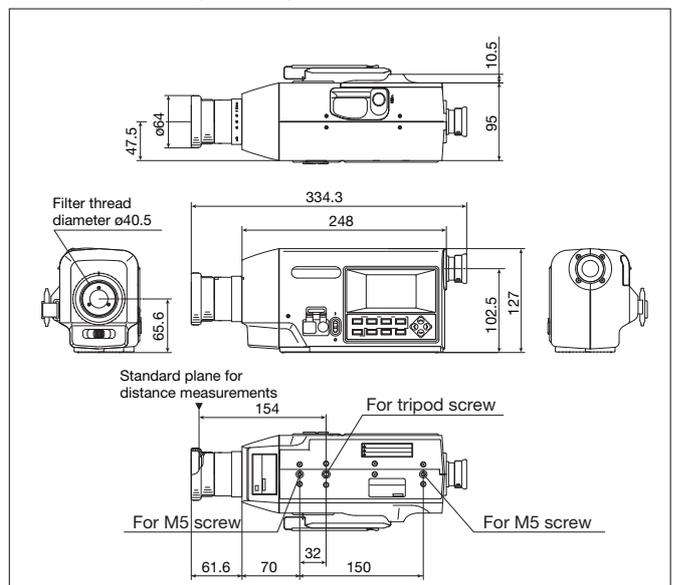

- The specifications and appearance shown herein are subject to change without notice.
- Some lighting control methods may make accurate measurements difficult. For details, please contact your nearest Konica Minolta sales office or dealer.

### Customization service:

In order to meet customer needs even more fully, Konica Minolta offers a customization service for modifying products currently being sold.

#### Main customization service for CS-200 :

##### Modification for high-speed measurement

Customized products will have specifications (such as accuracy and repeatability) different from those of our normal products. Please ask your nearest Konica Minolta dealer for details.

**KONICA MINOLTA, INC.**  
Konica Minolta Sensing Americas, Inc.  
Konica Minolta Sensing Europe B.V.

Osaka, Japan  
New Jersey, U.S.A.  
European Headquarter / BENELUX  
German Office  
French Office  
UK Office  
Italian Office  
Swiss Office  
Nordic Office  
Polish Office  
Turkish Office  
SE Sales Division  
Beijing Office  
Guangzhou Office  
Chongqing Office  
Qingdao Office  
Wuhan Office

**Konica Minolta (CHINA) Investment Ltd.**

**Konica Minolta Sensing Singapore Pte Ltd.**  
Konica Minolta Sensing Korea Co., Ltd.

Addresses and telephone/fax numbers are subject to change without notice. For the latest contact information, please refer to the KONICA MINOLTA Worldwide Offices web page :

©2004 KONICA MINOLTA, INC.

**Phone :** 888-473-2656 (in USA), 201-236-4300 (outside USA)

Nieuwegein, Netherlands

München, Germany

Roissy CDG, France

Warrington, United Kingdom

Cinisello Balsamo, Italy

Dietikon, Switzerland

Västra Frölunda, Sweden

Wroclaw, Poland

Istanbul, Turkey

Shanghai, China

Beijing, China

Guangdong, China

Chongqing, China

Shandong, China

Hubei, China

Singapore

Goyang-si, Korea

**Phone :** +31 (0)30 248-1193

**Phone :** +49 (0)89 4357 156 0

**Phone :** +33 (0)1 80 11 10 70

**Phone :** +44 (0)1925 467300

**Phone :** +39 02849488.00

**Phone :** +41 (0)43 322-9800

**Phone :** +46 (0)31 7099464

**Phone :** +48 (0)71 73452-11

**Phone :** +90 (0) 216-528 56 56

**Phone :** +86-(0)21-5489 0202

**Phone :** +86-(0)10-8522 1551

**Phone :** +86-(0)20-3826 4220

**Phone :** +86-(0)23-6773 4988

**Phone :** +86-(0)532-8079 1871

**Phone :** +86-(0)27-8544 9942

**Phone :** +65 6563-5533

**Phone :** +82 (0)2-523-9726

**Fax :** 201-785-2482

**Fax :** +31 (0)30 24 81 211

**Fax :** +49 (0)89 4357 156 99

**Fax :** +33 (0)1 80 11 10 82

**Fax :** +44 (0)1925 71 1143

**Fax :** +39 02849488.30

**Fax :** +41 (0)43 322-9809

**Fax :** +48 (0)71 734 52 10

**Fax :** +90 (0) 212-253 49 69

**Fax :** +86-(0)21-5489 0005

**Fax :** +86-(0)10-8522 1241

**Fax :** +86-(0)20-3826 4223

**Fax :** +86-(0)23-6773 4799

**Fax :** +86-(0)532-8079 1873

**Fax :** +86-(0)27-8544 9991

**Fax :** +65 6560-9721

**Fax :** +82(0)31-995-6511

<https://konicaminolta.com/instruments/network>

9242-4810-10 BIMPK Printed in Japan