



PMM 9010
PMM 9030
PMM 9060

Fully CISPR-Compliant
Digital EMC/EMI receivers
10 Hz – 6 GHz



PMM 9010
PMM 9030
PMM 9060



Main features at a glance

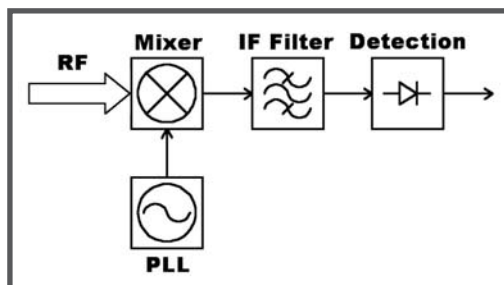

Traditional Receiver

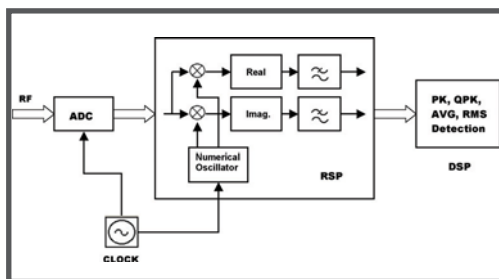

Innovative Digital Receiver

- The state-of-the-art full compliance 30 MHz EMI Digital Receiver is the platform of the system. Based on direct Analog to Digital conversion and sophisticated computation, it offers calibration-free operation on almost all of its key components, i.e. RBW filters, detectors, demodulation... while the RF front-end is self-calibrated by the internal, precise RF signal generator.
- All the units are uniquely compact and lightweight: the low frequency unit (PMM 9010) is about 4,1 kg and the high frequency extensions are about 2 kg. All are battery operated.
- Hardware and Firmware are designed around the current EMC standards, and ready to upgrade to future changes in the same.
- Powerful digital Click Analyzer is fully compliant with the latest CISPR specifications, 1 (internal option) or 4 (external option) channels.

Performance characteristics highlights

- Frequency ranges from 10 Hz to 30 MHz; 3 GHz; 6 GHz.
- Full compliance with the latest edition of CISPR 16-1-1 standard, including RMS-AVG detector, APD function, click measurements, etc.
- Commercial and military standards met within the frequency range
- CISPR and MIL-STD RBW filters.
- Integrated preamplifier (all units) and pulse limiter (only PMM 9010).
- Mostly maintenance and calibration free; service done in minutes.
- Excellent RF characteristics.
- Built-in tracking signal generator up to 30 MHz (PMM 9010).
- Multimode functions: sweep, spectrum analyzer, scalar network analyzer, manual receiver.
- Smart Detector: a "productivity booster" feature specifically designed to dramatically improve test speed.



Precise, accurate, fast and easy-to-use full compliance EMI/EMC tests to civilian and military standards

The latest design effort of Narda STS has produced a fully digital EMC receiver up to 30 MHz. The advantages of the digital techniques extended up to several GHz, thus creating outstanding equipment perfectly fitting the need of any designer and test engineer.

The new EMI/EMC receivers PMM 9010, PMM 9030 and PMM 9060 are fully compliant with CISPR16-1-1 requirements and meet all commercial and military standards for EMC measurements, including the latest revisions.

They exhibit an outstanding precision and are practically free of calibration; they are as small as possible, lightweight and battery operated; they are easy-to-use and easy-to-interface with a regular PC, and they are to a wide extent flexible and programmable, both locally and remotely. Servicing is as easy as to plugging a card into a computer and can be done simply by swapping with pre-calibrated RF modules.

These new concepts make the Narda STS receivers cost-effective and easy to update simply by downloading new firmware versions to cover all the future revisions of the relevant international standards.

- Flexible, easy to use for any kind of measurement in stand-alone, integrated in systems or driven by PC.
- Optical link between main and high frequency units.
- No need for a coaxial cable to connect the antenna to the receiver.
- No aging of critical receiver parts (RBW filters, detectors, mixers, local oscillators, etc.) that cause degradation of the measurement accuracy.
- Easily and quickly serviced by swapping factory calibrated modules.
- Cost-effective.

- Internal memory for limits and correction values: antenna factors, cable loss, probe factors etc.
- Built-in manual, semiautomatic and fully automatic test routines.
- All calculations required by the newest standards (e.g. Click, APD, RMS-AVG, etc.) automatic and built-in.
- Battery powered.
- Extremely fast in all measurements.





PMM 9010: the new fully digital receiver that outperforms competition is here



Once more Narda STS is anticipating the market and competition by introducing the first Fully Digital EMC Receiver and Analyzer that meets all the requirements of the latest civilian and military standards (CISPR-16-1-1 & MIL-STD-461F).

Every circuit in the receiver is digital now, with the only exception of the attenuator and the preselector that – physically – shall put a limit to the RF energy entering the equipment.

This architecture, carefully designed to deliver outstanding performances in a very small volume, is the latest development of Narda STS R&D Labs, well known all around the world with the former name “PMM” for their original and effective technical solutions.

Add the usual “Easy-to-Use” Narda STS software - always acknowledged for offering the best equipment control with a simple and intuitive user interface - and the picture



The PMM 9010 features several useful functions: as an example, pictures above show the automatic highest peaks finder and the intuitive way to observe the selected peak in Analyzer mode: from measurement to debugging at users' fingertips!

Practically maintenance-free and exceptionally stable, the PMM 9010 EMI Receiver is the ideal solution for reliable measurements day after day, month after month, year after year.

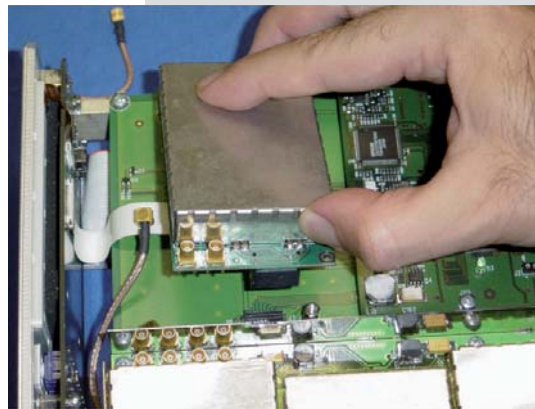

Moreover, the outstanding feature that service can be easily done by simply replacing plug-in pre-calibrated subassemblies, represents a highly valued advantage in case, for example, of damage to the RF front-end.

Indeed, even when an excess of energy or a too high signal would burn the input stage, the Customer can be back in operation and continue his work in the shortest possible time, being sure that his receiver is still perfectly calibrated.

The Narda STS Sales Network is highly qualified and will be your consultant for every measurement problem: ask the experts and make your job easier with PMM 9010, the guiding star in the EMC market.

of the new PMM 9010 is almost complete. PMM 9010: the new fully digital receiver that outperforms competition is here. Continuing the tradition of offering innovative technical solutions for easy and practical measurements applications, the PMM 9010 - a fully digital receiver in the 10 Hz to 30 MHz range - is the first cornerstone of a system which grows together with the users' needs: all EMC conducted measurements will be possible by simply

upgrading the PMM 9010 with specific options, e.g. Click Meter, MIL-STD filters, and accessories - LISNs and probes - providing a full compliance with almost all international standard or proprietary specifications. Moreover, the modular construction, based on pre-calibrated subassemblies, offers the fastest and most convenient recalibration and service ever!



PMM 9030 and PMM 9060: PMM 9010 companion products for testing up to 3 or 6 GHz

Until now, technology has not allowed a fully digital receiver up to the GHz range, Narda STS has conceived the best possible solution designing these extensions for PMM 9010, enabling the whole test system to go up to 3 or 6 GHz taking all the benefits from the digital approach.

The PMM 9030 and PMM 9060 are therefore the ultra-fast 30 MHz - 3 GHz or 6 GHz receivers extending the measurement frequency range of the PMM 9010 up to the field of Radiated Emissions, thanks to a dedicated RF module. A fast and safe connection with PMM 9010 is guaranteed by a High Speed Digital Optical Link, providing the most immune way to transfer data: only the real measurement data received at the antenna reaches the detectors!

This dedicated digital Front End perfectly matches with the PMM 9010, to create a compact-size, up-to-date digital receiver up to 3 or 6 GHz.

PMM 9030 and PMM 9060 are basically a highly sophisticated auxiliary equipment, which converts the RF input into a digital signal sent to PMM 9010 through a Fiber Optic Cable. The transfer rate is higher than 2.5 GB/s and a huge amount of information is handled by the proprietary protocol.

Very limited dimensions and lightweight construction allow the PMM 9030 and PMM 9060 to be connected directly to the antenna, making the dream of many test engineers come true. Benefits are really many, as RF coaxial cables for antenna to receiver connection may significantly affect measurements due to intrinsic cable loss and impedance mismatch.



Moreover, cables may pick up unwanted RF signals along the path from the antenna to the receiver. The PMM 9030 and PMM 9060 overcome all those error sources through the optical link, thus providing more accurate and reliable measurements.

In order to allow complete galvanic separation, PMM 9030 and PMM 9060 are battery powered by the same Li-Ion plug-in rechargeable battery used for the 9010 unit, thus providing interchangeability and noise-free performances for up to four hours of continuous operation. Replacing the plug-in battery is just a matter of seconds.

The PMM software can drive the coupled 9010-9030 or 9010-9060 to easily perform any measurement foreseen by the commercial and military standards, even stand-alone or, whenever required, with the necessary auxiliary equipment.

The APD (Amplitude Probability Distribution) function is another example of how well the new PMM receivers can respond to the evolving requests of upcoming standards.

The APD is a statistical characterization of signals recently introduced for testing above 1 GHz, that requires scanning of selected spans and measurements on several frequencies using Peak detector and Max Hold function, then sorting frequencies that show highest disturbance levels and comparing them with the limits for a given "Probability".



This requires the receiver featuring outstanding hardware with high range, huge memory and ultra fast computation capabilities - and a software capable of handling all the different test possibilities (two approaches are defined: E-based and P-based).

Moreover, to make the Test Engineer's life easier, the software allows the user to adopt the most convenient test approach - fully automatic, semiautomatic, manual, etc. - and, last but not least, to report all the data and results the User may need.

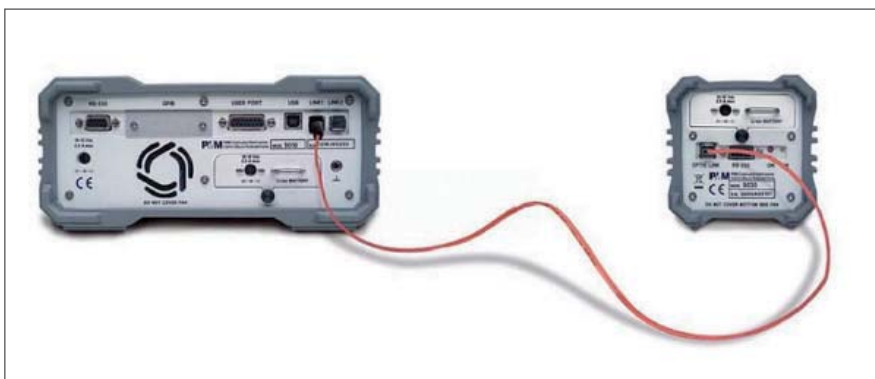

Fiber Optic link between PMM 9010 main unit and PMM 9030 & 9060 RF extension units. Max. length: 100 m.



Universal kit for mounting PMM 9030 & 9060 directly on the antenna connector.



High performance digital architecture

characterized by an ultra-fast A/D converter with the DSP controlling 3 processors for different functions: RSP (Receiver Signal Processor), FPGA and CPLD.

No calibrations, no adjustments

after the A/D converter which is inserted in the circuit just when the signal comes out of the input attenuator and the preselector, to take the maximum benefit from the digital approach. All the internal references are derived from the system clock: the receiver is free from any phase noise, jitter, drift, etc.

High-speed RSP and DSP

for highest precision and simultaneity. A dedicated Receiver Signal Processor handles all the numeric signals within the digital IF, while the Digital Signal Processor provides all of the calculations and signals treatment, like simultaneous detections, demodulations and graphical representation in real time.

The powerful RSP (Receiver Signal Processor)

allows the use of the FIR (Finite Impulse Response) technique to create digital RBW filters: the result is an impressive lifetime stability of such filters and a shape controlled to the perfection, due to its mathematical modelling. The competitive receivers featuring analogue filters are definitely several steps behind.

The Numeric Local Oscillator generates pure mathematical signals for the Digital IF Filters, divided into Real and Imaginary parts. The main advantage of the mathematic

approach is that the computing function do not generate those spurious components a conventional analog mixer would do.

The Pure Mathematical QP, PK, AVG, RMS, RMS + AVG Detectors and the APD function

feature absolute stability and lifetime calibration-free operation. The response of such RF receiver is no longer depending from the input signals and the detectors always work exactly as intended. These detectors are mathematical functions for unsurpassed performance and precision: they are simply the best and simultaneous by definition. It shall be noted that all these detectors and functions are needed in a receiver full compliant to the latest CISPR 16-1-1. Then the Product Committee can decide which of these features are the most appropriate; for instance, the latest RMS+Avg detector and the APD functions – as well as the Average detector - will be used with the new digital equipment and/or above 1 GHz. No problem for other products still requiring the more traditional Quasi-Peak and Average detectors: they're all on board.

Absolute and stable compliance to CISPR

of all digital RBW filters. It's simply amazing the perfection of these filters mathematically created and shaped to meet exactly the CISPR requirements.

If needed by changes in the standards, new markets opportunities, custom requests etc. Narda can model new filters to upgrade the receivers and implement the new features. This consists just in firmware upgrade done by the user and is a matter of seconds.

Ultra-fast measurements of CISPR A-band (9 kHz ÷ 150 kHz)

the FFT (Fast Fourier Transform) function allows to perform a full scan of the whole A-band in only 1 second! Even when the

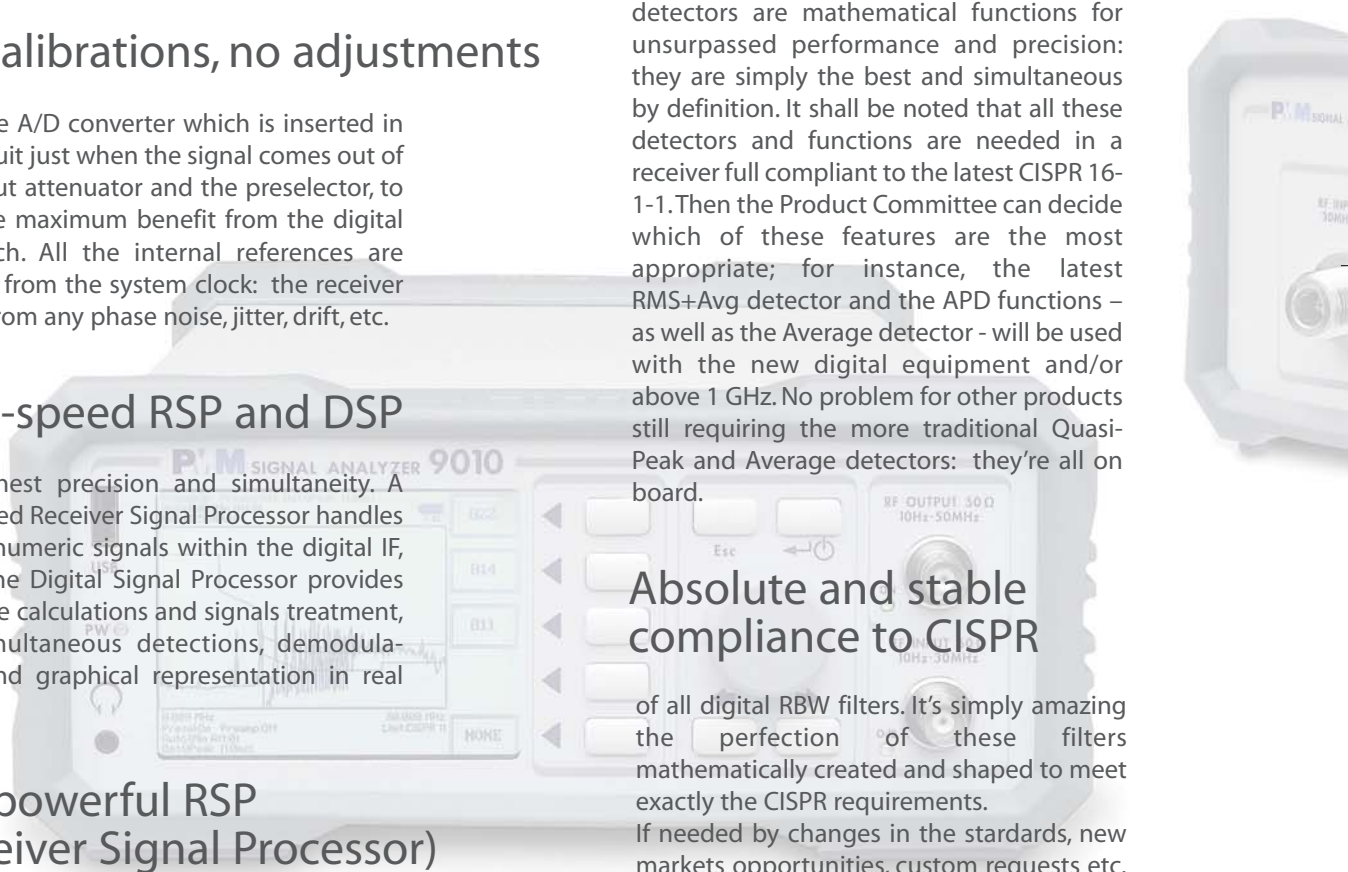

source is emitting for very short periods of time - or when the source operating cycle is extremely short, there is a much higher probability to capture and measure the disturbance.

Hold Time

another step ahead from analogue behaviour! At each frequency step, given by the selected filter bandwidth, the PMM 9010 really stops for the preset time, so taking a perfect picture of the signal under analysis, while analogue receivers may show a certain "drift" depending from the sweep time. With setting equal to 0, the Hold Time is the minimum time of permanence required by the selected IF filter for the fastest possible measurement speed.

Built-in Preselector

designed to make correct measurements of all input signals, including pulses. The quality of the preselector - one of the very few analogue sections in the receiver - is essential to guarantee the best performances and represents the most important difference between a true EMI Receiver, capable of the more reliable results, and a generic Spectrum Analyzer adapted to perform EMC measurements.

The Auto Attenuator

provides maximum dynamic range without distortion. It is controlled by an FPGA (Field Programmable Gate Array) directly driven by the internal DSP (Digital Signal Processor) and provides optimum performances in every testing condition, while protecting the RF input (e.g.: zero dB attenuation is not allowed in auto-attenuation mode).

The Built-in Preamplifier

of PMM 9010 cannot be saturated thus it provides correct response to continuous and pulsed signals, while in most receivers the preamplifier is directly connected to the RF input. Saturation might be there without notice!

Pulse Limiter

is built-in in the PMM 9010, providing an extra protection, if required.

The Pre-Loaded CISPR Limits

are stored in a non-volatile memory and immediately available for tests done in "Sweep Mode": easy, fast and error free!

The Internal RF Generator

in PMM 9010 is a very flexible RF generator tracking with the span or settable at any frequency in the range of 10 Hz ÷ 50 MHz: another powerful tool for the designers that makes the PMM 9010 an easy-to-use scalar network analyzer for characterizing components, filters etc.

This generator provides also the self-calibration of the equipment, as it represents the main frequency reference for all the receiver operation.

To keep it calibrated, it's enough to send back to Narda just the generator module itself: a terrific advantage in terms of costs and speed.

The Click Meter Option

allows the user to perform continuous disturbance tests in a straightforward and easy way.

The receiver takes care of everything: evaluation of the Click Rate N; applicable exceptions; Click measurement using Upper Quartile Method; Full Report with all mandatory data.

PMM 9010 fully supports the new standard dealing with all the allowed four exceptions, showing in real time all the events including click details and reporting all mandatory and optional data to make a detailed report. It shall be noted that the handling of E-3 is the most demanding in terms of hardware and software, however it is also the exception that is more beneficial for the customer, as it allows to skip unnecessary tests. In general, the first investigation is terminated as per one of the required events listed in the standard: after 40 clicks; after the standard 120 minutes; after a specific time span; manually; paused and resumed to allow restarting recursive EUT programs. Moreover, PMM 9010 has the unique feature



“Smart Measure” that can dramatically speed up the Click test: another productivity feature by Narda STS.

Input and Output

USB 2.0, RS232C, and Bluetooth for PC communication (GPIB/IEEE-488 via optional external adapter).

Programmable User Port to control auxiliary equipment like LISNs and other automatic equipment.

High-Speed Optic links featuring 2.6 GBps transfer rate, Bluetooth link, battery charger.

Graphic Display

Instruments typically compromise physical dimensions with display size and type. Despite its small size, the PMM 9010 features a sophisticated graphic process that allows the bright, clear, 16-levels grey backlighted display to catch and show even the narrowest peak in the spectrum.

Controls

the receiver can be operated as stand-alone by the front knob and soft keys through user-friendly menus, or remotely by a PC connected via USB or RS232 Serial interface (Bluetooth optionally).

Rechargeable/Replaceable Internal batteries

for enhanced portability and for field tests, also offering the major advantage of being completely disconnected from the mains in critical analysis, for measurements not influenced at all in hostile or noisy environments.

Easier Radiated Power set-up

as the high frequency receiver can be mounted directly on top of the EM Clamp using a suitable Clamp Adapter and a very short cable connection from the receiver to the EM Clamp.

This means that the long, movable connection (usually going to a reel on the ceiling of the lab and from there to the receiver) is made with a fibre optic, not with a coaxial cable which is heavier, thicker, less flexible, more subject to damage - especially near to the connectors. Again, mechanical and electrical advantages for the test Engineers.

In-situ Tests

or any tests where the connection to the supply network may introduce additional noise, e.g. due to ground loops - are no longer a problem with the PMM 9010 / 9030 / 9060 receivers: they are battery operated and all share the same model of rechargeable battery. Easy, clean, fast, simple.

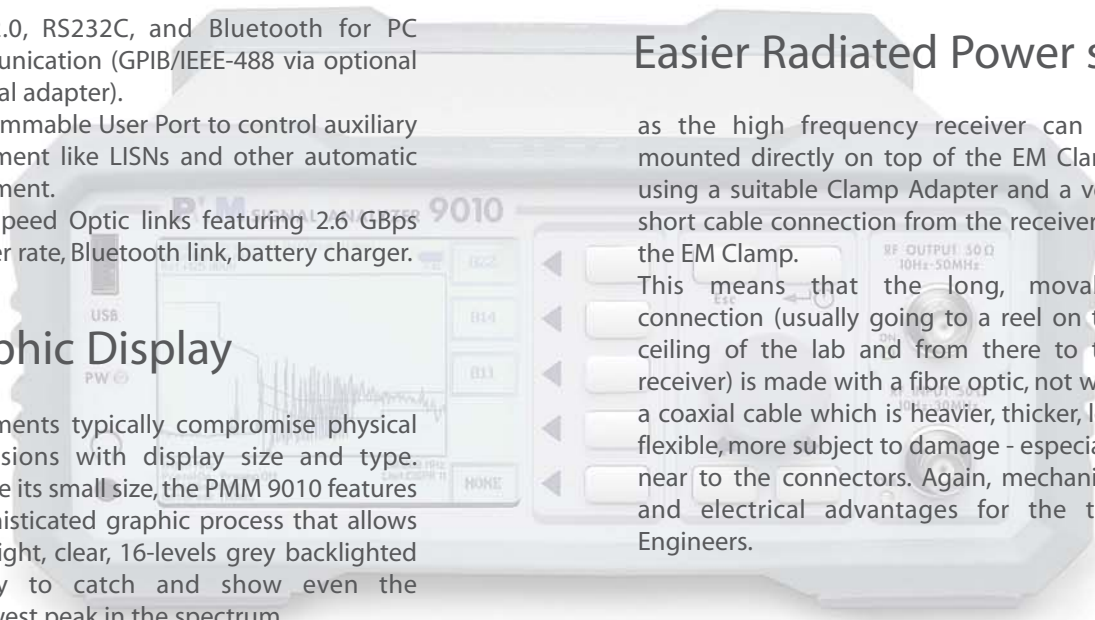

Unsurpassed Intrinsic Uncertainty

much better than any analogue receiver, as per the following table:

ANALOGUE TO DIGITAL UNCERTAINTY COMPARISON		
Input Quantity	Analogue uncertainty contribution (typical) in dB	PMM 9010 uncertainty contribution
Receiver reading	±0,1	Equal or better
Aging	TBD, but present	Absent
Attenuation:		
Antenna-receiver	±0,1	Equal
Cables	TBD, but present	Absent
Connections	TBD, but present	Absent
Receiver correction:		
Sine wave voltage	±1,0	Better
Pulse amplitude response	±1,5	Better
Pulse repetition rate response	±1,5	Better
Mismatch:		
antenna-receiver	+0,9/-1,0	Equal
antenna-cable	TBD, but present	Absent
cable-cable	TBD, but present	Absent
Cable-Antenna (or other transducer, e.g. E.M. clamp) balance	±0,9	Better (w/ 9030-9060)
Cables coupling to ground	TBD, but present	Absent with 9030 or 9060

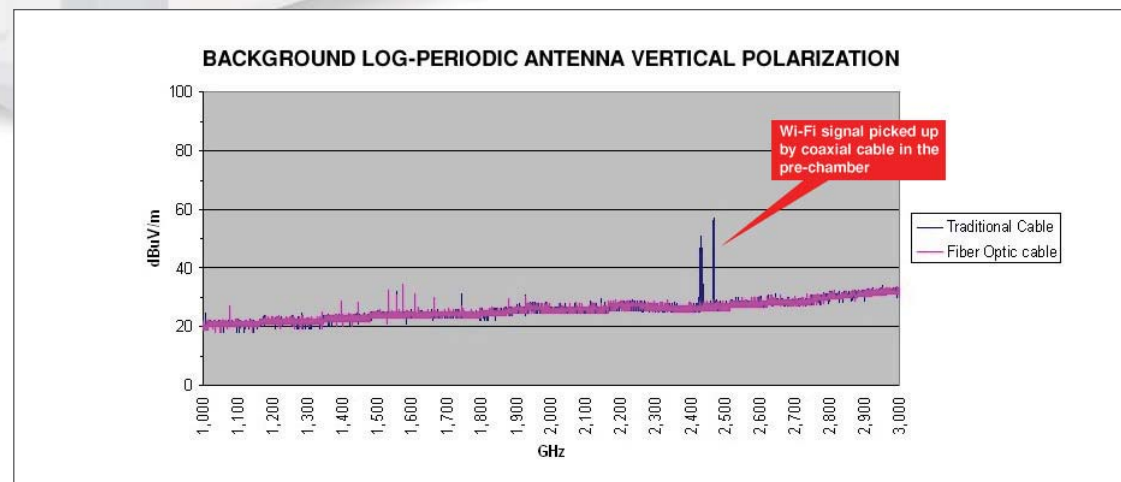

Comparison between antenna-receiver connected by coaxial cable (blue trace) and PMM 9030 directly connected to the antenna and linked to PMM 9010 by fiber optic cable (pink trace).

The example shows how PMM's solution can prevent unwanted signals being picked up by the coaxial cable along its path from the antenna to outside the chamber.



The same rechargeable plug-in battery is used for all PMM 9010, 9030 & 9060



Operating Principles of the PMM 9010-PMM 9030-PMM 9060

Perfect, life-long stable and calibration-free RBW filters
(picture: 200 Hz RBW CISPR filter)

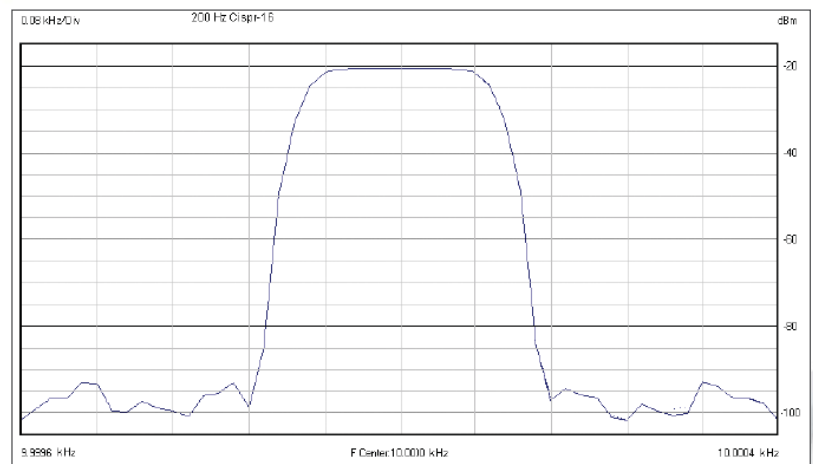

After the A/D conversion the behaviour of a regular receiver is mathematically simulated in order to perfectly match international standards specifications. Even for a digital architecture, preselector filters and input attenuators are mandatory for limiting the signal energy into well defined RF bands, to improve the dynamic range and to increase the signal to noise ratio, thus ensuring accurate measurements of all wideband complex signals typical of EMC measurements.

The input attenuator provides the maximum dynamic range with no distortion. This is particularly important in conducted tests where overloading signals may be present outside the frequency band under test.

To prevent this from happening, the PMM 9010's input attenuator is directly controlled by the DSP in wideband mode to maintain the response linearity in any conditions and also to protect the RF input from out-of-band signals that are too high.

No calibrations and no adjustments are required after the A/D converter: CISPR IF filters and detectors are all mathematically calculated and are thus not subject to any degradation for the life of the instrument. This high performance digital architecture

features an ultra-fast A/D converter with the DSP controlling 3 more processors for different functions: RSP, FPGA, CPLD.

The ADC is followed by the Receiver Signal Processor - RSP - that performs most of the analogue-like functions of the receiver and handles all the numeric signals within the digital IF, with the main advantage of this solution directly deriving from the perfection of the mathematic approach: the computing function is equivalent to conventional analogue mixers, but simply cannot generate spurious components which are therefore absent.

The sampled signals are processed by the RSP in a purely mathematical "mixer-like mode", and then applied to FIR (Finite Impulse Response) digital RBW filters: the result is an unbelievably stable filter, a shape controlled to perfection as it is mathematically modelled. Adjustments needed by analogue filters are simply not required. One of the fastest available DSP not only controls the RSP, but also performs all of the calculations and signal processing, like simultaneous detections and graphical representation, in real time; it controls other functions like the frequency

sweep, etc.

The DSP simultaneously applies the mathematical algorithms corresponding to the detectors Peak, CISPR Quasi-Peak, RMS, Average, RMS+AVE whose response is no longer depends on the input signals, as the detectors always work exactly as intended in perfect time coherent measurements.

Thanks to the high number of operations performed by the DSP - equivalent to those of an ideal 10 GHz Pentium 4™ - the DSP also manages the different operating modes: Sweep Mode, like a traditional receiver with CISPR Limits stored in non-volatile memory, Spectrum and Manual Mode.

The Spectrum Mode allows the receiver to perform spectrum analyzer functions, and thanks to the very high scan speed (<100 ms for full-span 9 kHz-30 MHz @ IF resolution 300 kHz) it is very useful for any kind of debugging. In Manual Mode the filter in CISPR bands is selected automatically according to the frequency and the data are displayed with a dynamic range up to 120 dB, and the hold time is exactly the integration time theoretically required by the applied detectors.

Moreover, hold time means that the receiver really stops for the preset time,

Block diagram of the PMM 9010 EMI Digital Receiver

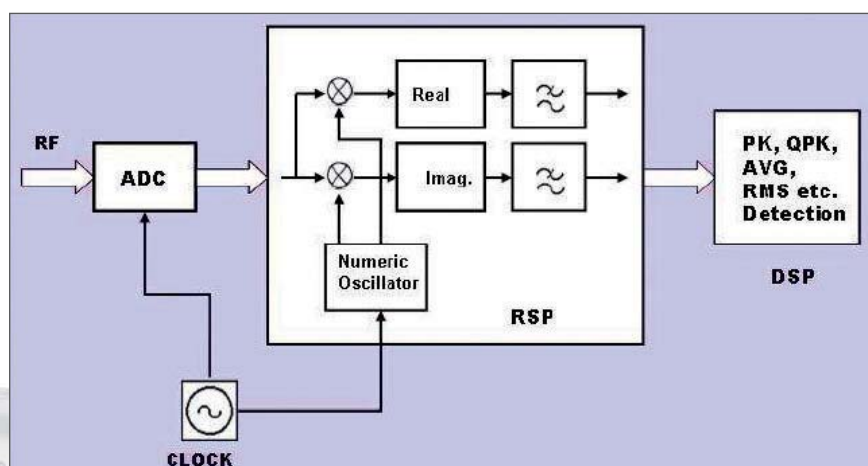

thus taking a perfect picture of the signal under analysis, with no drift depending from on the sweep time.

Other RBW filter standards which may be required in future can be easily added: Narda designers will model them mathematically, verify their performances and add them to userfriendly firmware upgrades.

The huge internal memory combined with the capability of making a FFT (Fast Fourier Transform) analysis of the signals allows for an ultra-fast complete scan of the whole A-band (9 to 150 kHz) performed in only 1 second even with the 200 Hz filter.

Even in those cases when the source is on for very short periods of time – or when the source has an extremely short cycle - it is possible to see and measure the emissions.

A clever function - the Smart Detector - dramatically reduces test time and improves productivity: the receiver starts scanning with the fast peak detector then, when the reading is close to a selected limit it immediately turns to quasi-peak detector (or any other selected one), moves some frequency step back and measures with the new detector until the signal returns low; then the receiver turns back in peak mode and continues the scan at the

highest possible speed, repeating this process any time there's an over limit peak.

This "performance booster" was first introduced in PMM's receivers in 1990. To maintain calibration a signal reference is essential: a high stability internal RF Signal Generator (60 to 90 dB μ V in 0,1 dB steps) has been added to the PMM 9010.

This RF generator can work in tracking mode with the span or set at any frequency in the range of 10 Hz to 50 MHz: in addition to being the main reference for the receiver, it also makes the receiver an easy-to-use scalar network analyzer for characterizing components, antennas, filters etc.

To always keep your receiver perfectly calibrated, just send the generator module back to your Narda Dealer: a terrific advantage in terms of costs and speed.

After recalibration, this single module is easily reinstalled into the receiver to restart operations immediately after.

The PMM 9030 and PMM 9060 are innovative and different from this stand point: although they need an external frequency reference source for calibration check, the complete RF front-end only - a single, solid block module - can be sent to Factory the

same way.

Utilizing a digital receiver implementation, it's easy for such a receiver to integrate a single channel Click Receiver with no additional hardware required: an external option is required only to have a full 4 channels click evaluation.

Moreover, the huge memory of the receiver (required for storing each disturbance duration and interval and for post-process) is essential to be able to fulfill the recently modified click specifications approved by CISPR.

PMM

Configurations and application examples

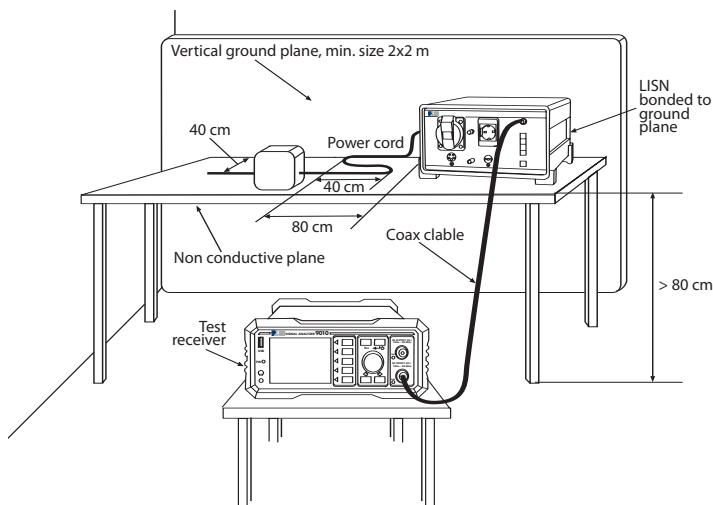

Example of Test Setup for RFI Voltage Measurement

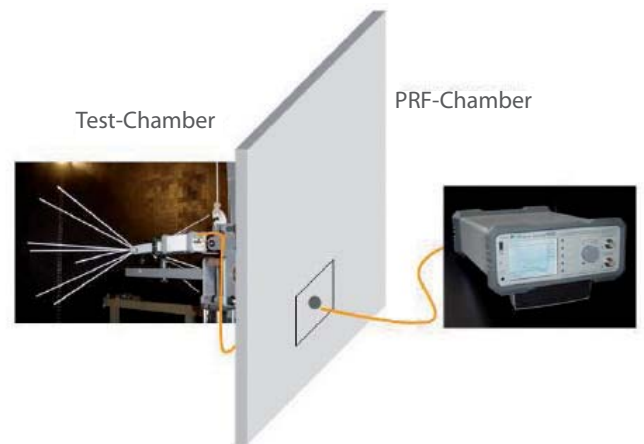

Radiated measurements with PMM 9030/9060 mounted directly on an antenna connector



PMM 9010

Conducted tests up to 30 MHz
Interference measurements with optional rod antenna



PMM 9010 + PMM 9030

All kinds of conducted and radiated measurements up to 3 GHz (CISPR 11 group 1; CISPR 11 group 2 with operating frequency < 400 MHz; CISPR 12; CISPR 13; CISPR 14-1; CISPR 22 when the highest internal source frequency is up to 500 MHz; future CISPR 32 when the highest internal source frequency is up to 500 MHz)



PMM 9010 + PMM 9060

Conducted and radiated measurements up to 6 GHz (as above plus: CISPR 22, any frequency of internal source; future CISPR 32, any frequency of internal source but except outdoor units of direct to home satellite receivers)

PMM 9010 as a Discontinuous Disturbance (Click) Analyzer

In the application of measurement of Discontinuous Conducted Disturbances (Clicks) the PMM 9010 EMI receiver equipped with the Click Option not only guarantees full compliance to the latest CISPR-14-1 requirements: thanks to its fully digital structure it offers superior stability and performance as an Automatic Click Analyzer featuring:

- wide memory to store each disturbance duration and interval as required by CISPR-14-1
- automatic evaluation of Click Rate N
- automatic use of Exceptions, if applicable
- automatic Click measurement using Upper Quartile Method
- exclusive Smart Measure function to speed up tests
- real time displaying of all events including click details
- generation of a Report with all mandatory data (and more)

Moreover, the PMM 9010 as a click Analyzer can be tailored to the users' requirements: from the basic single-channel solution, that's embedded in the PMM 9010 hardware and can be ordered and activated by the user at any time, up to the full four-channel configuration consisting of an external unit to connect to the PMM 9010 Receiver (single-channel Click option required).

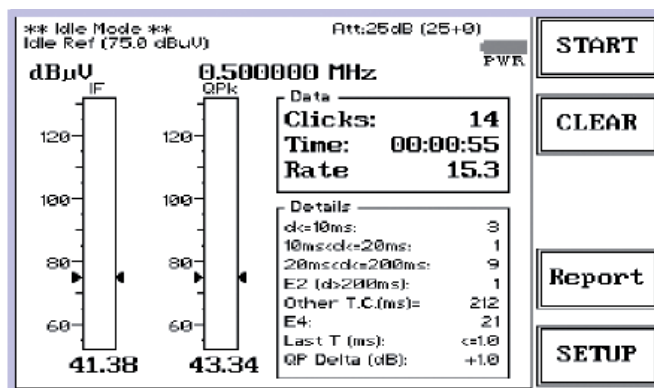

PMM 9010 with Click Option real-time display

Worst Line Search										
Line	Limit	10ms	20ms	0.2s	E4	o.t.c.	Total	Time	N	Worst
L3-1	75.0	3	1	5	0	1203	9	1.0	9.1	X
L3-2	75.0	2	0	0	0	241	3	0.2	17.2	.
L3-3	75.0	1	0	0	0	0	1	0.1	10.5	.
L3-N	75.0	0	0	9	0	0	9	0.4	24.1	.

Lq Calculation										
Freq	Limit	10ms	20ms	0.2s	E4	o.t.c.	Total	Time	N	+Lq
0.15	75.0	0	0	4	0	335	5	0.4	12.2	7.8
0.50	75.0	6	0	2	0	0	8	0.5	15.5	5.7

Final Test Report										
Freq	Lq	10ms	20ms	0.2s	E4	o.t.c.	Total	Time	Max	F/F
0.15	82.8	0	0	0	0	0	0	0.4	1	Pass
0.50	80.7	0	0	0	0	212	1	0.5	2	Pass
1.40	80.7	0	0	0	0	0	0	0.5	2	Pass
30.00	80.7	0	0	0	0	0	0	0.5	2	Pass

PMM 9010 with Click Option automatic Test Report

PMM 9010 + Click Meter (option)

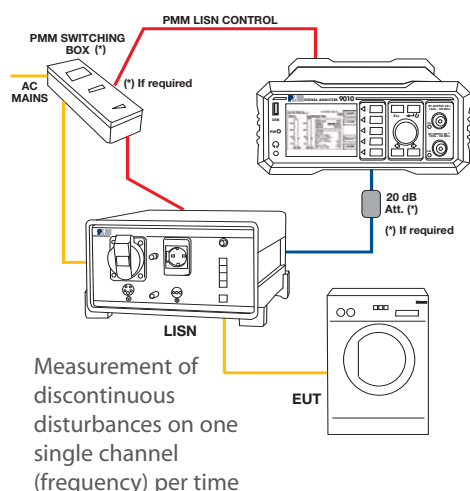

PMM 9010 + 4 channels Click Meter Adapter (option)

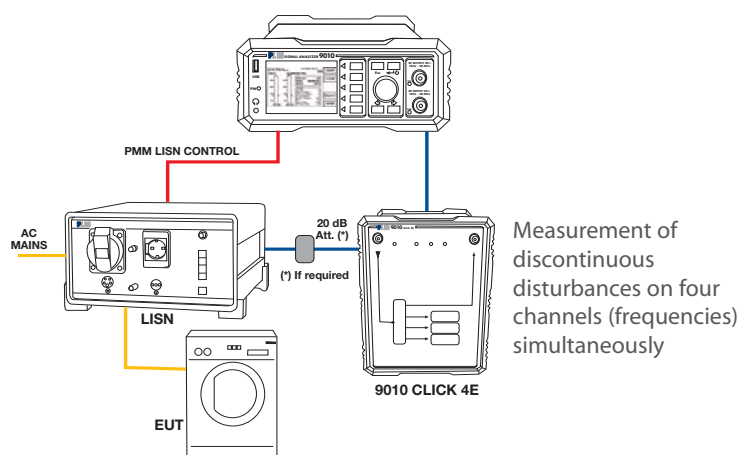



PMM 9010/9030/9060 Emission Suite PC software

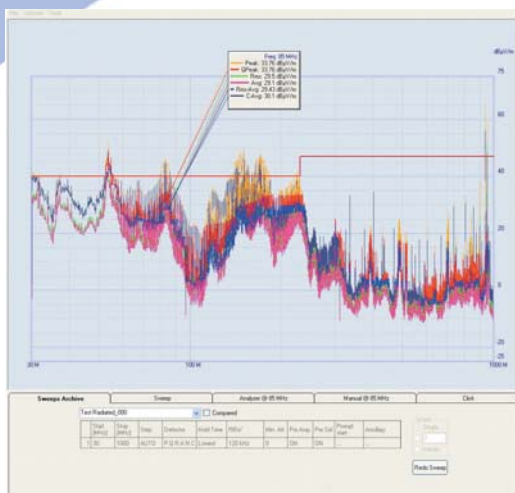

A powerful Software Utility that control the PMM 9010, PMM 9030 and PMM 9060 receivers and enables extremely useful functions to control measurements as well as to collect, analyze and post-process data safely and easily as never before. These pictures show just some examples of the most commonly required functions, with some of them specific to PMM's receivers.

SIMULTANEOUS DETECTORS IN REAL TIME - ALL SIX CISPR detectors!

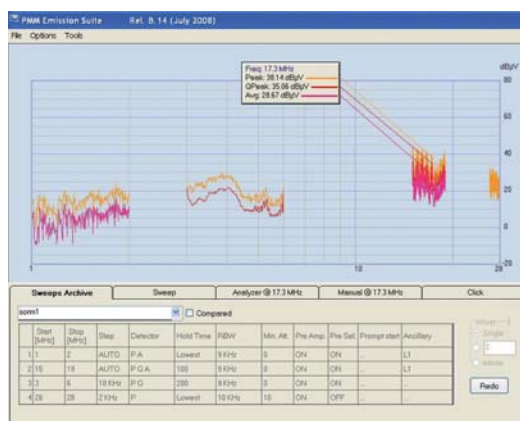

POWERFUL SCAN TABLE allowing any combinations of any measuring settings in any sequence to meet even the most demanding applications in terms of flexibility!

Useful Functions

Custom Limits

can be easily created, saved and recalled.

Cable losses, Antenna Factors and Absorbing Clamp Calibration Tables can be quickly created and computed during measurements.

"Smart Detector" function in Sweep Mode

Values measured by the fast Peak Detector and found exceeding the limits are immediately measured with the other detectors simultaneously and during the same sweep, thus providing an impressive time saving test.

Auto CISPR

when in Manual mode, the filter is selected automatically according to the frequency.

Spectrum Analyzer Function

The very high scan speed (<100 ms for full-span 10 Hz-30 MHz @ IF resolution 300 kHz), it is especially very useful for any kind of debugging with the outstanding performances of an EMI-specific instrument.

Scalar Network Analyzer Function

a powerful function useful for designers and test engineers, provides an easy-to-use scalar network analyzer for characterizing components, filters and much more.

TEM and G-TEM Correlation Program

is the best way to use the PMM receiver for simulating radiated emission tests in an OATS.

Fast and precise, this feature is already built in the PMM software.

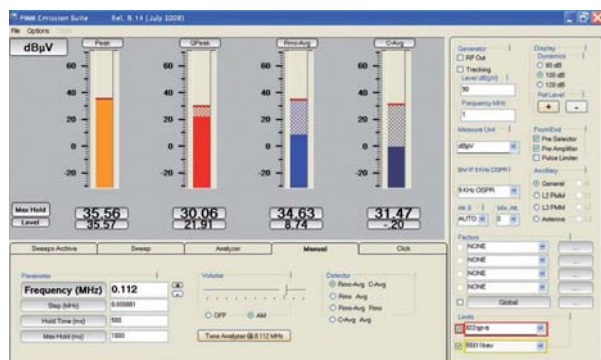

MANUAL mode: up to four simultaneous detectors

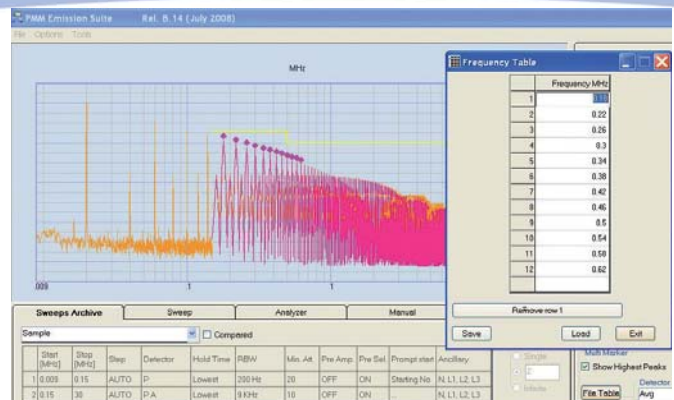

PEAKS FINDER with generation of Frequency tables

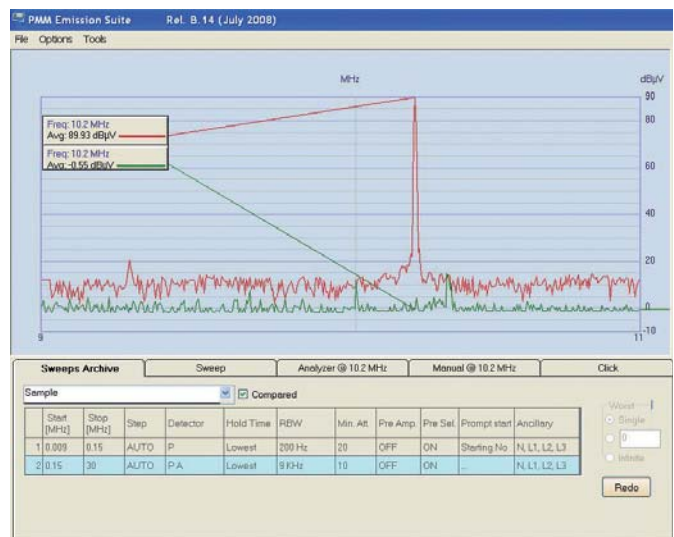

COMPARE function of stored measurements

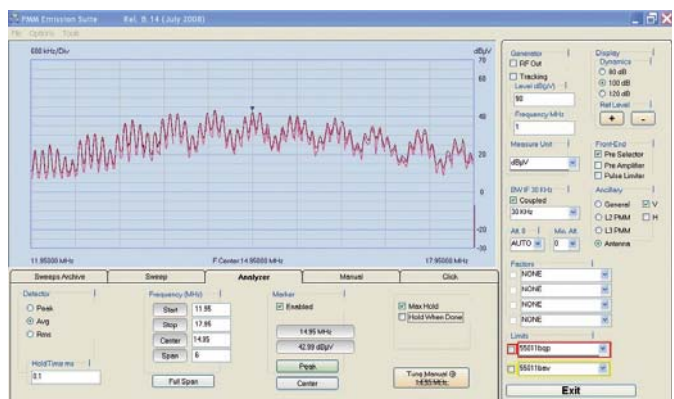

ANALYZER mode for fast and accurate debugging

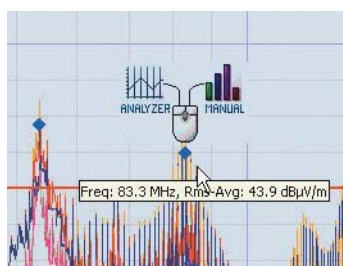

Just one click to move across functions

User-upgradeable Firmware

A simple utility included in the PMM Emission Suite CD allows the user to upgrade the firmware of his own PMM receiver whenever required by future standards, measuring features and test solutions. A dedicated operating system allows the PMM 9010 to be ready to use just few seconds after power on.

An exclusive "parking memory" makes upgrading the PMM Receivers Firmware totally failsafe against unexpected interruptions that may occur during downloading.



Technical Specifications

PMM 9010 - CISPR 16-1-1 & MIL-STD-461F Compliant

Frequency range Resolution Reference frequency	10 Hz to 30 MHz 0,1 Hz < 1 ppm	Display units Displayed dynamic	dBm, dB μ V, (dB μ A, dBpW, dB μ V/m, dB μ A/m by PMM Emission Suite) 80, 100, 120 dB selectable
RF input VSWR 10 dB RF att. 0 dB RF att. Attenuator Preamplifier gain Pulse limiter	Zin 50 Ω , BNC fem. < 1,2 < 2 0 dB to 35 dB (5 dB steps) 20 dB (after preselector) Built in (selectable)	Spectrum Analyzer mode Span/division	100 Hz \div 3 MHz
Max input level (without equipment damage) Sinewave AC voltage Pulse spectral density	137 dB μ V (1 W) 97 dB μ V/MHz	Measurement accuracy	S/N > 20 dB 10 Hz to 9 kHz \pm 1,0 dB Typ. 9 kHz to 30 MHz \pm 1,0 dB
Preselector Frequency ranges	(One LP and six BP filters) < 9 kHz 9 kHz to 150 kHz 150 kHz to 500 kHz 500 kHz to 3 MHz 3 MHz to 10 MHz 10 MHz to 20 MHz 20 MHz to 30 MHz	RF output Tracking & CW Generator Frequency range Level Level accuracy (10 Hz to 30 MHz)	Zout 50 Ω , BNC fem. 10 Hz to 50 MHz 60 to 90 dB μ V (0.1 dB step) \pm 0,5 dB
IF bandwidth 3 dB bandwidth 6 dB bandwidth	3, 10, 30, 100, 300 kHz 0,2 and 9 kHz (CISPR 16-1-1) 10, 100 Hz; 1, 10 kHz (MIL-STD-461) (100 kHz, 1 MHz MIL-STD-461 when operated with 9030 or 9060)	Demodulation	AM; volume setting by knob
Noise level (Preamplifier ON)	9 - 150 kHz < -8 dB μ V (QP) (200 Hz BW) < -15 dB μ V (AV) 0,15 - 30 MHz < -4 dB μ V (QP) (9 kHz BW) < -10 dB μ V (AV)	Autocalibration	Internal reference source
Detectors (simultaneous on PMM Emission Suite)	Peak, Quasi-Peak, Average, RMS, RMS-Average, C-Average, APD Smart Detector function	I/O Interface	RS-232 High Speed Optical (2 channels; 2nd for future extension) USB Rear USB Front (future extension) User Port (drives PMM LISNs) Bluetooth (optional) IEEE-488 (optional)
Level measuring time (Hold time)	CISPR 16-1-1 as default Variable, 1 ms to 30 sec.	Click meter (Optional)	1 to 4 simultaneous channels Full compliant to EN 55014-1
Stand-alone display & measure functions	Marker; marker peak; marker to center; highest peaks; move peak to Analyzer & Manual modes Store & Load: - up to 11 traces (sweep mode) - two panels - 4 conversion factors Built-in limits: CISPR 11, 14, 22 Battery charge and voltage Display style, contrast, backlight Click functions (option required)	Operating temperature	0° to 40°C
		Power supply	10 - 15 Vdc, 2.5A Li-Ion rechargeable plug-in battery (8h avg. duration) AC universal adapter/charger
		Dimensions	235x105x335 mm
		Weight	4,1 kg

PMM 9030 - PMM 9060 (CISPR 16-1-1 & MIL-STD-461F Compliant)

	PMM 9030	PMM 9060
Frequency range Resolution Reference frequency	30 MHz to 3 GHz 100 Hz < 2 ppm	30 MHz to 6 GHz 100 Hz < 2 ppm
RF input VSWR 10 dB RF att. 0 dB RF att. Attenuator Preamplifier gain	Z _{in} 50 Ω, N fem. < 1,2 ; < 2 over 1 GHz < 2 0 dB to 55 dB (5 dB steps) 10 dB	Z _{in} 50 Ω, N fem. < 1,2 ; < 2 over 1 GHz; < 3 over 3 GHz < 2; < 3 over 3 GHz 0 dB to 55 dB (5 dB steps) 20 dB, 30 MHz - 1 GHz; 15 dB > 1 GHz
Max input level (without equipment damage) Sinewave AC voltage Pulse spectral density	137 dBμV (1 W) 97 dBμV/MHz	137 dBμV (1 W) 97 dBμV/MHz
Preselector Frequency ranges	(Three tracking and one bandpass filters) 30 MHz to 96,6 MHz 96,6 MHz to 311,0 MHz 311,0 MHz to 1000 MHz 1 GHz to 3 GHz	(Four tracking and two bandpass filters) 30 MHz to 72 MHz 72 MHz to 173 MHz 173 MHz to 416 MHz 416 MHz to 1 GHz 1 GHz to 3 GHz 3 GHz to 6 GHz
IF bandwidth	3, 10, 30, 100, 300 kHz, 6 dB bandwidth 120 kHz (CISPR 16-1-1), 6 dB bandwidth 1 MHz (CISPR 16-1-1), B-imp	3, 10, 30, 100, 300 kHz, 6 dB bandwidth 120 kHz (CISPR 16-1-1), 6 dB bandwidth 1 MHz (CISPR 16-1-1), B-imp
Noise level (Preamplifier OFF)	30 to 300 MHz < 5 dBμV (QP) (120 kHz BW) < 1 dBμV (AV) 300 to 3000 MHz < 8 dBμV (QP) (120 kHz BW) < 4 dBμV (AV)	30 to 300 MHz < 10 dBμV (QP) (120 kHz BW) < 7 dBμV (AV) 300 to 3000 MHz < 13 dBμV (QP) (120 kHz BW) < 7 dBμV (AV) 3000 to 6000 MHz < 15 dBμV (QP) (120 kHz BW) < 10 dBμV (AV)
 (Preamplifier ON)	30 to 300 MHz < -1 dBμV (QP) (120 kHz BW) < -5 dBμV (AV) 300 to 3000 MHz < 2 dBμV (QP) (120 kHz BW) < -2 dBμV (AV)	30 to 300 MHz < -20 dBμV (AV) (10 kHz BW) 300 to 3000 MHz < -18 dBμV (AV) (10 kHz BW) 3000 to 6000 MHz < -12 dBμV (AV) (10 kHz BW)
Spurious response	< 10 dBμV, < 15 dBμV over 1 GHz	< 10 dBμV, < 15 dBμV over 2 GHz
Measurement uncertainty Worst case @ S/N > 20 dB	30 to 1000 MHz ± 1,0 dB 1 to 3 GHz ± 1,5 dB	30 to 1000 MHz ± 1,0 dB 1 to 3 GHz ± 1,5 dB 3 to 6 GHz ± 2,0 dB
I/O Interface	High Speed Optical RS-232 (for maintenance only)	High Speed Optical RS-232 (for maintenance only)
Operating temperature	0° to 40°C	0° to 40°C
Power supply	10 - 15 Vdc, 2.5A Li-Ion rechargeable & interchangeable battery (4h avg. duration) AC universal adapter/charger	10 - 15 Vdc, 2.5A Li-Ion rechargeable & interchangeable battery (4h avg. duration) AC universal adapter/charger
Dimensions	235x105x105 mm	235x105x105 mm
Weight	2 kg	2,2 kg

Ordering information

9010	EMI receiver 10 Hz - 30 MHz, CISPR 16-1-1 full-compliance 9 kHz - 30 MHz, including: - internal tracking generator - battery pack, AC adapter/charger - PC software PMM Emission Suite - Control cables (USB, RS-232), BNC-BNC cable
9030	Extension unit 30 MHz - 3 GHz for model 9010, CISPR 16-1-1 full-compliant, including: - 20 m fiber optic cable - battery pack with charger - antenna holder with adapters for BC-01, LP-02 and other models (ref. to manual) - N-male—N-male; N-male-BNC fem. adapters - SPA-01, plug-in AC supply adapter (replaces battery) for continuous operation
9060	Extension unit 30 MHz - 6 GHz for model 9010, CISPR 16-1-1 full-compliant, including: - 20 m fiber optic cable - battery pack with charger - antenna holder with adapters for BC-01, LP-02 and other models. (ref. to manual) - N-male-N-male; N-male-BNC fem. adapters - SPA-01, plug-in AC supply adapter (replaces battery) for continuous operation

Optional accessories and functions

9010/MIL	MIL-STD-461F RBW Filters
9010/CLICK	1-channel Click Analyzer function, CISPR 14-1: 2005 full-compliance, including: - Switching Operation Box, control cables - 2x20 dB attenuator NOTE: field-installable function (advice 9010 S/N for upgrading confirmation)
9010/CLICK4E	External box to connect to a receiver 9010 equipped with 9010/click option. Allows four-channel simultaneous click measurements according to CISPR-14-1-1. AC power only.
9010/BTA	RS-232 to Bluetooth adapter for 9010
9010/GPIB-232CV-A	RS-232 to GPIB (IEEE-488) external adapter for 9010
BP01	Spare Li-Ion Battery Pack for 9010 & 9030
9010/AC	AC adapter/charger for BP01, 9010, 9030
9010/FO-20	20 m fiber optic cable for 9030
9010/FO-50	50 m fiber optic cable for 9030
9010/FO-100	100 m fiber optic cable for 9030
9010/CC	Rigid carrying case for 9010
9010/UKAS UKAS	CISPR-16-1-1 accredited calibration certificate for 9010
9030/UKAS UKAS	CISPR-16-1-1 accredited calibration certificate for 9010 & 9030
9010/UKAS-Click	UKAS accredited calibration certificate for 9010 + 9010/Click according to CISPR-16-1-1 & CISPR-14-1

A wide range of PMM original accessories and ancillary equipments are available, making the PMM 9010 the complete measuring solution for almost all applications.

- L1-150: Single line LISN, 150A
- L2-16: Two lines, Single phase, 16A LISN
- L3-32: Four lines, 3-phase, 32A LISN
- L3-64: Four lines, 3-phase, 64A LISN
- L3-100: Four lines, 3-phase, 100A LISN
- L3-500: Four lines, 3-phase, 350A LISN
- SHC-1: 35 dB CISPR Voltage probe, 1500 Ω
- SHC-2: 30 dB CISPR Voltage probe, 1500 Ω
- RA-01: Rod Antenna (10 kHz – 30 MHz)
- BC-01: Biconical Antenna 30-200 MHz
- LP-02: Log Periodic Antenna 200 MHz-2700 MHz
- TR-01: Wooden tripod for PMM Antennas

PMM 9010 can also be used with other accessories available on market: LISN, any type; Antennas and Loops; Near Field Probes; TEM/GTEM Cells.

PMM's LISN are controlled by PMM 9010 receiver to automatically select the lines to measure



Narda Safety Test Solutions srl
Via Leonardo da Vinci, 21/23
20090 Segrate (MI) ITALY
Phone: +39 02 26 998 71
Fax: +39 02 26 998 700
E-Mail: support@narda-sts.it
www.narda-sts.it