



**Advanced Test Equipment Rentals**  
**www.atecorp.com 800-404-ATEC (2832)**

**AQ6317B**  
**OPTICAL SPECTRUM ANALYZER**  
**INSTRUCTION MANUAL**

**ANDO ELECTRIC CO., LTD**

© Copyright ANDO ELECTRIC CO., LTD. JAPAN 2000

**AS-62573 Rev. 1.1**

# WARRANTY

ANDO ELECTRIC' products are shipped after they undergo severe inspection by the ANDO's Quality Assurance System. However, in case any failure due to a manufacturing fault or an accident occurring during transportation occurs, please contact our Service Department, Head Office Sales Department, or your nearest branch or business office.

The term of warranty is one year after the date of delivery. We are making repairs free of charge on failures that occur within this term. However, a failure due to the user's misoperation or modification or change, or a failure or damage due to a natural disaster is excepted from the said free repair service even if it occurs within the term.

# MEANINGS AND USAGE OF MENTIONED MATTERS

This manual uses the following hazard identification markings that the operators and service personnel must be aware of all hazards associated with this system.

## 1. DANGER, CAUTION, NOTE, FOOTNOTE

### (1) Degree of Importance of Information

The degree of importance of each information conforms to the order of DANGER > CAUTION > NOTE > FOOTNOTE on the basis of the meanings of them shown in (2).

### (2) Meanings of hazard information

- DANGER : This corresponds to a danger that may directly affect people's lives and is the special information to be most emphasized.
- CAUTION : This is a possibility that the equipment may be damaged and gives advice on the possibility that the equipment operation may be interrupted.
- NOTE : This is a supplementary explanation about "exception", "correction" or "limitation" of the text and is information other than DANGER, WARNING, CAUTION and FOOTNOTE.
- FOOTNOTE : This is a note of reference to be placed below the text on a same page in supplementary explanation about terminologies used in this manual. It is so arranged to be referenced by a combination of a "(NOTE)" and number.

## 2. Reference Guide

This guide indicated items to be referenced. References are shown by arrow, item number and item name as "→ 2.1.2 Operation checks".

## 3. Representation of Operating keys in the Text

Operating keys are represented as follows:

- [       ] : Denotes a panel switch.
- <       > : Denotes a soft key.

# Precautions for Safety

- Before using this equipment, be sure to read through the "Precautions for Safety" and operation manual to ensure its correct operation.
- After reading these documents, keep them handy so that anyone can read them at any time.

## 1. Restrictions on Using Environment

- Be careful in that no water mixes in this equipment to be free from getting wet. Otherwise, it can cause a fire, electric shock or fault.
- When this equipment is used in a dampen place, be sure to connect it to the earth.

## 2. Restrictions on Using Conditions

- Do not use this equipment beyond the specified supply voltage. Otherwise, it causes a fire, electric shock or fault.
- When this equipment is connected to a commercial power supply, connect it directly to an exclusive plug socket without fail. Do not use any extension cord, since it fears to cause a risk of heating or igniting.

## 3 Setup and Installation

### 3.1 Cautions to Personnel who Sets Up and Installs this Equipment

- Do not put many loads on one electrical outlet to avoid causing a fire or heating.
- Be sure to insert a power plug into its socket surely. If a metal piece or the like touches to the blade of the power plug socket, it causes a fire or electric shock.
- When the equipment is installed on a product with caster (dolley, etc.), be sure to lock the caster. If the product moves or falls down, it can cause a physical injury.

### 3.2 Restrictions or Prohibitions in Installing Environment and Conditions

- Do not place this equipment at a place where is fairly damp or dusty. Otherwise, it can cause an electric shock or fault.
- Do not put this equipment in a unstable place such as a shaky table or inclined location to avoid it falling down or bringing down. If does, it can cause aphysical injury.
- Do not put this equipment at a place where is subject to vibration or shock. If it falls down or brings down, it can cause a physical injury.
- Do not insert or drop a metal piece, etc., into the equipment interior from its opening section. If does, it can cause a fire, electric shock or fault.
- Do not put a power cord close an electric heater. If does, the cord coating might melt, causing a fire or electric shock in some cases.

- When pulling out a power plug, be sure to do it by holding the plug. If the power cord is pulled, it damages the cord and can cause a fire or electric shock.
- Do not insert or pull out a power plug with wet hands. If does, it can cause an electric shock.
- Do not place this equipment at a place where is exposed to the direct sunlight or where is high in temperature. If does, the internal temperature raises and it can cause a fire in some cases.

### 3.3 Prohibited Items in Equipment Installing Methods

- When moving this equipment, first pull out the power plug from its socket, and after making sure that its external connecting cords have been all removed, move the equipment. Otherwise, it can damage the cord and cause a fire or electric shock.
- Do not block the air hole of this equipment. Blocking it can cause a heat to be accumulated inside of the equipment, causing a fire in some cases.
- Do not damage, break down or rework a power cord. If a heavy article is put on the power cord, or if the cord is heated or pulled, the power cord is damaged, causing a fire or electric shock.

## 4 Preparations before Use

- Read through the operation manual (Chapter 2) carefully.

## 5 Using Methods

- Use this equipment following the procedures given in the operation manual.
- When a warning mark ([NOTE], [WARNING] or [DANGER]) is indicated, use this equipment following the instructions given in the operation manual.
- Do not put any container filled with water, etc., or a small metal piece on or near this equipment. If the water overflows or gets in this equipment, it can cause a fire, electric shock or fault.
- Do not rework, bend, twist or pull a power cord forcibly. If does, it can cause a fire or electric shock.
- Do not disassemble or remodel this equipment. If does, it can cause a fire, electric shock or fault.
- When this equipment is not used for a long period of time, be sure to keep the plug socket removed. If not, it can cause a fire, electric shock or fault due to a lightning.
- When the lid of printer is closed for replacement of recording paper, etc., be careful not to pinch or hurt one's finger. Also, attention be paid to the cutter section of printer.

## 6 Maintenance and Inspection

- It is recommended to conduct a periodical maintenance and inspection for this equipment. If this equipment is left for a long period of time without cleaning it with dust accumulated inside, it can cause a fire or fault in some cases. If you have any consultations in this respect, please contact the closest agent of our company listed at the end of the operation manual.

## 7 Remedial Actions Taken when Any Error Occurs

- When the power cord is damaged, ask our agent to replace it. If a damaged cord is used as it is, it can cause a fire or electric shock.
- When a foreign matter mixes into this equipment, first turn off the power switch of its main unit, pull out the power plug from its socket, and then contact our agent. If the defective equipment is used as it is, it can cause a fire, electric shock or fault.
- When this equipment is used under any abnormal conditions, e.g., giving out smoke or offensive smell, it can cause a fire, electric shock or fault. In such a case, turn off its power switch immediately and then pull out the power plug from its socket, and after making sure that no smoke is given out any more, ask our agent to repair the equipment. Do not repair it by the user himself to avoid any danger from occurring.
- If this equipment is dropped down or damaged, turn off the power switch of the main unit of this equipment, pull out the power plug from its socket, and then contact our agent. If the defective equipment is used as it is, it can cause a fire, electric shock or fault.
- If the fan motor of this equipment is over-heated, turn off the power switch of the main unit, pull out the power plug from its socket, and then contact our agent. If the motor is used as it is, it can cause a fire, electric shock or fault.

# LASER SAFETY

## Initial Safety Information for AQ6317B.

The specifications for this equipment are as follows.

	AQ6317B
Laser class	LED
Laser class According to 21 CFR 1040.10(Canada, USA)	1
Laser class According to EN60825-1: 1994+All : 1996(Europe)	1
Maximum output power	-10 dBm
Beam diameter	10 $\mu$ m
Numerical aperture	0.1
Wavelength	1530 $\pm$ 20 nm

### NOTE

Canada, USA

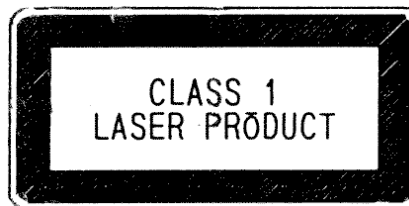

The laser safety warning labels are fixed on the optical unit.

### NOTE

Europe

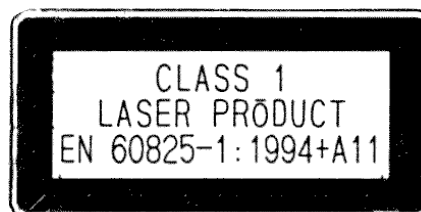

## PRECAUTIONS ON MOUNTING A FUSE

When mounting fuses again after you have removed the fuse holder for replacing or checking a fuse, make sure to push in the holder until height of its face becomes even with that of the filter body (see the figure below).

While you are inserting a fuse holder, you will feel a click from this noise filter equipped (with an inlet) used on this equipment. This noise filter is supplied from Schaffner Co.,Ltd. Note, however, that this feeling can differ among the filters.

If you stop the insertion when you felt this click, an incomplete electric contact or no electric contact will result, potentially resulting in blowing the fuse. Thus, reasonable care must be exercised in this operation.

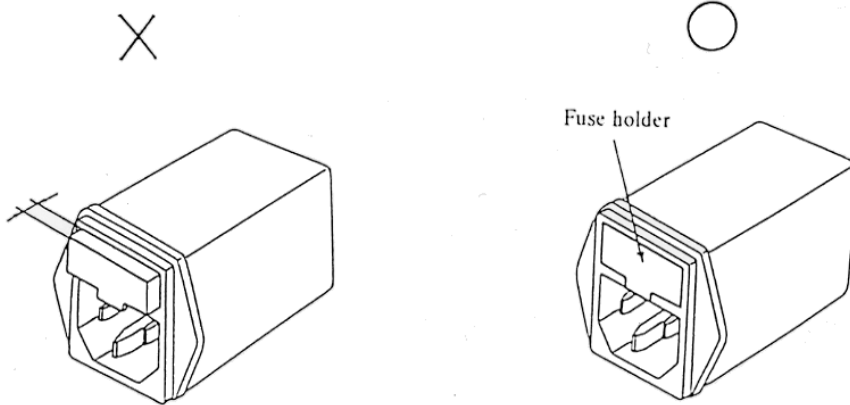
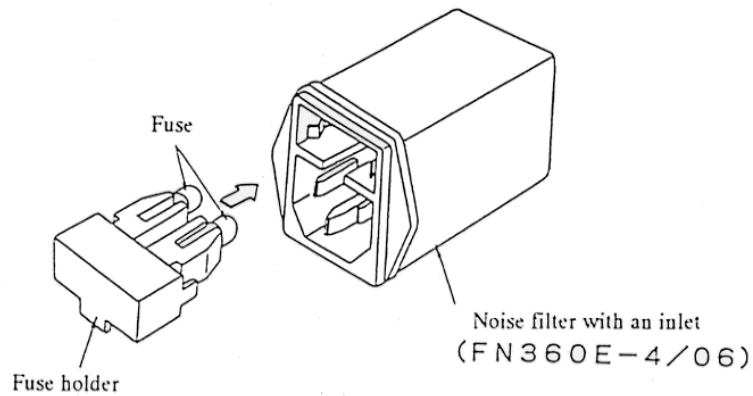

Push in the fuse holder in such that height its surface becomes even with that of the filter body.



# PREFACE

This Manual describes the operating procedures and maintenance of the AQ6317B Optical Spectrum Analyzer. When you desire to know the features and functions of this equipment, read through this manual starting from Chapter 1.

The user who is operating this equipment for the first time, be sure to read Chapter 2 "Preparations before Use". Regarding the operating procedures of this equipment, its functions are described in Chapter 4 "Usage" and Chapter 5 "Details of Functions" and they are concretely described in Chapter 8 "Examples of Measurement" including case study.

Periodic inspection of the equipment is indispensable for maintaining it in the normal condition. Please refer to Chapter 11 "Maintenance" that describes mechanical inspection and operation check methods.

To know the principle of operation, refer to Chapter 10 "Principle and Circuit Configuration".

This Manual is described on a basis of an easy-to-understand organization, using concrete applications and illustrations for the explanation of operating procedures.

We wish you to make the most of the functions of this equipment obtaining its full performance.

## PRECAUTIONS

- Lithium batteries are used in the memory of this analyzer and the backup circuit of the clock.
- Because the analyzer may malfunction when the lives of the batteries come to an end even if it can be used normally, replace the batteries after the lapse of about 7 years.
- The replaced batteries will be taken over by us. At that time, please contact us (head office, branch or business office).

# CONTENTS

Chapter 1	GENERAL.....	1-1
1.1	Outline of Equipment.....	1-2
1.2	Specifications .....	1-2
1.3	Options .....	1-2
1.4	Configuration .....	1-2
1.5	Precautions on Handling .....	1-8
1.5.1	Operating temperature range.....	1-8
1.5.2	Environmental conditions .....	1-8
Chapter 2	PREPARATIONS BEFORE USE .....	2-1
2.1	Unpacking and Acceptance Inspection .....	2-2
2.1.1	Mechanical checks.....	2-2
2.1.2	Operation checks .....	2-2
2.2	Action to Be Taken upon Detection of Damage or Abnormality.....	2-2
2.3	Preparations and General Precautions .....	2-3
2.4	Safety Measures for Power Supply .....	2-4
2.4.1	Polarity of power cord .....	2-4
2.4.2	Protective earthing .....	2-5
2.4.3	Fuse replacement .....	2-6
2.5	Precautions in Use .....	2-6
2.6	Precautions on Storage .....	2-7
2.6.1	Precautions before storage.....	2-7
2.6.2	Recommendable storage conditions .....	2-7
2.7	Repacking and Transportation .....	2-8
2.7.1	Repacking .....	2-8
2.7.2	Transportation.....	2-8
Chapter 3	DESCRIPTION OF FUNCTIONS.....	3-1
3.1	Names and Functions of Panels .....	3-2
3.2	Software Functions.....	3-5

Chapter 4	USAGE .....	4-1
4.1	Preparations and Operation Checks .....	4-2
4.1.1	Preparations before powering ON .....	4-2
4.1.2	Connections to other units .....	4-2
4.1.3	Power ON and screen display.....	4-3
4.1.4	Stop procedure .....	4-4
4.2	Operations.....	4-5
4.2.1	Description of screen .....	4-5
4.2.2	Description of means for entering parameters .....	4-6
4.2.3	Soft key execute form .....	4-8
4.2.4	"WARNING" display.....	4-8
Chapter 5	DETAILS OF FUNCTIONS .....	5-1
5.1	Detailed Description of [FUNCTION] Section.....	5-3
5.1.1	[SWEEP] switch .....	5-3
5.1.2	[CENTER] switch (In wavelength display mode) .....	5-6
5.1.3	[CENTER] switch (In frequency display mode).....	5-10
5.1.4	[SPAN] switch (In wavelength display mode).....	5-13
5.1.5	[SPAN] switch (In frequency display mode).....	5-16
5.1.6	[LEVEL] switch .....	5-19
5.1.7	[SETUP] switch .....	5-26
5.1.8	[MARKER] switch.....	5-31
5.1.9	[PEAK SEARCH] switch.....	5-38
5.1.10	[ANALYSIS] switch.....	5-42
5.1.11	[TRACE] switch .....	5-73
5.1.12	[DISPLAY] switch .....	5-85
5.1.13	[MEMORY] switch.....	5-94
5.1.14	[FLOPPY] switch .....	5-100
5.1.15	[PROGRAM] switch .....	5-120
5.1.16	[SYSTEM] switch .....	5-128
5.1.17	[ADVANCE] switch.....	5-144
5.1.18	[USER] switch .....	5-153
5.1.19	[HELP] switch.....	5-153
5.1.20	[COPY] switch .....	5-153
5.1.21	[FEED] switch .....	5-155
5.1.22	[AUXILIARY] switch .....	5-155

5.2	Detailed Description of Measuring Functions .....	5-156
5.2.1	Pulse light measuring function .....	5-156
5.2.2	Power meter function .....	5-158
5.2.3	Analog output function .....	5-159
5.2.4	Power density display function .....	5-159
5.3	Detailed Description of Analysis Function .....	5-161
5.3.1	NF measuring function .....	5-161
5.3.2	Curve fit function .....	5-164
5.3.3	WDM analysis function .....	5-165
5.3.4	WDM-NF analysis function .....	5-172
5.3.5	Optical Filter analysis function .....	5-175
5.4	Spectrum Width data calculation Algorithm .....	5-179
5.4.1	Envelope method .....	5-179
5.4.2	Threshold method .....	5-181
5.4.3	RMS (effective value) method .....	5-182
5.4.4	Notch width measurement methods .....	5-183
5.5	LONG TERM Measurement .....	5-185
5.5.1	Overview .....	5-185
5.5.2	Parameter setting .....	5-185
5.5.3	Condition setting .....	5-187
5.5.4	Measurement .....	5-187
5.5.5	Display of measurement results .....	5-188
5.5.6	ALL CHANNEL display .....	5-189
5.5.7	SINGLE CHANNEL display .....	5-193
5.6	Synchronous measurement function with the variable wavelength light source ....	5-195
5.6.1	Outline .....	5-195
5.6.2	Connections .....	5-195
5.6.3	Operation .....	5-195
5.6.4	Precautions .....	5-196
5.7	Video Output Specifications .....	5-197
5.8	Nonvolatile Data Initialize Function .....	5-198
5.9	Wavelength Calibrate Function .....	5-199
5.10	Setting Clock .....	5-199
5.11	WARNING Display Function .....	5-199

Chapter 6	PROGRAM FUNCTION .....	6-1
6.1	Outline .....	6-2
6.2	Program Input.....	6-3
6.2.1	Program name input and change .....	6-4
6.2.2	Program input and change.....	6-5
6.2.3	Registered command parameter section change .....	6-9
6.2.4	Line insertion and deletion and program list print .....	6-9
6.3	Program Copy .....	6-11
6.4	Program Deletion .....	6-12
6.5	Program Execution.....	6-13
6.5.1	Executable program selection.....	6-13
6.5.2	Program execution.....	6-14
6.5.3	Program pause .....	6-15
6.5.4	Program execute error .....	6-15
6.6	Description of Commands.....	6-18
6.6.1	Description of variables.....	6-18
6.6.2	Rule of four operations by variables .....	6-20
6.6.3	Specifications of "@=VAL (A\$)" command .....	6-20
6.7	Program Examples.....	6-51
Chapter 7	FLOPPY DISK FUNCTIONS .....	7-1
7.1	Floppy Disk Functions .....	7-2
7.1.1	Outline.....	7-2
7.1.2	Loading/Unloading a floppy disk .....	7-3
7.2	Storing into a Floppy Disk.....	7-4
7.3	Reading from a Floppy Disk .....	7-11
7.4	File List Display .....	7-16
7.5	File Deletion.....	7-17
7.6	Floppy Disk Initialization .....	7-18
7.7	File Formats .....	7-20
7.7.1	Waveforms files .....	7-20
7.7.2	Data files .....	7-25
Chapter 8	MEASUREMENT EXAMPLES .....	8-1
8.1	Basic Measurement.....	8-2
8.1.1	Measurement by the [SWEEP] switch, <AUTO>key .....	8-2
8.1.2	Measurement by manual operations.....	8-4
8.1.3	Measuring sensitivity selection.....	8-6

8.1.4	Averaging times selection .....	8-8
8.2	Applied Measurement .....	8-9
8.2.1	Spectral width measurement .....	8-9
8.2.2	SMSR measurement .....	8-11
8.2.3	Loss wavelength characteristic measurement.....	8-13
8.2.4	Optical filter transmission factor measurement .....	8-18
8.3	PMD Measurement .....	8-21
8.3.1	Overview .....	8-21
8.3.2	Measurement system.....	8-21
8.3.3	Measurement procedure.....	8-21
8.4	Usage of Markers .....	8-23
8.4.1	Marker names .....	8-23
8.4.2	▽ marker .....	8-23
8.4.3	Wavelength line marker .....	8-25
8.4.4	Level line marker.....	8-26
8.4.5	Auto search.....	8-27
8.4.6	Wavelength difference and level difference measurement.....	8-28
8.5	Convenient Functions.....	8-29
8.5.1	Marker-to-marker sweep function .....	8-29
8.5.2	Marker-to-marker power measurement function .....	8-31
8.5.3	0 nm sweep function .....	8-32
8.5.4	Normalization display function .....	8-34
8.5.5	Three-dimensional display function .....	8-35
<b>Chapter 9 GP-IB FUNCTIONS.....</b>		<b>9-1</b>
9.1	GP-IB 1 Port and GP-IB 2 Port.....	9-2
9.2	Usage of GP-IB 1 Port.....	9-3
9.2.1	Interface functions of GP-IB 1 port .....	9-3
9.2.2	Connection to GP-IB system.....	9-3
9.2.3	Address setting .....	9-4
9.2.4	Local/remote function.....	9-4
9.2.5	Program codes (commands) .....	9-4
9.2.6	Output data .....	9-41
9.2.7	Service request function .....	9-59
9.2.8	Precautions on programming.....	9-61
9.2.9	Programming examples.....	9-62

9.3	Usage of GP-IB 2 Port.....	9-71
9.3.1	Interface functions of GP-IB 2 port .....	9-71
9.3.2	Connection to GP-IB system.....	9-71
9.3.3	Address setting .....	9-72
9.3.4	Wavelength variable light source control .....	9-72
9.3.5	External unit control .....	9-72
 Chapter 10 PRINCIPLE AND CIRCUIT CONFIGURATION .....		 10-1
10.1	Configuration and Principle of Monochromator.....	10-2
10.1.1	Principle of monochromator.....	10-2
10.1.2	Signal detector .....	10-3
10.2	Circuit Configuration.....	10-4
10.3	Precautions on Measurement .....	10-5
10.3.1	Types of optical fiber usable in this equipment.....	10-5
10.3.2	Restriction on resolution .....	10-5
10.3.3	Absolute level accuracy .....	10-6
10.3.4	Effective range of level axis when the measuring sensitivity is set to NORMAL RANGE HOLD .....	10-6
10.3.5	Stray light in the SENS:NORMAL mode .....	10-7
10.3.6	Ripple around 1380 nm.....	10-8
10.3.7	Level accuracy below fiber cable cutoff wavelength (short wavelength) .....	10-8
10.3.8	Waveform observed in 0.01nm Resolution.....	10-8
10.3.9	Numerical Aperture (NA) of Input Optical Fiber and Level Measured Value .....	10-9
 Chapter 11 MAINTENANCE.....		 11-1
11.1	Mechanical Inspection.....	11-2
11.2	Operation Check .....	11-3
11.2.1	Check at power-on.....	11-3
11.2.2	Operation check of switches.....	11-3
11.2.3	Wavelength accuracy check .....	11-3
11.2.4	Level accuracy check.....	11-4



## Contents of Figure

Fig. 2-1	Three-core Power Control plug and Plug Socket.....	2-4
Fig. 2-2	Earthing by Conversion Adapter .....	2-5
Fig. 3-1	AQ6317B Optical Spectrum Analyzer .....	3-2
Fig. 3-2	AQ6317B Optical Spectrum Analyzer .....	3-3
Fig. 4-1	Initialize Screen .....	4-4
Fig. 4-2	Names of Screen Parts .....	4-5
Fig. 5-1	Power Range between Markers .....	5-44 to 45
Fig. 5-2	Setting Record Paper .....	5-154
Fig. 5-3	Results of LONG TERM Measurement.....	5-188
Fig. 5-4	WAVLEN Display ABSOLUTE .....	5-190
Fig. 5-5	WAVLEN Display RELATIVE .....	5-190
Fig. 5-6	LEVEL Display ABSOLUTE .....	5-191
Fig. 5-7	LEVEL Display RELATIVE .....	5-191
Fig. 5-8	SNR Display ABSOLUTE.....	5-192
Fig. 5-9	SNR Display RELATIVE.....	5-192
Fig. 5-10	Channel Selection Screen.....	5-193
Fig. 5-11	SINGLE CHANNEL Display ABSOLUTE .....	5-194
Fig. 5-12	SINGLE CHANNEL Display RELATIVE.....	5-194
Fig. 6-1	Screen Displayed by Pressing <PROGRAM EDIT> key.....	6-3
Fig. 6-2	Program Input Screen .....	6-5
Fig. 6-3	Screen Displayed by Pressing <PROGRAM EXECUTE> key.....	6-13
Fig. 6-4	Screen Displayed by Pressing <EXEC KEY DEFINE> key.....	6-14
Fig. 7-1	Floppy Disk and Drive .....	7-3
Fig. 8-1	Measurement Example by <AUTO> key.....	8-3
Fig. 8-2	Measurement Example Using Manual Operations .....	8-5
Fig. 8-3	Loss Wavelength Characteristic Measurement System .....	8-13
Fig. 8-4	Optical Filter Transmission Factor Measurement System .....	8-18
Fig. 8-5	PMD Measurement System .....	8-21
Fig. 8-6	PMD Measurement Result.....	8-22
Fig. 8-7	<PMD THRESH> Key and <MODE DIFF> Key .....	8-22
Fig. 8-8	Space Light Entering an Optical Fiber.....	8-32
Fig. 10-1	Basic Configuration of Monochromator.....	10-2
Fig. 10-2	Signal Detector Configuration .....	10-3
Fig. 10-3	Circuit Configuration of this Equipment.....	10-4
Fig. 10-4	Waveform Observed in the SENS:NORM Mode .....	10-7
Fig. 10-5	Waveform Observed in the SENS:HIGH1 Mode .....	10-7
Fig. 10-6	Waveform Observed in 0.01nm resolution .....	10-8
Fig. 10-7	Numerical Aperture of Input Optical Fiber and Level Error (Typical Characteristic).....	10-8

## Contents of Table

Table 1-1	Specifications .....	1-3 to 4
Table 1-2	Option List .....	1-6 to 7
Table 1-3	Standard Accessory List.....	1-7
Table 3-1	Description of Panel Functions .....	3-4
Table 5-1	Waveforms that Can be Stored into Memory.....	5-94
Table 5-2	Video Output Pin Connections (VGA compatible).....	5-197
Table 5-3	Initial Value of Nonvolatile Data .....	5-200 to 208
Table 5-4	WARNING message List .....	5-209 to 211
Table 6-1	Error Table for Program Execution .....	6-16 to 17
Table 6-2	Panel Switch Command List .....	6-21 to 44
Table 6-3	Special Command List .....	6-45 to 50
Table 7-1	Types and Sizes of Files .....	7-2
Table 7-2	Floppy Disk Capacity.....	7-2
Table 8-1	Measuring Sensitivity Selection.....	8-6
Table 8-2	Spectral Width Algorithms.....	8-9
Table 8-3	Method of Moving Wavelength Line Marker .....	8-25
Table 8-4	Method of Moving Level Line Marker .....	8-26
Table 9-1	Interface Functions of the GP-IB 1 port.....	9-3
Table 9-2	GP-IB Program Codes .....	9-5 to 40
Table 9-3	Delimiter Specifying Codes .....	9-41
Table 9-4	Output Data Formats.....	9-42 to 58
Table 9-5	Program Codes Related to SRQ Transmission .....	9-59
Table 9-6	Contents of Status Byte.....	9-60
Table 9-7	Interface Functions of GP-IB 2 Port .....	9-71
Table 10-1	Adaptability of Optical Fibers and Restrictions.....	10-5

## Attached Drawings

AQ6317B	Appearance of Optical Spectrum Analyzer .....	ASD-62573-1-1/4
AQ6317B	Front View of Optical Spectrum Analyzer .....	ASD-62573-1-2/4
AQ6317B	Rear View of Optical Spectrum Analyzer .....	ASD-62573-1-3/4
AQ6317B	Plane View of Optical Spectrum Analyzer .....	ASD-62573-1-4/4

# Chapter 1 GENERAL

This chapter describes an outline of this equipment.

## Contents of Chapter 1

1.1	Outline of Equipment.....	1-2
1.2	Specifications.....	1-2
1.3	Options.....	1-2
1.4	Configuration.....	1-2
1.5	Precautions on Handling .....	1-8
1.5.1	Operating temperature range.....	1-8
1.5.2	Environmental conditions .....	1-8

## **1.1 Outline of Equipment**

This equipment is an optical spectrum analyzer that permits measuring the spectrums of light sources such as LD and LED and also the loss wavelength characteristics and transmission characteristics of optical fiber cables, optical filters, etc.

The measurable wavelength range is as wide as 600 to 1750 nm.

This permits optical spectrum analysis of the near infra-red ray area.

The equipment is provided with not only the basic performance of high resolution, high-sensitivity, high-accuracy, wide dynamic range and excellent linearity but also many functions such as three-dimensional display, various data processing function and program measuring function.

As data output functions, the equipment is capable of hard-copying screens through a built-in high-speed printer, and reading/writing waveforms and programs through a built-in floppy disk.

Besides, the equipment is equipped with GP-IB as the standard configuration, thereby exerting full remote control.

## **1.2 Specifications**

Table 1-1 shows the specifications of this equipment.

## **1.3 Options**

Table 1-2 shows the options of this equipment.

## **1.4 Configuration**

In the standard configuration, this equipment consists of the accessories shown in the Table 1-3 Standard Accessory List.

Table 1-1 Specifications (1/2)

Applicable optical fiber		SM,GI (50/125μm)	
Measurement wavelength range (Note 1)		600 to 1750 nm	
Wavelength accuracy (Notes 1 and 3)		±0.02 nm (1520 to 1580 nm, after calibration using built-in standard light source)	
		±0.04 nm (1580 to 1620 nm, after calibration using built-in standard light source)	
		±0.05 nm (600 to 1750 nm)	
Wavelength linearity (Notes 1 and 3)		±0.01 nm (1520 to 1580 nm)	
		±0.02 nm (1580 to 1620 nm)	
Wavelength reproducibility (Notes 1 and 3)		±0.005 nm (for one minute)	
Wavelength resolution (Notes 1 and 3)		Maximum resolution: 0.015 nm or better (1520 to 1620 nm Resolution setting 0.01nm)	
		Resolution setting: 0.01, 0.02, 0.05, 0.1, 0.2, 0.5, 1.0, 2.0 nm	
Resolution accuracy (Notes 1 and 3)		±5%: (1300 to 1650 nm, Resolution setting: 0.05 nm or more) Resolution correction function:ON)	
Measurement level range (Notes 2 and 3)		-90 to +20 dBm (1200 to 1650 nm, measurement sensitivity: HIGH 3)	
		-80 to +20 dBm (1000 to 1200 nm, measurement sensitivity: HIGH 3)	
		-60 to +20 dBm (600 to 1000 nm, measurement sensitivity: HIGH 3)	
Level accuracy (Notes 2 and 3)		±0.3 dB (1310/1550 nm, input: -30 dBm, measurement sensitivity: HIGH 1-3)	
Level linearity (Notes 2 and 3)		±0.05 dB (input: +10 to -50 dBm, measurement sensitivity: HIGH 1-3)	
Level flatness (Notes 2 and 3)		±0.1 dB (1520 to 1580 nm), ±0.2dB(1580 to 1620nm)	
Polarization dependency (Note 2 and 3)		±0.05 dB (1550/1600nm) ±0.05 dB typ.(1310nm)	
Dynamic range (Note 3)		60 dB (1523 nm, Peak: ±0.2 nm, Resolution setting: 0.01 nm)	
		70 dB (1523 nm, Peak: ±0.4 nm, Resolution setting: 0.01 nm)	
		45 dB (1523 nm, Peak: ±0.2 nm, Resolution setting: 0.1 nm)	
Measurement time		About 500 msec (Sweep width: 100 nm or less, measurement sensitivity: NORMAL HOLD, averaging times: 1 time, sampling point: 501)	
		About 0.5 min. (Sweep width: 100 nm or less, measurement sensitivity: HIGH 2, averaging times: 1 time, sampling point: 501, no signal)	
Function	Automatic measurement	Program function (20 programs, 200 steps) Long term measurement function	
	Measurement condition setting	Sweep width setting:	0 to 1200 nm
		Measurement sensitivity setting:	NORMAL HOLD/AUTO, MID, HIGH 1/2/3
		Number of averaging times setting:	1 to 1000 times
		Number of samples setting:	11 to 20001, AUTO

Table 1-1 Specifications (2/2)

Function	Measurement condition setting	Automatic setting function of automatic sweep measurement Condition Inter-marker sweep function 0 nm sweep function Pulse light measurement function Air/vacuum wavelength measurement function Synchronous sweep function for wavelength tunable laser source	
	Trace display	Level scale setting 0.1 to 10 dB/div and linear Concurrent display of independent three traces Maximum value/minimum value display Roll averaging display Inter-trace arithmetic operation display Normalization display Curve fit display Three-dimensional display 2-screen splitting display Power density display, % display, dB/km display Frequency display on a horizontal axis	
	Data analysis	WDM waveform analysis (waveforms/levels/SNR listing), analysis of optical fiber amplifier (gain/NF), PMD analysis, DFB-LD analysis, FP-LD analysis, LED analysis, SMSR analysis, peak/bottom search, spectral width search, notch width search, delta marker (up to 200), line marker (specification of analysis range), graphic display of long term measurement results	
	Others	Self-wavelength calibration function (using built-in wavelength standard light source) Wavelength/level correction function, label function, help function	
Storage	Built-in FDD	3.5-inch 2HD	
	Built-in memory	32 waveforms, 20 programs	
	File format	Waveform file, program file, measurement condition file, text file (waveform, analysis data, etc.) graphic file (BMP, TIFF)	
Data output	Printer	Built-in high-speed printer	
Interface	Remote control	GP-IB (2 ports) Control port for wavelength tunable laser source (TTL)	
	Others	Sweep trigger input (TTL), sample enable input (TTL), sample trigger input (TTL), analog output (0 to 5 V), video output (VGA)	
Display		9.4-inch color LCD (resolution: 640 × 480 dots)	
Optical connector		FC (standard)	
Power supply		100 to 120/200 to 240 VAC, 50/60 Hz	
Environmental conditions		Operating temperature:	+5 to +40°C
		Storage temperature:	-10 to 50°C
		Relative humidity:	80% or less (no condensation)
Dimensions and mass	(Note 4)	Approx. 222 (H) × 425 (W) × 450 (D) mm, Approx, 30 kg	

*Note 1: Horizontal axis scale in wavelength display mode*

*Note 2: Vertical axis scale in absolute level display mode, resolution setting 0.05nm or more, at resolution correction OFF*

*Note 3: When 10/125  $\mu$ m single mode fiber is used, after 2-hour warm-up, after adjusting optical axis of monochro-meter(used <OPTICAL ALIGNMENT> soft key), at 15 to 30°C*

*Note 4: however exclude protector*



Table 1-2 Option List (1/2)

<ul style="list-style-type: none"> <li>• AQ4320A/4320B/4320D ( tunable laser source)</li> </ul>	
Wavelength span	:AQ4320A; 1480~1580 nm :AQ4320B; 1500~1580nm :AQ4320D; 1520~1620nm
Optical output	:AQ4320A; +10dBm(typ.)(1550nm) :AQ4320B; -3dBm or more(1550nm) :AQ4320D; +7dBm(typ.) (peak)
<p>This equipment carries the synchronized sweeping function to work with the AQ6317B optical spectrum analyzer.</p>	
<ul style="list-style-type: none"> <li>• AQ4310 (155) ASE light source unit (for optical filter transmission factor measurement)</li> </ul>	
Center wavelength	: 1550±20 nm
Spectral width	: (-10 dB): 40 nm
<p>(The AQ2141 expansion frame is required.)</p>	
<ul style="list-style-type: none"> <li>• AQ-4303B White light source (for less wavelength characteristic measurement)</li> </ul>	
Emitted light wavelength	: 400 to 1800 nm
Optical output level	: -45 dBm or more (Wavelength 850 nm and 1300 nm, wave length zone 10 nm with G150/125 μm fiber and CW light)
Light emitting element	: Halogen lamp
<ul style="list-style-type: none"> <li>• AQ-9313 Device adapter (for CAN-type LD element characteristic measurement)</li> </ul>	
Adaptable package	: TO-5 (standard). Other packages (TO-46, TO-52, etc.) are adaptable.
Usable fiber	: SM10/125 μm with FC plug and collimator
Rated current output	: 5 to 150 mA
<ul style="list-style-type: none"> <li>• AQ-9314B Parallel beam mount (for optical device/optical material loss wavelength characteristic measurement)</li> </ul>	
<p>External dimensions of measured material :</p>	
<p>10×15 mm or more, 50×50 mm or less, thickness 12 mm or less</p>	
Connection loss	: 5 dB or less (at a wavelength of 850 nm)
Usable fiber	: 800 μm large-caliber fiber (separately sold)
<ul style="list-style-type: none"> <li>• Quartz cell for liquid measurement (When combined with the AQ-9314B parallel mount, this cell makes liquid permeability measurement.)</li> </ul>	
Recommended product	: T-56A-UV-3-1 (Japan Quartz Glass Co., Ltd.)

Table 1-2 Option List (2/2)

<ul style="list-style-type: none"> <li>• AQ-9343 Collateral Beam Measuring adapter (For gas laser measurement) Usable fiber : SM10/125 μm with FC plug Maximum permissible diameter : Collateral beam having beam diameter of 6 mm or less Connection loss : 5 dB or less</li> <li>• AQ-9346 Point light measuring adapter (for point light source measurement for LD and LED elements) This adapter is suitable for the case where LDs and LEDs are incorporated in the system and mounted on the following fine adjustment table. Select an optical fiber cord suitable for the light source and connect it. (This adapter is not attached to the optical fiber cord and fine adjustment table.) Output type : FC connector Recommended fine adjustment table : Σ-2001-(1) Precision XYZ composition (Sigma Koki)</li> </ul>
--

Table 1-3 Standard Accessory List

Accessory name	Quantity	Remarks
Power code	1 pc.	Approx. 3 m (for regular use)
Fuse	2 pcs.	(For regular use) (Note)
Instruction manual	1 copy	
Record paper	2 rolls	TF50KS-E2 (for built-in printer) (Jujo Paper)
Floppy disk	2 pcs.	3.5-inch 2HD

*Note: 3.15A (Fast-Acting) for operation at 100 to 120 V  
3.15A (Time-Lag) for operation at 200 to 240 V*

## 1.5 Precautions on Handling

### 1.5.1 Operating temperature range

The operating temperature range guaranteed for this equipment is +5 to +40°C.

But the operating temperature range in a part of function is +15 to +30°C.

### 1.5.2 Environmental conditions

This equipment incorporating a very-high-precision monochromator requires extreme care about temperatures, shocks and vibrations when it is stored and transported.

In particular, when the equipment is operated over the following environmental conditions, its performance may not be restored.

#### Environmental Conditions

(1) Storage temperature range : -10 to +50°C

(2) Vibration

Oscillation frequency : 10 Hz

Compound amplitude :  $2 \pm 0.5$  mm

Direction of vibration : Up/down, left/right, forward/backward

Vibration time : 10 minutes each (in each direction of vibration)

(3) Shock

Shock equivalent to a natural drop when one side of the base is raised 2.5 cm in the static state on the hard wooden floor.

(4) Installation

When this equipment is installed in the vertical or reverse direction for a long time, the accuracy of its built-in monochromator will be affected adversely.

During transportation and storage, this equipment must be kept level.

## Chapter 2 PREPARATIONS BEFORE USE

This chapter describes unpacking, repacking and acceptance inspection and general precautions. Before using this equipment, be sure to read this chapter to correctly operate it.

### Contents of Chapter 2

2.1	Unpacking and Acceptance Inspection .....	2-2
2.1.1	Mechanical checks .....	2-2
2.1.2	Operation checks.....	2-2
2.2	Action to Be Taken upon Detection of Damage or Abnormality .....	2-2
2.3	Preparations and General Precautions.....	2-3
2.4	Safety Measures for Power Supply .....	2-4
2.4.1	Polarity of power cord.....	2-4
2.4.2	Protective earthing .....	2-5
2.4.3	Fuse replacement.....	2-6
2.5	Precautions in Use.....	2-6
2.6	Precautions on Storage.....	2-7
2.6.1	Precautions before storage .....	2-7
2.6.2	Recommendable storage conditions .....	2-7
2.7	Repacking and Transportation .....	2-8
2.7.1	Repacking .....	2-8
2.7.2	Transportation.....	2-8

## **2.1 Unpacking and Acceptance Inspection**

This equipment undergoes both mechanical and electrical inspection before shipment from the plant, in order to guarantee its normal operation.

After receiving this equipment, perform unpacking at once and make checks to see if the equipment has not been damaged during transportation.

When performing unpacking, be careful not to give damage to the corrugated fiberboard case for inner package and cushion materials except consumable materials for packing such as packing paper and preserve them for reuse at a transfer.

### **2.1.1 Mechanical checks**

Check the appearance, switch operations and connectors of this equipment to see if they have not been damaged or had any fault during transportation.

Collate the types and quantity of accessories and reserves with Table 1-3 Standard Accessory List.

### **2.1.2 Operation checks**

After making sure that the mechanical operation is normal, make operation tests to make performance checks.

With these checks, it can be known whether the operation of this equipment conforms to the specifications shown in 1.2.

For the inspection procedure, refer to Chapter 11.

## **2.2 Action to Be Taken upon Detection of Damage or Abnormality**

When any damage or specification fault is detected on this equipment at acceptance inspection, inform us (head office, branch or business office) of its contents at once.

## 2.3 Preparations and General Precautions

(1) Power supply

Use a power supply of AC 100 V to 240 V with a power supply frequency of 48 Hz to 63 Hz.

Also, use a cable of the rated voltage that satisfies the operating voltage.

(2) Power cable

The power cable is a 3-pin plug type whose central round pin is an earth pin.

Use it with a 3-pin plug socket.

If a 2-pin plug socket is used, connect it to the plug socket by using an adapter. Be sure to connect the earth wire coming from the adapter to an external earth or the ground.

(3) Fuse

When the power supply voltage is 100 to 120 V, use a 3.15 A fuse (Fast-Acting). When it is 200 to 240 V, use a 3.15 A fuse (Time-Lag).

## 2.4 Safety Measures for Power Supply

When a power supply of AC 100 V to 240 V, 48 to 63 Hz, is connected, the equipment will normally function. However, it is necessary to feed the AC power supply after taking preventive measures against the following points.

- Accident resulting in injury or death, due to electric shocks
- Damage within units due to abnormal voltages
- Trouble due to earth current

Be sure to observe the following items as preventive measures.

### 2.4.1 Polarity of power cord

The 3-pole power plug socket with a earth terminal E (Earth) (earth type 2-pole) is connected to the voltage pole side line L (live line), earth side line N (neutral) and protective earth line (earth) as shown in Fig. 2-1.

Therefore, the attached 2-core power cord is designed in such a way that the polarity of the power supply may be coincident when its plug is inserted into the 3-pole (earth type 2-pole) plug socket.

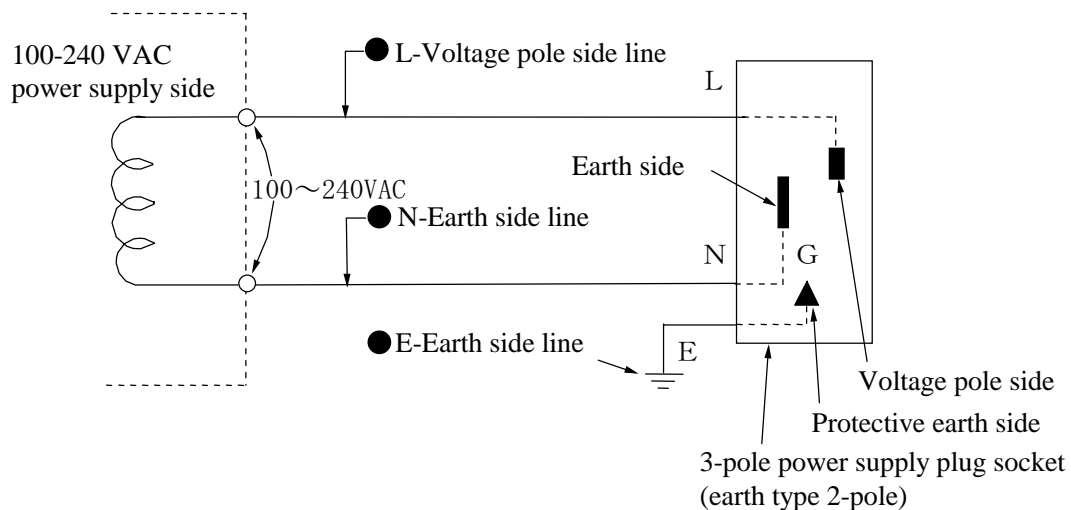

Fig. 2-1 Three-core Power Control plug and Plug Socket

## 2.4.2 Protective earthing

### [Earthing by conversion adapter]

When the 3-pole power supply plug socket shown in Fig. 2-1 is not equipped, earth the terminal coming from the 3-pole/2-pole conversion adapter shown in Fig. 2-2.

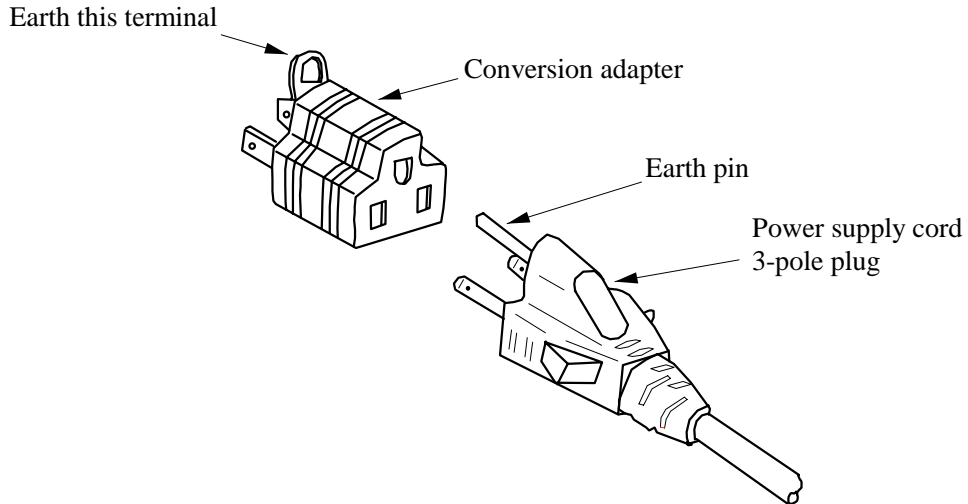

Fig. 2-2 Earthing by Conversion Adapter

This equipment is of protective structure against electric shocks by means of protective earthing and classified as Safety Class I.

By connecting the earth pin of the 3-pole power cord or the terminal of the 3-pole/2-pole conversion adapter to the power supply plug socket, this equipment is earthed so that an accident of electric shock due to the AC power supply can be prevented.

### [Earthing by the 3-pole power plug socket]

In this case, as described in 2.4.1, when a 3-pole (earth type 2-pole) plug socket is provided, there is a match in polarity between the 3-core power cord plug and the power supply. Accordingly, the equipment cabinet is connected to the earth potential at the time when the power cord is inserted into the plug socket.

Therefore, a 3-pole/2-pole conversion plug is not required.



### 2.4.3 Fuse replacement

The fuses shown in Table 1-3 (→ 1-4 Configuration) is attached in the standard equipment.

In case a fuse must be replaced because of a failure, clear up the cause of the failure and remove it before replacing the fuse.

#### **DANGER**

- *Before replacing a fuse, turn off the power switch and disconnect the power plug from the plug socket.  
If fuse replacement is performed in the power ON status, an accident resulting in injury or death due to an electric shock may be caused.*
- *After completion of fuse replacement, execute any of protective earthing operations described in 2.4.2 and check that the AC power supply voltage is proper. Then, turn on the power switch.  
If the power supply is turned on without executing protective earthing, an accident resulting in injury or death due to an electric shock may be caused.  
In case of an improper AC power supply voltage, the insides of units may be damaged by abnormal voltage.*

### 2.5 Precautions in Use

(1) Screen display unit

A color LCD module (hereinafter shall be referred to LCD) is adopted in the screen display unit of this equipment. A filter plate is provided in front side of this LCD. If a strong shock is given to this filter plate, it might crack the filter plate or the LCD itself is damaged. To avoid it, be careful to its handling.

(2) If such phenomena occur

If the following phenomena occur in the light during measurement, there is a possibility that dust sticks to the end surface of the optical fiber cord which connects the light source to this equipment. In such a case, wipe clean the end surface of optical fiber cord with alcohol, etc.:

- Deterioration of resolution
- Wavelength error
- Occurrence of a level error

## 2.6 Precautions on Storage

The precautions on storing this equipment for a long time will be described below.

### 2.6.1 Precautions before storage

- (1) Wipe off the dust, hand-stain (finger mark), dirt, stain, etc. adhering on this equipment.
- (2) Execute 11.2 Operation Checks to see that this equipment can normally function.
- (3) Avoid storing this equipment in the following places:
  - 1) Place exposed to direct sunlight or dusty place
  - 2) High-humidity place that may cause waterdrop adhesion or waterdrop generation.
  - 3) Place that may be affected by active gas or place that may oxidize units.
  - 4) Place where the temperature and humidity levels are as shown below.
    - Temperature .....  $> 50^{\circ}\text{C}$ ,  $< -10^{\circ}\text{C}$
    - Humidity .....  $> 80\%$

### 2.6.2 Recommendable storage conditions

For long-term storage, it is desirable to satisfy the following environmental conditions as well as observe the precautions before storage described in 2.6.1.

- Temperature .....  $-10$  to  $50^{\circ}\text{C}$
- Humidity .....  $40$  to  $70\%$
- Slight change in temperature and humidity in the day

For reuse after storage, execute 11.2 Operation Checks to see that this equipment can normally function.

## 2.7 Repacking and Transportation

When this equipment is reused or repaired at a remote place, the problems of repacking and transportation must be settled.

### 2.7.1 Repacking

Use the packing materials, as they are, which were used for the first delivery. If the packing materials are thrown away or broken, perform packing in the following way.

- (1) Apply cushions to protect the protrusive portions of the front panel and rear panel of this equipment.
- (2) Wrap up this equipment in vinyl sheets.
- (3) Prepare a corrugated fiberboard case, wooden case or aluminum case with a space of 10 to 15 cm in each direction of this equipment.
- (4) Put this equipment in the middle of the case and fill the space of 10 to 15 cm in each direction of this equipment with sufficient cushioning materials to absorb shocks due to vibrations.
- (5) Fix the outside of the case firmly with packing strings, adhesive tapes or bands.

#### NOTE

*The reuse of the packing materials which were used for the first delivery makes it easy to repack the equipment. Please preserve these packing materials.*

### 2.7.2 Transportation

We recommend you to avoid vibrations as much as possible and satisfy the recommendable storage conditions described in 2.6.2 for transportation.

# Chapter 3 DESCRIPTION OF FUNCTIONS

This chapter describes the functions of this equipment.

## Contents of Chapter 3

3.1	Names and Functions of Panels .....	3-2
3.2	Software Functions .....	3-5

### 3.1 Names and Functions of Panels

Figure 3-1 to Fig. 3-3 show the names of the panels of this equipment and Table 3-1 shows the functions of these panels. The encircled numbers in the figures correspond to the encircled numbers in the number column of the table.

Front Panel

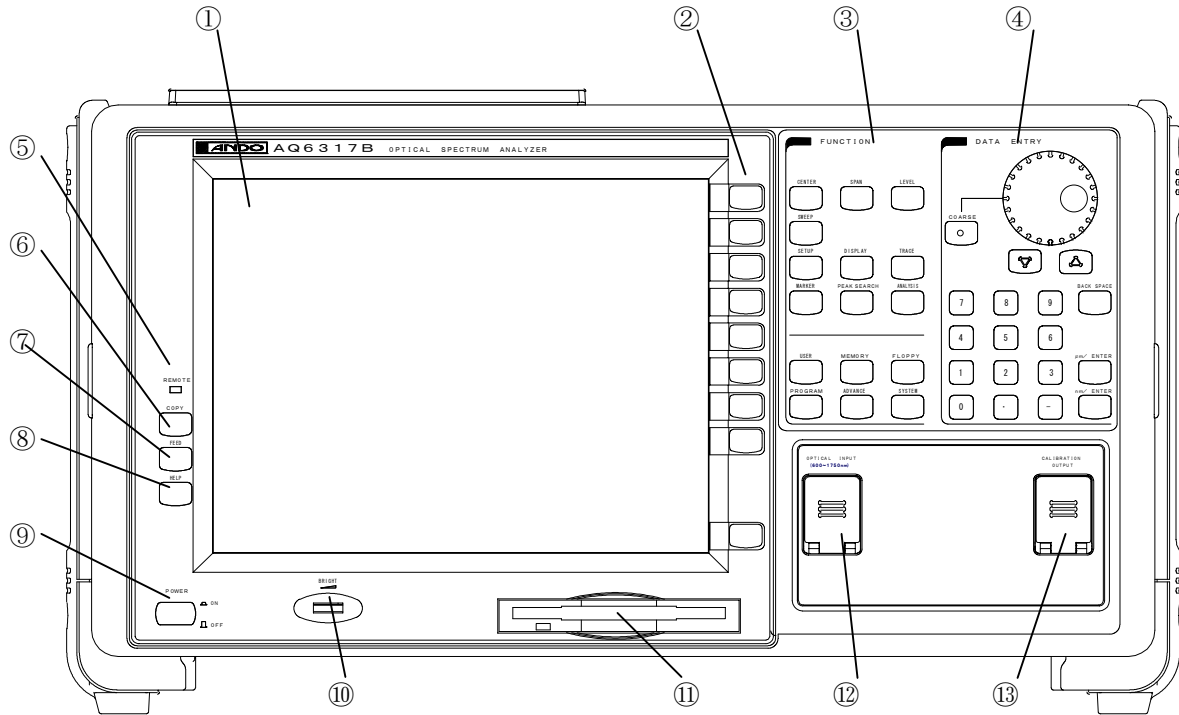

Fig. 3-1 AQ6317B Optical Spectrum Analyzer

# Rear Panel

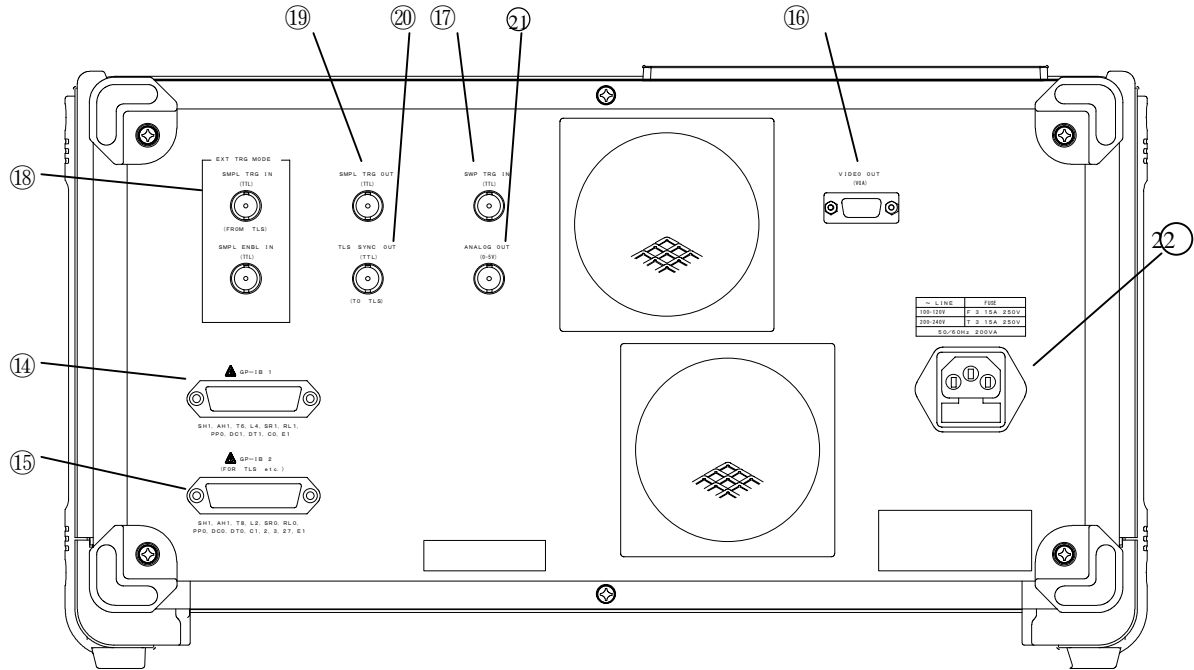

Fig. 3-2 AQ6317B Optical Spectrum Analyzer

Table 3-1 Description of Panel Functions

No.	Name	Description of function
①	LCD display	Displays measured waveforms, measuring conditions, measured values, etc.
②	Soft key switch	Used to execute the function of each switch.
③	[FUNCTION] section	Used to perform setting for every measurement (sweep, measuring conditions, data analysis and various functions).
④	[DATA ENTRY] section	Used to enter measuring condition parameters and labels.
⑤	Remote lamp	Comes on when this equipment is in the remote status.
⑥	[COPY]	Used to execute printer functions.
⑦	[FEED]	Used to feed record paper.
⑧	[HELP]	Used to check the contents of the soft key menu displayed on the screen.
⑨	[POWER]	Power switch
⑩	[BRIGHT]	LCD brightness adjusting control
⑪	Floppy disk drive (3.5 inches)	Used to store waveform data, programs, etc.
⑫	[OPTICAL INPUT]	Optical input connector
⑬	[CALIBRATION OUTPUT]	Optical output connector of the standard light source used for wavelength calibration
⑭	[GP-IB 1]	GP-IB port to control this equipment from an external computer
⑮	[GP-IB 2]	GP-IB port to control external units (wavelength variable light source, etc.) while this equipment functions as a system controller on the GP-IB bus
⑯	[VIDEO OUT (VGA)]	Connector to output analog RGB video signals (conforming to VGA)
⑰	[SWP TRG IN]	Connector to input sweep trigger signals
⑱	[EXT TRG IN]	Connector to input control signals synchronized with measured light from outside. Also used to synchronize with the wavelength variable light source
⑲	[SMPL TRG OUT]	Connector to output measurement trigger signals
⑳	[TLS SYNC OUT]	Connector to output synchronous signals for the synchronous sweep with the wavelength variable light source
㉑	[ANALOG OUT]	Connector to output electric signals proportional to the measurement level
㉒	AC power connector	Input the AC power through the attached power cord.

## **3.2 Software Functions**

All system functions can be controlled from a distant place via GPIB interface. For the GPIB details, see Chapter 9 "GPIB function".



# Chapter 4 USAGE

This chapter outlines how to handle and operate this equipment.

## Contents of Chapter 4

4.1	Preparations and Operation Checks .....	4-2
4.1.1	Preparations before powering ON.....	4-2
4.1.2	Connections to other units.....	4-2
4.1.3	Power ON and screen display .....	4-3
4.1.4	Stop procedure .....	4-4
4.2	Operations .....	4-5
4.2.1	Description of screen .....	4-5
4.2.2	Description of means for entering parameters.....	4-6
4.2.3	Soft key execute form .....	4-8
4.2.4	"WARNING" display.....	4-8

## **4.1 Preparations and Operation Checks**

This section describes the items that you should perform or the items of which you should have knowledge before operating this equipment.

### **4.1.1 Preparations before powering ON**

Make the following checks before inserting the power cord of this equipment into the commercial power plug socket.

- (1) Turn off the [POWER] switch.
- (2) Check that the voltage of the power plug socket conforms to the power supply voltage of this equipment.
- (3) To avoid electric shocks, be sure to earth the earth terminal on the rear panel and the earth terminal of the power cord.
- (4) Before fuse replacement, be sure to turn off the [POWER] switch and disconnect the power cord from the power plug socket.
- (5) Avoid operating this equipment in those places that cause strong vibrations or are humid and dusty, exposed to direct sunlight, affected by active gas, or inclined or may cause an overturn.

### **4.1.2 Connections to other units**

Before connecting this equipment to GP-IB equipment such as external computers, and CRT display, make a wiring check and turn off the power switch of this equipment and those of these units.

If this equipment is connected on the power ON status, it may be damaged.

### 4.1.3 Power ON and screen display

After checking the power ON and connection status according to 4.1.1 and 4.1.2, turn on the power supply according to the following procedure.

- (1) Press the [POWER] switch to turn on the power supply.
- (2) "MEMORY CHECKING" blinks on the upper left part of the screen and an internal memory check and initialize processing are executed.
- (3) After completion of the memory check, the screen shown in Fig. 4-1 is displayed and internal initialize processing is started. At this time, "STEP 1/8" - "STEP 8/8" are displayed indicating the progress status of the initialize processing.
- (4) After normal completion of the initialize processing, the screen shown in Fig. 4-1 disappears and the previous power OFF screen is displayed.
- (5) If any error occurs in memory during the initialize processing in (2), an error message is displayed according to the cause of the error and the processing stops.  
If any fault occurs in the initialize processing in (3), "STEP O/8" is displayed and the processing stops halfway. (The screen shown in Fig. 4-1 is continuously displayed.)

#### NOTE

*In this equipment, the measuring conditions, soft key setting, displayed waveforms are stored in nonvolatile memory.  
When the power supply is turned on, the previous power OFF status is restored.*

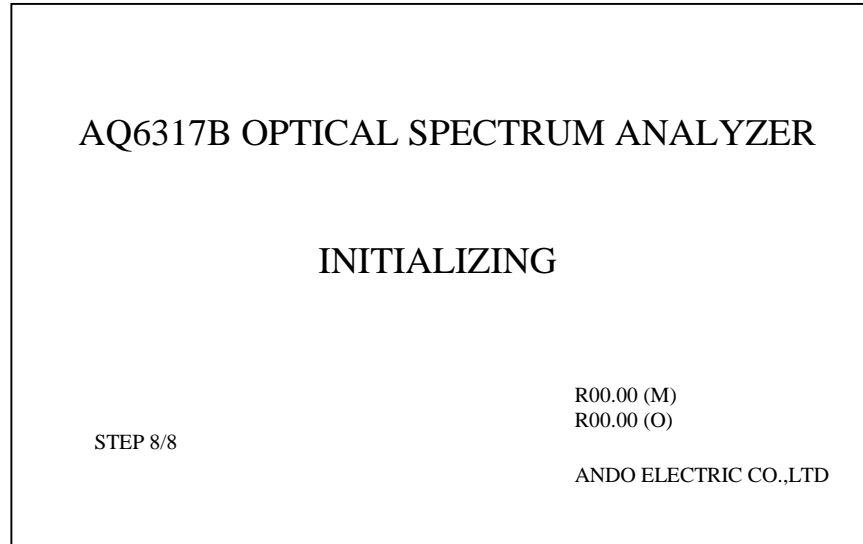

Fig. 4-1 Initialize Screen

#### 4.1.4 Stop procedure

- (1) Turn off the [POWER] switch.
- (2) Disconnect the optical fiber cord connected to the [OPTICAL INPUT] connector and close the cover.
- (3) Pull out the power cable from the power plug socket.  
Wind the power cord on the cord winding leg on the rear side.

## 4.2 Operations

This section describes how to operate this equipment.

### 4.2.1 Description of screen

On the screen of this equipment, measuring conditions, marker values and other data as well as measured waveforms are displayed. The name of each part of the screen is shown below.

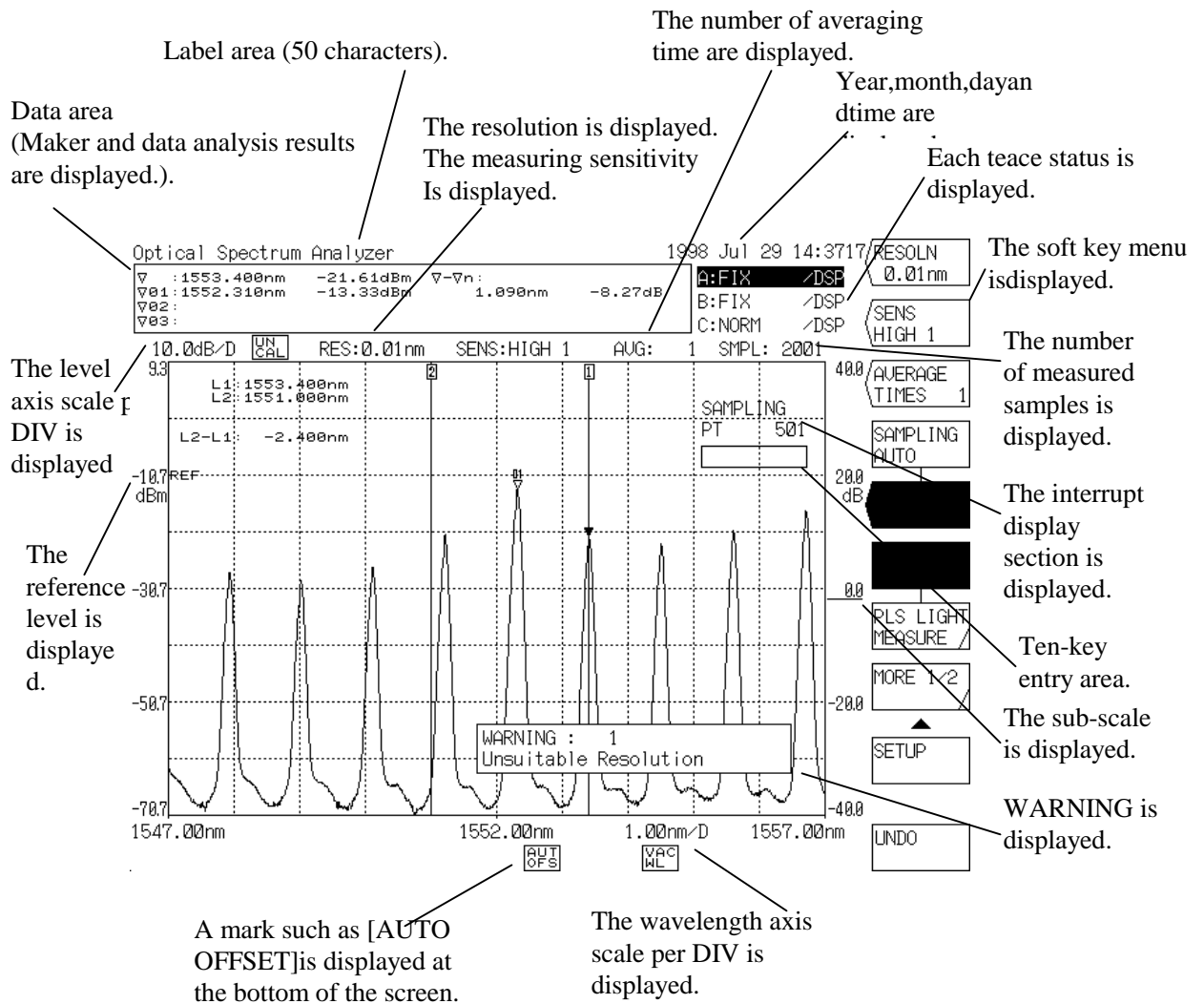
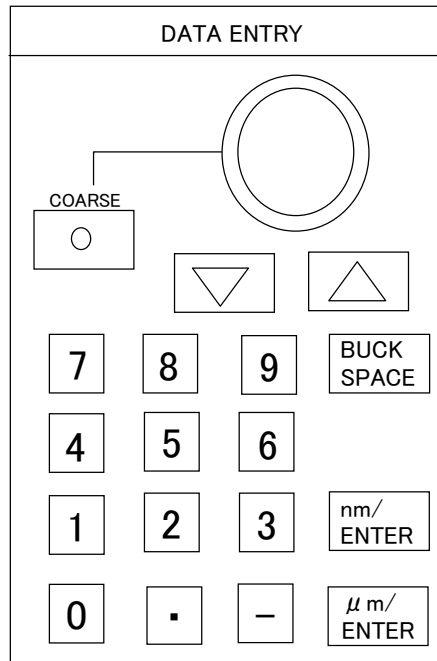

Fig. 4-2 Names of Screen Parts

## 4.2.2 Description of means for entering parameters

This equipment is provided with 3 types of means for entering parameters such as measuring conditions, namely, a rotary knob, step keys and a ten-key pad.



(1) Entry by rotary knob

When the Soft key with parameter is pressed, the current set value is displayed in the interrupt display section. When the rotary knob is turned, the numeric value in the interrupt display section is incremented or decremented (increment: clockwise, decrement: counterclockwise), and also the internal setting is changed.

While the [COARSE] switch is ON (lamp ON), the numeric value is changed in coarse.

(2) Enter by step keys ([ $\uparrow$ ], [ $\downarrow$ ])

When the multi-marker function is selected, the marker value display of the data area can be scrolled up or down by the step keys.

Otherwise, when the [ $\uparrow$ ] key is pressed, the same operation as clockwise turn of the rotary knob is performed.

Likewise, when the [ $\downarrow$ ] key is pressed, the same operation as counterclockwise turn of the rotary knob is performed. When the key is continuously pressed for 0.5 second or more, an auto repeat operation is performed.

In the three-dimensional display mode, select a waveform to display the marker using a step key.

Use the rotary control knob or numeric keys to change the parameters.

(3) Entry by ten-key pad

When any key in the ten-key pad is pressed while the current set value is displayed in the interrupt display section by pressing the soft key with parameter, the ten-key entry area appears and the pressed numeric value is displayed in this area.

To set the numeric value in the frame, press the key corresponding to the unit of the parameter to be entered out of the [ $\square$ m/ENTER] and [nm/ENTER] keys. Then, The numeric value in the ten-key entry area is reflected in the interrupt display section and internally set. For a parameter without any unit, press the either key.

If a wrong key is pressed during ten-key entry, press the [BACK SPACE] key. Then, the number lastly entered (at the right end) in the ten-key entry area disappears and a correct number can be entered anew.

If the [BACK SPACE] key is continuously pressed to make the ten-key entry area empty, the ten-key entry status disappears and a return can be made to the status precedent to ten-key entry.

If the value entered through the ten-key pad does not agree with the settable value, the nearest value to the settable value is set.

### 4.2.3 Soft key execute form

When a panel switch of this equipment is pressed, the function related to the switch is displayed as a soft key menu at the right end of the screen. When the corresponding key is pressed, the function is executed. There is also a switch that can execute a function by pressing key. The following 5 soft key execute forms are available.

- (1) The soft key display is executed by pressing the corresponding key.

Soft key form: 

- (2) When the soft key is pressed, the set value is displayed in the interrupt display area and it can be changed using the rotary control knob, step keys or numeric keys. The window may be displayed instead of the interrupt display area.

Soft key form: 

- (3) When a panel switch is pressed, a function to be executed is selected among multiple soft keys. The selected key displayed in reverse video.

When another key is pressed, the display in reverse video proceeds to the key.

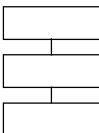
Soft key form: 

- (4) Each time a soft key is pressed, the key display in reverse video/key display in non-reverse video is switched alternately.

In this manual, this is represented as "toggle".

- (5) When the soft key is pressed, the related soft keys are displayed.

Soft key form: 

### 4.2.4 "WARNING" display

In this equipment, if a failure has occurred due to an incorrect operation on this equipment, a window is opened on the screen and a message is displayed. For this function, refer to 5.11 WARNING display function.

#### CAUTION

*When the unit is used for the first time or used again after being exposed to significant vibrations, make sure to warm it up first and then implement the alignment function prior to the operation.*

*Refer to 5.1.16(14) for the alignment function.*



# Chapter 5 DETAILS OF FUNCTIONS

This chapter details the functions of individual switches in this equipment.

## Contents of Chapter 5

5.1	Detailed Description of [FUNCTION] Section .....	5-3
5.1.1	[SWEEP] switch .....	5-3
5.1.2	[CENTER] switch (In wavelength display mode).....	5-6
5.1.3	[CENTER] switch (In frequency display mode) .....	5-10
5.1.4	[SPAN] switch (In wavelength display mode) .....	5-13
5.1.5	[SPAN] switch (In frequency display mode).....	5-16
5.1.6	[LEVEL] switch .....	5-19
5.1.7	[SETUP] switch .....	5-26
5.1.8	[MARKER] switch.....	5-31
5.1.9	[PEAK SEARCH] switch.....	5-38
5.1.10	[ANALYSIS] switch .....	5-42
5.1.11	[TRACE] switch.....	5-73
5.1.12	[DISPLAY] switch.....	5-85
5.1.13	[MEMORY] switch.....	5-94
5.1.14	[FLOPPY] switch.....	5-100
5.1.15	[PROGRAM] switch .....	5-120
5.1.16	[SYSTEM] switch.....	5-128
5.1.17	[ADVANCE] switch .....	5-144
5.1.18	[USER] switch .....	5-153
5.1.19	[HELP] switch.....	5-153
5.1.20	[COPY] switch.....	5-153
5.1.21	[FEED] switch.....	5-155
5.1.22	[AUXILIARY] switch.....	5-155
5.2	Detailed Description of Measuring Functions.....	5-156
5.2.1	Pulse light measuring function .....	5-156
5.2.2	Power meter function .....	5-158
5.2.3	Analog output function.....	5-159
5.2.4	Power density display function .....	5-159

5.3	Detailed Description of Analysis Function .....	5-161
5.3.1	NF measuring function.....	5-161
5.3.2	Curve fit function .....	5-164
5.3.3	WDM analysis function .....	5-165
5.3.4	WDM-NF analysis function .....	5-172
5.3.5	Optical Filter analysis function .....	5-175
5.4	Spectrum Width data calculation Algorithm.....	5-179
5.4.1	Envelope method.....	5-179
5.4.2	Threshold method .....	5-181
5.4.3	RMS (effective value) method .....	5-182
5.4.4	Notch width measurement methods.....	5-183
5.5	LONG TERM Measurement.....	5-185
5.5.1	Overview.....	5-185
5.5.2	Parameter setting.....	5-185
5.5.3	Condition setting.....	5-187
5.5.4	Measurement.....	5-187
5.5.5	Display of measurement results.....	5-188
5.5.6	ALL CHANNEL display.....	5-189
5.5.7	SINGLE CHANNEL display .....	5-193
5.6	Synchronous measurement function with the variable wavelength light source.....	5-195
5.6.1	Outline.....	5-195
5.6.2	Connections.....	5-195
5.6.3	Operation.....	5-195
5.6.4	Precautions .....	5-196
5.7	Video Output Specifications .....	5-197
5.8	Nonvolatile Data Initialize Function .....	5-198
5.9	Wavelength Calibrate Function.....	5-199
5.10	Setting Clock.....	5-199
5.11	WARNING Display Function.....	5-199

## 5.1 Detailed Description of [FUNCTION] Section

This section performs the setting related to every measurement (sweep, measuring conditions, data analysis and various functions).

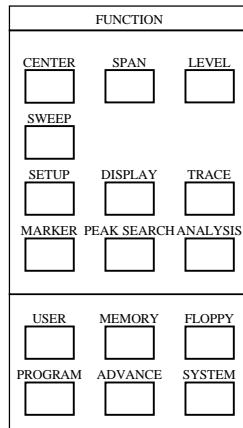

### 5.1.1 [SWEEP] switch

The related functions of the SWEEP switch have been grouped in this switch area.

When this switch is pressed, the soft key menu shown in the following figure is displayed.

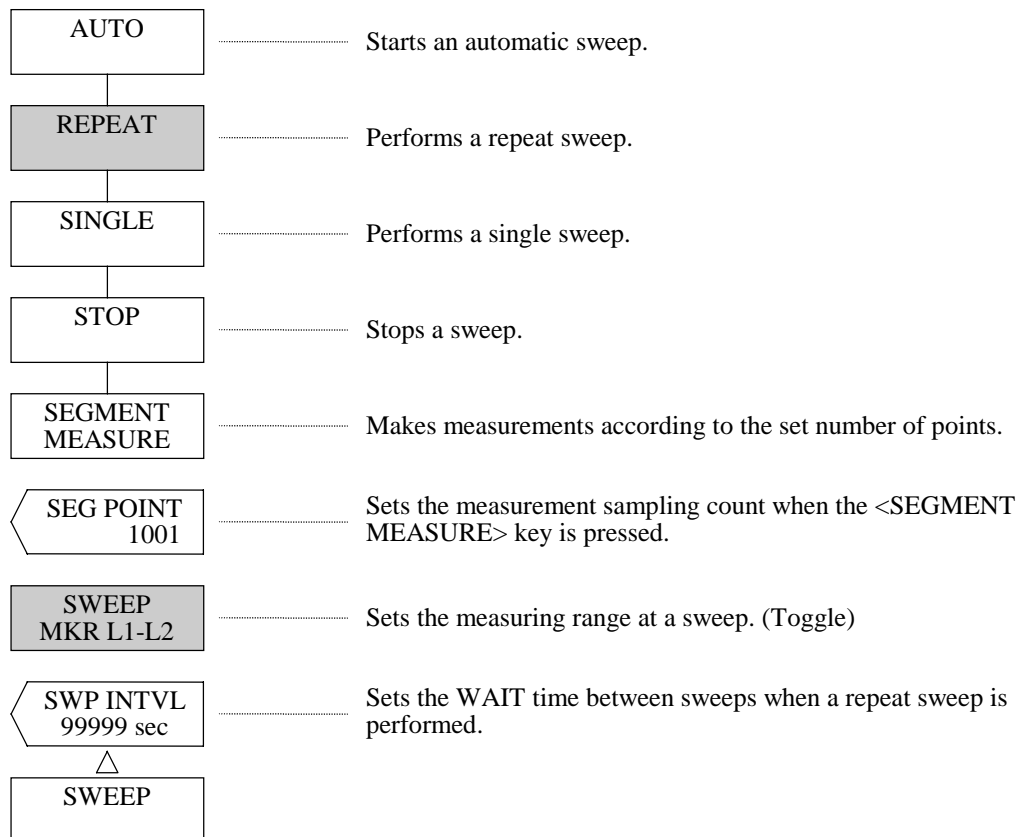

- (1) <AUTO> key  
Sets measuring conditions automatically to the optimum status according to the input light.  
When this key is pressed, the soft key is displayed in reverse video and the optimum conditions (center wavelength, sweep width, reference level and resolution) suitable for measuring input light is obtained.  
After that, the reverse video proceeds to the <REPEAT> key and a repeat sweep is performed.  
If the measuring conditions are not converged, sweeps are stopped, and displays WARNING.  
During execution, only the <REPEAT>, <SINGLE>, <STOP> and <UNDO> keys are effective.
- (2) <REPEAT> key  
Performs a repeat sweep.  
When this key is pressed, the soft key is displayed in reverse video and a repeat sweep is started.
- (3) <SINGLE> key  
Performs a single sweep.  
When this key is pressed, the soft key is displayed in reverse video and a single sweep is started.
- (4) <STOP> key  
Stops a sweep.
- (5) <SEGMENT MEASURE> key  
Makes measurements according to the sampling count set by the <SEG POINT> key, starting from the stop position at that time.
- (6) <SEG POINT> key  
Sets the sampling count for execution of SEGMENT MEASURE.  
When this key is pressed, the current sampling count is displayed in the interrupt display section.  
The allowable setting range is 1 to 20001 and the sampling count is set by the rotary knob, step keys or ten-key pad.
- (7) <SWEEP MKR L1-L2> key  
Sets the sweep range for sweep.  
When this key is displayed in reverse video, a sweep is performed between the wavelength line markers 1 and 2 (WL1 and WL2). When the key is displayed in non-reverse video, a sweep is performed within the effective range of the screen.

## NOTE

*When both WL1 and WL2 are set, a sweep is performed between the line marker 1 and 2.*

*When only WL1 is set, a sweep is performed from the line marker 1 to the right end of the screen.*

*When only WL2 is set, a sweep is performed from the left end of the screen to the line marker 2.*

*When WL1 and WL2 are not set, a sweep is performed within the effective range of the screen.*

*When WL1 and WL2 are set out of the sweep range (600 to 1750 mm), a sweep is performed within the sweep range.*

In the reverse video status, 

SWP 1-2
------------

 is displayed at the bottom of the screen.

(8) <SWP INTVL> key

Sets the time from a start of a sweep till a start of the next sweep in the repeat sweep mode.

If the time required for sweeps is longer than the set time, the next sweep is started as soon as a sweep ends.

When this key is pressed, the current set time is displayed in the interrupt display section.

The allowable setting range is MINIMUM and 1 to 99999 sec and the rotary knob, step keys or ten-key pad is used for setting.

When 0 is entered through the ten-key pad, MINIMUM is set.

For setting by using the rotary knob or step keys and setting by using the ten-key pad, refer to 4.2.2.

In the reverse video status, 

SWP INT
------------

 is displayed at the bottom of the screen.

## 5.1.2 [CENTER] switch (In wavelength display mode)

The related center wavelength setup functions have been grouped in the CENTER switch area.

When this switch is pressed, the soft key menu of ① is displayed and the function of <CENTER> key is performed.

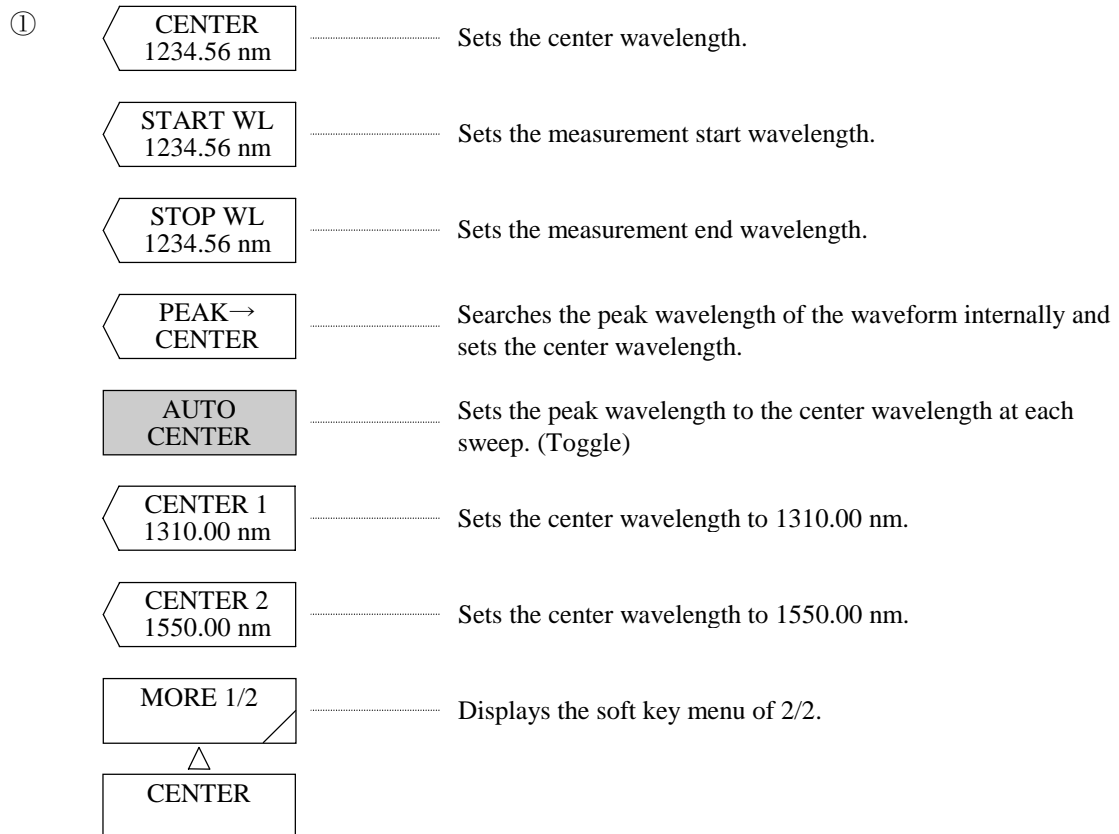

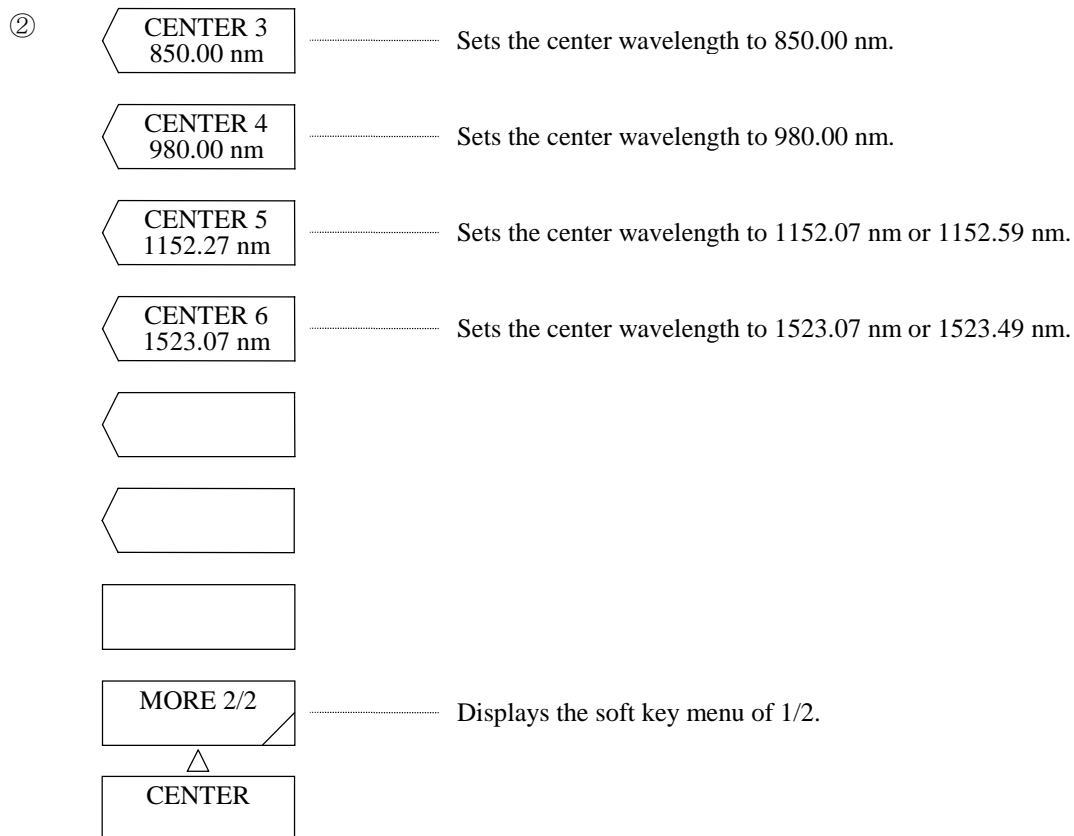

(1) <CENTER> key

Sets the center wavelength.

The allowable setting range is 600.00 to 1750.00 nm (0.01 step) and the rotary knob, step keys or ten-key pad are used for setting.

(2) <START WL> key

Sets the measurement start wavelength.

When this key is pressed, the current measurement start wavelength is displayed in the interrupt display section.

The allowable setting range is 0.00 to 1750.00 nm (0.01 step) and the rotary knob, step keys or ten-key pad are used for setting.

(3) <STOP WL> key

Sets the measurement end wavelength.

When this key is pressed, the current measurement end wavelength is displayed in the interrupt display section.

The allowable setting range is 600.00 to 2350.00 nm (0.01 step) and the rotary knob, step keys or ten-key pad is used for setting.

When setting the measurement start wavelength, the measurement end wavelength is fixed.

When setting the measurement end wavelength, the measurement start wavelength is fixed. For this reason, sweep width setting is changed. The center wavelength setting is also changed at the same time.

When the ten-key pad is used for setting, the settable nearest value is set.

(4) <PEAK → CENTER> key

Searches the peak of the active trace internally, sets the center wavelength.

After execution, the set center wavelength is displayed in the interrupt display section. At this time, center wavelength setting, measurement start wavelength setting and measurement end wavelength setting are changed.

The center wavelength can be set in succession by using the rotary knob, step keys or ten-key pad.

The allowable setting range is 600.00 to 1750.00 nm (0.01 step).

(5) <AUTO CENTER> key

Sets the ON/OFF status of the PEAK → CENTER function to be executed at each sweep. When this key is selected, the peak level is searched from the active trace waveforms automatically during each sweep and the peak level is set to the center wavelength. This key does not function while the active trace is in the MAX HOLD, MIN HOLD, CALC, EFFECT, or ROLL AVG status.

In the reverse video status, 

AUT CTR
------------

 is displayed at the bottom of the screen.

(6) <CENTER 1\*\*\*\*.\*\*nm> ~<CENTER 6 key \*\*\*\*.\*\*nm> keys

Sets the center wavelength in preset value (\*\*\*\*.\*\*nm).

When this key is pressed, the center wavelength is set in \*\*\*\*.\*\*nm.

At this time, it is also reflected in the interrupt display section. (\*\*\*\*.\*\* : Wavelength value shown in the soft key menu.)

Preset value of center wavelength varies depending on to which of air wavelength or vacuum wavelength this device is set.

For this setting, refer to (7) <MEAS WL AIR VAC> key in 5.1.14 [SYSTEM] switch.



Preset values displayed in the soft key menu change depending on the mode, as shown below.

*(unit: nm)*

Center \ Mode	Air wavelength	Vacuum wavelength
1	1310.00	1310.00
2	1550.00	1550.00
3	850.00	850.00
4	980.00	980.00
5	1152.27	1152.59
6	1523.07	1523.49

### 5.1.3 [CENTER] switch (In frequency display mode)

The related center frequency setup functions have been grouped in the CENTER switch area.

When this switch is pressed, the soft key menu of ① is displayed and the function of <CENTER> key is performed.

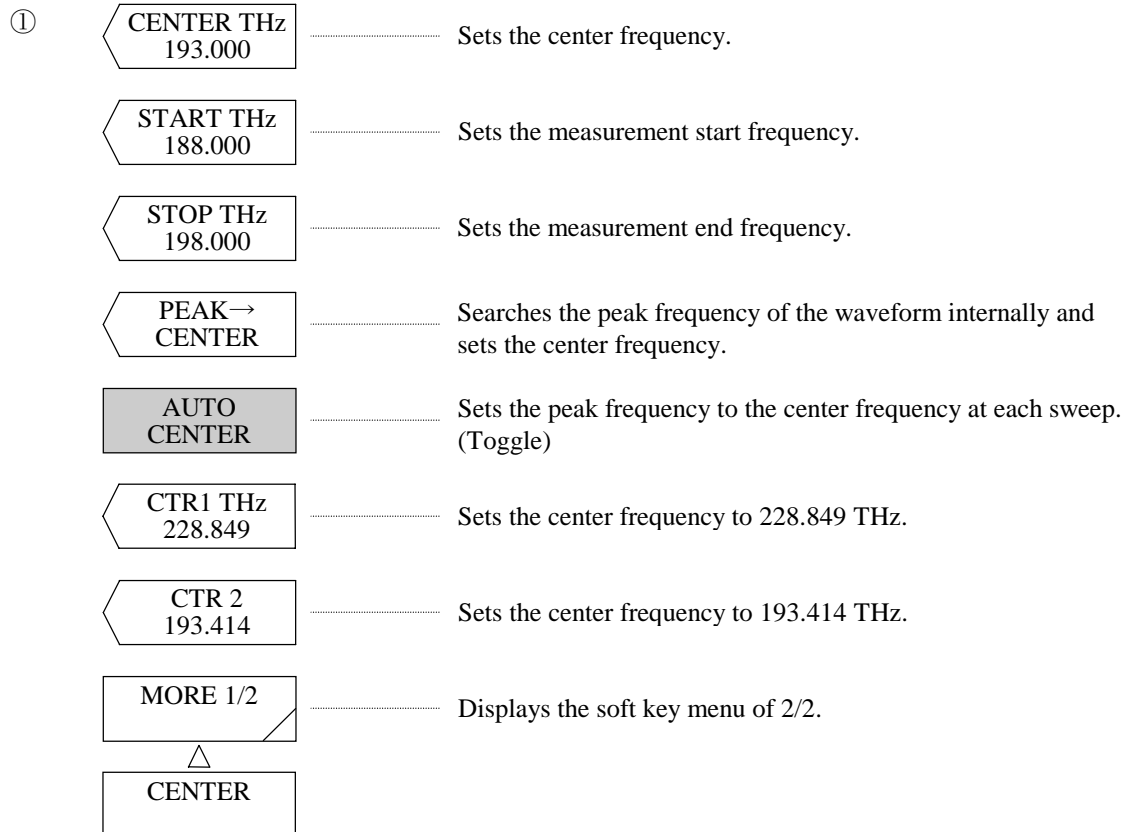

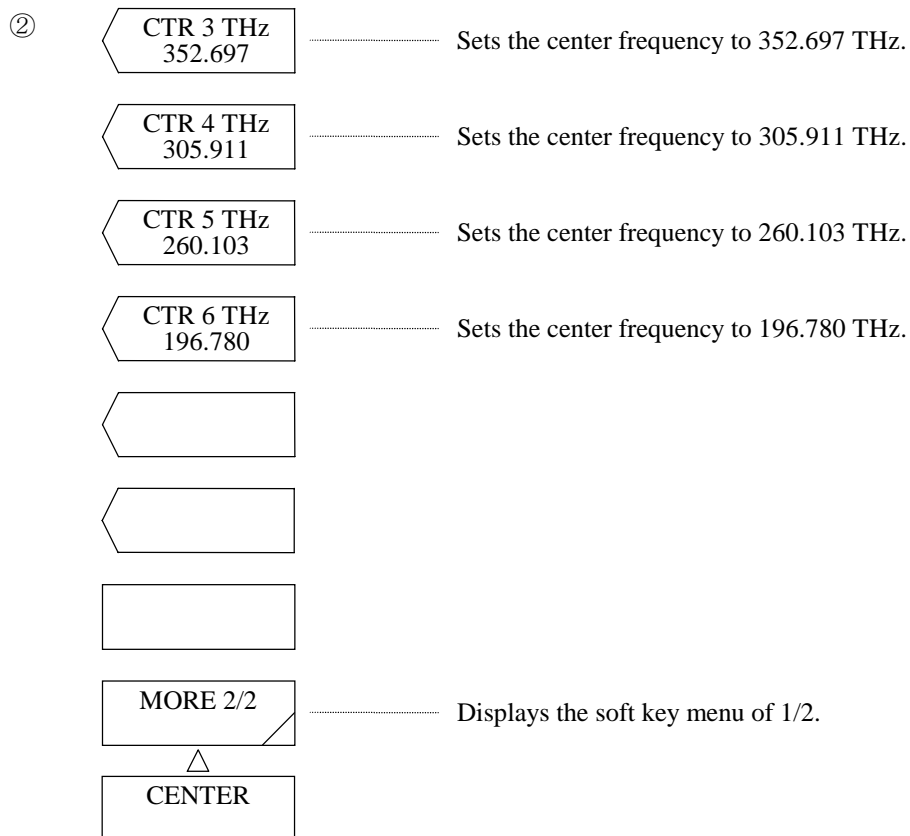

(1) <CENTER> key

Sets the center frequency.

The allowable setting range is 171.500 to 499.500 THz (0.001 step) and the rotary knob, step keys or ten-key pad are used for setting.

(2) <START> key

Sets the measurement start frequency.

When this key is pressed, the current measurement start frequency is displayed in the interrupt display section.

The allowable setting range is 1.000 to 499.500 nm (0.001 step) and the rotary knob, step keys or ten-key pad are used for setting.

(3) <STOP> key

Sets the measurement end frequency.

When this key is pressed, the current measurement end frequency is displayed in the interrupt display section.

The allowable setting range is 171.500 to 674.500 (0.001 step) and the rotary knob, step keys or ten-key pad is used for setting.

When setting the measurement start frequency, the measurement end frequency is fixed.

When setting the measurement end frequency, the measurement start frequency is fixed. For this reason, sweep width setting is changed. The center frequency setting is also changed at the same time.

When the ten-key pad is used for setting, the settable nearest value is set.

(4) <PEAK → CENTER> key

Searches the peak of the active trace internally, sets the center frequency.

After execution, the set center frequency is displayed in the interrupt display section. At this time, center frequency setting, measurement start frequency setting and measurement end frequency setting are changed.

The center frequency can be set in succession by using the rotary knob, step keys or ten-key pad.

The allowable setting range is 171.500 to 674.500 (0.001 step).

(5) <AUTO CENTER> key

Sets the ON/OFF status of the PEAK → CENTER function to be executed at each sweep. When this key is selected, the peak level is searched from the active trace waveforms automatically during each sweep and the peak level is set to the center frequency. This key does not function while the active trace is in the MAX HOLD, MIN HOLD, CALC, EFFECT, or ROLL AVG status.

In the reverse video status,  is displayed at the bottom of the screen.

(6) <CTR1 \*\*\*.\*\*\* THz> ~<CTR 6 \*\*\*.\*\*\* THz> keys

Sets the center frequency in preset value (\*\*\*.\*\*\* THz).

When this key is pressed, the center frequency is set in.

At this time, it is also reflected in the interrupt display section. (\*\*\*.\*\*\* : Frequency value shown in the soft key menu.)

Preset value of center frequency varies depending on to which of air frequency or vacuum frequency this device is set.

For this setting, refer to (7) <MEAS WL AIR VAC> key in 5.1.14 [SYSTEM] switch.

## 5.1.4 [SPAN] switch (In wavelength display mode)

The related sweep functions have been grouped in the SPAN switch area.

When this switch is pressed, the soft key menu shown in the following figure is displayed and the function of <SPAN> key is performed.

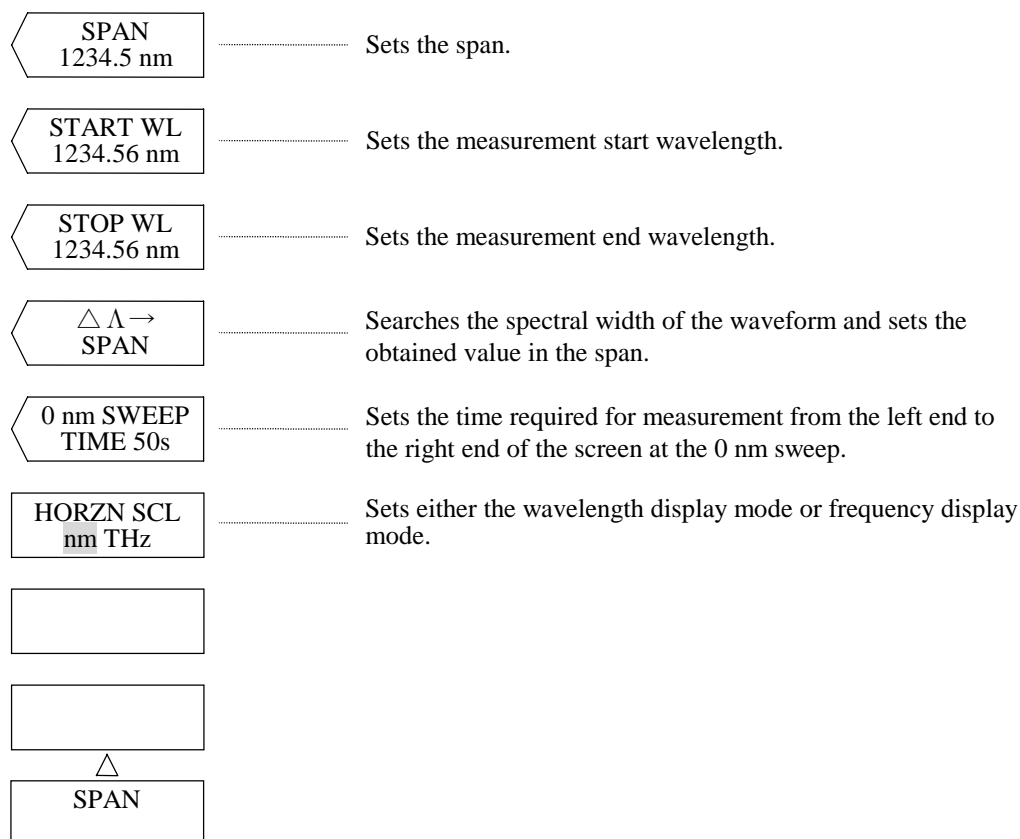

(1) <SPAN> key

Sets the span.

The allowable setting range is 0 and 0.5 to 1200.0 nm (0.1 step) and the rotary knob, step keys or ten-key pad is used for setting.

When the setting has been changed, waveform rewrite processing is performed. Measurement start wavelength setting and measurement end wavelength setting are also changed at the same time.

(2) <START WL> key

Sets the measurement start wavelength.

When this key is pressed, the current measurement start wavelength is displayed in the interrupt display section.

The allowable setting range is 0.00 to 1750.00 nm (0.01 step) and the rotary knob, step keys or ten-key pad is used for setting.

When the setting has been changed, waveform rewrite processing is performed.

(3) <STOP WL> key

Sets the measurement end wavelength.

When this key is pressed, the current measurement end wavelength is displayed in the interrupt display section.

The allowable setting range is 600.00 to 2350.00 nm (0.01 step) and the rotary knob, step keys or ten-key pad is used for setting.

When the setting has been changed, waveform rewrite processing is performed.

When setting the measurement start wavelength, the measurement end wavelength is fixed.

When setting the measurement end wavelength, the measurement start wavelength is fixed.

Therefore, sweep width setting is changed. Mean wavelength setting is also changed at the same time.

When the ten-key pad is used for setting, the settable nearest value is set.

(4) < $\Delta\lambda \rightarrow$  SPAN> key

Executes a spectral width search for active trace internally and sets the obtained value in the center wavelength and the span.

The spectral width search is made at an RMS of 20 dB and a magnification of 6.00.

After execution, the set span is displayed in the interrupt display section, and the displayed waveform is rewritten according to the set center wavelength and span.

Span setting can be performed in succession by using the rotary knob, step keys or ten-key pad, and the allowable setting range is 0 and 0.5 to 1200.0 nm (0.1 step).

The center wavelength span, measurement start wavelength and measurement end wavelength are changed through execution of this key.

(5) <0 nm SWEEP TIME> key

Sets the time required for measurement from the left end to the right end of the screen for a sweep when the span is 0 nm.

At this time, the sampling count is 1001 points.

When this key is pressed, the current sweep time is displayed in the interrupt display section.

The allowable setting range is MINIMUM and 1 to 50 sec (1 step) and the rotary knob, step keys or ten-key pad is used for setting.

(6) <HORZN SCL nm THz> key

Switches the wavelength display mode and frequency display mode.

When this key is pressed, the wavelength display mode is switched to the frequency display mode.

## NOTE

### *“ UNCAL ” Display*

*When the resolution is too small for the sampling intervals determined by the set span and the set number of samples, there is a possibility that data may not be collected perfectly.*

*In this equipment, when the span, number of samples and resolution are improperly set, “ UNCAL ” is displayed in the vicinity of the resolution display on the waveform frame.*

*In the status where “ UNCAL ” is displayed, correct measurement cannot be made. At that time, reduce the span or increase the number of samples or resolution before measurement so that “ UNCAL ” may not be displayed.*

*Besides, if the number of samples is automatically set using the <SAMPLING AUTO> key of the [SET UP] switch, the optimum number of samples is automatically set according to the settings of the span and resolution.*

## 5.1.5 [SPAN] switch (In frequency display mode)

The related sweep functions have been grouped in the SPAN switch area.

When this switch is pressed, the soft key menu shown in the following figure is displayed and the function of <SPAN> key is performed.

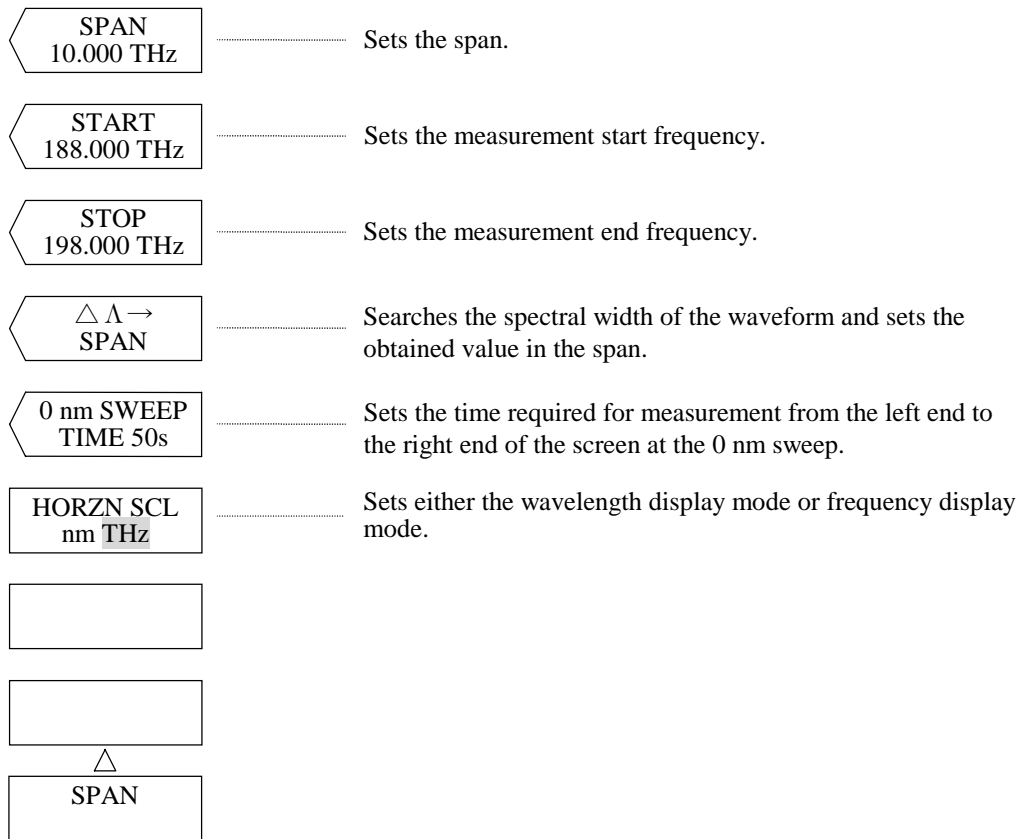

(1) <SPAN> key

Sets the span.

The allowable setting range is 0.010 to 350.000 (0.001 step) and the rotary knob, step keys or ten-key pad is used for setting.

When the setting has been changed, frequency rewrite processing is performed. Measurement start frequency setting and measurement end frequency setting are also changed at the same time.

(2) <START> key

Sets the measurement start frequency.

When this key is pressed, the current measurement start frequency is displayed in the interrupt display section.

The allowable setting range is 1.000 to 499.500 (0.001 step) and the rotary knob, step keys or ten-key pad is used for setting.

When the setting has been changed, waveform rewrite processing is performed.



(3) <STOP> key

Sets the measurement end frequency.

When this key is pressed, the current measurement end frequency is displayed in the interrupt display section.

The allowable setting range is 171.500 to 674.500 nm (0.001 step) and the rotary knob, step keys or ten-key pad is used for setting.

When the setting has been changed, waveform rewrite processing is performed.

When setting the measurement start frequency, the measurement end frequency is fixed.

When setting the measurement end frequency, the measurement start frequency is fixed.

Therefore, sweep width setting is changed. Mean wavelength setting is also changed at the same time.

When the ten-key pad is used for setting, the settable nearest value is set.

(4) < $\Delta\lambda \rightarrow$  SPAN> key

Executes a spectral width search for active trace internally and sets the obtained value in the center frequency and the span.

The spectral width search is made at an RMS of 20 dB and a magnification of 6.00.

After execution, the set span is displayed in the interrupt display section, and the displayed waveform is rewritten according to the set center frequency and span.

Span setting can be performed in succession by using the rotary knob, step keys or ten-key pad, and the allowable setting range is 0.010 to 350.000 nm (0.001 step).

The center wavelength span, measurement start frequency and measurement end frequency are changed through execution of this key.

(5) <0 nm SWEEP TIME> key

Sets the time required for measurement from the left end to the right end of the screen for a sweep when the span is 0 nm or 0 THz.

At this time, the sampling count is 1001 points.

When this key is pressed, the current sweep time is displayed in the interrupt display section.

The allowable setting range is MINIMUM and 1 to 50 sec (1 step) and the rotary knob, step keys or ten-key pad is used for setting.

(6) <HORZN SCL nm THz> key

Switches the wavelength display mode and frequency display mode.

When this key is pressed, the frequency display mode is switched to the frequency display mode.

## NOTE

### *“ UNCAL ” Display*

*When the resolution is too small for the sampling intervals determined by the set span and the set number of samples, there is a possibility that data may not be collected perfectly.*

*In this equipment, when the span, number of samples and resolution are improperly set, “ UNCAL ” is displayed in the vicinity of the resolution display on the waveform frame.*

*In the status where “ UNCAL ” is displayed, correct measurement cannot be made. At that time, reduce the span or increase the number of samples or resolution before measurement so that “ UNCAL ” may not be displayed.*

*Besides, if the number of samples is automatically set using the <SAMPLING AUTO> key of the [SET UP] switch, the optimum number of samples is automatically set according to the settings of the span and resolution.*

## 5.1.6 [LEVEL] switch

The related level axis setup functions have been grouped in the LEVEL switch area.

When this switch is pressed, the soft key menu shown in the following figure is displayed and the function of <REF LEVEL> key is performed.

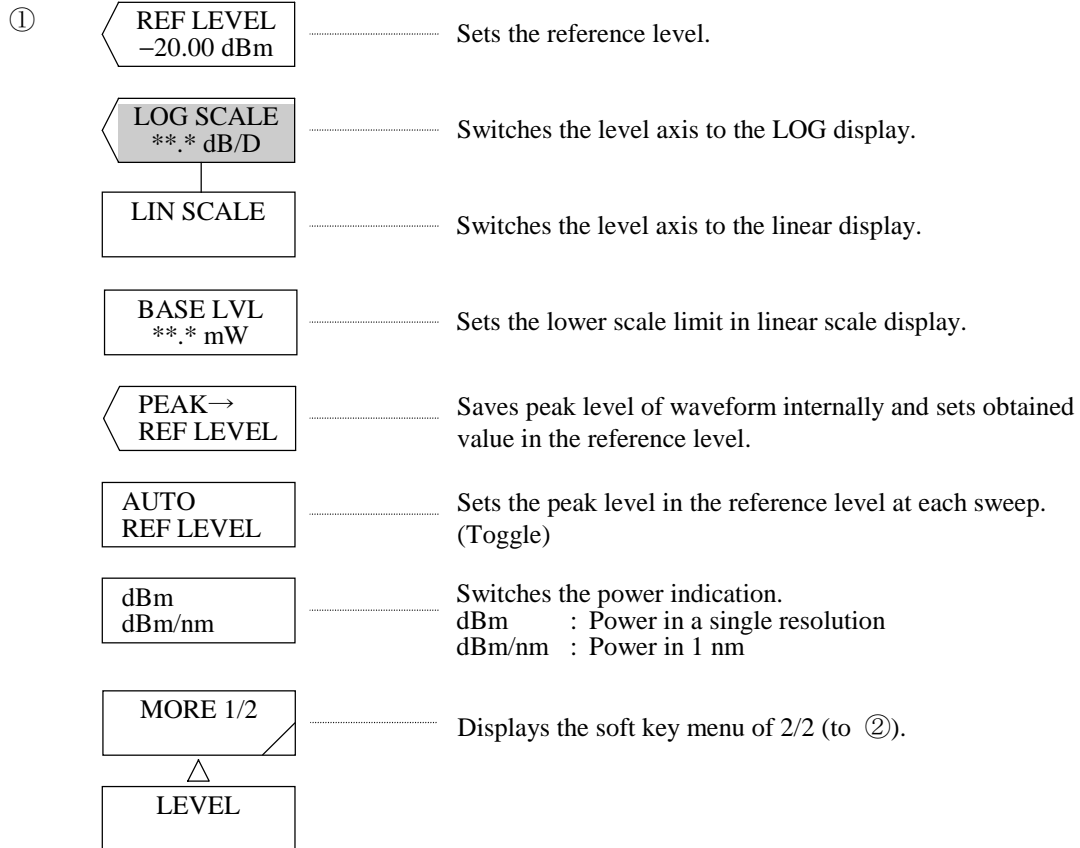

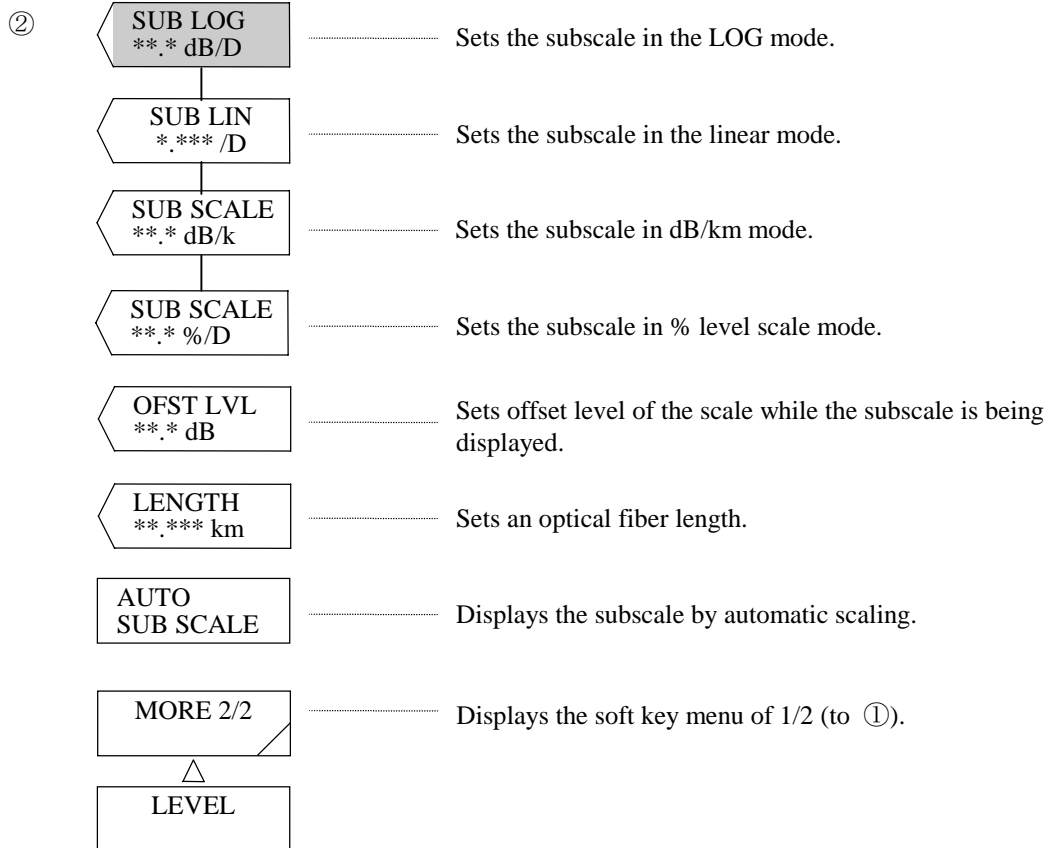

(1) <REF LEVEL> key

Sets the reference level.

Unit switches between "dBm" and "\*W" depending on in which of the LOG or linear the level scale is displayed. Also, there is difference in display position of the reference level between the LOG scale and the linear scale (See following page).

Allowable setting range in the LOG scale mode is -90 to +20.0 dBm (0.1 step). This setting is done with the rotary knob, step keys or ten-key.

Allowable setting range in the linear scale mode is 1.00 pW to 100 mW (1.00 to 9.99 [pW, nW, μW, mW]:0.01 step, 10.0 to 99.9 (100) [pW, nW, μW, (mW)]:0.1 step, 100 to 999 [pW, nW, μW]:1 step).

This setting is done with the rotary knob, step keys or ten-key. When ten-key is used for setting, the soft key menu ③ used for selecting the unit (pW, nW, μW, mW) appears upon pressing ten-key.

Enter value and press the soft key corresponding to the desired unit.

If [ENTER] of ten-key is pressed instead of unit key of the soft key, setting is performed using currently set unit. When a change such as 999 → 1.00 or 1.00 → 999 is done, change of unit also takes place.

(Example: pW → nW or nW → pW.)

When the reference level in the LOG mode or linear mode is changed, waveform being displayed is rewritten according to the reference level after change.

- When the main scale is in the linear scale (10 DIV)

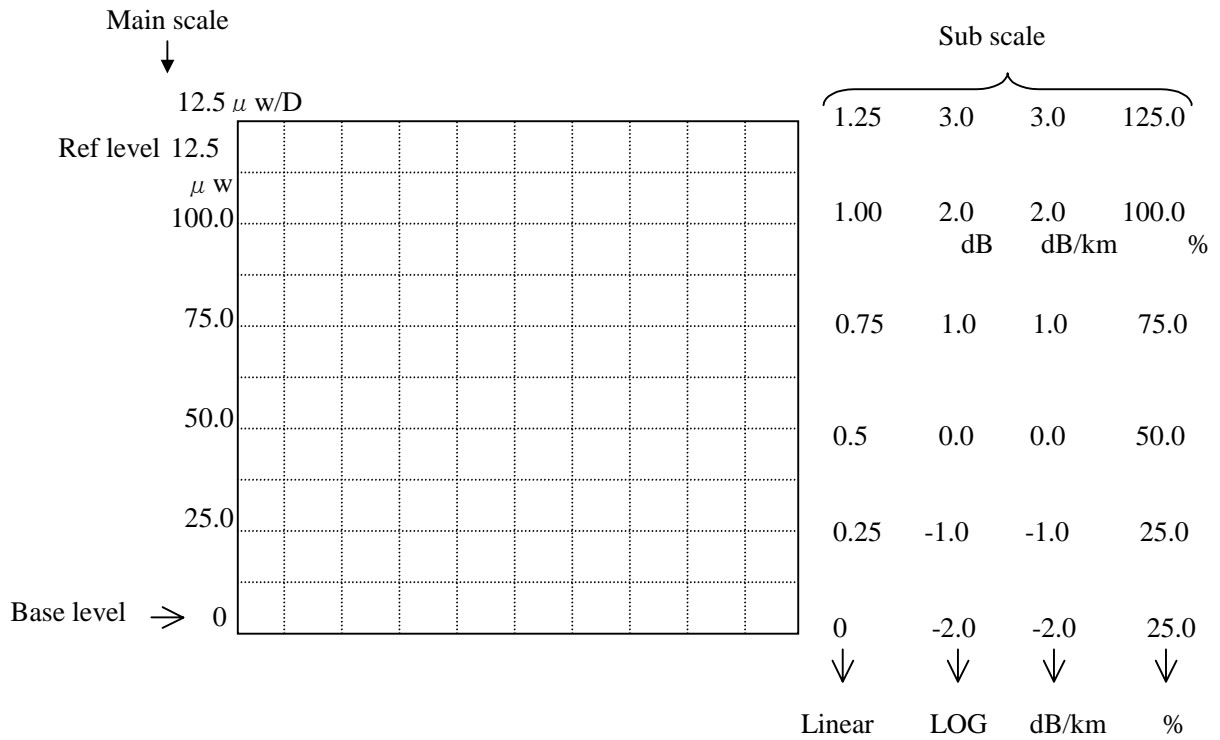

- When the main scale is in the LOG scale (8 DIV)

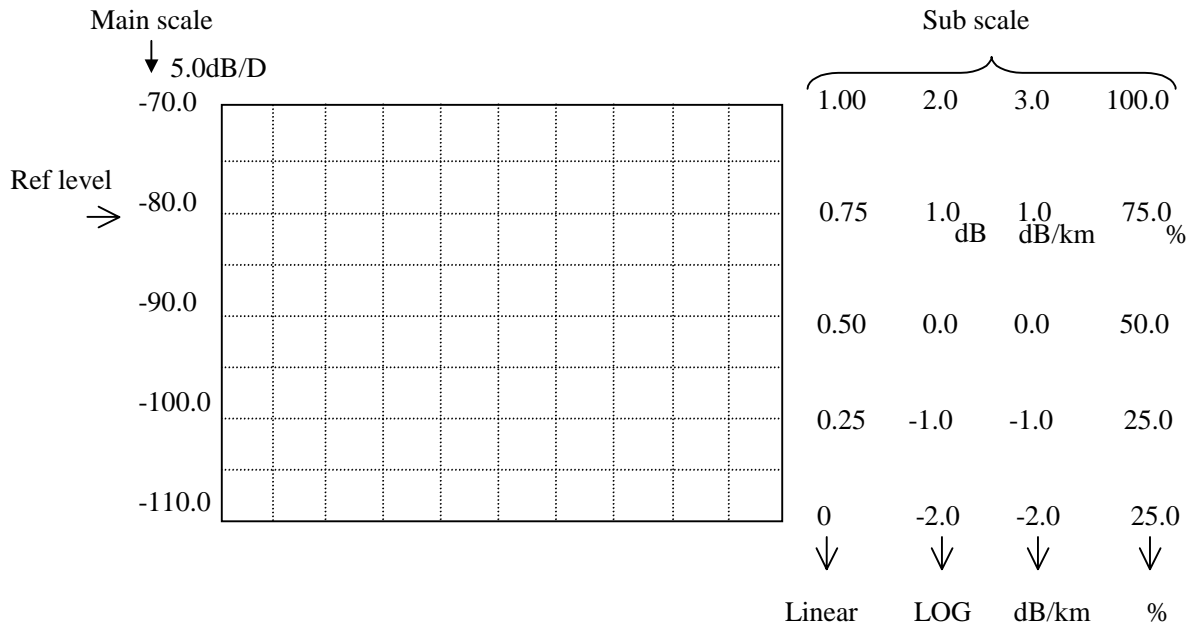

- (2) <LOG SCALE \*\*. \* dB/D> key  
 Switches the level axis to the LOG display and sets the level scale.  
 When this key is pressed, the level axis is set in the LOG scale and, at the same time, current set value is displayed in the interrupt display section.  
 Allowable setting range is 0.1 to 10.0 dB/DIV (0.1 step). Setting is done with the rotary knob, step keys or ten-key.  
 When the setting is changed, waveform being displayed is rewritten according to the level axis after change.  
 If setting is done to a scale equal to or larger than 5 dB/DIV in the range fixed mode (SENS:NORMAL RANGE HOLD) or pulse light measurement mode, WARNING will appear because accurate measurement of top and bottom of the waveform is impossible.  
 (→ 10.3.4 Valid range of level axis when the measurement sensitivity is set in NORMAL RANGE HOLD.)
- (3) <LIN SCALE> key  
 Sets the main scale in the linear scale.  
 Setting per 1DIV is done in the reference level.
- (4) <BASE LVL \*\*. \*mW> key  
 Sets the lower limit of the level scale if the liner level axis scale is used.  
 This setup is invalid in the LOG scale mode.  
 The allowable setting range is 0 to REF level multiplied by 0.9. Only the same unit set in the REF level is valid.  
 If the setup is changed, the on-screen waveforms are redrawn according to the level axis after change.  
 The scale of the left upper end waveforms is 1/10 (\*mW/D) of the REF (reference) level subtracted by the base level.
- (5) <PEAK → REF LEVEL> key  
 Searches peak level processing for active trace internally and sets the obtained value in the reference value.  
 After execution, the set reference level (peak level value) is displayed in the interrupt display section and rewrite processing is performed for the displayed waveform according to the reference level after the change.  
 The rotary knob, step keys or ten-key pad can be used for setting the reference level in succession.  
 Allowable range of change in the LOG mode scale is – 90.0 to +20.0 dBm (0.1 step) and that in the linear scale mode is 1.00 pW to 100 mW (1.00 to 9.999 [pW, nW, μW, mW] :0.01 step, 100 to 99.9 (100) [pW, nW, μW (mW)]:0.1 step, 100 to 999 [pW, nW, μW]:1 step).  
 If the peak level value exceeds the allowable setting range, it is set to the nearest value within the range and WARNING is displayed.

(6) <AUTO REF LEVEL> key

Sets the ON/OFF status of the PEAK → REF LEVEL function to be performed at each sweep.

When this key is selected, the peak level is searched from the active trace waveforms automatically during each sweep and the peak level is set to the reference level.

This function is disabled while the active trace is in the MAX HOLD, MIN, HOLD, CALC, EFFECT or ROLL AVG status.

In the reverse video status, 

AUT REF
------------

 is displayed at the bottom of the screen.

(7) <dBm dBm/nm> key

Switches the level axis scale display between "dBm" (mW,  $\mu$ W, nW or pW in Linear Scale mode) and "dB/nm" (mW/nm,  $\mu$ W/nm, nW/nm or pW/nm in Linear Scale mode).

dBm : Power in a single resolution

dB/nm : Power in 1 nm

Refer to Item 5.2.6. for usage of dBm and dB/nm.

(8) <SUB LOG> key

Sets the subscale in the LOG scale.

When this key is pressed, the current set value is displayed in the interrupt display section.

The allowable setting range is shown below and the rotary knob, step keys or ten-key pad is used for setting.

0.1 to 10.0 dB/DIV (0.1 step):

When the setting has been changed, rewrite processing is performed for the display waveform according to the scale after the change.

(9) <SUB LIN> key

Sets the subscale in the linear scale.

When this key is pressed, the current set value is displayed in the interrupt display section.

The allowable setting range is shown below and the rotary knob, step keys or ten-key pad is used for setting.

0.005 to 1.250/DIV (0.005 step): Upon execution of A/B or B/A

When the setting has been changed, rewrite processing is performed for the display waveform according to the scale after the change.

(10) <SUB SCALE \*\*. \*dB/km> key

Sets the subscale in dB/km.

When this key is pressed, the current set value is displayed in the interrupt display section.

The allowable setting range is 0.1 to 10.0 dB/km (at 0.1 step), and it can be set by the rotary knob, step keys, or numeric keys.

If the setup is changed, the on-screen waveforms are redrawn according to the scale after change.

- (11) <SUB SCALE  $***.*/D$ > key  
 Sets the subscale in percentage (%).  
 When this key is pressed, the current set value is displayed in the interrupt display section.  
 The allowable setting range is 0.5 to 125.0%/D (at 0.1 step), and it can be set by the rotary knob, step keys, or numeric keys.  
 If the setup is changed, the on-screen waveforms are redrawn according to the scale after change.
- (12) <OFST LVL> and <SCALE MIN> keys  
 When the subscale is in the "dB/m" or "dB/km" mode, the <OFST LVL> key set an offset.  
 During "dB/D" mode, the allowable setting range is 0 to  $\pm 99.9$  dB (at 0.1 step). During "dB/km" mode, the allowable setting range is 0 to  $\pm 99.9$  dB/km (at 0.1 step). They can be set by the rotary knob, step keys, or numeric keys.  
 When the subscale is in the "LIN" or "%" mode, the <SCALE MIN> key sets the scale lower limit value.  
 During "LIN" mode, the allowable setting range is 0 to the subscale value ( $***./D$ ) multiplied by 10.  
 During "%" mode, the allowable setting range is 0 to the subscale value ( $***.*/D$ ) multiplied by 10.  
 They can be set by the rotary knob, step keys, or numeric keys.
- (13) <LENGTH  $**.*km$ > key  
 Sets an optical fiber length.  
 The allowable setting range is 0.001 to 99.999 km (at 0.001 step), and it can be set by the rotary knob, step keys, or numeric keys.
- (14) <AUTO SUB SCALE> key  
 Sets the ON/OFF status of the function to display the subscale by automatic scaling after arithmetic operations when the trace C is set at <CALCULATE C> or <EFFECT C>.  
 When this key is selected, rewrite processing is performed for the displayed waveform according to the level axis scale after the change. SUB LOG, SUB LIN or OFST LVL are changed by automatic scaling.

In the reverse video status, 

AUT SCL
------------

 is displayed at the bottom of the screen.

### NOTE

#### *What is the subscale ?*

*When the differential waveforms (based on LOG value), normalized waveforms, or luminosity correction waveforms are displayed, the absolute value is shown on the level scale. On this equipment, the relative level scale is called the " subscale" .*  
*When both the waveforms of absolute and relative values are overlapped, the absolute value scale is shown at left and the relative value scale is shown at right.*  
*If the left scale (main scale) is switched to the LOG (8 DIV) or linear (10 DIV), the subscale is shown according to number of DIV of the main scale.*



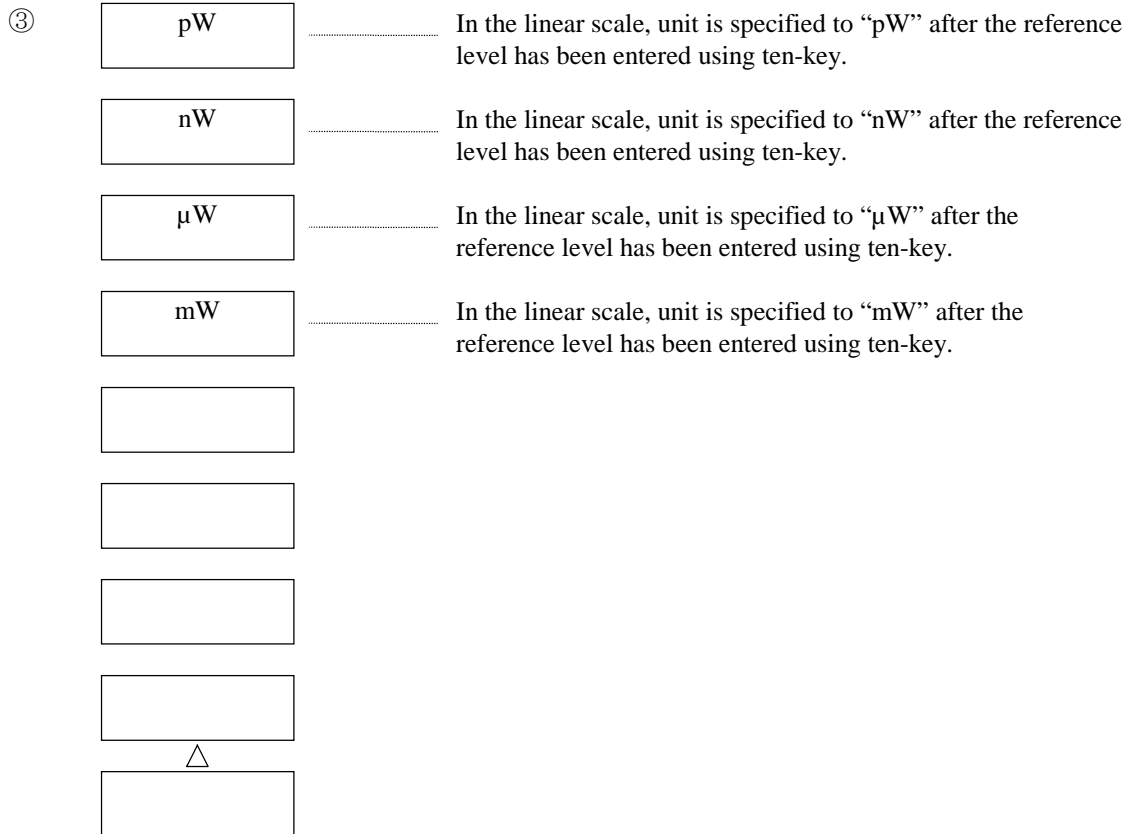

(15) <pW> key

Specifies unit of reference level to "pW" in the linear scale.

This soft key menu ③ can be shown by pressing ten-key while the screen is in the linear scale mode (this state is brought up by selecting <LIN SCALE>) and displaying interrupt of the reference level.

If this key is pressed following entry of value, scale is set and, at the same time, the soft key menu disappears and the screen returns to the state at the time when ten-key was pressed.

(16) <nW> key

Specifies unit of the reference level to "nW" in the linear scale.

This soft key menu ③ can be shown by pressing ten-key while the screen is in the linear scale mode (this state is brought up by selecting <LIN SCALE>) and displaying interrupt of the reference level.

If this key is pressed following entry of value, scale is set and, at the same time, the soft key menu disappears and the screen returns to the state at the time when ten-key was pressed.

(17) <μW> key

Specifies unit of the reference level to "μW" in the linear scale.

This soft key menu ③ can be shown by pressing ten-key while the screen is in the linear scale mode (this state is brought up by selecting <LIN SCALE>) and displaying interrupt of the reference level.

If this key is pressed following entry of value, scale is set and, at the same time, the soft key menu disappears and the screen returns to the state at the time when ten-key was pressed.

(18) <mW> key

Specifies unit of the reference level to "mW" in the linear scale.

This soft key menu ③ can be shown by pressing ten-key while the screen is in the linear scale mode (this state is brought up by selecting <LIN SCALE>) and displaying interrupt of the reference level.

If this key is pressed following entry of value, scale is set and, at the same time, the soft key menu disappears and the screen returns to the state at the time when ten-key was pressed.

### 5.1.7 [SETUP] switch

The relative measuring condition setup functions have been grouped in the SETUP switch area.

When this switch is pressed, the soft key menu of ① is displayed.

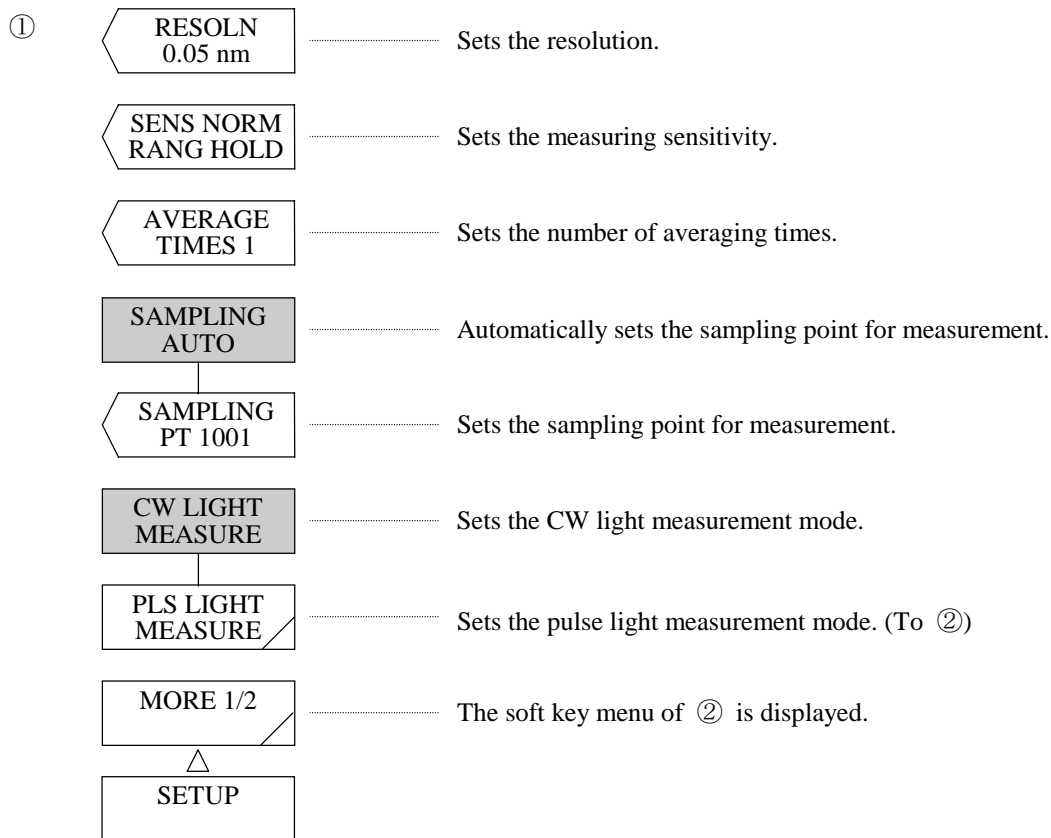

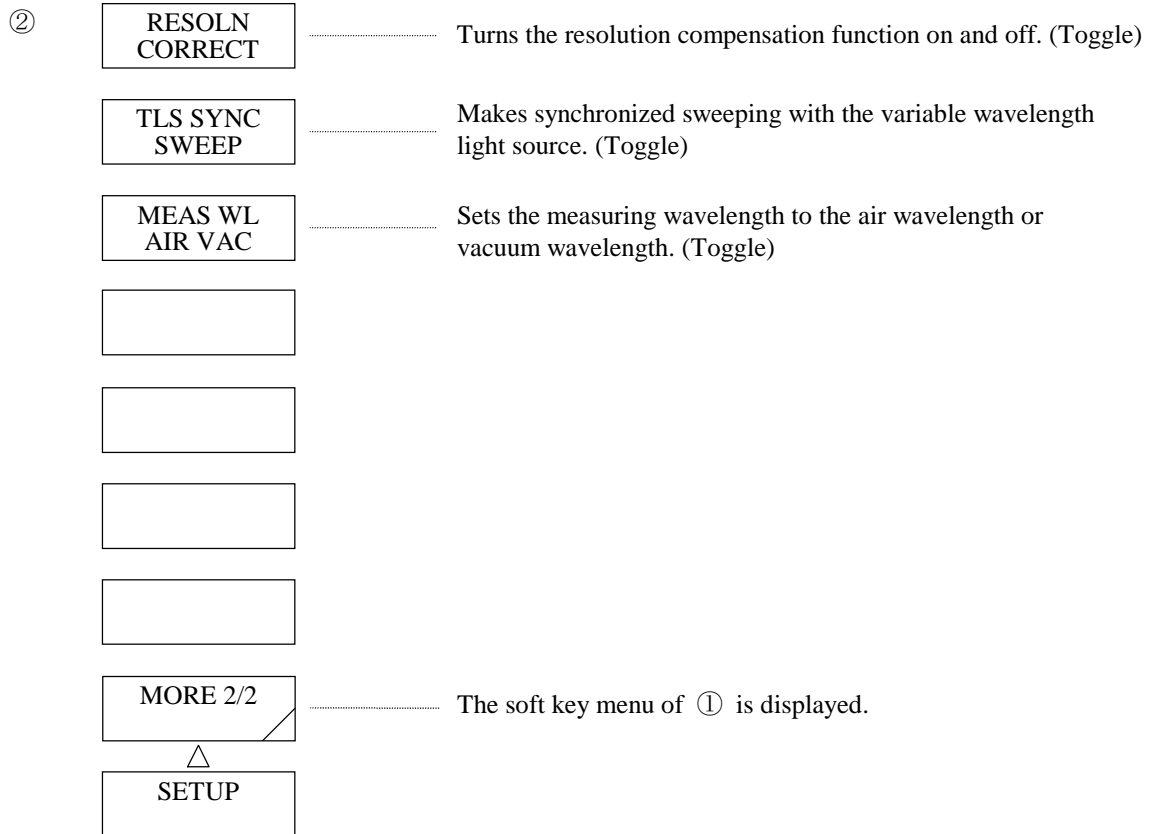

- (1) <RESOLN> key  
Sets the resolution.  
When this key is pressed, the current resolution is displayed in the interrupt display section.  
The allowable setting range is 0.01 to 2 nm (1, 2 or 5 steps) and the rotary knob, step keys or ten-key pad is used for setting.

**NOTE**

*When an optical fiber with large-diameter cores is used, the maximum resolution is restricted, so that the set resolution may not be obtained.  
(→ 10.3.3 Restriction on resolution)*

- (2) <SENS> key  
Sets the measuring sensitivity.  
This equipment permits selecting 5 measuring sensitivity levels according to the use.  
When this key is pressed, the current measuring sensitivity is displayed in the interrupt display section.  
The allowable setting range is NORMAL RANGE HOLD, NORMAL RANGE AUTO, MID, HIGH 1, HIGH 2 and HIGH 3. The display is changed in rotation by the rotary knob or step keys as "NORMAL RANGE HOLD", "NORMAL RANGE AUTO", "MID", "HIGH 1", "HIGH 2" and "HIGH 3" in order to select a desired sensitivity level. (→8.1.3 Measuring sensitivity selection)

- (3) <AVERAGE TIME> key

Sets the number of averaging times for each measurement point.

When this key is pressed, the current number of averaging times is displayed in the interrupt display section.

The allowable setting range is 1 to 1000 times (1 step) and the rotary knob, step keys or ten-key pad is used for setting.

#### NOTE

*If the number of averaging times is large (e.g., 1000 times) at a measuring sensitivity level of HIGH 1 to 3, the time required for sweeps becomes extremely long.*

- (4) <SAMPLING AUTO> key

Sets on and off the function that automatically sets the sampling count for measurement. When this key is selected, the sampling count is automatically set according to the settings of span and resolution.

- (5) <SAMPLING PT> key

Sets the sampling point for one sweep.

When this key is pressed, the current sampling count is displayed in the interrupt display section.

The allowable setting range is 11 to 20001 points (1 step) and the rotary knob, step keys or ten-key pad is used for setting.

Usually, this mode is used for measurement.

#### NOTE

##### *“ UNCAL ” Display*

*When the resolution is too small for the sampling intervals determined by the set span and the set number of samples, there is a possibility that data may not be collected perfectly.*

*In this equipment, when the span, number of samples and resolution are improperly set, “ UNCAL ” is displayed in the vicinity of the resolution display on the waveform frame.*

*In the status where “ UNCAL ” is displayed, correct measurement cannot be made. At that time, reduce the span or increase the number of samples or resolution before measurement so that “ UNCAL ” may not be displayed.*

*Besides, if the number of samples is automatically set using the <SAMPLING AUTO> key of the [SET UP] switch, the optimum number of samples is automatically set according to the settings of span and resolution.*

- (6) <CW LIGHT MEASURE> key

Sets the CW light measurement mode.

In this mode, every measuring sensitivity can be set.

(7) <PLS LIGHT MEASURE>

Sets the pulse light measurement mode. (→ 5.2.1 Pulse light measuring function)

When this key is pressed, it is displayed in reverse video and the soft key menu of ② is displayed.

If the <PEAK HOLD> key is displayed in reverse video in the soft key menu of ②, the current hold time is displayed in the interrupt display section.

In this mode, the measuring sensitivity can not be changed.

(8) <RESOLN CORRECT> key

Turns the resolution compensation function on and off.

Press this key and the its indication is reversed and the resolution compensation function becomes effective.

At this time,  appears at the low end section of the display

With the optical spectrum analyzer, the wavelength resolution is preset by changing the slit width inside the monochromator. Consequently, the setting does not always coincide with the actual resolution levels.

With this equipment, for example, when the resolution is set to 0.1 nm, the actual resolution level becomes 0.09 nm at 1,310 nm and it becomes 0.06 nm at 1,550 nm.

When the resolution compensation function is turned on, the measurement data are software-processed so that the actual resolution coincides with the preset resolution level. Turn this resolution compensation function on when it is necessary to use actual resolution level which equals to the preset resolution level.

Nonetheless, it is invalid in the following cases:

- When the resolution setting is made to 0.01 nm.  
compensation function
- When the measuring wavelength is 1,250 nm or less.

(9) <TLS SYNC SWEEP> key

Sets on and off the synchronous sweep function for the wavelength variable light source. When this key is selected, the wavelength variable light source connected to the GP-IB 2 port is swept interlocking with the sweep of this equipment. (→ Interlock sweep function for the wavelength variable light source)

(10) <MEAS WL AIR VAC> key

Sets the measuring wavelength to the air wavelength or vacuum wavelength.

While the "AIR" is being selected, the measuring wavelength becomes air wavelength and while the "VAC" is being selected, the measuring wavelength becomes vacuum wavelength.

Meanwhile, when the vacuum wavelength is being selected (when the "VAC" indication is being reversed),  appears at the low end section of the display.

\* Changeover  according to this function is valid to the measuring wavelength only and changing over the <MEAS WL AIR VAC> key after measurement has been finished and while the measured wavelength is being indicated does not work to change the wavelength.

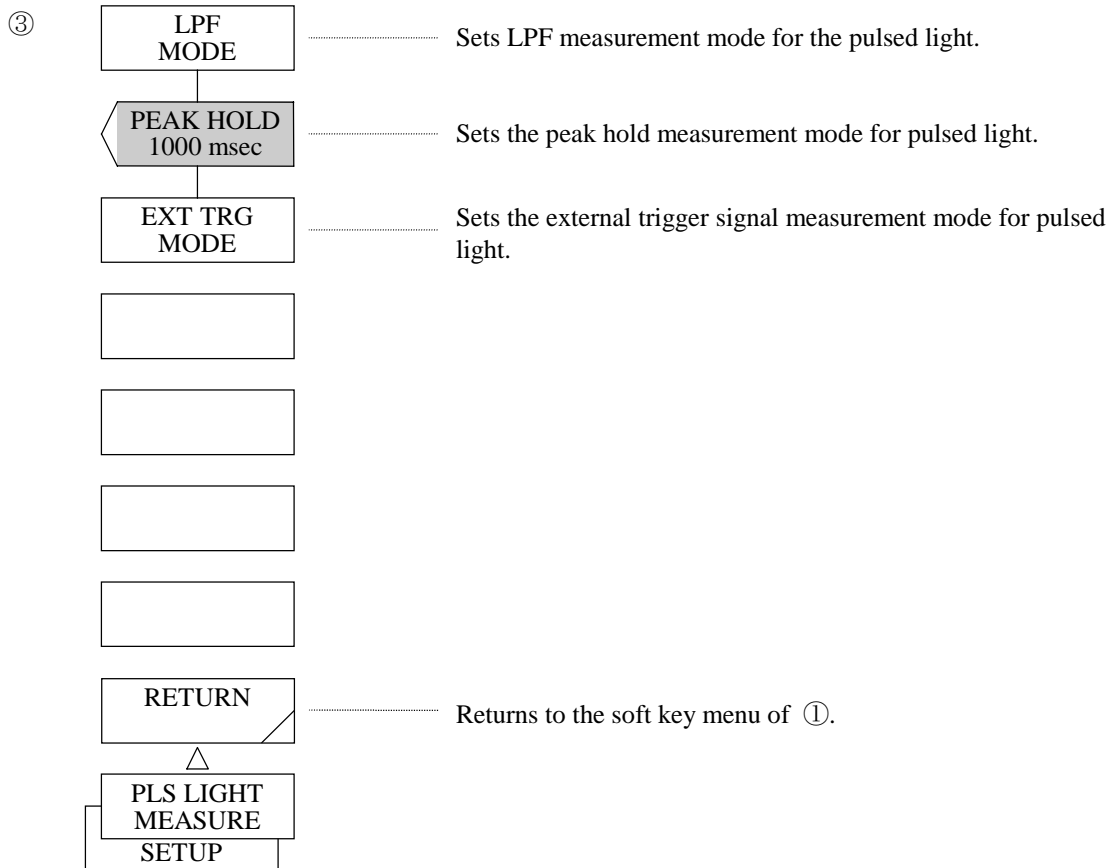

(11) <LPF MODE> key

Sets the mode for measuring pulse light by using a Low Pass Filter. (→ 5.2.1 Pulse light measuring function)

When this key is pressed, it is displayed in reverse video and LPF mode is entered.

(12) <PEAK HOLD> key

Sets the mode for measuring the peak level of pulse light. (→ 5.2.1 Pulse light measuring function)

When this key is pressed, it is displayed in reverse video and PEAK HOLD mode is entered.

The hold time is shown in the interrupt display area.

It can be set within the range of 1 msec to 9999 msec using the rotary knob, step keys or ten keys.

(13) <EXT TRG MODE> key

Sets the mode for measuring pulse light by external trigger signal. (→ 5.2.1 Pulse light measuring function)

When this key is pressed, it is displayed in reverse video and external trigger mode is entered.

(14) <RETURN> key

Returns to the soft key menu of ①.

## 5.1.8 [MARKER] switch

This switch performs the setting related to the marker function.

When this switch is pressed, the soft key menu of ① is displayed.

### NOTE

*In the three-dimensional display mode, the waveforms displayed by the step keys can be selected by use of the marker. The parameters can be changed by the rotary control knob or numeric keys.*

①	MARKER	Displays the moving marker.
	MARKER→ CENTER	Sets the wavelength of the moving marker to the center wavelength.
	MARKER→ REF LEVEL	Sets the level of the moving marker to the reference level.
	SET MARKER 1&2	Sets the moving marker to the fixed marker 1 or 2.
	SET MKR	Sets the moving marker to the fixed marker with the specified number.
	CLR MKR	Clears the fixed marker with the specified number.
	ALL MKR CLEAR	Clears the displayed moving marker and fixed marker.
	MORE 1/3	Displays the soft key menu of 2/3.
	△ MARKER	

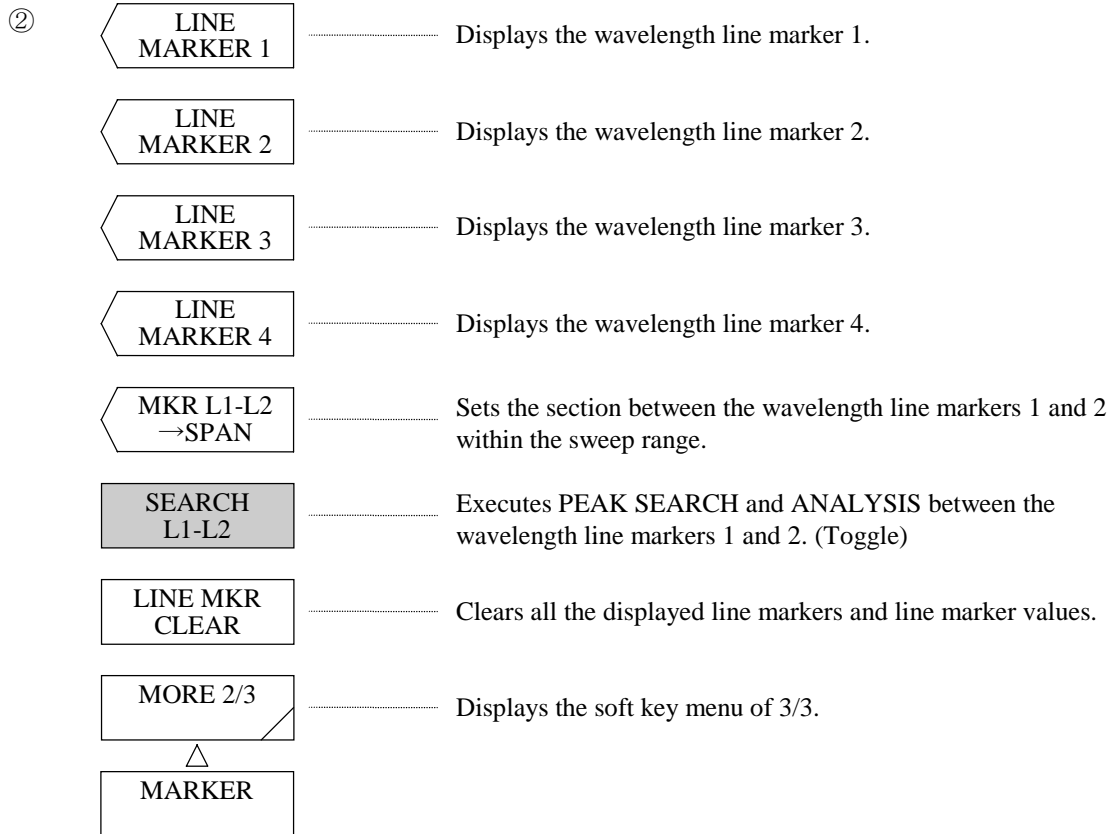

(1) <MARKER> key

Displays the moving marker.

When no moving marker appears, it is displayed on the waveform in the center (point 501) of the screen and the marker value is displayed in the data area. If a moving marker already appears, it remains at the current displayed position without change.

After pressing this key, the moving marker can be moved by the rotary knob or step keys.

(2) <MARKER → CENTER> key

Sets the wavelength of the moving marker to the center wavelength.

After execution, the set mean wavelength is displayed in the interrupt display section. At this time, center wavelength setting, measurement start wavelength setting and measurement end wavelength setting are changed.

Center wavelength setting can be performed in succession by using the rotary knob, step keys or ten-key pad.

The allowable setting range is 600.00 to 1750.00 nm (0.01 step).



(3) <MARKER → REF LEVEL> key

Sets the level of the moving marker to the reference level.

After execution, the set reference level is displayed in the interrupt display section and rewrite processing is performed for the displayed waveform according to the reference level after the change.

Reference level setting can be performed in succession by using the rotary knob, step keys or ten-key pad. Allowable range of change in the LOG scale is – 90.0 to +20.0 dBm (0.1 step) and that in the linear scale is 1.00 pW to 100 mW (1.00 to 9.99 [pW, nW, μW, mW]:0.01 step, 10.0 to 99.9 (100) [pW, nW, μW, (mW)]:0.1 step, 100 to 999[pW, nW, μW]:1 step).

If the moving marker value exceeds the allowable setting range, it is set to the nearest value in the range and WARNING is displayed.

(4) <SET MARKER 1&2> key

If the fixed marker is not set, this key sets the fixed marker 1 at the position of the moving marker. When the fixed marker 1 is set, the fixed marker 2 is set and the marker value is displayed in the data area.

(5) <SET MKR> key

Sets the moving marker to the fixed marker with the specified number and displays the marker value in the data area. When this key is pressed, the marker number is displayed in the interrupt display section, and can be changed by using the rotary knob, step keys, or ten-key pad. The menu (④) of this soft key is displayed. When the <SET> key is pressed, the fixed marker with the specified number is set.

(6) <CLR MKR> key

Clears the fixed marker with the specified number and also the marker value from the data area. When this key is pressed, the marker number is displayed in the interrupt display area, and can be changed by using the rotary knob, step keys, or ten-key pad. The menu (⑤) of this soft key is displayed. When the <CLEAR> key is pressed, the fixed marker with the specified number is cleared.

(7) <ALL MKR CLEAR> key

Clears the displayed moving marker and fixed marker and also the marker value in the data area.

(8) <LINE MARKER 1> key

Displays the wavelength line marker 1.

While the moving marker is displayed, the wavelength line marker 1 is displayed at the position of the moving marker. When the moving marker is not displayed, the wavelength line marker 1 is displayed at the 1/4 position from the left end of the screen.

When the wavelength line marker 1 already appears, it remains at the displayed position without change. After execution, the wavelength line marker 1 can be moved by the rotary knob or step keys.

- (9) <LINE MARKER 2> key  
 Displays the wavelength line marker 2.  
 While the moving marker is displayed, the wavelength line marker 2 is displayed the position of the moving marker. When the moving marker is not displayed, the wavelength line marker 2 is displayed at the 1/4 position from the right end of the screen.  
 When the wavelength line marker 2 already appears, it remains at the displayed position without change.  
 After execution, the wavelength line marker 2 can be moved by the rotary knob or step keys.
- (10) <LINE MARKER 3> key  
 Displays the level line marker 3.  
 While the moving marker is displayed, the level line marker 3 is displayed at the 1/4 from the upper end of the screen. When the level line marker 3 already appears, it remains at the displayed position without change.  
 After execution, the level line marker 3 can be moved by the rotary knob or step keys.
- (11) <LINE MARKER 4> key  
 Displays the level line marker 4.  
 While the moving marker is displayed, the level line marker 4 is displayed at the position of the moving marker. When the moving marker is not displayed, the level line marker 4 is displayed at the 1/4 position from the lower end of the screen.  
 When the level line marker 4 already appears, it remains at the displayed position without change.  
 After execution, the level line marker 4 can be moved by the rotary knob or step keys.
- (12) <MKR L1-L2 → SPAN> key  
 Sets the section between the wavelength line markers 1 and 2 within the sweep range and performs rewrite processing.  
 After execution, the set span is displayed in the interrupt display section. When a span change is made, the displayed waveform is rewritten according to the set span.  
 Span setting can be performed in succession by using the rotary knob, step keys or ten-key pad.  
 The allowable setting range is 0 and 1.0 to 1500.0 nm (0.1 step).  
 Span setting, measurement start wavelength setting and measurement end wavelength setting can be changed by executing this key.

#### NOTE

*When both WL1 and WL2 are set, set the smaller value to the measurement start wavelength and the larger value to the measurement end wavelength.  
 When only WL1 is set, set the marker value to the measurement start wavelength and the right end of the screen to the measurement end wavelength.  
 When only WL2 is set, set the left end of the screen to the measurement start wavelength and the marker value to the measurement end wavelength.*

- (13) <SEARCH L1-L2> key  
 When this key is selected and the wavelength line markers 1 and 2 are set, PEAK SEARCH or ANALYSIS is executed between the markers 1 and 2.  
 When this key is not selected, it is executed within the effective range of the screen.

## NOTE

When both WL1 and WL2 are set, it is executed between the line marker 1 and 2.  
 When only WL1 is set, it is executed between the line marker 1 and the right end of the screen.  
 When only WL2 is set, it is executed between the left end of the screen and the line marker 2.  
 When WL1 and WL2 are not set, it is executed for all range of the screen.

In the reverse video status, SRC  
1-2 is displayed at the bottom of the screen.

(14) <LINE MKR CLEAR> key

Clears all the displayed line markers and line marker values.

- ③
- |   |       |  |
|---|-------|--|
| <span style="border: 1px solid black; padding: 2px;">MULTI-MKR<br/>DISPLAY</span> | ..... | Switches the marker value display to the multi-marker display. (Toggle)  |
| <span style="border: 1px solid black; padding: 2px;">OFFSET<br/>SPACING</span>    | ..... | In the multi-marker display, selects whether to display the display column of a subtraction value for the difference in the moving marker or adjacent marker. (Toggle) |
| <span style="border: 1px solid black; padding: 2px;">LVL DIGIT 2</span>           | ..... | Specifies the number of digits (below a decimal point) for the level display of the marker.  |
| <span style="border: 1px solid black; padding: 2px;">MKR LIST<br/>PRINT</span>    | ..... | Prints the multi-marker value.   |
| <span style="border: 1px solid black; padding: 2px;">MKR AUTO<br/>UPDATE</span>   | ..... | Makes the waveform track the fixed marker level position at the active trace updating time. (Toggle)   |
| <span style="border: 1px solid black; padding: 2px;">MKR UNIT<br/>nm THz</span>   | ..... | Selects the wavelength display mode or the frequency display mode for marker value display. (Toggle)   |
| <span style="border: 1px solid black; padding: 2px;"> </span>                     | ..... |  |
| <span style="border: 1px solid black; padding: 2px;"> </span>                     | ..... |  |
| <span style="border: 1px solid black; padding: 2px;">▲<br/>MORE 3/3</span>        | ..... | Displays the soft key menu of 1/3. (To ①)  |

(15) <MULTI-MKR DISPLAY> key

Switches the marker value display to the multi-marker display.

When this key is selected, a moving marker value and up to three fixed marker values are displayed in the data area. If four or more fixed markers are set, the data area is scrolled up or down by pressing the step keys and the remaining fixed marker values can be displayed.

If this key is not selected, only the values of the moving marker and fixed marker 1 or 2 are displayed. This display is the same as that of the AQ-6315 series. Usually, use this key as it remains pressed.

(16) <OFFSET SPACING> key

In the multi-marker display, selects whether to display the display column of a subtraction value for the difference (OFFSET) in the moving marker and adjacent marker.

- Examples of the multi-marker display

(For OFFSET)

▽	:1552.000 nm	-10.000 dBm	▽-▽n :	
▽01	:1552.100 nm	-20.000 dBm	0.100 nm	-10.000 dBm
▽02	:1552.200 nm	-30.000 dBm	0.200 nm	-20.000 dBm
▽03	:1552.300 nm	-40.000 dBm	0.300 nm	-30.000 dBm

➤ Difference in the moving marker (▽)

(For SPACING)

▽	:1552.000 nm	-10.000 dBm	SPACING :	
▽01	:1552.100 nm	-20.000 dBm	0.100 nm	-10.000 dBm
▽02	:1552.200 nm	-30.000 dBm	0.100 nm	-10.000 dBm
▽03	:1552.300 nm	-40.000 dBm	0.100 nm	-10.000 dBm

➤ Difference in the preceding marker

The window can be scrolled up or down by the step keys.

If the marker is set outside the screen, the screen is scrolled up or down to the position where the value can be displayed.

Only the marker that is set is displayed.

(17) <LVL DIGIT \*> key

Specifies the number of level display digits (below a decimal point) of the marker.

After execution, the number of level display digits (below a decimal point) of the marker is displayed in the interrupt display section, and can be changed by using the rotary knob, step keys, or ten-key pad.

The changeable range is 1 to 3 (1 step).

(18) <MKR LIST PRINT> key

Prints the multi-marker value to the built-in printer.

(19) <MKR AUTO UPDATE> Key

While this key is selected, the fixed marker level value being displayed in the data area is updated each time the active trace waveform is updated.

(20) <MKR UNIT nm THz> Key

Switches the marker value display between in the wavelength display mode and in the frequency display mode.

When this key is pressed, the marker value display unit (wavelength/frequency) can be set independently from the horizontal axis unit (wavelength/frequency) for waveform display set with the <HORZN SCL nm THz> Key.

The setting with this key changes as the setting with the <HORZN SCL nm THz> key changes, but the setting with the <HORZN SCL nm THz> key does not change even when the setting with this key changes. (When the X axis is in the frequency display mode, marker values can be set to the wavelength display mode.)

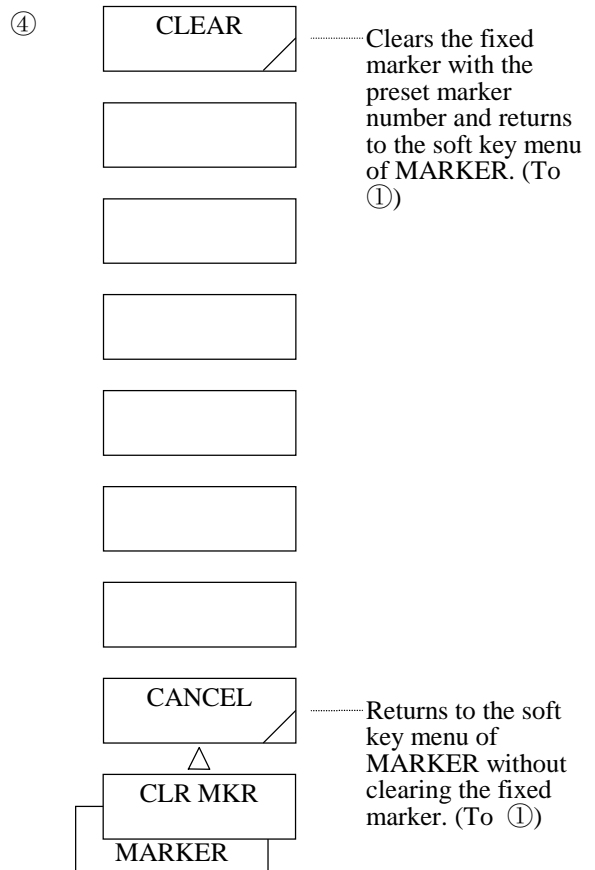
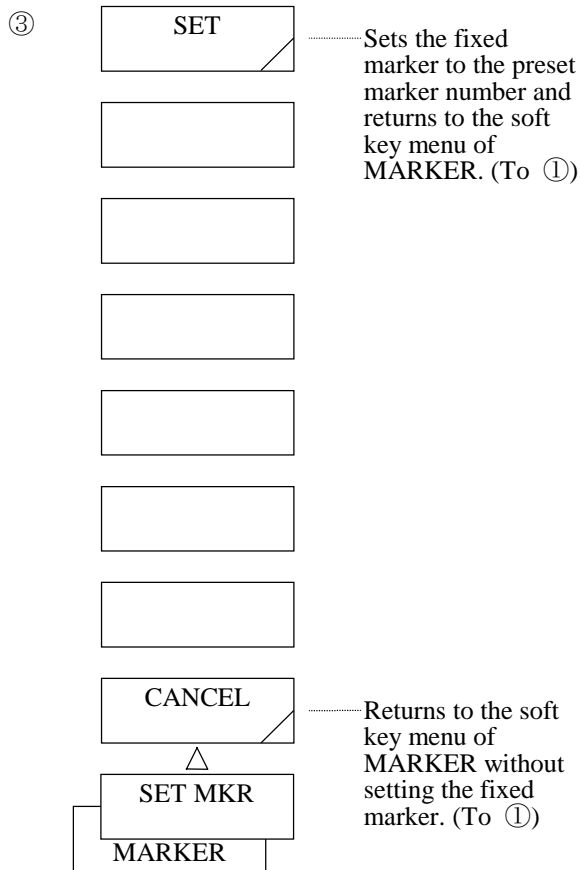

(21) <SET> key

Sets the fixed marker to the preset marker number.

After setting, it returns to the soft key menu of [MARKER]. (To ①)

(22) <CLEAR> key

Clears the fixed marker with the preset marker number.

If the fixed marker is not provided, it clears the moving marker.









After clearing, it returns to the soft key menu of [MARKER]. (To ①)

(23) <CANCEL> key

Returns to the soft key menu of [MARKER] without setting (clearing) the fixed marker. (To ①)

## 5.1.9 [PEAK SEARCH] switch

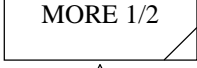
When this switch is pressed, the soft key menu of ① is displayed and the <PEAK SEARCH> key or <BOTTOM SEARCH> key that is selected is executed.

①		.....	Detects the maximum value of level and sets the moving marker.
		.....	Detects the minimum value of level and sets the moving marker.
		.....	Detects the next maximum value/minimum value and sets the moving marker.
		.....	Sets the moving marker to the right-hand next maximum value/minimum value.
		.....	Sets the moving marker to the left-hand next maximum value/minimum value.
		.....	Sets the moving marker to the fixed marker 1 or 2.
		.....	Sets the moving marker to the fixed marker with the specified number.
		.....	Displays the soft key menu of 2/2.
			

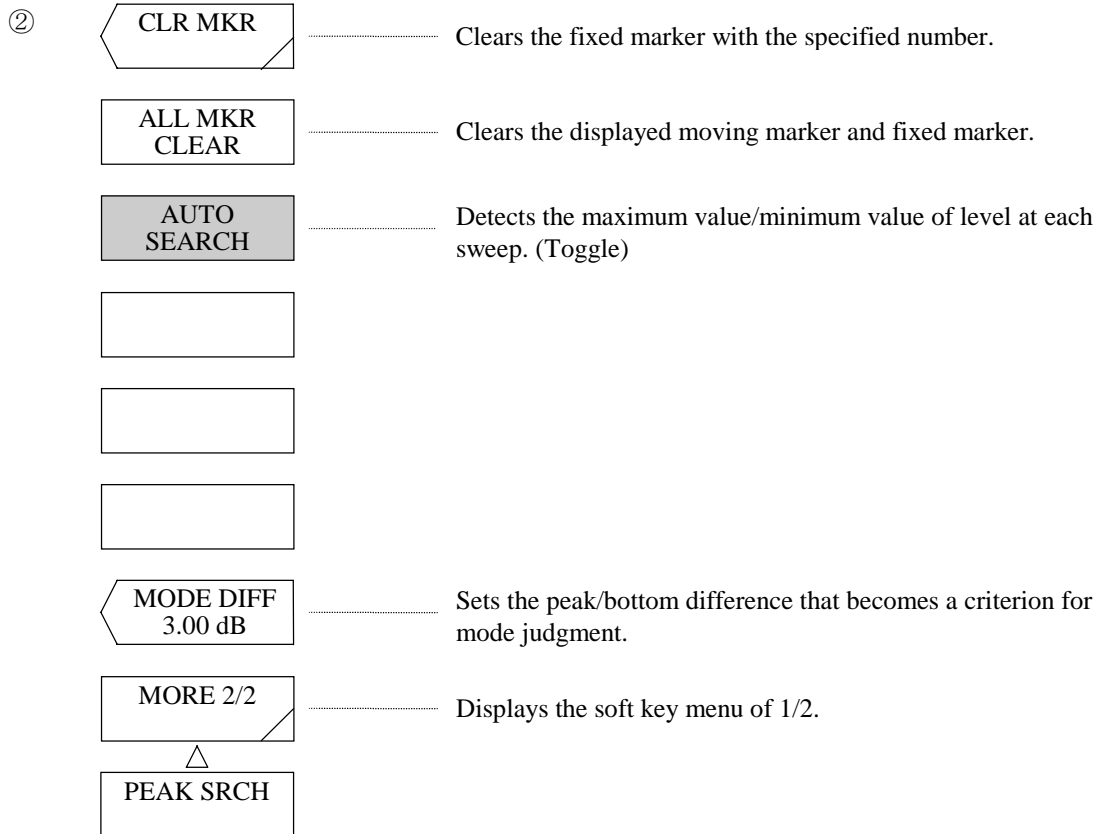

- (1) <PEAK SEARCH> key  
 Makes a peak search (detection of the maximum value of level) for the active trace, sets the moving marker and displays the marker value in the data area. When the peak level exceeds the upper end or lower end of the screen, the marker is displayed at the upper end or lower end, and the marker value is displayed correctly.  
 After execution, the marker can be moved by the rotary knob or step keys.
- (2) <BOTTOM SEARCH> key  
 Makes a bottom search (detection of the minimum value of level) for the active trace, sets the moving marker, and displays the marker value in the data area. When the bottom level exceeds the upper end or lower end of the screen, the marker is displayed at the upper end or lower end, and the marker value is displayed correctly.  
 After execution, the marker can be moved by the rotary knob or step keys.
- (3) <NEXT SEARCH> key  
 Sets the moving marker to the peak (maximum value of level) or bottom (minimum value of level) next to the current set moving marker value (level value) on the active trace. When such a peak or bottom does not exist, the moving marker is continuously displayed at the same position.  
 When the peak or bottom exceeds the upper end or lower end, the marker value is displayed correctly.

- (4) <NEXT SRCH RIGHT> key  
Sets the moving marker to the peak (maximum value of level) or bottom (minimum value of level) on the right of the current set moving marker value (level value) on the active trace. When such a peak or bottom does not exist, the moving marker is continuously displayed at the same position. When the peak or bottom exceeds the upper end or lower end of the screen, the marker value is displayed correctly.
- (5) <NEXT SRCH LEFT> key  
Sets the moving marker to the peak (maximum value of level) or bottom (minimum value of level) on the left of the current set moving marker value (level value) on the active trace. When such a peak or bottom does not exist, the moving marker is continuously displayed at the same position. When the peak or bottom exceeds the upper end or lower end of the screen, the marker value is displayed correctly.
- (6) <SET MARKER 1&2> key  
If the fixed marker is not set, this key sets the fixed marker 1 at the position of the moving marker. When the fixed marker 1 is set, the fixed marker 2 is set and the marker value is displayed in the data area.
- (7) <SET MKR> key  
Sets the moving marker to the fixed marker with the specified number and displays the marker value in the data area. After execution, the marker number is displayed in the interrupt display section, and can be changed by using the rotary knob, step keys, or ten-key pad. The menu (③) of this soft key is displayed and the mark number is set.
- (8) <CLR MKR> key  
Clears the fixed marker with the specified number and also the marker value from the data area. After execution, the marker number is displayed in the interrupt display section, and can be changed by using the rotary knob, step keys, or ten-key pad. When this key is pressed, the menu (④) of this soft key is displayed and the specified number is set.
- (9) <ALL MKR CLEAR> key  
Clears the displayed moving marker and fixed marker and also the marker value in the data area.
- (10) <AUTO SEARCH> key  
Sets the ON/OFF status of the peak/bottom function at each sweep. When this key is selected, a peak/bottom search is automatically made after completion of the sweep, and the moving marker is set.  
  
In the reverse video status, 

AUT SRC
------------

 is displayed at the bottom of the screen.
- (11) <MODE DIFF> key  
Sets the minimum difference (dB) between the top and bottom points of waveforms to be used as the mode selection reference when a mode is selected by <PEAK SEARCH> or <ANALYSIS> key. When this key is pressed, the current set value is displayed in the interrupt display section. The allowable setting range is 0.01 to 50.00 dB (0.01 step) and the rotary knob, step keys or ten-key pad is used for setting.



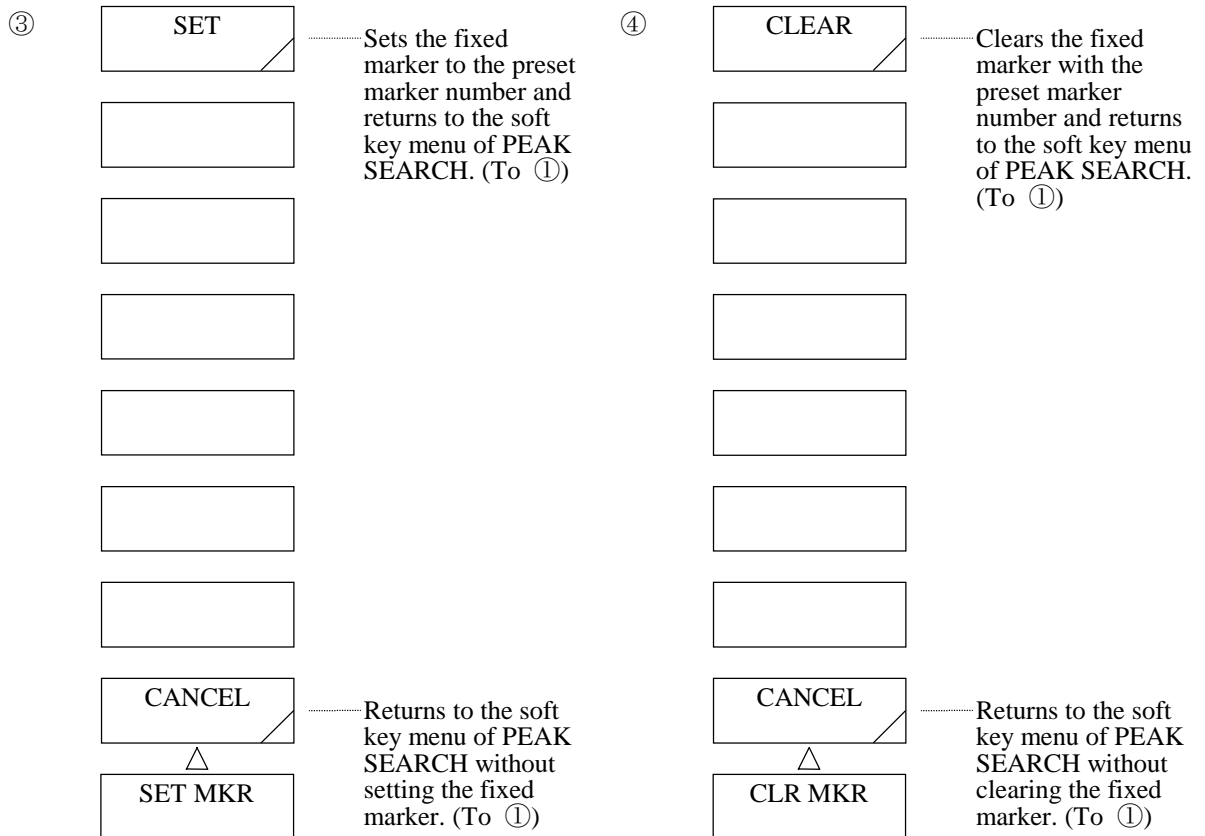

(12) <SET> key

Sets the fixed marker to the preset marker number.

After setting, it returns to the soft key menu of [PEAK SEARCH]. (To ①)

(13) <CLEAR> key

Clears the fixed marker with the preset marker number.

If the fixed marker is not provided, it clears the moving marker.

After clearing, it returns to the soft key menu of [PEAK SEARCH]. (To ①)

(14) <CANCEL> key

Returns to the soft key menu of [PEAK SEARCH] without setting (clearing) the fixed marker. (To ①)

## 5.1.10 [ANALYSIS] switch

The related spectrum analysis functions have been grouped in this ANALYSIS switch area.

When this switch is pressed, the soft key menu of ① is displayed, and also a selected key among the first 3 keys from the top is executed.

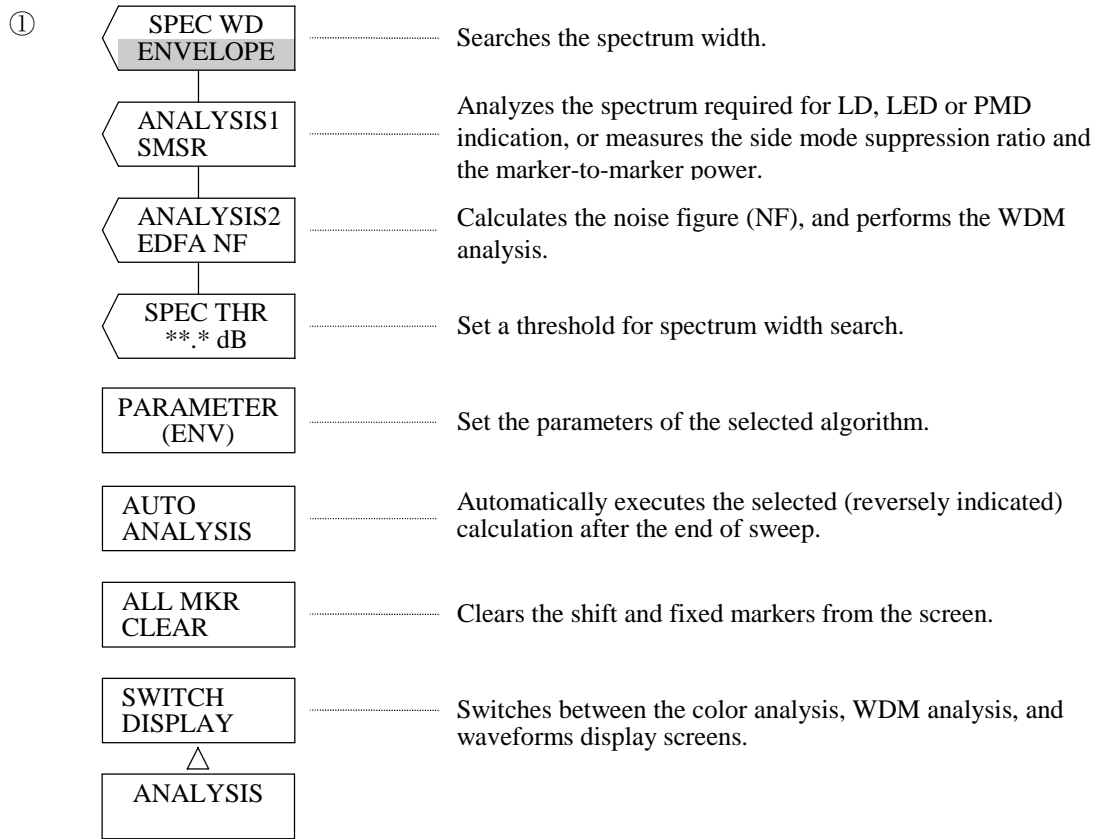

### (1) <SPEC WD \*\*\*\*\*> key

Measures the spectrum width.

When this key is pressed, the algorithm is displayed on the screen. Also, the spectrum width is measured based on the selected algorithm, the exclusive marker is set, and the spectrum width is displayed in the data area.

The following algorithm parameters can be set by the rotary knob or step keys:

Parameters: ENVELOPE, THRESH, RMS, PEAK RMS, NOTCH

### (1)-1 <SPEC WD ENVELOPE> key

Displays the spectral width by the envelope method on active trace.

Also, this key sets the dedicate marker.

The threshold can be set by the <SPCWD THR \*.\*dB> key. The other parameters can be set from the soft key menu which is displayed when the <PARAMETER(\*\*\*\*\*)> key is pressed.

When there is no data on the active trace, WARNING is displayed.

For the algorithm using the envelope method, refer to 5.4.1.

(1)-2 <SPEC WD THRESH> key

Displays the spectral width by the threshold method on active trace.

Also, this key sets the exclusive marker.

The threshold can be set by the <SPCWD THR \*.\*dB> key. The other parameters can be set from the soft key menu which is displayed when the <PARAMETER(\*\*\*\*\*)> key is pressed.

When there is no data on active trace, WARNING is displayed.

For the algorithm using the threshold method, refer to 5. 4. 2.

(1)-3 <SPEC WD RMS> key

Displays the spectral width by the RMS method on active trace.

Also, this key sets the exclusive marker.

The threshold can be set by the <SPCWD THR \*.\*dB> key. The other parameters can be set from the soft key menu which is displayed when the <PARAMETER(\*\*\*\*\*)> key is pressed.

When there is no data on active trace, WARNING is displayed.

For the algorithm using the RMS method, refer to 5.4.3.

(1)-4 <SPEC WD PEAK RMS> key

Displays the spectral width by the PEAK RMS method on active trace.

Also, this key sets the exclusive marker.

When this key is selected, only the peak point of each mode exceeding the limit value on the displayed waveform is calculated.

The threshold can be set by the <SPCWD THR \*.\*dB> key. The other parameters can be set from the soft key menu which is displayed when the <PARAMETER(\*\*\*\*\*)> key is pressed.

When there is no data on active trace, WARNING is displayed.

For the algorithm using the PEAK RMS method, refer to 5.4.3.

(1)-5 <SPEC WD NOTCH> key

Measures the notch width of fiber grading transparent spectrum and others. For the notch width measurement algorithm, see Section 5.4.4.

The threshold can be set by the <SPCWD THR \*.\*dB> key. The other parameters can be set from the soft key menu which is displayed when the <PARAMETER(\*\*\*\*\*)> key is pressed.

(2) <ANALYSIS 1\*\*\*\*\*> key

Measures the side-mode suppression ratio (SMSR) and the marker-to-marker power. Also, it can perform analysis required for LD, LED and PMD indication.

When this key is pressed, the analysis type is indicated displayed in the interrupt display area.

Also, the currently selected analysis is executed, the exclusive marker is set, and the measured results are displayed in the data area.

The following analysis parameters can be set using the rotary knob or step keys.

Parameters: SMSR, POWER, FP-LD, DFB-LD, LED, PMD

(2)-1 <ANALYSIS1 SMSR> key

Measures the side mode suppression ratio (SMSR) of the active trace, sets the moving marker and fixed marker 1 to the peak level of the waveform and the fixed marker 2 to the second highest level, and displays the result in the data area.

This function is mainly used for DFB laser measurement.

When there is no data on active trace, WARNING is displayed.

(2)-2 <ANALYSIS1 POWER> key

Makes a power measurement between markers for active trace.

When the <SEARCH L1-L2> key is displayed in reverse video, the integrated power enclosed by the wavelength line markers 1 and 2 is calculated and the level line marker 3 is set. Then, the integrated power value is displayed in the data area.

When the <SEARCH L1-L2> key is displayed in non-reverse video, power is calculated within the effective range of the screen.

When the <SEARCH L1-L2> key is displayed in reverse video and both wavelength line markers 1 and 2 are set out of the range, this is regarded as a no data status and WARNING is displayed.

The range for integration varies with the set status of the wavelength line markers.

Fig. 5-1 shows the range for integration at each setting by hatching.

① Both markers 1 and 2 are set.

② Only the marker 1 is set.

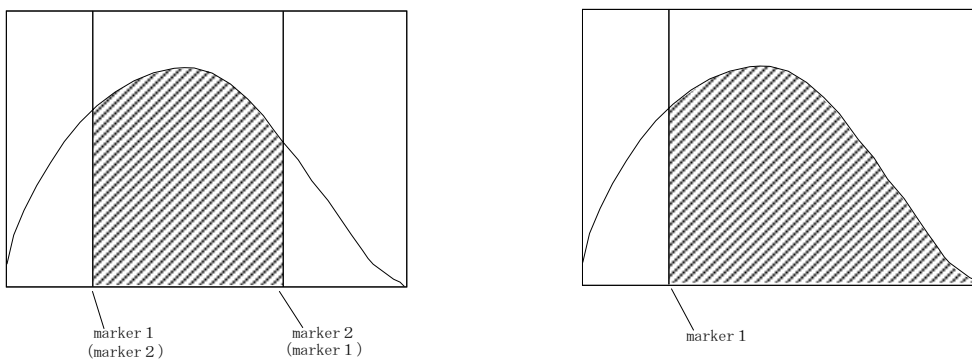

Fig. 5-1 Power Range Between Markers (1/2)

③ Only the marker 2 is set.

④ No marker is set.

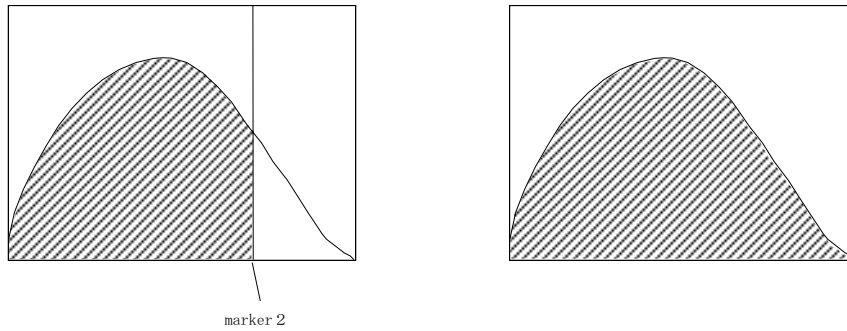

Fig. 5-1 Power Range Between Markers (2/2)

Power measurement calculation is made by the following expression.

$$P = S \times \Sigma \left( \frac{P_i}{R_i} \right)$$

In case of the A-B or B-A waveform:

$$P = S \times \Sigma P_i$$

P : Measured powervalue

S : Wavelength difference between display points  $\left[ \frac{\text{SPAN}}{\text{SAMPLE POINTS}-1} \right]$

P<sub>i</sub> : Level at each point

R<sub>i</sub> : Effective resolution value at the wavelength at each point (Stored in this equipment)

(2)-3 <ANALYSIS1 FP-LD> key

Makes an analysis required for FP-LD (Fabry-Perot laser diode) and displays the result in the data area for active trace. Regardless of the select status of the <SEARCH L1-L2> key, analysis is made for all the range of active trace.

The analysis items are as follows (Parameter can be set except for peak wavelength and peak level) :

- [MEAN WL]
- [MODE] (Mode number)
- [TOTAL POWER]
- [PK WL] (Peak wavelength)
- [PK LVL] (Peak level)
- [SPEC WD]

(2)-4 <ANALYSIS1 DFB-LD> key

Makes an analysis required for distributed feedback-laser diode (DFB-LD) and displays the result in the data area for active trace.

Regardless of the select status of the <SEARCH L1-L2> key, analysis is made for all the range of active trace.

The analysis items are as follows (Parameter can be set for SMSR and band width) :

- [SMSR] (Side-Mode Suppression Ratio)
- [MODE OFFSET] (space between a peak level and the next peak level)
- [PK WL] (Peak wavelength)
- [PK LVL] (Peak level)
- [- X dB WD]

(2)-5 <ANALYSIS1 LED> key

Makes an analysis required for LED (light emitting diodes) and displays the result in the data area.

Regardless of the select status of the <SEARCH L1-L2> key, analysis is made for all the range of active trace.

When noise mask is set, the above measurement is made after completion of the noise mask.

The analysis items are as follows (Parameter can be set except for peak wavelength and peak level) :

- [MEAN WL]
- [TOTAL POWER]
- [PK WL] (Peak wavelength)
- [PK LVL] (Peak level)
- [SPEC WD]

(2)-6 <ANALYSIS1 PMD> key

Performs the PMD analysis for the waveform of the active trace and the results are displayed in the data area. For details of the PDM analysis, see section 8.3.

(3) <ANALYSIS2 \*\*\*\*\*> Key

This key allows executing the following analyses:

- ① Calculation of noise figure (NF)
- ② WDM analysis
- ③ WDM-NF (multi-channel NF) analysis
- ④ Optical filter (PEAK) analysis
- ⑤ Optical filter (BOTTOM) analysis

When this key is pressed, the types of analyses are displayed in the interrupt display area.

At the same time, the type of analysis currently selected is executed, the dedicated marker is set and the measured value is displayed in the data area. The following analysis parameters can be set with the rotary knob or the step key:

Parameters : EDFA-NF, WDM, WDM-NF, FIL-PK, FIL-BTM

(3)-1 <ANALYSIS2 EDFA NF> key

Calculates NF (NOISE FIGURE) on the supposition that pre-amplification waveform and post-amplification waveform of the optical amplifier are put in the trace A and trace B and displays the result in the data area.

If the measurement conditions are different between the trace A and the trace B, WARNING is displayed.

For the NF measuring function, refer to 5.3.1.

(3)-2 <ANALYSIS2 WDM> key

Calculates the peak wavelength, peak level, and SNR of each channel of WDM waveforms.

Also, this key calculates the wavelength difference and level difference when any channel is selected.

The results are listed and displayed.

For the WDM analysis algorithm, see Section 5.3.3.

(3)-3 <ANALYSIS2 WDM-NF> Key

Calculates NF (noise figure) for each WDM channel in block on the assumption that the WDM waveforms before and after amplification with the light amplifier are placed in the traces A and B, and displays the result in the data area.

For the NF measuring function, refer to 5.3.4.

(3)-4 <ANALYSIS2 FIL-PK> Key

Analyzes the following items in block for the waveform with which the optical filter (transmission type) and displays the results in the data area:

- ① Peak level
- ② Peak wavelength
- ③ Center wavelength
- ④ Peak width
- ⑤ Cross talk
- ⑥ Ripple width

For the algorithm of the optical filter analysis function, see Paragraph 5.3.5.

(3)-5 <ANALYSIS2 FIL-BTM> Key

Analyzes the following items in block for the waveform with which the optical filter (notch type) and displays the results in the data area:

- ① Bottom level
- ② Bottom wavelength
- ③ Center wavelength
- ④ Notch width
- ⑤ Cross talk

For the algorithm of the optical filter analysis function, see Paragraph 5.3.5.

(4) <SPEC THR \*.\*dB> key

Sets a threshold for spectrum width measurement.

When this key is pressed, the threshold is indicated in the interrupt display area. Also, the spectrum width is measured based on the current threshold, and the marker and data area are displayed.

The parameter corresponds to the TH or TH1 of each algorithm, and the parameters can be set for each algorithm.

The parameters can be set in the following range.

ENVELOPE	:	0.01 to 50.00 dB (at 0.01 step)
THRESH	:	0.01 to 50.00 dB (at 0.01 step)
RMS, PEAK RMS	:	0.01 to 50.00 dB (at 0.01 step)
NOTCH	:	0.01 to 50.00 dB (at 0.01 step)

(5) <PARAMETER> key

Displays a soft key menu (soft key menus of ② to ⑳) for setting parameters for a selected key out of the above keys of (1) to (3)

A different soft key menu is displayed depending on the one out of 3 select status.

(6) <AUTO ANALYSIS> key

Sets the ON/OFF status of the ANALYSIS function to be executed at each sweep. When this key is selected, a selected key out of the above keys (1) to (3) is automatically executed after completion of the sweep.

If the <AUTO PEAK SEARCH> key is selected when this key is latched, the <AUTO PEAK SEARCH> key is cleared.

When the latch status of the <AUTO PEAK SEARCH> key is cleared by latching this key or when ANALYSIS cannot be executed upon completion of a sweep, WARNING is displayed.

In the reverse video status, 

AUT
ANA

 is displayed at the bottom of the screen.

(7) <ALL MKR CLEAR> key

Clears the displayed moving marker and fixed marker and also the marker value in the data area.

(8) <SWITCH DISPLAY> key

Switches between the WDM list displayed by the <ANALYSIS2 WDM> key, and the waveforms screen.

This key is valid only when the <ANALYSIS2 WDM> key has been pressed.



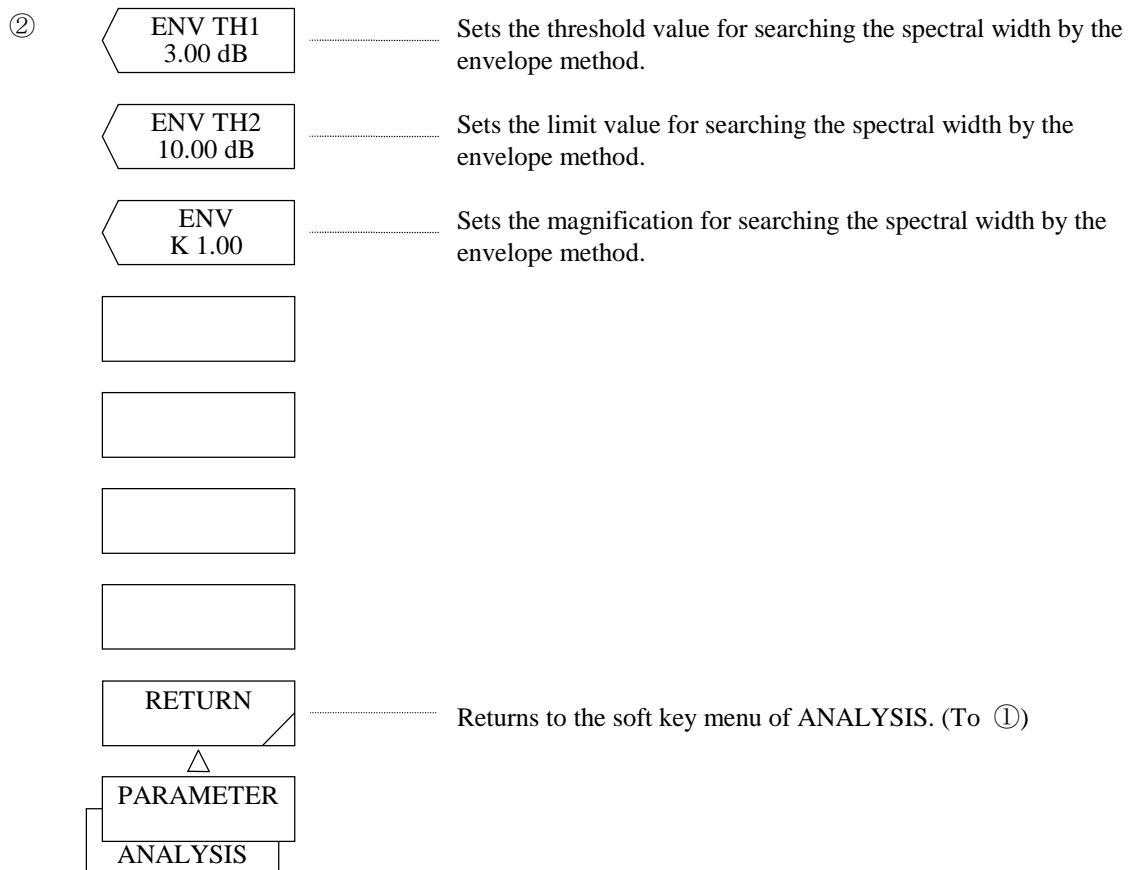

- (9) <ENV TH1> key  
 Sets the threshold value for the spectral width search by the envelope method.  
 After execution, the current threshold value is displayed in the interrupt display section.  
 The threshold value can be changed in the range of 0.01 to 50.00 dB (0.01 step) by the rotary knob, step keys or ten-key pad.
- (10) <ENV TH2> key  
 Sets the limit value for the spectral width search by the envelope method.  
 After execution, the current limit value is displayed in the interrupt display section.  
 The limit value can be changed in the range of 0.01 to 50.00 dB (0.01 step) by the rotary knob, step keys or ten-key pad.
- (11) <ENV K> key  
 Sets the magnification for spectral width search by the envelope method.  
 After execution, the current magnification is displayed in the interrupt display section.  
 The magnification can be changed in the range of 1.00 to 10.00 (0.01 step) by the rotary knob, step keys or ten-key pad.
- (12) <RETURN> key  
 Returns the soft menu key of ANALYSIS ①.

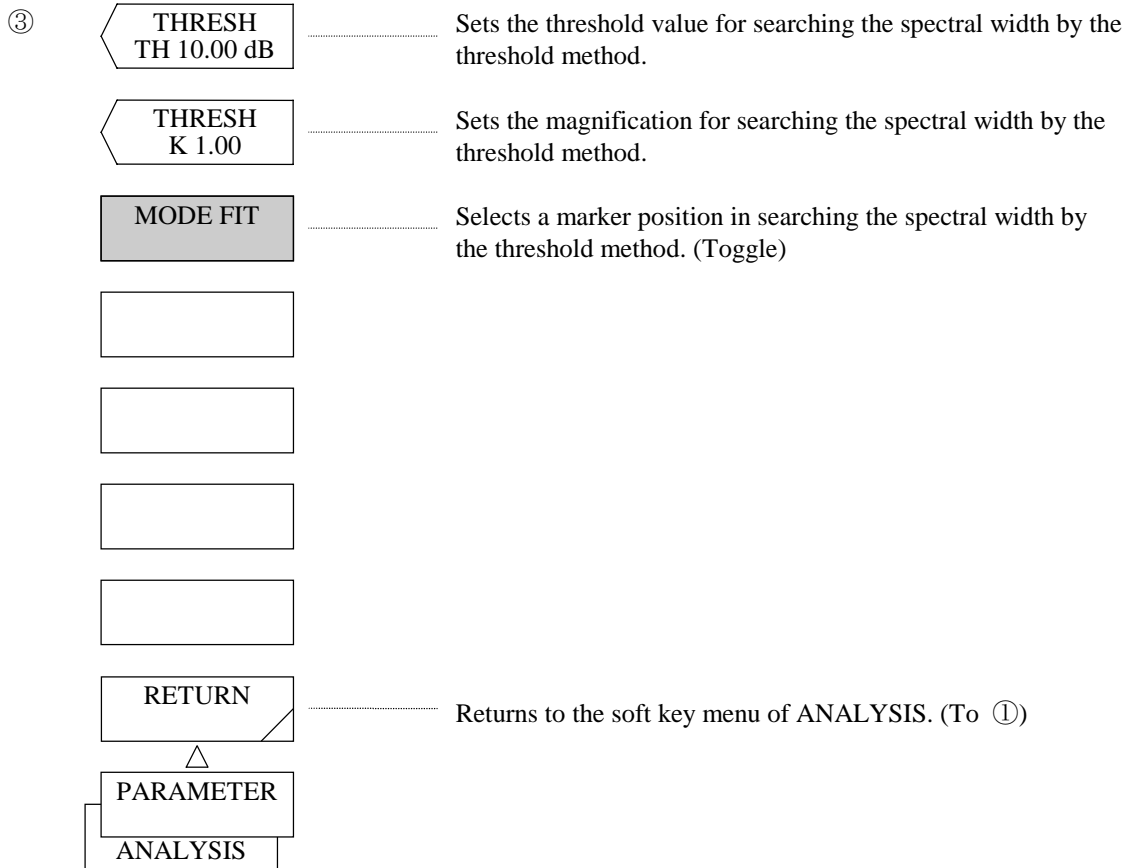

(13) <THRESH TH> key

Sets the threshold value for the spectral width search by the threshold method.  
After execution, the current threshold value is displayed in the interrupt display section.  
The threshold value can be changed in the range of 0.01 to 50.00 dB (0.01 step).

(14) <THRESH K> key

Sets the magnification for the spectral width search by the threshold method.  
After execution, the current magnification is displayed in the interrupt display section.  
The magnification can be changed in the range of 1.00 to 10.00 (0.01 step) by the rotary knob, step keys or ten-key pad.

(15) <MODE FIT> key

Selects whether the marker is to be set to the mode peak or to the position where the level agrees with the threshold level when a spectral width search by the threshold method is executed (magnification K = 1).

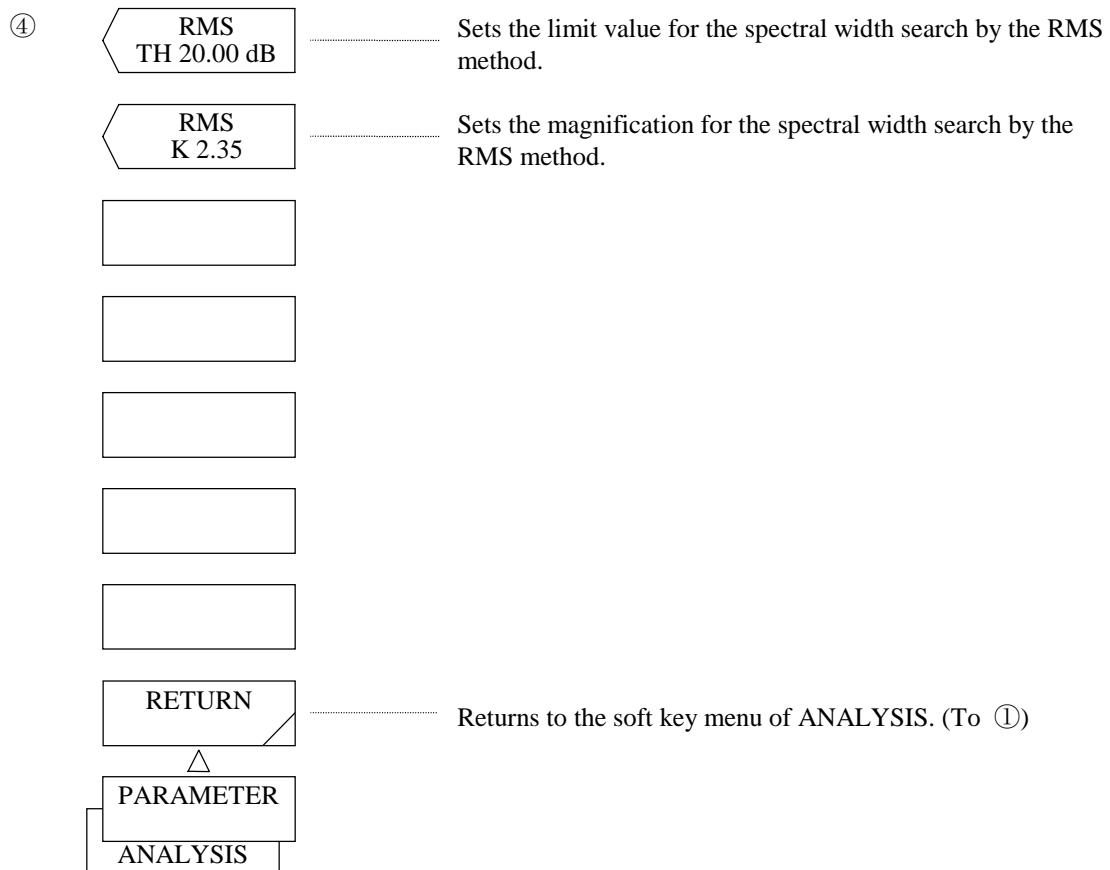

(16) <RMS TH> key

Sets the limit value for the spectral width search by the RMS.

After execution, the current value is displayed in the interrupt display section.

The limit value can be changed in the range of 0.01 to 50.00dB (0.01 step) by the rotary knob, step key or ten-key pad.

(17) <RMS K> key

Sets the magnification for the spectral width search by the RMS method.

After execution, the current magnification is displayed in the interrupt display section.

The magnification can be changed in the range of 1.00 to 10.00 (0.01 step) by the rotary knob, step keys or ten-key pad.

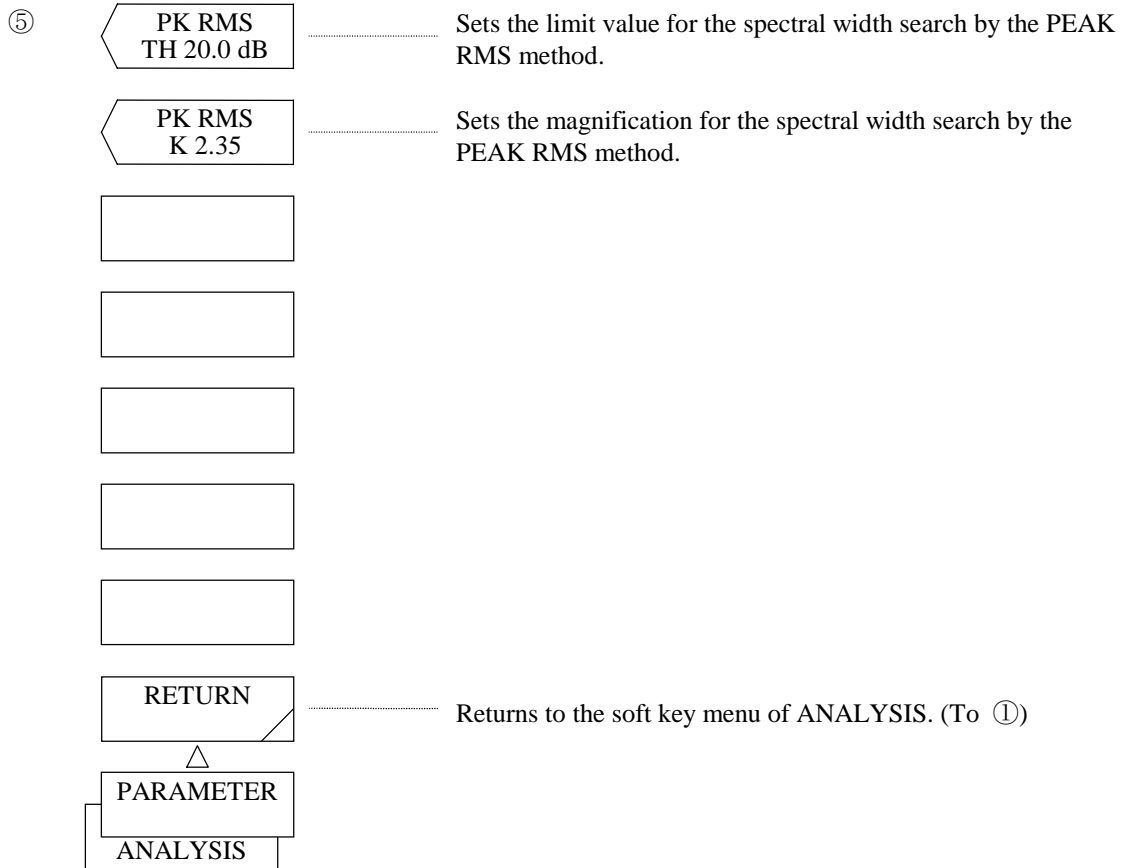

(18) <PK RMS TH> key

Sets the limit value for the spectral width search by the PEAK RMS method.

After execution, the current limit value is displayed in the interrupt display section.

The limit value can be changed in the range of 0.01 to 50.00 dB (0.01 step) by the rotary knob, step keys or ten-key pad.

(19) <PK RMS K> key

Sets the magnification for the spectral width search by the PEAK RMS method.

After execution, the current magnification is displayed in the interrupt display section.

The magnification can be changed in the range of 1.00 to 10.00 (0.01 step) by the rotary knob, step keys or ten-key pad.

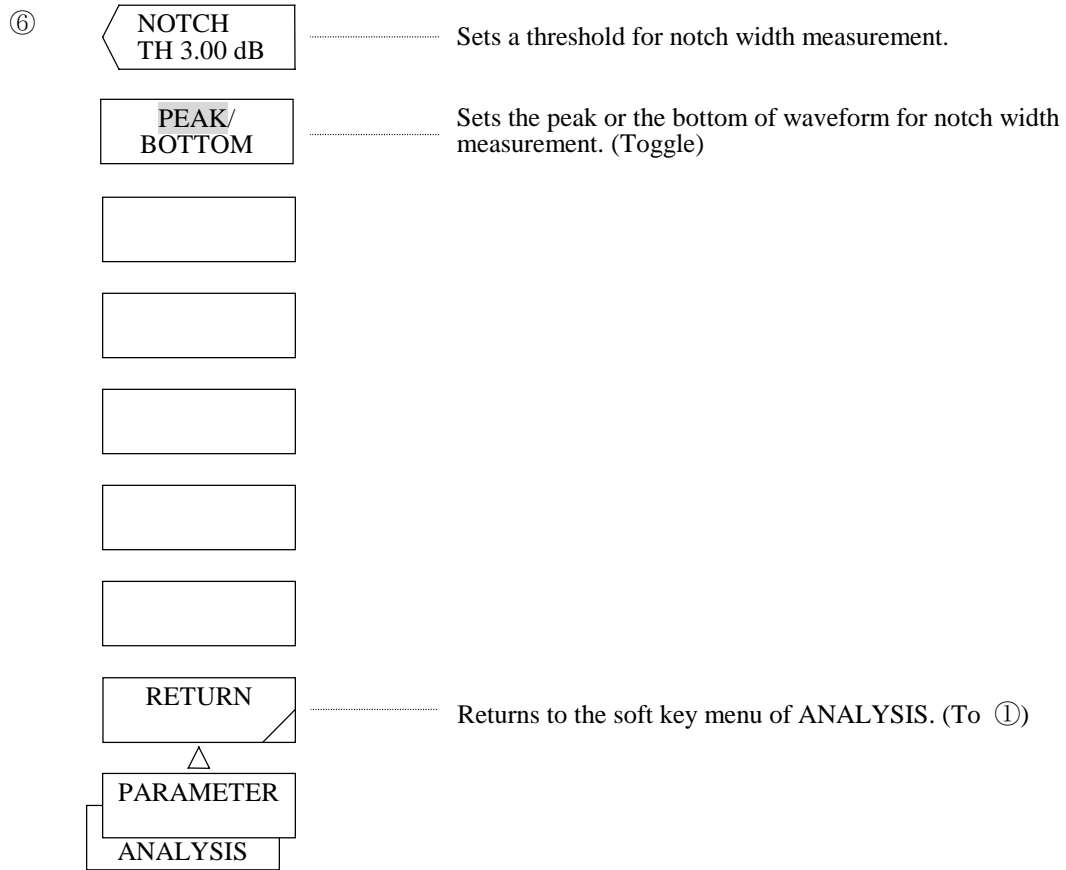

(20) <NOTCH TH> key

Sets a threshold for notch width measurement.

The threshold can be changed within the range of 0.01 to 50.00 dB (at 0.01 step) by the rotary knob, step keys, or numeric keys.

(21) <PEAK/BOTTOM> Key

Set the peak or the bottom of the waveform for notch width search.

Each time this key is pressed, "PEAK" or "BOTTOM" is displayed in reverse alternately.

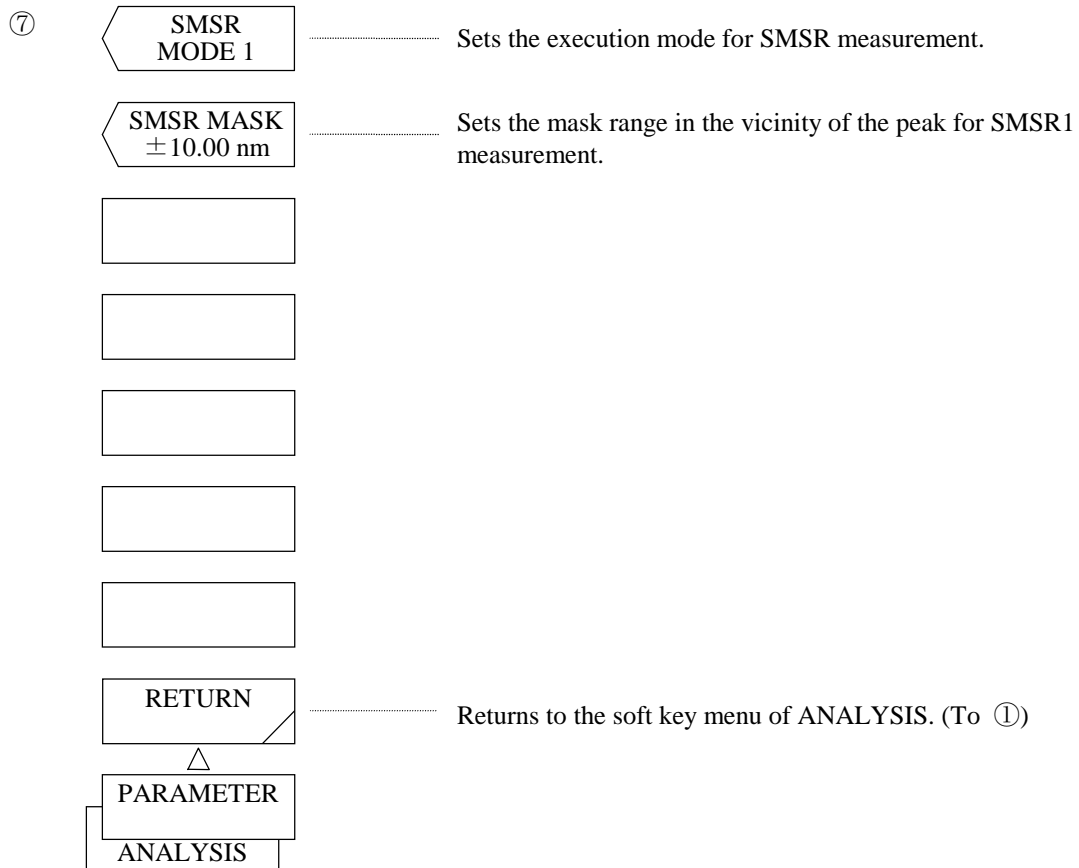

(22) <SMSR MODE> key

Sets the execution mode for SMSR measurement.

After execution, the current execution mode is displayed in the interrupt display section.

The execution mode can be set to 1 or 2 by the rotary knob, step keys or ten-key pad.

The following explains the "SMSR1" and "SMSR2" definition.

(23) <SMSR MASK> key

Sets the mask range in the vicinity of the peak for SMSR1 measurement.

After execution, the current mask range is displayed in the interrupt display section.

The mask range can be changed in the range of 0 to 99.99 nm (0.01 step) by the rotary knob, step keys or ten-key pad.

### Definition of SMSR 1

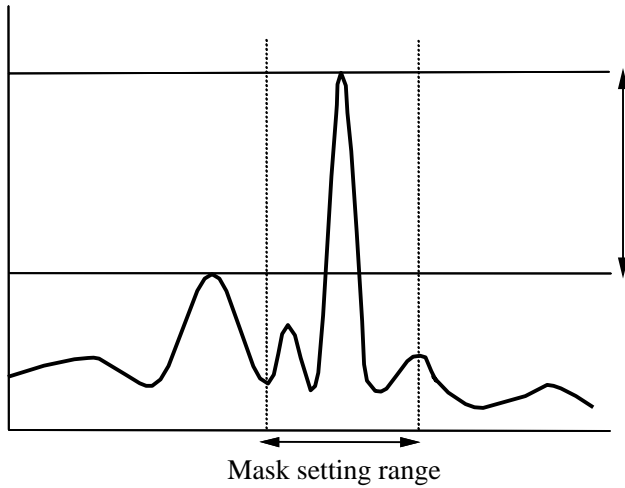

Determines the difference in level between the highest mode peak and the second highest mode peak (except mask setting range).

Level difference

### Definition of SMSR 2

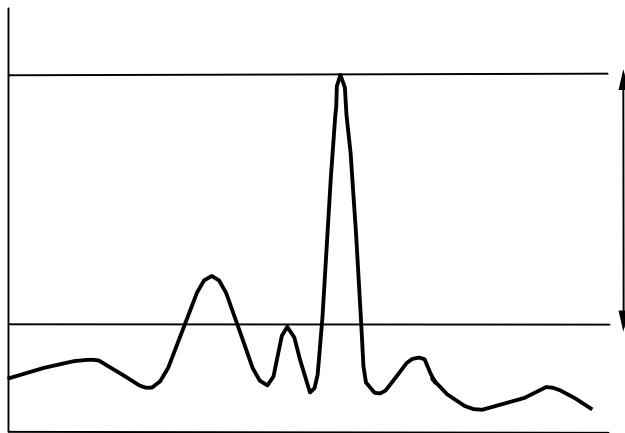

Determines the difference in level between the highest mode peak and adjacent mode peaks whichever higher.

Level difference

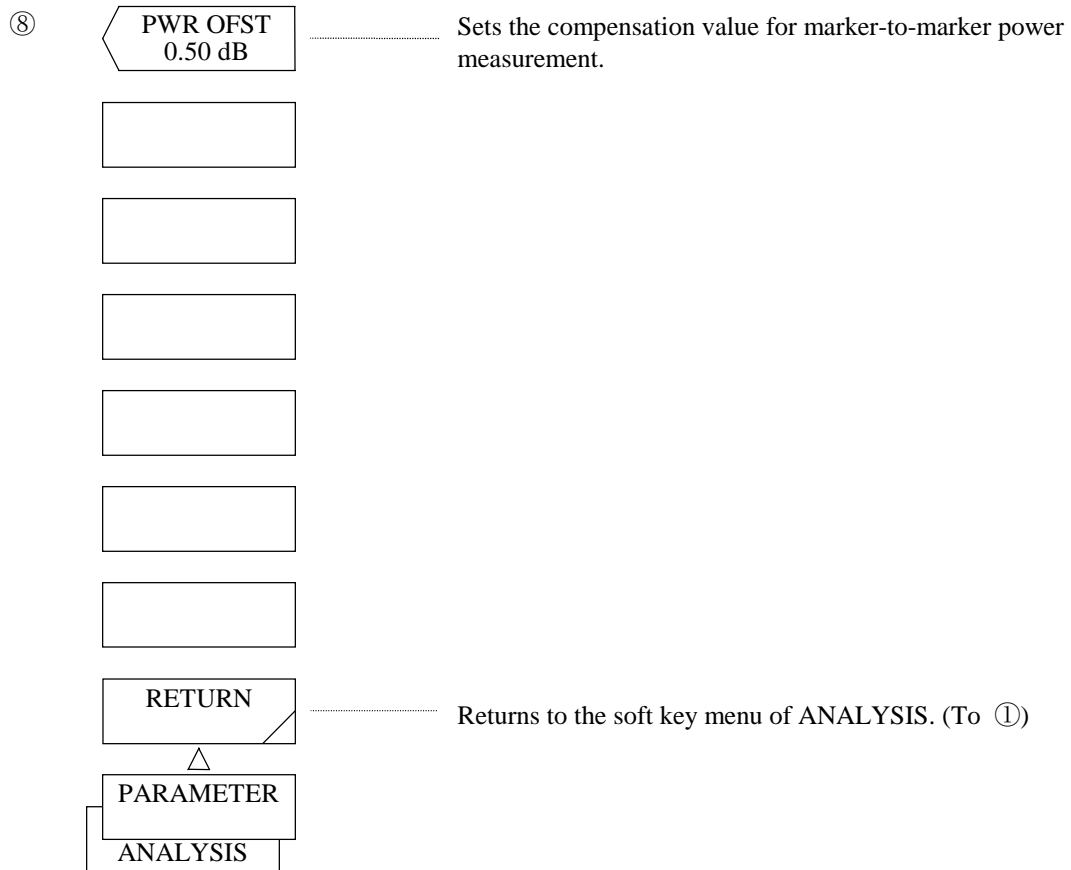

(24) <PWR OFFSET> key

Sets the compensation value for power measurement.

After execution, the current compensation value is displayed in the interrupt display section. The compensation value can be changed in the range of – 10.00 to 10.00 dB (0.01 step) by the rotary knob, step keys or ten-key pad.



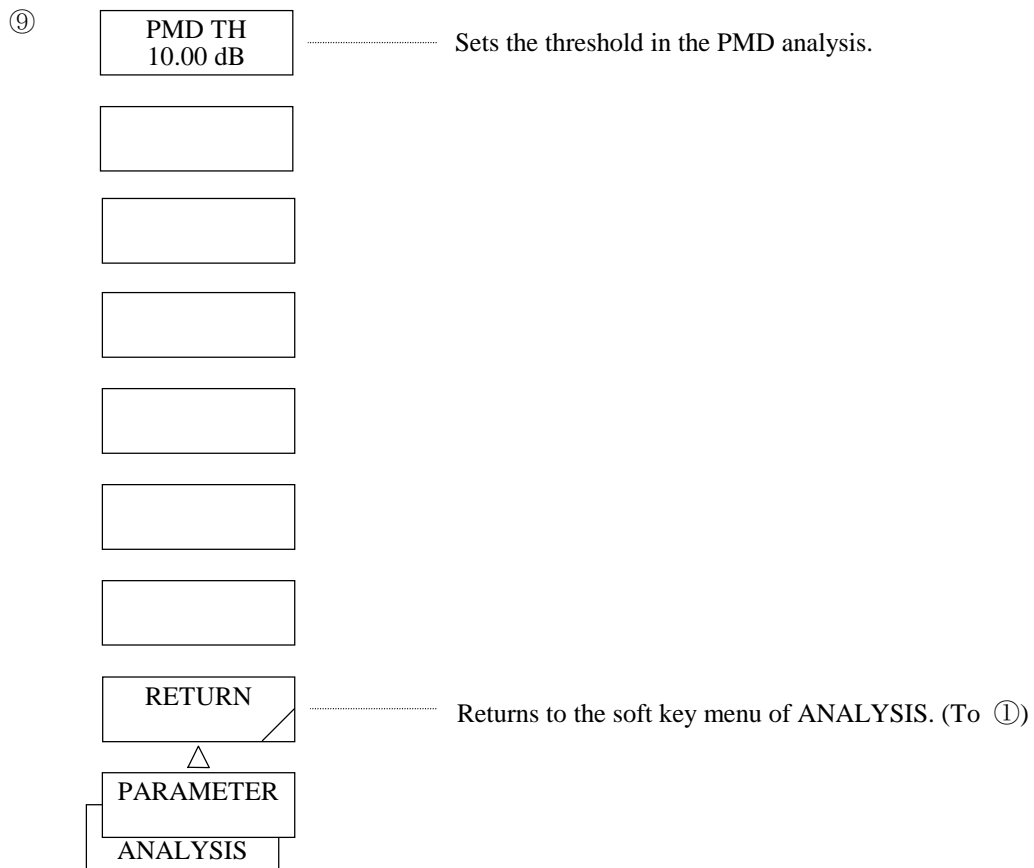

(25) <PMD TH> key

Sets the threshold in the PMD analysis.

After execution, the current threshold value is displayed in the interrupt display section.

The threshold can be varied in the range of 0.01 to 50.00 dB (0.01 step) by using the rotary knob, step keys, or ten-key pad.

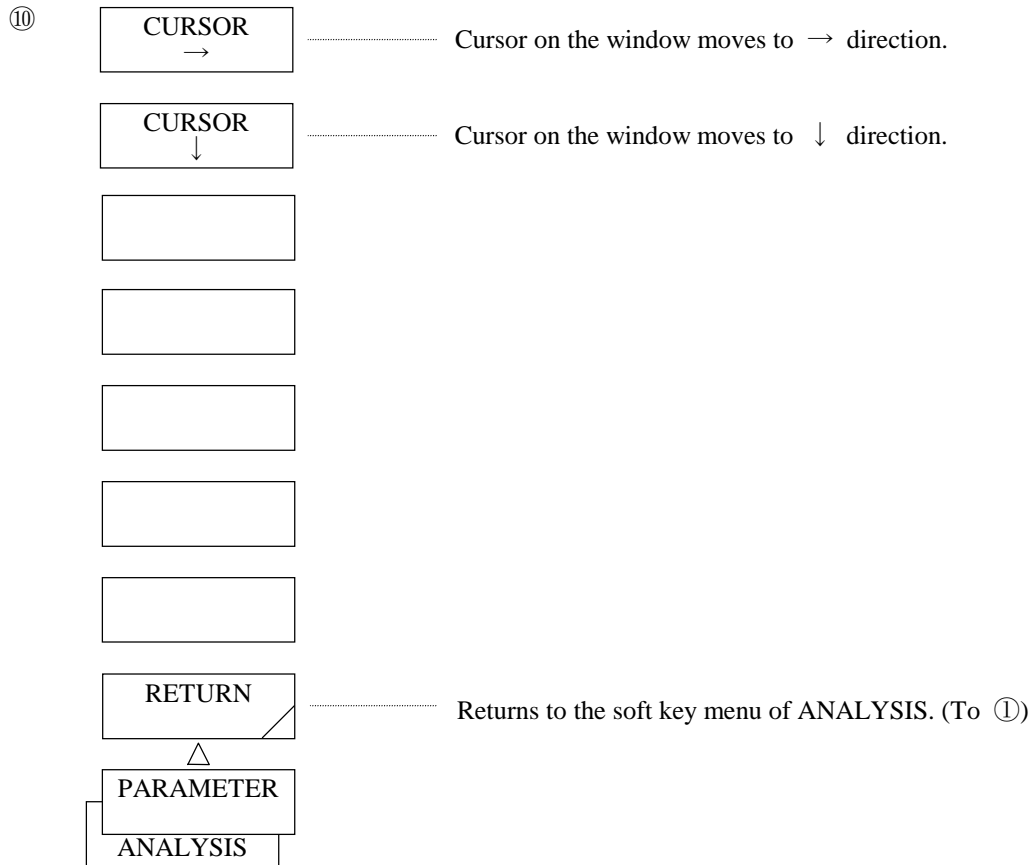

- (26) <PARAMETER (FP-LD)>, <PARAMETER (DFB-LD)>, <PARAMETER (LED)>, <PARAMETER(FIL-PK)>, <PARAMETER(FIL-BTM)> keys

Displays parameter setting window.

When the window is displayed, cursor appears at top of "ALGO". When modifying parameters, move cursor to desired position with <CURSOR →> or <CURSOR ↓> and use the rotary knob, step keys or ten-key for the modification.

Window to be shown varies depending on which of <ANALYSIS1 FP-LD>, <ANALYSIS1 DFB-LD>, <ANALYSIS1 LED>, <ANALYSIS2 FIL-PK> and <ANALYSIS2 FIL-BTM> key is pressed.

Following shows windows corresponding to each key.

- < ANALYSIS1 FP-LD>

ANALYSIS1 FP-LD							
ITEM	ALGO	TH [dB]	TH2 [dB]	K	MODE FIT	MODE DIFF [dB]	OFST LEVEL [dB]
SPEC WIDTH	PK RMS	20.0	–	2.00	–	3.00	–
MEAN WL	PK RMS	20.0	–	2.00	–	3.00	–
TOTAL POWER	POWER	–	–	–	–	–	0.00
MODE NO.	PK RMS	20.0	–	1.00	–	3.00	–

- <ANALYSIS1 DFB-LD>

ANALYSIS1 DFB-LD							
ITEM	ALGO	TH [dB]	TH2 [dB]	K	MODE FIT	MODE DIFF [dB]	SMSR MASK [nm]
– X dB WIDTH	THRESH	20.0	–	1.00	OFF	3.00	–
SMSR	SMSR1	–	–	–	–	3.00	± 0.00

- < ANALYSIS1 LED>

ANALYSIS1 LED							
ITEM	ALGO	TH [dB]	TH2 [dB]	K	MODE FIT	MODE DIFF [dB]	OFST LEVEL [dB]
SPEC WIDTH	THRESH	3.0	–	1.00	OFF	3.00	–
MEAN WL	RMS	20.0	–	2.00	–	–	–
TOTAL POWER	POWER	–	–	–	–	–	0.00

- ◆ SPEC WIDTH (Spectral width)  
Specifies algorithm to be used in spectral measurement and also sets its parameters. (\*)
- ◆ MEAN WL (Center wavelength)  
Specifies what algorithm is to be used in the spectral width measurement.  $\lambda_c$  obtained in that measurement is used as center wavelength. It also sets up parameter for the algorithm. (\*)
- ◆ TOTAL POWER (Total power)  
Calculates the power measurement value just as done by <POWER> key. Here only correction values for power measurement is set because of parameters of <OFST LEVEL>. Refer to before mentioned (23) <PWR OFST> key for parameter setting.
- ◆ MODE NO. (Number of mode)  
Specifies algorithm is to be used in the spectral width measurement and also sets its parameters. "MODE" obtained in that measurement is used as number of mode. (\*)
- ◆ – X dB WIDTH (Band width)  
Specifies algorithm to be used in the spectral width measurement and also sets its parameters.  $\Delta\lambda$  (spectral width) obtained in that measurement is used as band width. (\*)
- ◆ SMSR (Side mode suppression ratio)  
Calculates side mode suppression ratio just as done by <SMSR> key. Specifies algorithm to be used and sets up its parameter.  
Refer to above mentioned (2)-1 for definition of algorithm and (22) and 5.1.7 (10) for parameter setting.

(\*) Following 4 types of algorithm are available for the spectrum width measurement.

- ENV (Envelope method)
- THRESH (Threshold method)
- RMS (RMS method)
- PK RMS (Peak RMS method)

Refer to Section 5.4 for definition of algorithm and above mentioned (9) through (19) and 5.1.7 (10) for parameter setting.

• < ANALYSIS2 FIL-PK >

FILTER (PEAK) ANALYSIS								
ITEM		ALGO	TH [dB]	K	MODE FIT	MODE DIFF [dB]	CH SPACE [nm]	SEARCH AREA [nm]
PEAK LVL	ON	PK LVL	—	—	—	—	—	—
PEAK WL	ON	PK WL	—	—	—	—	—	—
MEAN WL	ON	THRESH	3.00	1.00	OFF	3.00	—	—
SPEC WD	ON	THRESH	3.00	1.00	OFF	3.00	—	—
CRS TALK	ON	THRESH	3.00	1.00	OFF	3.00	±0.40	—
RIPPLE WD	ON	THRESH	3.00	—	—	0.50	—	—

• < ANALYSIS2 FIL-BTM >

FILTER (BOTTOM) ANALYSIS						
ITEM		ALGO	TH [dB]	MODE DIFF [dB]	CH SPACE [nm]	SEARCH AREA [nm]
BTM LVL	ON	BTM LVL	—	—	—	—
BTM WL	ON	BTM WL	—	—	—	—
MEAN WL	ON	BOTTOM	3.00	3.00	—	—
NOTCH WD	ON	BOTTOM	3.00	3.00	—	—
CRS TALK	ON	BOTTOM	3.00	1.00	±0.40	—

- ◆ PEAK LVL (Peak level)
- ◆ BTM LVL (Bottom level)
- ◆ PEAK WL (Peak wavelength)
- ◆ BTM WL (Bottom wavelength)
- ◆ MEAN WL (Center wavelength) ----- Specifies any algorithm for the calculation and sets the parameter in order to make  $\lambda_c$  calculated from the spectral band width the center wavelength.
- ◆ SPEC WD (Spectral band width) ----- Specifies an algorithm and set the parameter for measurement of spectral band width.
- ◆ NOTCH WD (Notch width) ----- Specifies an algorithm and set the parameter for measurement of notch width.
- ◆ CRS TALK (Cross talk)----- Specifies an algorithm and set the parameter for measurement of cross talk.
- ◆ RIPPLE WD (Ripple width)----- Specifies an algorithm and set the parameter for measurement of ripple width.

(27) <CURSOR →> key

Moves cursor shown in window to → direction.

Hold this key down to return it to its original position.

“ ALGO” → “ TH1” → “ TH2” →“ K” →“ MODE FIT” →“ MODE DIFF” →“ OFST LEVEL”



(28) <CURSOR ↓> key

Moves cursor shown in window to ↓ direction.

Hold this key down to return it to its original position.

(Example)

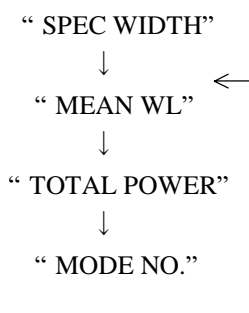

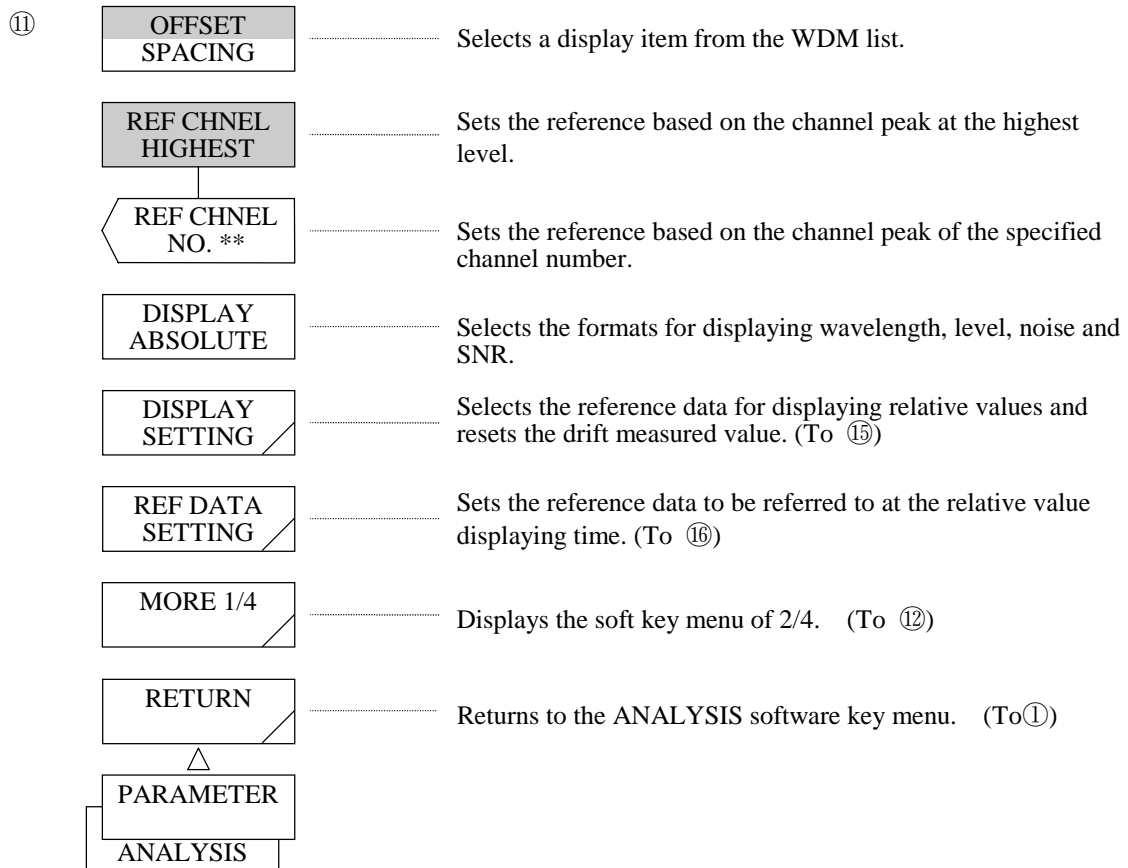

(29) <OFFSET SPACING> key

Selects a display item from the WDM list.

OFFSET : Displays an offset based on any single channel.

SPACING : Displays an offset from the adjacent channel.

(30) <REF CHNEL HIGHEST> key

Sets the reference at the highest channel peak of OFFSET WL and OFST LVL displayed on the WDM list. This key is valid only when the OFFSET of Item (28) has been selected.

(31) <REF CHNEL NO.\*\*> key

Sets the reference at the "\*\*\*"-th channel peak of OFFSET WL and OFST LVL displayed on the WDM list. The allowable setting range is 1 to 200 (at 1 step) using the rotary knob, step keys, or numeric keys. This key is valid only when the OFFSET of Item (33) has been selected.

(32) <DISPLAY \*\*\*\*\*> Key

Sets formats for displaying the wavelength, the level, the noise and the SNR as the result of the WDM analysis. The display format has the following four types:

- ① ABSOLUTE --Displays absolute values of analysis results.
- ② RELATIVE ---Displays relative values for reference data (REF DATA).
- ③ ABS & REL --Displays absolute values of analysis results and relative values for reference data (REF DATA).
- ④ DRIFT -----Displays the MAX/MIN of relative values for reference data (REF DATA).

Parameters : ABSOLUTE, RELATIVE, ABS & REL and DRIFT

(33) <DISPLAY SETTING> Key  
 Selects reference data (REF DATA) for displaying relative values and resets drift measured values.  
 When this key is pressed, the soft key menu of ⑦ is displayed.

(34) <REF DATA SETTING> Key  
 Sets reference data (REF DATA) at the relative value displaying time.  
 When this key is pressed, the soft key menu of ⑧ is displayed.

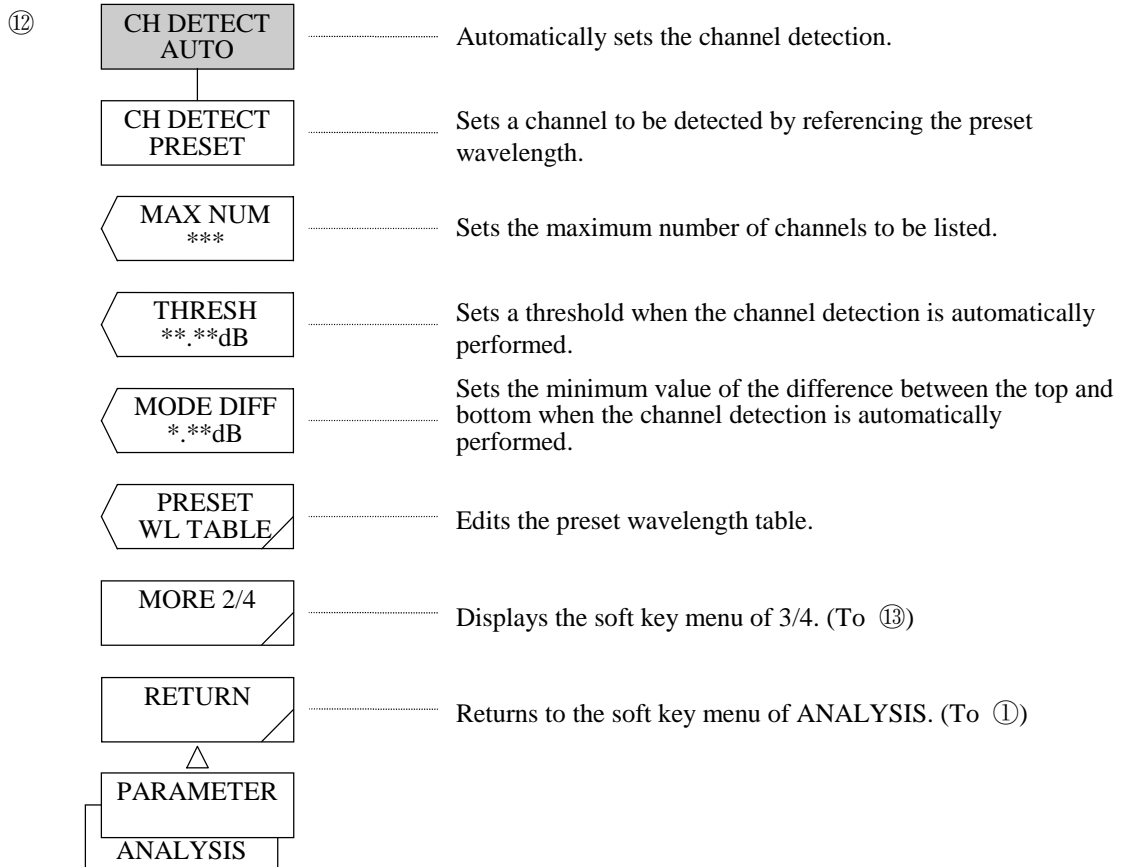

(35) <CH DETECT AUTO> key  
 Sets a channel to be detected automatically.

(36) <CHANNEL DETECT PRESET> key  
 Sets a channel to be detected by referencing the preset wavelength.

(37) <MAX NUM\*\*\*> key  
 Sets the maximum number of channel peaks to be listed.  
 The setting range can be varied in the range of 1 to 200 (1 step) by using the rotary knob, step keys, or ten-key pad.

(38) <THRESH \*\*.\*\*\*dB> key  
 Sets a threshold when the channel peak is obtained.  
 The setting range can be varied in the range of 0.1 to 50.0 dB (0.1 step) by using the rotary knob, step keys, or ten-key pad.

(39) <MODE DIFF \*\*. \*dB> key

Sets the minimum value of the difference between the top and bottom when the channel peak is detected.  
The setting range can be varied in the range of 0.1 to 50.0 dB (0.1 step) by using the rotary knob, step keys, or ten-key pad.

(40) <PRESET WL TABLE> key

Edits the preset wavelength table.  
When this key is pressed, the soft key menu of ⑰ is displayed.

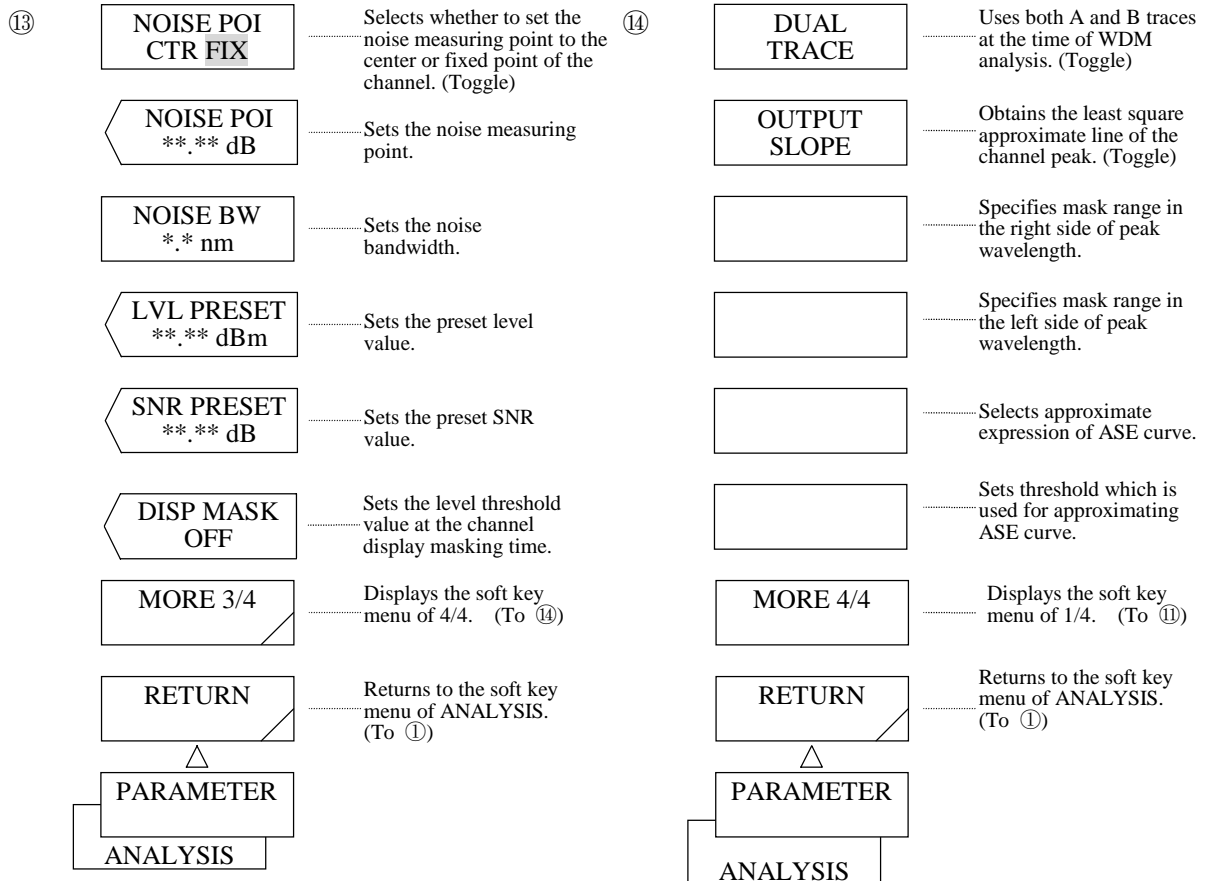

(41) <NOISE POI CTR FIX> key

Selects the noise measuring point.  
CTR : Set at the center of the channel.  
FIX : Set at the fixed point. (Sets a parameter using the <NOISE POI \*\*. \*\*nm> key.)

(42) <NOISE POI \*\*. \*\*nm> key

Sets the noise measuring point.  
After execution, the current noise measuring point is displayed in the interrupt display section.  
The noise measuring point can be varied in the range of 0.00 to 10.00 nm (0.01 step) by using the rotary knob, step keys, or ten-key pad. It becomes valid only when the FIX of (40) is selected.



- (43) <NOISE BW \*. \*\*nm> key  
Sets the noise bandwidth.  
After execution, the current noise measuring point is displayed in the interrupt display section.  
The noise bandwidth can be varied in the range of 0.01 to 1.00 nm (0.01 step) by using the rotary knob, step keys, or ten-key pad.
- (44) <LEV PRESET\*\*, \*\*dBm> key  
Sets the preset level value.  
After execution, the current preset level value is displayed in the interrupt display section.  
The preset level value can be varied in the range of -90.00 to 20.00 dBm (0.01 step) by using the rotary knob, step keys, or ten-key pad.
- (45) <SNR PRESET\*\*, \*\*dB> key  
Sets the preset SNR value.  
After execution, the current preset level value is displayed in the interrupt display section.  
The preset SNR value can be varied in the range of 0.00 to 50.00 dB (0.01 step) by using the rotary knob, step keys, or ten-key pad.
- (46) <DISP MASK \*\*\*> Key  
Sets the level threshold value at the channel display masking time.  
This key is effective only when <CH DETECT PRESET> is selected.  
The mask value can be changed to OFF and the range from 0 to -100 dBm (1 step).
- (47) <DUAL TRACE> Key  
Calculate the wavelength and the level from the waveform of Trace A and the noise level from the waveform of Trace B irrespective of the active trace status.  
When this key is pressed, the reverse display appears and is turned on and off.
- (48) <OUTPUT SLOPE> Key  
Obtains the least square approximate line for each channel peak obtained from the WDM analysis and displays the least square approximate line and its slope (dB/nm or dB/THz) together.  
When this key is pressed, the reverse display appears and is turned on and off.

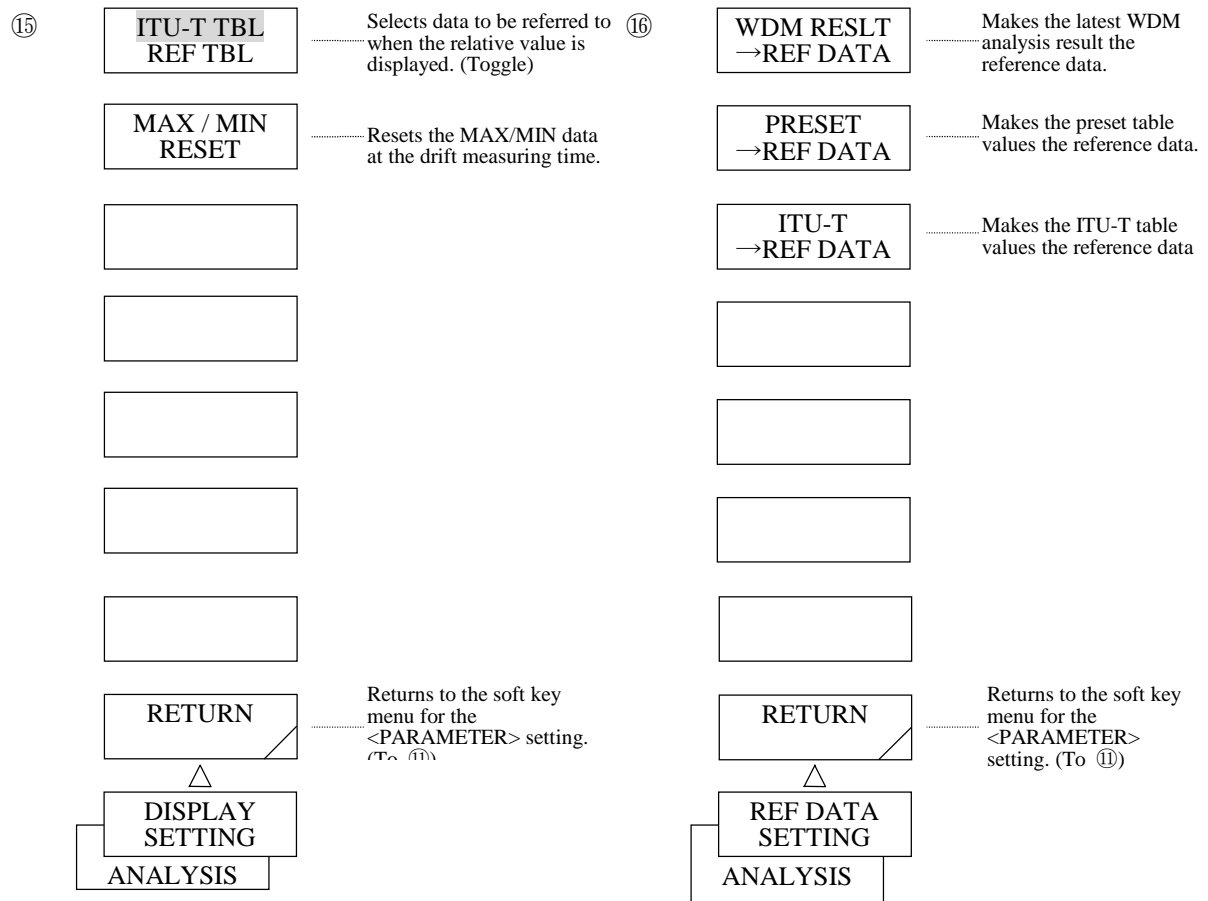

(49) <ITU-T TBL REF TBL> Key

Selects data to be referred to when the relative value is displayed.

ITU-T TBL : Makes the ITI-T TABLE wavelength values the reference data.

For the level, values on the <LVL PRESET> key become the reference data, and for the SNR, values on the <SNR PRESET> key become the reference data.

REF TBL : The reference table set with the <REF DATA SETTING> key of (9) becomes the reference data.

(50) <MAX/MIN RESET> Key

Resets the MAX/MIN value to be displayed at the drift measuring time (when the <DISPLAY DRIFT> key is selected) to 0.

(51) <WDM RESULT→REF DATA> Key

Makes the latest WDM analysis result the reference data.

(52) <PRESET→REF DATA> Key

Makes the preset value the reference data.

The preset value is set with the <PRESET WL TABLE>, <LEVEL PRESET> or <SNR PRESET> key.

(53) <ITU-T→REF DATA> Key

Makes ITU-T TABLE values the reference data.

For the level, the value of the <LVL PRESET> key becomes the reference data, and for SNR, the value of the <SNR PRESET> key becomes the reference data.

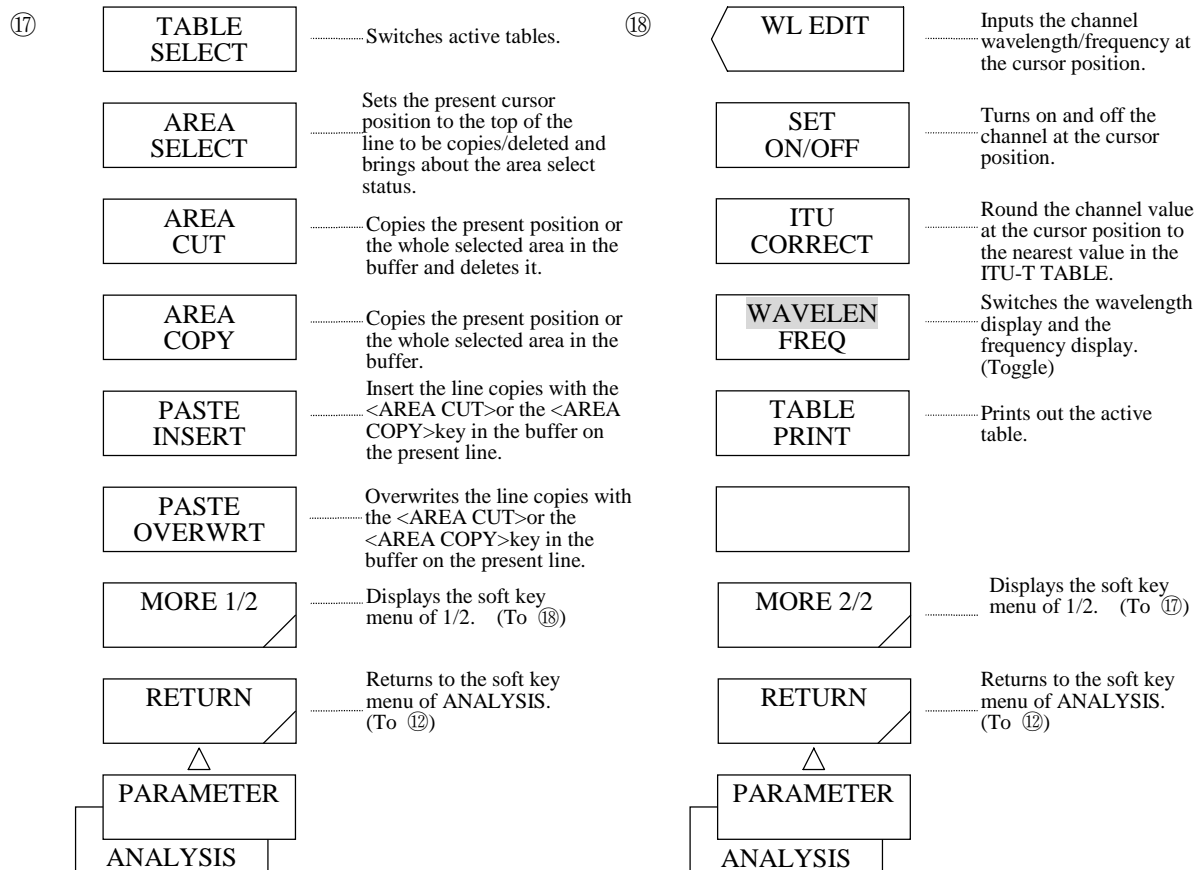

(54) <TABLE SELECT> Key

Switches active tables. Active tables have thick outer frames when displayed.

(55) <AREA SELECT> Key

Sets the present cursor position to the top of the area for controlling plural data at a time and brings about the area select status. When this key is pressed in the area select status, the area select status is released.

(56) <AREA CUT> Key

Copies the data at the present cursor position or the data in the area selected with the <AREA SELECT> key in the buffer and deletes it.

(57) <AREA COPY> Key

Copies the data at the present cursor position or the data in the area selected with the <AREA SELECT> key in the buffer.

(58) <PASTE INSERT> Key

Inserts the data copied with the <AREA CUT> or the <AREA COPY> key in the buffer to the present cursor position. When the number of data exceeded 200ch after the insertion, no more data can be inserted.

- (59) <PAST OVER WRT> Key  
Overwrites the data copies with the <AREA CUT> or <AREA COPY> key in the buffer from the present cursor position.
- (60) <WL EDIT> Key  
Inputs the channel wavelength/frequency at the cursor position.
- (61) <SET ON/OFF> Key  
Turns on and off the channel at the cursor position.  
The channel, which has been turned off at the channel detecting time, cannot be used.
- (62) <ITU CORRECT> Key  
Round the channel value at the cursor position to the nearest value in the ITU-T TABLE.
- (63) <WAVELEN FREQ> Key  
Switches the data display on the table to the wavelength display and to the frequency display.
- (64) <TABLE PRINT> Key  
Prints out the active table.

The List displayed by <WDM> key

<WDM ANALYSIS>		REF CHANNEL:HIGHEST				
THRESH: 20.0 dB		MAX NUMBER: 20		MODE DIFF: 3.0 dB		
NO.	WAVELENGTH [nm]	LEVEL [dBm]	OFFSET WL [nm]	OFST LVL [dB]	NOISE(/nm) [dBm]	SNR [dB]
01	1550.000	- 12.34	- 1.000	- 2.34	- 40.00	27.66
02	1551.000	- 10.00	(REF)	(REF)	- 35.00	25.00
03	1552.500	- 15.00	1.500	- 5.00	- 30.00	15.00
04	1553.000	- 20.00	2.500	- 10.00	- 32.00	12.00

If the list exceeds a single screen page, it can be scrolled up or down by the rotary knob or step keys.

#### Explanation

- WAVELENGTH (\*1) : Wavelength of each channel peak  
 LEVEL : Signal level of each channel peak  
 OFFSET WL (\*2) : Wavelength difference from the reference channel peak  
 OFST LVL (\*2) : Level difference from the reference channel peak  
 NOISE (/nm) : Noise level at channel peak (The calculation method will be determined separately.)  
 SNR : Difference between the channel peak level and noise level

(\*1) Displayed in frequency if the marker is in the frequency length display mode.

(\*2) Displayed in SPACING and LVL DIFF modes if the SPACING has been selected.

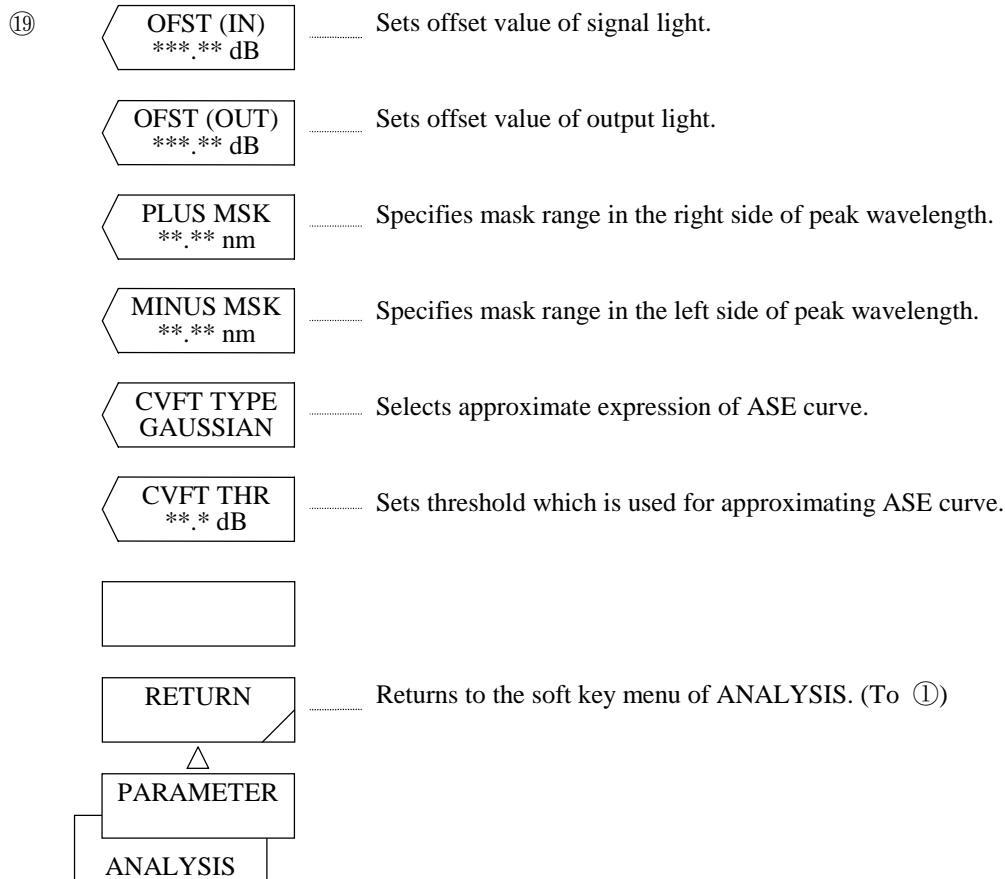

(65) <OFST (IN) \*\*\*.\*\* dB> key

Press <EDFA NF> key for setting offset value of signal light (light which is entered to optical fiber amplifier) which is used in calculation of NF and gain.

When this key is executed, current offset value will be shown in the interrupt display section.

Offset value can be varied in the range of – 99.99 to +99.99 dB (0.01 step) by use of the rotary knob, step keys or ten-key.

(66) <OFST (OUT) \*\*\*.\*\*dB> key

Press <EDFA NF> key for setting offset value of output light (light being amplified through optical amplifier) which is used in calculation of NF and gain.

When this key is executed, current offset value will be shown in the interrupt display section.

Offset value can be varied in the range of – 99.99 to +99.99 dB (0.01 step) by use of the rotary knob, step keys or ten-key.

(67) <PLUS MSK \*\*.\*\*nm> key

Specifies mask range on the right of peak wavelength when masking is done to signal light for calculating NF.

When this key is executed, current mask value will be shown in the interrupt display section.

Mask range can be varied in the range of 0 to 10.00 nm (0.01 step) by use of the rotary knob, step keys or ten-key.

(68) <MINUS MSK \*\*.\*\*\*nm> key

Specifies mask range on the left side of peak wavelength when masking is done to signal light for calculating NF.

When this key is executed, current mask value will be shown in the interrupt display section.

Offset value can be varied in the range of 0 to 10.00 nm (0.01 step) by use of the rotary knob, step keys or ten-key.

(69) <CVFT TYPE> key

Selects type of curve fit (approximation expression) for calculating NF.

If this key is executed, current setting will be shown in the interrupt display section.

Type of curve fit can be changed by use of the rotary knob or step keys.

Following 5 types of curve fits are available:

- ◆ GAUSSIAN (Normal distribution curve)
- ◆ LORENZIAN (Lorenz curve)
- ◆ 3RD POLY (Cubic expression)
- ◆ 4TH POLY (Biquadratic expression)
- ◆ 5TH POLY (Pentagonal expression)

(70) <CVFT THR \*\*.\*\*\*dB> key

In calculation of NF, this key sets a threshold for the curve fit.

When this key is executed, the current mask value is displayed in the interrupt display section. The threshold can be varied in the range of 0.1 to 99.9 dB (0.1 step) by using the rotary knob, step keys, or ten key pad.

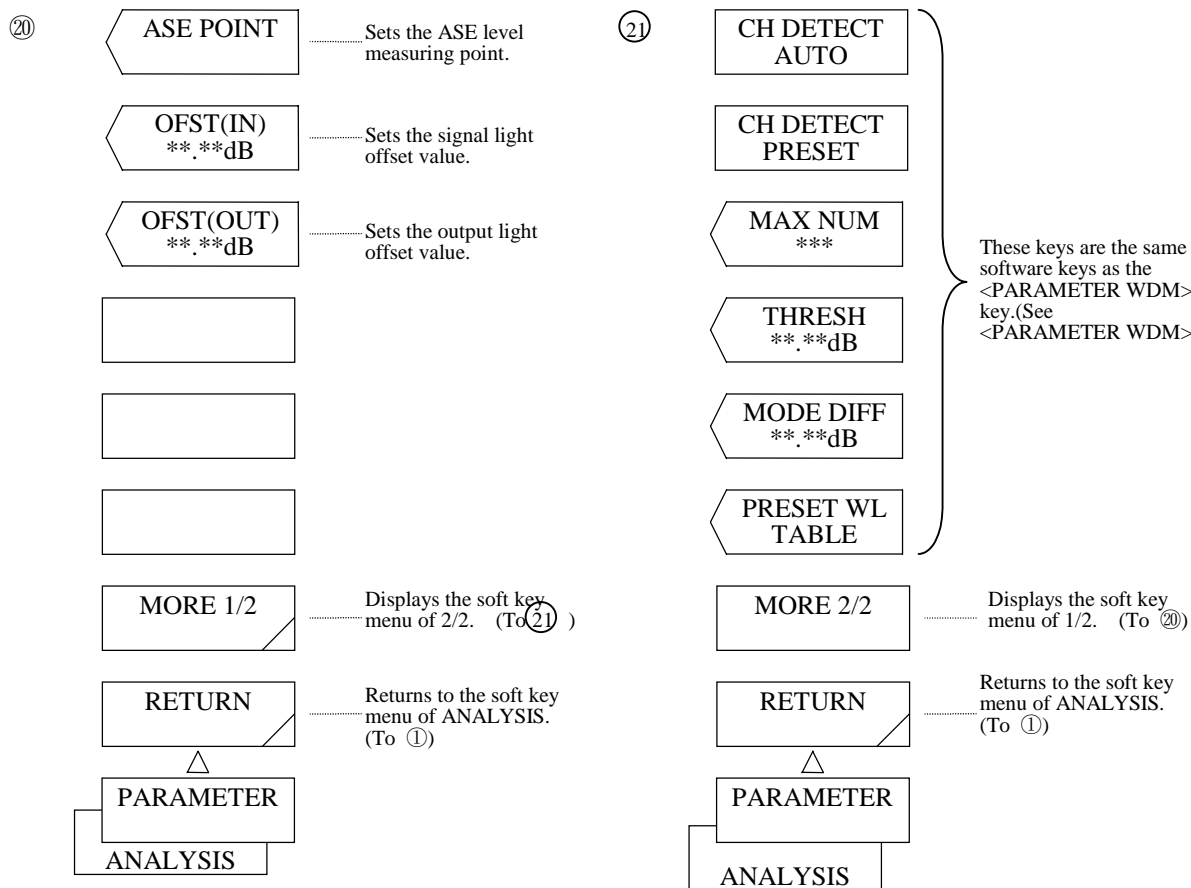

(71) <ASE POINT ±\*\*, \*\*nm> Key

Sets the ASE level measuring point.

After the execution, the present ASE level measuring point is displayed in the interrupt display area.

The ASE level measuring point can be changed in the range from 0.00 to 10.00 nm (0.1 step) with the rotary knob, the step key or the ten-key pad.

(72) <OFST (IN) \*\*, \*\*dB> Key

Sets the offset value of the signal light (light that is input to the optical fiber amplifier) at the NF and Gain calculating times.

After the key is executed, the present offset value is displayed in the interrupt display area.

The offset value can be changed in the range from -99.99 to +99.99 dB (0.01 step) with the rotary knob, the step key or the ten-key pad.

(73) <OFST (OUT) \*\*, \*\*dB> Key

Sets the offset value of the output light (light amplified with the optical fiber amplifier) at the NF and Gain calculating times.

After the key is executed, the present offset value is displayed in the interrupt display area.

The offset value can be changed in the range from -99.99 to +99.99 dB (0.01 step) with the rotary knob, the step key or the ten-key pad.

- (74) <CH DETECT AUTO> Key
  - (75) <CH DETECT PRESET> Key
  - (76) <MAX NUM \*\*\*> Key
  - (77) <THRESH \*\*.\*dB> Key
  - (78) <MODE DIFF \*\*.\*dB> Key
  - (79) <PREEST WL TABLE> Key
- } These keys are the same as the software keys of <PARAMETER WDM>.

The List to be displayed with the <WDM-NF> Key

<WDM NF>		ASE: ±0.40 nm	0FST(IN): 0.00 dB	0FST(OUT): 0.00 dB			
CH: AUTO		MAX NUM: 20	THRESH: 20.00 dB	MODE DIFF: 3.00 dB			
NO.	WAVELENGTH [nm]	INPUT LEV [dBm]	OUTPUT LEV [dBm]	ASE LEV [dBm]	RESOLN [nm]	GAIN [dB]	NF [dB]
01	1547.464	- 19.94	- 2.44	- 33.28	0.145	17.49	5.58
02	1549.076	- 19.93	- 2.19	- 33.01	0.158	17.73	5.25
03	1550.679	- 19.94	- 1.92	- 32.65	0.148	18.02	5.62
04	1552.268	- 19.98	- 1.70	- 32.45	0.146	18.28	5.63

The list can be scrolled with the rotary knob or the step key when larger than a screen.

Explanation of Each Item

- WAVELENGTH (Note 1): Peak wavelength of each channel (to be obtained from Trace A).
- INPUT LEV : Level before amplification of each channel (to be obtained from Trace A).
- OUTPUT LBE : Level after amplification of each channel (to be obtained from Trace B).
- ASE LEV : ASE level of each channel
- RESOLN : Measurement resolution of each channel (to be obtained from Trace B)
- GAIN : Gain of each channel
- NF : NF value of each channel

Note 1 : Frequency is displayed when the marker is in the frequency length display mode.



### 5.1.11 [TRACE] switch

When this switch is pressed, the soft key menu (①, ② or ③) corresponding to the selected active trace (A, B or C) is displayed.

For the trace A

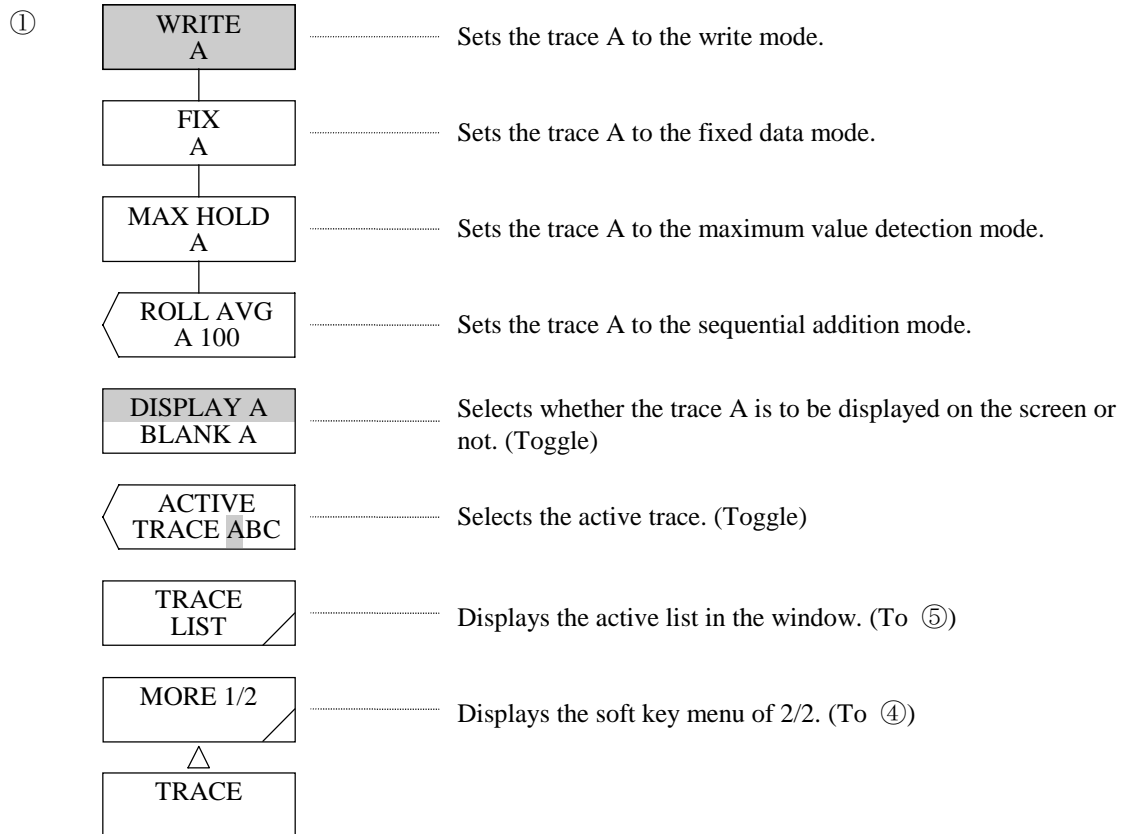

For the trace B

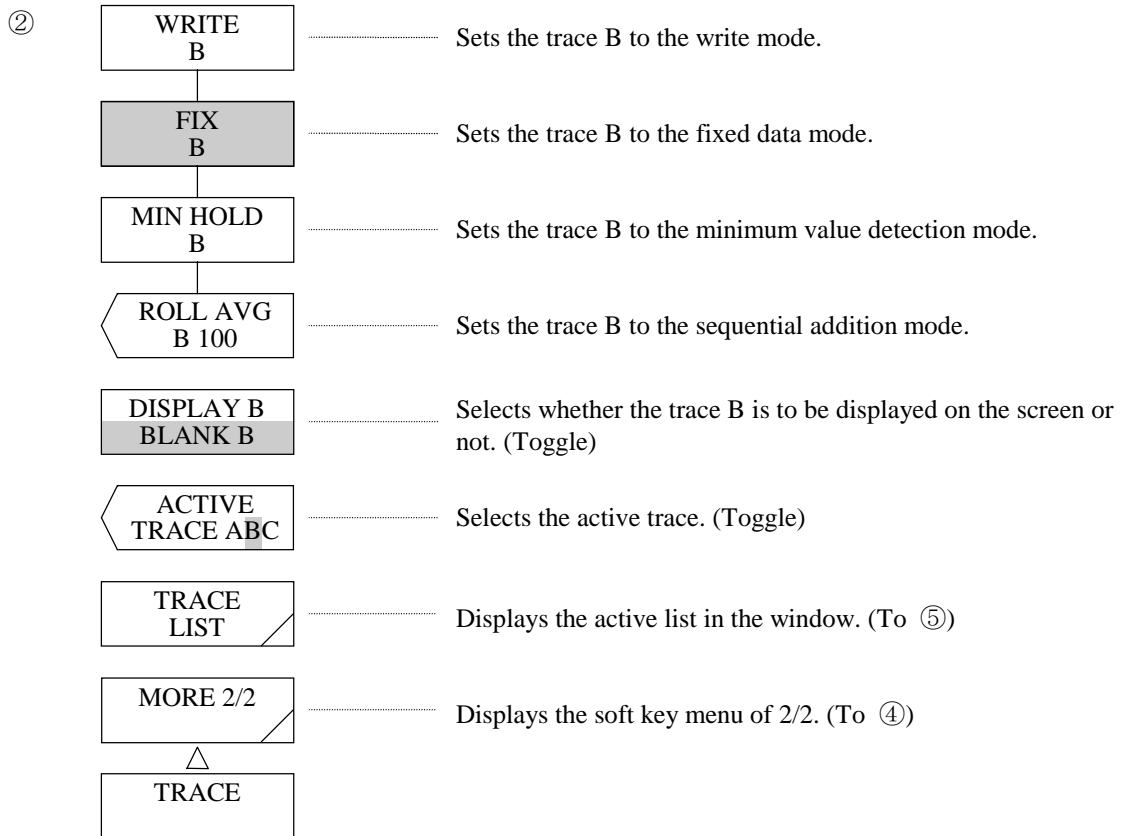

(1) <WRITE A> key

Sets the trace A to the write mode.

In this mode, the measured data is used as trace-A data as it is and displayed on the screen.

The trace display by the side of the data area becomes "WRITE".

(2) <FIX A> key

Sets the trace A to the fixed data mode.

In this mode, the data of the trace A is not changed after measurement, so that the waveforms on the screen remain without change.

The trace display by the side of the data area becomes "FIX".

When the <FIX A> key is pressed during a sweep, the waveform displayed at that time is fixed as it is.

All of the trace A, B and C become "FIX, the <STOP> key is displayed in reverse video, and the sweep stops. Then, WARNING is displayed.

(3) <MAX HOLD A> key

Sets the trace A to the maximum value detection mode.

In this mode, the maximum value at each measurement point is detected at each measurement and written into the trace A.

The detection of the maximum value is not affected by the set value of NOISE MASK.

NOISE MASK is executed when the result of maximum value detection is displayed.

The trace display by the side of the data area becomes "MAX HLD".

(4) <ROLL AVG A> key

Sets the trace A to the sequential addition mode.

In this mode, sequential averaging is performed at each measurement point at each measurement and its result is written into the trace A.

After execution, the current number of averaging times is displayed in the interrupt display section.

The number of averaging times can be changed in the range of 2 to 100 (1 step) by the rotary knob, step keys or ten-key pad.

Sequential averaging is not affected by the set value of NOISE MASK.

NOISE MASK is executed when the result of sequential averaging is displayed.

The trace display by the side of the data area becomes "ROL AVG".

Averaging is performed by the following expression.

$$W_j(i) = W_{j-1}(i) \cdot \frac{n-1}{n} + W(i) \cdot \frac{1}{n} \quad (i=1, 2, \dots, N)$$

$W_j(i)$  : New displayed waveform

$W_{j-1}(i)$  : Existing displayed waveform

$W(i)$  : New obtained waveform

$N$  : Number of samples

$n$  : Number of averaging times

(5) <DISPLAY A BLANK A> key

Selects whether the trace A is to be displayed on the screen or not.

When this key is pressed, the "DISPLAY A" is replaced with the "BLANK A".

In the "DISPLAY A" status, a waveform is displayed.

At this time, the trace display by the side of the data area becomes "DSP".

In the "BLANK A" status, no waveform is displayed on the screen. At this time, the trace display by the side of the data area becomes "BLK" and the marker and marker value disappear.

(6) <ACTIVE TRACE ABC> key

Selects the active trace.

Each time this key is pressed, the active trace latch is switched in rotation in the order of A, B, C and A.

- (7) <TRACE LIST> key  
 Opens the window and displays the measuring condition list for the trace A, trace B and trace C.

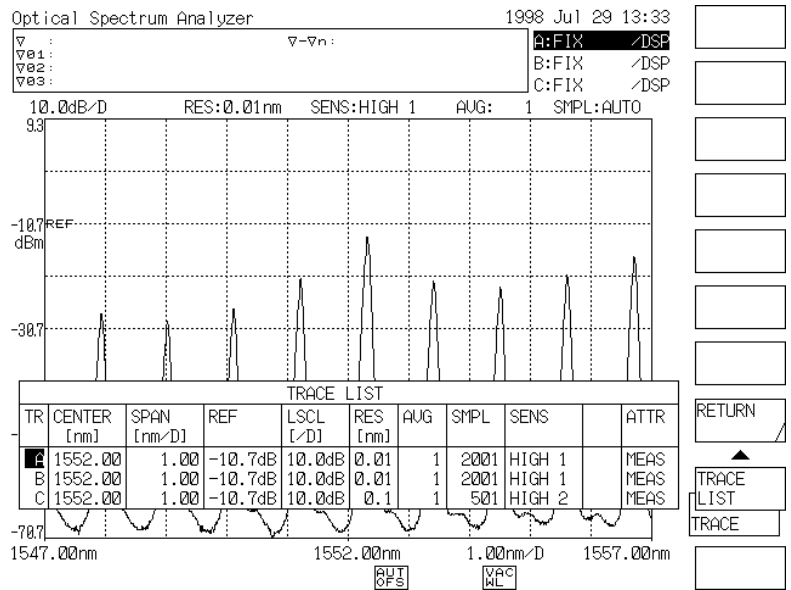

Trace List Display Screen

- (8) <WRITE B> key  
 Sets the trace B to the write mode.  
 In this mode, the measured data is used as trace-B data as it is and displayed on the screen.  
 The trace display by the side of the data area becomes "WRITE".

(9) <FIX B> key

Sets the trace B to the fixed data mode.

In this mode, the data of the trace B is not changed by measurement, so that the waveforms on the screen are not changed.

The trace display by the side of the data area becomes "FIX".

When the <FIX B> key is pressed during a sweep, the waveforms displayed at that time are fixed as they are. When all of the trace A, trace B and trace C become FIX, the <STOP> key is displayed in reverse video and the sweep stops.

Then, WARNING is displayed.

(10) <MIN HOLD B> key

Sets the trace B to the minimum value detection mode.

In this mode, the minimum value at each measurement point is detected at each measurement and written into the trace B.

The detection of the minimum value is not affected by the set value in NOISE MASK. NOISE MASK is executed when the result of minimum value detection is displayed.

The trace display by the side of the data area becomes "MIN HLD".

(11) <ROLL AVG B> key

Sets the trace B to the sequential addition mode.

In this mode, sequential averaging is performed at each measurement point at each measurement and written into the trace B.

After execution, the current number of averaging times is displayed in the interrupt display section.

The number of averaging times can be changed in the range of 2 to 100 (1 step) by the rotary knob, step keys or ten-key pad.

Sequential averaging is not affected by the set value of NOISE MASK.

NOISE MASK is executed when the result of sequential averaging is displayed.

The trace display by the side of the data area becomes "ROL AVG". Averaging is performed by the following expression.

$$W_j(i) = W_{j-1}(i) \cdot \frac{n-1}{n} + W(i) \cdot \frac{1}{n} \quad (i=1, 2, \dots, N)$$

$W_j(i)$  : New displayed waveform

$W_{j-1}(i)$  : Existing displayed waveform

$W(i)$  : New obtained waveform

$N$  : Number of samples

$n$  : Number of averaging times

(12) <DISPLAY B BLANK B> key

Selects whether the trace B is to be displayed on the screen or not.

When this key is pressed, the "DISPLAY B" is replaced with the "BLANK B".

In the "DISPLAY B" status, a waveform is displayed on the screen. At this time, the trace display by the side of the data area becomes "DSP".

In the "BLANK B" status, no waveform is displayed on the screen. At this time, the trace display by the side of the data area becomes "BLK" and the marker and marker value disappear.

For the trace C

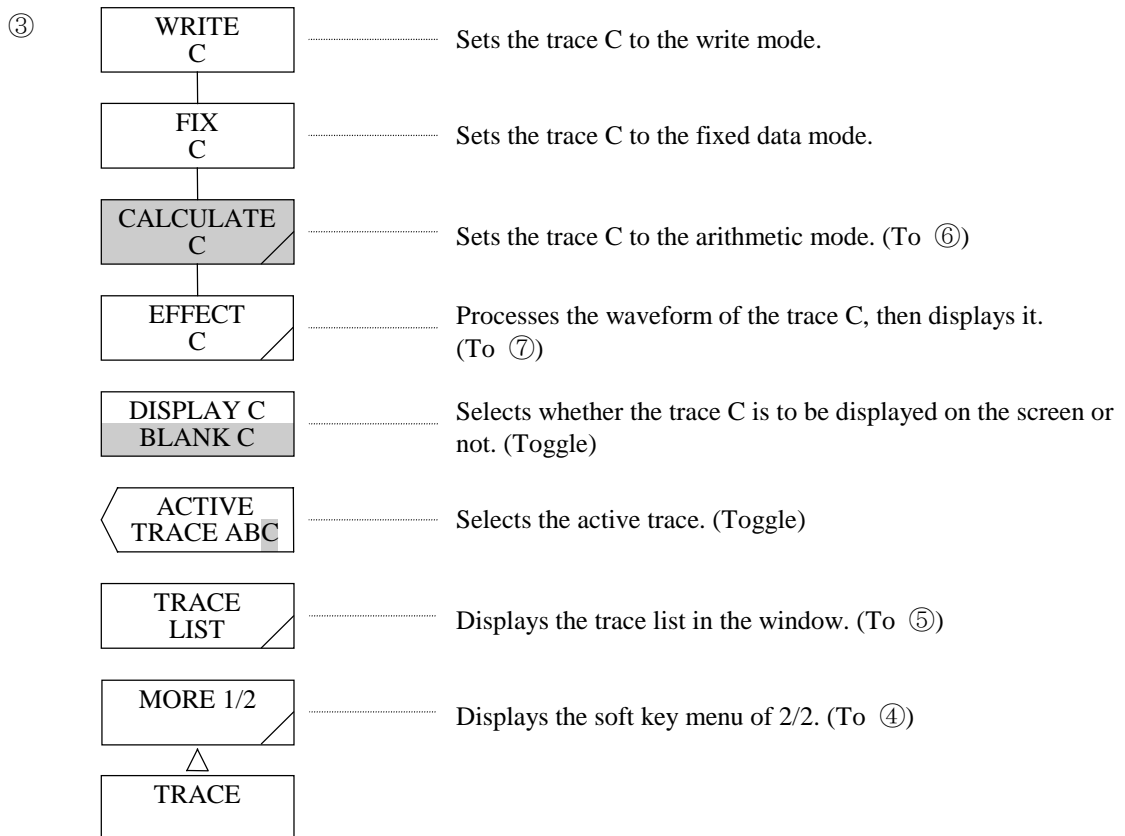

For the trace C

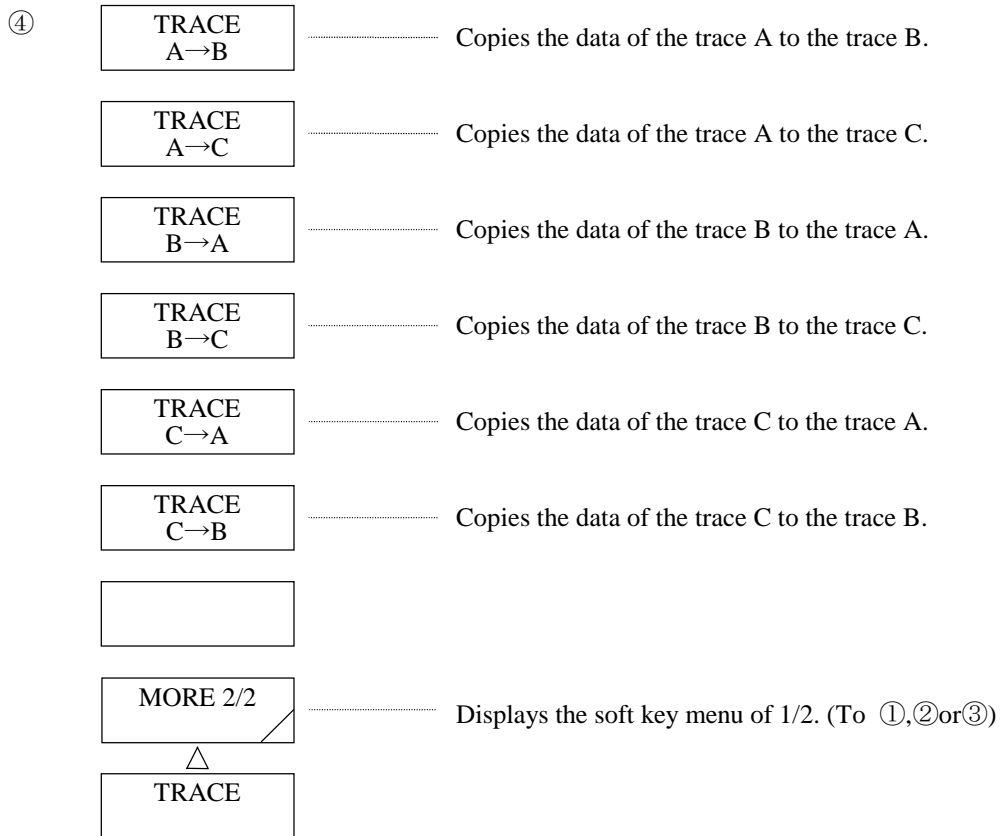

(13) <WRITE C> key

Sets the trace C to the write mode.

In this mode, the measured data is used as trace-C data as it is and displayed on the screen.

The trace display by the side of the data area becomes "WRITE".

(14) <FIX C> key

Sets the trace C to the fixed data mode.

In this mode, the data of the trace C is not changed by measurement, so that the waveforms on the screen are not changed.

The trace display by the side of the data area becomes "FIX".

When the <FIX C> key is pressed during a sweep, the waveforms displayed at that time are fixed as they are. When all of the trace A, trace B and trace C become FIX, the <STOP> key is displayed in reverse video and the sweep stops. Then, WARNING is displayed.

- (15) <CALCULATE C> key  
Sets the trace C to the arithmetic mode.  
In this mode, subtraction (LOG/linear value) or addition (linear value) are performed for the waveforms of the trace A and trace B by the selected status (calculation method) of the soft key menu displayed by pressing this key, and the results are written into the trace C.  
The trace display by the side of the data area is changed to the display corresponding to the above latch status.  
When trace A or B contains any data that cannot be calculated, WARNING is displayed.
- (16) <EFFECT C> key  
Processes the measured data of the trace C and displays it.  
In this mode, one of the NORMALIZE, DOMINANT and CURVE FIT functions is executed depending on the selected status of the soft key menu displayed by pressing this key, and its result is written into the trace C. The result is displayed when the measurement is completed up to the end.  
The trace display by the side of the data area is changed into the display corresponding to the above selected status.
- (17) <DISPLAY C BLANK C> key  
Selects whether the trace C is to be displayed on the screen or not.  
When this key is pressed, the "DISPLAY C" is replaced with the "BLANK C".  
In the "DISPLAY C" status, a waveform is displayed on the screen.  
At this time, the trace display by the side of the data area becomes "DSP".  
In the "BLANK C" status, no waveform is displayed on the screen. At this time, the trace display by the side of the data area becomes "BLK" and the marker and marker value disappear.
- (18) <TRACE A → B> key  
Copies the data of the trace A to the trace B.  
After copying, the trace B becomes FIX.  
The trace display by the side of the data area becomes "FIX".
- (19) <TRACE A → C> key  
Copies the data of the trace A to the trace C.  
After copying, the trace C becomes FIX.  
The trace display by the side of the data area becomes "FIX".
- (20) <TRACE B → A> key  
Copies the data of the trace B to the trace A.  
After copying, the trace A becomes FIX.  
The trace display by the side of the data area becomes "FIX".
- (21) <TRACE B → C> key  
Copies the data of the trace B to the trace C.  
After copying, the trace C becomes FIX.  
The trace display by the side of the data area becomes "FIX".



(22) <TRACE C → A> key

Copies the data of the trace C to the trace A.

After copying, the trace A becomes FIX.

The trace display by the side of the data area becomes "FIX".

(23) <TRACE C → B> key

Copies the data of the trace C to the trace B.

After copying, the trace B becomes FIX.

The trace display by the side of the data area becomes "FIX".

⑤

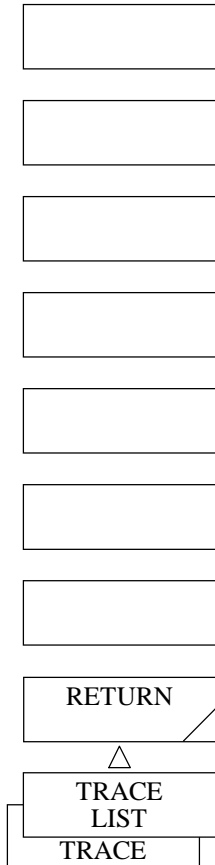

Returns to the soft key menu of MORE 1/2. (To ①,②or③)

(24) <RETURN> key

Returns to the soft key menu of "MORE 1/2" (①, ② or ③).

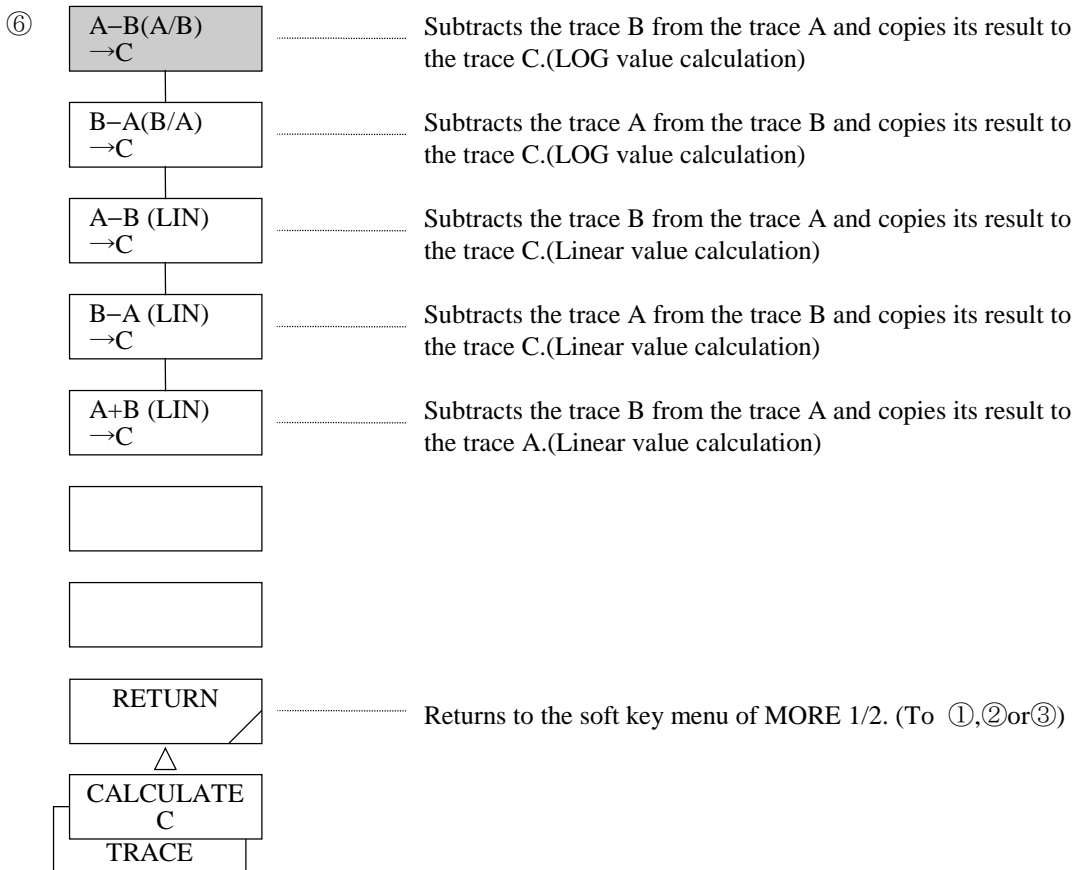

(25) <A - B (A/B) → C> key

Subtracts the data of the trace B from the trace A (in LOG value) and writes its result to the trace C.

When both trace A and trace B are set to BLANK, the subscale is displayed on the left of the screen.

In the other cases, the subscale is on the right of the screen.

When a waveform is recalled to the trace A or trace B, calculation and display are tried again.

When the center wavelength and span have been changed, calculation and display are tried again with new waveform data.

The trace display by the side of the data area becomes "A - B".

When the measuring condition (RESOLUTION) of the trace C does not agree with that of the trace B,

WARNING is displayed.

In any case, calculation and display are performed.

(26) <B – A (B/A) → C> key

Subtracts the data of the trace A from the trace B (in LOG value) and writes its result to the trace C.

When both trace A and B are set to BLANK, the subscale is displayed on the left of the screen.

In the other cases, the subscale is displayed on the right of the screen.

When a waveform is recalled to the trace A or trace B, calculation and display are tried again.

When the center wavelength and span have been changed, calculation and display are tried again with new waveform data.

The trace display by the side of the data area becomes "B – A".

When the measuring condition (RESOLUTION) of the trace A does not agree with that of the trace B, WARNING is displayed.

In any case, calculation and display are performed.

(27) <A – B (LIN) → C> key

Subtracts the data of the trace B from the trace A (in linear value) and writes its result to the trace C.

When a waveform is recalled to the trace A or trace B, calculation and display are tried again.

When the center wavelength and span have been changed, calculation and display tried again with new waveform data.

The trace display by the side of the data area becomes "A – B LIN".

When the measuring condition (RESOLUTION) of the trace A does not agree with that of the trace B, WARNING is displayed.

In any case, calculation and display are performed.

(28) <B – A (LIN) → C> key

Subtracts the data of the trace A from the trace B (in linear value) and copies its result to the trace C.

When a waveform is recalled to the trace A or trace B, calculation and display are tried again.

When the center wavelength and span have been changed, calculation and display are tried again with new waveform data.

The trace display by the side of the data area becomes "B – A LIN".

When the measuring condition (RESOLUTION) of the trace A does not agree with that of the trace B, WARNING is displayed.

In any case, calculation and display are performed.

(29) <A + B (LIN) → C> key

Adds the data of the trace A to that of the trace B (in linear value) and copies its result to the trace C.

When a waveform is recalled to the trace A or trace B, calculation and display are tried again.

When the center wavelength and span have been changed, calculation and display are tried again with new waveform data.

The trace display by the side of the data area becomes "A + B LIN".

When the measuring condition (RESOLUTION) of the trace A does not agree with that of the trace B, WARNING is displayed.

In any case, calculation and display are performed.

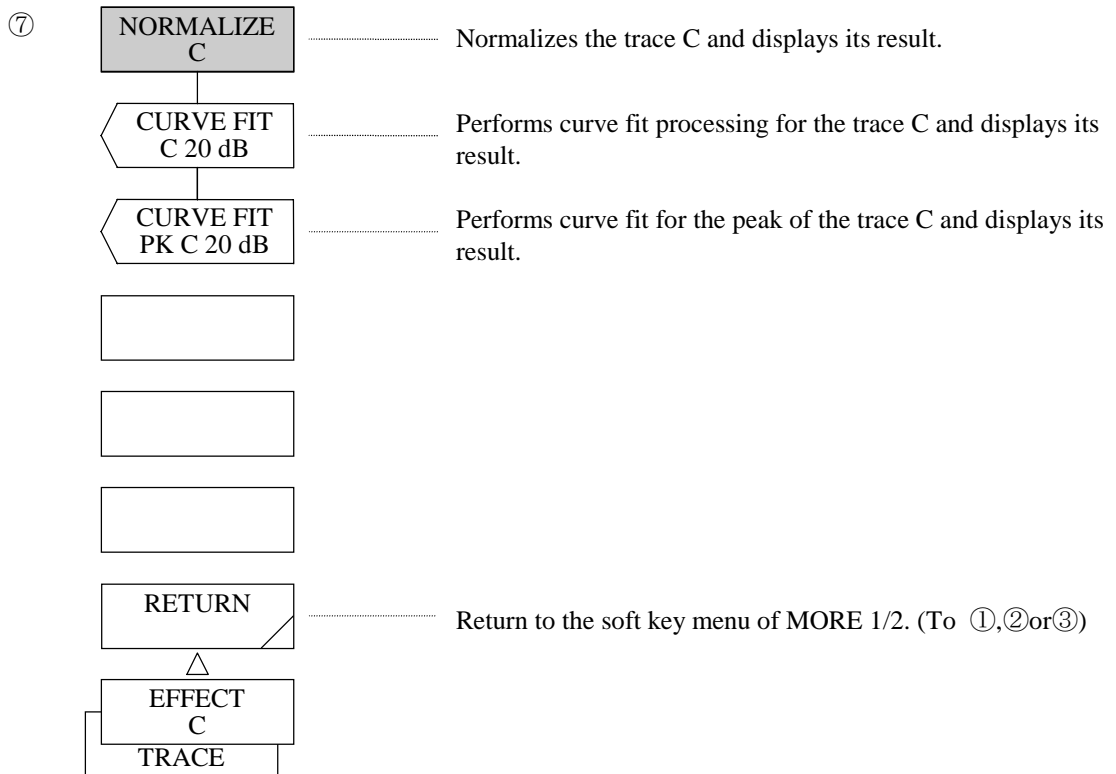

(30) <NORMALIZE C> key

Normalizes the data of the trace C so that the peak point is set to 0 or 1 dB and displays its result.  
 The normalized data is displayed when the sweep is completed up to the end.  
 When both trace A and trace B are set to BLANK, the subscale is displayed on the left of the screen.  
 In the other cases, the subscale is displayed on the right of the screen.  
 The trace display by the side of data area becomes "NORM".

(31) <CURVE FIT C> key

Performs curve fit for the trace C and displays its result.  
 The data to be calculated is all that exceeds the limit value.  
 After execution, the current limit value is displayed in the interrupt display section.  
 The limit value can be changed in the range of 0 to 99 dB (1 step) by the rotary knob, step keys or ten-key pad.  
 The trace display by the side of the data area becomes "CV FIT".

(32) <CURVE FIT PK C> key

Performs curve fit for the peak of the trace C and displays its result.  
 The data to be calculated is all that exceeds the limit value.  
 After execution, the current limit value is displayed in the interrupt display section. The limit value can be changed in the range of 0 to 99 dB (1 step) by the rotary knob, step keys or ten-key pad.  
 The trace display by the side of the data area becomes "CVFIT PK".

## 5.1.12 [DISPLAY] switch

The related screen display functions have been grouped in the DISPLAY switch area.

When this switch is pressed, the soft key menu of ① is displayed.

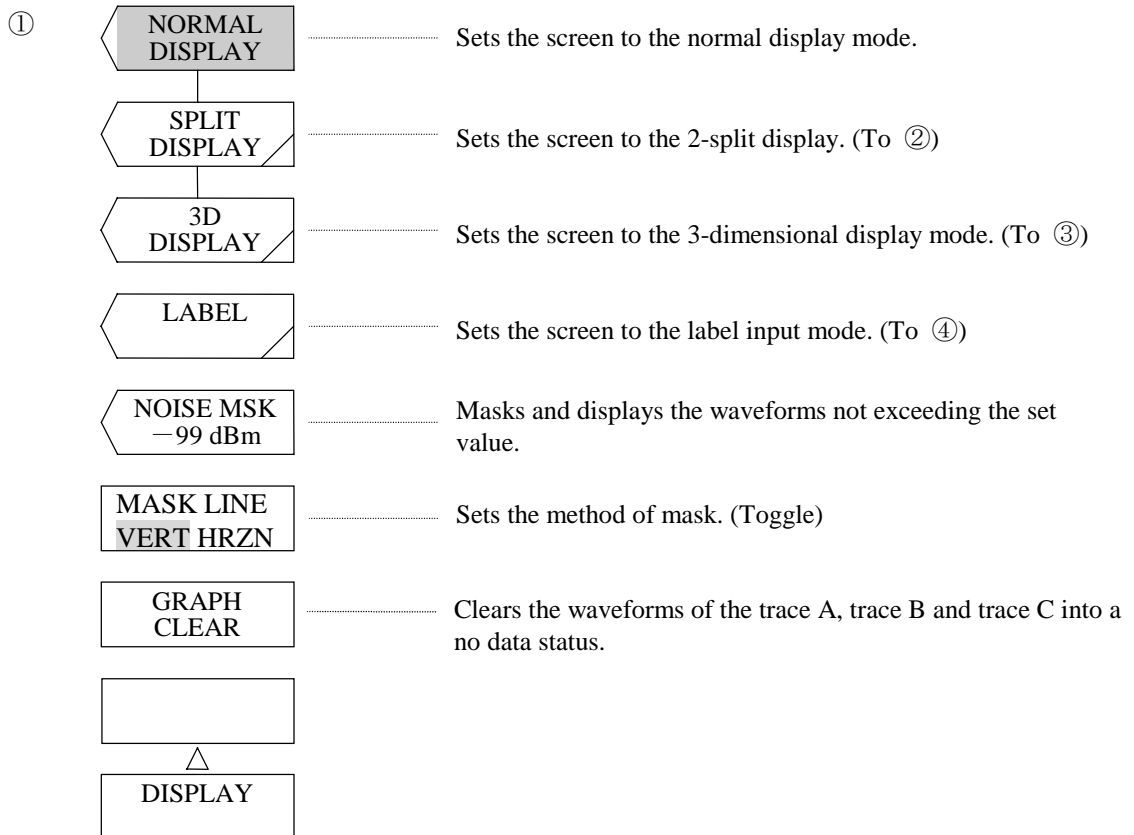

- (1) <NORMAL DISPLAY> key  
Sets the screen to the normal display mode.

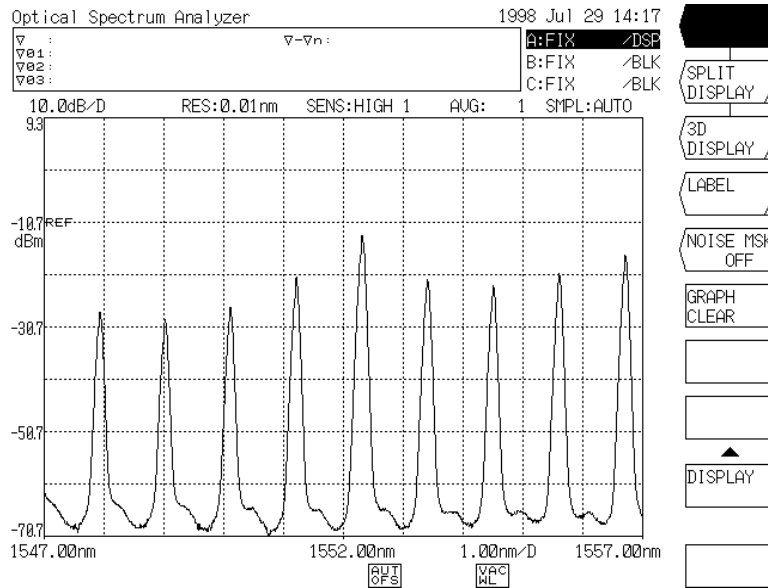

- (2) <SPLIT DISPLAY> key  
Sets the screen to the upper/lower 2-split display mode.  
The trace selected by the <TRACE A UP LOW>, <TRACE B UP LOW> or <TRACE C UP LOW> key is assigned.  
When this key is turned on and off, the status of the <UPPER HOLD> or <LOWER HOLD> key is cleared.

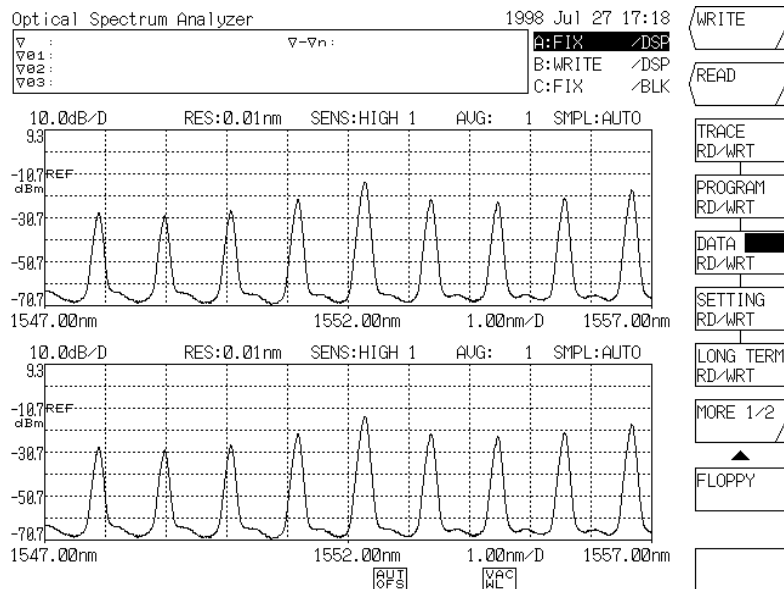

(3) <3D DISPLAY> key

Sets the screen to the 3-dimensional display mode.

In the 3-dimensional display, the Z axis (axis in the direction of depth) is added and 3 to 16 spectrums can be displayed at the same time. Updated waveforms are displayed forward on the screen by sweep and each of the previous waveforms is shifted backward.

The waveform to be handled in the 3-dimensional display mode is displayed by the function of the trace C. However, When the <FIX C> key is selected, the <WRITE C> key is selected instead.

When the <BLANK C> key is selected, the <DISPLAY C> key is latched instead.

When this key is OFF, the waveforms on 3-dimensional display are copied to the trace C.

**NOTE**

*Each waveform in the 3-dimensional display mode is saved in the 32 nonvolatile memories of this equipment.  
The number indicated on the Z axis scale correspond to the memory number.  
Accordingly, to reference a specific waveform on 3-dimensional display on the normal display screen, recall the memory corresponding to the number of the Z axis scale of the waveform. (Refer to 5.1.11 [MEMORY] switch.)*

(4) <LABEL> key

Sets the screen to the label input mode.

With this key, various messages such as a comment input to the label area and a program name input in the program function are entered.

When this key is pressed, a window for character selection is opened on the screen and a cursor appears on both window and label area. The cursor on the window can be moved by the rotary knob or step keys. The soft key menu is changed into the contents of the label function. The key displayed in this soft key menu is used for entering a label.

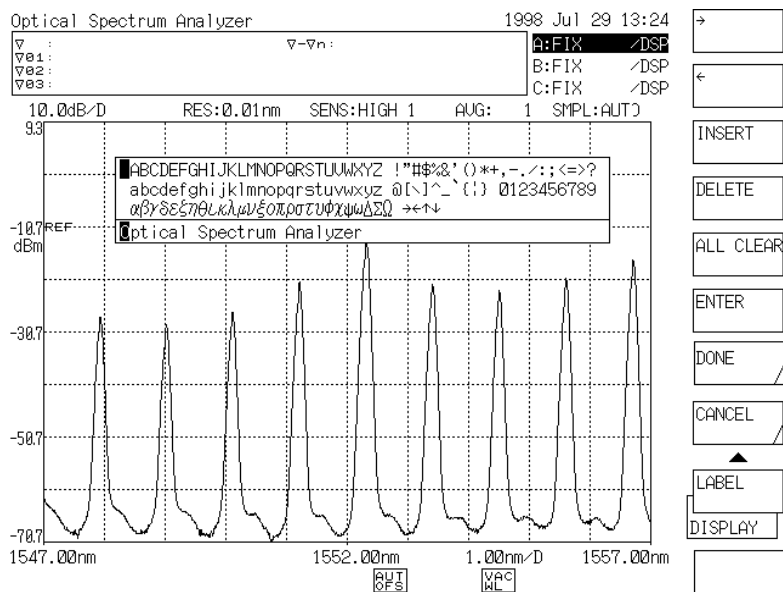

Label Input Screen

(5) <NOISE MSK> key

Masks and displays the waveforms not exceeding the set value at waveform display.

When a noise mask value is set, the waveform is rewritten in real time.

When this key is pressed, the current noise mask value is displayed in the interrupt display section.

The noise mask value can be changed in the range of OFF and 0 to – 100 dBm (1 step) by the rotary knob, step keys or ten-key pad.

If the <MARKER → REF LEVEL> key is executed when a marker is positioned at the noise mask level, WARNING is displayed.

When the noise mask value is set to any value other than OFF, 

NOI MSK
------------

 is displayed at the bottom of the screen.

(6) <MASK LINE VERT HRZN>key

sets the method of MASK.

Select VERT : Less than MASK value is made ZERO.

Select HRZN : Less than MASK value is made MASK value.

(7) <GRAPH CLEAR> key

Clears the waveforms of the trace A, trace B and trace C into a no data status.

(In the normal display mode or 2-split display mode) In the 3-dimensional display mode, only the waveforms are cleared.

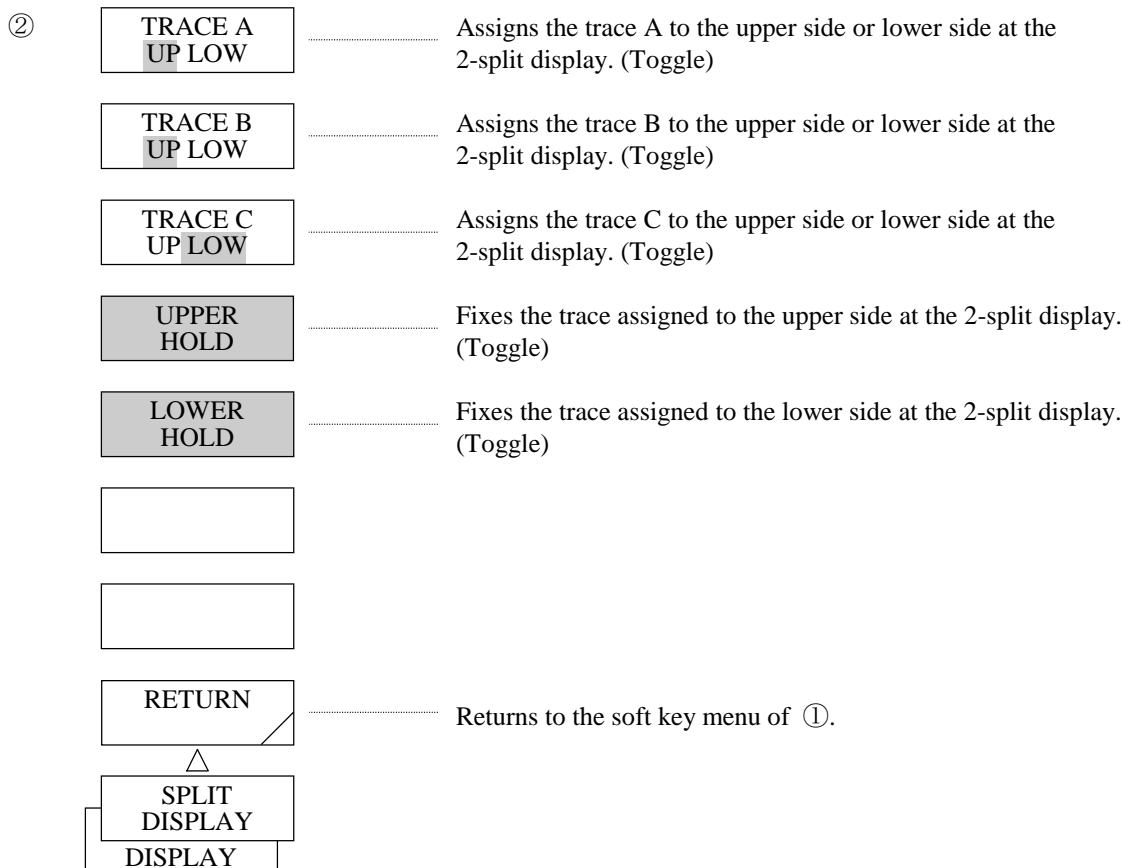



- (8) <TRACE A UP LOW> key  
Sets the trace A to the upper side or lower side in the 2-split display mode.  
In the "UP" selected status, the trace A is assigned to the upper side.  
In the "LOW" selected status, it is assigned to the lower side.  
When the setting has been changed, the trace A moves from upper to lower or from lower to upper.  
When trace assignment has been changed, the HOLD status is cleared and WARNING is displayed.
- (9) <TRACE B UP LOW> key  
Sets the trace B to the upper side or lower side in the 2-split display mode.  
In the "UP" selected status, the trace B is assigned to the upper side.  
In the "LOW" selected status, it is assigned to the lower side.  
When the setting has been changed, the trace B moves from upper to lower or from lower to upper.  
When trace assignment has been changed, the HOLD status is cleared and WARNING is displayed.
- (10) <TRACE C UP LOW> key  
Sets the trace C to the upper side or lower side in the 2-split display mode.  
In the "UP" selected status, the trace C is assigned to the upper side.  
In the "LOW" selected status, it is assigned to the lower side.  
When the setting has been changed, the trace C moves from upper to lower or from lower to upper.  
When the trace assignment has been changed, the HOLD status is cleared and WARNING is displayed.
- (11) <UPPER HOLD> key  
When this key is pressed into a selected status, the trace assigned to the upper side in the 2-split display mode is fixed and the scale is also fixed.  
When the selected status is cleared by pressing this key again, the scale is changed into the updated setting and the waveform is also changed.  
If the trace is changed from FIX to another in the selected status, WARNING is displayed as soon as the selected status is cleared.
- (12) <LOWER HOLD> key  
When this key is pressed into a selected status, the trace assigned to the lower side in the 2-split display mode is fixed and the scale is also fixed.  
When the selected status is cleared by pressing this key again, the scale is changed into the updated setting and the waveform is also changed.  
When the trace is changed from FIX into another in the selected status, WARNING is displayed as soon as the selected status is cleared.
- (13) <RETURN> key  
Returns to the soft key menu of ①.

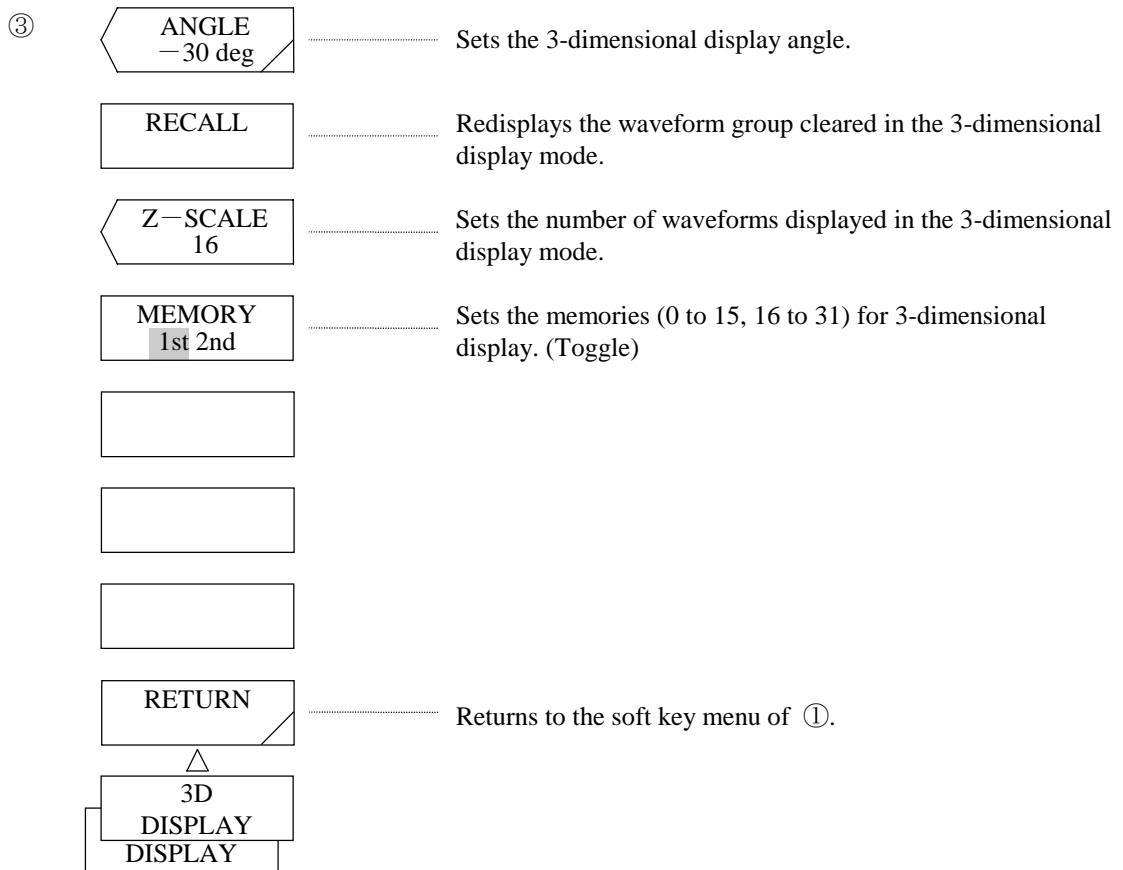

(14) <ANGLE> key

Sets the 3-dimensional display angle.

When this key is pressed, the current angle is displayed in the interrupt display section.

The angle can be changed in the range of +50 to - 50 deg (10 steps) by the rotary knob, step keys or ten-key pad.

As soon as the angle is changed, the waveform is rewritten according to the new angle.

(15) <RECALL> key

Redisplays the waveform group cleared by pressing the <GRAPH CLEAR> key or setting the 3-dimensional display mode again after sweeping in the normal display mode.

When the RECALL conditions are not satisfied, WARNING is displayed.

## NOTE

*The prior condition for redisplay is that the type of each waveform and measuring conditions (center wavelength, span and sampling points) for 3-dimensional display must be coincident. That is, after measurement in the 3-dimensional display mode, this mode is changed into the normal display mode and the waveforms measured under different conditions are saved into the memory used as a buffer for 3-dimensional display. In this case, these waveforms cannot be redisplayed even if the <RECALL> key is pressed.*

*Besides, if the selected status of the <MEMORY 1st 2nd> key is switched or a sweep is made by changing the Z scale, redisplay is disabled.*

### (16) <Z-SCALE> key

Sets the number of waveforms to be displayed simultaneously in the 3-dimensional display mode. When this key is pressed, the current number of waveforms is displayed in the interrupt display section. The number of waveforms can be changed in the range of 3 to 16 (1 step) by the rotary knob, step keys or ten-key pad.

After the number of waveforms of the Z scale is set to n by this key, the first memories corresponding to n waveforms out of the memories (1st: 0 to 15, 2nd: 16 to 31) selected by the <MEMORY 1st 2nd> key are used as buffers for 3-dimensional display.

For example, if the Z scale is set to 5 waveforms when "2nd" is selected by the <MEMORY 1st 2nd> key, memories 16, 17, 18, 19 and 20 are used as buffers.

By sweeping, the number display of the Z scale is changed in rotation between 16 and 20 as 16, 17, 18, 19, 20, 16, 17...

### (17) <MEMORY 1st 2nd> key

Selects memories (1st or 2nd) to be used as buffers for 3-dimensional display.

In the "1st" selected status, memories 0 to 15 are used.

In the "2nd" selected status, memories 16 to 31 are used.

This equipment is provided with 32 nonvolatile memories for storing waveforms. In the 3-dimensional display mode, the first memories corresponding to the number of waveforms of the Z scale out of the first half (memories 0 to 15) or the second half (memories 16 to 31) of the 32 memories are used as buffers.

④	→	.....	Moves the cursor in the label input area one character to the right.
	←	.....	Moves the cursor in the label input area one character to the left.
	INSERT	.....	Inserts a blank character into the cursor position in the label input area.
	DELETE	.....	Deletes the character at the cursor position in the label input area.
	ALL CLEAR	.....	Clears all the character strings in the label input area.
	ENTER	.....	Sets the characters on the label window into the label input area.
	DONE	.....	Copies the character strings in the label input area to the label area.
	CANCEL	.....	Cancels the label input and returns to the soft key menu of ①.
	△		
	LABEL		
	DISPLAY		

(18) <=> key

Moves the cursor in the label input area one character to the right in the label input status.  
When this key is continuously pressed for 0.5 sec or more, an auto repeat operation is performed.

(19) <<=> key

Moves the cursor in the label input area one character to the left in the label input status.  
When this key is continuously pressed for 0.5 sec or more, an auto repeat operation is performed.

(20) <INSERT> key

Inserts one blank character into the cursor position in the label input area in the label input status, shifting the character string existing on the right of the cursor to the right. When this key is continuously pressed for 0.5 sec or more, an auto repeat operation is performed.  
To insert a character into the label area, move the cursor to the position of the corresponding character and press this key.  
A space for the character to be inserted is made and the character is entered.

(21) <DELETE> key

Deletes one character at the cursor position in the label input area, shifting the character string existing on the right of the cursor to the left. When this key is pressed for 0.5 sec or more, an auto repeat operation is performed.  
To delete only an optional character in the label area, move the cursor to the corresponding character and press this key.

- (22) <ALL CLEAR> key  
Clears all the character strings in the label input area in the label input status and moves the cursor to the left end.
- (23) <ENTER> key  
Sets the character at the cursor position in the window for character selection to the cursor position in the label input area. The character is entered in the label input area and the cursor is shifted one character to the right.  
The <Enter> key of the numeric keypad also has the same functions.
- (24) <DONE> key  
Terminates an label input in the label input status and copies the character string in the label input area to the label area in the top of the screen.  
After completion of the above processing, the window is closed and the soft key menu of ① is displayed again.
- (25) <CANCEL> key  
Cancels a label input and the soft key menu of ① is displayed again.

### 5.1.13 [MEMORY] switch

In this switch, waveforms are saved and recalled to/from memory and a memory list is displayed.

This equipment is provided with 32 (0 to 31) nonvolatile memories that can store and recall displayed waveforms.

The main measuring conditions of each memory or the list containing the contents of labels can be displayed by the <LBL LIST CONDTN> key so that the stored contents of the memory can be checked.

The following 13 types of waveforms can be stored into memory.

Table 5-1 shows the contents that are displayed in the ATTR (types of waveforms) columns of the label list and the condition list.

Table 5-1 Waveforms that Can be Stored into Memory

Table of waveform	ATTR column	Type of waveform	ATTR column
Measurement waveform	MEAS	Linear addition display waveform	A+B_L
Normalization display waveform	NORM	Maximum value hold display waveform	MAX_H
Subtraction display waveform	A- B	Minimum value hold display waveform	MIN_H
Subtraction display waveform	B- A	Sequential addition averaging display waveform	R_AVG
Linear subtraction display waveform	A- B_L	Curve fit waveform	CVFT
Linear subtraction display waveform	B- A_L	Peak curve fit waveform	CVFTP

When this switch is pressed, the soft key menu of ① is displayed.

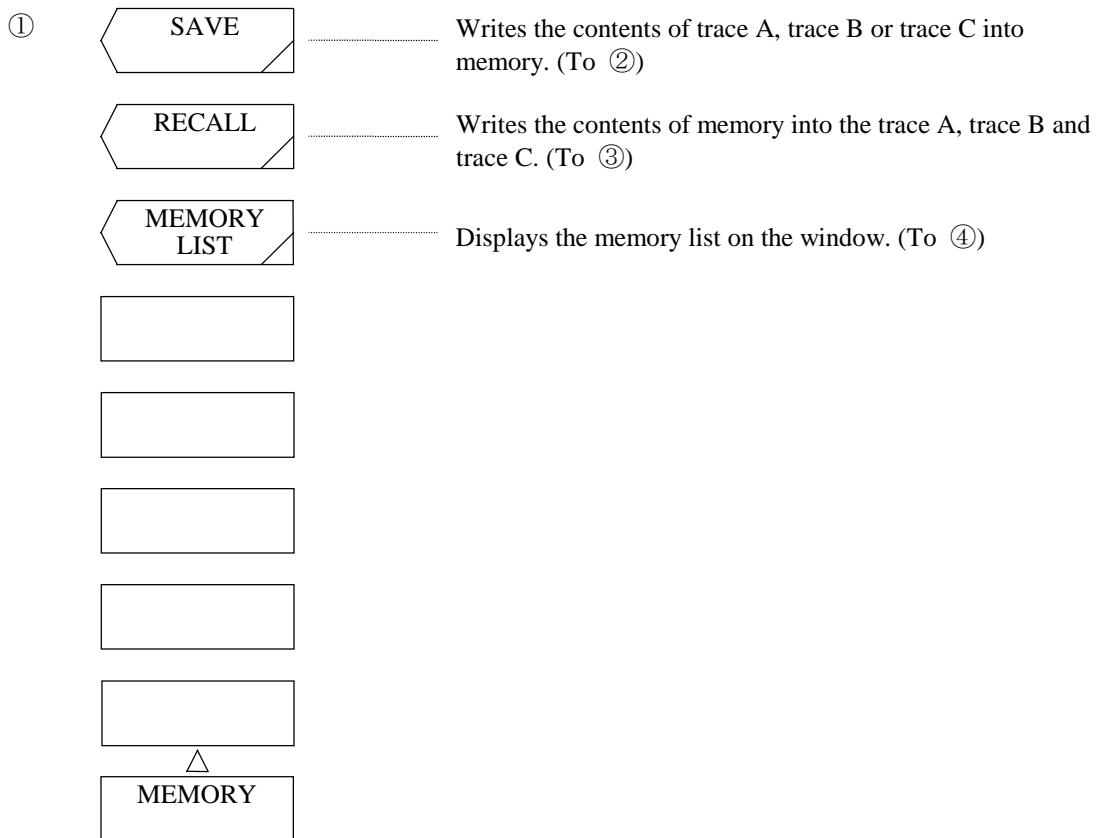

(1) <SAVE> key

Writes the contents of the trace A, trace B or trace C.

When this key is pressed, the soft key menu of ② is displayed.

The screen display is changed into the trace list (display of trace A, B and C measuring conditions) display and the memory list (label list or condition list) display.

The memory list display is changed depending on the selected status of the <LBL LIST CONDITN> key.

As a means for storing waveforms into memory, a number specification method using the ten-key pad and a memory number selection method using the rotary knob or step keys in the memory list display status are available.

(a) Memory number specification method using the ten-key pad

To store waveforms, press this key, enter a desired memory number (0 to 31) by the ten-key pad, and press the <ENTER> key.

For example, to store waveforms into memory No.12, press [MEMORY], <SAVE>, [1], [2] and <ENTER>.

- (b) Memory number selection method using the rotary knob or step keys  
When the NO. column displayed in reverse video is shifted up and down to the upper end and lower end of the screen by the rotary knob or step keys, the screen is scrolled.  
To store waveforms into memory, move the NO. column displayed in reverse video to the memory number and press the <ENTER> key.  
With the above operations, a memory operation is performed and the memory list display is changed into the normal display.  
Then, the trace name and the stored memory number are displayed in the interrupt display section like "A → MEM12".  
In the list display, the ATTR column of the memory number storing no waveform is blank.  
To return to the normal display screen without executing any memory operation, press the <CANCEL> key. At this time, the soft key menu of ① is displayed again.

(2) <RECALL> key

- Reads the contents of memory to trace A, trace B or trace C.  
When this key is pressed, the soft key menu of ③ is displayed.  
The screen display is changed into the trace list (display of the measuring conditions of the trace A, trace B and trace C) display and the memory list (label list or condition list) display.  
The memory list display depends on the selected status of the <LBL LIST CONDTN> key.  
As a means for reading waveforms from memory, a number specification method using the ten-key pad and a memory number selection method using the rotary knob or step keys are available.

(a) Memory number specification method using the ten-key pad

- To read waveforms, press this key, enter a desired memory number (0 to 31) by the ten-key pad, and press the <ENTER> key.  
For example, to read a memory No.12, press [MEMORY], <RECALL>, [1], [2], and <ENTER>.

(b) Memory number selection method using the rotary knob or step keys

- When the NO. column displayed in reverse video is shifted up and down to the upper end and lower end of the screen by the rotary knob or step keys, the screen is scrolled.  
To read waveforms, move the NO. column displayed in reverse video to the memory number and press the <ENTER> key.  
With the above operations, a read operation is performed and the memory list display is changed into the normal display. Then, the memory number and read trace name are displayed in the interrupt display section like "MEM12 → A".  
In the list display, the ATTR column of the memory number storing no waveform is blank.  
To return to the normal display screen without executing any read operation, press the <CANCEL> key. At this time, the soft key menu of ① is displayed again.

(3) <MEMORY LIST> key

- Displays the memory list window.  
The memory list includes the contents of trace. Accordingly, the trace list (display of the measuring conditions of the trace A, trace B and trace C) and the memory list (label list or condition list) are displayed on the screen.



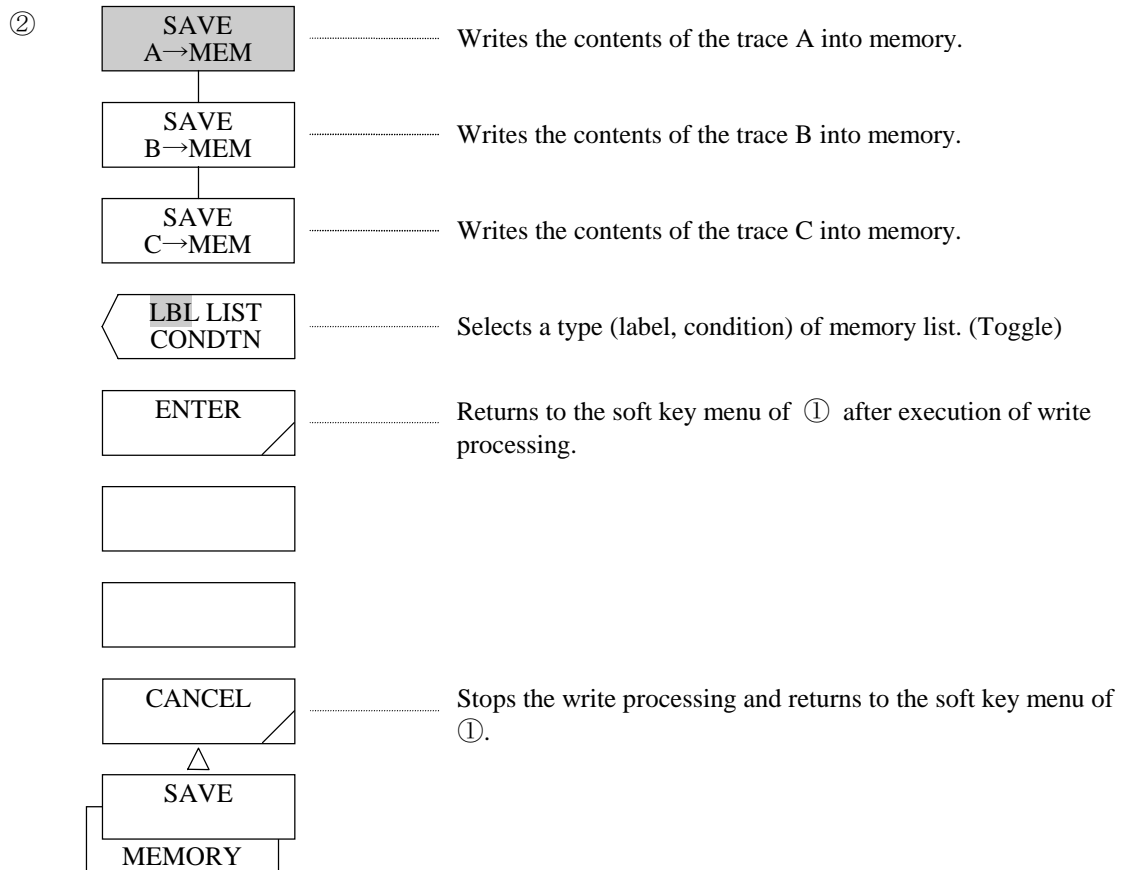

(4) <SAVE A → MEM> key

Writes the contents of the trace A into memory.

If this key is pressed into a reverse video status when writing waveforms into memory, the above contents are executed.

(5) <SAVE B → MEM> key

Writes the contents of the trace B into memory.

If this key is pressed into a reverse video status when writing waveforms into memory, the above contents are executed.

(6) <SAVE C → MEM> key

Writes the contents of the trace C into memory.

If this key is pressed into a reverse video status when writing waveforms into memory, the above contents are executed.

(7) <LBL LIST CONDTN> key

Sets whether the memory list is to be displayed by the label list or by the condition list.

Each time this key is pressed, the reverse video status is changed and the corresponding list (label list or condition list) is displayed.

(8) <ENTER> key (SAVE)

Executes an operation for writing the contents of trace into memory, clear the window, and returns to the normal display screen. The soft menu key of ① is displayed again.

The [ENTER] switch in the ten-key pad functions in the same way as this key.

After this key is executed, the trace name and the corresponding memory No. are displayed in the interrupt display section. If a numeric value other than 0 to 31 is entered as a memory number by the ten-key pad, WARNING is displayed.

(9) <CANCEL> key (SAVE)

Cancels a write operation from a trace into memory, clears the window, and returns to the normal display screen.

The soft key menu of ① is displayed again.

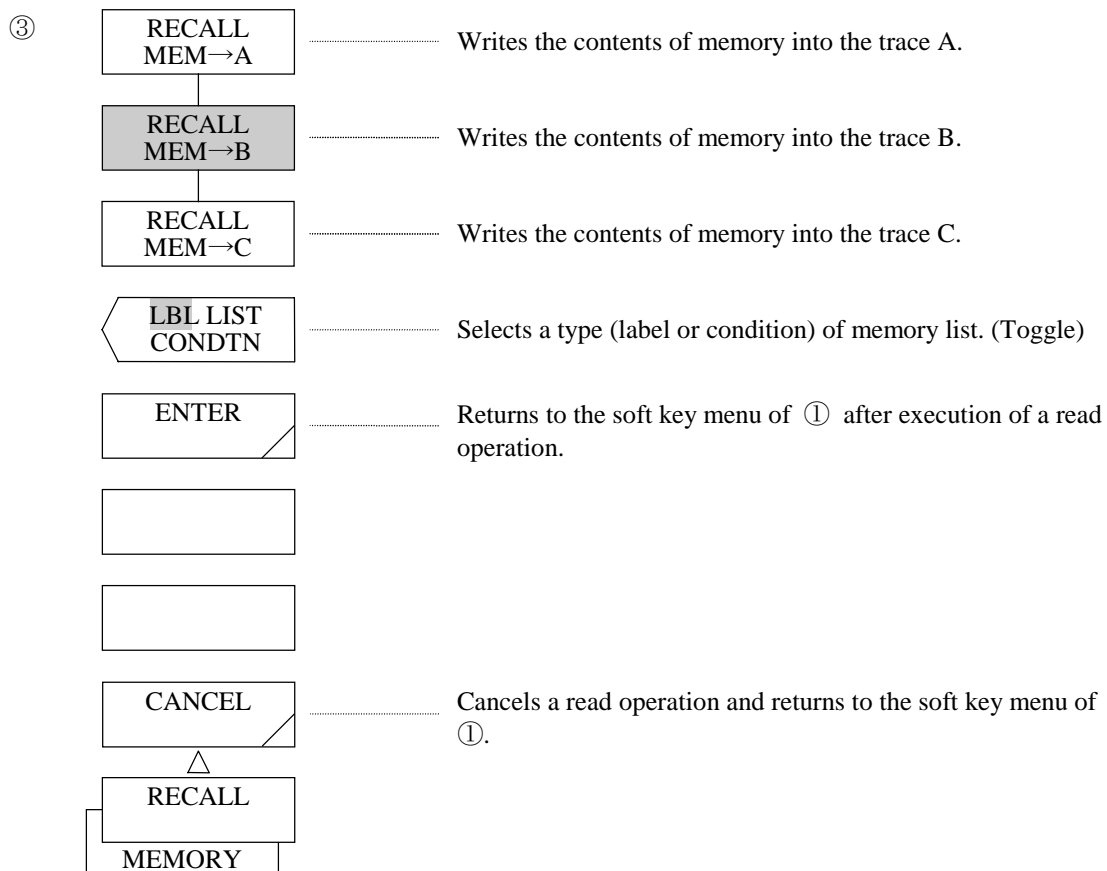

(10) <RECALL MEM → A> key

Reads the contents of memory into the trace A.

If this key is displayed in reverse video when reading from memory into the trace, the above contents are executed.

(11) <RECALL MEM → B> key

Reads the contents of memory into the trace B.

If this key is displayed in reverse video when reading from memory into the trace, the above contents are executed.

(12) <RECALL MEM → C> key

Reads the contents of memory into the trace C.

If this key is displayed in reverse video when reading from memory into the trace, the above contents are executed.

(13) <ENTER> key (RECALL)

Executes an operation for reading the contents of memory into a trace, clears the window, and returns to the normal display screen. The soft key menu of ① is displayed again.

The [ENTER] key in the ten-key pad functions in the same way as this key.

After this key is executed, the memory number and the corresponding trace are displayed in the interrupt display section.

(14) <CANCEL> key (RECALL)

Cancels a read operation from memory into a trace, clears the window, and returns to the normal display screen. The soft key menu of ① is displayed again.

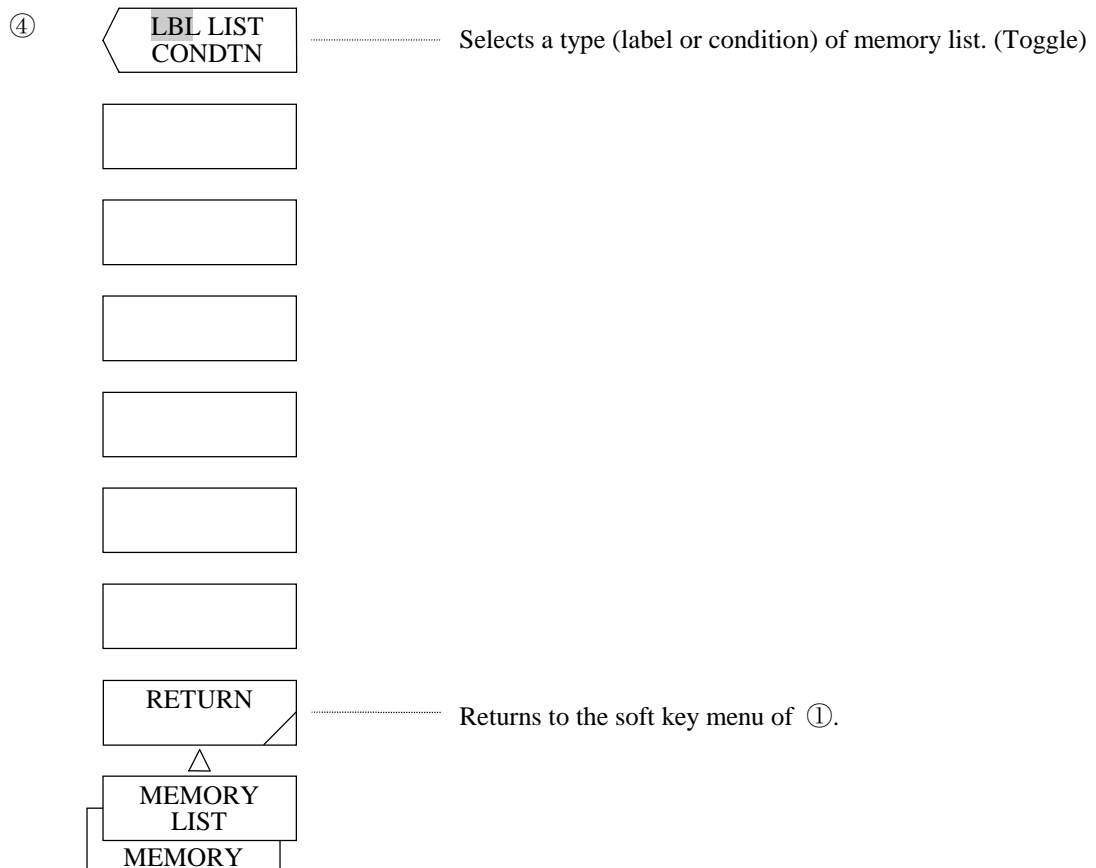

(15) <RETURN> key

Returns to the soft key menu of ①.

### 5.1.14 [FLOPPY] switch

This equipment is provided with a 3.5-inch 2HD floppy disk to store and read waveforms and programs. For the details of this function, refer to Chapter 7 Floppy Disk Functions.

The soft key menu is as follows. When this switch is pressed, the soft key menu of ① is displayed.

When the [FLOPPY] switch is pressed:

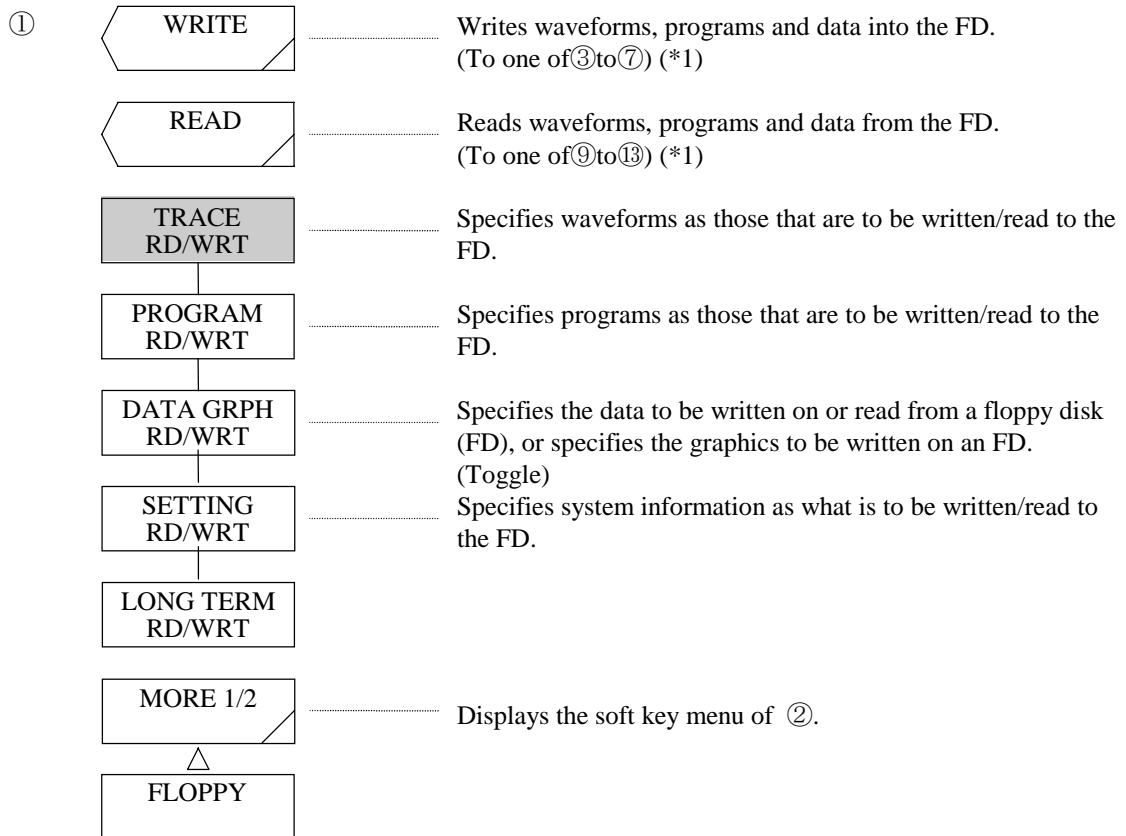

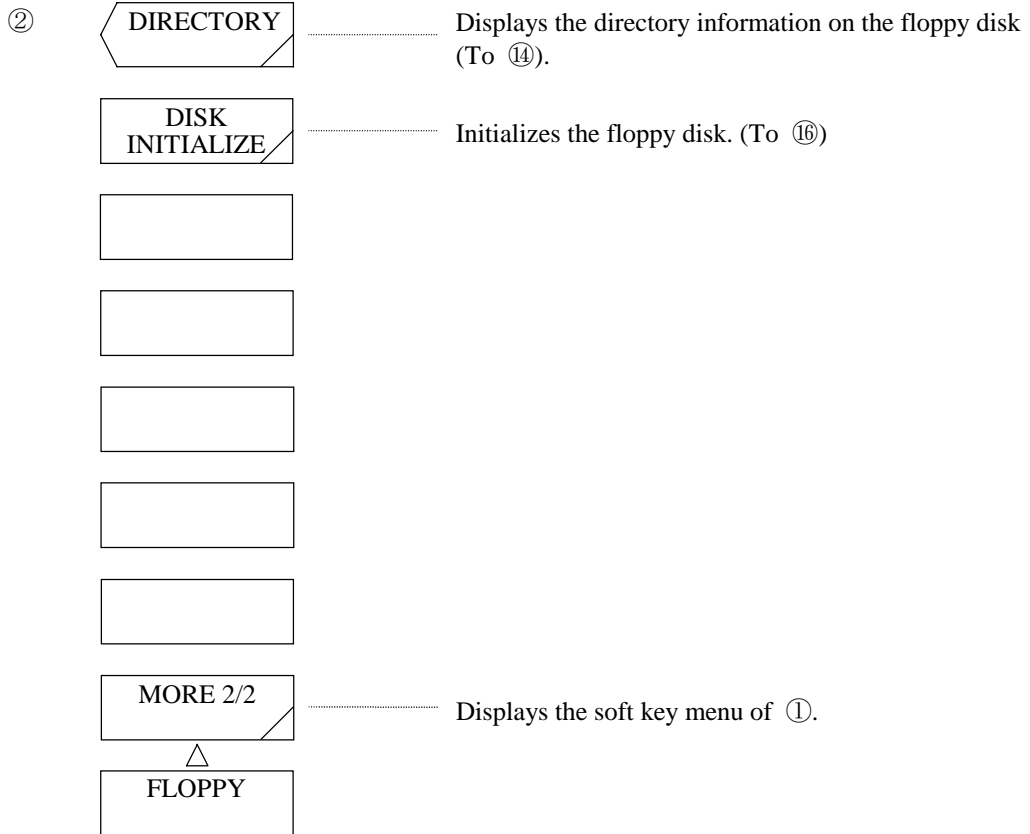

When the <TRACE RD/WRT> key is selected (write operation)

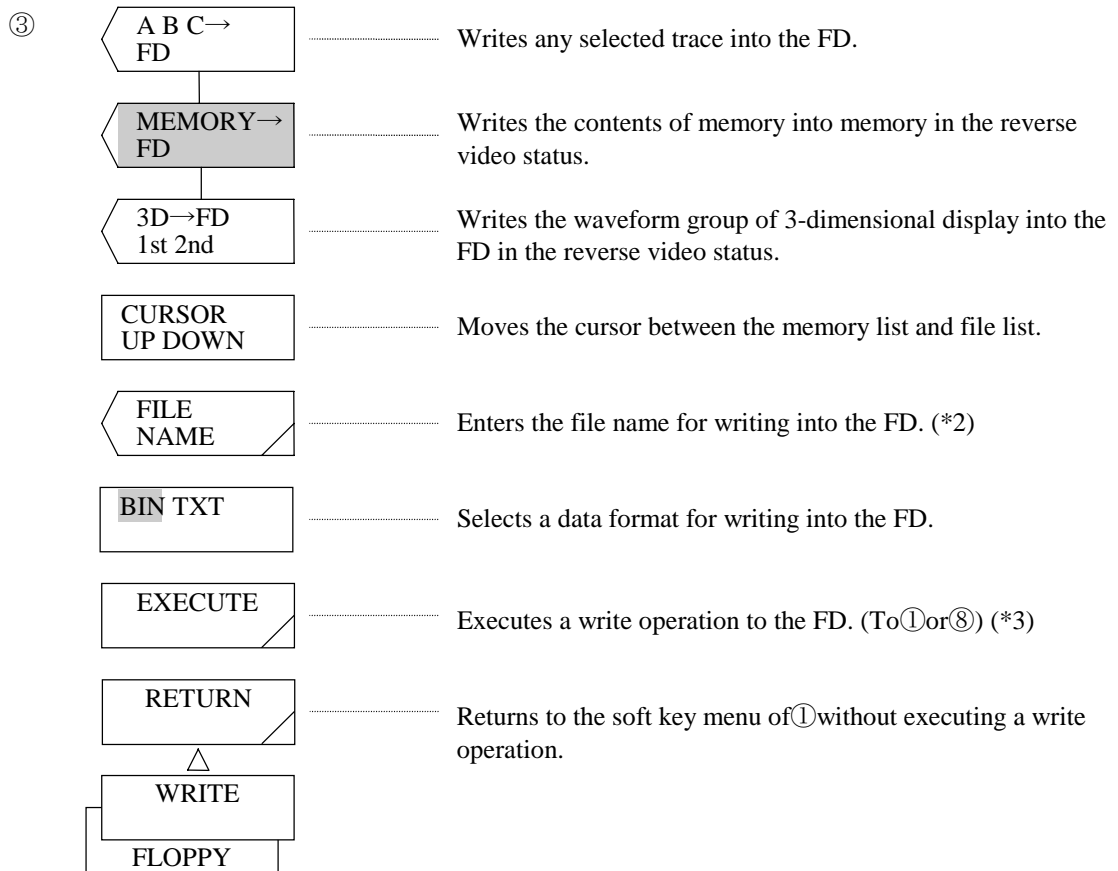

When the <PROGRAM RD/WRT> key selected (write operation):

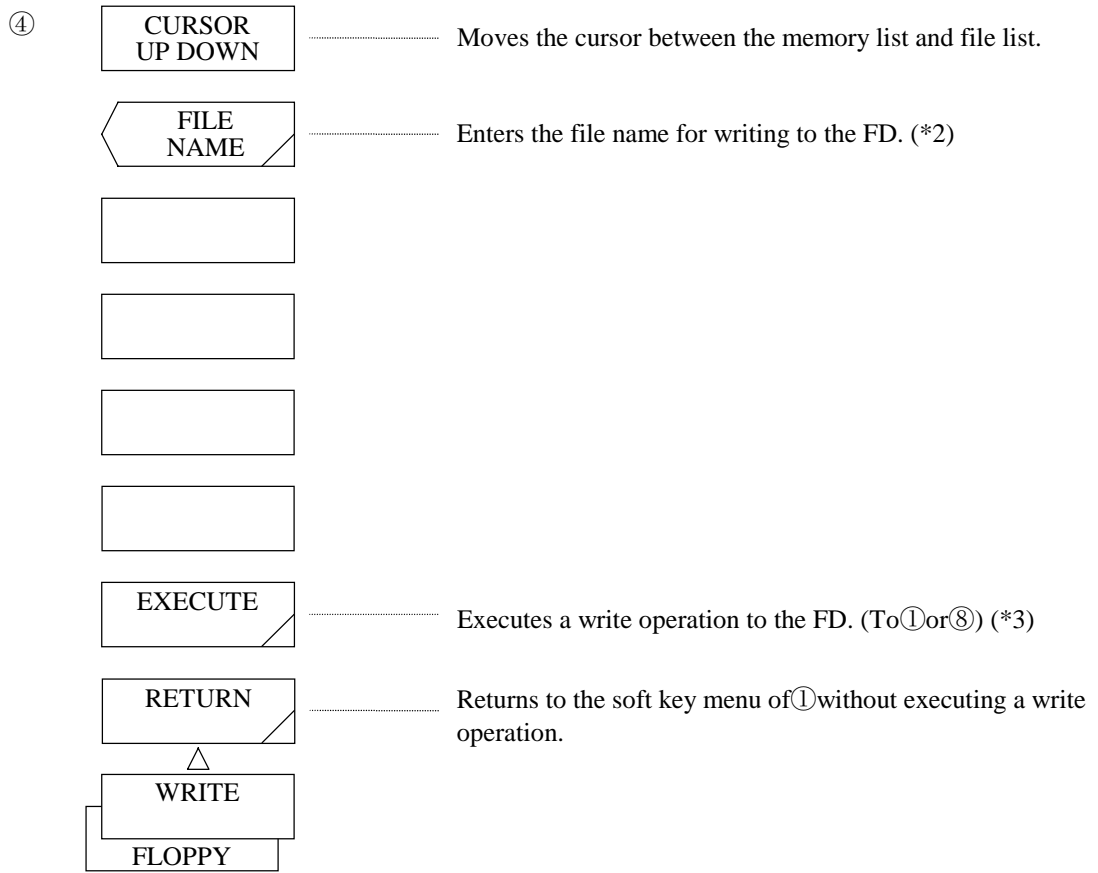

When the <DATA GRPH RD/WRT> key is selected – the DATA is highlighted (write operation):

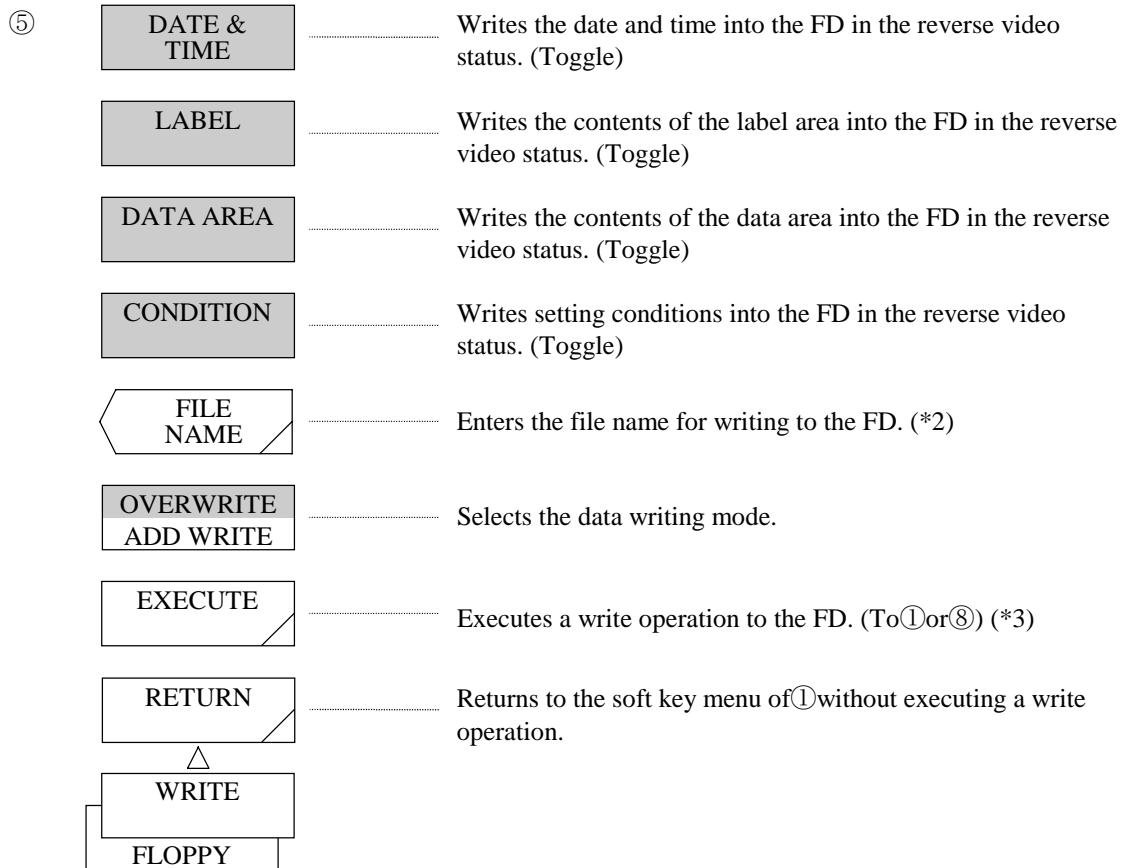



When the <DATA GRPH RD/WRT> key is selected - the GRPH is highlighted (write operation):

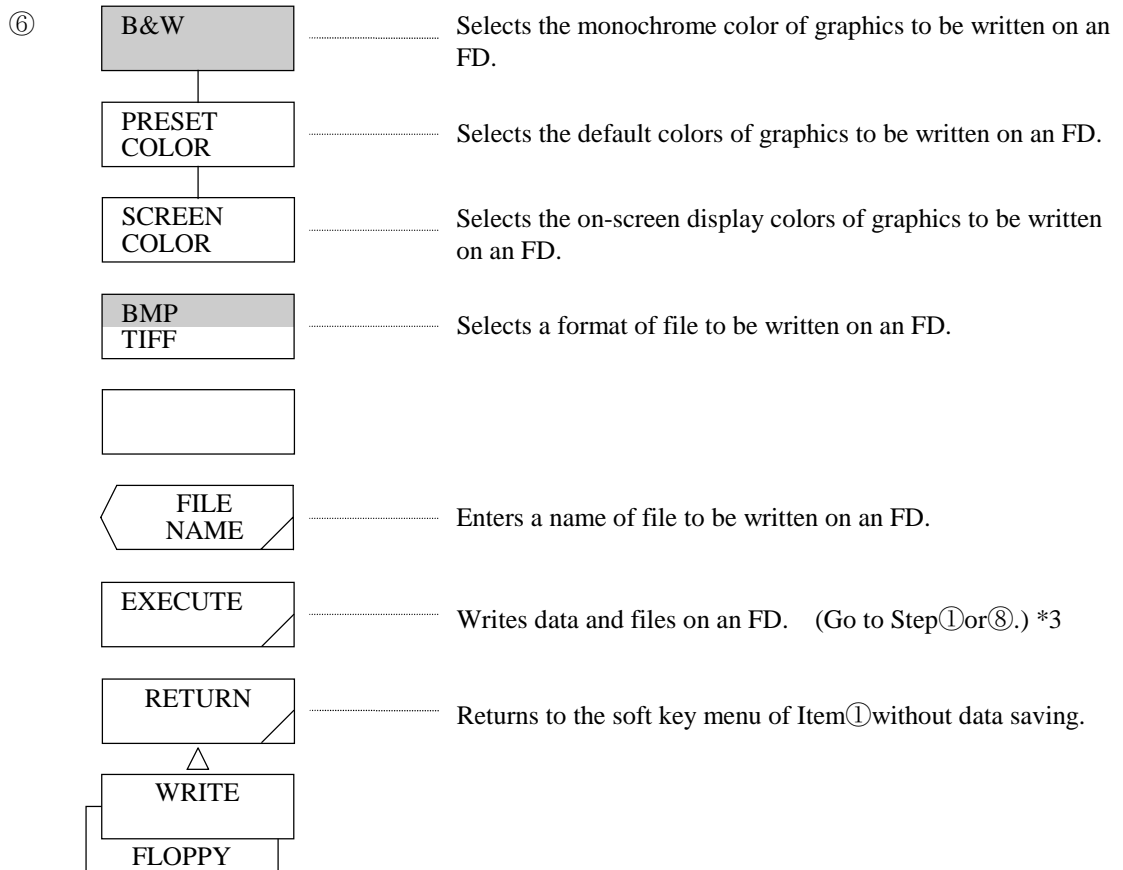

When the <SETTING RD/WRT> key or <LONG TERM RD/WRT> key is selected (write operation):

⑦

FILE  
NAME

Enters the file name for writing to the FD. (\*2)

EXECUTE

Executes a write operation to the FD. (To①or⑧) (\*3)

RETURN

Returns to the soft key menu of①without executing a write operation.



WRITE

FLOPPY

At an overwrite operation (write operation):

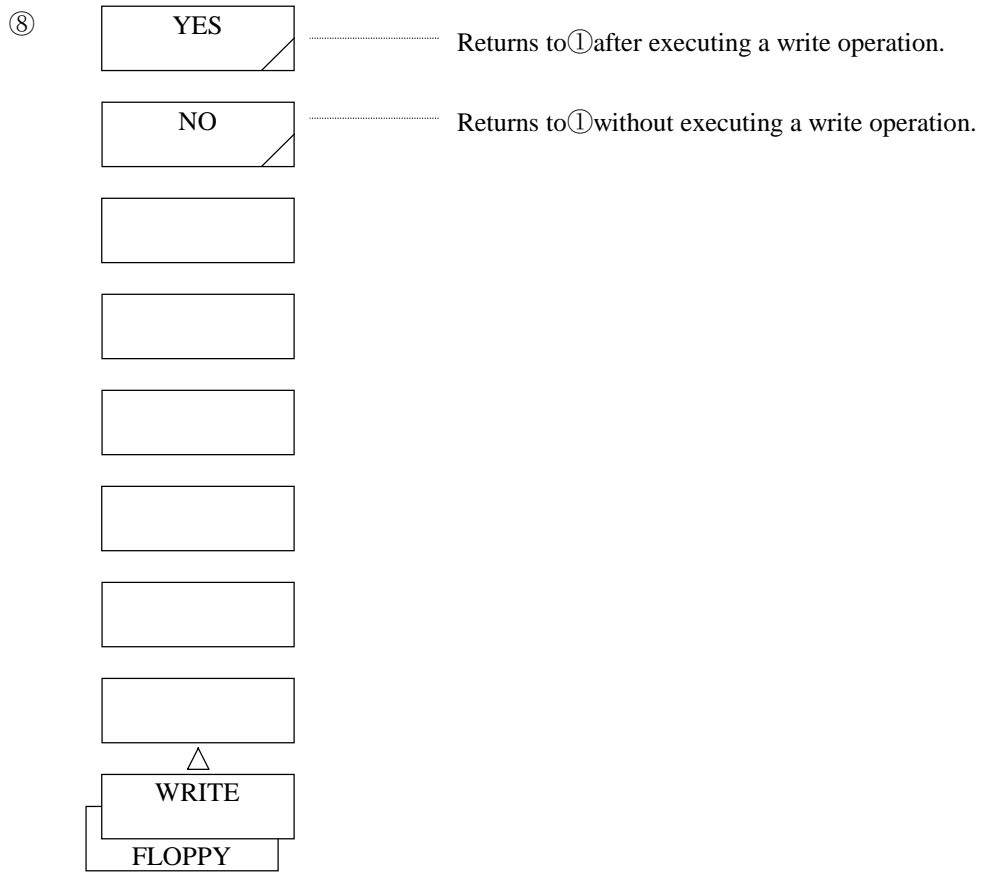

When the <TRACE RD/WRT> key is selected (read operation):

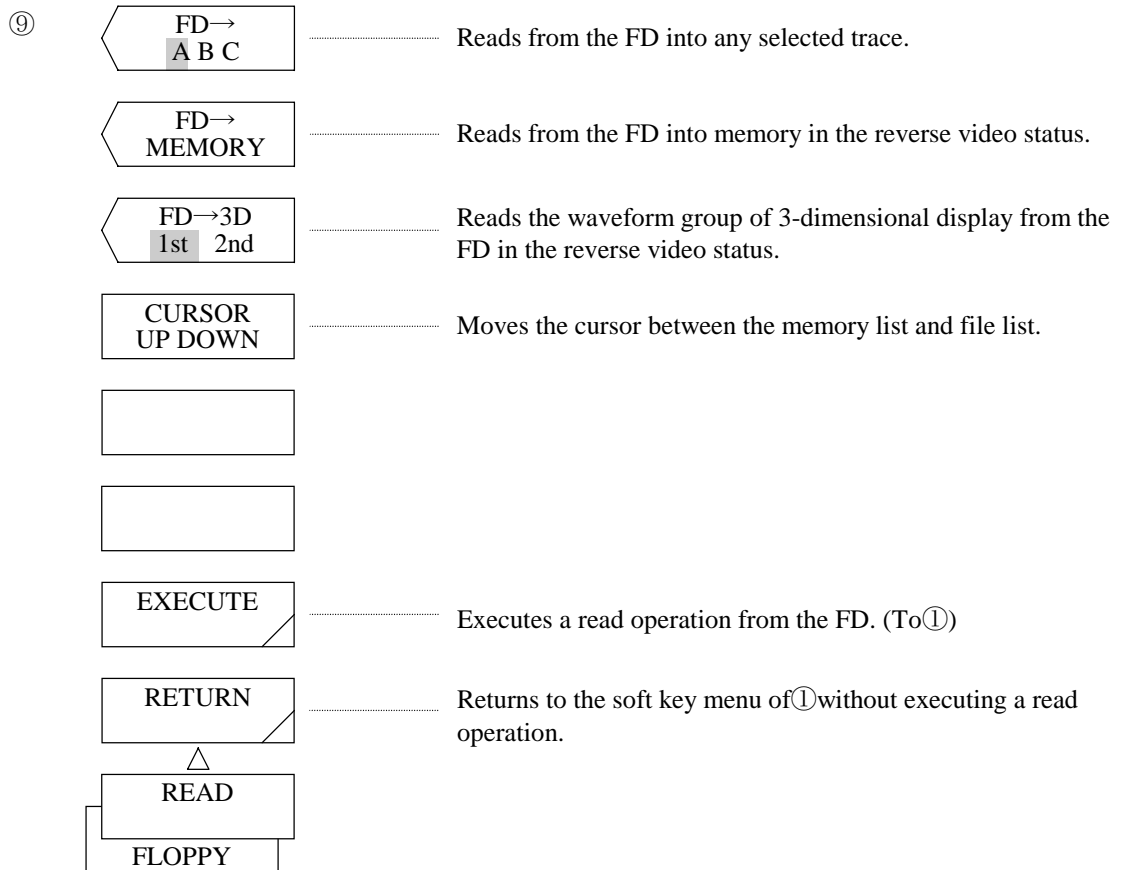

When the <PROGRAM RD/WRT> key is selected (read operation):

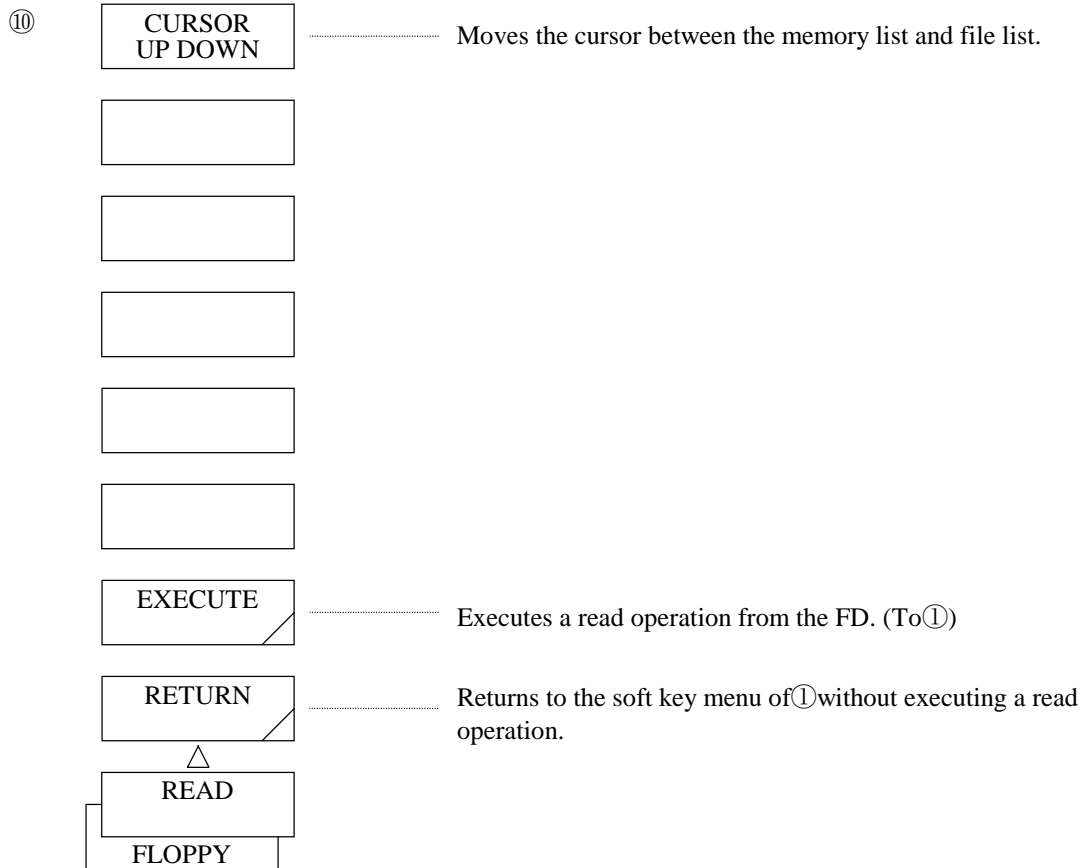

When the <DATA GRPH RD/WRT> key is selected – the DATA is highlighted (read operation):

⑪

EXECUTE

Executes a read operation from the FD. (To⑫)

RETURN

Returns to the soft key menu of⑪without executing a read operation.



READ

FLOPPY

When a data read operation is executed (read operation):

⑫



Returns to the soft key menu of ① canceling the data display.

When the <SETTING RD/WRT> key or <LONG TERM RD/WRT> key is selected (read operation):

⑬

Executes a read operation from the FD. (To①)

Returns to the soft key menu of①without executing a read operation.





When the <DIRECTORY> key is pressed:

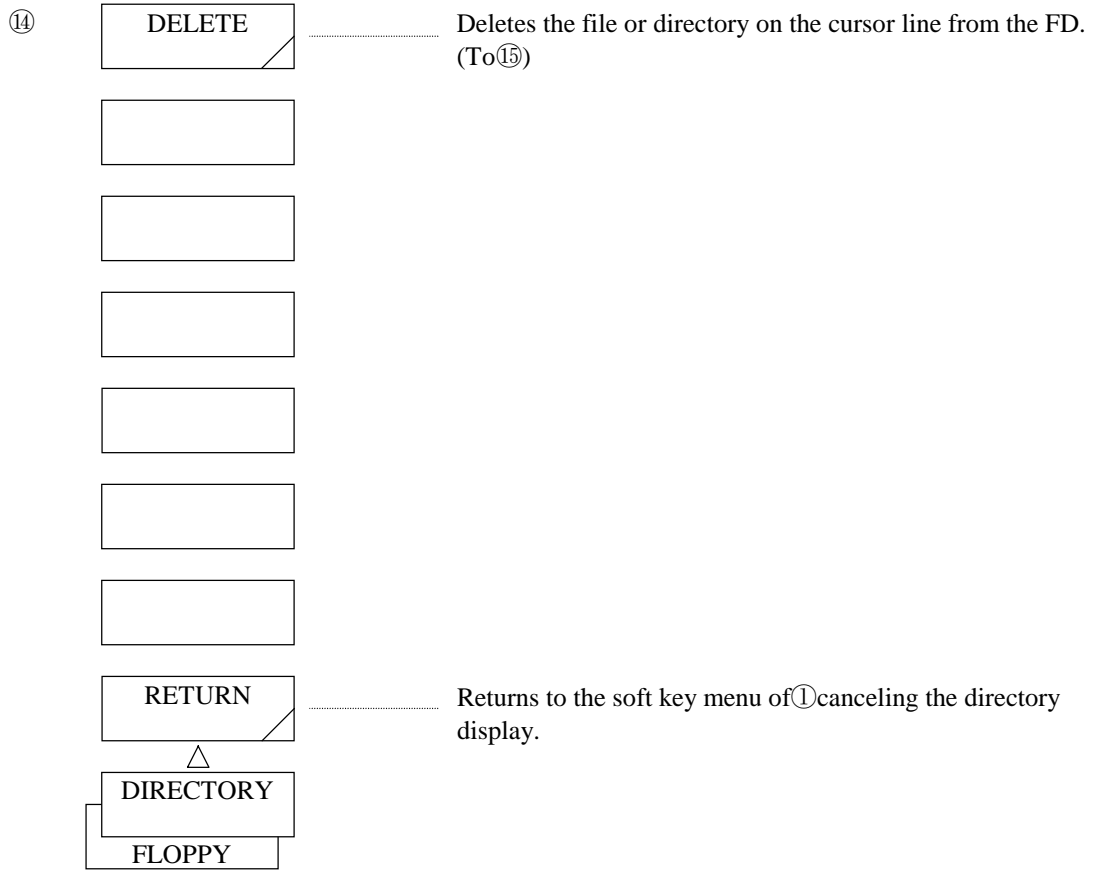

When a file or directory delete operation is executed:

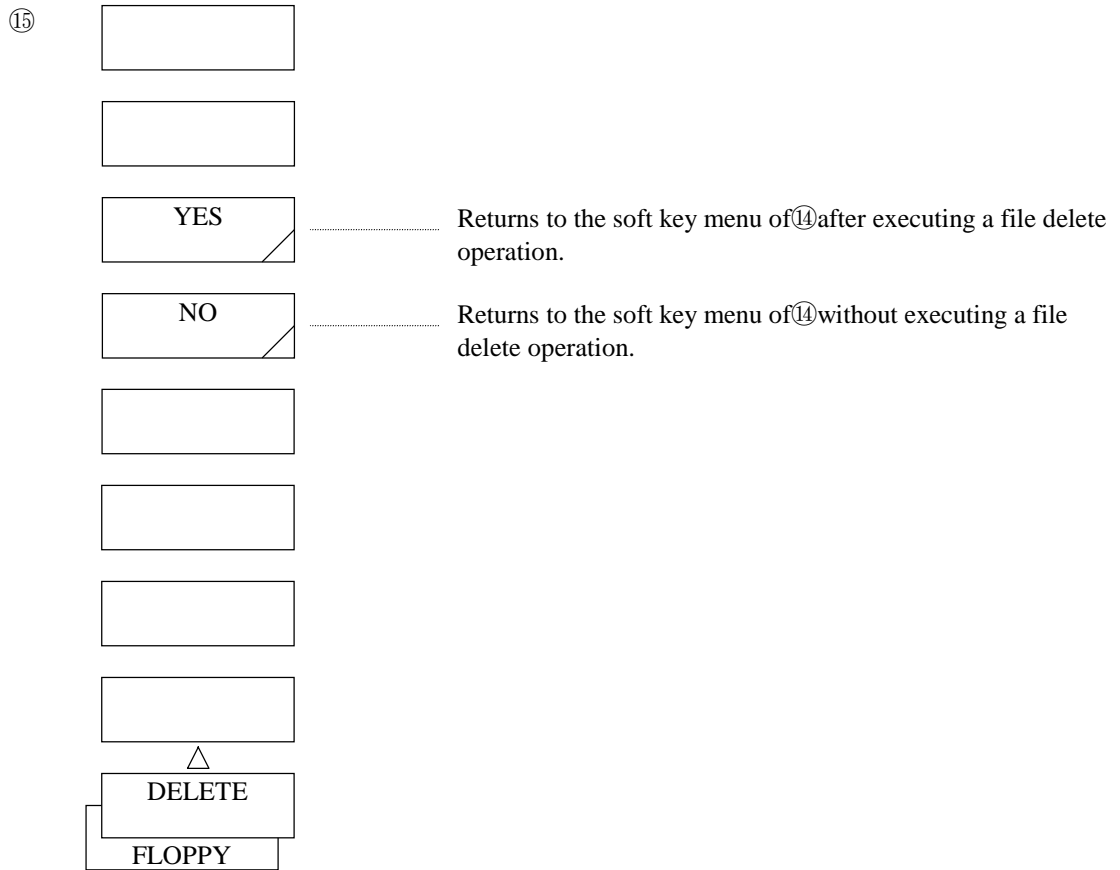

When the <DISK INITIALIZE> key is pressed:

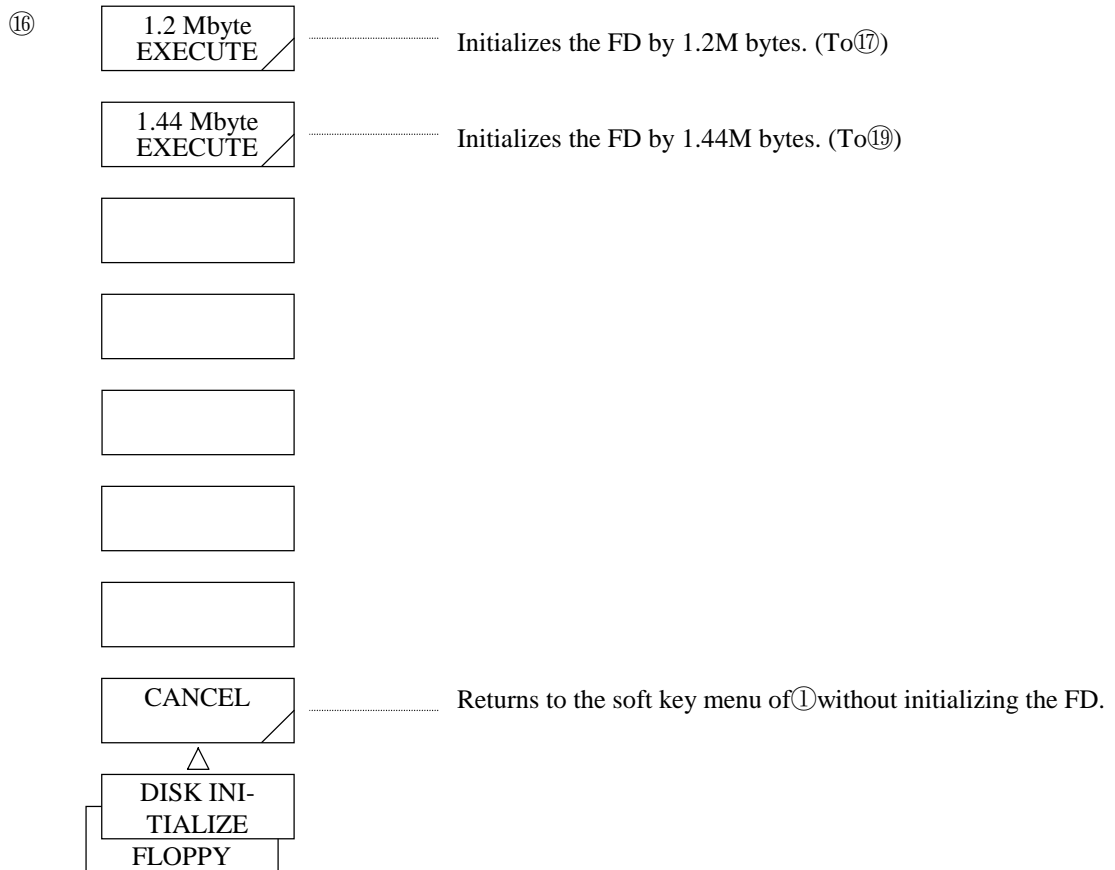

When the <1.2 M byte EXECUTE> key is pressed:

⑰

Initialize the FD. (⑱to⑰)

Returns to the soft key menu of⑰without initializing the FD.



When an initialize operation (1.2 M bytes) is executed:

⑱



Returns to the soft key menu of ⑰ canceling FD initialization.

When the <1.44 M byte EXECUTE> key is pressed:

①

Initializes the FD. (②to①)

Returns to the soft key menu of①without initializing the FD.



When an initialize operation (1.44M bytes) is executed:

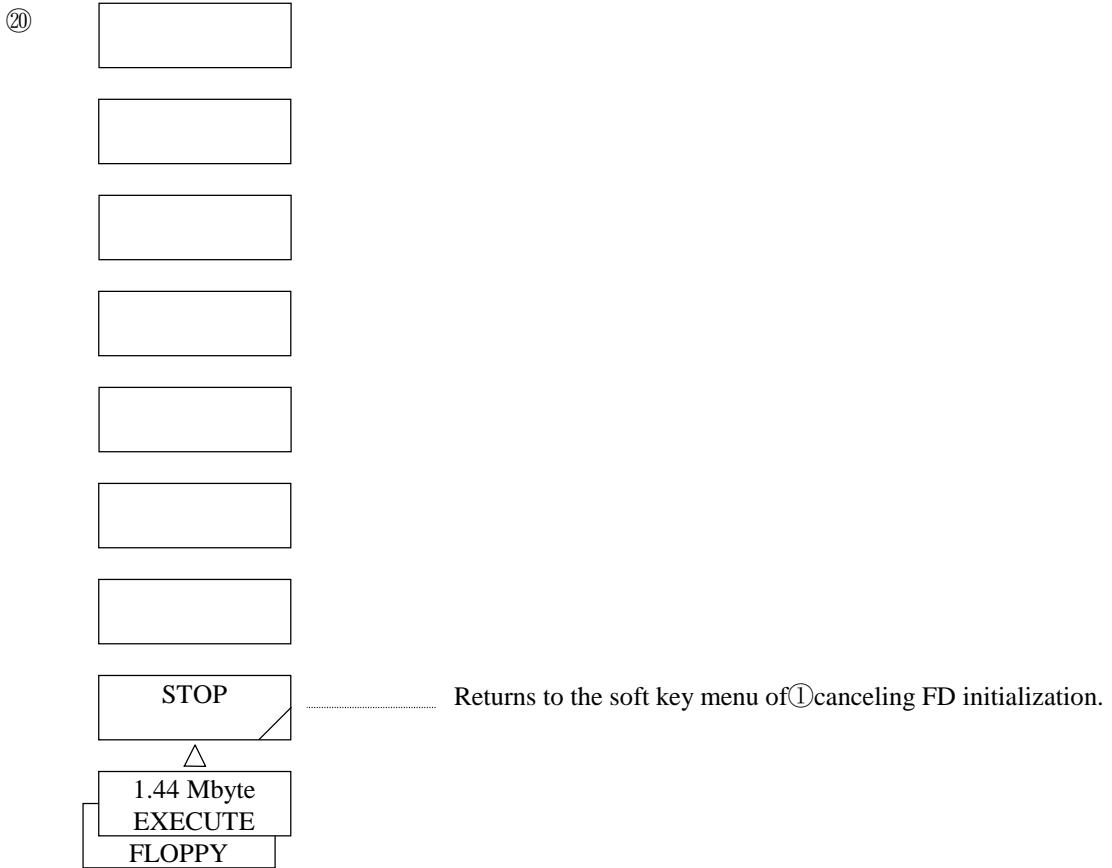

\*1 : When the <WRITE> key or <READ> key is pressed, the soft key menu to be displayed next depends on the selected status of the following 5 soft keys.

Selected soft key	Soft key menu display	
	Write status	Read status
<TRACE RD/WRT>	③	⑨
<PROGRAM RD/WRT>	④	⑩
<DATA GRPH RD/WRT> Data is highlighted.	⑤	⑪
<DATA GRPH RD/WRT> GRPH is highlighted.	⑥	—
<SETTING RD/WRT>	⑦	⑬
<LONG TERM RD/WRT>	⑦	⑬

\*2 : When the <FILE NAME> key is pressed, the same soft key menu as the <LABEL> key is displayed and the window for character selection is opened.  
By pressing the <DONE> key after entering a file name into the label input area, the soft key menu of ① is displayed again. (For the procedure for entering a file name, refer to 5.1.12 [DISPLAY] switch.)

\*3 : For an overwrite operation, the soft key menu for verification ( ⑧ ) is displayed.

## 5.1.15 [PROGRAM] switch

Enters and executes programs.

For details of its function, refer to Chapter 6 Program Function.

When this switch is pressed, the soft key menu of ① is displayed.

When the [PROGRAM] switch is pressed:

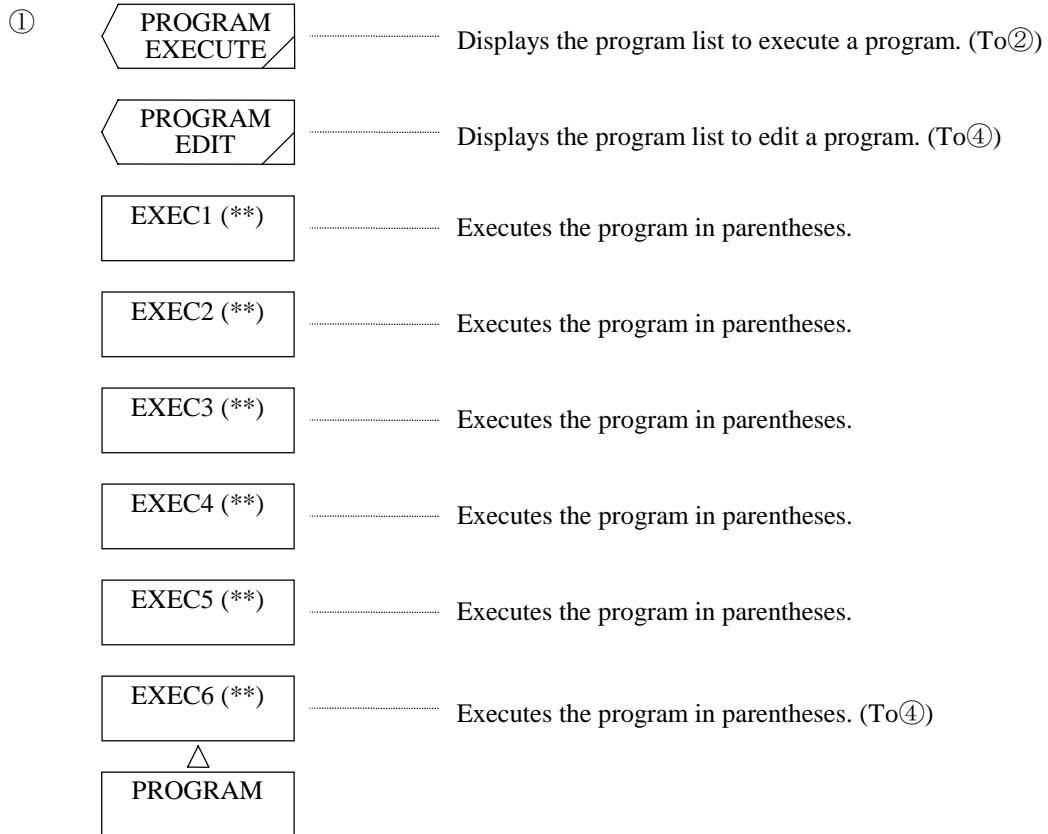



When the <PROGRAM EXECUTE> key is pressed:

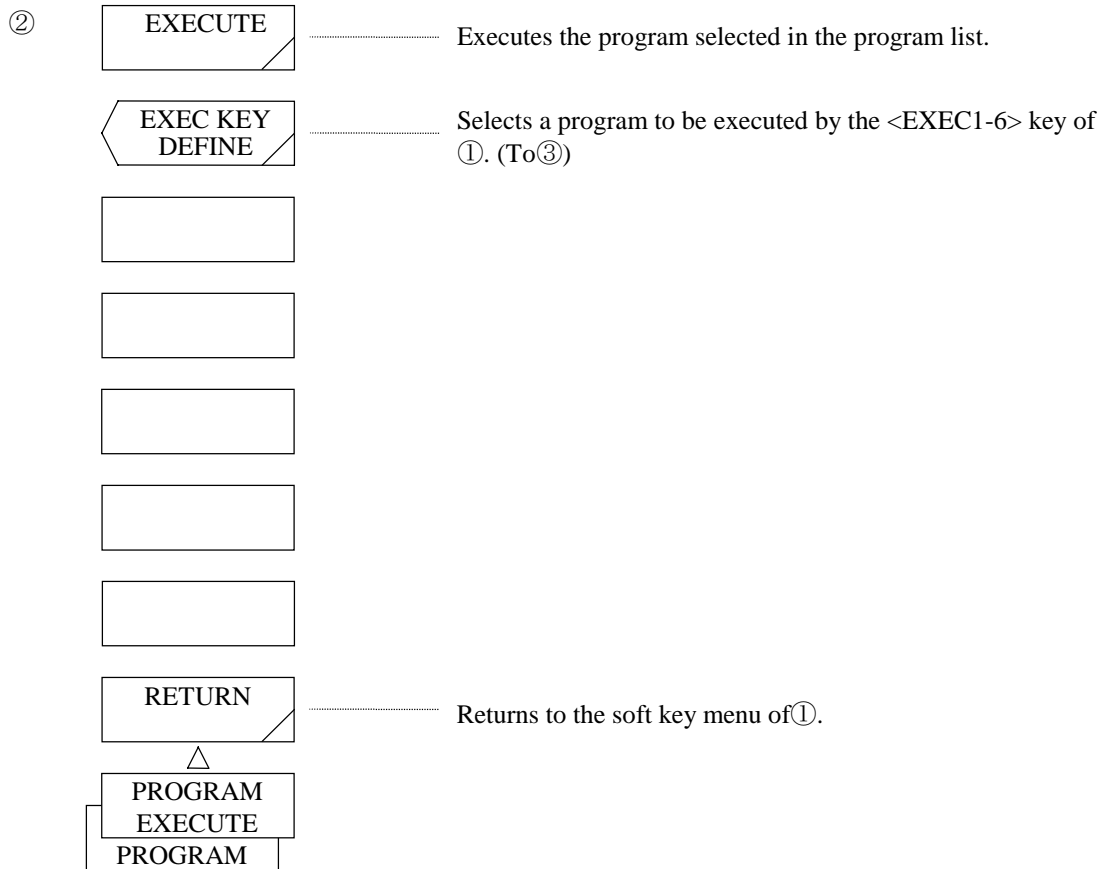

When the <EXEC KEY DEFINE> key is pressed:

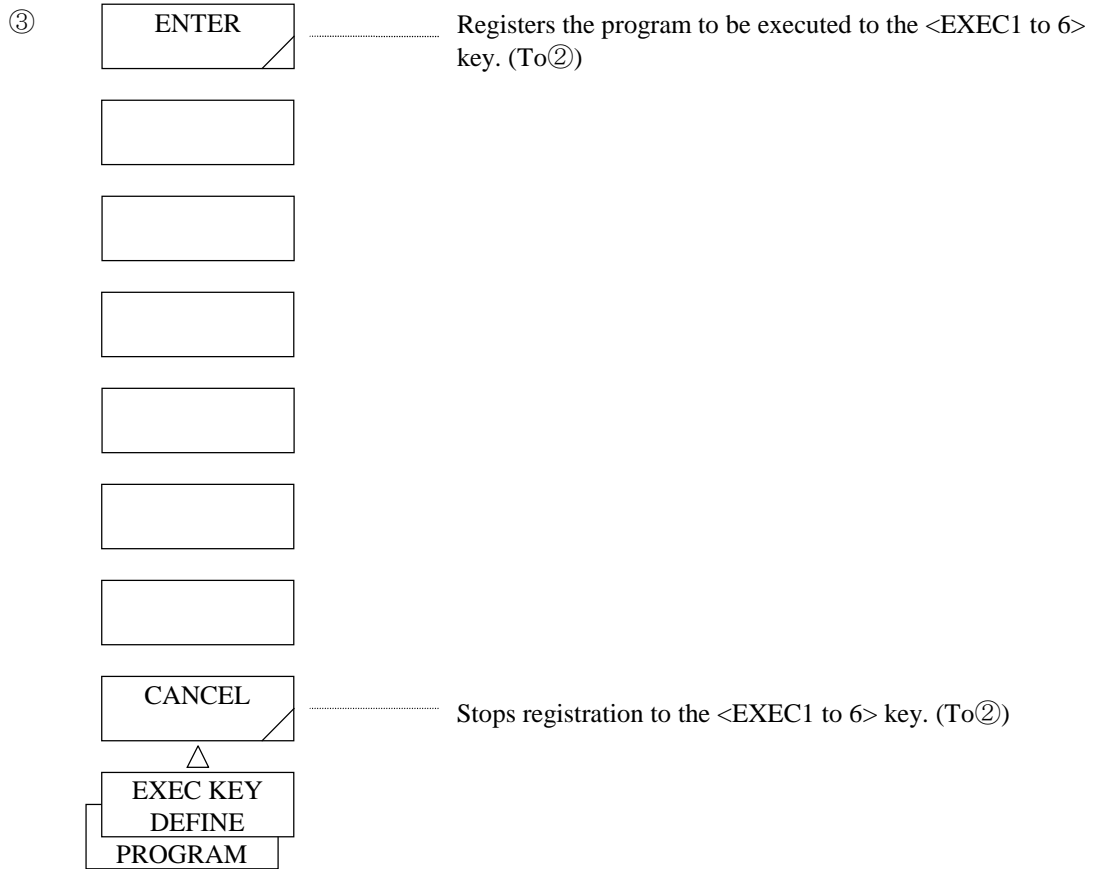

When the <PROGRAM EDIT> key is pressed:

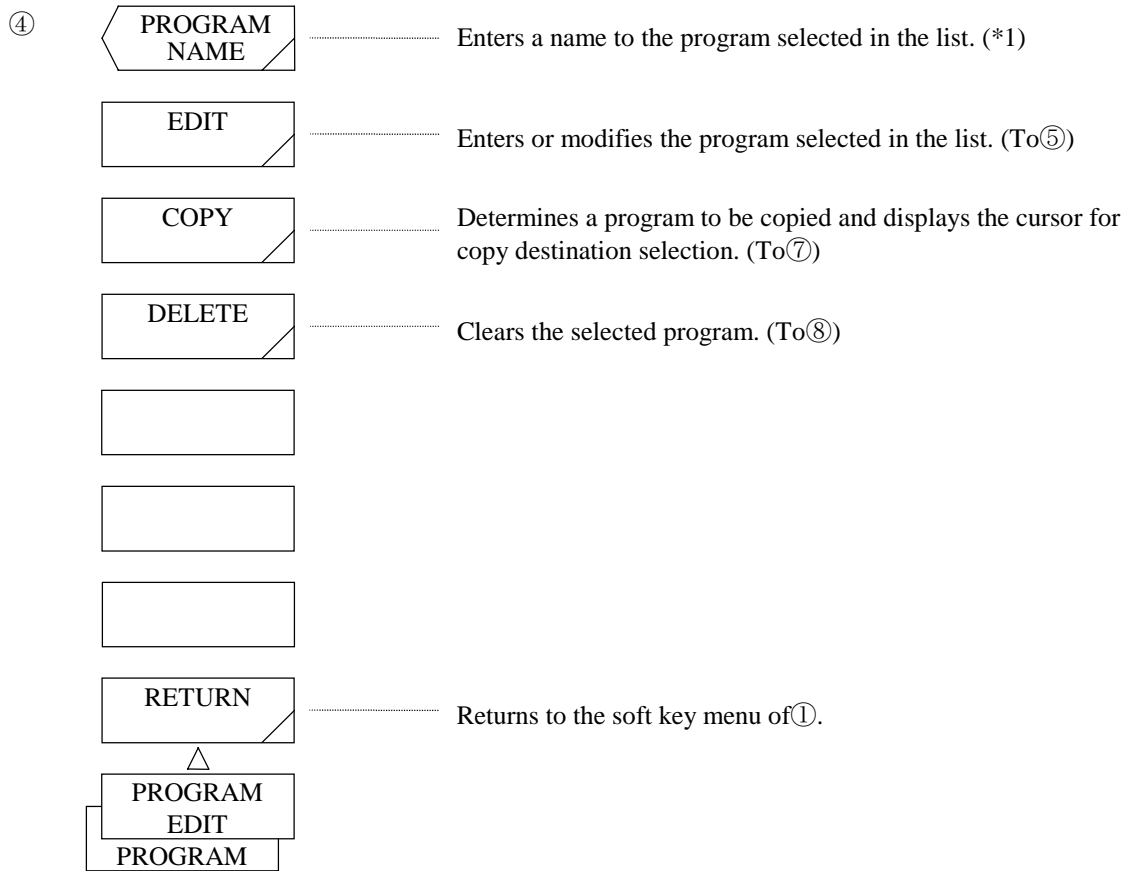

When the <EDIT> key is pressed:

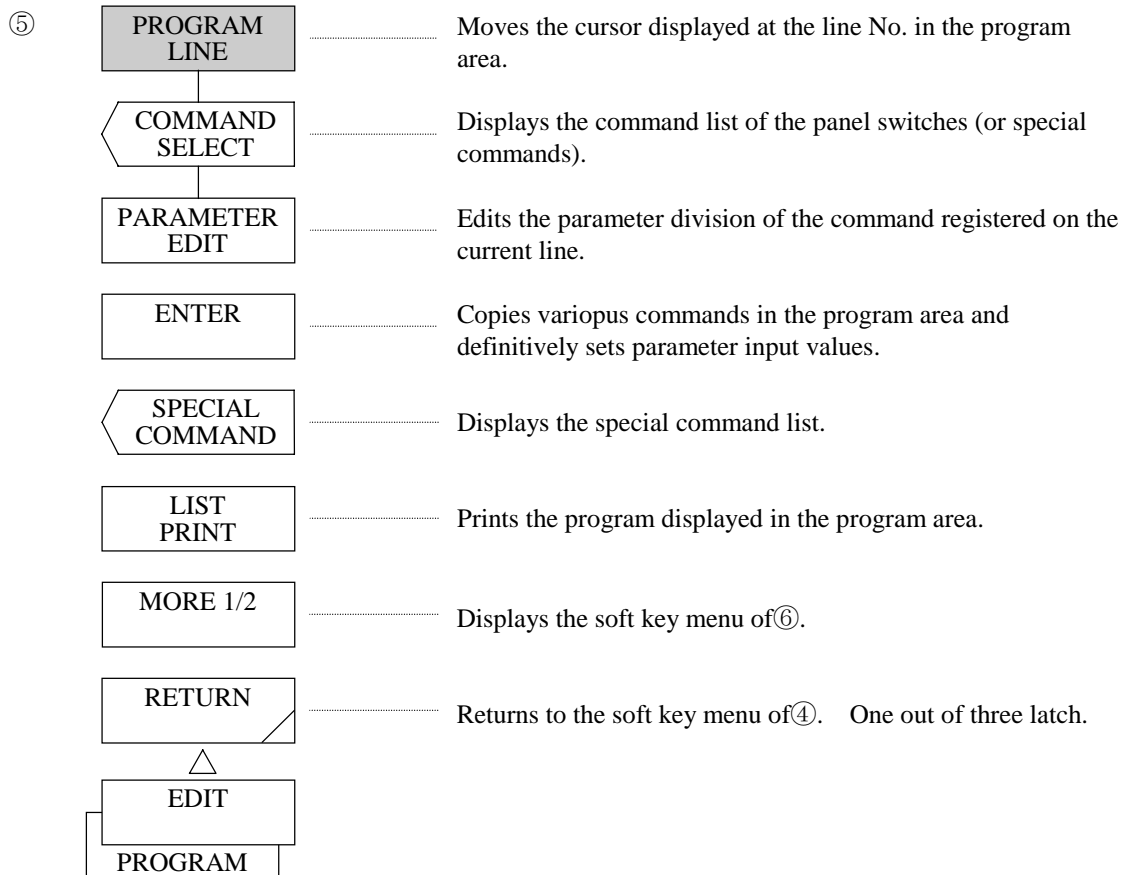

When the <MODE 1/2> key is pressed:

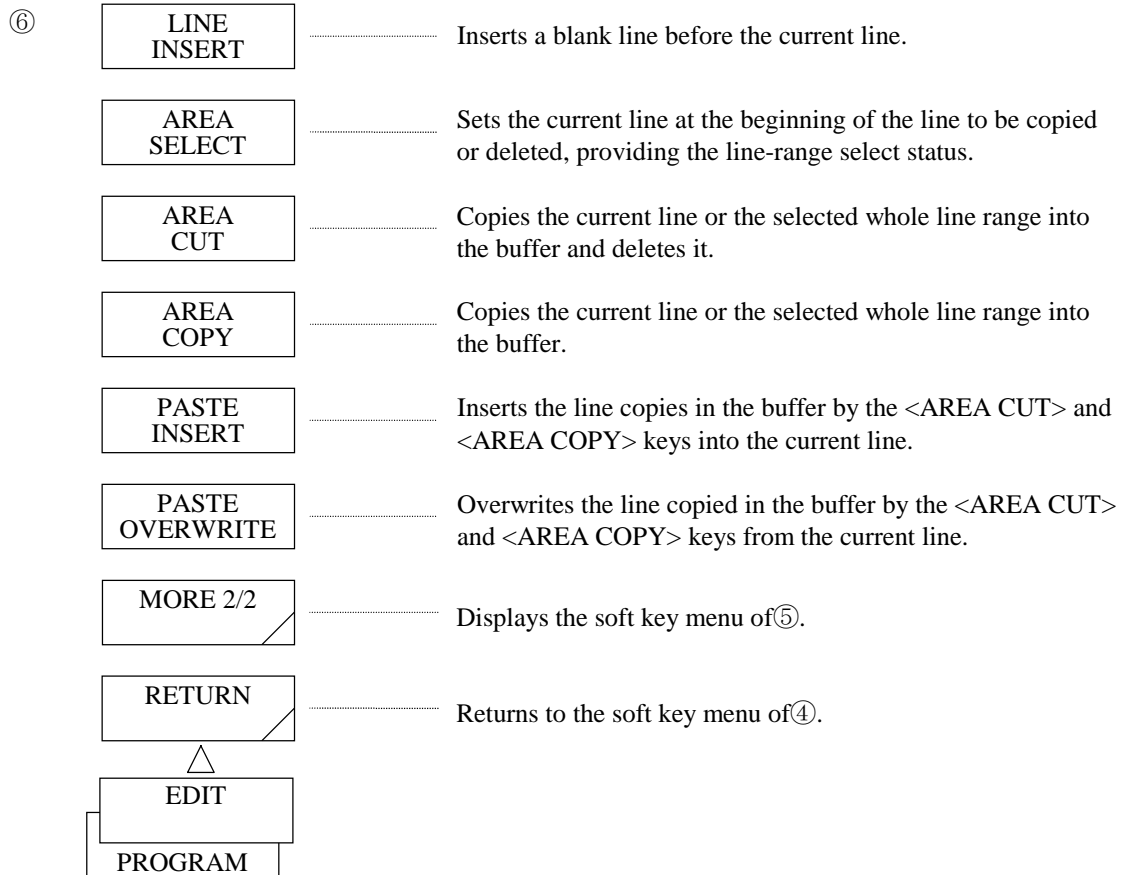

When the <COPY> key is pressed:

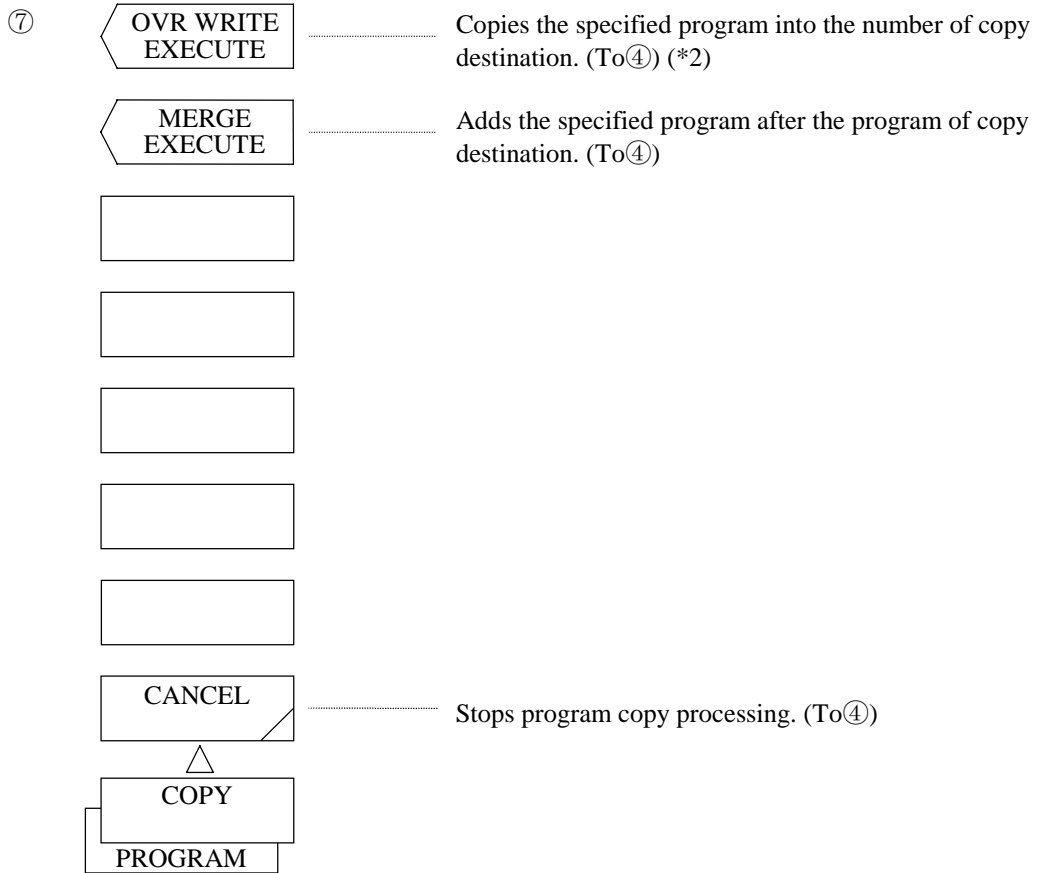

When the <DELETE> key is pressed:

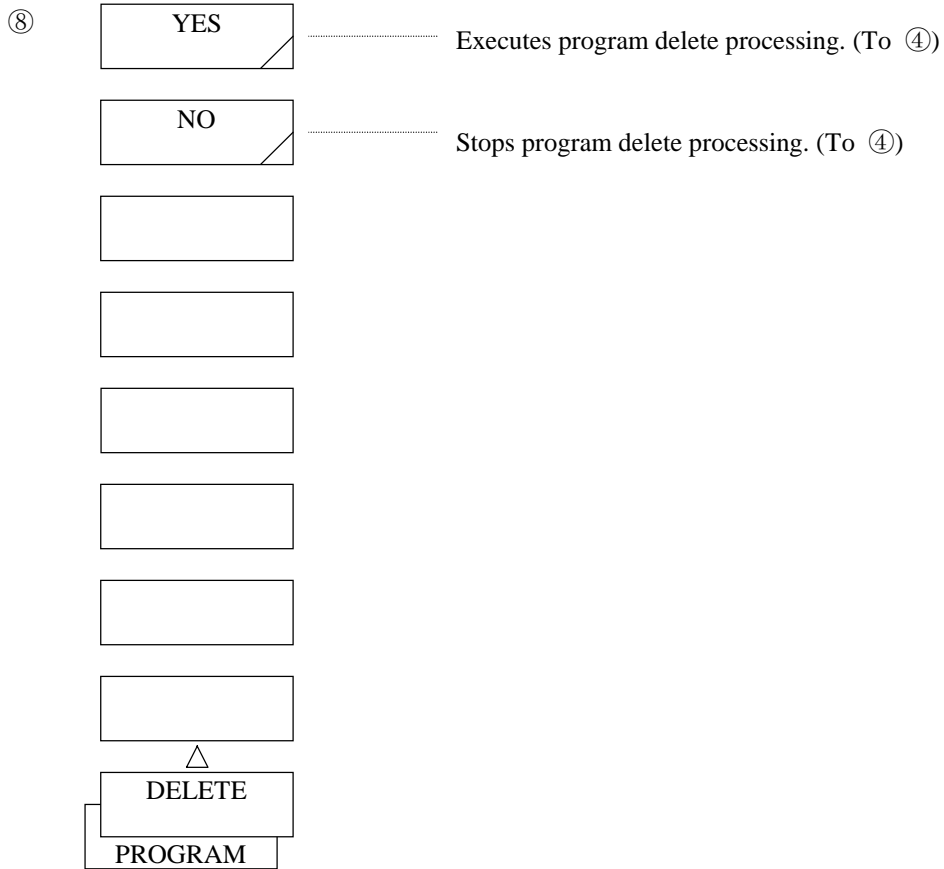

- \*1: When the <PROGRAM NAME> key is pressed, the same soft key menu as the <LABEL> key is displayed and the window for character selection is opened.  
By pressing the <DONE> key after entering a file name into the label input area, the soft key menu of ④ is displayed again. (For the procedure for entering a file name, refer to 5.1.12 [DISPLAY] switch.)*
- \*2: When a program is already registered in the number of copy destination, it is overwritten.  
The program name is changed into the name of copy source.  
After the execution, the soft key menu of ④ is displayed again.*

## 5.1.16 [SYSTEM] switch

Registers printers, X-Y plotters and user keys, and sets date and time, screen display colors and addresses.  
When this switch is pressed, the soft key menu of ① is displayed.

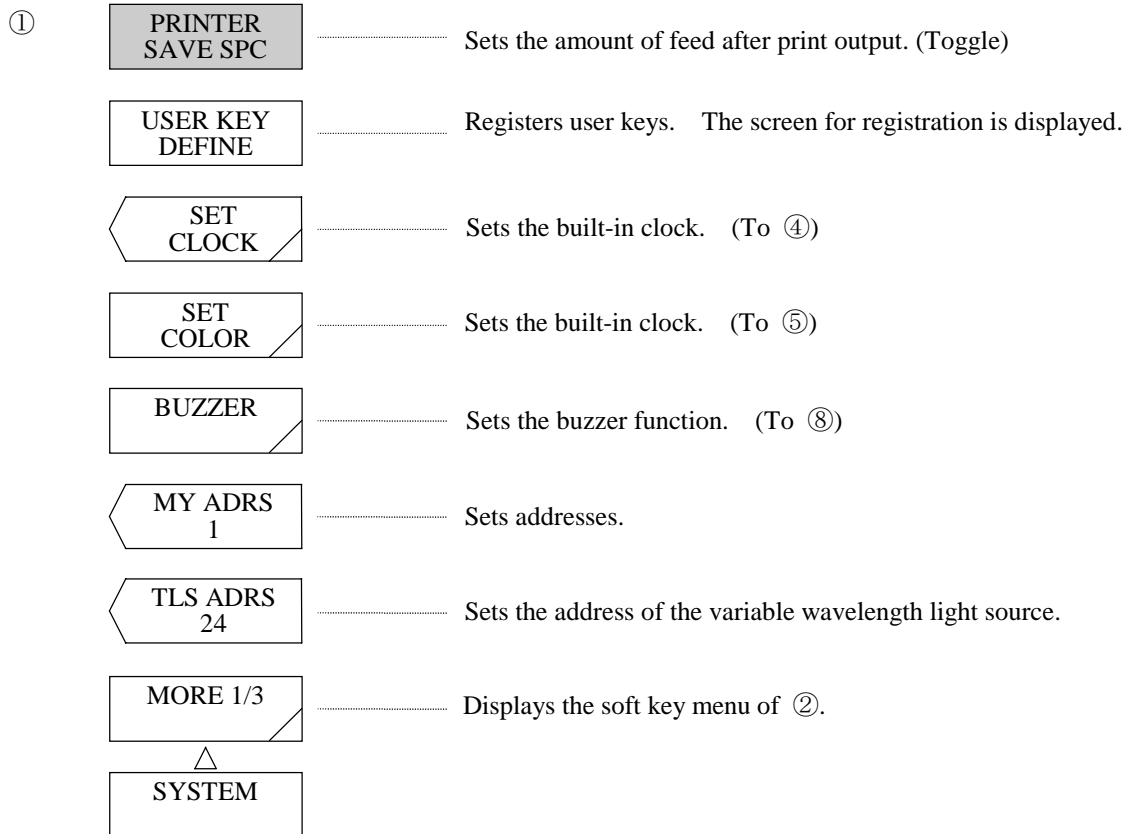



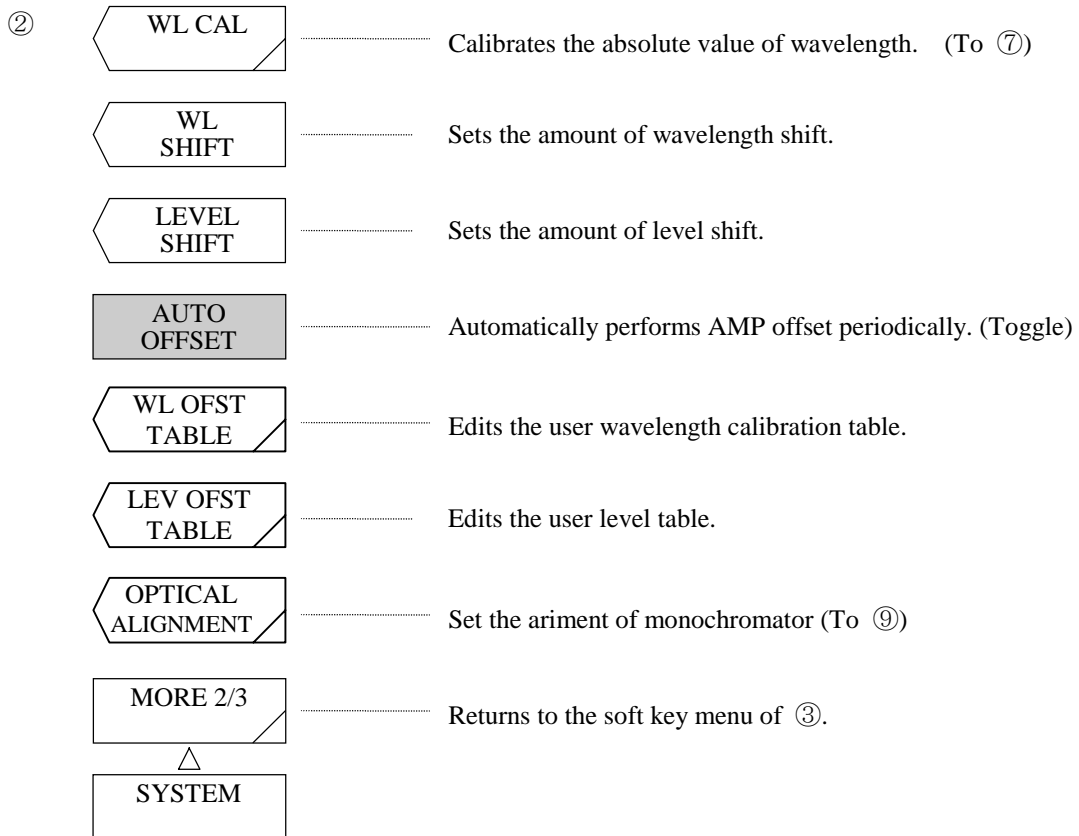

(1) <PRINTER SAVE SPC> key

Sets the amount of paper feed after the screen has been copied by the printer.  
 When this key is pressed, the key is selected and the amount of feed is reduced.  
 If the key is not selected, the amount of normal feed is applied.

(2) <USER KEY DEFINE> key

Registers user keys.  
 When this key is pressed, the screen for registration is displayed.  
 The procedure for registration is shown below.

- a) When the panel switch of the soft key to be registered is pressed, the soft key menu is changed into the corresponding key menu. Soft keys that cannot be registered are not displayed.
- b) When the soft key to be registered is pressed, the soft key pressed in a) is displayed in the registration key display section in the screen is displayed.
- c) In the status where the soft key to be registered is displayed in the registration key display section, press the [USER] switch. With this, the soft key menu is changed into that of the [USER] switch.

- d) In the soft key menu of the [USER] switch, press the key to be registered.  
 Then, the selected soft key is registered as a user key, and also the registration key display section becomes blank.  
 If the user key is already registered, it is overwritten.

To register another soft key, repeat the above operations a) to d).

To terminate the user key register mode, press the auxiliary key <KEY DEFINE DONE>.

With this, the soft key menu of ① is displayed again.

As a rule, the only key that can be registered is the soft key displayed after the panel switch is pressed.

Registration is disabled for the soft key that was pressed next.

Soft keys that cannot be registered are not displayed.

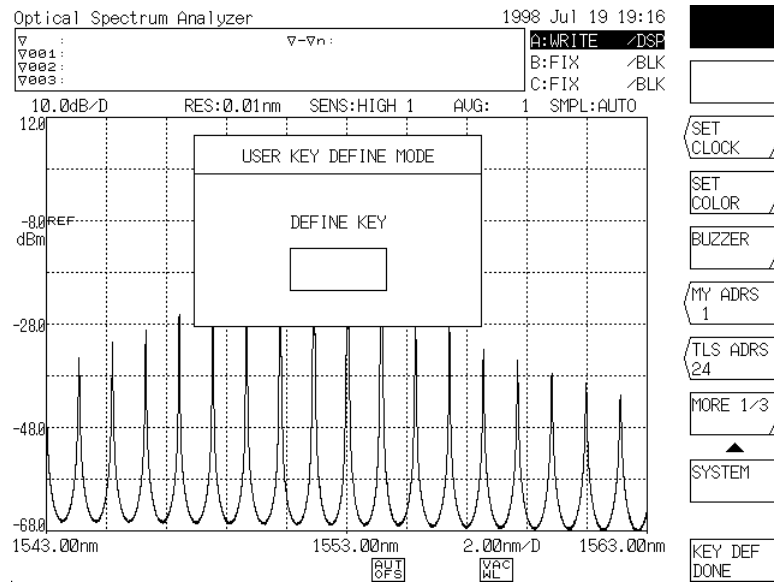

When the <USER KEY DEFINE> key is pressed:

(3) <SET CLOCK> key

Sets the built-in clock.

When this key is pressed, the soft key menu of ④ and a window is displayed.

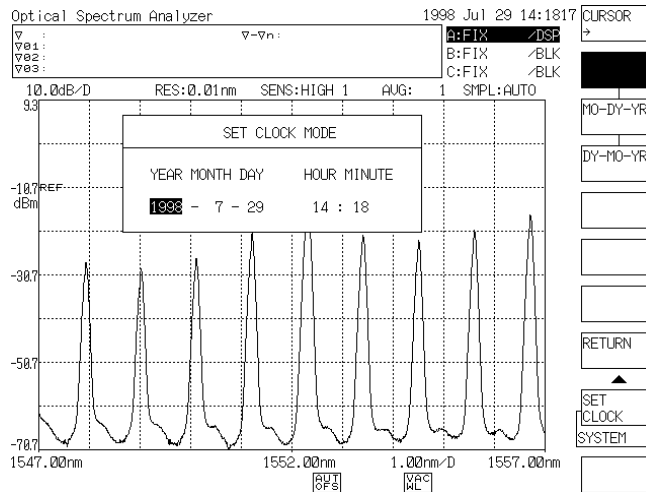

When the <SET CLOCK> key is pressed:

(4) <SET COLOR> key

Sets display colors.

When this key is pressed, the soft key menu of ⑤ is displayed.

(5) <BUZZER> key

Sets the buzzer function. This function determines whether or not to cause the buzzer to sound when a hard key or soft key is pressed or WARNING is displayed. When this key is pressed, the soft key menu of ⑧ is displayed.

(6) <MY ADRS> key

Sets the GPIB address of this equipment.

When this key is pressed, the current set value is displayed in the interrupt display section.

The set value can be changed in the range of 0 to 30 by the rotary knob, step keys or ten-key pad.

This key sets the address of the first port. About the address of second port, please set <GP-IB2 ADR> key.

(7) <TLS ADRS> key

Sets the address of the variable wavelength light source connecting to the port "GP-IB2".

When entry of the setting has been made, the current address appears in the interrupt indication section.

The address can be changed within the range of 0 through 29 (1 step) using the rotary knob, step keys or numeric keys.

\*: *This function is used only for switching of measurement wavelength. Even if <MEAS WL AIR VAC> key is executed for waveform being displayed after measurement, switching of wavelength does not take place.*

(8) <WL CAL> key

Calibrates the wavelength. When this key is pressed, the window containing a message is displayed on the screen and the soft key menu of ⑦ is displayed. (\*).

As calibration steps, connect the laser for calibration to this equipment by single mode fiber cable and then press the corresponding soft key or change the set value displayed in the interrupt display section by the rotary knob, step keys or ten-key pad.

When the EXECUTE key is pressed, the absolute value of wavelength is calibrated with the selected or set wavelength.

The set value can be changed in the range of 350.000 to 1750.000 nm.

If the used laser is not in the range of  $\pm 5$  nm to the set value, the absolute value is not calibrated.

\*: *The soft key menu of ⑦ indicates the wavelength bands of helium-neon laser, etc. Accordingly, to calibrate the absolute value by the light source of displayed wavelength, use the soft key. However, in the soft key menu, wavelength is displayed either in air wavelength or vacuum wavelength depending on the setting on 5.1.7 (10) <MEAS WL AIR VAC> key.*

If the key is not found in the soft key menu, set the set value in the interrupt display section to the wavelength of the light source and calibrate the absolute value.

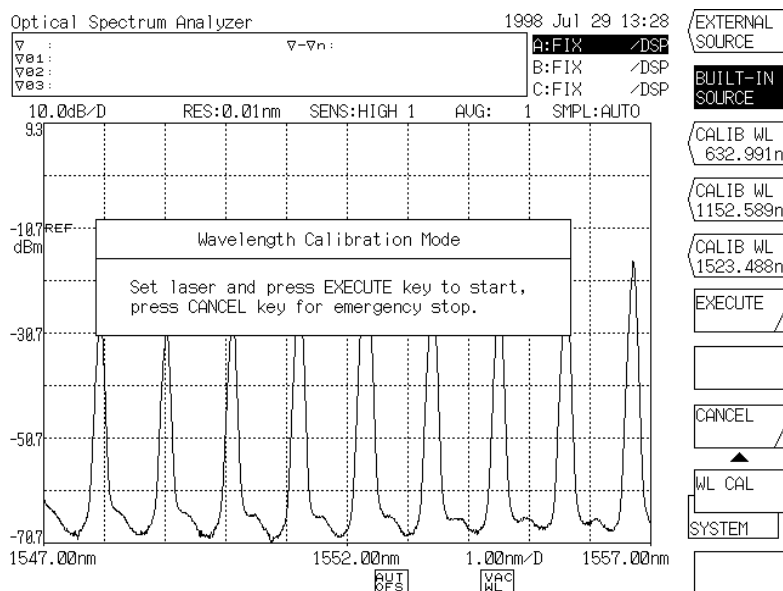

When the <WL CAL> key is pressed:

## CAUTION

- *In the following cases, wavelength calibration is disabled.*
  - 1) *The level of the light source for calibration is less than  $-30$  dBm.  
(For the external light source)*
  - 2) *There is a difference between the light source for calibration and the set wavelength.*
  - 3) *The wavelength error of this equipment exceeds  $\pm 5$  nm.  
In the case of 3), readjustment is required. Please ask us to make this readjustment.*
- *Do not use this function to intentionally change the display wavelength. To do so, use the <WL SHIFT> key.*

## NOTE

*This function performed calibration for the whole wavelength area when offset is applied to the grading angle so that the error of the wavelength to be calibrated may be zero.*

*Accordingly, multiple wavelengths are not required for calibration. If multiple wavelengths have been calibrated, only the last calibration becomes effective.*

(9) <WL SHIFT> key

Sets the amount of wavelength shift.

When this key is pressed, the current set value is displayed in the interrupt display section.

The set value can be changed in the range of  $-5.000$  to  $5.000$  nm (0.001 step) by the rotary knob, step keys or ten-key pad.

After the amount of wavelength shift is set, the set value is added to the displayed value of wavelength axis.

This key is used to compensate differences in displayed wavelength wave among multiple measuring instruments.

When the offset value is not 0,  is displayed at the bottom of the screen.



(10) <LEVEL SHIFT> key

Sets the amount of level shift.

When this key is pressed, the current set value is displayed in the interrupt display section. The set value can be changed in the range of  $-60.00$  to  $60.00$  dBm (0.01 step) by the rotary knob, step keys or ten-key pad.

After the amount of level shift is set, the set value is added to the displayed value of the level axis.

This key is used to compensate the loss of the isolator or filter connected to an external circuit.

When the offset value is not 0,  is displayed at the bottom of the screen.



(11) <AUTO OFFSET> key

Sets whether or not to make an automatic offset adjustment for the AMP circuit.

When the <AUTO OFFSET> key is selected, an offset adjustment is periodically made for the internal AMP circuit.

When this key is not selected, no automatic offset adjustment is made. If this key is pressed in the unselected status, the key is selected and an offset adjustment is executed (immediately). After that, an automatic offset adjustment is made periodically.

### CAUTION

*If this key is kept in the unselected status, low input level waveforms becomes inaccurate when the measuring sensitivity is NORMAL (NORM RANG HOLD, NORM RANG AUTO).*

*Usually, use it in the selected status.*

(12) <WL OFST TABLE> key

Edits the user wavelength calibration table.

When this key is pressed, the wavelength calibration table and the soft key menu are displayed.

Usually, this function needs not to be used.

(13) <LEV OFST TABLE> key

Edits the user level calibration table.

When this key is pressed, the level calibration table and the soft key menu are displayed.

Usually, this function needs not to be used.

(14) <OPTICAL ALIGNMENT> key

The <OPTICAL ALIGNMENT> key is used for adjusting optical axis of monochromator optical system employed on this unit.

The light source used must be the standard light source installed on the unit. After powering on and before starting the adjustment, it is recommended to wait for approximately 1 hour for warming up.

As you press this key, the software menu ⑨ will appear.

Implement the alignment in the following procedure:

- i . Connect the optical input and output connectors on the unit using 10/125  $\mu$  m SM fiber.
- ii . Press the <EXECUTE> software key on the software menu ⑨.
- iii . Adjustment of the optical axis will be automatically executed. As the adjustment is complete after one minute, the original screen is restored.

### CAUTION

*When the unit is used for the first time or used again after being exposed to significant Vibrations, make sure to warm it up first and then implement the alignment function Prior to the operation.*

③

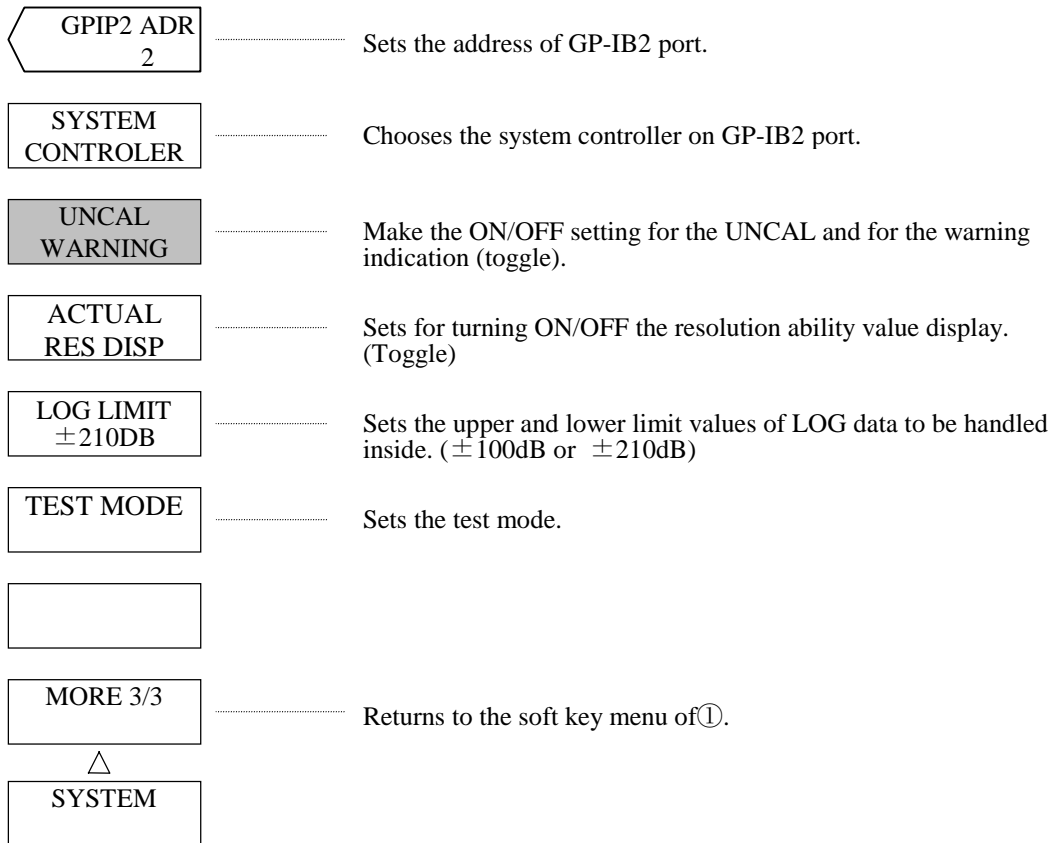

(15) <GP-IB2 ADR> key

This key sets the address of GP-IB2 port.

When this key is pressed, the current address is displayed in the interrupt display section.

The set value can be changed in the range of 0 to 30 by the rotary knob, step keys or ten-key pad.

(16) <SYSTEM CONTROLER> key

This key selects whether or not the GP-IB2 port is a system controller.

In the ON state, this equipment controls the peripheral device connected to GP-IB2 port, that is also set to default.

When <SYSTEM CONT> is OFF, the computer connected to GP-IB1 port controls directly the peripheral device. The connections and program are different for the OFF state.

The details of the connections and program are separate to this manual and can be obtained by contacting the head-office directly.

(17) <UNCAL WARNING> key

Make the ON/OFF setting for the UNCAL mark and for the warning indication.

Each time this key is pressed, select and select clear are repeated alternately.

When this key is being set to the "select" side, the UNCAL mark and the warning indication will appear.

(18) <ACTUAL RES DISP> Key

While this key is selected, the resolution ability value in setting the present center wavelength is displayed on the interrupt display with the <RESOLN> key for [SETUP].

Display example -----RES 0.02 nm

(0.014 nm) ← Resolution ability value in setting the present center wavelength.

(19) <LOG LIMIT> Key

Sets the upper and lower limit values of LOG data to be handled inside.

Either of the two values ±210dB and ±100dB can be set.

(20) <TEST MODE> key

Set the test mode.

This key is used when this equipment is adjusted at plant, and is generally unusable.

When this key is pressed, the window for password setting is displayed but can be cleared by pressing another soft key or switch.

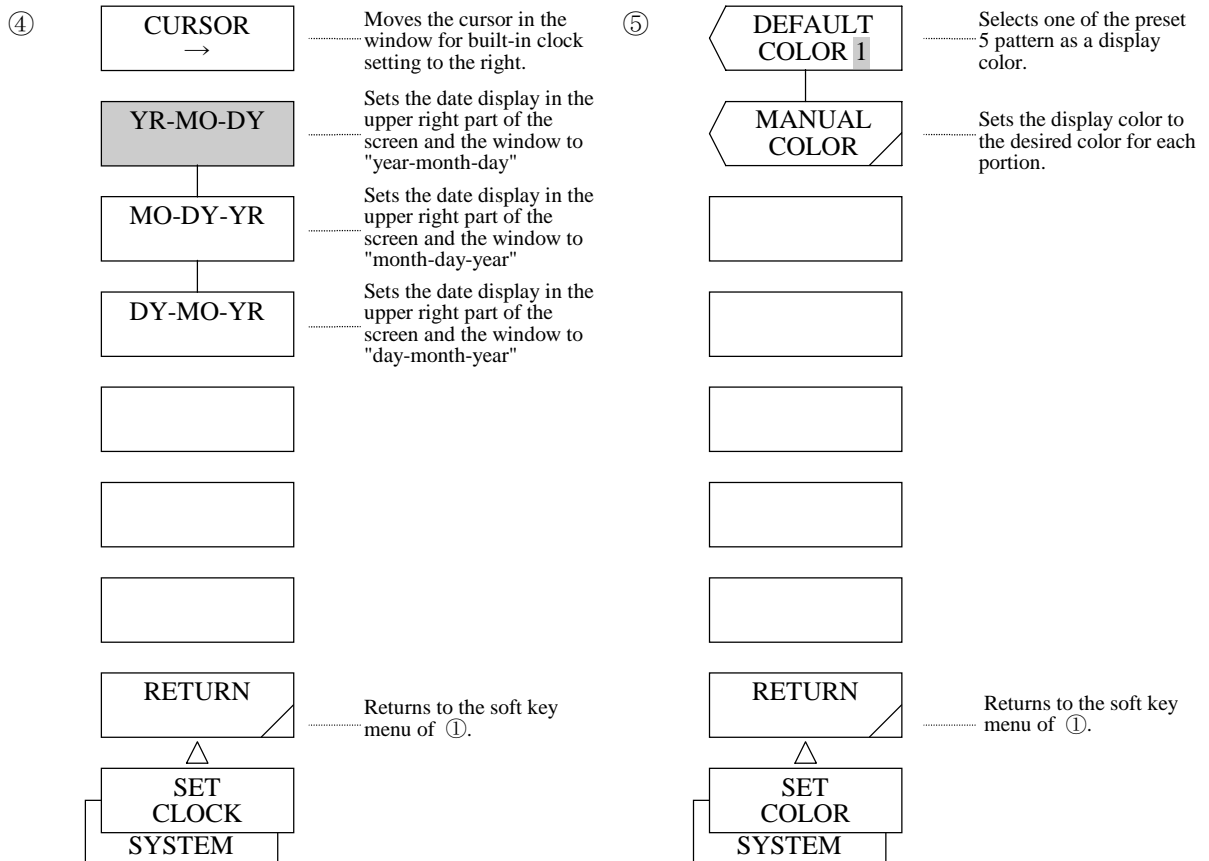

(21) <CURSOR →> key

Moves the cursor in the window displayed by the <SET CLOCK> key to the right.

(When the cursor is at the right end, it is moved to the left end.)

(22) <YR – MO – DY> key

Sets the date display method in the upper right part of the screen and the window to "year-month-day".



- (23) <MO – DY – YR> key  
Sets the date display method in the upper right part of the screen and the window to "month-day-year".
- (24) <DY – MO – YR> key  
Sets the date display method in the upper right part of the screen and the window to "day-month-year".
- (25) <RETURN> key (SET CLOCK)  
Clears the window and returns to the soft key menu of ①.
- (26) <DEFAULT> key  
Selects one of the preset 5 patterns as a display color.  
When this key is pressed, the current set value is displayed in the interrupt display section.  
The set value can be changed in the range of 1 to 5 by the rotary knob, step keys or ten-key pad.
- (27) <MANUAL COLOR> key  
Sets the display color to the desired color.  
Color setting can be performed for each portion.  
When this key is pressed, the soft key menu of ⑥ and the window for color setting by RGB video signals are displayed. In the soft key menu of ⑥, specify the portion to be changed (one out of twelve). The ratio of R (red)/G (green)/B (blue) in the window for color setting in the range of 0 to 7 by the rotary knob, step keys or ten-key pad. A total of 512 combinations can be displayed. As soon as the setting is changed, the color is changed.

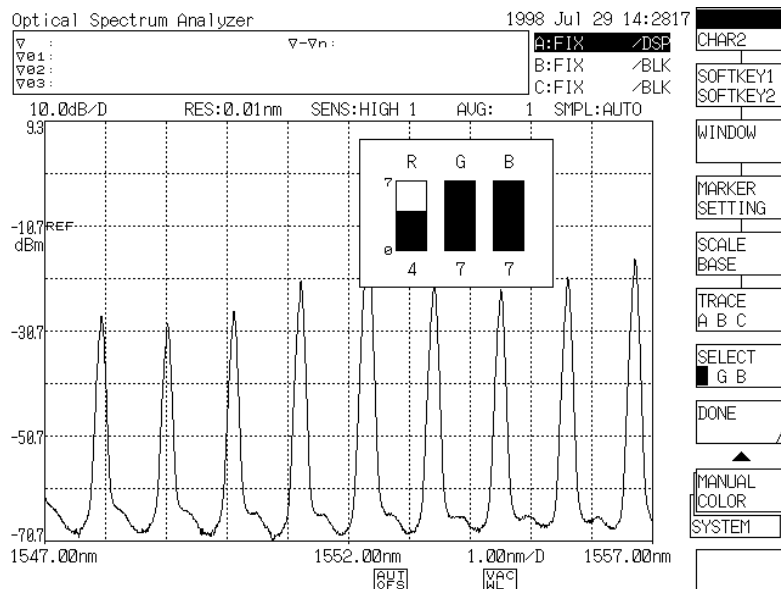

When the <MANUAL COLOR>key is pressed:

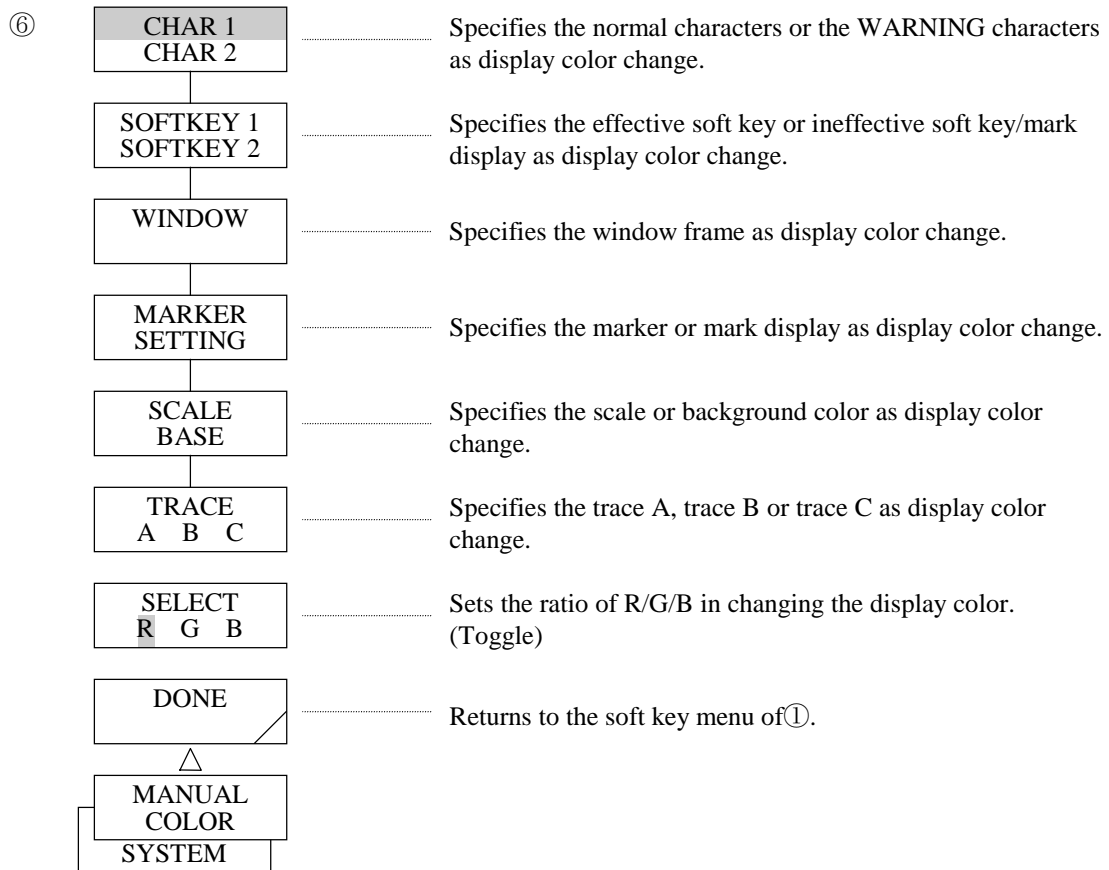

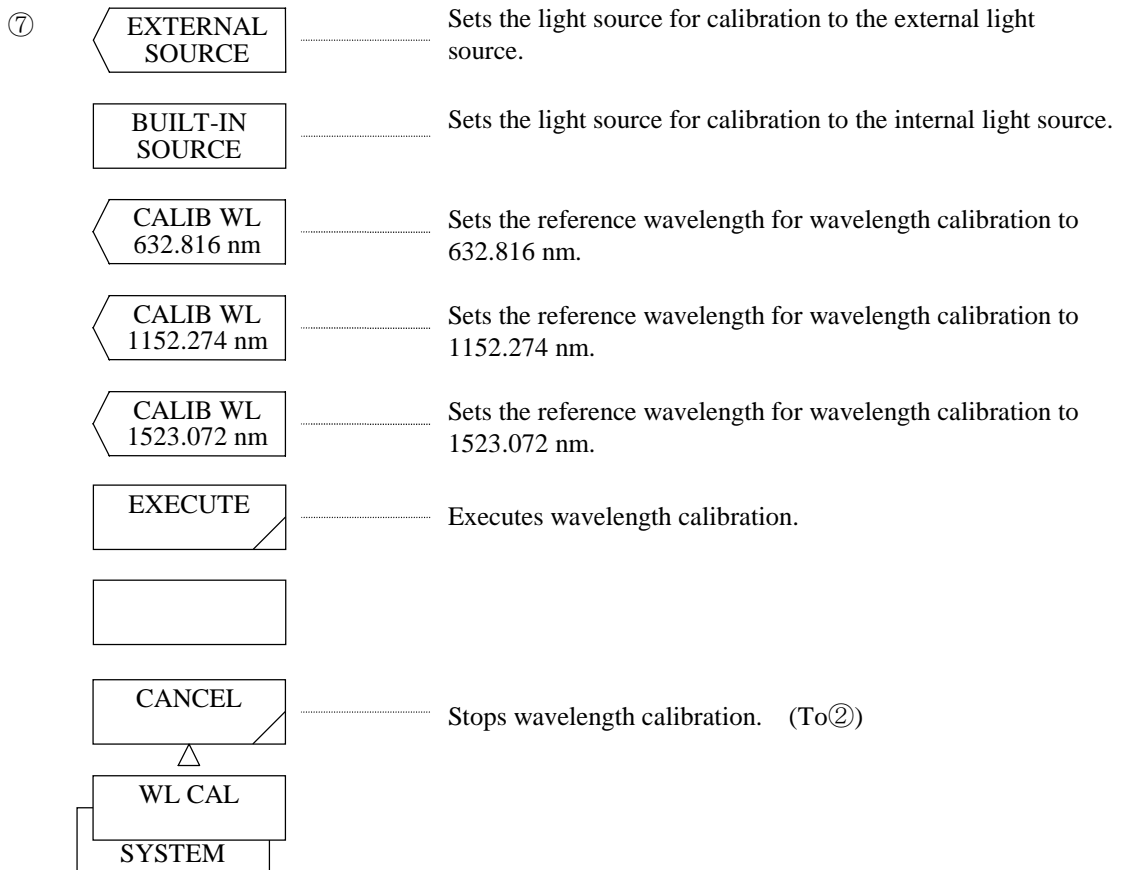

(28) <CHAR 1 CHAR 2> key

Specifies the normal characters or WARNING characters as display color change.

When this key is pressed, the display in reverse video is switched between "CHAR1" and "CHAR 2".

When "CHAR 1" is selected, the normal character color is specified.

When "CHAR 2" is selected, the WARNING character color is specified.

(29) <SOFTKEY 1 SOFTKEY 2> key

Specifies the effective soft key, ineffective soft key or mark display at the ineffective time as display color change.

When this key is pressed, the display in reverse video is switched between "SOFTKEY 1" and "SOFTKEY 2".

When "SOFTKEY 1" is selected, the effective soft key color is specified.

When "SOFTKEY 2" is selected, the ineffective soft key or mark display at the ineffective time is specified.

(30) <WINDOW> key

Specifies the window frame as display color change.

Each time this key is pressed, select and select clear are repeated alternately.

When this key is selected, the window frame color is specified.

- (31) <MARKER SETTING> key  
Specifies the marker or mark display as display color change.  
When this key is pressed, the display in reverse video is switched between "MARKER" and "SETTING".  
When "MARKER" is selected, the marker color is specified.  
When "SETTING" is selected, the mark display color is specified.
- (32) <SCALE BASE> key  
Specifies the scale or background color as display color change.  
When this key is pressed, the display in reverse video is switched between "SCALE" and "BASE".  
When "SCALE" is selected, the scale color is specified.  
When "BASE" is selected, the background color is specified.
- (33) <TRACE A B C> key  
Specifies the trace A, B or C as display color change.  
When this key is pressed, the display in reverse video is changed in rotation in the order of "TRACE A", "TRACE B", "TRACE C" and "TRACE A".  
When "TRACE A" is selected, the trace A color is specified.  
When "TRACE B" is selected, the trace B color is specified.  
When "TRACE C" is selected, the trace C color is specified.
- (34) <SELECT R/G/B> key  
Sets the ratio of R/G/B in changing the display color.  
When this key is pressed, the display in reverse video is changed in rotation in the order of "SELECT R", "SELECT G", "SELECT B", "SELECT R", and the display in reverse video in the parameter section (R/G/B) in the window for color setting moves.  
When "SELECT R" is selected, Red is specified.  
When "SELECT G" is selected, Green is specified.  
When "SELECT B" is selected, Blue is specified.
- (35) <DONE> key  
Returns to the soft key menu of ①.
- (36) <EXTERNAL SOURCE> key  
Sets the light source for wavelength calibration to the external light source.
- (37) <BUILT-IN SOURCE> key  
Sets the light source for wavelength calibration to the internal light source.

(38) <CALIB WL \*\*\*\*.\*\*\* n> key

Sets reference wavelength used for wavelength calibration to \*\*\*\*.\*\*\*nm. (\*\*\*\*.\*\*\* represents wavelength value shown in the soft key menu.) Interrupt display section ~~(window)~~ reference wavelength being set to \*\*\*\*.\*\*\*nm. To change the setting, set reference wavelength to wavelength of light source by pressing another soft key or using the rotary knob, step keys or ten-key.

Wavelength calibration is available both in air wavelength or vacuum wavelength.

Therefore, wavelength shown in the soft key menu varies depending on which setting is selected.

Prior to the calibration, either air wavelength or vacuum wavelength must be selected and its setting must be done accordingly using above mentioned 5.1.7 (10) <MEAS WL AIR VAC> key (→P. 5-107).

Wavelength shown in the soft key menu varies according to the mode used.

Air wavelength mode	Vacuum wavelength mode
632.816	632.991
1152.274	1152.589
1523.072	1523.488

(39) <EXECUTE> key

Executes wavelength calibration with the set wavelength.

During the execution, the window is continuously displayed and this key is displayed in reverse video.

After completion of wavelength calibration, the window disappears and the soft key menu of ② is displayed again.

At this time, the screen displays the waveforms precedent to pressing the <WL CAL> key.

If execution could not be attained, WARNING is displayed.

(40) <CANCEL> key

After completion of wavelength calibration, the window disappears and the soft key menu of ② is displayed again.

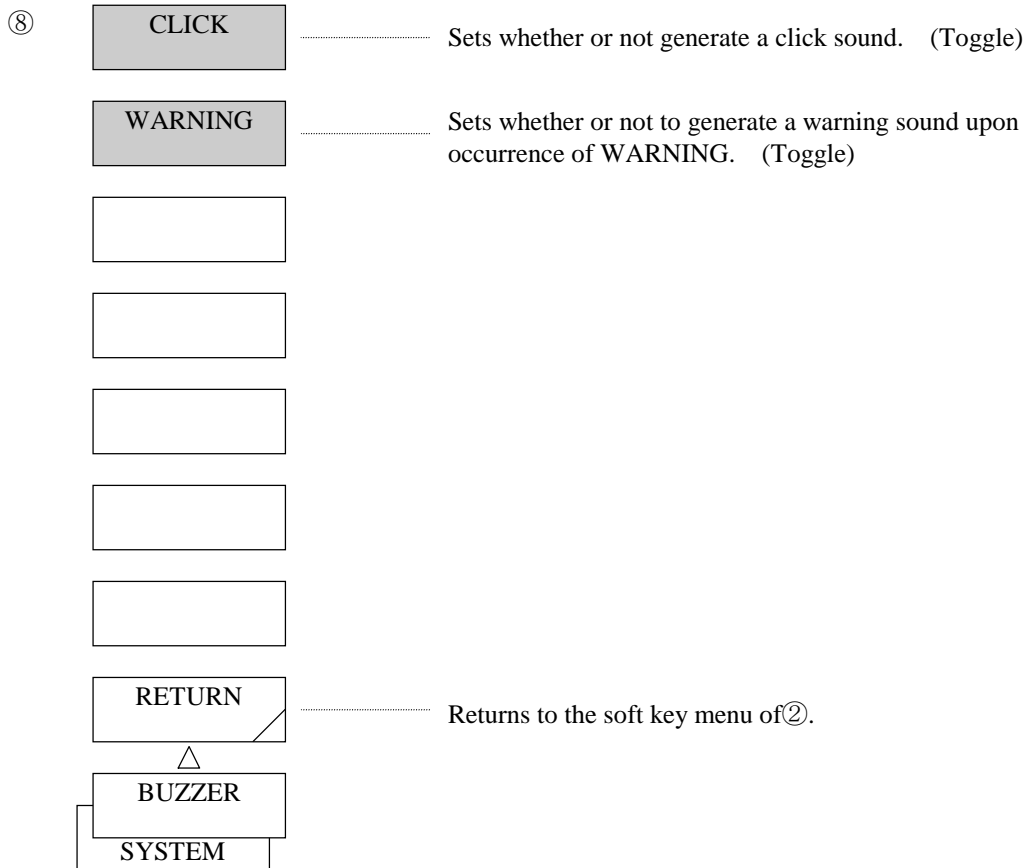

(41) <CLICK> key

Sets whether or not to generate a click sound when a panel switch or soft key is pressed.  
 Each time this key is pressed, select or select clear is repeated alternately.  
 When this key is selected, click sound generation is set.

(42) <WARNING> key

Sets whether or not to generate a warning sound upon occurrence of WARNING etc.  
 Each time this key is pressed, select or select clear is repeated alternately.  
 When this key is selected, warning sound generation is set.

(43) <RETURN> key (BUZZER)

Returns to the soft key menu of ②.

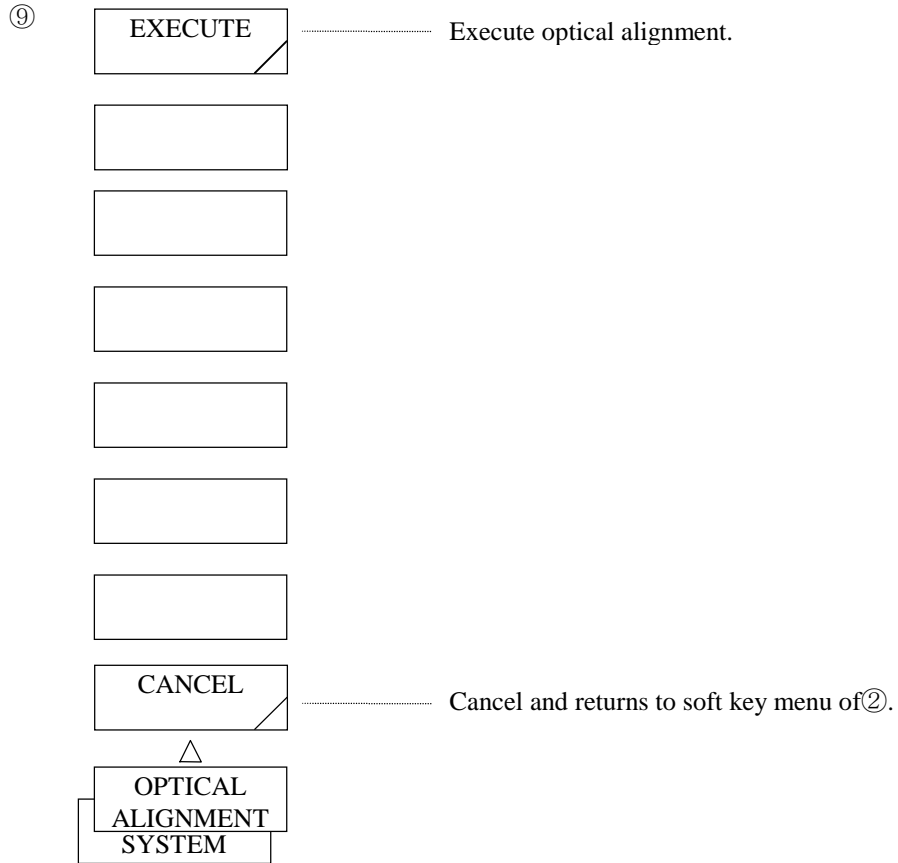

- (44) <EXECUTE> key  
Executes an optical alignment.  
During the execution, the window is continuously displayed and this key is displayed in reverse video.  
After completion of wavelength calibration, the window disappears and the soft key menu of ② is displayed again.
- (45) <CANCEL> key  
Cancel an optical alignment.  
The window disappears and the soft key menu of ② is displayed again.

### 5.1.17 [ADVANCE] switch

This switch executes the power meter function and long term function.

When this switch is pressed, the soft key menu of 1 is displayed.

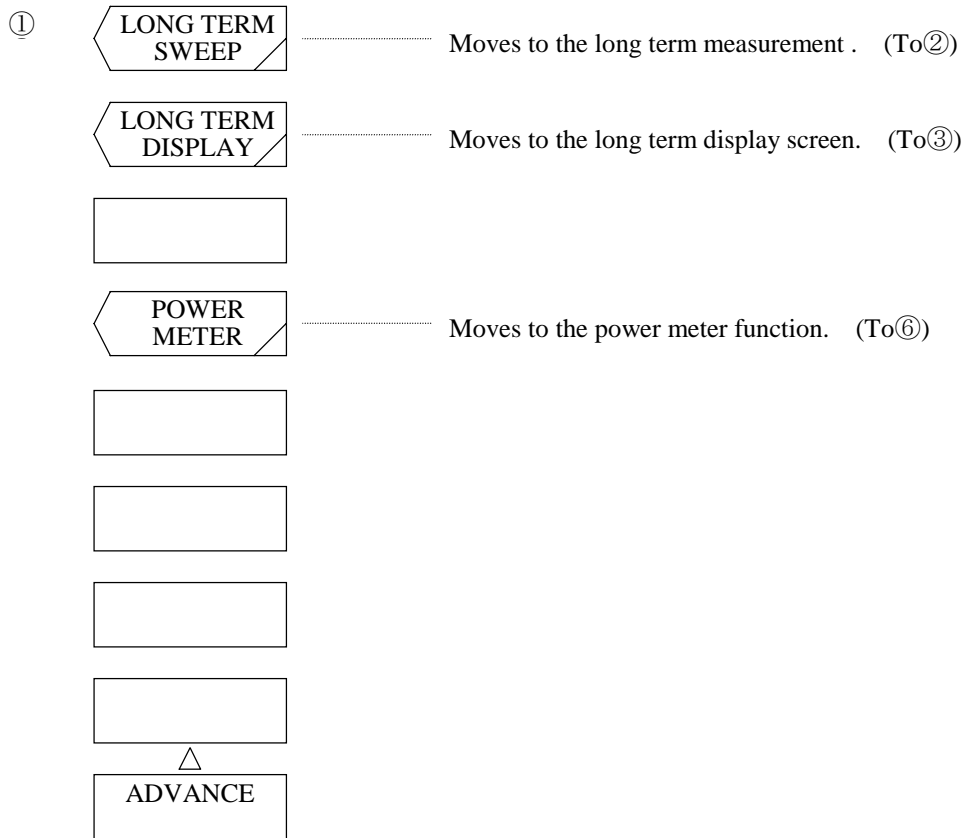



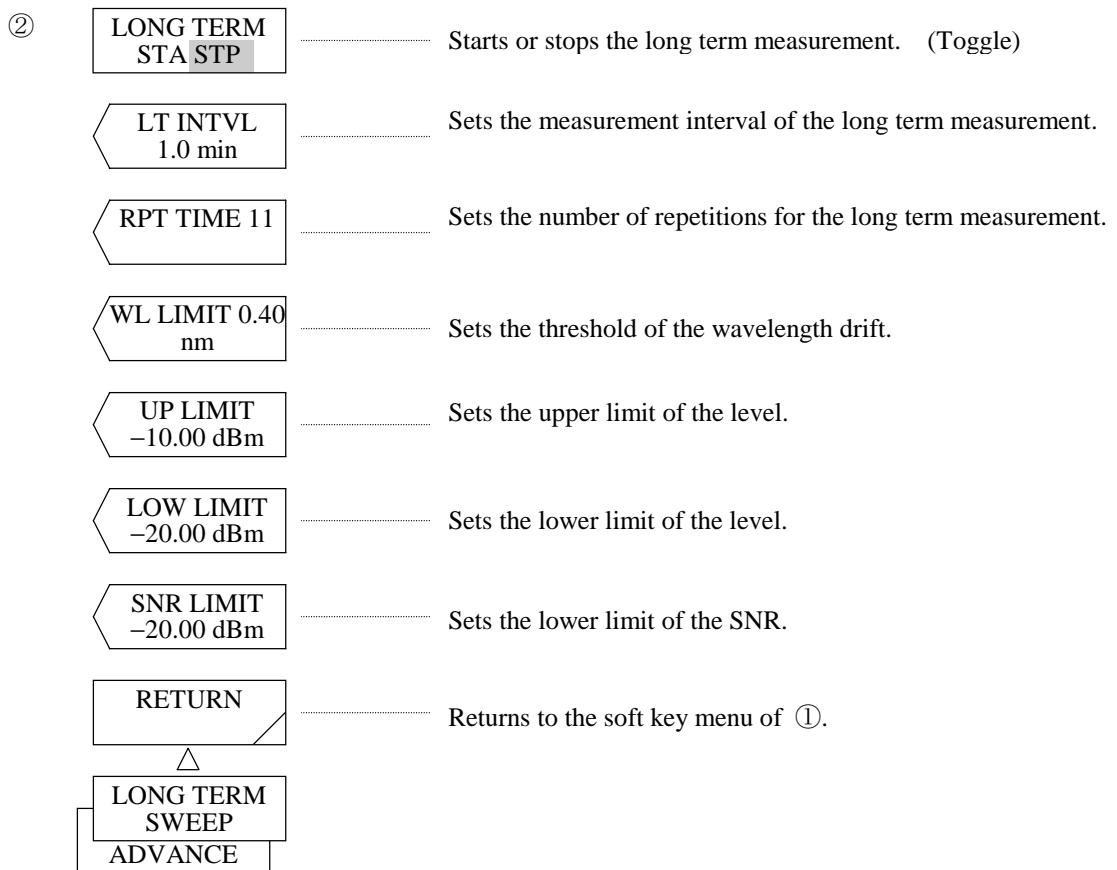

- (1) <LONG TERM SWEEP> key  
 Moves to the long term measurement function.  
 When this key is pressed, the window and the soft key menu of ② are displayed.  
 For details of the long term measurement function, see Section 5.5.
- (2) <LONG TERM DISPLAY> key  
 Moves to the long term measurement result screen.  
 When this key is pressed, the window and the soft key menu of ③ are displayed.
- (3) <POWER METER> key  
 Moves to the power meter function.  
 When this key is pressed, the window and the soft key menu of ④ are displayed.  
 For details of the power meter function, see Section 5.2.2.
- (4) <LONG TERM STA STP> key  
 Selects the start or end of the long term measurement.  
 STA : Starts the long-term measurement.  
 STP : Stops the long term measurement.

- (5) <LT INTVL> key  
Sets the measurement interval of the long term measurement.  
When this key is pressed, the current measurement interval is displayed in the interrupt display section.  
The settable range is set to 0.1 to 9999.9 min (in 0.1 step) by using the rotary knob, step keys, or ten-key pad.
- (6) <RPT TIME> key  
Sets the number of repetitions for the long term measurement.  
When this key is pressed, the current number of measurement times is displayed in the interrupt display section.  
The settable range is set to 1 to 1,000 times (in 1 step) by using the rotary knob, step keys, or ten-key pad.
- (7) <WL LIMIT> key  
Sets the threshold of the wavelength drift.  
When this key is pressed, the current threshold is displayed in the interrupt display section.  
The settable range is set to 0.00 to 99.99 nm (in 0.01 step) by using the rotary knob, step keys, or ten-key pad.  
In the measurement result of LONG TERM, if the wavelength shift of each channel exceeds this value, the measurement result is displayed in red.
- (8) <UP LIMIT> key  
Sets the upper limit of the level.  
When this key is pressed, the upper limit of the current level is displayed in the interrupt display section.  
The settable range is set to -30.00 to 20.00 dBm (in 0.01 step) by using the rotary knob, step keys, or ten-key pad.  
In the measurement result of LONG TERM, if the level of each channel exceeds this value, the measurement result is displayed in red.
- (9) <LOW LIMIT> key  
Sets the lower limit of the level.  
When this key is pressed, the lower limit of the current level is displayed in the interrupt display section.  
The settable range is set to -90.00 to -30.00 dBm (in 0.01 step) by using the rotary knob, step keys, or ten-key pad.  
In the measurement result of LONG TERM, if the level of each channel goes below this value, the measurement result is displayed in red.
- (10) <SNR LIMIT> key  
Sets the lower limit of the SNR.  
When this key is pressed, the lower limit of the SNR is displayed in the interrupt display section.  
The settable range is set to 0.00 to 50.00 dBm (in 0.01 step) by using the rotary knob, step keys, or ten-key pad.  
In the measurement result of LONG TERM, if the SNR of each channel exceeds this value, the measurement result is displayed in red.

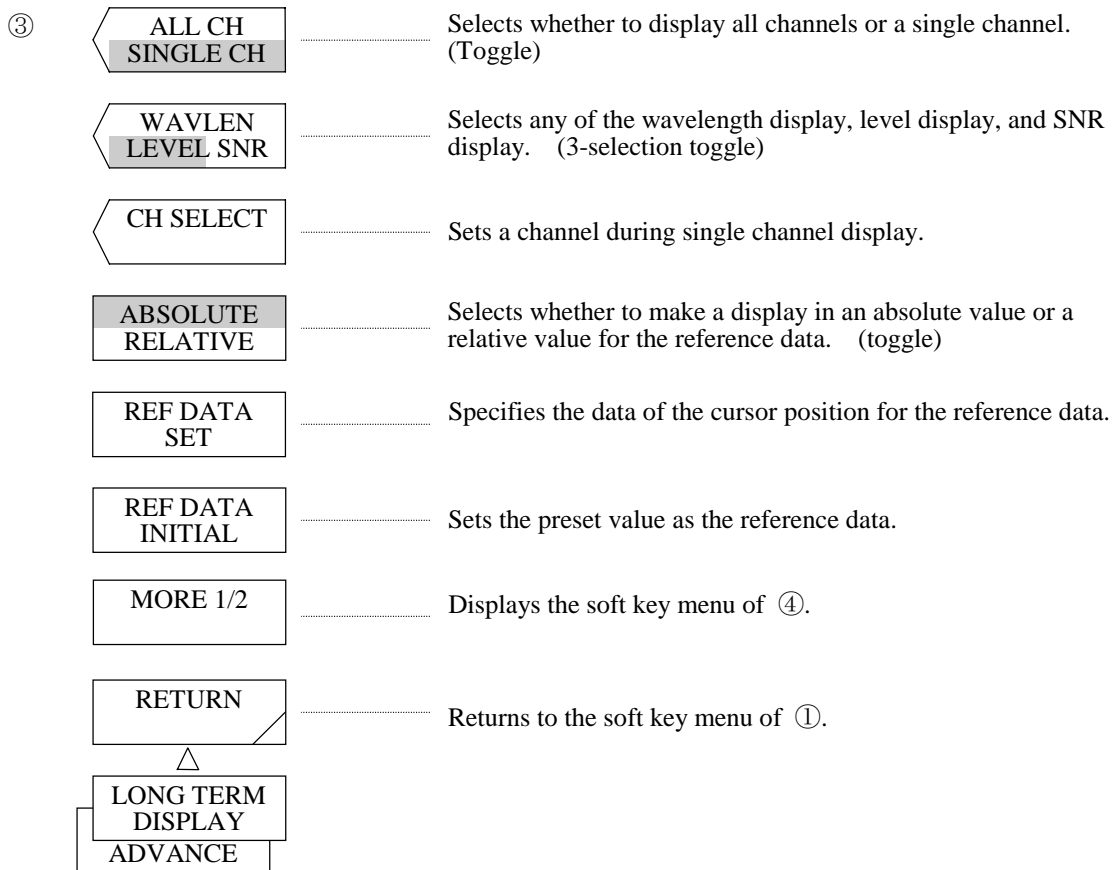

(11) <ALL CH SINGLE CH> key

Selects whether to display this channel concurrently or only an arbitrary single channel.

ALL CH : Display of all channels

SINGLE CH: Display of a single channel

(12) <WAVLEN LEVEL SNR> key

Selects whether to display any of the wavelength, level, and SNR during all channel display.

This key becomes invalid during single channel display.

WAVLEN : Wavelength display

LEVEL : Level display

SNR : SNR display

(13) <CH SELECT> key

Sets a channel during single channel display.

(14) <ABSOLUTE RELATIVE> key

Selects whether to make a display in an absolute value or a relative value for the reference data.

ABSOLUTE : Displayed in an absolute value.

RELATIVE : Displayed in a relative value for the reference data

(15) <REF DATA SET> key  
Sets the data of the cursor position as reference data.

(16) <REF DATA INITIAL> key  
Sets the preset value as reference data.

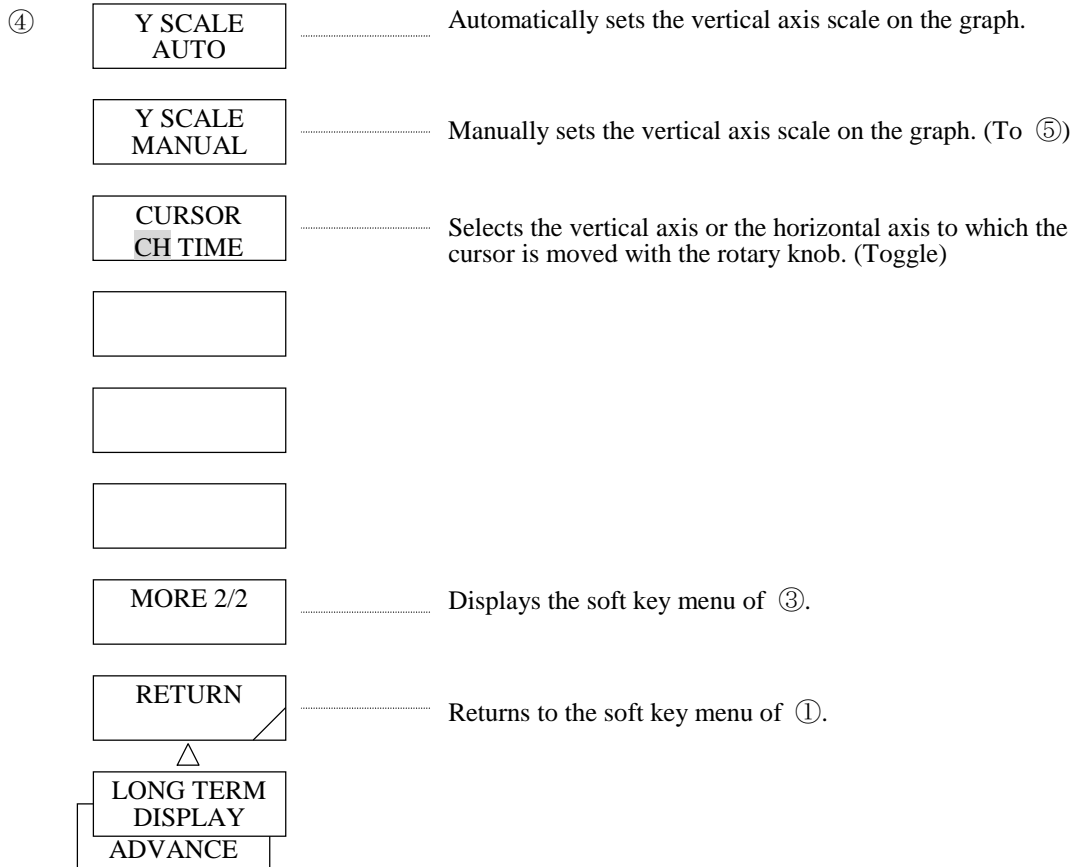

(17) <Y SCALE AUTO> Key  
When this key is selected, the vertical axis scale is automatically set on the long-term measurement result display graph.

(18) <Y SCALE MANUAL> Key  
When this key is selected, the vertical axis scale can be manually set on the long-term measurement result display graph.  
When this key is pressed, the soft key menu of ⑤ is displayed.

(19) <CURSOR CH TIME> key  
The preset value sets the cursor moved by using the rotary knob or step keys to either the vertical axis (channel) or horizontal axis (time).  
CH : Set for the vertical axis (channel)  
TIME : Set for the horizontal axis (time).

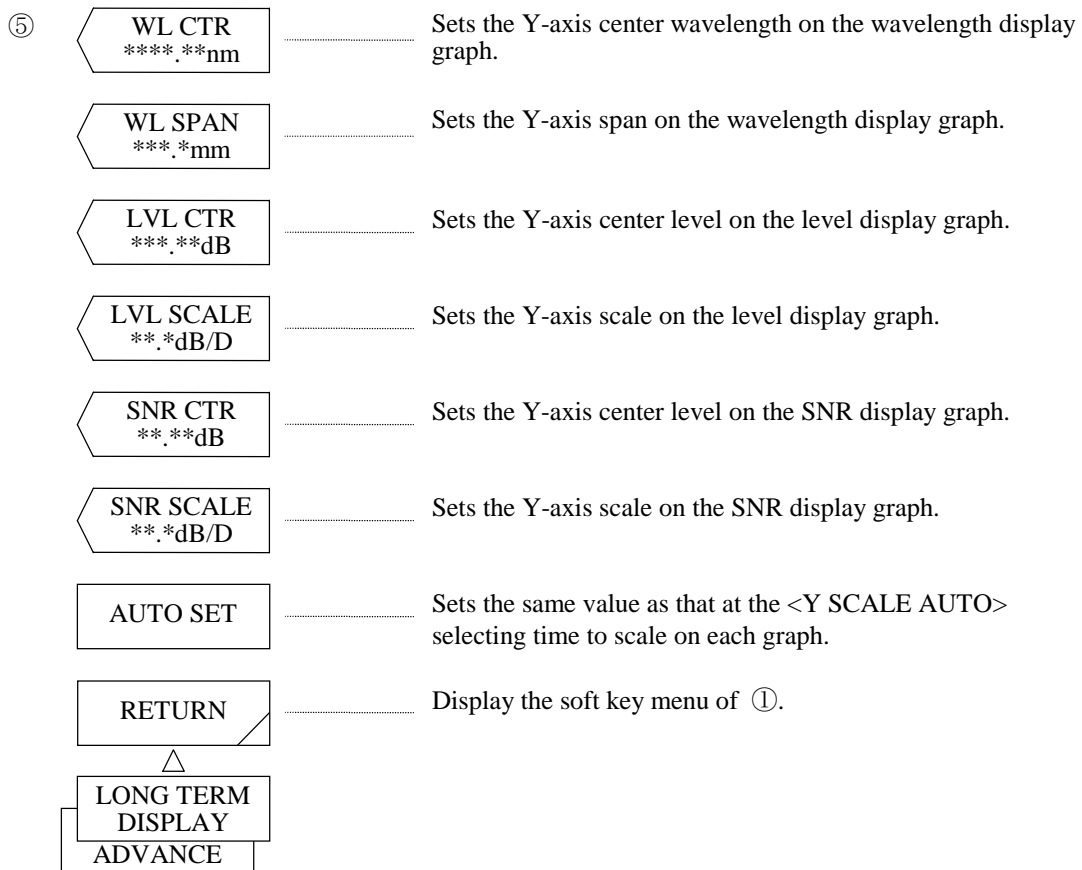

(20) <WL CTR \*\*\*\*.\*nm> Key

Sets the Y-axis center wavelength on the wavelength display graph.

The Y-axis center wavelength can be with the rotary knob, the step key or the ten-key pad in the range from 600.00 to 1750.00 nm (0.01 step).

(21) <WL SPAN \*\*\*.\*nm> Key

Sets the Y-axis span on the wavelength display graph.

The Y-axis span can be changed with the rotary knob, the step key or the ten-key pad in the range from 0.0 to 1200.0 nm (0.1 step).

(22) <LVL CTR \*\*\*.\*dB> Key

Sets the Y-axis center level on the level display graph.

The Y-axis center level can be changed with the rotary knob, the step key or the ten-key pad in the range from -90.00 to 20.00 dB (0.01 step).

(23) <LVL SCALE \*.\*dB> Key

Sets the Y-axis scale on the level display graph.

The Y-axis scale can be changed with the rotary knob, the step key or the ten-key pad in the range from 0.1 to 10.0 dB (0.1 step).

(24) <SNR CTR \*\*.\*dB> Key

Sets the Y-axis center level on the SNR display graph.

The Y-axis center level can be changed with the rotary knob, the step key or the ten-key pad in the range from -90.0 to 20.0 dB (0.01 step).

(25) <SNR SCALE \*\*.\*dB> Key

Sets the Y-axis scale on the SNR display graph.

The Y-axis scale can be changed with the rotary knob, the step key or the ten-key pad in the range from 0.1 to 10.0 dB (0.1 step).

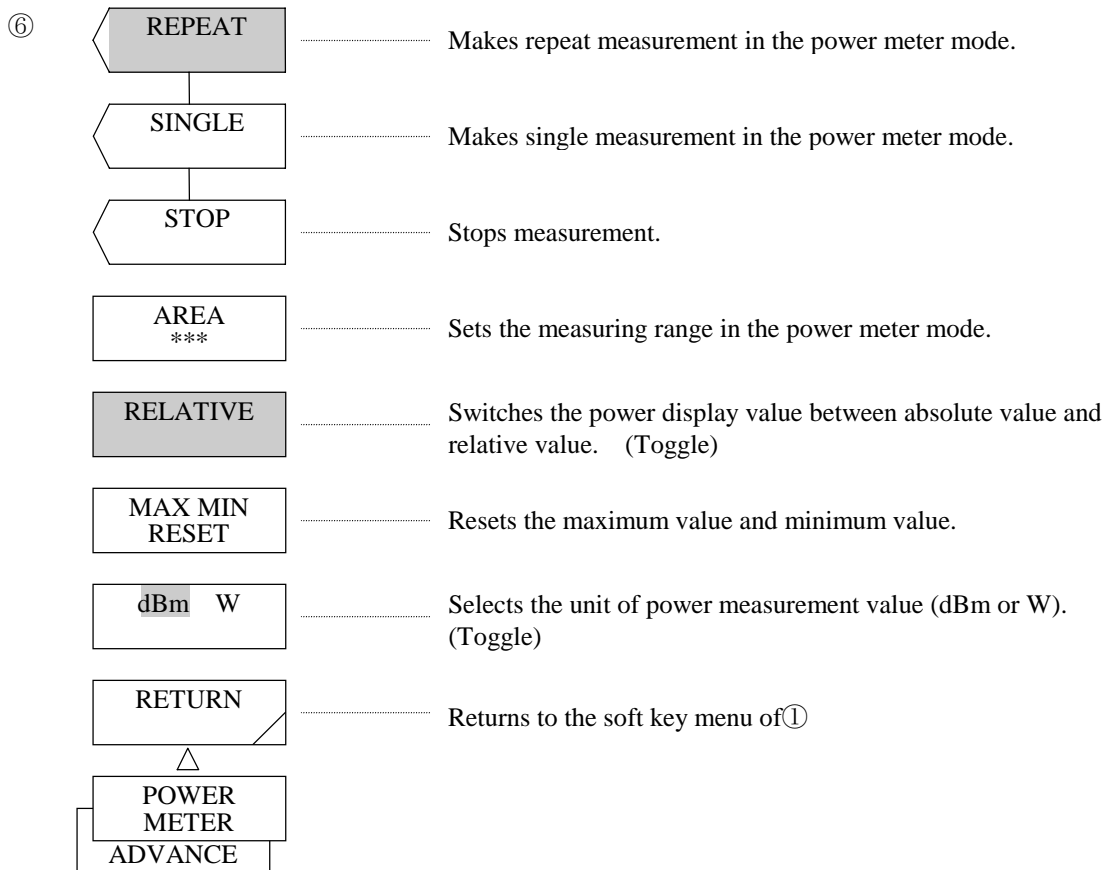

(26) <REPEAT> key

Makes repeat measurement in the power meter mode and displays the result in the window.  
When this key is pressed, the soft key is selected and a repeat measurement is started.

(27) <SINGLE> key

Makes single measurement in the power meter mode.  
When this key is pressed, the soft key is selected and single measurement is started.  
After measurement is made and its result is displayed in the window, the <STOP> key is selected.

(28) <STOP> key

Stops measurement in the power meter mode.

(29) <AREA> key

Sets the measuring range in the power meter mode.  
When this key is pressed, the current set value is displayed in the interrupt display section.  
The set value can be changed in the range of FULL, 600 to 1000 and 1000 to 1750 by the rotary knob, step keys or ten-key pad. The "FULL" value represents the range of 600 to 1750 nm.

- (30) <RELATIVE> key  
Switches the power display value in the window between absolute value and relative value.  
Each time this key is pressed, select or select clear is repeated alternately.  
When this key is selected, the display value in the window is set to relative value.  
Unless this key is not selected, the display value in the window is set to absolute value.  
The relative value in the selected status is set at 0 dB.
- (31) <MAX MIN RESET> key  
Resets the MAX value and MIN value displayed in the window by the power meter function.  
By pressing the key, the maximum value and minimum value are reset.
- (32) <dBm W> key  
Selects LOG value (dBm) or linear value (W) for power measurement result display.  
Each time this key is pressed, the display in reverse video is switched between "dBm" and "W".  
When "dBm" is selected, LOG value is specified.  
When "W" is selected, linear value is specified.
- (33) <RETURN> key (POWER METER)  
Closes the window and returns to the soft key menu of ①.  
The screen displayed by pressing the <POWER METER> key is displayed again.



### 5.1.18 [USER] switch

Soft keys that are to be frequently used can be registered in the soft key menu displayed by this switch.

The soft key menu includes 1/3 to 3/3 and unregistered soft keys remain blank. When a soft key is pressed, the operation corresponding to the registered contents is performed.

For the procedure for registration, refer to 5.1.16 [SYSTEM] switch, <USER KEY DEFINE> key.

### 5.1.19 [HELP] switch

When this switch is pressed, the explanation of the soft key menu displayed at that time is displayed.

If the soft key menu is changed by pressing a panel switch or soft key, the explanation is also changed accordingly. (The function is not executed.)

The WARNING/ERROR message display area is provided at the bottom of the help message list and displayed the contents of the occurring warning/error.

To quit the help screen and return to the initial screen, press the auxiliary key <QUIT HELP> key (displayed at the bottom of the soft key menu).

### 5.1.20 [COPY] switch

When this switch is pressed, hard copies or lists are output to the printer in accordance with the screen.

By pressing the auxiliary key <COPY CANCEL>, the copy operation is stopped.

The usage of the printer is shown below.

- (1) When the [COPY] switch is pressed, a hard copy of the screen displayed at that time is output from the printer.
- (2) When the [COPY] switch is pressed in the sweep status, the sweep is stopped and printing is performed. After that, a sweep is started again.
- (3) The amount of paper feed after printing is set by the <COPY CONFIG> key displayed by pressing the [SYSTEM] switch.
- (4) When record paper is used up during printing or when the [COPY] switch is pressed without setting record paper, the warning "Printer paper empty" is displayed.  
When the [COPY] switch is pressed with the head-up lever set at [UP], the warning "Printer head up" is displayed.  
By pressing the [COPY] switch after setting record paper or set the head-up lever to [DOWN], printing is started.

- (5) Set record paper according to the following procedure.
- 1) Open the cover on the top face plate of this equipment and set the record paper in the paper holder. At this time, set it so that the outside face may look upward when the end of record paper is opened outward.
  - 2) Set the head-up lever to the [UP] side. If any record paper chip is left, remove it and insert the end of the record paper set in 1) as indicated in Fig. 5-2. Then, feed it by 5 cm or so. (Refer to Fig. 5-2.)
  - 3) Set the head-up lever to the DOWN side. Continue to press the [FEED] switch until record paper comes out from the record paper slit on the top face plate.
  - 4) Close the cover of the top face plate.

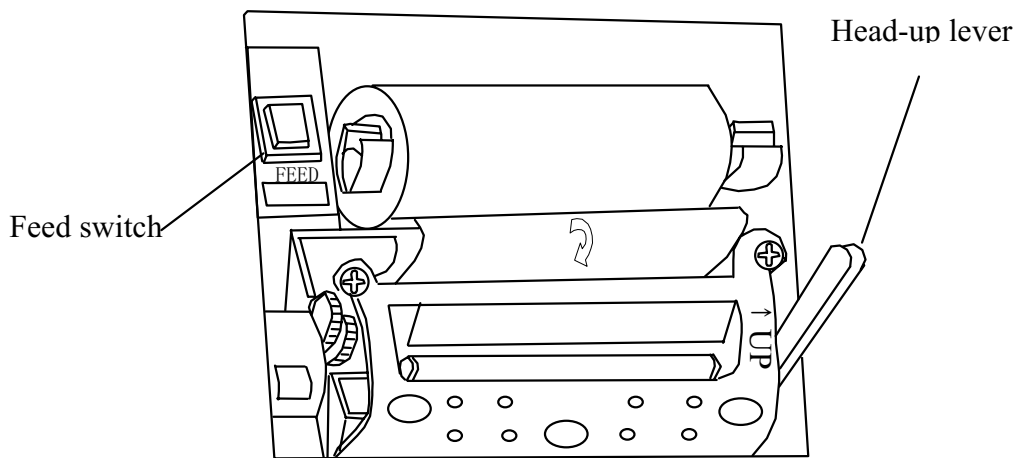

Fig. 5-2 Setting Record Paper

### 5.1.21 [FEED] switch

When this switch is pressed, printer paper feed is performed.

While this switch is continuously pressed, paper feed is continued.

### 5.1.22 [AUXILIARY] switch

This switch (displayed at the bottom of the soft key menu) is provided with a different key display and function depending on the screen status (function in the execute status).

The different functions depending on the screen status are shown below.

Screen status	Key display	Function
a) When the UNDO function is effective:	UNDO	Parameter setting/change and data change/deletion are displayed after completion of execution. When the key is pressed, the result previously executed is canceled and the status precedent to the execution is set.
b) When a program is executed:	PROGRAM EXIT P03	The program in execution is stopped and the soft key menu of the panel switch lastly executed is displayed. " P03" of the auxiliary key denotes the program number in execution.
c) When a user key is registered:	KEY DEF DONE	The soft key menu displayed by pressing the [SYSTEM] switch upon completion of the user key registration mode is displayed again. The screen becomes the status displayed by pressing the <USER KEY DEFINE> key.
d) When the HELP screen is displayed:	QUIT HELP	The HELP message widnow is closed and the screen displayed by pressing the [HELP] switch is displayed again.
e) When the COPY function is executed:	COPY CANCEL	The copy operation is stopped and the screen displayed by pressing the [COPY] switch is displayed again.
f) When the GP-IB is in the remote status:	LOCAL	The remote status is reset to the local status.

## 5.2 Detailed Description of Measuring Functions

### 5.2.1 Pulse light measuring function

#### 1. Outline

This equipment is provided 3 types of pulse light measuring function.

##### 1) LPF mode

**Setting method:**

Press [SET UP] <PLS LIGHT MEASURE> <LPF MODE>.

**Function:**

Pulse light is averaged by a low-pass filter. The mean level of pulse light can be measured. Pulse light with a repeat frequency of about 5 kHz or more (cycle 200  $\mu$ s or less) can be measured.

When the number of averaging times (set by [SETUP] <AVERAGE TIMES>) is increased, lower repeat frequencies can be measured.

When the number of averaging times is  $n$ , the measurable lowest repeat frequency is about  $5/\sqrt{n}$  kHz.

The measuring level is the mean level of pulse light. For example, when pulse light is perfectly square, the measuring level is (peak level of pulse light)  $\times$  (duty of pulse light). Accordingly, as the duty of pulse light is smaller, the measuring level becomes lower.

##### 2) Peak hold mode

**Setting method:**

Press [SETUP] <PLS LIGHT MEASURE> <PEAK HOLD> and enter the hold time (HOLD TIME) by the ten-key pad.

**Function:**

The peak level of pulse light is measured.

Pulse light with a repeat frequency of 0.1 Hz or more (cycle 10 sec or less) can be measured.

The measurable minimum pulse width is 30  $\mu$ s. However, when the pulse width is less than 100  $\mu$ s, the measuring level becomes inaccurate.

In the peak hold mode, the hold time (peak detect time) for each measuring point is set. The hold time must be set longer than the repeat frequency of pulse light.

##### 3) External trigger mode

**Setting method:**

Press [SETUP] <PLS LIGHT MEASURE> <EXT TRG MODE>.

**Function:**

By inputting a control signal synchronized with measured light to the SMPL TRG IN terminal or SMPL ENBL IN terminal from an external circuit, measurement can be made with desired timing.

The SMPL TRG IN terminal (Measurement trigger input terminal) is a TTL-level negative-logic input terminal. Each time a trailing edge of an input signal is detected, each measuring point is measured. Accordingly, to terminate a sweep, the number of trigger signals equal to the number of samples (set by [SETUP] <SAMPLING POINT>) is required.

The SMPL ENBL IN terminal (measurement enable input terminal) is a TTL-level negative-logic input terminal. Only for the period in which a LOW level of an input signal is detected, measurement is made. Unlike the EXT TRIG IN terminal, while the signal is LOW, measurement is continued one after another.

In the external trigger mode, the maximum response frequency is 5 kHz.

The delay time from trigger signal detection till measurement is about 25  $\mu$ s.

If a trigger signal is input while the wavelength is changed to the next measuring point after completion of measurement at each point (approx. 10 to 30 ms), it is ignored.

Both SMPL TRG IN terminal and SMPL ENBL IN terminal are internally pulled up.

Accordingly, they can be caused to go high in the open status and low in the GND short status.

2. How to use each mode properly

For pulse light with a repeat frequency of 10 kHz or less, the peak hold mode is suitable.

When the repeat frequency exceeds 10 kHz, the LPF mode is suitable.

The external trigger mode is used to know an optical spectrum at an optional timing when the light source level and wavelength characteristic vary cyclically.

(The variation speed must be followed up at the maximum response frequency of 5 kHz.)

3. When the pulse light measuring function is not used:

Even when the pulse light measuring function is not used, measurement is possible if the repeat frequency of pulse light is high to some extent. In this case, like the LPF mode, mean level measurement is made.

The measurable repeat frequency depends on the measuring sensitivity (set by [SETUP] <SENS>)

1) When the measuring sensitivity is set to SENS:NORM:

Pulse light with a repeat frequency of 100 kHz or more can be measured.

When the number of averaging times (set by [SETUP] <AVERAGE TIMES>) is increased, lower repeat frequencies can be measured.

When the number of averaging times is set to n, the measurable lowest frequency is about  $100/\sqrt{n}$  kHz.

2) When the measuring sensitivity is set to SENS:HIGH1 to 3:

Pulse light with a repeat frequency of 1 kHz or more can be measured.

Even if the number of averaging times is increased, the measurable lowest frequency is the same.

## NOTE

### *SWP TRG IN terminal*

*Unlike the SMPL TRG IN terminal, the SWP TRG IN terminal (sweep trigger IN terminal) is a TTL-level negative-logic input terminal and starts a sweep by a trigger signal. When a trigger signal is received, the terminal functions in the same way as pressing [SWEEP] <SINGLE>. This terminal, which is independent of the pulse light measuring function, can function in any mode.*

## 5.2.2 Power meter function

### 1. Outline

In this equipment, the following measurement is made in the power meter mode.

In the power meter mode, a sweep is internally performed in the wavelength range set by the <AREA> key at a resolution of 2 nm for spectrum measurement. For a measured spectrum, power measurement is made and the result is displayed in the window.

At this time, the spectrum internally measured, which have undergone wavelength sensitivity compensation, permits power measurement free from wavelength dependency.

Power variation can be measured by switching between relative value and absolute value by the <RELATIVE> key. In the window, there is a function to display the maximum value and minimum value levels which can be initialized by the <MAX MIN RESET> key.

As a power unit, "dBm" and "W" can be selected by the <dBm W> key.

### 2. Setting method

When the [ADVANCE] switch and the <POWER METER> key are pressed, the power meter mode is set.

Then, set the measuring range to any of FULL (600 to 1750 nm), 600 to 1000, and 1000 to 1750 by the <AREA> key.

### 5.2.3 Analog output function

#### 1. Outline

To the ANALOG OUT terminal, the electric signals proportional to the measuring level are output in real time upon execution of a sweep. (0 to 5 V, load impedance 1 k $\Omega$  or more)

To the SMPL TRG OUT terminal, trigger pulses are output according to the timing with which measurement at each measuring point is made during a sweep.

(TTL level, negative logic, pulse width approx. 15  $\mu$ s)

#### 2. Remarks

- The output signal of the ANALOG OUT terminal cannot undergo wavelength sensitivity compensation unlike the waveforms displayed on the screen.
- Use the ANALOG OUT terminal in the measurement mode: CW light measurement (press [SETUP] <CW LIGHT MEASURE>) with the measuring sensitivity: NORM RANGE HOLD (set by [SETUP] <SENS>).  
In the other setting conditions, the output signals of the ANALOG OUT terminal and SMPL TRG OUT terminal do not correspond to screen displays.
- When the number of averaging times is set to more than 1, to the SMPL TRG out terminal, the same number of trigger pulses as the number of averaging times is output to the same measuring point.

### 5.2.4 Power density display function

The level axis of the optical spectrum analyzer represents the absolute power in a single resolution.

If the resolution is set to 0.1 nm, for example, the power in 0.1 nm is displayed.

If a gas laser or a semiconductor laser is used, its optical spectrum is narrower than the resolution of this Analyzer and, therefore, the entire power can be displayed within a single resolution bandwidth.

The measured power (that is, the peak level) matches the total power of the optical source.

This Analyzer has been calibrated to accurately display the power in such conditions.

While the natural sun light, fluorescent lamps, and LEDs often have the spectrum width wider than the setup resolution of this Analyzer. If these lights are measured by this Analyzer, the measured power is changed depending on the resolution setup.

In some cases, the actual resolution of the optical spectrum analyzer does not match the preset resolution completely.

For example, in this equipment, if the wavelength is lower than 1,200 nm, the actual resolution is slightly wider than the preset resolution. This complicates the determination of relationship between the measured value and absolute value when a wide range optical spectrum is measured.

To solve such problems, the Analyzer can switch the level axis display from the absolute power of a single resolution (dBm, mW,  $\mu$ W, nW or pW) to the power density (dBm/nm, mW/nm,  $\mu$ W/nm, nW/nm, or pW/nm) by the <dBm dBm/nm> key.

During power density display, the measured values are converted into the power of 1 nm and displayed. Therefore, the fixed power density can always be displayed even when any resolution is selected for measurement.

The absolute power display or the power density display can be selected in the following applications:

- Absolute power display : For measurement of an optical source which has a narrow spectrum width (examples of gas laser and semiconductor laser).
- Power density display : For measurement of the natural light and LEDs having the wide spectrum width.

If the trace subtraction function is used for "A- B(A/B)  $\rightarrow$  C" and for "B- A(B/A)  $\rightarrow$  C" modes, the results are not different between the absolute power display and power density display.

As the power measurement function use the different calculation methods depending on their level axis display, these functions can output the correct results in both display modes.

Also, if the NF measurement function (by the <ANALYSIS2 EDFA-NF> key) and the WDM analysis function (by the <ANALYSIS2 WDM> key) are executed, the level axis is forcibly changed to the absolute power display mode.

#### NOTE

*The Analyzer specifications such as level accuracy, measurement level range, and level linearity have been defined for the absolute power display.*



## 5.3 Detailed Description of Analysis Function

### 5.3.1 NF measuring function

#### 1. Outline

The NF function measures NF (noise figure) of the optical fiber amplifier.

Optical spectrum of signal light is entered to the trace A and, for the trace B, optical spectrum of signal light after being amplified by optical fiber amplifier is entered. Then this function is executed.

With this, the following items are calculated and the results are displayed in the data area.

ASE (amplified spontaneous emission) level

Gain

NF

For ASE calculation, the data of the trace B is used. At this time, the optical spectrum of signal light must be masked.

The mask range can be set freely.

As the measuring resolution at ASE level measurement, required for NF calculation, the half-width level of optical spectrum before amplification is measured and the result is applied.

The mask range and measuring resolution are displayed together.

Level offset can be applied to both optical spectrum before amplification and after amplification. This operation makes up possible loss due to isolator or photo coupler being installed on optical fiber amplifier.

#### 2. Operations

- 1) Set the trace A to WRITE and measure the optical spectrum of signal light (light entering the optical fiber AMP). After the measurement, set the trace A to FIX.
- 2) Set the trace B to WRITE and measure the optical spectrum of output light (light amplified by the optical fiber AMP). After the measurement, set the trace B to FIX.
- 3) Press the [ANALYSIS] switch and the <EDFA NF> key.
- 4) NF measurement function is executed and results are shown in data area.  
Following soft keys are also shown. Press desired key and enter parameters using the rotary knob, step keys or ten-key.
  - <OFST (IN)> key..... Level offset of input spectrum
  - <OFST (OUT)> key..... Level offset of output spectrum
  - <PLUN MSK> key ..... Mask range at ASE calculation  
(Right side of signal light's peak wavelength)
  - <MINUS MSK> key ..... Mask range at ASE calculation  
(Left side of signal light's peak wavelength)

- <CVFT TYPE> key ..... Approximation expression of ASE curve
  - GAUSSIAN : Normal distribution curve
  - LORENZIAN : Lorenz curve
  - 3RD POLY : Cubic expression
  - 4TH POLY : Biquadratic expression
  - 5TH POLY : Pentagonal expression
- <CVFT THR> key ..... Threshold when ASE curve is approximated

3. Calculation method

1) ASE level PASE

For the data in the section from the waveform data of the trace B to Value corresponding to threshold (being set with <CVFT THR> key) lower on both sides than the position of "peak wavelength  $\pm$  mask range" (setting is done with <PLUS MSK> or <MINUS MSK> key), perform approximation by function specified with <CVFT TYPE> key.

Next, find the peak wavelength of the trace B and specify the peak wavelength level of the approximation curve as ASE level PASE.

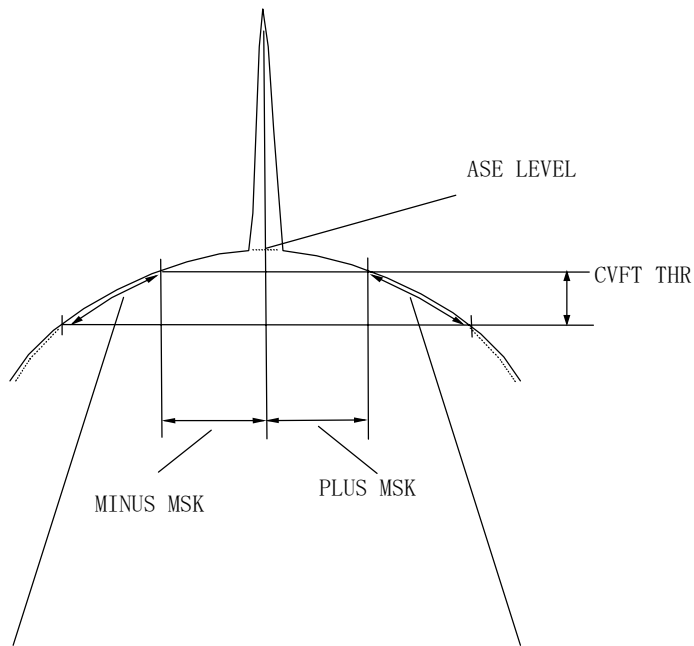

Approximation is conducted on the data within this range  
 Approximation expression is per <CVFT TYPE> key.

When the approximation curve is found, the whole waveform of the trace B is usually approximated. However, if the wavelength line marker is set by [MARKER] <LINE MARKER 1> and <LINE MARKER 2> and put [MARKER] <SEARCH L1-L2> into the select status, only the range enclosed by the line markers is approximated.

2) gain G

$$G = (PB - PASE) / PA$$

PA : Peak level of signal light

PB : Peak level of the light amplified by optical fiber AMP

3) NF

$$NF = \frac{PASE}{\Delta v \cdot G \cdot h \cdot v} + \frac{1}{G}$$

$\Delta v$  : Measuring bandwidth

Value obtained by finding the half-amplitude value of trace A waveform and then performing frequency conversion.

h : Plank's constant

v : Center frequency

Value obtained by finding the peak wavelength of trace B waveform and then performing frequency conversion

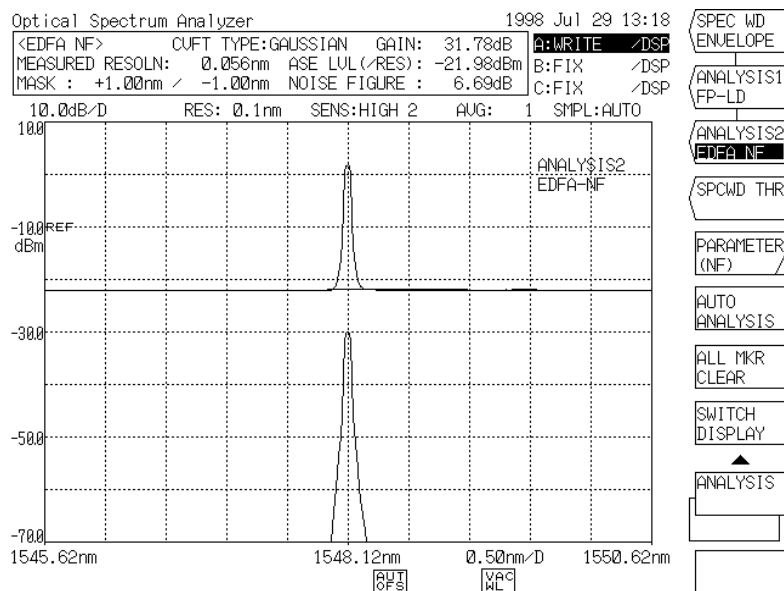

NF Measurement Waveform

## 5.3.2 Curve fit function

### 1. Outline

For all the data that exceeds the spectrum limit value (set by <CURVE FIT C> or <CURVE FIT PK C>, this function performs frequency conversion of wavelength and LOG conversion of level and then performs approximation to a quadratic curve by the method of least squares.

The peak curve fit function performs frequency conversion of wavelength and LOG conversion of level for the mode peaks exceeding the limit value, and then performs approximation to a quadratic curve by the method of least squares.

(The quadratic curve of LOG data corresponds to a normal distribution curve in linear value.)

If the number of data is insufficient, curve fit processing is impossible. In this case, the original spectrum is displayed as it is.

### 2. Operations

- 1) Press the [TRACE] switch and the <ACTIVE TRACE A B C> key and set the active trace to "C".
- 2) By pressing the <EFFECT> and <CURVE FIT C> keys, curve fit processing is performed. Regarding the limit value, the set value displayed in the interrupt display section by the rotary knob, step keys or ten-key pad when the key is pressed. When the <EFFECT> and <CURVE FIT PK C> keys are pressed, peak curve fit processing is performed. The limit value can be changed in the same way.

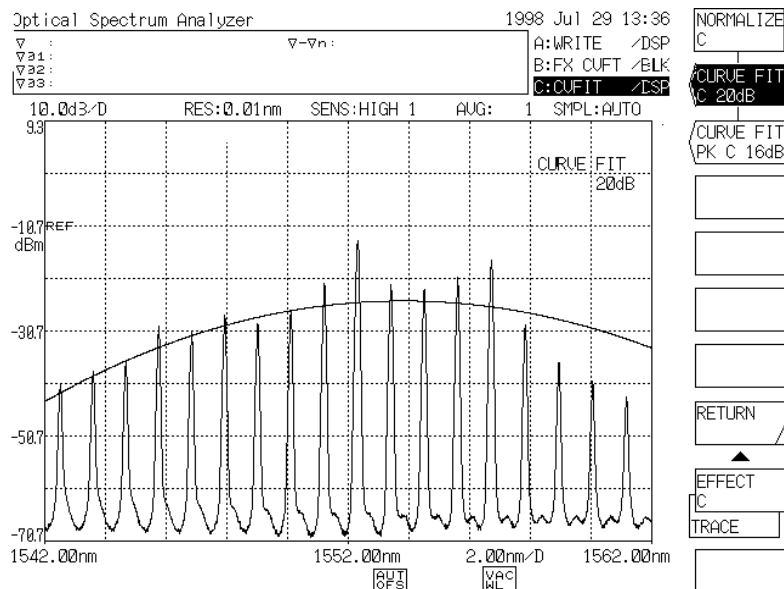

Curve Fit Display Waveform

### 5.3.3 WDM analysis function

(1) Analysis Items

The following values are obtained from measured WDM wavelength:

- Center wavelength of each channel  $\lambda_i$
- Level of each channel  $L_i$
- Noise level of each channel peak  $LN_i$
- Difference between level of each channel peak and noise level (SNR)  $SN_i$
- Wavelength difference for the channel peak that becomes the standard
- Level difference for the channel peak that becomes the standard

However,  $i = 1, 2, \dots, n$

(2) Analysis Example and Display Items

An actual WDM waveform example and a WDM analysis example are as follows:

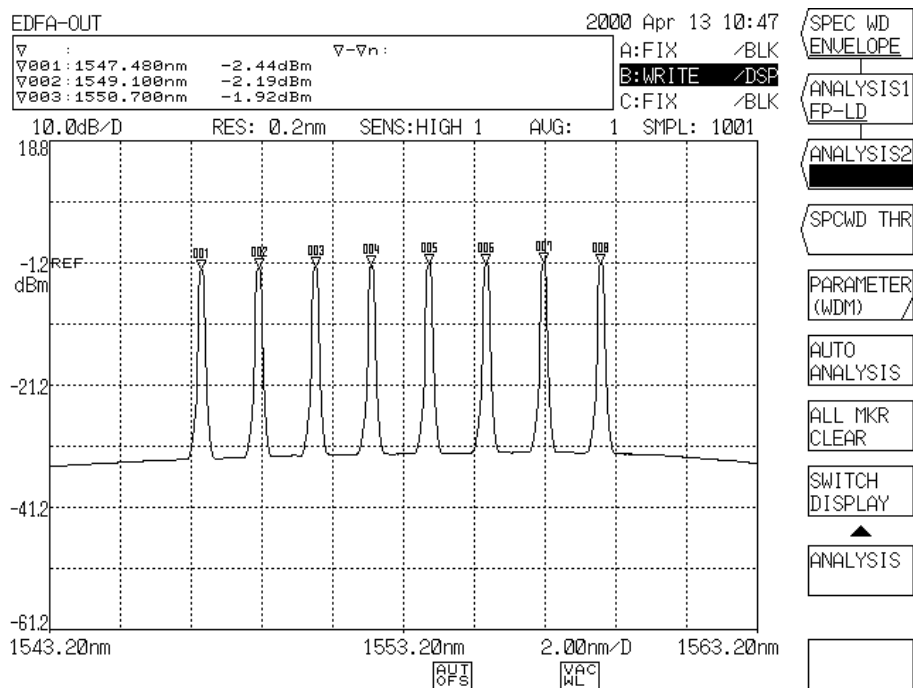

Example WDM Measurement Waveform

① When <DISPLAY ABSOLUTE> is set,

EDFA-OUT							2000 Apr 13 10:48	
<WDM ANALYSIS>							REF CH:HIGHEST	
							REF TBL:ITU-T	
							NOISE POI: 0.40nm	
							TH:20.00dB	
							MAX NUM: 20	
							MODE DIFF: 3.00dB	
NO.	WAVELENGTH [nm]	LEVEL [dBm]	OFFSET WL [nm]	OFST LVL [dB]	NOISE (-BW) [dBm]	SNR [dB]		
01	1547.477	-2.45	-9.683	-1.23	-23.96	21.51	OFFSET SPACING	
02	1549.090	-2.20	-8.069	-0.98	-23.67	21.47	REF CHNEL HIGHEST	
03	1550.696	-1.92	-6.464	-0.71	-23.30	21.38	REF CHNEL NO. 1	
04	1552.284	-1.70	-4.876	-0.49	-23.07	21.37	DISPLAY ABSOLUTE	
05	1553.903	-1.49	-3.257	-0.28	-22.95	21.45	DISPLAY SETTING /	
06	1555.529	-1.38	-1.631	-0.16	-22.81	21.43	REF DATA SETTING /	
07	1557.145	-1.22	(REF)	(REF)	-22.71	21.49	MORE 1/4	
08	1558.766	-1.37	1.607	-0.15	-22.83	21.46	RETURN	
							PARAMETER	
							ANALYSIS	

Example of WDM List at the time of <DISPLAY ABSOLUTE>

<Explanation of Display Items>

- No. : WDM channel number
- Wavelength (\*1) : Center wavelength of each channel
- Level : Level of each channel
- Offset WL (\*2) : Offset wavelength for any one mode (to be set with the <REF CHNEL> key)
- OFST LVL (\*2) : Offset level for any one mode (to be set with the <REF CHNEL> key)
- Noise : Noise level of each channel
- SNR : SNR of each channel

\*1 : Frequency is displayed when the marker is in the frequency display mode.

\*2 : When <SPACING> is selected, these change to SPACING and LVL DIFF.

② When <DISPLAY RELATIVE> is set,

EDFA-OUT		2000 Apr 13 10:48				
<WDM ANALYSIS>		REF CH:HIGHEST	REF TBL:ITU-T	NOISE POI: 0.40nm		
		TH:20.00dB	MAX NUM: 20	MODE DIFF: 3.00dB		
NO.	WAVELENGTH [nm]	LEVEL [dBm]	OFFSET WL [nm]	OFST LVL [dB]	NOISE (-BW) [dBm]	SNR [dB]
01	-0.161	-27.55	-9.683	-1.23	-26.04	-1.51
02	-0.176	-27.80	-8.069	-0.98	-26.33	-1.47
03	-0.179	-28.08	-6.464	-0.71	-26.70	-1.38
04	-0.161	-28.30	-4.876	-0.49	-26.93	-1.37
05	-0.172	-28.51	-3.257	-0.28	-27.05	-1.45
06	-0.186	-28.62	-1.631	-0.16	-27.19	-1.43
07	-0.186	-28.78	(REF)	(REF)	-27.29	-1.49
08	-0.189	-28.63	1.607	-0.15	-27.17	-1.46

- OFFSET SPACING
- REF CHNEL HIGHEST
- REF CHNEL NO. 1
- DISPLAY RELATIVE
- DISPLAY SETTING /
- REF DATA SETTING /
- MORE 1/4
- RETURN
- ▲
- PARAMETER
- ANALYSIS
- 

Example of WDM List at the time of <DISPLAY RELATIVE>

<Explanation of Display Items>

- No. : WDM channel number
- Wavelength (\*1) : Center wavelength of each channel (Relative value for reference data)
- Level : Level of each channel (Relative value for reference data)
- Offset WL (\*2) : Offset wavelength for any one mode (to be set with the <REF CHNEL> key)
- OFST LVL (\*2) : Offset level for any one mode (to be set with the <REF CHNEL> key)
- Noise : Noise level of each channel
- SNR : SNR of each channel

\*1 : Frequency is displayed when the marker is in the frequency display mode.

\*2 : When <SPACING> is selected, these change to SPACING and LVL DIFF.

③ When <DISPLAY ABS & REL> is set,

EDFA-OUT		2000 Apr 13 10:48				
<WDM ANALYSIS>		REF CH:HIGHEST	REF TBL:ITU-T	NOISE POI: 0.40nm		
		TH:20.00dB	MAX NUM: 20	MODE DIFF: 3.00dB		
NO.	ABS WL [nm]	REL WL [nm]	ABS LV [dBm]	REL LV [dB]	ABS SNR [dB]	REL SNR [dB]
01	1547.477	-0.161	-2.45	-27.55	21.51	-1.51
02	1549.090	-0.176	-2.20	-27.80	21.47	-1.47
03	1550.696	-0.179	-1.92	-28.08	21.38	-1.38
04	1552.284	-0.161	-1.70	-28.30	21.37	-1.37
05	1553.903	-0.172	-1.49	-28.51	21.45	-1.45
06	1555.529	-0.186	-1.38	-28.62	21.43	-1.43
07	1557.145	-0.186	-1.22	-28.78	21.49	-1.49
08	1558.766	-0.189	-1.37	-28.63	21.46	-1.46

OFFSET  
 SPACING  
 REF CHNEL  
 HIGHEST  
 REF CHNEL  
 NO. 1  
 DISPLAY  
 ABS&REL  
 DISPLAY  
 SETTING  
 REF DATA  
 SETTING  
 MORE 1/4  
 RETURN  
 ▲  
 PARAMETER  
 ANALYSIS  
 [ ]

Example of WDM List at the time of <DISPLAY ABS & REL>

<Explanation of Display Items>

- No. : WDM channel number
- ABS WL (\*1) : Center wavelength of each channel
- REL WL (\*1) : Center wavelength of each channel (Relative value for reference data)
- ABS LV : Level of each channel
- REL LV : Level of each channel (Relative value for reference data)
- ABS SNR : SNR of each channel
- REL SNR : SNR of each channel (Relative value for reference data)

\*1 : Frequency is displayed when the marker is in the frequency display mode.



④ When <DISPLAY DRIFT> is set,

EDFA-OUT		2000 Apr 13 10:48				
<WDM ANALYSIS>		REF CH:HIGHEST	REF TBL:ITU-T	NOISE POI: 0.40nm		
		TH:20.00dB	MAX NUM: 20	MODE DIFF: 3.00dB		
NO.	REL WL [nm] ABS WL [nm]	MAX [nm] MIN [nm]	MAX-MIN [nm]	REL LV [dB] ABS LV [dBm]	MAX [dB] MIN [dB]	MAX-MIN [dB]
01	-0.161 1547.477	-0.161 -0.161	0.000	-27.55 -2.45	-27.55 -27.55	0.00
02	-0.176 1549.090	-0.176 -0.176	0.000	-27.80 -2.20	-27.80 -27.80	0.00
03	-0.179 1550.696	-0.179 -0.179	0.000	-28.08 -1.92	-28.08 -28.08	0.00
04	-0.161 1552.284	-0.161 -0.161	0.000	-28.30 -1.70	-28.30 -28.30	0.00
05	-0.172 1553.903	-0.172 -0.172	0.000	-28.51 -1.49	-28.51 -28.51	0.00
06	-0.186 1555.529	-0.186 -0.186	0.000	-28.62 -1.38	-28.62 -28.62	0.00
07	-0.186 1557.145	-0.186 -0.186	0.000	-28.78 -1.22	-28.78 -28.78	0.00
08	-0.189 1558.766	-0.189 -0.189	0.000	-28.63 -1.37	-28.63 -28.63	0.00

OFFSET  
 SPACING  
 REF CHNEL  
 HIGHEST  
 /REF CHNEL  
 NO. 1  
 DISPLAY  
 DRIFT  
 DISPLAY  
 SETTING /  
 REF DATA  
 SETTING /  
 MORE 1/4  
 RETURN  
 ▲  
 PARAMETER  
 ANALYSIS  
 [ ]

Example of WDM List at the time of <DISPLAY DRIFT>

<Explanation of Display Items>

- No. : WDM channel number
- REL WL (\*1) : Center wavelength of each channel (Relative value for reference data)
- ABS WL (\*1) : Center wavelength of each channel
- MAX/MIN (\*1) : MAX/MIN value of REL WL
- MAX-MIN (\*1) : Fluctuation width of REL WL
- REL LV : Level of each channel (Relative value for reference data)
- ABS LV : Level of each channel
- MAX/MIN : MAX/MIN Value of REL LV
- MAX-MIN : Fluctuation width of REL LV

\*1 : Frequency is displayed when the marker is in the frequency display mode.

(3) Channel Distinguishing Method

- When CH DETECT is AUTO,
  - ① Obtain all the maximum points and the minimum points of a waveform.
  - ② When the level difference for the minimum points on the both sides exceeds the difference between the top and the bottom MODE DIFF and the level difference of the largest maximum point exceeds THRESH, the maximum points are judged as the channel peak. The center at the point 3dB (or the MODE DIFF value when the MODE DIFF set point is less than 3 dB) lower to the right and to the left than the obtained channel peak is called the channel center wavelength  $\lambda_i$ .  
The maximum number of channels obtained shall be up to MAX No.
  - ③  $i$  numbers are called Channel 1, 2, ... in the order of channel peak from the short wavelength side.
  
- When CH DETECT is PRESET,
  - ① Obtain the intermediate point between the right channel and the left channel for each channel being set with PRESET WL TABLE (up to the channels being set with MAX No).
  - ② Obtain the peak of each channel in the range from the intermediate point of the left channel to the intermediate point of the right channel and judge the point as the channel peak. The center at the point 3 dB (or the MODE DIFF value when the MODE DIFF set point is less than 3 dB) lower to the right and to the left than the obtained channel peak is called the channel center wavelength  $\lambda_i$ .

\* Set "MODE DIFF," "THRESH," "MAX No." and "PRESET WL TABLE" according to the PARAMETER menu of the ANALYSIS switch.

(4) Noise Calculating Method

- When NOISE POINT is FIX,
  - ① Obtain the levels  $E_{Li}$  and  $E_{Ri}$  of each channel at the points the NOISE POINT (nm) away to the left and to the right.
  - ② Assuming that the equation,  $LN_i = \frac{E_{Li} + E_{Ri}}{2}$  can be formed, obtain the noise level  $LN_i$ .
  
- When NOISE POINT is CENTER,
  - ① Obtain the noise level  $LN_i$  of each channel peak.
    - Obtain the level  $E_i$  at the intermediate point of each channel.
    - Obtain the average value of the left  $E_i$  and the right  $E_i$  for each channel. (Linear interpolation)
    - Also, convert this value into the power density per 1 nm with the resolution stored in this equipment and make it  $LN_i$ .

(5) Level Calculating Method

Obtain the level  $L_i$  of each channel from the following equation:

$$L_i = \text{Mode Peak Level} - \text{Noise level of the channel } LN_i$$

(6) Setting of <DUAL TRACE> Key

When this key is turned ON, WDM can be analyzed as follows from the waveforms of Traces A and B irrespective of the active trace status:

- The channel center wavelength  $\lambda_i$  and the level value  $L_i$  can be calculated from the waveform of Trace A.
- The noise level  $LN_i$  can be calculated from the waveform of Trace B.

(7) Setting of <OFFSET/SPACING> Key

- \* When OFFSET is selected,  
Displays the offset value for any one mode.
- \* When SPACING is selected,  
Displays the offset value for an adjacent mode.

(8) Reference Data at the RELATIVE Value Calculating Time

When the <DISPLAY \*\*\*\*\*> key is set so as to select "RELATIVE," "ABS & REL" or "DRIFT," the wavelength, the level and SNR are calculated as the relative values for the reference table set with the <DISPLAY SETTING> key.

① When <ITU-T TABLE> has been selected as the reference table,

- Values in the ITU-T TABLE already registered in the internal memory of this equipment are referred to for the wavelength. These values in the ITU-T TABLE can be edited with the <PRESET WL TABLE> key.
- The value set with the <LEV PRESET \*\*.\*\*.dBm> key is referred to for the level.
- The value set with the <SNR PRESET \*\*.\*\*.dB> key is referred to for the SNR.

② When <REF TABLE> has been selected as the reference table,

The reference table set with the <REF DATA SETTING> key is referred to.

### 5.3.4 WDM-NF Analysis Function

1. Outline

The WDM-NF analysis function is for obtaining the following values for each WDM channel in block from the WDM waveforms before and after being amplified with the optical fiber amplifier:

- Center wavelength (WAVELENGTH)
- Signal light level (INPUT LEV)
- Output light level (OUTPUT LEV)
- ASE (Spontaneously emitted light) level (ASE LEV)
- Measuring resolution (RESOLN)
- Gain (GAIN)
- Noise Figure (NF)

(Measurement Example)

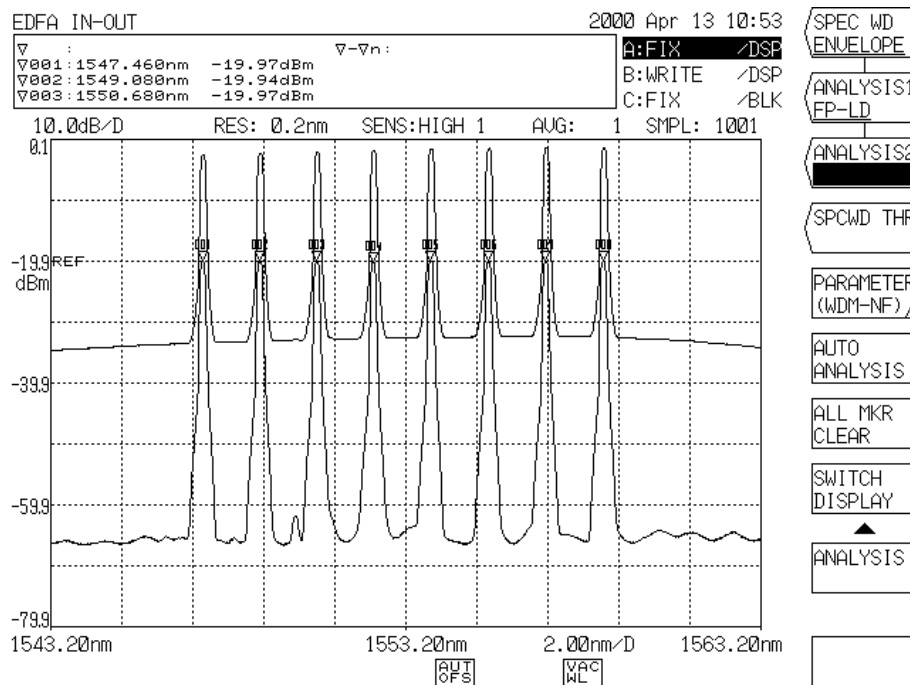

Example of WDM Waveforms before and after being amplified with Optical Fiber Amplifier

<WDM NF>		ASE:± 0.40nm OFST(IN): 0.00dB OFST(OUT): 0.00dB		CH:AUTO MAX NUM: 20 THRESH: 20.00dB MODE DIFF: 3.00dB			
NO.	WAVELENGTH [nm]	INPUT LEV [dBm]	OUTPUT LEV [dBm]	ASE LEV [dBm]	RESOLN [nm]	GAIN [dB]	NF [dB]
01	1547.464	-19.94	-2.44	-33.28	0.145	17.49	5.58
02	1549.076	-19.93	-2.19	-33.01	0.158	17.73	5.25
03	1550.679	-19.94	-1.92	-32.65	0.148	18.02	5.62
04	1552.268	-19.98	-1.70	-32.45	0.146	18.28	5.63
05	1553.885	-19.92	-1.49	-32.34	0.152	18.43	5.43
06	1555.510	-19.96	-1.37	-32.23	0.155	18.58	5.31
07	1557.126	-19.87	-1.22	-32.15	0.143	18.65	5.69
08	1558.747	-19.92	-1.37	-32.28	0.154	18.55	5.35

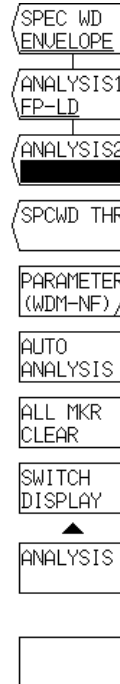

### Execution Example of WDM-NF Analysis Function

The ASE level is obtained from the data of Trace A, but at the time it is necessary to set the ASE level measuring point. The measuring resolution at the ASE level measuring time necessary for the NF calculation uses the half bandwidth of the optical spectrum after amplification as the value measured for each channel.

It is possible to put the optical spectrum before and after amplification. This enables to compensate losses in measure when isolators or couplers are connected to the input and output ports of the optical fiber amplifier.

## 2. Operation

- ① Set Trace A to WRITE and measure the optical spectrum of the signal light (entering the optical fiber amplifier). After the measurement, set Trace A to FIX.
- ② Set Trace B to WRITE and measure the optical spectrum of the output light (amplified with the optical fiber amplifier). After the measurement, set Trace B to FIX.
- ③ Press the <ANALYSIS2 WDM-NF> key of the [ANALYSIS] switch.
- ④ The NF measuring function is executed, and the result is displayed in a list.

When the following soft keys are displayed, press any keys as the need arises and input relevant parameters with the rotary knob, the step key or the ten-key pad:

- <ASE POINT> Key ----- ASE level measuring position ( $\Delta\lambda$  ASE)
- <OFST (IN)> Key ----- Input spectrum level offset
- <OFST (OUT)> Key ----- Output spectrum level offset

### 3. Calculating Method

The WDM-NF analysis takes the following processes:

- ① Execute the WDM analysis for the waveform data of Trace A and detect channels.
- ② Obtain the center wavelength  $\lambda_i$  of each channel and the signal light level  $PA_i$  from the waveform data of Trace A.
- ③ Obtain the output light level  $PBi$  of each channel from the waveform data of Trace B.  
Also, obtain the spectrum half bandwidth and make the value converted into frequency the measuring resolution  $\Delta\nu_i$ .
- ④ Obtain the levels at the two points  $\lambda_i \pm \Delta\lambda_{ASE}$ , which are the ASE level measuring position ( $\Delta\lambda_{ASE}$  ASE) away from the center wavelength  $\lambda_i$  of each channel, from the waveform data of Trace B, and make the intermediate point of the level the ASE level ( $PASE_i$ ).

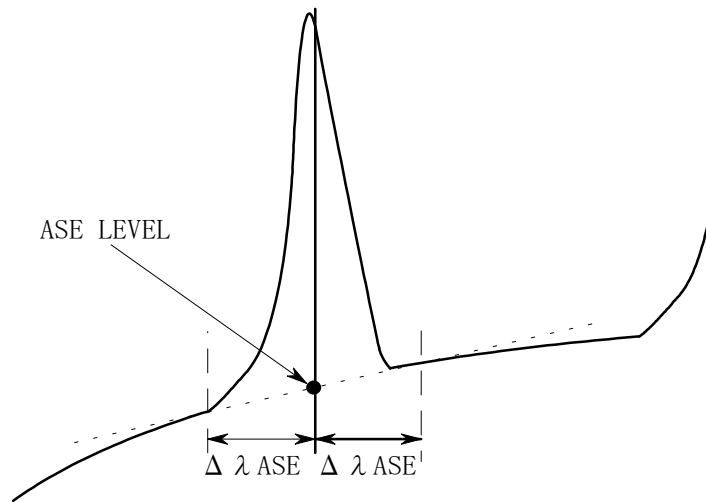

ASE Level Obtaining Method in WDM-NF Analysis

- ⑤ Calculate the gain  $G_i$  and the NF value of each channel from the following equation:

$$G_i = (PBi - PASE_i) / PA_i$$

$PA_i$  : Signal light level of each channel

$PBi$  : Output light level amplified with the optical fiber amplifier of each channel

$PASE_i$  : ASE level of each channel

$$NF_i = \frac{PASE_i}{\Delta\nu_i \cdot G_i \cdot h \cdot \nu_i} + \frac{1}{G_i}$$

$\Delta\nu_i$  : Measuring resolution of each channel

$h$  : Planck's constant

$\nu_i$  : Center frequency of each channel (The value obtained by converting the center wavelength  $\lambda_i$  of each channel into frequency)

### 5.3.5 Optical Filter Analysis Function

1. Outline

The following parameters are analyzed in block from the measured waveform of the optical filter:

- (a) FIL-PEAK
  - Peak level
  - Peak wavelength
  - Center wavelength
  - Spectral band width
  - Cross talk value
  - Ripple width
  
- (b) FIL-BOTTOM
  - Bottom level
  - Bottom wavelength
  - Center wavelength
  - Notch width
  - Cross talk value

(Measurement Example)

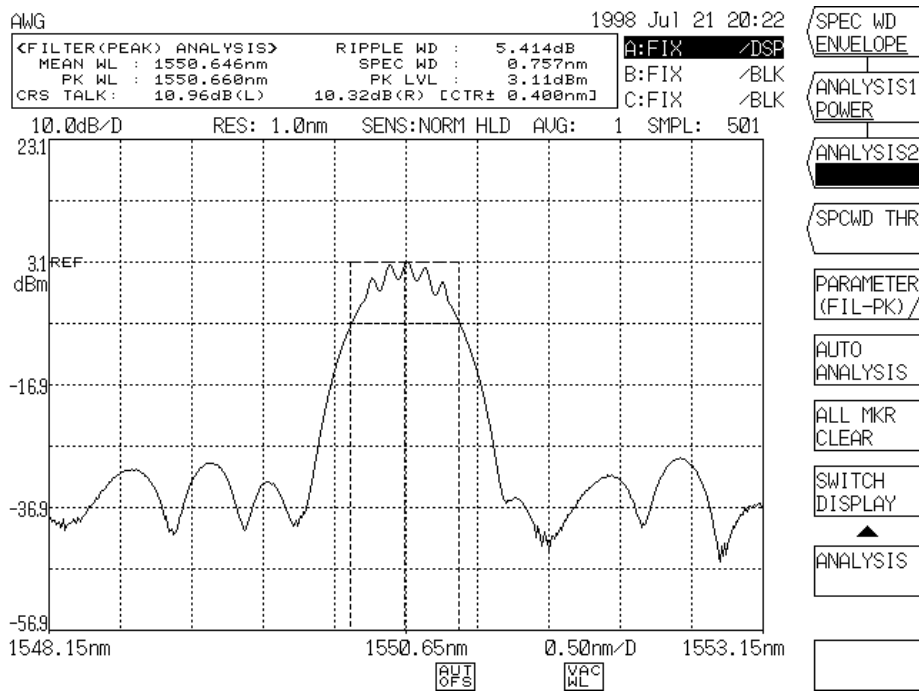

Example of FIL-PEAK Analysis

2. Algorithm

(a) FIL-PEAK

The following explains the analysis items and parameter contents:

- ① Peak level (PEAK LVL) ----- Level value at the waveform peak position
- ② Peak wavelength (PEAK WL) ----- Wavelength value at the waveform peak position
- ③ Center wavelength (MEAN WL)----- Center wavelength value at threshold value TH
- ④ Spectral band width (SPEC WD)----- Spectral band width at threshold value TH
- ⑤ Cross talk value (CRS TALK)

a. With THRESH / PEAK LV Algorithm,

Obtain the level value at the wavelength standard (MEAN WL in case of THRESH or PEAK WL in case of PEAK LV) and obtain the level value at the wavelength  $\pm\lambda$ CH SPACE [nm] away from the wavelength standard. Make the difference between the both level values the cross talk.

b. With ITU-T Algorithm,

Make the ITU-T grid wavelength nearest to the peak wavelength the reference wavelength, and make the difference between the bottom level in the range of the reference wavelength  $\pm\lambda$ SEARCH AREA[nm] and the peak level in the range  $\pm\lambda$ SEARCH AREA[nm] at the position the reference wavelength  $\pm\lambda$ CH SPACE[nm] away the cross talk.

- ⑥ Ripple Width (RIPPLE WD)----- Search the spectral band width, and make the value obtained by subtracting the bottom level from the peak level in the obtained spectral band width the ripple width.

Contents of <PARAMETER> Key at the time of FIL PEAK

FILTER (PEAK) ANALYSIS								
ITEM	SW	ALGO	TH [dB]	K	MODE FIT	MODE DIFF [dB]	CH SPACE [nm]	SEARCH AREA [nm]
PEAK LVL	ON/OFF	—	—	—	—	—	—	—
PEAK WL	ON/OFF	—	—	—	—	—	—	—
MEAN WL	ON/OFF	THRESH/RMS	***	***	OFF	***	—	—
SPEC WD	ON/OFF	THRESH/RMS	***	***	OFF	***	—	—
CRS TALK	ON/OFF	THRESH/PK LVL/ITU-T	***	—	—	—	±***	±***
RIPPLE WD	ON/OFF	THRESH	***	—	—	***	—	—



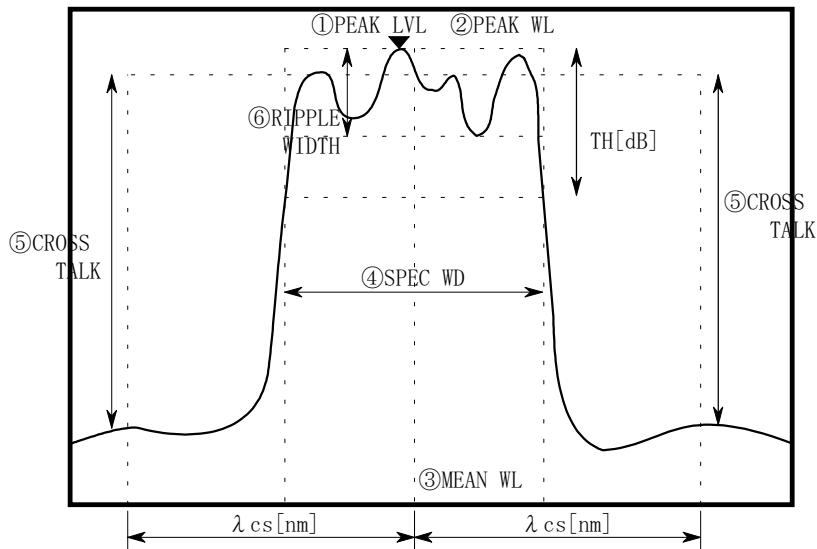

Analysis Items at the time of FIL PEAK

(b) FIL-BOTTOM

The following explains the analysis items and parameter contents:

- ① Bottom level (BTM LVL) ----- Level value at the waveform bottom position
- ② Bottom wavelength (BTM WL) ----- Wavelength value at the waveform bottom position
- ③ Center wavelength (MEAN WL) ----- Center wavelength value at threshold value TH
- ④ Notch width (NOTCH WD) ----- Notch width at threshold value TH
- ⑤ Cross talk value (CRS TALK)
  - a. With PEAK/BOTTOM/BOTTOM LV Algorithm,
    - Obtain the level value at the wavelength standard (MEAN WL in case of PEAK/BOTTOM or BOTTOM WL in case of BOTTOM LV) and obtain the level value at the wavelength  $\pm\lambda_{CH\ SPACE}$  [nm] away from the wavelength standard. Make the difference between the both level values the cross talk.
  - b. With ITU-T Algorithm,
    - Make the ITU-T grid wavelength nearest to the bottom wavelength the reference wavelength, and make the difference between the peak level in the range of the reference wavelength  $\pm\lambda_{SEARCH\ AREA}$  [nm] and the bottom level in the range  $\pm\lambda_{SEARCH\ AREA}$  [nm] at the position the reference wavelength  $\pm\lambda_{CH\ SPACE}$  [nm] away the cross talk.

Contents of <PARAMETER> Key at the time of FIL BOTTOM

FILTER (BOTTOM) ANALYSIS						
ITEM	SW	ALGO	TH [dB]	MODE DIFF [dB]	CH SPACE [nm]	SEARCH AREA [nm]
BTM LVL	ON/OFF	—	—	—	—	—
BTM WL	ON/OFF	—	—	—	—	—
MEAN WL	ON/OFF	PEAK/BOTTOM	***	***	—	—
NOTCH WD	ON/OFF	PEAK/BOTTOM	***	***	—	—
CRS TALK	ON/OFF	PEAK/BOTTOM/ BTM LV/ITU-T	***	—	±***	±***

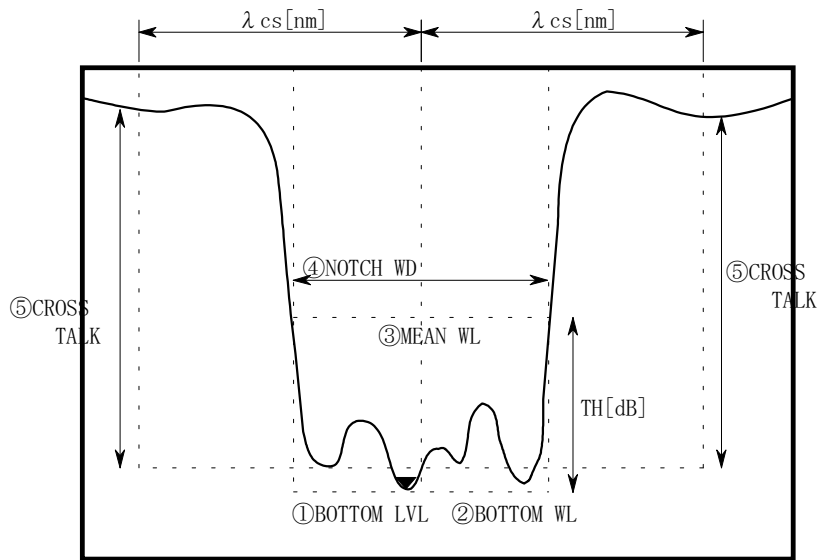

Analysis Items at the time of FIL BOTTOM

## 5.4 Spectrum Width Data Calculation Algorithm

In this equipment, the spectrum width of a displayed waveform can be calculated by the [ANALYSIS] switch. The following explains the three spectrum width calculation methods and the notch width measurement algorithm.

### 5.4.1 Envelope method

- 1) Make a mode search to obtain mode peaks.  
After the mode is judged by the peak/bottom difference (set by [PEAK SEARCH] <MODE DIFF>), the values exceeding the limit value TH2 (set by <ENV TH2>) are found.
- 2) Obtain the spectrum width.  
The method of obtaining it as follows.

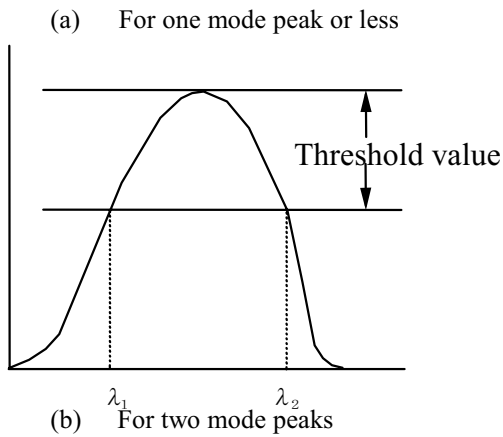

The wavelengths where the spectrum and threshold value TH1 (set by <ENV TH1>) intersect are specified as  $\lambda_1$  and  $\lambda_2$  and  $\lambda_2 - \lambda_1$  is regarded as spectrum width  $\Delta\lambda$ .

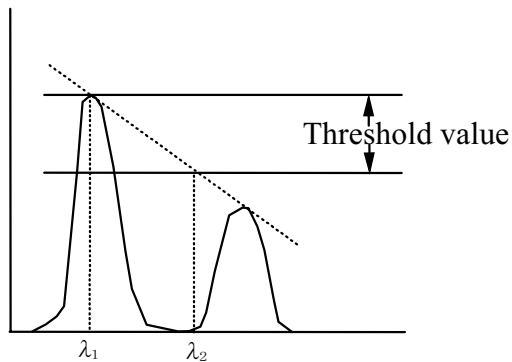

The difference ( $\lambda_2 - \lambda_1$ ) between wavelength  $\lambda_2$  and peak wavelength  $\lambda_1$  where the straight line (envelope) connecting individual peaks intersects with the threshold value TH1 is regarded as spectrum width  $\Delta\lambda$ .

However, when the envelope does not intersect with TH1, the wavelength of 2 mode peak is specified as  $\lambda_1$  or  $\lambda_2$ .

c) For three or more mode peaks

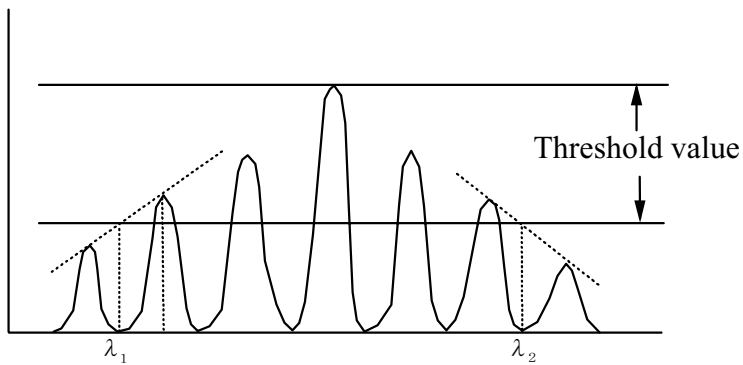

- (i) Connect individual mode peaks by straight line (envelope).
- (ii) When the wavelengths where the envelope intersects with the threshold value TH1 are specified as  $\lambda_1$  and  $\lambda_2$  and  $\lambda_2 - \lambda_1$  is regarded as spectrum width  $\Delta\lambda$ .  
However, when the envelope does not intersect with TH1, the lowest-level mode peak is specified as  $\lambda_1$  or  $\lambda_2$ .

- 3) Multiply the obtained spectrum width  $\Delta\lambda$  by the magnification K (set by <ENV K>).
- 4)  $\lambda_c$  displayed in the data area represent the center of the spectrum width ( $\Delta\lambda$ ).
- 5) The mode peak count above TH2 is shown in the MODE data area.

## 5.4.2 Threshold method

- 1) Make a mode search to find mode peaks. The modes exceeding the peak/bottom difference (set by <MODE DIFF> of [PEAK SEARCH]) are searched.
- 2) Find the spectrum width.

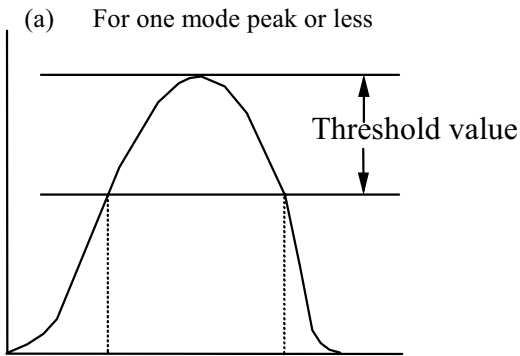

The wavelengths where the spectrum intersects and the threshold value (set by <THRESH TH>) intersect are specified as  $\lambda_1$  and  $\lambda_2$  and  $\lambda_2 - \lambda_1$  is regarded as spectrum width  $\Delta\lambda$ .

(b) For two or more mode peaks

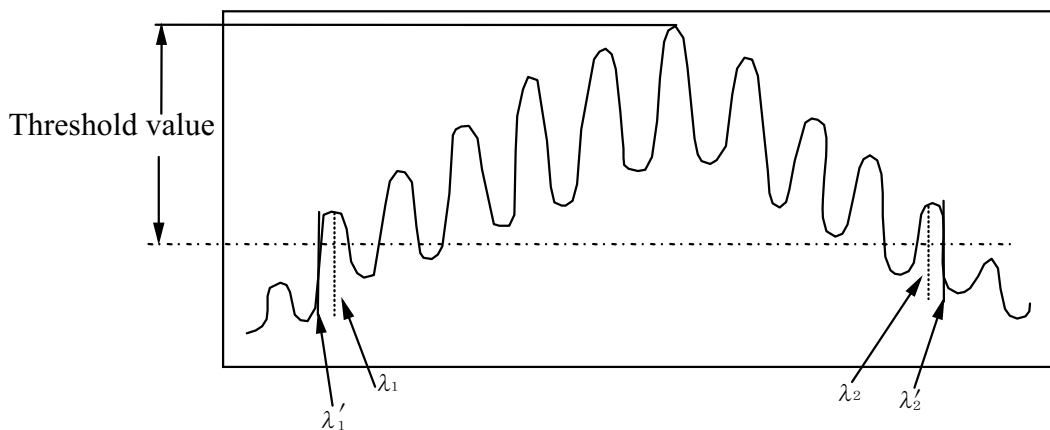

- (i) The most outer mode peak wavelengths exceeding the threshold value TH among mode peaks are specified as  $\lambda_1$  and  $\lambda_2$ .
  - (ii) When the <MODE FIT> key is ON (display in reverse video),  $\lambda_2 - \lambda_1$  is the spectrum width. When the <MODE FIT> key is OFF (display in non-reverse video), find the wavelengths  $\lambda_1'$  and  $\lambda_2'$  being outside  $\lambda_1$  and  $\lambda_2$  where the spectrum and threshold value intersect. Accordingly,  $\lambda_2' - \lambda_1'$  is the spectrum width.
- 3) Multiply the obtained spectrum width  $\Delta\lambda$  by the magnification K (set by <THRESH K>).
  - 4)  $\lambda_c$  displayed in the data area represents the center of the spectrum width ( $\Delta\lambda$ ).
  - 5) The mode peak count between  $\lambda_1$  and  $\lambda_2$  is shown in the MODE data area.

### 5.4.3 RMS (effective value) method

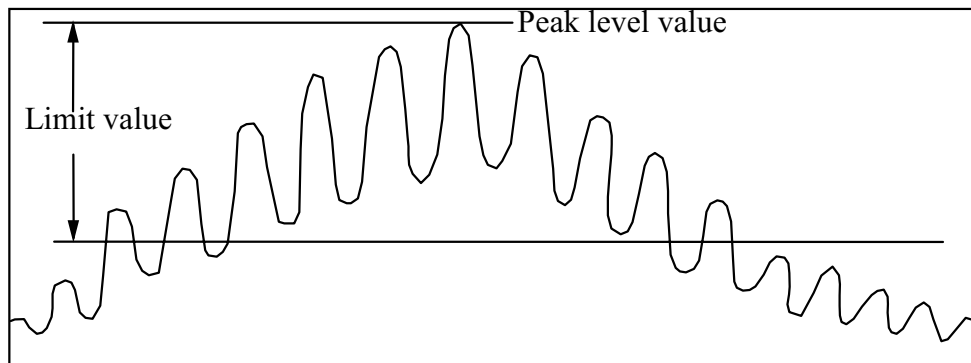

- 1) Take out the data points exceeding the limit value TH (set by <RMS TH>, as shown in the above figure, within the displayed waveform, and find the spectrum width by the following calculation.
- 2) When the RMS method is used, adopt all the points exceeding the limit value TH for calculation. When the PK RMS method is used, the displayed waveforms are searched in Mode Search mode and only the mode peak values above TH are calculated.

- 3) When the wavelength at each point is  $\lambda_i$  and the level at the point is  $P_i$ , the mean wavelength  $\lambda_c$  can be found by the following expression.

$$\lambda_c = \frac{\sum P_i \cdot \lambda_i}{\sum P_i}$$

- 4) By using the mean wavelength  $\lambda_c$  obtained in 3), find the spectrum width  $\Delta\lambda$  by the following expression.

$$\Delta\lambda = K \times \sqrt{\frac{\sum P_i \cdot (\lambda_i - \lambda_c)^2}{\sum P_i}}$$

K : Magnification by which the spectrum width is multiplied.  
(Set by <RMSK>.)

- 5) When the PK RMS method is used, the mode peak count above the TH is shown in the MODE data area.

## 5.4.4 Notch width measurement methods

The threshold value TH\*\*.\*dB is set for active trace waveforms to obtain the notch width  $\Delta\lambda$  and its center wavelength  $\lambda_C$ . In this case, the <PEAK BOTTOM> key is used to set whether the threshold value TH is calculated from the waveform peak level or the bottom level.

(a) At the time of NOTCH-PEAK

- ① Find the minimum point  $\lambda_{min}$  of the level.
- ② Find the point  $\lambda_0$  where the level becomes the maximum on the left side from  $\lambda_{min}$  and find the point  $\lambda_1$  where the level becomes the maximum on the right side from  $\lambda_{min}$ .  
Compare the both levels at  $\lambda_0$  and  $\lambda_1$  and make the larger level  $L_p$ .
- ③ Make the wavelength on the most left side where the spectrum crosses with the level (Log value) of  $L_p-TH$  between  $\lambda_0$  and  $\lambda_{min}$   $\lambda_A$ .  
Make the wavelength on the most right side where the spectrum crosses with the level (Log value) of  $L_p-TH$  between  $\lambda_{min}$  and  $\lambda_1$   $\lambda_B$ .
- ④ The center wavelength can be obtained from the following equation:

$$\lambda_c = \frac{\lambda_A + \lambda_B}{2}$$

- ⑤ The notch width  $\Delta\lambda$  can be obtained from the following equation:

$$\Delta\lambda = \lambda_B - \lambda_A$$

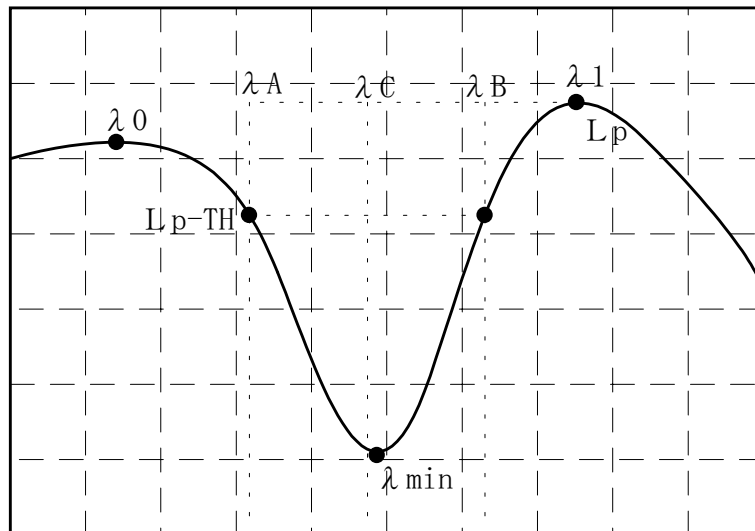

Measurement of Notch Width (PEAK)

(b) At the time of NOTCH-BOTTOM

- ① Find the minimum point  $\lambda_{\min}$  of the level.  
Make the level at the  $\lambda_{\min}$  point  $L_b$ .
- ② Make the wavelength on the most right side where the spectrum crosses with the level (Log value) of  $L_b$ -TH on the left side from  $\lambda_{\min}$   $\lambda_A$ .  
Make the wavelength on the most left side where the spectrum crosses with the level (Log value) of  $L_b$ -TH on the right side from  $\lambda_{\min}$   $\lambda_B$ .
- ③ The center wavelength can be obtained from the following equation:

$$\lambda_c = \frac{\lambda_A + \lambda_B}{2}$$

- ④ The notch width  $\Delta\lambda$  can be obtained from the following equation:

$$\Delta\lambda = \lambda_B - \lambda_A$$

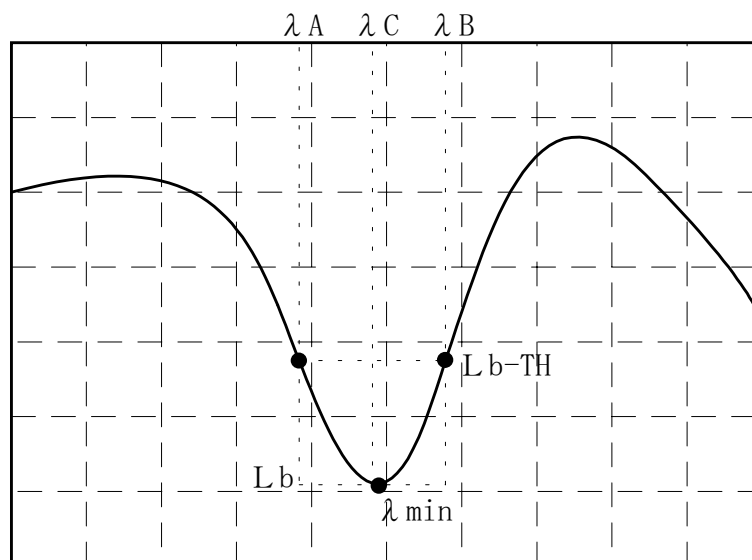

Measurement of Notch Width (BOTTOM)



## 5.5 LONG TERM Measurement

This section describes the LONG TERM measurement.

### 5.5.1 Overview

The LONG TERM measurement performs sweep every fixed time under the currently set conditions and holds the results (peak waveform, level, and SNR of each channel peak) of the WDM analysis.

This measurement can examine the trend of the long-term changes of each WDM channel.

The analysis results are displayed on the LONG TERM menu in DISPLAY mode. The display is also enabled during measurement.

### 5.5.2 Parameter setting

To perform the LONG TERM measurement, several parameters must be preset. This section describes the parameter setting.

The parameters are set using the <PARAMETER> key when <ANALYSIS2 WDM> of the [ANALYSIS] switch is selected.

(1) Setting the number of WDM channels

Open the <PARAMETER> key of the [ANALYSIS] switch and match the number of channels of the system that measures "<MAX NUM>".

(2) Setting the wavelength of each channel

Then open <PRESET WL TABLE> and set the wavelength for the number of channels set in (1).

Channels that are larger than the number of channels set in (1) need not to be set in particular.

The wavelength of each channel depends on the specification of a measuring system.

(3) Setting <CH DETECT>

Open the <PARAMETER> key of the [ANALYSIS] switch and set <CH DETECT>.

This setting is classified into two types "AUTO" and "PRESET".

- When "AUTO" is selected

The WDM analysis is performed and channels are called "CH1, 2 ....." in ascending order of wavelengths.

Accordingly, when the power of one channel is reduced, all the channels with longer wavelengths than the channel are shifted.

Example)

When measuring the light with four wavelengths 1,551.70, 1,552.50, 1,553.3, and 1,554.1 nm, assume that 1,551.70 nm is used for the channel 1, 1,552.50 nm is for the channel 2, 1,553.3 nm for the channel 3, and 1,554.1 nm is used for the channel 4.

If the light with wavelength 1,552.50 nm is not emitted, it is normally emitted to the channel 1 at 1,551.70 nm. However, it is judged that the channel 2 is varied by 0.8 nm from 1,552.50 nm to 1,553.3 nm.

This case also applies to the channel 3.

- When "PRESET" is selected;  
Each channel mainly detects the wavelength selected in (2).  
Accordingly, when the wavelength is shifted and approaches to the preset wavelength of the adjacent channel, it is recognized as the adjacent channel.

Example)

When measuring the light with four wavelengths 1,551.70, 1,552.50, 1,553.3, and 1,554.1 nm, assume that 1,551.70 nm is used for the channel 1, 1,552.50 nm is for the channel 2, 1,553.3 nm for the channel 3, and 1,554.1 nm is used for the channel 4.

If the wavelength of the channel 2 that was originally that of 1,552.50 nm is varied and reaches 1,553.0 nm, properly speaking, it must be judged that the channel 2 was shifted by 0.5 nm. However, for the PRESET operation, it is judged that the channel 3 was shifted by -0.3 nm.

If the wavelengths of all channel wavelengths are greatly varied considering each characteristic of "AUTO" and "PRESET", select "AUTO". If the power of each channel is greatly changed, select "PRESET".

- (4) Setting [ADVANCE] <LONG TERM SWEEP> <WL LIMIT>

When the wavelength shift of each channel exceeds this value, the wavelength is displayed in red on the display screen.

- (5) Setting [ADVANCE] <LONG TERM SWEEP> <UP LIMIT>

When the level shift of each channel exceeds this value, the level is displayed in red on the display screen.

- (6) Setting [ADVANCE] <LONG TERM SWEEP> <LOW LIMIT>

When the level shift of each channel goes below this value, the level is displayed in red on the display screen.

### 5.5.3 Condition setting

When the setting of the parameters described in the preceding section is terminated, the measurement interval and the number of measurement times are set as actual measurement conditions.

For the measurement conditions such as another resolution and span, set them in the same way as the normal measurement.

(1) Setting the measurement interval

Setting the <LT INTVL> key that is the soft key when the [ADVANCE] <LONG TERM SWEEP> key is pressed displays the input screen of the measurement interval.

LT INTVL 1.0 min
---------------------

Then turn the rotary knob (or input using the ten-key pad) to set values.

(2) Setting the number of measurement times

Setting the <RPT TIME> key that is the soft key when the [ADVANCE] <LONG TERM SWEEP> key is pressed displays the input screen of the number of measurement times.

RPT TIME 10
----------------

Then turn the rotary knob (or input using the ten-key pad) to set values

### 5.5.4 Measurement

When the settings of parameters and measurement conditions are terminated, the LONG TERM measurement is enabled.

Execute the <LONG TERM STA STP> key that is the soft key when the [ADVANCE] <LONG TERM SWEEP> key is pressed. The measurement is performed according to the conditions and automatically terminates with the preset number of measurement times.

## 5.5.5 Display of measurement results

During measurement and after the end of measurement, the measurement results can be displayed on the screen above the graph.

Selecting the [ADVANCE] <LONG TERM DISPLAY> key displays the measurement result.

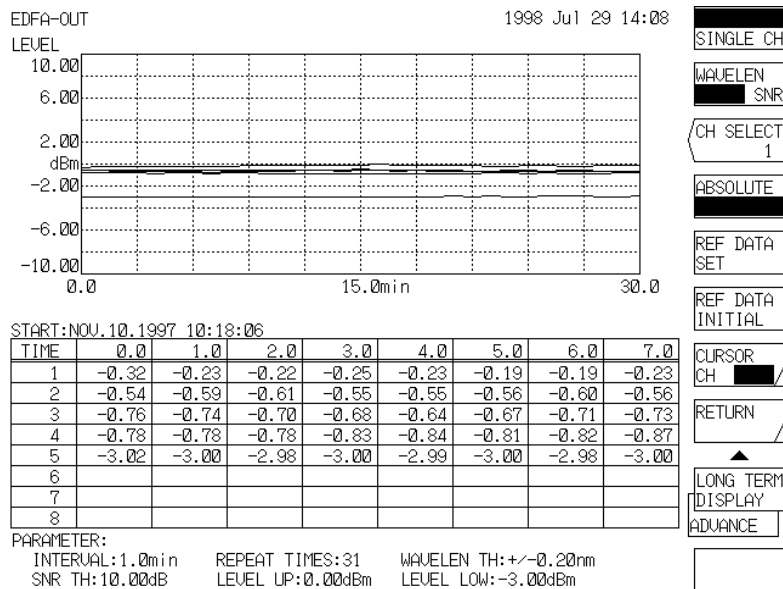

Fig. 5-3 Results of LONG TERM Measurement

### (1) Setting the reference value

The display of LONG TERM measurement can select two display methods of the absolute value display (ABSOLUTE) and relative value display (RELATIVE). If the relative value display is selected, the reference value must be set.

Executing the <REF DATA SET> key that is the soft key when the [ADVANCE] <LONG TERM SWEEP> key is pressed sets the current cursor data to the reference value. When the <REF DATA INITIAL> is executed, the PRESET data input at parameter setting becomes the reference value.

## 5.5.6 ALL CHANNEL display

The measurement results of LONG TERM measurement are displayed by using the two display methods: ALL CHANNEL display that simultaneously displays all channels and SINGLE CHANNEL display that displays only arbitrary channels.

This section describes the ALL CHANNEL display.

### ① Rotary knob operation

Turning the rotary knob moves the cursor above the graph and the enclosed section of the table below the graph.

Subsequently, pressing the rotary knob once and then turning it change the channel. The <CURSOR> key is used to switch the time axis move (horizontal axis) and channel move (vertical axis) of the cursor.

Re-pressing the rotary knob moves the cursor above the graph again.

② Wavelength display

Selecting the WAVELEN of the <WAVELEN LEVEL SNR> key that is the soft key when the [ADVANCE] <LONG TERM DISPLAY> key is pressed changes the vertical axis to the wavelength. In this case, if the <ABSOLUTE RELATIVE> key that is the soft key when the {ADVANCE} <LONG TERM DISPLAY> key is pressed is set to ABSOLUTE, the wavelength becomes an absolute value. When it is set to RELATIVE, the wavelength becomes the relative value display based on the channel to which the cursor is moved.

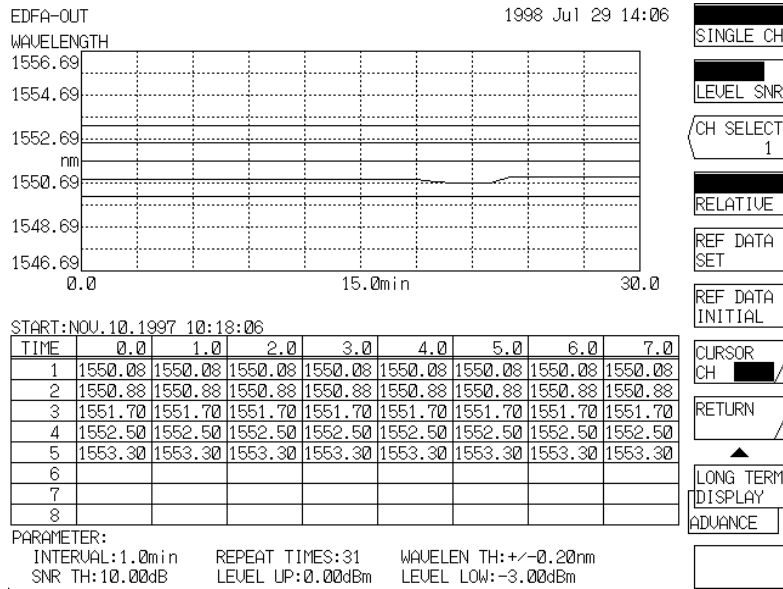

Fig. 5-4 WAVELEN Display ABSOLUTE

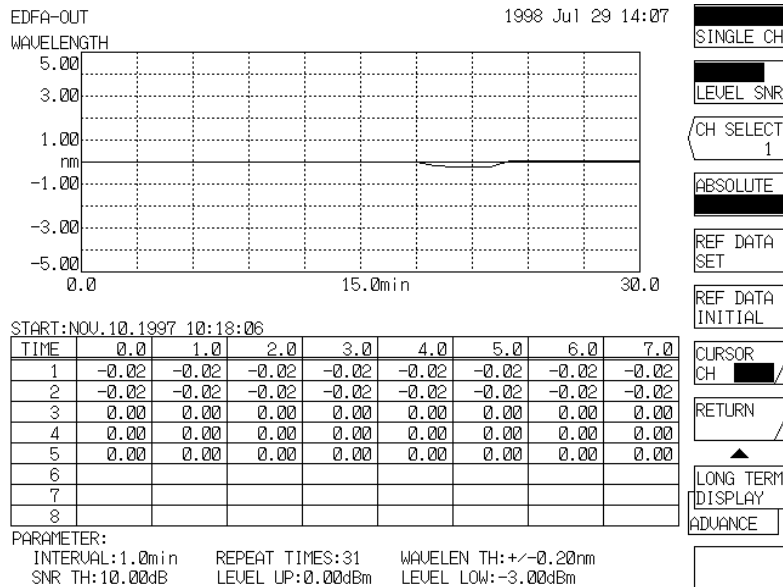

Fig. 5-5 WAVELEN Display RELATIVE

③ Level display

Setting the LEVEL of the <WAVELEN LEVEL SNR> key that is the soft key when the [ADVANCE] <LONG TERM DISPLAY> key is pressed changes the vertical axis to the level.

In this case, if the <ABSOLUTE RELATIVE> key that is the soft key when the [ADVANCE] <LONG TERM DISPLAY> key is pressed is set to ABSOLUTE, the wavelength becomes an absolute value. When it is set to RELATIVE, the wavelength becomes the relative value display based on the channel to which the cursor is moved.

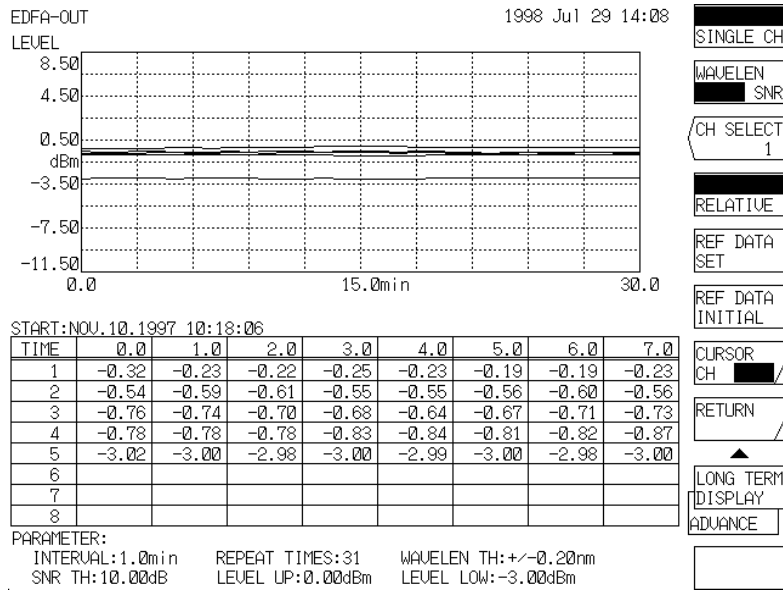

Fig. 5-6 LEVEL Display ABSOLUTE

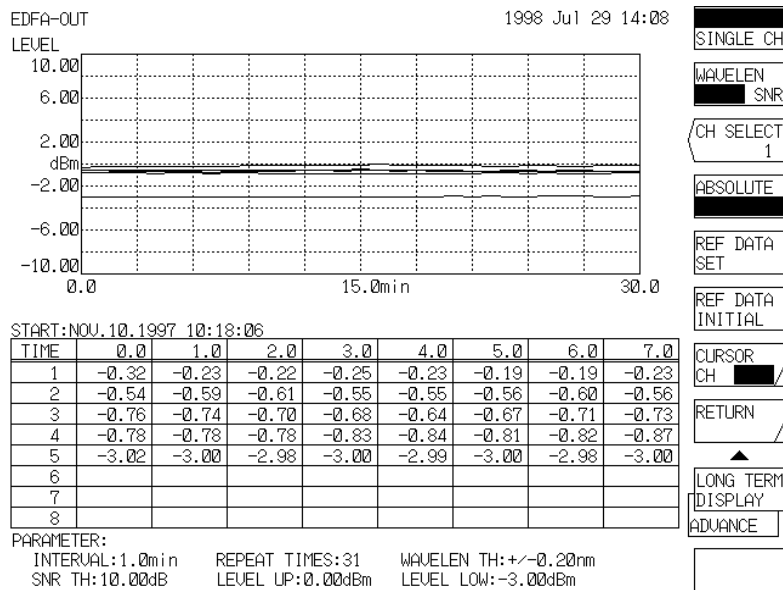

Fig. 5-7 LEVEL Display RELATIVE

④ SNR display

Selecting the SNR of the <WAVELEN LEVEL SNR> key that is the soft key when the [ADVANCE] <LONG TERM DISPLAY> key is pressed changes the vertical axis to the SNR.

In this case, if the <ABSOLUTE RELATIVE> key that is the soft key when the [ADVANCE] <LONG TERM DISPLAY> key is pressed is set to ABSOLUTE, the wavelength becomes an absolute value. When it is set to RELATIVE, the wavelength becomes the relative value display based on the channel to which the cursor is moved.

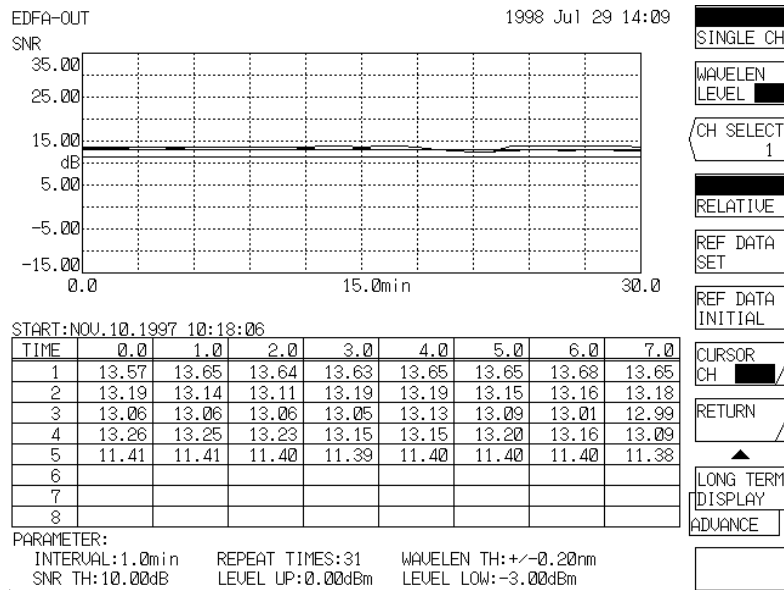

Fig. 5-8 SNR Display ABSOLUTE

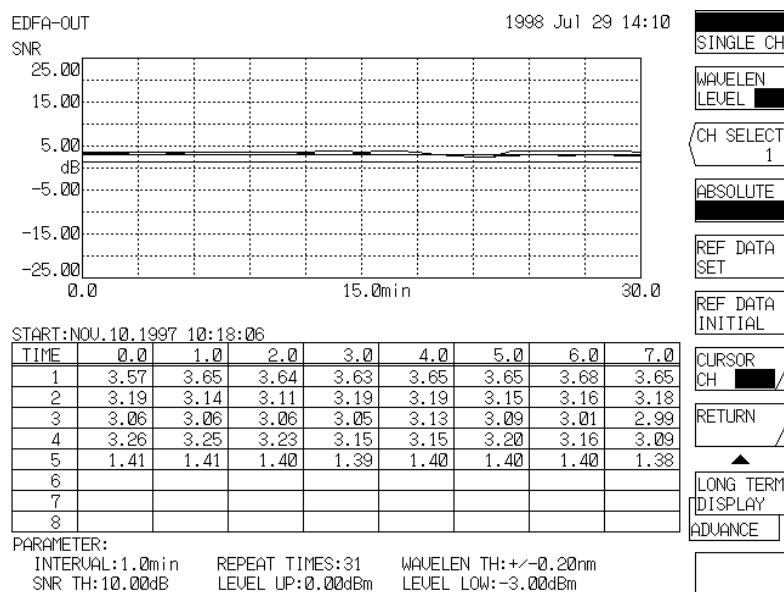

Fig. 5-9 SNR Display RELATIVE



## 5.5.7 SINGLE CHANNEL display

This section describes the SINGLE CHANNEL display.

### ① Channel display

Pressing the <CH SELECT> key that is the soft key when the [ADVANCE] <LONG TERM DISPLAY> key can select the channel to be displayed.

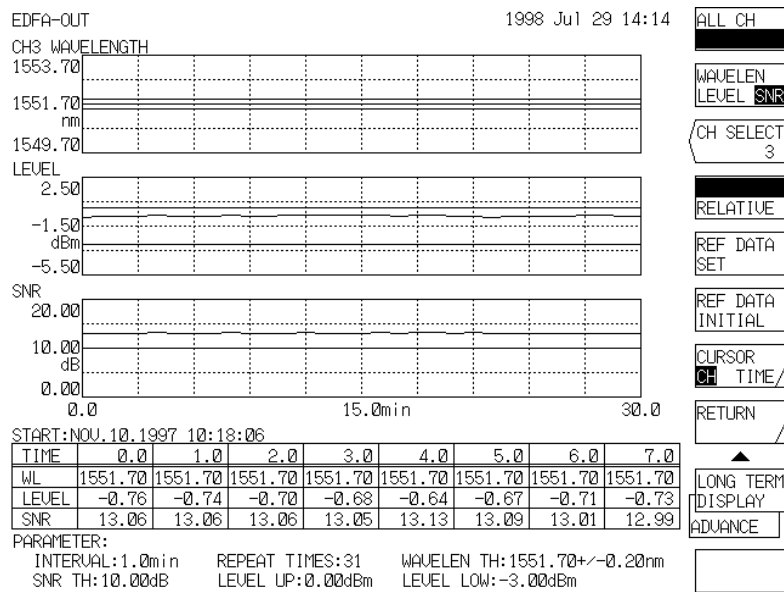

Fig. 5-10 Channel Selection Screen

Then use the rotary knob, step keys or ten-key pad to select the channel and then press the <ENTER> key to fix the channel.

② Switching between the absolute value display and relative value display

In the same way as the ALL CHANNEL display, if the ABSOLUTE of the <ABSOLUTE RELATIVE> key that is the soft key when the [ADVANCE] <LONG TERM DISPLAY> key is pressed is selected, the vertical axis is changed to an absolute value. When it is set to RELATIVE, the wavelength becomes the relative value display based on the channel to which the cursor is moved.

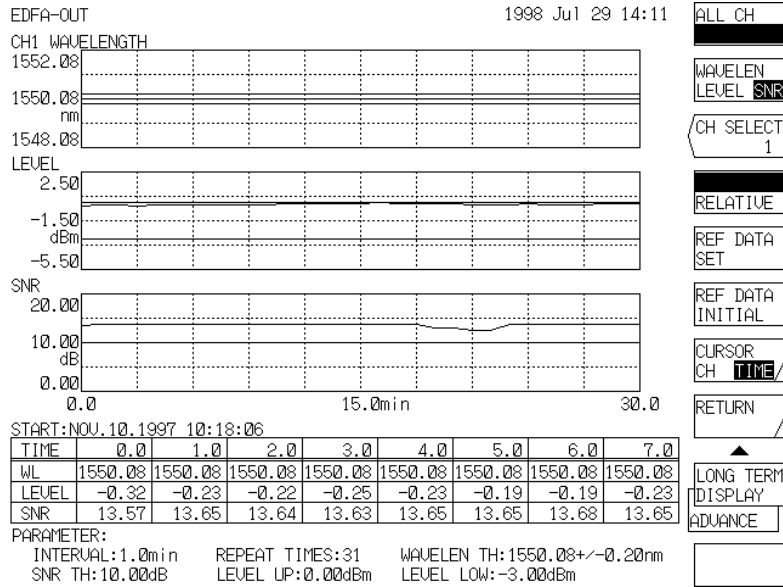

Fig. 5-11 SINGLE CHANNEL Display ABSOLUTE

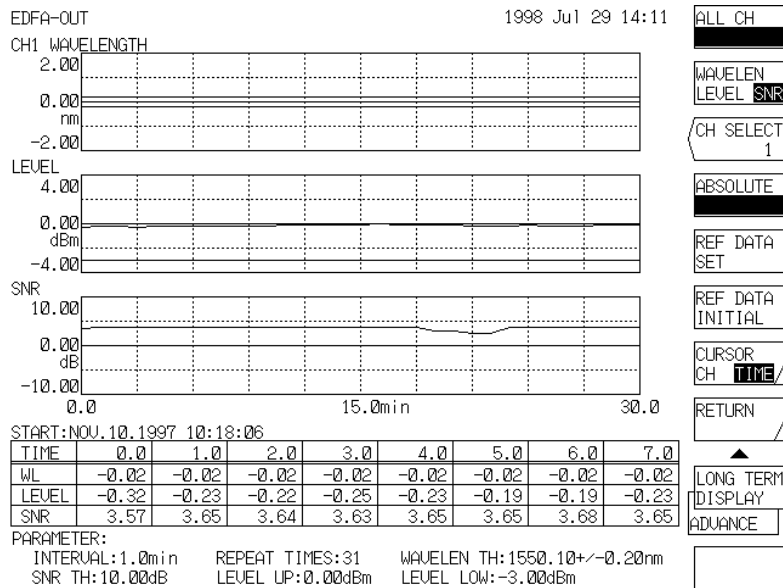

Fig. 5-12 SINGLE CHANNEL Display RELATIVE

## 5.6 Synchronous measurement function with the wavelength tunable laser source

### 5.6.1 Outline

This equipment carries the synchronized sweeping function to work with the AQ4320 Series wavelength tunable laser source (hereafter called AQ4320).

When measuring the wavelength loss characteristics with the optical filters, optical fiber gratings, etc., wideband light sources such as the ASE light source have thus far been used.

With the synchronized sweeping function, the wavelength tunable laser source with narrower wavelength band is being used instead of the ASE light source and the wavelength sweeping function of this equipment and the wavelength sweeping of the wavelength tunable laser source are synchronized.

By so doing, higher resolution can be obtained since the wavelength resolution is being determined by the spectral line width of the wavelength tunable laser source and the wavelength setting resolution. Also, since the wavelength tunable laser source scarcely outputs any other components than the measuring wavelength, and as the noise light which comes out faintly is being totally cut except for the section corresponding to the resolution range of this equipment, extremely high optical dynamic range can be acquired.

### 5.6.2 Connections

Before turning on the power supply, make the following connections:

- (1) Connect the connector "GP-IB2" of this equipment and the connector "GP-IB" of the AQ4320 using the GP-IB cable.
- (2) Connect the "EXT TRIG IN" terminal of this equipment and the "SMPL TRIG OUT" terminal of the AQ4320 using a coaxial cable.
- (3) Connect the "TLS SYNC OUT" terminal of this equipment and the "OSA SYNC IN" terminal of the AQ4320 using a coaxial cable.

### 5.6.3 Operation

- (1) Pressing the <MORE 1/3> key and <TLS ADRS> key of the [SYSTEM] switch, set the GP-IB address of the AQ4320 using the rotary knob, step keys or numeric keys.  
Meanwhile, the GP-IB address of the AQ4320 is being set to "24" when shipped out from the factory. Also, pressing the <MORE 3/3> key and <GP-IB2 ADRS> key of the [SYSTEM] switch, make due setting not to let the address of the GP-IB2 port and the address of the AQ4320 duplicated. also, make sure the <SYSTEM CONTROLLER> key of the same soft key menu is in reversed indication.
- (2) Press the <MORE 2/2> <TLS SYNC SWEEP> keys of the soft key menu of the [SET UP] switch to reverse their indications.
- (3) Execute sweeping of this equipment using the [SWEEP] <REPEAT>, <SINGLE> or <SEGMENT MEASURE> key and sweeping of the wavelength of the AQ4320 is also carried out interlocking with the sweeping of this equipment.
- (4) Press the <TLS SYNC SWEEP> key once again to cancel the reversed indication and the synchronized sweeping function with the AQ4320 becomes in valid.

## 5.6.4 Precautions

- (1) When making measurements of optical devices, first, execute sweeping under the status where the AQ4320 and this equipment are being connected directly by means of short fibers to use the obtained optical spectrum as the reference value. Then, execute sweeping with the specimen device being connected between the AQ4320 and this equipment and deem the acquired optical spectrum as the measured value. After that, by finding out the ratio between the two optical spectra using the trace to trace computing function, the wavelength-loss/transmission-factor can be measured accurately. Refer to Section 8.2.3 and Section 8.2.4 regarding how to use the trace to trace computing function.
- (2) When performing synchronized sweeping of the wavelength, the difference between the wavelength of this equipment and that of the AQ4320 must be fully smaller than a half of the resolution setting of this equipment. To satisfy this requirement, set the resolution of this equipment to 2.0nm. The resolution of actual measurements is being determined by the wavelength step (the quotient of dividing the "sweep width" by the "number of sample - 1") at the time of performing the measurement and, since the resolution setting for this equipment is merely to determine how far to suppress the noise light coming out from the wavelength tunable laser source, setting a wider resolution will not influence the actual measurement resolution.
- (3) Preset the output power and line width of the AQ4320 in advance.
- (4) When the sweeping range exceeds the wavelength setting range of the AQ4320, "WARNING" appears while sweeping is being performed. When this warning is issued, adjust the center wavelength and span setting for this equipment.
- (5) Synchronized sweeping is not workable under the pulse light measurement mode, while "AUTO" measurement is being performed and while "LONG TERM" measurement is being made.

## 5.7 Video Output Specifications

On the rear panel of this equipment, there is a video output terminal from which the same video signals as LCD display are output.

Horizontal scanning frequency : 31.469 kHz

Vertical scanning frequency : 59.94 Hz

Connector : D-sub 15-pin connector

Table 5-2 Video Output Pin Connections (VGA compatible)

Pin No.	Signal name	Remarks
1	RED	Video signal (red)
2	GREEN	Video signal (green)
3	BLUE	Video signal (blue)
4	N.C	Unused
5	GND	Ground
6	GND	Ground
7	GND	Ground
8	GND	Ground
9	N.C	Unused
10	GND	Ground
11	GND	Ground
12	N.C	Unused
13	HSYNC	Horizontal synchronizing signal
14	VSYNC	Vertical synchronizing signal
15	N.C	Unused

## 5.8 Nonvolatile Data Initialize Function

This equipment stores wave data, measuring conditions, soft key select status (display status of keys displayed in reverse video or keys that is reversed by pressing), etc. in memory.

When the power supply is turned off after use, the above status is held.

Besides, 32 data memories for measured waveform storage and 20 programs are held in nonvolatile memory.

By the following operations, the above nonvolatile data can be initialized.

Also, Table 5-5 shows the type of nonvolatile data and the initial value of each data.

- (1) Turn on the power supply pressing the [CENTER] switch.
- (2) The BOOT function (data initialize, software update) is started and the following menu is displayed.

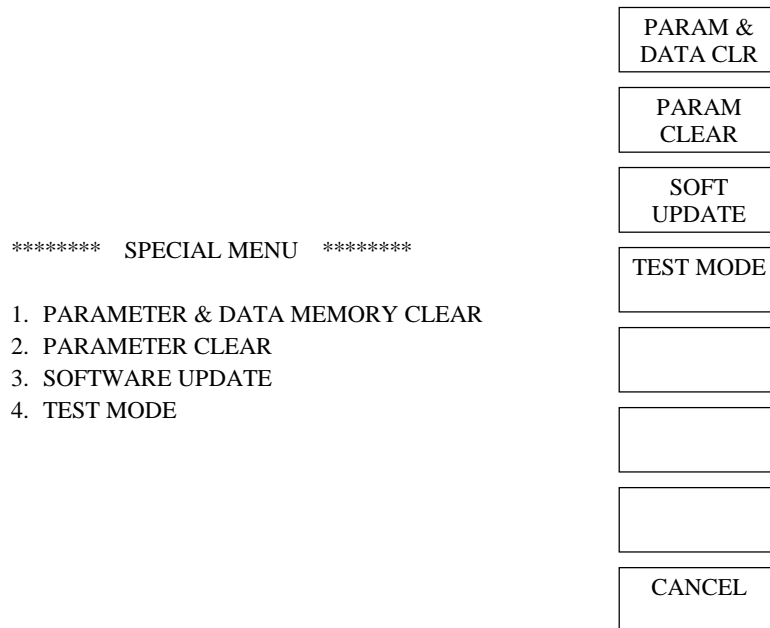

When turning on the power supply pressing [CENTER]

- (3) Press the soft key 1 or 2 depending on the contents to be initialized.
- (4) The contents of each key are as follows.
  - <PARAM & DATA CLR> key  
All of parameters, waveform memory and programs are initialized and the equipment is started in the same status as where it was delivered.  
(The nonvolatile data shown in Table 5-5 is all initialized.)
  - <PARAM CLEAR> key  
Only parameters are initialized and this equipment is started with the normal screen.  
The nonvolatile data is initialized excluding the functions marked with asterisks (\*) shown in Table 5-5.

### CAUTION

*The "LONG TERM" measurement data will be deleted when the power supply is turned off.*

- <CANCEL> key

This equipment is started with the normal screen without doing anything.

The <SOFT UPDATE> key is used for software version-up and the <4. TEST MODE> key is used for adjustment at plant. They must not be operated by the user.

When the key is pressed, the equipment is started with the normal screen by pressing the <EXIT> key at <SOFT UPDATE>.

At <TEST MODE>, the screen displayed by turning on the power supply pressing the [CENTER] switch is displayed again by pressing the <CANCEL> key.

## 5.9 Wavelength Calibrate Function

This equipment is provided a wavelength absolute value calibrate function using the reference light source including gas laser. For details, refer to 5.1.16 [SYSTEM] switch, <WL CAL>.

## 5.10 Setting Clock

This equipment is provided with a clock backed up by battery to display year-month-day and time in the upper right part of the screen. This clock is used as a time stamp for outputting date and time at printer/plotter output and recording data in floppy disk.

For how to set the clock, refer to 5.1.16 [SYSTEM] switch, <SET CLOCK>.

## 5.11 WARNING Display Function

When a fault due to a misoperation occurs or when the select status of other keys are forcibly changed after the select status of a soft key is changed, this equipment displays a WARNING message.

There are two types of message, namely, short message displayed with a number in the window appearing in the middle of the screen, and long message displayed by pressing the [HELP] switch. If the <WARNING> key is selected by the soft key <BUZZER> of the [SYSTEM] switch beforehand, the buzzer sounds to attract attention concurrently with a message display.

Table 5-6 shows warning numbers, short messages and causes of occurrence.

Table 5-3 Initial Value of Nonvolatile Data (1/8)

Item	Function	Initial state
[SWEEP]	<SEG POINT> <SWEEP MKR L1-L2> <SWP INTVL>	1 OFF MINIMUM
[CENTER]	<CENTER> <CENTER THz> <START WL> <START THz> <STOP WL> <STOP THz> <AUTO CENTER>	1250.00 nm 285.517 THz 750.00 nm 171.310 THz 1750.00 nm 399.723 THz OFF
[SPAN]	<SPAN> <SPAN THz> <START WL> <START THz> <STOP WL> <STOP THz> <0 nm SWEEP TIME> <HORZN SCL nm THz>	1000.0 nm 228.41 THz 750.00 nm 171.310 THz 1750.00 nm 399.723 THz 0s nm
[LEVEL]	<REF LEVEL> <LOG SCALE> <LIN SCALE> <BASE LVL> <AUTO REF LEVEL> <dBm dBm/nm> <dBm dBm/THz> <SUB LOG> <SUB LIN> <SUB SCALE> <SUB SCALE> <OFST LVL> <OFST LVL> <SCALE MIN> <SCALE MIN> <LENGTH> <AUTO SUB SCALE>	- 10 dBm ON, 5.0 dB/D OFF 0 mV OFF Dbm  ON, 5.0 dB/D OFF, 0.125/F OFF, 5.0 dB/km OFF, 10.0%/D 0.0 dB 0.0 dB/km 0 0% 1.000 km OFF
[SETUP]	<RESOLN> <SENS> <AVERAGE TIME> <SAMPLING AUTO> <SAMPLING PT> <CW LIGHT MEASURE> <PLS LIGHT MEASURE> <LPF MODE> <PEAK HOLD> <EXT TRG MODE> <RESOLN CORRECT> <TLS SYNC SWEEP> <MEAS WL AIR VAC>	2.0 nm NORM RANG HOLD 1 ON 1001 ON OFF OFF ON, 10 ms OFF OFF OFF OFF VAL
[MARKER]	<SET MARKER 1, 2> <SET MKR> <LINE MARKER 1>	None  None



Table 5-3 Initial Value of Nonvolatile Data (2/8)

Item	Function	Initial state
[MARKER]	<LINE MARKER 2> <LINE MARKER 3> <LINE MARKER 4> <SEARCH L1-L2> <MULTI-MKR DISPLAY> <OFFSET SPACING> <LVL DIGIT> <MARKER AUTO UPDATE> <MKR UNIT>	None None None OFF ON OFFSET 2 OFF nm
[PEAK SEARCH]	<PEAK SEARCH> <BOTTOM SEARCH> <SET MARKER 1, 2> <SET MKA> <AUTO SEARCH> <MODE DIF>	ON OFF None None OFF 3.00 dB
[ANALYSIS]	<SPEC WD ENVELOPE> <ENV TH1> <ENV TH2> <ENV K> <SPEC WD THRESH> <THRESH TH> <THRESH K> <MODE FIT> <SPEC WD RMS> <RMS TH> <RMSK> <SPEC WD PEAK RMS> <PK RMS TH> <PK RMS K> <NOTCH> <NOTCH TH> <PEAK / BOTTOM> <ANALYSIS1 PMD> <ANALYSIS1 SMSR> <SMSR MODE> <SMSR MASK> <ANALYSIS1 POWER> <PWR OFST> <ANALYSIS1 FP-LD> SPEC WIDTH  MEAN WL  TOTAL POWER  MODE NO.	ON 3.0 dB 13.0 dB 1.00 OFF 3.0 dB 1.00 OFF OFF 20.0 dB 2.00 OFF 20.0 dB 2.00 OFF 3.00 dB PEAK OFF OFF 1 ±0.00 nm OFF 0.00 Db — "ALGO" = PK RMS "TH" = 20.00 dB "K" = 2.00 "MODE DIF" = 3.00 dB "ALGO" = PK RMS "TH" = 20.00 dB "K" = 2.00 "MODE DIF" = 3.00 dB "ALGO" = POWER "OFST LEVEL" = 0.00 dB "ALGO" = PK RMS "TH" = 20.00 dB

Table 5-3 Initial Value of Nonvolatile Data (3/8)

Item	Function	Initial state
[ANALYSIS]		"K" = 2.00
		"MODE DIFF" = 3.00 dB
	<ANALYSIS1 DFB-LD>	—
	– X dB WIDTH	"ALGO" = THRESH
		"TH" = 20.00 dB
		"K" = 1.00
		"MODE FIT" = OFF
	SMSR	"MODE DIFF" = 3.00 dB
		"ALGO" =SMSR1
		"MODE DIFF" = 3.00 dB
		"SMSR MASK" = ± 0.00 nm
	<ANALYSIS1 LED>	—
	SPEC WIDTH	"ALGO" = THRESH
		"TH" = 3.00 dB
		"K" = 1.00
		"MODE FIT" = OFF
	MEAN WL	"MODE DIFF" = 3.00 dB
		"ALGO" = RMS
		"TH" = 20.00 dB
	TOTAL POWER	"K" = 2.00
		"ALGO" = POWER
		"OFST LEVEL" = 0.00 dB
	<PMD>	OFF
	<PMD TH>	10.00Db
	<ANALYSIS2 EDFA NF>	—
	<OFST (IN)>	0.00 dB
	<OFST (OUT)>	0.00 dB
	<PLUS MSK>	1.00 nm
	<MINUS MSK>	1.00 nm
	<CVFT TYPE>	GAUSSIAN
	<CVFT THR>	3.00dB
	<ANALYSIS2 WDM>	OFF
	<OFFSET SPACING>	OFFSET
	<REF CHNEL HIGHEST>	ON
	<REF CHNEL NO.>	OFF 1
	<DISPLAY *****>	ABSOLUTE
	<ITU-T TBL REF TBL>	<ITU-T TBL>
	<CH DETECTY AUTO>	ON
	<CH DETECT PRESET>	OFF
	<MAX NUM>	20
	<THRESH>	20.00 dB
	<MODE DIFF>	3.00 dB
	<NOISE POI CTR FIX>	FIX
	<NOISE POI>	0.40 nm
	<NOISE BW>	1.00 nm
	<LVL PRESET>	– 30.00 dBm
	<SNR PRESET>	20.00 dB
	<DISP MASK>	OFF
	<DUAL TRACE>	OFF
	<OUTPUT SLOPE>	OFF

Table 5-3 Initial Value of Nonvolatile Data (4/8)

Item	Function	Initial state
[ANALYSIS]	<ANALYSIS2 WDM-NF> <ASE POINT> <OFST(IN)> <OFST(OUT)> <ANALYSIS2 FIL-PK> <PEAK LVL> <PEAL WL> <MEAN WL> <SPEC WD> <CRS TALK> <RIPPLE WD>	OFF ±0.40nm 0.00dB 0.00dB OFF "SW"="ON" "ALGO"="PEAK LVL" "SW"="ON" "ALGO"="PK WL" "SW"="ON" "ALGO"="THRESH" "TH"=3.00dB "K"=1.00 "MODEFIT"="OFF" "MODE DIFF"=3.00dB "CH SPACE"="-" "SEARCH AREA"="-" "SW"="ON" "ALGO"="HRESH" "TH"=3.00dB "K"=1.00 "MODE FIT"="OFF" "MODE DIFF"=3.00dB "CH SPACE"="-" "SEARCH AREA"="-" "SW"="ON" "ALGO"="HRESH" "TH"=3.00dB "K"=1.00 "MODE FIT"="OFF" "MODE DIFF"=3.00dB "CH SPACE"="±0.40nm" "SEARCH AREA"="-" "SW"="ON" "ALGO"="HRESH" "TH"=3.00dB "K"="-" "MODE FIT"="-" "MODE DIFF"=0.50dB "CH SPACE"="-" "SEARCH AREA"="-"

Table 5-3 Initial Value of Nonvolatile Data (5/8)

Item	Function	Initial state
[ANALYSIS]	<ANALYSIS2 FIL-BTM>	OFF
	<BTM LVL>	"SW"="ON"
	<BTM WL>	"ALGO"="BTM LVL"
	<BTM WL>	"SW"="ON"
	<MEAN WL>	"ALGO"="BTM WL"
	<MEAN WL>	"SW"="ON"
	<MEAN WL>	"ALGO"="BOTTOM"
	<MEAN WL>	"TH"=3.00dB
	<MEAN WL>	"MODE DIFF"=3.00dB
	<MEAN WL>	"CH SPACE"="-"
	<MEAN WL>	"SEARCH AREA"="-"
	<NOTCH WD>	"SW"="ON"
	<NOTCH WD>	"ALGO"="BOTTOM"
	<NOTCH WD>	"TH"=3.00dB
<NOTCH WD>	"MODE DIFF"=3.00dB	
<NOTCH WD>	"CH SPACE"="-"	
<CRS TALK>	"SEARCH AREA"="-"	
<CRS TALK>	"SW"="ON"	
<CRS TALK>	"ALGO"="BOTTOM"	
<CRS TALK>	"TH"=3.00dB	
<CRS TALK>	"MODE DIFF"=3.00dB	
<CRS TALK>	"CH SPACE"= $\pm 0.40\text{nm}$	
<CRS TALK>	"SEARCH AREA"="-"	
<SPECWD THR>	3.00 dB	
<ENVELOPE>	3.00 Db	
<THRESH>	20.00 dB	
<RMS>	20.00 Db	
<PEAK RMS>	3.00 Db	
<NOTCH>	3.00 Db	
<AUTO ANALYSIS>	OFF	



Table 5-3 Initial Value of Nonvolatile Data (7/8)

Item	Function	Initial state
[MEMORY]	<RECALL> <RECALL MEM → A> <RECALL MEM → B> <RECALL MEM → C> <LBL LIST CONDTN> <MEMORY LIST> <LBL LIST CONDTN> *MEMORY NO. 0 to 31	— ON OFF OFF LBL — LBL None
[FLOPPY]	<WRITE> <TRACE RD/WRT> <ABC → FD> <MEMORY → FD> <3D → FD 1st 2nd> <BIN TXT> <DATA RD/WRT> <DATA & TIME> <LABEL> <DATA AREA> <CONDITION> <ADD WRITE OVERWRITE> <GRAPH RD/WRT> <B & W> <PRESET COLOR> <SCREEN COLOR> <BMP TIFF> <READ> <TRACE RD/WRT> <FD → ABC> <FD → MEMORY> <FC → 3D 1st 2nd>	— ON ON, A OFF OFF (, 1st) BIN OFF ON ON ON ON ADD WRITE OFF ON OFF OFF BMP — ON ON, A OFF OFF (,1st)
[PROGRAM]	<PROGRAM EDIT> <EDIT> <PROGRAM LINE> <COMMAND SELECT> <PARAMETER EDIT> <EXEC1 (**)> <EXEC2 (**)> <EXEC3 (**)> <EXEC4 (**)> <EXEC5 (**)> <EXEC6 (**)> *PROGRAM NO.1 to 20	— — ON OFF OFF 01 02 03 04 05 06 None
[SYSTEM]	<SET CLOCK> <YR-MO-DY> <MO-DY-YR> <DY-MO-YR>	— ON OFF OFF

Table 5-3 Initial Value of Nonvolatile Data (8/8)

Item	Function	Initial state
[SYSTEM]	<SET COLOR> <DEFAULT COLOR> <MANUAL COLOR> <CHAR1 CHAR2> <SOFTKEY1 SOFTKEY2> <WINDOW> <MARKER SETTING> <SCALE BASE> <TRACE A B C> <SELECT R G B> <MY ADRS> <TLS ADRS> <BUILT-IN SOURCE> <EXTERNAL SOURCE> <CALIB WL> <WL SHIFT> <LEVEL SHIFT> <AUTO OFFSET> <BUZZER> <CLICK> <WARNING> <GP-IB2 ADR> <SYSTEM CONTROLER> <UNCAL WARNING> <ACTUAL RES DISP> <LOG LIMIT>	— ON, 1 OFF ON, CHAR1 OFF (, SOFTKEY1) OFF OFF OFF OFF (,A) R 1 24 ON OFF 632.816 nm 0.000 nm 0.00 dB ON — ON ON 2 ON ON OFF ±210dB
[ADVANCE]	<LONG TERM SWEEP> <LONG TERM STA STP> <INTER VAL> <RPT TIMES> <WL LIMIT> <UP LIIMT> <LOW LIMIT> <SNR LIMIT> <LONG TERM DISPLAY> <ALL CH SINGLE CH> <WAVLN LEVEL SNR> <CH SELECT> <ABSOLVTE RELATIVE> <Y SCALE AUTO> <Y SCALE MANUAL> <CURSOR CH TIME> <POWER METER> <AREA> <RELATIVE> <dBm W>	— STP 1.0 min 11 0.20 nm —10.00 dBm —30.00 dBm 10.00 dBm — ALL CH WAVLN 1 ABSOLUTE ON OFF CH — FULL OFF dBm

When the <PARAM CLEAR> key of the SPECIAL MENU is pressed, the functions marked with asterisk (\*) are not initialized.

(When the <PARAM & DATA CLR> key is pressed, however, all functions are initialized.)



Table 5-4 WARNING message List (1/3)

No.	Message	Cause of occurrence
1	Unsuitable Resolution	Because resolution setting is improper for the span and the number of samples, there is a possibility that data may not be collected perfectly.
2	Unsuitable Level Scale	In the range fixed mode (SENS: NORMAL RANGE HOLD) or pulse light measuring mode, the level scale was set over 5 dB/D. In the range fixed mode and pulse light measuring mode, if the level scale is set over 5 dB/D, the data in the upper and lower parts of the screen cannot be displayed correctly.
3	Unsuitable Ref Level	In setting the waveform peak level to the reference level, it was set to the nearest value in the reference level setting range because the peak level value was out of the reference level setting range.
4	Unsuitable Marker value	In setting the marker value to the mean wavelength or reference level, it was set to the nearest value in the setting range because the marker value was out of the setting range.
5	<AUTO ANALYSIS> off	The selected status of <AUTO ANALYSIS> was cleared.
6	<AUTO PEAK SRCH> off	The selected status of <AUTO PEAK SEARCH> was cleared.
7	Trace A&B resoln mismatch	The trace A resolution is different from the trace B resolution in setting.
8	<HOLD> off	Because trace assignment for split screen was changed, HOLD was cleared.
9	Trace * state changed	Because the trace in HOLD status was changed from FIX to another, HOLD was cleared.
10	Repeat times changed	The number of times of making measurement has been changed since the data capacity becomes too large while using the "LONG TERM" measurement function.
50	TLS does not respond	The wavelength variable light source does not respond.
51	TLS is not connected	The wavelength variable light source is not connected.
52	Unsuitable TLS mode	The wavelength variable light source is set incorrectly.
53	Unsuitable wavelength range	The wavelength range exceeds the settable range of the wavelength variable light source.

Table 5-4 WARNING message List (2/3)

No.	Message	Cause of occurrence
100	Auto sweeping now	During the AUTO sweep execution, an invalid key was pressed.
101	All traces is in FIXed state	Because all of trace A, B and C are set to FIX, waveform rewrite processing is impossible.
102	Sweep stopped	Because all of trace A, B and C are set to FIX during a sweep, the sweep was stopped.
103	No data in active trace	When there was no data in active trace the setting of moving marker, peak search or the analysis function was executed.
104	Trace A & B mismatch	Because there is a difference in condition setting between trace A and B, subtraction display is impossible.
106	Unsuitable recall condition	At 3-dimensional display, because there is a difference in mean wavelength, span or waveform type in the memory, it cannot redisplayed.
107	Unsuitable memory number	In the memory SAVE or RECALL mode, a number other than 0 to 31 was specified. Or the memory saving no waveform was recalled.
108	Marker setting out of range	When both line marker 1 and 2 are set out of the measuring range, the marker-to-marker analysis was executed.
109	Auto sweep failed	After an AUTO sweep was started, it was stopped because the optimum conditions could not be found.
120	Disk not inserted	No floppy disk is inserted into the drive.
121	Disk not initialized	The floppy disk is not initialized. Or the format that cannot be used in this equipment is initialized.
122	Disk is write protected	The floppy disk is set to write inhibit.
123	File not found	The selected file could not be found, file read cannot be performed. Or no file on disk.
125	Illegal file name	The file name is illegal.
128	File is write protected	The file is in the read-only attribute and data cannot be rewritten or deleted.
129	Disk full	The disk capacity is insufficient to create a file.
130	Directory full	The directory area is full and a file cannot be created.
131	No data	No data to save exist.

Table 5-4 WARNING message List (3/3)

No.	Message	Cause of occurrence
132	File is not a trace file	The file is not a trace file and data cannot be read out.
133	File is not a program file	The file is not a program file and data cannot be read out.
134	File is not a data file	The file is not a data file and data cannot be read out.
135	File is not a setting file	The file is not a setting file and data cannot be read out.
140	No paste possible	In editing a program, empty lines are insufficient, so that paste processing cannot be executed.
141	No merge possible	In editing a program, because the merge result exceeds the maximum number of lines and merge processing cannot be executed.
142	WL calibration failed	In calibrating waveforms, the light source level is insufficient. Or the wavelength deviation exceeds the calibration range, calibrate processing cannot be executed.
160	Printer paper empty	Printer record paper is used up.
161	Printer head up	Because the printer head-up lever is UP, printing is impossible.
163	GP-IB error	The plotter address is incorrect. Or an GP-IB error occurred.
200	Fan motor stopped!	The fan motor stopped.
201	Monochromater error!	The grating operation in the monochromater is abnormal.
202	Monochromater error!	An error occurred in a place other than the grating in the monochromater.
203	Auto offset error!	The AUTO OFFSET operation of the AMP is abnormal.
204	Measure sequence error!	In the sweep status, because the measurement sequence went out of order, the sweep stopped.

5-211

- 1) Numbers are classified according to below 49, 50 to 100, 200 to 299 and 300 to 399 as follows.
  - 1 to 49 ..... After the function is executed, a message is output.
  - 50 to 199 ..... The reason when the function cannot be executed is output.
  - 200 to 299 ..... The message warns a hardware fault.
  - 300 to 399 ..... Error upon execution of a program function (Refer to Chapter 6 Program Functions.)
- 2) The above numbers can be read as talk data for the GP-IB talker command "WARN?".
- 3) Warning priority: Among the above warnings, 200 to 299 (hardware errors) have top priority.
  - If these occur concurrently with another cause, their processing is executed with priority.

# Chapter 6 PROGRAM FUNCTION

This chapter described program functions.

## Contents of Chapter 6

6.1	Outline .....	6-2
6.2	Program Input .....	6-3
6.2.1	Program name input and change .....	6-4
6.2.2	Program input and change .....	6-5
6.2.3	Registered command parameter section change .....	6-9
6.2.4	Line insertion and deletion and program list print .....	6-9
6.3	Program Copy .....	6-11
6.4	Program Deletion .....	6-12
6.5	Program Execution .....	6-13
6.5.1	Executable program selection .....	6-13
6.5.2	Program execution .....	6-14
6.5.3	Program pause .....	6-15
6.5.4	Program execute error .....	6-15
6.6	Description of Commands .....	6-18
6.6.1	Description of variables .....	6-18
6.6.2	Rule of four operations by variables .....	6-20
6.6.3	Specifications of "@=VAL (A\$)" command .....	6-20
6.7	Program Examples .....	6-51

## **6.1 Outline**

The program function means that measuring conditions, measuring procedures and other data are registered and executed. There are 200 steps per program and 20 programs can be created.

Created programs are stored in nonvolatile memory and also can be stored in the built-in floppy disk.

By using this function, automatic measurement can be performed without any external computer.

This function permits control the external unit connected to the connector [GP-IB 2], so that it can be used for various applications.

## 6.2 Program Input

When the <PROGRAM EDIT> key is pressed, the screen shown in Fig. 6-1 is displayed.

Optical Spectrum Analyzer 1998 Jul 29 14:2617

US	NO	PROGRAM NAME	EXEC NO.
	01		1
	02		2
	03		3
	04		4
	05		5
	06		6
	07		
	08		
	09		
	10		
	11		
	12		
	13		
	14		
	15		
	16		
	17		
	18		
	19		
	20		

	PROGRAM NAME
	EDIT
	COPY
	DELETE
	RETURN
	▲
	PROGRAM
	EDIT
	PROGRAM

Fig. 6-1 Screen Displayed by Pressing <PROGRAM EDIT> key

In the No. column, program Nos. 01 to 20 are displayed.

In the US column, "\*" is displayed when the corresponding program No. is already registered.

In the program name display area, program names are displayed.

## 6.2.1 Program name input and change

To a program, a comment of up to 50 characters can be attached as its program name.

On the screen shown in Fig. 6-1, enter a program name and select a program name to be changed by moving the display in reverse video in the No. column up and down by using the rotary knob or step keys.

After number selection, press the <PROGRAM NAME> key. Then, the window character selection and program name input area appear as shown in the following figure, and the same contents as the program name display area are displayed in the program name input area.

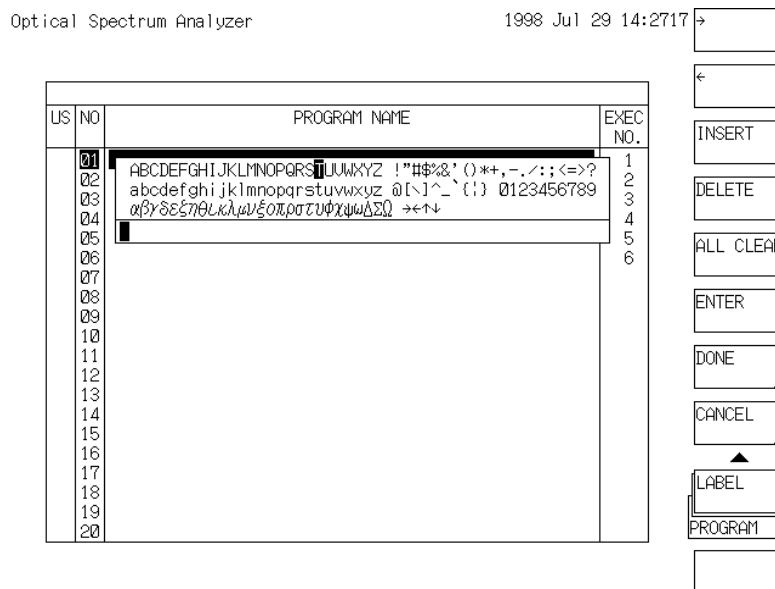

Program Name Input Screen

In the same way as label input, enter and change the program name in the program name input area. After that, when the <DONE> key is pressed, the program name is registered and the window disappears.

### NOTE

- 1) Program names can be entered even before program registration.
- 2) Before executing a program registered by GP-IB, specify its program No., and it is executed.
- 3) When a program name is entered in the programs which have been registered in <EXEC1(\*\*)> to <EXEC6(\*\*)> keys (the software keys which are displayed when the [PROGRAM] switch is pressed), the program name (up to 9 characters) is also displayed on these software keys. However, if the registered program has no list (that is, if an asterisk (\*) is not shown in the US area), the program name is not displayed even when it is entered.

## 6.2.2 Program input and change

On the screen shown in Fig. 6-1, move the display in reverse video in the No. column to the program No. to be entered or changed, and then press the <EDIT> key. Then, the program input screen shown in Fig. 6-2 is displayed.

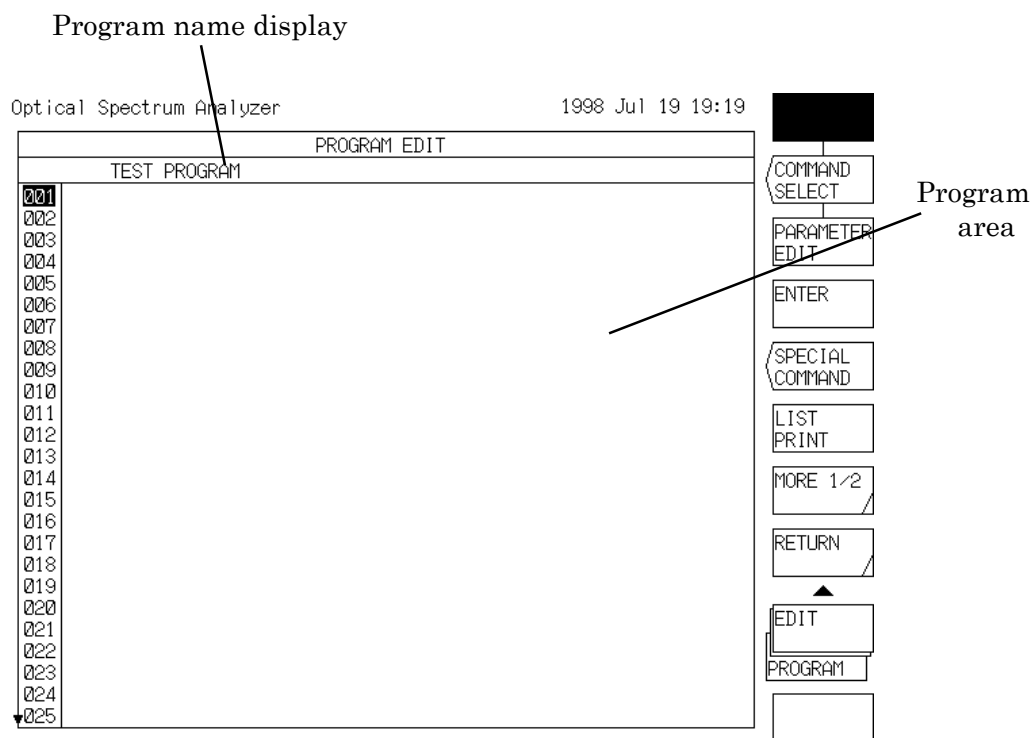

Fig. 6-2 Program Input Screen

- In the program area, the contents of the registered program are displayed together with line numbers. When the <PROGRAM LINE> key is selected, a display in reverse video appears in a line number in the program area. Select a line number for input or change by the rotary knob, step keys or ten key pad and edit the contents to be registered into the program area.
- At the right of the screen, when the <COMMAND SELECT> key is selected, a command list is displayed. When the <SPECIAL COMMAND> key is pressed, a special command list is displayed.
- By pressing the <RETURN> key, the screen shown in Fig. 6-1 is displayed again.

The commands to be registered in the program area are classified into ones that execute the same functions as panel switches (including soft keys), and other special commands.

The special commands are program control commands such as jump command and condition decide command, external unit control commands, and printer character output commands.

In the following, the command input procedure for each command is described.



(1) Registering the panel switch function

- 1) On the program input screen, move the display in reverse video in the program area to a line number to be input or changed.
- 2) When a panel switch is pressed, the command list corresponding to the switch at the right of the screen and one of commands is displayed in reverse video. At this time, if the <COMMAND SELECT> key is selected beforehand, select a command to be registered by the rotary knob or step keys and press the <ENTER> key. Then, the selected command is displayed in the program area.

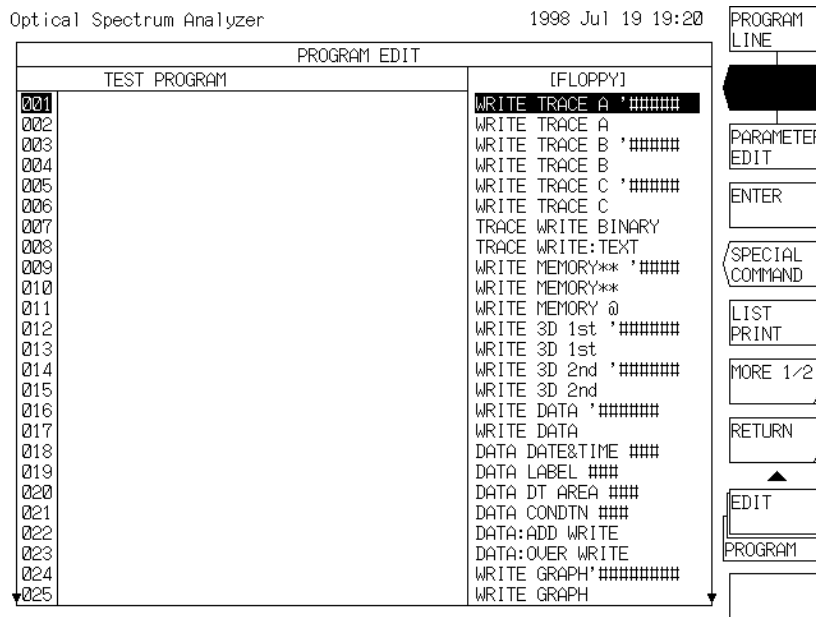

When the selected command is provided with a parameter, the current value or the initial value determined for each command is displayed and the parameter section is displayed in reverse video.

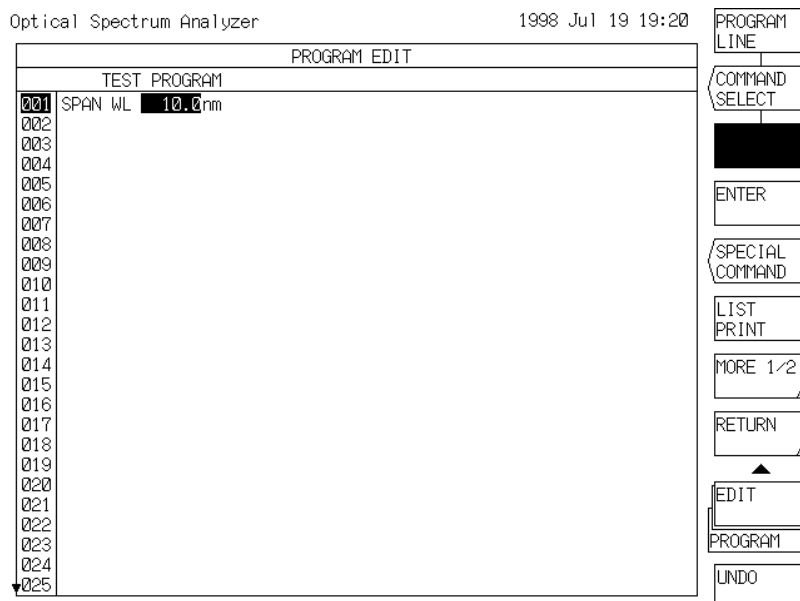

- 3) When the command is provided with parameters and they must be changed, change them by the rotary knob, step keys or ten-key pad.

When the label command or floppy disk command requiring a character input is selected, the window for character selection and the label input area are displayed.

At that time, enter characters in the same way as label input.

By pressing the <DONE> key, the characters are entered in the parameter section.

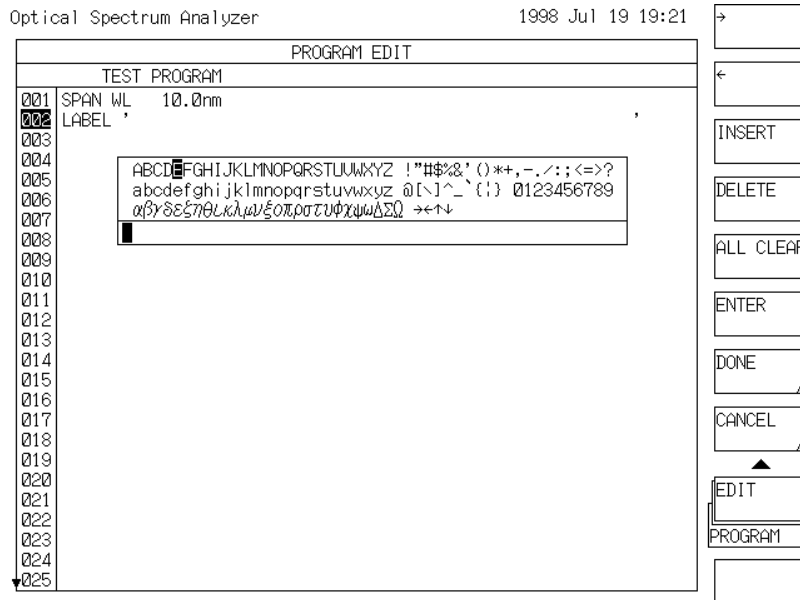

- 4) After registering the command in the program area (after registering parameters when they are provided), the line No. displayed in reverse video moves to the next line.

(2) Registering a special command

- 1) On the program input screen, move the display in reverse video in the program area to a line number to be input or changed.
- 2) When the <SPECIAL COMMAND> key is pressed, a special command list is displayed at the right of the screen and one of commands is displayed in reverse video.

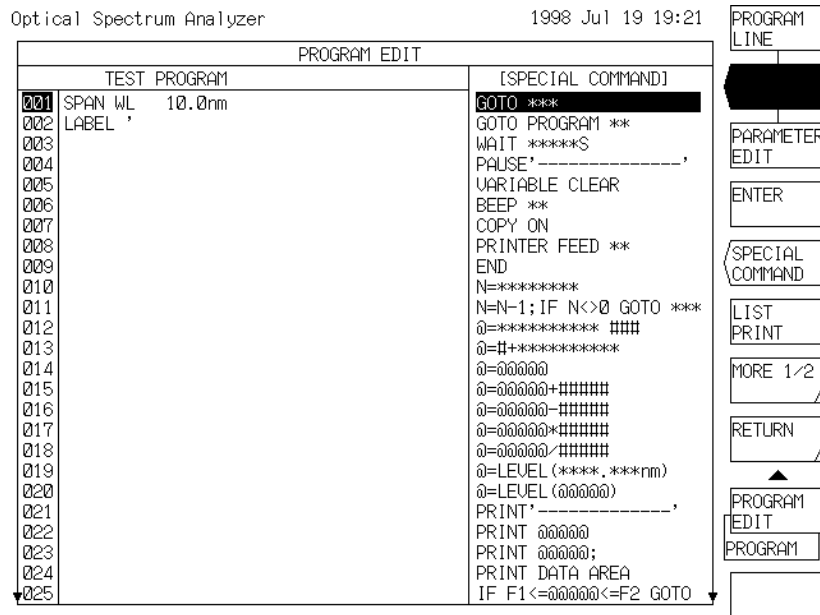

Select a special command to be registered by the rotary knob or step keys and press the <ENTER> key. Then, the selected command is displayed in the program area.

When the command displayed in the program area is provided with parameters, the initial values determined for each command and the parameter section are displayed in reverse video.

- 3) When the command is provided with parameters and they must be changed, change the parameters by the rotary knob, step keys or ten-key pad and press the <ENTER> key. When the print command requiring a character input is selected, the window for character selection is displayed. Enter characters in the same way as label input and press the <DONE> key. Then, the characters are entered in the parameter section.
- 4) After registering the special command in the program area (after registering parameters when the program is provided with parameters), the line number displayed in reverse video moves to the next line.

### 6.2.3 Registered command parameter section change

To change only the parameter section of a command registered in the program area, observe the following procedure.

- 1) Press the <PROGRAM LINE> key and move the display in reverse video to a command line number to be changed by the rotary knob or step keys.
- 2) When the <PARAMETER> key is pressed, if the command is provided with parameters, the parameter section of the command displayed in the program area is displayed in reverse video and change processing is enabled. (When parameters are not provided, the <PROGRAM LINE> key is selected.)

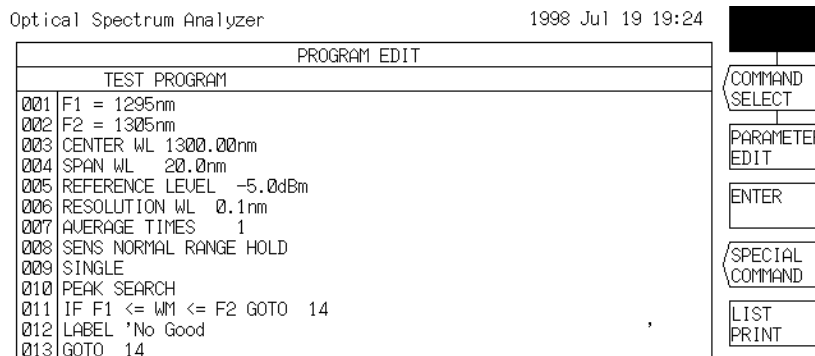

- 3) Change the parameters in the same way as program input. After completion of the change, press the <ENTER> key. Then, the command whose parameters have been changed is registered in the program area.

### 6.2.4 Line insertion and deletion and program list print

To add or delete lines in the program area on the program input screen, press the <MODE 1/2> key to display the soft key menu of 2/2.

- (1) Line insertion

Move the line number displayed in reverse video in the program area to the position where a line is to be inserted, by using the rotary knob or step keys, and press the <LINE INSERT> key.

Then, a blank line is inserted and the part subsequent to the line displayed in reverse video is shifted backward by one line. However, when 200 lines are already filled with registered programs or when the end line of the program reaches the line 200 during line insertion, no line can be inserted.

(2) Line deletion

Move the line number displayed in reverse video in the program area to a line to be deleted by the rotary knob or step keys and press the <AREA CUT> key. Then, the line displayed in reverse video is deleted and the subsequent program is shifted forward by one line.

If the <AREA SELECT> key is pressed when the delete line range is set by the <AREA CUT> key, all the set range is deleted and the subsequent program is shifted to the first line of the set range.

(3) Line copy

Move the line number displayed in reverse video in the program area to a line to be copied by the rotary knob or step keys and press the <AREA INSERT> key. Move it to a line to be inserted or overwritten and press the <PASTE INSERT> key or <PASTE OVR WRITE> key. Then, when the <PASTE INSERT> key is pressed, the contents to be copied are inserted and the program subsequent to the line displayed in reverse video is shifted backward by one line.

To set a line range and insert or overwrite its contents, set the desired copy range by the <AREA SELECT> key before pressing the <AREA COPY> key.

(4) Program list print

When the <LIST PRINT> key is pressed, the list containing the first line to the last line of the program in the edit process is output to the printer.

\*\*\*\*\* Program List \*\*\*\*\*

Program Name : TEST PROGRAM

```
001 FI = 1295.00nm
002 F2 = 1305.00nm
003 CENTER WL 1300.00nm
004 SPAN 20.0nm
005 REFERENCE LEVEL -5.0dBm
006 RESOLUTION 0.1nm
007 AUERAGE TIMES 1
008 SENS NORMAL FANGE HOLD
009 SINGLE
010 PEAK SEARCH
011 IF F1 <= LM <= F2 GOTO 14
012 LABEL 'No Good
013 GOTO 14
014 LABEL 'Good
015 PAUSE 'RETRY
016 GOTO 9
017 END
```

Example of Program List





## 6.5 Program Execution

To execute a registered program, select the program and press the <EXECUTE> key on the screen displayed by pressing the <PROGRAM EXECUTE> key.

In the soft key menu displayed by pressing the [PROGRAM] switch, press any of the <EXEC1 (\*\*)> to <EXEC6 (\*\*)> keys.

In this case, the program must be registered in the <EXEC1 (\*\*)> to <EXEC6 (\*\*)> keys beforehand.  
(\*\* : Program No.)

### 6.5.1 Executable program selection

- (1) For executing a program by the <EXECUTE> key:

On the screen displayed by pressing the <PROGRAM EXECUTE> key, move the display in reverse video in the No. column to a program to be executed by the rotary knob, step keys or ten key pad.

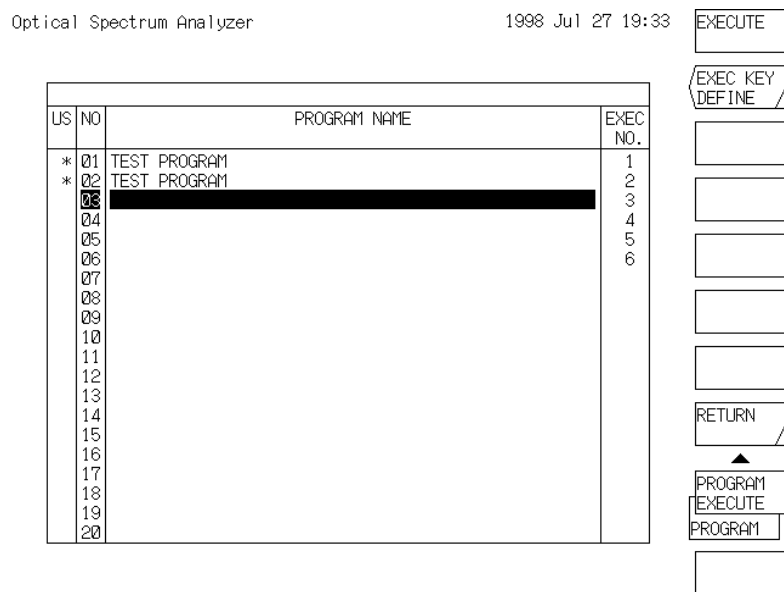

Fig. 6-3 Screen Displayed by Pressing <PROGRAM EXECUTE> key

- (2) For executing a program by the <EXEC1 (\*\*)> to <EXEC6 (\*\*)> keys

- 1) To register a program to the <EXEC1 (\*\*)> to <EXEC6 (\*\*)> keys, move the display in reverse video in the No. column to the program to be registered in the same way as (1) and press the <EXEC KEY DEFINE> key.

The display in reverse video moves as shown in Fig. 6-4.



US	NO	PROGRAM NAME	EXEC NO.
*	01	TEST PROGRAM	1
*	02	TEST PROGRAM	2
	03		3
	04		4
	05		5
	06		6
	07		
	08		
	09		
	10		
	11		
	12		
	13		
	14		
	15		
	16		
	17		
	18		
	19		
	20		

Fig.6-4 Screen Displayed by pressing <EXEC KEY DEFINE> key

- 2) Select a soft key number (<EXEC1 (\*\*)> to <EXEC6 (\*\*)>) of registration destination by the rotary knob, step key or ten key pad and press the <ENTER> key. With this operation, the program selected in 1) is registered into the soft key number selected in 2). The program name (up to 9 characters) is also displayed on the registered software key. If any program is already registered in the number of registration destination, the program number is change

### 6.5.2 Program execution When the <EXECUTE> key is pressed, the program displayed in reverse video in the No. column on the screen displayed by the <PROGRAM EXECUTE> key is executed.

When one of the <EXEC1 (\*\*)> to <EXEC6 (\*\*)> keys is pressed, the program registered in the corresponding key is executed.

The program is executed in sequence starting from line 001 and terminated by the "END" command or a blank line.

To stop program execution, press the auxiliary key <PROGRAM EXIT\*\*> key.

Then, the program stops. (\*\*: Program No. in execution)

### 6.5.3 Program pause

If the "PAUSE" command is used during program execution, this execution pauses.

At this time, a window appears and displays a message and the program name in the pause status.

To continue the execution, press the <CONTINUE> key, and the window disappears and the program is restarted.

When a program is executed by GP-IB, the "PAUSE" command is ignored and the next processing is performed.

### 6.5.4 Program execute error

When an error occurs during program execution, a window appears and displays a number indicating the type of the error and the execution is stopped.

Table 6-1 shows an error list.

#### NOTE

*If a ERROR occurs during program execution, a window appears as usual and displays a number indicating the type of the error and a message, and the program execution is continued.*

- Classification of error numbers

Error numbers are classified as follows.

300 to 319.....	Error occurring upon execution of the setting that must not be operated manually
320 to 339.....	Special command error
340 to 359.....	I/O error
360 to 379.....	Floppy disk error
380 to 399.....	Other error

The above numbers can be read out as talk data in response to the GP-IB talker command "WARN?".

Table 6-1 Error Table for Program Execution (1/2)

No.	Message	Causes of occurrence
300	Parameter out of range	In a command whose parameter is set in a variable, the variable value is out of the range or undefined.
301	Can't execute across mode	In the normal display status, a command related to 3-dimensional display was executed.
302	Scale unit mismatch	In the "LINE MRK3 or 4" command, there is a mismatch in parameter unit between active trace and Y axis scale.
303	No data in active trace	Upon execution of the moving marker set command, peak search command or analysis command, no data exists in active trace.
304	Maker value out of range	In the moving marker or line wavelength marker set command, the specified wavelength is out of the sweep range.
305	No data in trace A or B	Upon execution of the "EDFA NF" command, no waveform data exists in trace A and B.
306	Invalid data	Upon execution of trace memory save or FD write processing, no data exists in trace.
307	Unsuitable write item	Upon execution of "WRITE DATA", all the data items are set at OFF.
320	Undefined variable	A command including an undefined variable was executed.
321	Variable unit mismatch	In a command including two or more variables, there is a mismatch in unit among variables.
322	Overflow	At arithmetic operations, an overflow occurred.
323	Undefined marker variable	When no marker is displayed, a command including a marker value variable was executed.
324	Invalid marker variable	Except immediately after execution of spectral width search or peak search, a command including the corresponding variable was executed.
325	Undefined line number	The jump destination of the GOTO command is not 1 to 2000.
326	F1 greater than F2	Upon execution of the "IF F1 <= @@@@ <= F2" command, F1 > F2.

Table 6-1 Error Table for Program Execution (2/2)

No.	Message	Causes of occurrence
340	Printer paper empty	Printer record paper is used up.
341	Printer head up	Because the printer head-up lever is up, printing is impossible.
345	Option does not respond	The external unit does not respond.
346	Option is not connected	No external unit is connected.
347	GPIB2 not system controller	System controller is set to external computer.(This equipment is not system controller.)
360	Disk full	The disk capacity is insufficient to create a file.
361	Disk not inserted	No floppy disk is inserted into the drive.
362	Disk is write protected	The floppy disk is set to write inhibit.
363	Disk not initialized	The floppy disk is not initialized. Or the format that cannot be used in this equipment is initialized.
365	File not found	The specified file is not found and data cannot be read out or no file is found on the disk.
366	File is write protected	The file is in the read-only attribute and data cannot be rewritten or deleted.
367	No data	No data to save is found.
368	File is not a trace file	The file is not a trace file and data cannot be read out.
369	Illegal file name	The file name is illegal and data cannot be saved.
380	Undefined program	The program was not registered at execution.
381	Syntax error	The command is incorrect. (The contents of the program were changed for some reason.)

## 6.6 Description of Commands

The commands used in a program are classified into commands that are entered from the panel switch and special commands.

Table 6-2 shows a panel switch command list and Table 6-3 shows a special command list.

### 6.6.1 Description of variables

The variables usable in a program are described below.

Variable name	Contents
I	Enters a general purpose variable.
J	Enters a general purpose variable.
K	Enters a general purpose variable.
S	Performs serial polling and stores a received status byte and also used as a general-purpose variable.
X	Enters a general-purpose variable.
Y	Enters a general-purpose variable.
Z	Enters a general-purpose variable.
A\$	Saves the data received by GP-IB 2 port.
FILE\$	Enters the file name upon the last access to the floppy disk.
TIME\$	Enters date and time (Example: 1994 Sep 08 20 : 45 : 37)
WM	Enters the wavelength value of the moving marker.
W1	Enters the wavelength value of fixed marker 1.
W2	Enters the wavelength value of fixed marker 2.
W2-W1	Enters wavelength difference between fixed marker 2 and 1.
LM	Enters the level value of the moving marker.
L1	Enters the level value of fixed marker 1.
L2	Enters the level value of fixed marker 2.
L2-L1	Enters the level difference between fixed marker 2 and 1.
SPWD	Enters the spectral width upon execution of spectral width search.
PKWL	Enters the peak (or bottom) wavelength value upon execution of peak (or bottom) search or spectral width search.
PKLVL	Enters the peak (or bottom) level value upon execution of peak (or bottom) search or spectral width search.
MODN	Enters the number of modes upon execution of spectral width search.

Variable name	Contents
SMSR	Enters the side mode suppression ratio (level difference) upon execution of SMSR measurement.
MKPWR	Enters the power upon execution of marker-to-marker power measurement.
EDFNF	Enters the NF value upon execution of EDFA NF measurement.
GAIN	Enters GAIN value when EDFA NF measurement is executed.
ASELV	Enters ASE LEVEL value when EDFA NF measurement is executed.
PWMTR	Enters the power value upon execution of measurement using the power meter function.
PMD	Enters the PMD value of the PMD analysis.
N	Enters the quadruple counter value.
F <sub>1</sub>	Enters a variable for determining conditions.
F <sub>2</sub>	Enters a variable for determining conditions.

## 6.6.2 Rule of four operations by variables

The rule of giving units after arithmetic operations is shown below.

(1)	Unit	*	No unit	=	Unit	(10)	dB	+	dB	=	dB
(2)	Unit	/	No unit	=	Unit	(11)	dB	-	dB	=	dB
(3)	No unit	+	No unit	=	No unit	(12)	dBm	+	dB	=	dBm
(4)	No unit	-	No unit	=	No unit	(13)	dBm	-	dB	=	dBm
(5)	No unit	*	No unit	=	No unit	(14)	dBm	-	dBm	=	dB
(6)	No unit	/	No unit	=	No unit	(15)	#W	+	#W	=	#W
(7)	nm	+	nm	=	nm	(16)	#W	-	#W	=	#W
(8)	nm	-	nm	=	nm	(17)	#W	/	#W	=	No unit
(9)	nm	/	nm	=	No unit						

Units dBm/nm, W/nm, dB/km, and % are treated as dBm, W, dB and no unit, respectively during handling of variables.

The above operations are performed with variable unit and each unit is given to operation results.

If any other combination of variables is used for calculation (that is, if the variables having different units are operated), the calculation results have no unit.

The unit of variable "#W" is treated as follows:

1 mW	=	1
1 $\mu$ W	=	0.001
1 nW	=	0.000001
1 pW	=	0.000000001

## 6.6.3 Specifications of "@=VAL (A\$)" command

- (1) Ignore the character strings except the number ahead of a numeric value (beginning with sign or number) in the character strings of the A\$ command.

Convert the numbers before ",", or the next character string or a delimiter.

- (2) When no numeric value exists in the character strings of the A\$ command, substitute "0" for the variable @.

Table 6-2 Panel Switch Command List (1/24)

Panel switch	Soft key list display	Program area display	Explanation and range of parameter
SWEEP	AUTO REPEAT SINGLE STOP SEGMENT MEASURE SEG POINT **** SWEEP MKR L1-L2 ### SWP INTVL *****sec	AUTO REPEAT SINGLE STOP SEGMENT MEASURE SEGMENT POINT **** SWEEP MKR L1-L2 ### SWP INTVL *****sec	Auto sweep Repeat sweep Single sweep Stop of sweep Measurement of the specified number of points starting from the wavelength position at a stop. Specifies the number of points to be measured by <SEGMENT MEASURE>. 1 to 20001 (1 step) Selects ON or OFF for the marker-to-marker sweep function. For ###, select ON or OFF by rotary knob. Sets the interval time at repeat sweep. MINIMUM, 1 to 99999 sec (1 step) [MINIMUM when "0" is set.]
CENTER	CENTER WL *****nm CENTER WL @@@@  CENTER FREQ ***.***THz CENTER FREQ @@@@  START WL *****nm START FREQ ***.***THz STOP WL *****nm STOP FREQ ***.***THz PEAK → CENTER	CENTER WL *****nm CENTER WL @@@@  CENTER FREQ ***.***THz CENTER FREQ @@@@  START WL *****nm START FREQ ***.***THz STOP WL *****nm STOP FREQ ***.***THz PEAK → CENTER	Sets the mean wavelength. 600.00 to 1750.00 nm (0.01 step) Sets the variable @@@@ value to the center wavelength. For @@@@, select one of I, J, K, S, X, Y, Z, WM, W1, W2, and PKWL by rotary knob. Sets the center frequency. 171.500 to 499.500 THz (0.001 step) Sets the variable @@@@ to the center frequency. For @@@@, select one of I, J, K, S, X, Y, Z, WM, W1, W2, and PKWL variables by rotary knob. Sets the measurement start wavelength. 0.00 to 1750.00 nm (0.01 step) Sets the measurement start frequency. 1.0 to 499.5 THz (0.1 step) Sets the measurement end wavelength. 600.00 to 2350.00 nm (0.01 step) Sets the measurement end frequency. 171.5 to 674.5 THz (0.1 step) Sets the peak wavelength of the waveform on active trace to the mean wavelength.



Table 6-2 Panel Switch Command List (2/24)

Panel switch	Soft key list display	Program area display	Explanation and range of parameter
CENTER (cont.)	AUTO CENTER ###	AUTO CENTER ###	Select ON or OFF for the peak → enter function to be executed at the end of each sweep. For ###, select ON or OFF by rotary knob.
SPAN	SPAN WL ****.*nm	SPAN WL ****.*nm	Sets the span. 0, 0.5 to 1200.0 nm (0.1 step)
	SPAN WL @@@@	SPAN WL @@@@	Sets the variable @@@@ value to the span. For @@@@, select one of I, J, K, S, X, Y, Z, W2-W1 and SPWD variables by rotary knob.
	SPAN FREQ ***.*THz	SPAN FREQ ***.*THz	Sets the span. 0, 0.10 to 350.00 THz (0.01 step)
	SPAN FREQ @@@@	SPAN FREQ @@@@	Sets the variable @@@@ value to the span. For @@@@, select S, X, Y, Z, W2-W1 and SPWD variables by rotary knob.
	START WL ****.*nm	START WL ****.*nm	Sets the measurement start wavelength. 0.00 to 1750.00 nm (0.01 step)
	START FREQ ***.*THz	START FREQ ***.*THz	Sets the measurement start frequency. 1.0 to 499.5 THz (0.1 step)
	STOP WL ****.*nm	STOP WL ****.*nm	Sets the measurement end wavelength. 600.00 to 2350.00 nm (0.01 step)
	STOP FREQ ***.*THz	STOP FREQ ***.*THz	Sets the measurement end frequency. 171.5 to 674.5 THz (0.1 step)
	$\Delta\lambda \rightarrow$ SPAN	$\Delta\lambda \rightarrow$ SPAN	Performs spectral width search and sets the result as span.
	0nm SWEEP TIME **sec	0nm SWEEP TIME **sec	Sets the time for sweep at a span of 0 nm. MINIMUM, 1 to 50 sec (1 step) [MINIMUM when "0" is set.]
X SCALE UNIT WAVELEN	X SCALE UNIT WAVELENGTH	Sets the unit of the vertical axis to the wavelength display.	
X SCALE UNIT FREQ	X SCALE UNIT FREQUENCY	Sets the unit of the vertical axis to the frequency display.	

Table 6-2 Panel Switch Command List (3/24)

Panel switch	Soft key list display	Program area display	Explanation and range of parameter
LEVEL	REF LEVEL ***.*dBm	REFERENCE LEVEL ***.*dBm	Sets the reference level value in the LOG scale mode. –90.0 to 20.0 dBm (0.1 step)
	REF LEVEL ***.*##	REFERENCE LEVEL ***.*##	Sets reference level value in the linear scale. 1.00 pW to 100 mW (1.00 to 9.99 [pW, mW, μW, mW]: 0.01 step, 10.0 to 99.9 (100) [pW, nW, μW, (mW)]: 0.1 step, 100 to 999 [pW, nW, μW]: 1 step) ## selects either one of pW, nW, μW or mW.
	REF LEVEL @@@@	REF LEVEL @@@@	Sets the variable @@@@ value to the reference level value. For @@@@, select one of I, J, K, S, X, Y, Z, LM, L1, L2, PKLVL, MKPWR, PWMTR and ASELV variables by rotary knob.
	LVL SCALE **.*dB/D	LEVEL SCALE **.*dB/D	Sets the level scale value. LINEAR, 0.1 to 10.0 dB/DIV (0.1 step) [LINEAR when "0" is set.]
	LVL SCALE @@@@	LEVEL SCALE @@@@	Sets the variable @@@@ value to the level scale value. For @@@@, select one of I, J, K, S, X, Y, Z, L2-L1, SMSR, and EDFNF variables by rotary knob.
	BASE LEVEL *****	BASE LEVEL *****	Sets the bottom value of linear scale. 0 to REF level (scale top value) × 0.9 The unit which has been set at REF level is used.
	PEAK → REF LEVEL	PEAK → REF LEVEL	Sets the peak level of the waveform on active trace to the reference level.
	AUTO REF LEVEL ###	AUTO REF LEVEL ###	Selects ON or OFF for the peak → center function to be executed at the end of each sweep. For ###, select ON or OFF by rotary knob.
	LEVEL UNIT #####	LEVEL UNIT #####	Sets the unit of level scale. dBm or dB/nm
	SUB LOG **.*dB/D	SUB SCALE LOG **.*dB/D	Sets the subscale value in the LOG scale mode. 0.1 to 10 dB/DIV (0.1 step)
SUB SCL ***dB/km	SUB SCALE ***dB/km	Sets the subscale value in the dB/km scale mode. 0.1 to 10.0 dB/km/D (at 0.1 step)	

Table 6-2 Panel Switch Command List (4/24)

Panel switch	Soft key list display	Program area display	Explanation and range of parameter
LEVEL (cont.)	SUB LIN **.*/D	SUB SCALE LIN **.*/D	Sets the subscale value in the LIN scale mode. 0.005 to 1.250 (0.005 step)
	SUB SCL *****%/D	SUB SCALE *****%/D	Sets the subscale value in the % scale mode. 0.5 to 125.0%/D (at 0.1 step)
	OFST LVL ***. *dB	OFFSET LEVEL ***. *dB	Sets the subscale offset value in the LOG scale mode. -99.9 to 99.9 dB (0.1 step)
	OFST LVL ****dB/km	OFFSET LEVEL ****dB/km	Sets an offset of subscale in the dB/km scale mode. -99.9 to 99.9 dB/km (at 0.1 step)
	SCALE MIN ****	SUB SCALE MINIMUM ****	Sets the bottom value of subscale in linear scale mode. 0 to 1.25 (at 0.01 step)
	SCALE MIN *****%	SUB SCALE MINIMUM *****%	Sets the bottom value of subscale in % scale mode. 0 to 100 (at 1 step)
	LENGTH **.*** km	LENGTH **.*** km	Sets an optical fiber length. 0.001 to 99.999 km (at 0.001 step)
	AUTO SUB SCALE ###	AUTO SUB SCALE ###	Selects ON or OFF for the auto subscale function to be executed at the end of each sweep. For ###, select ON or OFF by rotary knob.
SETUP	RESOLN WL **. *nm	RESOLUTION WL **. *nm	Sets the resolution. 0.01 to 2 nm (1-2-5 steps)
	RESOLN WL @@@@	RESOLUTION WL @@@@	Sets the variable @@@@ value to the resolution. For @@@@, select one of I, J, K, S, X, Y, Z, W2-W1 and SPWD variables by rotary knob.
	RESOLN FREQ **GHz	RESOLUTION FREQ **GHz	Sets the resolution. 2, 4, 10, 20, 40, 100, 200, 400 GHz
	RESOLN FREQ @@@@	RESOLUTION FREQ @@@@	Sets the variable @@@@ value to the resolution. For @@@@, select one of I, J, K, S, X, Y, Z, W2-W1, and SPWD variables by rotary knob.
	SENS NORM RANG HOLD	SENS NORMAL RANGE HOLD	Sets the measuring sensitivity to the normal fixed range mode.
	SENS NORM RANG AUTO	SENS NORMAL RANGE AUTO	Sets the measuring sensitivity to the normal auto range mode.
	SENS MID	SENS MID	Sets the measuring sensitivity to the medium-sensitivity mode.

Table 6-2 Panel Switch Command List (5/24)

Panel switch	Soft key list display	Program area display	Explanation and range of parameter
SETUP (cont.)	SENS HIGH 1	SENS HIGH 1	Sets the measuring sensitivity to the high-sensitivity mode 1.
	SENS HIGH 2	SENS HIGH 2	Sets the measuring sensitivity to the high-sensitivity mode 2.
	SENS HIGH 3	SENS HIGH 3	Sets the measuring sensitivity to the high-sensitivity mode 3.
	AVERAGE TIMES ****	AVERAGE TIMES ****	Sets the number of averaging times. 1 to 1000 (1 step)
	AVERAGE TIMES @	AVERAGE TIMES @	Sets the averaging count in variable @. "@ " can be I, J, K, S, X, Y, Z or N.
	SAMPLING PT ****	SAMPLING POINT ****	Sets the number of sampling points per sweep. 11 to 20001 (1 step)
	SAMPLING PT @	SAMPLING POINT @	Sets the sample count in variable @. "@ " can be I, J, K, S, X, Y, Z, or N.
	CW LIGHT MEASURE	CW LIGHT MEASURE	Sets continuous light.
	PLS MEAS LPF	PULSE LIGHT MEASURE LPF MODE	Measures pulse light.
	PLS MEAS PK HOLD ****	PULSE LIGHT MEASURE PEAK HOLD MODE ****	Measures pulse light. 1 to 9999 (1 step)
PLS MEAS EXT TRG	PULSE LIGHT MEASURE EXT TRG MODE	Measures pulse light.	
TLS SYNC SWEEP ###	TLS SYNC SWEEP ###	Selects the synchronous measurement with the variable wavelength light source.### :ON/OFF select by rotary knob.	
MARKER	MARKER ****.***nm	MARKER ****.***nm	Sets the marker to the specified wavelength position of the active trace waveform. (by wavelength value) 0.000 to 2350.000 nm (0.001 step)
	MARKER ****.****THz	MARKER ****.****THz	Sets the marker to the specified wavelength position of the active trace waveform. (by frequency value) 1.0000 to 674.5000 THz (0.0001 step)
	MARKER @@@@	MARKER @@@@	Sets marker to wavelength position of variable @@@@. For @@@@, one of variables I, J, K, S, X, Y, Z, WM, W1, W2, or PKWL shall be selected using the rotary knob.

Table 6-2 Panel Switch Command List (6/24)

Panel switch	Soft key list display	Program area display	Explanation and range of parameter
MARKER (cont.)	MARKER → CENTER	MARKER → CENTER	Sets the marker wavelength value to the center wavelength.
	MARKER → REF LEVEL	MARKER → REF LEVEL	Sets the marker level value to the reference level.
	SET MARKER 1	SET MARKER 1	Sets the marker to the fixed marker 1.
	SET MARKER 2	SET MARKER 2	Sets the marker to the fixed marker 2.
	SET MARKER ***	SET MARKER ***	Sets the fixed marker *** to the position of the moving marker. 1 to 200 (1 step)
	CLEAR MARKER ***	CLEAR MARKER ***	Clears the fixed marker ***. 1 to 200 (1 step)
	ALL MARKER CLEAR	ALL MARKER CLEAR	Clears the marker.
	LINE MKR1 ****.***nm	LINE MARKER1 ****.***nm	Sets the line marker 1 to the specified wavelength. 0.000 to 2350.000 nm (0.001 step)
	LINE MKR1 ****.***THz	LINE MARKER1 ****.***THz	Sets line marker 1 to specified frequency. 1.0000 to 674.5000 THz (0.0001 step)
	LINE MKR1 @@@@	LINE MARKER1 @@@@	Sets the line marker 1 to the wavelength position of the variable @@@@. For @@@@, select one of I, J, K, S, X, Y, Z, WM, W1, W2, and PKWL variables by rotary knob.
	LINE MKR2 ****.***nm	LINE MARKER2 ****.***nm	Sets the line marker 2 to the specified wavelength. 0.000 to 2350.000 nm (0.001 step)
	LINE MKR2 ****.***THz	LINE MARKER2 ****.***THz	Sets line marker 2 to specified frequency. 1.0000 to 674.5000 THz (0.0001 step)
	LINE MKR2 @@@@	LINE MARKER2 @@@@	Sets the line marker 2 to the wavelength position of the variable @@@@. For @@@@, select one of I, J, K, S, X, Y, Z, WM, W1, W2, and PKWK variables by rotary knob.
LINE MKR3 ****.***dB	LINE MARKER3 ****.***dB	Sets the line marker 3 to the specified level. -139.900 to 139.900 dB (0.001 step)	
LINE MKR3 ****.***dBm	LINE MARKER3 ****.***dBm	Sets the line marker 3 to the specified level.. -150.00 to 40.00 dBm (0.01 step)	

Table 6-2 Panel Switch Command List (7/24)

Panel switch	Soft key list display	Program area display	Explanation and range of parameter
MARKER (cont.)	LINE MKR3 *.****##	LINE MARKER3 *.****##	Sets the line marker 3 to the specified level. 0 to 9.9999 (0.001 step) For ##, select one of pW, nW, μW, mW and W by rotary knob.
	LINE MKR3 **.***	LINE MARKER3 **.***	Sets the line marker 3 to the specified level. 0 to 10.000 (0.001 step)
	LINE MKR3 @@@@	LINE MARKER3 @@@@	Sets the line marker 3 to the level position of the variable @@@@. For @@@@, select one of I, J, K, S, X, Y, Z, LM, L1, L2, PKLVL, MKPWR, PWMTR and ASELV variable by rotary knob.
	LINE MKR4 ****.***dB	LINE MARKER4 ****.***dB	Sets the line marker 4 to the specified level. -139.900 to 139.900 dB (0.001 step)
	LINE MKR4 ****.***dBm	LINE MARKER4 ****.***dBm	Sets the line marker 4 to the specified level. -150.00 to 40.00 dBm (0.01 step)
	LINE MKR4 *.****##	LINE MARKER4 *.****##	Sets the line marker 4 to the specified level. 0 to 9.9999 (0.001 step) For ##, select one of pW, nW, μW, mW and W by rotary knob.
	LINE MKR4 **.***	LINE MARKER4 **.***	Sets the line marker 4 to the specified level. 0 to 10.000 (0.001 step)
	LINE MKR4 @@@@	LINE MARKER4 @@@@	Sets the line marker 4 to the level position of the variable @@@@. For @@@@, select one of I, J, K, S, X, Y, Z, LM, L1, L2, PKLVL, MKPWR, PWMTR and ASELV variable by rotary knob.
	MKR L1-L2 → SPAN	MKR L1-L2 → SPAN	Sets the range enclosed by the line markers 1 and 2 to the span.
	SEARCH L1-L2 ###	SEARCH L1-L2 ###	Selects ON or OFF for the analysis function in the range enclosed by the line markers 1 and 2. For ###, select ON or OFF by rotary knob.
	LINE MKR CLEAR	LINE MARKER CLEAR	Clears the line mark.
	MARKER OFFSET LIST	MARKER OFFSET LIST	Displays the difference for the moving marker.
	MARKER SPACING LIST	MARKER SPACING LIST	Displays the difference for the adjacent marker.
	MARKER LVL DIGIT*	MARKER LEVEL DIGIT*	Specifies the number of level display digits (below a decimal point) of the marker.
	MARKER LIST PRINT	MARKER LIST PRINT	Prints out the multi-marker value.
MKR UNIT nm	MKR UNIT nm	Displays the wavelength marker value by wavelength.	

Table 6-2 Panel Switch Command List (8/24)

Panel switch	Soft key list display	Program area display	Explanation and range of parameter
MARKER (cont.)	MKR UNIT THz MARKER AUTO UPDATE ###	MKR UNIT THz MARKER AUTO UPDATE ###	Displays the wavelength marker value by frequency. Makes the active trace waveform track the fixed marker level position. For ###, select ON or OFF by rotary knob.
PEAK SEARCH	PEAK SEARCH BOTTOM SEARCH NEXT SRCH NEXT SRCH RIGHT NEXT SRCH LEFT SET MARKER 1 SET MARKER 2 ALL MARKER CLEAR AUTO SEARCH ### MODE DIFF **. **dB SET MARKER *** CLEAR MARKER ***	PEAK SEARCH BOTTOM SEARCH NEXT SEARCH NEXT SEARCH RIGHT NEXT SEARCH LEFT SET MARKER 1 SET MARKER 2 ALL MARKER CLEAR AUTO SEARCH ### MODE DIFF **. **dB SET MARKER *** CLEAR MARKER ***	Executes peak search for the waveform on active trace. Executes bottom search for the waveform on active trace. Searches the peak/bottom subsequent to the marker of the waveform on active trace. Searches the peak/bottom at the right of the marker of the waveform on active trace. Searches the peak/bottom at the left of the marker of the waveform on active trace. Specifies the marker as fixed marker 1. Specifies the marker as fixed marker 2. Clears the marker. Selects ON or OFF for the peak/bottom search function to be executed at each sweep. For ###, select ON or OFF by rotary knob. Sets the level difference of mode criterion to be used for peak search or waveform analysis. 0 to 50.00 dB (0.01 setup) Sets the fixed marker *** to the position of the moving marker. 1 to 200 (1 step) Clears the fixed marker ***. 1 to 200 (1 step)

Table 6-2 Panel Switch Command List (9/24)

Panel switch	Soft key list display	Program area display	Explanation and range of parameter
ANALYSIS	SPEC WD ENV **. *dB	SPEC WD ENV **. *dB	Makes spectral width search by the envelope method with the specified threshold value. 0.01 to 50.00 dB (at 0.01 step)
	ENV TH2 **. *dB	PARAM ENV TH2 **. *dB	Sets the limit value of the spectral width search by the envelope method. 0.01 to 50.00 dB (at 0.01 step)
	ENV K **. **	PARAM ENV K **. **	Sets the magnification of the spectral width search by the envelope method. 0.01 to 10.00 (0.01 step)
	SPEC WD THRESH **. *dB	SPEC WD THRESH **. *dB	Makes spectral width search by the THRESH method with the specified threshold value. 0.01 to 50.00 dB (at 0.01 step)
	THRESH K **. **	PARAM THRESH K **. **	Sets the magnification of the spectral width search by the THRESH method. 0.01 to 10.00 (0.01 step)
	MODE FIT ###	PARAM THRESH MODE FIT ###	Sets ON or OFF for the marker mode peak set function upon execution of spectral width search by the THRESH method. For ###, select ON or OFF by rotary knob.
	SPEC WD RMS **. *dB	SPEC WD RMS **. *dB	Makes spectral width search by the RMS method with the specified threshold value. 0.01 to 50.00 dB (at 0.01 step)
	RMS K **. **	PARAM RMS K **. **	Sets the magnification of the spectral width search by the RMS method. 0.01 to 10.00 (0.01 step)
	SPEC WD PK RMS **. *dB	SPEC WD PK RMS **. *dB	Makes spectral width search by the PEAK-RMS method. 0.01 to 50.00 dB (at 0.01 step)
	PK RMS K **. **	PARAM PEAK RMS K **. **	Sets the magnification of the spectral width search by the PEAK-RMS method. 0.01 to 10.00 (0.01 step)
SPEC WD NOTCH ***dB	SPEC WD NOTCH ***dB	Measures the notch width based on the specified threshold. 0.01 to 50.00 dB (at 0.01 step)	



Table 6-2 Panel Switch Command List (10/24)

Panel switch	Soft key list display	Program area display	Explanation and range of parameter
ANALYSIS (cont.)	NOTCH FROM #####	NOTCH FROM #####	Sets the standard for notch width measurement. For #####, select PEAK or BOTTOM by rotary knob.
	SMSR *	SMSR *	Makes side mode suppression ratio measurement by specifying a mode. 1.2
	SMSR MASK ±**.**nm	SMSR MASK ±**.**nm	Sets the mask range upon execution of SMSR 1 mode. 0 to 99.99 nm (0.01 step)
	POWER	POWER	Makes power measurement.
	PWR OFST ***.**dB	PARAM POWER OFST ***.**dB	Sets the offset value at power measurement. -10.00 to 10.00 dB (0.01 step)
	FP-LD ANALYSIS	FP-LD ANALYSIS	Makes an analysis required for FP-LD.
	DFB-LD ANALYSIS	DFB-LD ANALYSIS	Makes an analysis required for DFB-LD.
	LED ANALYSIS	LED ANALYSIS	Makes an analysis required for LED.
	PMD ANALYSIS	PMD ANALYSIS	Makes an analysis required for PMD.
	PMD THRESH **.**dB	PMD THRESH **.**dB	Sets the threshold of the PMD. 0.01 to 50.00 dB (0.01 step)
	EDFA OFST (IN) ***.**	EDFA NF TRACE A OFST ***.**dB	Sets offset value of signal light which is used in calculation of NF and gain. -99.99 to 99.99 dB
	EDFA OFST (OUT) ***.**	EDFA NF TRACE B OFST ***.**dB	Sets offset value of output light which is used in calculation of NF and gain. -99.99 to 99.99 dB
	EDFA PLUS MASK **.**	EDFA NF PLUS MASK **.**nm	In the ASE level measurement, mask range above peak wavelength is specified to perform NF measurement of optical amplifier. 0 to 10.00 nm (0.01 step)
	EDFA MINUS MASK **.**	EDFA NF MINUS MASK **.**nm	In the ASE level measurement, mask range below peak wavelength is specified to perform NF measurement of optical amplifier. 0 to 10.00 nm (0.01 step)
	EDFA CVFT TYPE GAUS	EDFA NF CURVE FIT TYPE GAUSSIAN	Sets type of curve fit to GAUSSIAN (normal distribution curve) for NF calculation.

Table 6-2 Panel Switch Command List (11/24)

Panel switch	Soft key list display	Program area display	Explanation and range of parameter
ANALYSIS (cont.)	EDFA CVFT TYPE LORENZ	EDFA NF CURVE FIT TYPE LORENZIAN	Sets type of curve fit to LORENZIAN (Lorenz curve) for NF calculation.
	EDFA CVFT TYPE 3rd POLY	EDFA NF CURVE FIT TYPE 3RD POLY	Sets type of curve fit to 3RD POLY (cubic expression) for NF calculation.
	EDFA CVFT TYPE 4th POLY	EDFA NF CURVE FIT TYPE 4TH POLY	Sets type of curve fit to 4TH POLY (biquadratic expression) for NF calculation.
	EDFA CVFT TYPE 5th POLY	EDFA NF CURVE FIT TYPE 5TH POLY	Sets type of curve fit to 5TH POLY (pentagonal expression) for NF calculation.
	EDFA CVFT THR *.*.*	EDFA NF CURVE FIT THRESH *.*.*dB	Sets threshold for curve fit in NF calculation. 0.1 to 99.9 dB (0.1 step)
	WDM ANALYSIS	WDM ANALYSIS	Performs WDM analysis.
	WDM REF HIGHEST	WDM REF CHANNEL HIGHEST	Sets the reference channel of WDM analysis to the peak.
	WDM REF NO **	WDM REF CHANNEL NO.**	Sets the reference channel of WDM analysis. 1 to 200 (at 1 step)
	WDM RESULT TO REF DATA	WDM RESULT TO REF DATA	Sets the latest WDM analysis result to the reference data.
	WDM PRESET TO REF DATA	WDM PREEST TO REF DATA	Sets the preset wavelength value to the reference data.
	WDM ITU-T TO REF DATA	WDM ITU-T TO REF DATA	Sets the ITU-T table value to the reference data.
	WDM THRESH *.*.*dB	WDM THRESH *.*.*dB	Sets the WDM analysis threshold. 0.1 to 50.0 dB (at 0.1 step)
	WDM MAX ***	WDM MAX NUMBER ***	Sets the maximum number of channels for WDM analysis. 1 to 200 channels (at 1 step)
	WDM DIFF *.*.*dB	WDM MODE DIFF *.*.*dB	Sets the minimum difference between top and bottom waveforms for WDM analysis. 0.01 to 50.00 dB (at 0.01 step)
	WDM OFFSET LIST	WDM OFFSET LIST	Displays an offset from the reference channel during WDM analysis.
	WDM SPACING LIST	WDM SPACING LIST	Displays an offset from the adjacent channel during WDM analysis.
	WDM DISPLAY ABSOLUTE	WDM DISPLAY ABSOLUTE	Sets the WDM analysis result display in the absolute value display.

Table 6-2 Panel Switch Command List (12/24)

Panel switch	Soft key list display	Program area display	Explanation and range of parameter
ANALYSIS (cont.)	WDM DISPLAY RELATIVE	WDM DISPLAY RELATIVE	Sets the WDM analysis result display in the relative value display.
	WDM DISPLAY ABS&REL	WDM DISPLAY ABS&REL	Sets the WDM analysis result display in the absolute value and relative value display.
	WDM DISPLAY DRIFT	WDM DISPLAY DRIFT	Sets the WDM analysis result display in the DRIFT display.
	WDM CH DETECT AUTO	WDM CHANNEL DETECTION AUTO	Sets a channel to be detected automatically.
	WDM CH DETECT PRESET	WDM CHANNEL DETECTION PRESET	Sets a channel to be detected by referencing the preset wavelength.
	WDM NOISE POINT FIXED	WDM NOISE POINT FIXED	Sets the noise measurement point to the fixed point.
	WDM NOISE POINT CENTER	WDM NOISE POINT CENTER	Sets the noise measurement point to the center of the channel.
	WDM NOISE POI **.***nm	WDM NOISE POINT **.***nm	Sets the noise measurement point. 0.00 to 10.00 nm (0.01 step)
	WDM NOISE BW *.**	WDM NOISE BANDWIDTH *.**	Sets the bandwidth during noise measurement. 0.0 to 1.00 nm (0.01 step)
	WDM CH WAVLEN ***;##.#	WDM CHANNEL WAVELENGTHS ***;####.##nm	Sets the preset wavelength to the ***-th (-st, - nd) channel. *** : CHANNELs 1 to 200 (1 step) ####.## : WAVELENGTHs 600.00 to 1750.00 nm (0.01 step)
	WDM CH FREQ ***;###.##	WDM CHANNEL FREQ ***;###.####THz	Sets the preset frequency to the ***-th (-st, - nd) channel. *** : CHANNELs 1 to 200 (1 step) ###.###: FREQUENCIES 171.500 to 499.500 nm (0.001 step)
	WDM UNIT WAVELEN	WDM UNIT WAVELEN	Sets so that the preset wavelength is displayed as a wavelength.
	WDM UNIT FREQ	WDM UNIT FREQ	Sets so that the preset wavelength is displayed as a frequency.
	WDM LEVEL PRESET **.**	WDM LEVEL PRESET **.***nm	Sets the preset value of the level. -90.00 to 20.00 dBm (0.01 step)
WDM SNR PRESET **.**	WDM SNR PRESET **.***nm	Sets the preset value of the SNR. 0.00 to 50.00 dB (0.01 step)	

Table 6-2 Panel Switch Command List (13/24)

Panel switch	Soft key list display	Program area display	Explanation and range of parameter
ANALYSIS (cont.)	WDM DISP MASK ***.**	WDM DISP MASK ***.**dBm	Sets the threshold value at the channel display masking time. ***.** : OFF, 10.00 to -100.00dBm(0.01 step)
	WDM CH SW ***;###	WDM CHANNEL SW ***;###	Sets the ON/OFF switch of the ***th channel.
	WDM PRSET COPY ON	WDM PRSET COPY ON	Outputs the active wavelength table to the printer.
	WDM REF REF TABLE	WDM REF REF TABLE	Sets so that the reference data is referred to at the relative value displaying time.
	WDM REF ITU-T TABLE	WDM REF ITU-T TABLE	Sets so that the ITU-T TABLE is referred to at the relative value displaying time.
	WDM MAX/MIN RESET	WDM MAX/MIN RESET	Reset the MAX/MIN data at the drift measuring time.
	WDM OUTPUT SLOPE ###	WDM OUTPUT SLOPE ###	Displays the least square approximate value line of the channel peak. For ###, select ON or OFF by rotary knob.
	WDM DUAL TRACE ###	WDM DUAL TRACE ###	Sets so that the both A and B traces are used at the WDM analyzing time. For ###, select ON or OFF by rotary knob.
	WDM NF ANALYSIS	WDM NF ANALYSIS	Execute the multichannel NF analysis.
	WDM NF NOISE POINT ###	WDM NF NOISE POINT ##.##nm	Sets the ASE level measuring point. ##.## : 0.00 to 10.00nm
	WDM NF OFFSET(IN)***	WDM NF OFFSET(IN)***.**dB	Set the signal light offset value. ***.** : -99.99 to 99.99dB
	WDM NF OFFSET(OUT) ***	WDM NF OFFSET(OUT) ***.**dB	Set the output light offset value. ***.** : -99.99 to 99.99dB
	FILTER(PEAK) ANALYSIS	FILTER(PEAK) ANALYSIS	Makes an analysis necessary for the optical filter (PEAK).
	FILTER(BOTTOM)ANALYSIS	FILTER(BOTTOM)ANALYSIS	Makes an analysis necessary for the optical filter (BOTTOM).
	ALL MARKER CLEAR	ALL MARKER CLEAR	Clears the marker.
AUTO ANALYSIS ###	AUTO ANALYSIS ###	Selects ON or OFF for the wave analysis function to be executed at sweep. For ###, select ON or OFF by rotary knob.	

Table 6-2 Panel Switch Command List (14/24)

Panel switch	Soft key list display	Program area display	Explanation and range of parameter
TRACE	WRITE A	WRITE	Sets the trace A to the write mode.
	FIX A	FIX A	Sets the trace A to the fixed data mode.
	MAX HOLD A	MAX HOLD A	Sets the trace A to the maximum value detection mode.
	ROLL AVG A ***	ROLL AVG A ***	Sets the trace A to the sequential averaging mode. 2 to 100 (1 step)
	DISPLAY A	DISPLAY A	Sets the trace A to the data display mode.
	BLANK A	BLANK A	Sets the trace A to the data non-display mode.
	ACTIVE TRACE A	ACTIVE TRACE A	Sets the trace A to the active trace.
	WRITE B	WRITE B	Sets the trace B to the write mode.
	FIX B	FIX B	Sets the trace B to the fixed data mode.
	MIN HOLD B	MIN HOLD B	Sets the trace B to the minimum value detection mode.
	ROLL AVG B ***	ROLL AVG B ***	Sets the trace B to the sequential averaging mode. 2 to 100 (1 step)
	DISPLAY B	DISPLAY B	Sets the trace B to the data display mode.
	BLANK B	BLANK B	Sets the trace B to the data non-display mode.
	ACTIVE TRACE B	ACTIVE TRACE B	Sets the trace B to the active trace.
	WRITE C	WRITE C	Sets the trace C to the write mode.
	FIX C	FIX C	Sets the trace C to the fixed data mode.
	A-B → C	A-B → C	Sets the trace C to the trace A-B subtraction display mode (LOG).
	B-A → C	B-A → C	Sets the trace C to the trace B-A subtraction display mode (LOG).
	A-B(LIN) → C	A-B(LIN) → C	Sets the trace C to the trace A-B subtraction display mode (LIN).
	B-A(LIN) → C	B-A(LIN) → C	Sets the trace C to the trace B-A subtraction display mode (LIN).
A+B(LIN) → C	A+B(LIN) → C	Sets the trace C to the trace A+B subtraction display mode (LIN).	
NORMALIZE C	NORMALIZE C	Sets the trace C to the normalization waveform display mode.	

Table 6-2 Panel Switch Command List (15/24)

Panel switch	Soft key list display	Program area display	Explanation and range of parameter
TRACE (cont.)	CURVE FIT C **dB	CURVE FIT C **dB	Sets the trace C to the curve fit display mode. 0 to 99 dB (1 step)
	CURVE FIT PK C **dB	CURVE FIT PK C **dB	Sets the trace C to the peak curve fit display mode. 0 to 99 dB (1 step)
	DISPLAY C	DISPLAY C	Sets the trace C to the data display mode.
	BLANK C	BLANK C	Sets the trace C to the data non-display mode.
	ACTIVE TRACE C	ACTIVE TRACE C	Sets the trace C to the active trace.
	TRACE A → B	TRACE A → B	Copies the trace A to the trace B.
	TRACE A → C	TRACE A → C	Copies the trace A to the trace C.
	TRACE B → A	TRACE B → A	Copies the trace B to the trace A.
	TRACE B → C	TRACE B → C	Copies the trace B to the trace C.
	TRACE C → A	TRACE C → A	Copies the trace C to the trace A.
TRACE C → B	TRACE C → B	Copies the trace C to the trace B.	
DISPLAY	NORMAL DISPLAY	NORMAL DISPLAY	Sets the screen to the normal display mode.
	SPLIT DISPLAY	SPLIT DISPLAY	Sets the screen to the 2-split display mode.
	TRACE A UP	TRACE A UPPER	Sets the trace A to the upper screen of 2-split display.
	TRACE A LOW	TRACE A LOWER	Sets the trace A to the lower screen of 2-split display.
	TRACE B UP	TRACE B UPPER	Sets the trace B to the upper screen of 2-split display.
	TRACE B LOW	TRACE B LOWER	Sets the trace B to the lower screen of 2-split display.
	TRACE C UP	TRACE C UPPER	Sets the trace C to the upper screen of 2-split display.
	TRACE C LOW	TRACE C LOWER	Sets the trace C to the lower screen of 2-split display.
	UPPER HOLD ###	UPPER HOLD ###	Fixes the upper screen of 2-split display.
	LOWER HOLD ###	LOWER HOLD ###	Fixes the lower screen of 2-split display.

Table 6-2 Panel Switch Command List (16/24)

Panel switch	Soft key list display	Program area display	Explanation and range of parameter
DISPLAY (cont.)	3D DISPLAY	3D DISPLAY	Sets the screen to 3-dimensional display mode.
	3D ANGLE **	3D ANGLE **	Sets the angle of 3-dimensional display. +50 to -50 deg (10 steps)
	3D RECALL	3D RECALL	Redisplays 3-dimensional display waveforms.
	3D Z-SCALE **	3D Z-SCALE **	Sets the number of waveforms of 3-dimensional display. 3 to 16 (1 step)
	3D MEMORY 1st	3D MEMORY 1st	Sets the buffer memory to be used for 3-dimensional display to 0 to 15.
	3D MEMORY 2nd	3D MEMORY 2nd	Sets the buffer memory to be used for 3-dimensional display to 16 to 31.
	LABEL '-----'	LABEL '-----' 50 characters -----'	Displays a comment in the label area. When a semicolon ";" is added to the end of the command, the comment (variable value) specified by the next LABEL command is displayed in succession.
	LABEL @@@@	LABEL @@@@	Displays the contents of the variable @@@@ in the label area. For @@@@, select one of I, J, K, S, X, Y, Z, WM, W1, W2, W2-W1, LM, L1, L2 L2-L1, SPWD, PKWL, PKLVL, MODN, SMSR, MKPWR, EDFNF, GAIN, ASELV, PWMTR, A\$, FILE\$ and TIME\$ variables by rotary knob.
	LABEL @@@@;	LABEL @@@@;	Display the contents of the variable @@@@ by label. The comment (variable value) specified by the next LABEL command is displayed in succession.
	LABEL CLEAR	LABEL CLEAR	Clear the label.
	NOISE MASK ***dB	NOISE MASK ***dB	Masks and displays the waveform data that is less than the specified level. OFF, 0 to -100 dBm (1 step)
	MASK LINE VERTICAL	MASK LINE VERTICAL	Sets less than mask value to ZERO.
	MASK LINE HORIZONTAL	MASK LINE HORIZONTAL	Sets less than mask value to mask value.
	GRAPH CLEAR	GRAPH CLEAR	Clears the waveforms of trace A, B and C and also data.

Table 6-2 Panel Switch Command List (17/24)

Panel switch	Soft key list display	Program area display	Explanation and range of parameter
MEMORY	SAVE A → MEM **	SAVE A → MEM **	Writes the waveform of trace A into the memory of the specified number. 0 to 31 (1 step)
	SAVE A → MEM @	SAVE A → MEM @	Writes the waveform of trace A into the memory of the number in variable @. For @, select of I, J, K, S, X, Y and Z variables by rotary knob.
	SAVE B → MEM **	SAVE B → MEM **	Writes the waveform of trace B into the memory of the specified number. 0 to 31 (1 step)
	SAVE B → MEM @	SAVE B → MEM @	Writes the waveform of trace B into the memory of the number in variable @. For @, select of I, J, K, S, X, Y and Z variables by rotary knob.
	SAVE C → MEM **	SAVE C → MEM **	Writes the waveform of trace C into the memory of the specified number. 0 to 31 (1 step)
	SAVE C → MEM @	SAVE C → MEM @	Writes the waveform of trace C into the memory of the number in variable @. For @, select of I, J, K, S, X, Y and Z variables by rotary knob.
	RECALL MEM ** → A	RECALL MEM ** → A	Reads the waveform of the memory of the specified memory into the trace A. 0 to 31 (1 step)
	RECALL MEM @ → A	RECALL MEM @ → A	Reads the waveform of the memory of the number in variable @ into the trace A. For @, select one of I, J, K, S, X, Y and Z variables by rotary knob.
	RECALL MEM ** → B	RECALL MEM ** → B	Reads the waveform of the memory of the specified memory into the trace B. 0 to 31 (1 step)
	RECALL MEM @ → B	RECALL MEM @ → B	Reads the waveform of the memory of the number in variable @ into the trace B. For @, select one of I, J, K, S, X, Y and Z variables by rotary knob.
RECALL MEM ** → C	RECALL MEM ** → C	Reads the waveform of the memory of the specified number into the trace C. 0 to 31 (1 step)	



Table 6-2 Panel Switch Command List (18/24)

Panel switch	Soft key list display	Program area display	Explanation and range of parameter
MEMORY (cont.)	RECALL MEM @ → C	RECALL MEM @ → C	Reads the waveform of the memory of the number in variable @ into the trace C. For @, select one of I, J, K, S, X, Y and Z variables by rotary knob.
FLOPPY	WRITE TRACE A '#####	WRITE TRACE A '#####.WA*'	Writes the waveform of trace A into the floppy disk by specifying a file name. '#####': File name
	WRITE TRACE A	WRITE TRACE A	Writes the waveform of trace A into the floppy disk. A file name is automatically given. ("W****")
	WRITE TRACE B '#####	WRITE TRACE B '#####.WA*'	Writes the waveform of trace B into the floppy disk by specifying a file name. '#####': File name
	WRITE TRACE B	WRITE TRACE B	Writes the waveform of trace B into the floppy disk. A file name is automatically given. ("W****")
	WRITE TRACE C '#####	WRITE TRACE C '#####.WA*'	Writes the waveform of trace C into the floppy disk by specifying a file name. '#####': File name
	WRITE TRACE C	WRITE TRACE C	Writes the waveform of trace C into the floppy disk. A file name is automatically given. ("W****")
	TRACE WRITE BINARY	TRACE WRITE: BINARY	Sets the format for writing trace waveform into the floppy disk to binary.
	TRACE WRITE TEXT	TRACE WRITE: TEXT	Sets the text format to write the trace waveforms on a floppy disk.
	TRACE WRITE ASCII	TRACE WRITE: ASCII	Sets the format for writing trace waveforms into the floppy disk to ASCII.
	WRITE MEMORY** '#####	WRITE MEMORY** '#####.WA'	Enters a file name and writes the memory of the specified number into the floppy disk. **: 0 to 31, '#####': File name
WRITE MEMORY**	WRITE MEMORY**	Writes the memory of the specified number into the floppy disk. **: 0 to 31. A file name is automatically given. ("W****")	
WRITE MEMORY @	WRITE MEMORY @	Writes the memory of the number in variable @ into the floppy disk. A file name is automatically given. For @, select of I, J, K, S, X, Y and Z variables by rotary knob.	

Table 6-2 Panel Switch Command List (19/24)

Panel switch	Soft key list display	Program area display	Explanation and range of parameter
FLOPPY (cont.)	WRITE 3D 1st '#####	WRITE 3D 1st '#####.3D3'	Writes 3-dimensional display waveforms (0 to 15) into the floppy disk by specifying a file name. '#####': File name
	WRITE 3D 1st	WRITE 3D 1st	Writes 3-dimensional display waveforms (0 to 15) into the floppy disk. A file name is automatically given. ("T****")
	WRITE 3D 2nd '#####	WRITE 3D 2nd '#####.3D3'	Writes 3-dimensional display waveforms (16 to 31) into the floppy disk by specifying a file name. '#####': File name
	WRITE 3D 2nd	WRITE 3D 2nd	Writes 3-dimensional display waveforms (16 to 31) into the floppy disk. A file name is automatically given. ("T****")
	WRITE DATA '#####	WRITE DATA '#####.DT3'	Writes the contents of the data area into the floppy disk by specifying a file name. '#####': File name
	WRITE DATA	WRITE DATA	Writes the contents of the data area into the floppy disk A file name is automatically given. ("D****")
	DATA DATE&TIME ###	DATA DATE&TIME ###	Selects date and time as data for writing by the <WRITE DATA> key. For ###, select ON of OFF by rotary knob.
	DATA LABEL ###	DATA LABEL ###	Select label information as data for writing by the <WRITE DATA> key. For ###, select ON or OFF by rotary knob.
	DATA DT AREA ###	DATA DT AREA ###	Selects the contents of the data area as data for writing by the <WRITE DATA> key. For ###, select ON or OFF by rotary knob.
	DATA CONDTN ###	DATA CONDITION ###	Selects measuring conditions as data for writing by the <WRITE DATA> key. For ###, select ON or OFF by rotary knob.
	DATA:ADD WRITE	DATA:ADD WRITE	Selects the additional writing of data files.
	DATA:OVERWRITE	DATA:OVERWRITE	Selects the overwriting of data files.
	WRITE GRAPH '#####	WRITE GRAPH '#####.***'	Specifies the file name and stores it on a floppy disk. '#####': File name
WRITE GRAPH	WRITE GRAPH	Stores a graphic file on a floppy disk. The file is named automatically.	

Table 6-2 Panel Switch Command List (20/24)

Panel switch	Soft key list display	Program area display	Explanation and range of parameter
FLOPPY (cont.)	GRAPH COLOR: B&W	GRAPH COLOR: B&W	Sets the graphic file(s) to the monochrome mode.
	GRAPH COLOR: PRESET	GRAPH COLOR: PRESET	Sets the graphic file(s) to the preset color mode.
	GRAPH COLOR: SCREEN	GRAPH COLOR: SCREEN	Sets the graphic file(s) to the screen color mode.
	GRAPH TYPE: BMP	GRAPH TYPE: BMP	Specifies the BMP graphic file format.
	GRAPH TYPE: TIFF	GRAPH TYPE: TIFF	Specifies the TIFF graphic file format.
	WRITE SETTING '#####	WRITE SETTING '#####.SET'	Writes measuring conditions, soft key latch status and user key registration information into the floppy disk by specifying a file name. '#####': File name
	WRITE SETTING	WRITE SETTING	Writes measuring conditions, soft key latch status and user key registration information into the floppy disk. A file name is automatically given. ("S****")
	WRITE LONG TRM '#####	WRITE LONG TERM '#####.LT2'	Writes the long term measurement result in the floppy disk by specifying a file name. '#####': File name
	WRITE LONG TRM	WRITE LONG TERM	Writes the long term result in the floppy disk. A file name is assigned automatically.
	READ TRACE A '#.WA*	READ TRACE A '#####.WA*'	Reads a waveform from the floppy disk into the trace A. '#####.WA*': File name
	READ TRACE B '#.WA*	READ TRACE B '#####.WA*'	Reads waveform from the floppy disk into the trace B. '#####.WA*': File name
	READ TRACE C '#.WA*	READ TRACE C '#####.WA*'	Reads waveform from the floppy disk into the trace C. '#####.WA*': File name
	READ MEMORY** '#.WA*	READ MEMORY** '#####.WA*'	Reads a waveform from the floppy disk into the floppy disk. **: 0 to 31, '#####.WA*': File name
	READ 3D 1st '#####	READ 3D F '#####.3D3'	Reads 3-dimensional waveforms (0 to 15) from the floppy disk. '#####.3D3': File name
	READ 3D 2nd '#####	READ 3D S '#####.3D3'	Reads 3-dimensional waveforms (16 to 31) from the floppy disk. '#####.3D3': File name
READ DATA '#####	READ DATA '#####.DT3'	Reads and displays data from the floppy disk. '#####.DT3': File name	

Table 6-2 Panel Switch Command List (21/24)

Panel switch	Soft key list display	Program area display	Explanation and range of parameter
FLOPPY (cont.)	READ SETTING '#####	READ SETTING '#####.ST3'	Reads and sets measuring conditions, soft key latch status and user key registration information from the floppy disk. '#####.ST3': File name
	READ LONG TRM '#####	READ LONG TERM '#####.LT2'	Reads and sets the long term measurement result from the floppy disk. '#####.LT2': File name
	DELETE '#####	DELETE '#####.\$\$\$'	Deletes a file in the floppy disk. '#####.\$\$\$': File name
	DISK INITIALIZE 1.2M	DISK INITIALIZE 1.2M	Initializes the floppy disk in the 1.2M byte mode.
	DISK INITIALIZE 1.44M	DISK INITIALIZE 1.44M	Initializes the floppy disk in the 1.44M byte mode.
SYSTEM	PRINTER SAVE SPACE	PRINTER SAVE SPACE	Sets the amount of paper feed after printing to a low value.
	PRINTER NORMAL SPACE	PRINTER NORMAL SPACE	Sets the amount of paper feed after printing to a high value.
	DEFAULT COLOR *	DEFAULT COLOR *	Selects a display color among the default 5 patterns. 1 to 5
	MEAS WL AIR	MEASURE WAVELENGTH AIR	Sets measurement wavelength to air wavelength
	MEAS WL VACUUM	MEASURE WAVELENGTH VACUUM	Sets measurement wavelength to vacuum wavelength
	SELF CALIBRATION	SELF CALIBRATION	Calibrates the wavelength by the internal light source.
	WL CAL ****.***nm	WL CAL ****.***nm	Sets the wavelength of light source to perform waveform absolute value calibration. 350.000 to 1750.000 nm (0.001 step)
	WL SHIFT **.***nm	WL SHIFT **.***nm	Sets the amount of wavelength shift. -5.000 to 5.000 nm (0.001 step)
	LEVEL SHIFT ***.**dB	LEVEL SHIFT ***.**dB	Sets the amount of level shift. -60.00 to 60.00 dB (0.01 step)
AUTO OFFSET ###	AUTO OFFSET ###	Selects ON or OFF for the function to periodically cancel the DC offset of the AMP. For ###, select ON or OFF by rotary knob.	

Table 6-2 Panel Switch Command List (22/24)

Panel switch	Soft key list display	Program area display	Explanation and range of parameter
SYSTEM (cont.)	BUZZER CLICK ###	BUZZER CLICK ###	Generates a click sound when a key is pressed. For ###, select ON or OFF by rotary knob.
	BUZZER WARNING ###	BUZZER WARNING ###	Activates the buzzer upon occurrence of a warning error. For ###, select ON or OFF by rotary knob.
	TLS ADRS **	TLS ADRS	Sets the address of the wavelength variable light source. 0 to 29 (1 step)
	OPTICAL ALIGNMENT	OPTICAL ALIGNMENT	Adjusting optical axis of monochromator optical system employed on this unit.
	UNCAL WARNING###	UNCAL WARNING###	Displays UNCAL and WARNING. ###:Select ON or OFF by rotary knob
	ACTUAL RESOLUTION ###	ACTUAL RESOLUTION DISPLAY ###	Displays the resolution ability value. For ###, select ON or OFF by rotary knob.
	LOG DATA LIMIT ***	LOG DATA LIMIT ***	Sets the upper/lower limit value of the LOG data. For ###, select 210 or 100 by rotary knob.
ADVANCE	LONG TRM SWEEP	LONG TERM SWEEP	Starts the long term measurement.
	LONG TRM INTVL ****SEC	LONG TERM INTERVAL ****SEC	Sets the long term measurement interval. 0.1 to 9999.9 sec (0.1 step)
	LONG TRM RPT TIMES ***	LONG TERM REPEAT TIMES ***	Sets the number of long term measurement times. 1 to 1000 (1 step)
	LONG TRM ALL CH WAVLEN	LONG TERM ALL CH DISP WAVELENGTH	Sets all channel display to the wavelength display.
	LONG TRM ALL CH LEVEL	LONG TERM ALL CH DISP LEVEL	Sets all channel display to the level display.
	LONG TRM ALL CH SNR	LONG TERM ALL CH DISP SNR	Sets all channel display to the SNR display.
	LONG TRM SINGLE CH ***	LONG TERM SINGLE CH DISPLAY ***	Sets a channel during single channel display. 1 to 200 (1 step)
	LONG TRM ABSOLUTE	LONG TERM ABSOLUTE	Sets the absolute value display.

Table 6-2 Panel Switch Command List (23/24)

Panel switch	Soft key list display	Program area display	Explanation and range of parameter
ADVANCE (cont.)	LONG TRM REF DATA SET	LONG TERM REF DATA SET	Specifies the data of the cursor position for the reference data.
	LONG TRM RELATIVE	LONG TERM RELATIVE	Sets the relative value display for the reference data.
	LONG TRM REF DATA INI	LONG TERM REF DATA INITIAL	Specifies the preset value for the reference data.
	LONG TRM DATA CLR	LONG TERM DATA CLEAR	Clears the data of the long term measurement result.
	LONG TRM WAV LIMIT **	LONG TERM WAVELENGTH LIMIT **.***nm	Sets the threshold the wavelength drift. 0.00 to 99.99 nm (0.01 step)
	LONG TRM LOWER LIMIT *	LONG TERM LOWER LIMIT **.***dBm	Sets the upper limit of the level. -90.00 to -30.00 dBm (0.01 step)
	LONG TRM UPPER LIMIT *	LONG TERM UPPER LIMIT **.***dBm	Sets the lower limit of the level. -30.00 to 20.00 dBm (0.01 step)
	LONG TRM SNR LIMIT **	LONG TERM SNR LIMIT **.***dB	Sets the lower limit of the SNR. 0.00 to 50.00 dB (0.01 step)
	LONG TERM Y SCALE AUTO	LONG TERM Y SCALE AUTO	Sets the vertical axis scale on the graph in the automatic mode.
	LONG TERM Y SCALE MAN	LONG TERM Y SCALE MANUAL	Sets the vertical axis scale on the graph in the manual mode.
	LONG TERM WL CTR *	LONG TERM WL CENTER ****.***nm	Sets the Y-axis center wavelength on the wavelength display graph. ****.* : 600.00 to 1750.00nm (0.01 step)
	LONG TERM WL SPAN *	LONG TERM WL SPAN ****.*nm	Sets the Y-axis span on the wavelength display graph. ****.* : 0.0 to 1200.0nm (0.1 step)
	LONG TERM LVL CTR ****	LONG TERM LVL CENTER ***.*dBm	Sets the Y-axis center level on the level display graph. ***.* : -90.00 to 20.00dBm (0.01 step)
	LONG TERM LVL SCALE **	LONG TERM LVL SCALE *.*dB/D	Sets the Y-axis scale on the level display graph. *.* : 0.1 to 10.0dB (0.1 step)
LONG TERM SNR CTR ****	LONG TERM SNR CENTER ***.*dB	Sets the Y-axis center level on the SNR display graph. ***.* : -90.00 to 20.00dB (0.01 step)	

Table 6-2 Panel Switch Command List (24/24)

Panel switch	Soft key list display	Program area display	Explanation and range of parameter
ADVANCE (cont.)	LONG TERM SNR SCALE **	LONG TERM SNR SCALE **.*dB/D	Sets the Y-axis scale on the SNR display graph. **.* : 0.1 to 10.0dB (0.1 step)
	LONG TERM SCL AUTO SET	LONG TERM SCALE AUTO SET	Sets the same value as that at the automatic setting time on the graph scale.
	LONG TRM REF DATA SET	LONG TERM REF DATA SET	Specifies the data of the cursor position for the reference data.
	POWER METER REPEAT	POWER METER REPEAT	Makes repeat measurement by the power meter function.
	POWER METER SINGLE	POWER METER SINGLE	Makes single measurement by the power meter function.
	POWER METER STOP	POWER METER STOP	Stops measurement by the power meter function.
	AREA 600-1000	AREA 600-1000	Sets the wavelength range to 600 to 1000 nm by the power meter function.
	AREA 1000-1750	AREA 1000-1750	Sets the wavelength range to 1000 to 1750 nm by the power meter function.
	AREA FULL	AREA FULL	Sets the wavelength range to FULL (350 to 1750 nm) by the power meter function.
	RELATIVE ###	RELATIVE ###	Selects ON or OFF for the relative value display function by the power meter function. For ###, select ON or OFF by rotary knob.
	MAX MIN RESET	MAX MIN RESET	Selects the maximum value and minimum value by the power meter function.
	POWER METER UNIT dBm	POWER METER UNIT dBm	Sets the unit to "dBm" by the power meter function.
POWER METER UNIT W	POWER METER UNIT W	Sets the unit to "W" by the power meter function.	

Table 6-3 Special Command List (1/6)

Command list display	Program area display	Explanation and precaution of command (including parameter range)
<p>COPY ON</p> <p>PRINTER FEED **</p> <p>GOTO ***</p> <p>GOTO PROGRAM **</p> <p>WAIT *****S</p> <p>PAUSE '-----'</p> <p>VARIABLE CLEAR</p> <p>END</p> <p>N=*****</p> <p>N=N-1;IF N&lt;&gt;0 GOTO ***</p> <p>@=***** ###</p>	<p>COPY ON</p> <p>PRINTER FEED **</p> <p>GOTO ***</p> <p>GOTO PROGRAM **</p> <p>WAIT *****S</p> <p>PAUSE '----- 50 characters ----- '(Message to be displayed at a stop)</p> <p>VARIABLE CLEAR</p> <p>END</p> <p>N=*****</p> <p>N=N-1;IF N&lt;&gt;0 GOTO ***</p> <p>@=***** ###</p>	<p>Hardcopies the screen by the printer.</p> <p>Feeds the printer paper. (1 to 10.1 step) The amount of feed is approximately 5 mm per step.</p> <p>Jumps to the *** line. (1 to 200, 1 step) **:(1 to 200, 1 step) Jumps to program ** and starts execution from the first line. Jumps back to original program when contents of program ** has been executed. However, if END command is populated in the program **, this program ends without causing jump to the original program. When a program is executed with this command, variables are not initialized.</p> <p>Waits for ***** seconds. (1 to 99999.1 step)</p> <p>Causes execution to pause and displays a message window. In the window, the message in ' ' and an explanation of the &lt;CONTINUE&gt; key are displayed. When the soft key &lt;CONTINUE&gt; is pressed, the window is closed and the execution is restarted. However, when the program is started by GP-IB, it cannot pause.</p> <p>All variables used in a program are initialized.</p> <p>Terminates a program.</p> <p>Substitutes a value for the variable N. (1 to 99999999, 1 step) (1 to 200, 1 step) Subtracts 1 from the variable N. When the result is not 0, a jump takes place to the *** line.</p> <p>Substitutes a value for the variable @. For **-**, a real number of up to 10 digits including a sign and a decimal point can be set. For @, select one of I, J, K, S, X, Y and Z variables by rotary knob. For ###, select one of nm, dB, dBm, pW, nW, μW, mW, W and ' ' (no unit) by rotary knob.</p>



Table 6-3 Special Command List (2/6)

Command list display	Program area display	Explanation and precaution of command (including parameter range)
@=#+*****	@=#+*****	<p>Adds the **.* value to the variable # and substitutes the result for the variable @. For **.*, a real number of up to 10 digits including a sign and a decimal point can be set.</p> <p>When a minus value is set, subtraction is performed from the variable #.</p> <p>For @, #, select one of I, J, K, S, X, Y and Z variables by rotary knob.</p>
@=@@@@	@=@@@@	<p>Copies the contents of the variable @@@@ to the variable @. For @, select one of I, J, K, S, X, Y and Z variables by rotary knob. For @@@@, select one of I, J, K, S, X, Y, Z, WM, W1, W2, W2-W1, LM, L1, L2, L2-L1, SPWD, PKWL, PKLVL, MODN, SMSR, MKPWR, EDFNF, GAIN, ASELV, PWMTR, and PMD variables by rotary knob.</p>
@=@@@@+#####	@=@@@@+#####	<p>Performs four operations between variables.</p> <p>For @. select one of I, J, K, S, X, Y and Z variables by rotary knob. For @@@@, Select one of I, J, K, S, X, Y, Z, WM, W1, W2, W2-W1, LM, L1, L2, L2-L1, SPWD, PKWL, PKLVL, MODN, SMSR, MKPWR, EDFNF, GAIN, ASELV, PWMTR, and PMD variables by rotary knob.</p>
@=@@@@-#####	@=@@@@-#####	<p>Performs four operations between variables.</p> <p>For @. select one of I, J, K, S, X, Y and Z variables by rotary knob. For @@@@, Select one of I, J, K, S, X, Y, Z, WM, W1, W2, W2-W1, LM, L1, L2, L2-L1, SPWD, PKWL, PKLVL, MODN, SMSR, MKPWR, EDFNF, GAIN, ASELV, PWMTR, and PMD variables by rotary knob.</p>
@=@@@@*#####	@=@@@@*#####	<p>Performs four operations between variables.</p> <p>For @. select one of I, J, K, S, X, Y and Z variables by rotary knob. For @@@@, Select one of I, J, K, S, X, Y, Z, WM, W1, W2, W2-W1, LM, L1, L2, L2-L1, SPWD, PKWL, PKLVL, MODN, SMSR, MKPWR, EDFNF, GAIN, ASELV, PWMTR, and PMD variables by rotary knob.</p>
@=@@@@/#####	@=@@@@/#####	<p>Performs four operations between variables.</p> <p>For @. select one of I, J, K, S, X, Y and Z variables by rotary knob. For @@@@, Select one of I, J, K, S, X, Y, Z, WM, W1, W2, W2-W1, LM, L1, L2, L2-L1, SPWD, PKWL, PKLVL, MODN, SMSR, MKPWR, EDFNF, GAIN, ASELV, PWMTR, and PMD variables by rotary knob.</p>

Table 6-3 Special Command List (3/6)

Command list display	Program area display	Explanation and precaution of command (including parameter range)
<pre>PRINT '-----' PRINT @@@@ PRINT @@@@; PRINT DATA AREA IF F1&lt;=@@@@&lt;=F2 GOTO F1=***** ###</pre>	<pre>PRINT '----- 50 characters -----' PRINT @@@@ PRINT @@@@; PRINT DATA AREA IF F1&lt;=@@@@&lt;=F2 GOTO *** F1=***** ###</pre>	<p>Prints the command enclosed by single quotation marks. When a semicolon ";" is attached to the end of a comment, the comment (variable value) specified by the next PRINT command is printed in succession without line feed.</p> <p>Prints the variable @@@@ value with unit. For @@@@, select one of I, J, K, S, X, Y, Z, WM, W1, W2, W2-W1, LM, L1, L2, L2-L1, SPWD, PKWL, PKLVL, MODN, SMSR, MKPWR, EDFNF, GAIN, ASELV, PWMTR, A\$, FILE\$ and TIME\$ variables by rotary knob.</p> <p>Prints the variable @@@@ value with unit. After printing, the comment (variable value) specified by the next PRINT command is printed in succession without line feed. For @@@@, select one of I, J, K, S, X, Y, Z, WM, W1, W2, W2-W1, LM, L1, L2, L2-L1, SPWD, PKWL, PKLVL, MODN, SMSR, MKPWR, EDFNF, GAIN, ASELV, PWMTR, A\$, FILE\$ and TIME\$ variables by rotary knob.</p> <p>Prints the contents of the data area. ***: (1 to 200, 1 step) When the variable @@@@ value is more than F1 or less than F2, a jump takes place to the *** line. For @@@@, select one of I, J, K, S, X, Y, Z, WM, W1, W2, W2-W1, LM, L1, L2, L2-L1, SPWD, PKWL, PKLVL, MODN, SMSR, MKPWR, EDFNF, GAIN, ASELV and PWMTR variables by rotary knob.</p> <p>Substitutes a value for the variable F1. For *-**, real number of up to 10 digits including a sign and a decimal point can be set. For ###, select one of nm, THz, dB, dBm, pW, nW, μW, mW, W and ' ' (no unit) by rotary knob.</p>

Table 6-3 Special Command List (4/6)

Command list display	Program area display	Explanation and precaution of command (including parameter range)
F2=***** ###	F2=***** ###	Substitutes a value for the variable F2. For **-**, a real number of up to 10 digits including a sign and a decimal point can be set. For ###, select one of nm, THz, dB, dBm, pW, nW, μW, mW, W and ' ' (no unit) by rotary knob.
F1=@@@@	F1=@@@@	Copies the contents of the variable @@@@ to the variable F1. For @@@@, select one of I, J, K, S, X, Y, Z, WM, W1, W2, W2-W1, LM, L1, L2, L2-L1, SPWD, PKWL, PKLVL, MODN, SMSR, MKPWR, EDFNF, GAIN, ASELV and PWMTR variables by rotary knob.
F2=@@@@	F2=@@@@	Copies the contents of the variable @@@@ to the variable F2. For @@@@, select one of I, J, K, S, X, Y, Z, WM, W1, W2, W2-W1, LM, L1, L2, L2-L1, SPWD, PKWL, PKLVL, MODN, SMSR, MKPWR, EDFNF, GAIN, ASELV and PWMTR variables by rotary knob.
@=LEVEL (****.*** nm)	@=LEVEL (****.*** nm)	Assigns the level of "****.***nm" wavelength points (obtained by active trace) into variable @. "@" can be I, J, K, S, X, Y or Z.
@=LEVEL (@@@@)	@=LEVEL (@@@@)	Assigns the level of "aaaa" variable wavelength points (obtained by active trace) into variable @. "aaaa" can be I, J, K, S, X, Y, Z, WM, W1, W2, PKWL.
IF @@@@<@@@@ GOTO	IF @@@@<@@@@ GOTO ***	Jumps to line "****" if two variables satisfy the inequality sign condition.
IF @@@@=<@@@@ GOTO	IF @@@@=<@@@@ GOTO ***	Jumps to line "****" if two variables satisfy the inequality sign condition.
IF @@@@=@@@@ GOTO	IF @@@@=@@@@ GOTO ***	Jumps to line "****" if two variables satisfy the quality sign condition.
IF @@@@<>@@@@ GOTO	IF @@@@<>@@@@ GOTO ***	Jumps to line "****" if two variables satisfy the inequality sign condition. "@@@@" can be I, J, K, S, X, Y, Z, WM, W1, W2, W2-W1, LM, L1, L2, L2-L1, SPWD, PKWL, PKLVL, MODN, SMSR, MKPWR, EDFNF, GAIN, ASELV, PWMTR, N, F1 or F2.

Table 6-3 Special Command List (5/6)

Command list display	Program area display	Explanation and precaution of command (including parameter range)
@=SAMPL POINT	@=SAMPL POINT	Substitutes the current sampling point for the variable @. For @, select one of I, J, K, S, X, Y, and Z variables.
@=REF LEVEL	@=REF LEVEL	Substitutes the current reference level for the variable @. For @, select one of I, J, K, S, X, Y, and Z variables.
INIT	INIT	Initializes all parameters (does not clear any variables).
SEND ** '-----'	SEND ** '-----' 50 characters -----'	**; (0 to 29, 1 step) Specifies the external unit of address **, connected to the [GP-IB 2] connector, as a listener and sends out the command in ''. The delimiter is CR/LF.
SEND ** '-----';@	SEND ** '-----' 50 characters -----';@	**; (0 to 29, 1 step) Specifies the external unit of address **, connected to the [GP-IB 2] connector, to the listener and sends out the variable @ value after the command in ''. The delimiter is CR/LF.
SEND ** '----';@; '----'	SEND ** '-- 20 characters --';@; '-- 20 characters --'	**; (0 to 29, 1 step) Specifies external unit of address** being connected to [GP-IB2] connector as a listener and sends out the command in ', value of variable @ and command '' to the external unit, in that order. Delimiter is CR/LF. For @, one variable out of I, J, K, S, X, Y and Z is selected using the rotary knob.
RECEIVE ** ;A\$	RECEIVE ** ;A\$	**; (0 to 29, 1 step) Specifies the external unit of address**, connected to the [GP-IB 2] connector, as a talker, receives a message, and substitutes it for the character variable A\$. Up to 512 characters can be received. The delimiter is CR/LF.
@=CENTER	@=CENTER	Substitutes the current center wavelength for the variable @. For @, select one of I, J, K, S, X, Y, and Z variables.
@=SPAN	@=SPAN	Substitutes the current sweep width for the variable @. For @, select one of I, J, K, S, X, Y, and Z variables.

Table 6-3 Special Command List (6/6)

Command list display	Program area display	Explanation and precaution of command (including parameter range)
@=RESOLN	@=RESOLUTION	Substitutes the current resolution for the variable @. For @, select one of I, J, K, S, X, Y, and Z variables.
@=VAL ( A\$ )	@=VAL ( A\$ )	Converts the character variable A\$ into a numeric value and substitutes it for the variable @. For @, select one of I, J, K, S, X, Y and Z variables by rotary knob.
SPOLL ** ;S	SPOLL ** ;S	**:(0 to 29, 1 step) Performs serial polling to the external unit of address **, connected to the [GP-IB 2] connector, and substitutes the status byte for the variable S.
RESET OPTION	RESET OPTION	Performs remote clear, device clear and interface clear processing for the external unit connected to the [GP-IB 2] connector.
BEEP **	BEEP **	Activates the buzzer for ** × 100 msec. (1 to 10, 1 step)

## 6.7 Program Examples

Program examples are shown below.

- (1) After measuring conditions are set, a single sweep is executed. Then, the spectral width and peak wavelength are searched and output to the label area and printer. After waiting for 3 seconds, the above operation is repeated 10 times.

```
001 CENTER WL 1552.00nm
002 SPAN 10.0nm
003 REFERENCE LEVEL -10.0dBm
004 RESOLUTION 0.1 nm
005 AVERAGE TIMES 1
006 SENS NORMAL RANGE HOLD
007 N=10
008 SINGLE
009 SPEC WD THRESH 20.0dB
010 PRINT Wd= ;
011 LABEL Wd= ;
012 PRINT SPWD;
013 LABEL SPWD;
014 PEAK SEARCH
015 PRINT Pk= ;
016 LABEL Pk= ;
017 PRINT PKWL
018 LABEL PKWL
019 WAIT 3S
020 N=N-1;IF N<>0 GOTO 8
021 END
```

### [Explanation of program]

- Lines 001 to 006 ..... Sets measuring conditions.
- Line 007 ..... Sets 10 in loop counter N.
- Line 008 ..... Executes a single sweep.
- Line 009 ..... Makes a spectral width search.
- Lines 010 to 013 ..... Outputs the spectral width to the printer and label area.
- Line 014 ..... Makes a peak search.
- Lines 015 to 018 ..... Outputs the peak wavelength value to the printer and label area.
- Line 019 ..... Waits for 3 seconds.
- Line 020 ..... Subtracts 1 from loop counter N. When the result is not 0, a jump takes place to line 008.
- Line 021 ..... Terminates the program.

After execution of the above program, the following screen is output to the printer.

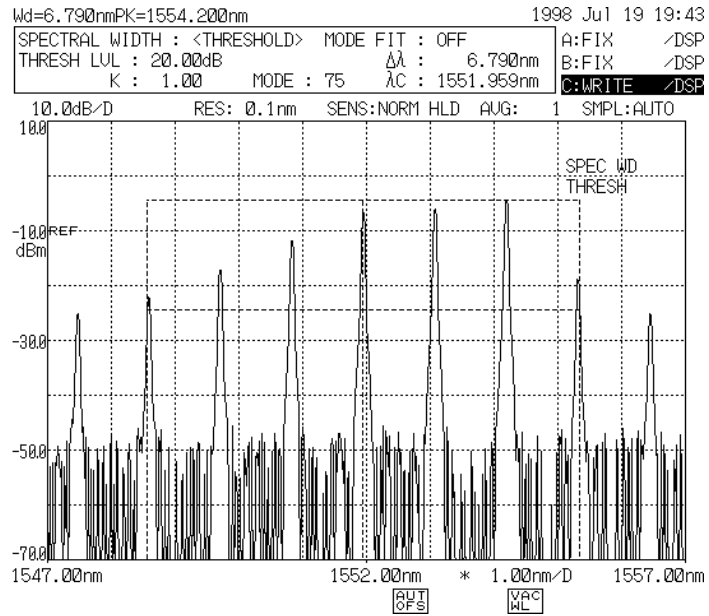

Wd= 6.782nm Pk= 1554.200nm  
Wd= 6.798nm Pk= 1554.180nm  
Wd= 6.773nm Pk= 1554.200nm  
Wd= 6.749nm Pk= 1554.180nm  
Wd= 6.754nm Pk= 1554.200nm  
Wd= 6.763nm Pk= 1554.200nm  
Wd= 6.775nm Pk= 1554.200nm  
Wd= 6.770nm Pk= 1554.180nm  
Wd= 6.759nm Pk= 1554.180nm  
Wd= 6.760nm Pk= 1554.200nm

(2) The waveforms stored in memories 0 to 31 are saved into the floppy disk and the file name list at that time is output to the printer.

```
001 N=32
002 Y=0
003 WRITE MEMORY Y
004 PRINT MEMORY ;
005 PRINT Y;
006 PRINT →
007 PRINT FILE$
008 Y=Y+1
009 N=N-1; IF N<>0 GOTO 3
010 END
```

**[Explanation of program]**

- Line 001 ..... Sets 32 in loop counter N.
- Line 002 ..... Substitutes 0 for variable Y.
- Line 003 ..... The waveforms stored in the memory of the number of variable Y are saved into the floppy disk.
- Lines 004 to 007 ..... Outputs the saving file name to the printer.
- Line 008 ..... Adds 1 to variable Y.
- Line 009 ..... Subtracts 1 from loop counter N.  
When the result is not 0, a jump takes place to line 003.
- Line 010 ..... Terminates the program.

After execution of the above program, the following file name list is output to the printer.

If any of memories 0 to 31 stores no waveform, an error is displayed at that time and the program is terminated.

```
MEMORY 0.000000 → W0000 .WV3
MEMORY 1.000000 → W0001 .WV3
MEMORY 2.000000 → W0002 .WV3
MEMORY 3.000000 → W0003 .WV3
MEMORY 4.000000 → W0004 .WV3
MEMORY 5.000000 → W0005 .WV3
MEMORY 6.000000 → W0006 .WV3
MEMORY 7.000000 → W0007 .WV3
MEMORY 8.000000 → W0008 .WV3
MEMORY 9.000000 → W0009 .WV3
MEMORY 10.000000 → W0010 .WV3
MEMORY 11.000000 → W0011 .WV3
MEMORY 12.000000 → W0012 .WV3
MEMORY 13.000000 → W0013 .WV3
MEMORY 14.000000 → W0014 .WV3
MEMORY 15.000000 → W0015 .WV3
MEMORY 16.000000 → W0016 .WV3
MEMORY 17.000000 → W0017 .WV3
MEMORY 18.000000 → W0018 .WV3
MEMORY 19.000000 → W0019 .WV3
MEMORY 20.000000 → W0020 .WV3
MEMORY 21.000000 → W0021 .WV3
MEMORY 22.000000 → W0022 .WV3
MEMORY 23.000000 → W0023 .WV3
MEMORY 24.000000 → W0024 .WV3
MEMORY 25.000000 → W0025 .WV3
MEMORY 26.000000 → W0026 .WV3
MEMORY 27.000000 → W0027 .WV3
MEMORY 28.000000 → W0028 .WV3
MEMORY 29.000000 → W0029 .WV3
MEMORY 30.000000 → W0030 .WV3
MEMORY 31.000000 → W0031 .WV3
```



- (3) The external unit connected to the [GP-IB 2] connector is specified as a listener and a device message is sent out. Next, it is specified as a talker and data is received. Then, the data is output to the printer. The above operation is repeated 10 times.

```

001 N=10
002 SEND 1 B, C1, E1, H1, S
003 WAIT IS
004 RECEIVE 1;A$
005 PRINT A$
006 N=N-1; IF N<>0 GOTO 2
007 END

```

**[Explanation of program]**

- Line 001 ..... Sets 10 in loop counter N.
- Line 002 ..... Specifies the external unit of address 1 as a listener and sends out the contents of ' '.
- Line 003 ..... Waits for 1 second.
- Line 004 ..... Specifies the external unit of address 1 as a talker, receives data, and substitutes it for character variable A\$.
- Line 005 ..... Outputs the contents of A\$ to the printer.
- Line 006 ..... Subtracts 1 from loop counter N. When the result is not 0, a jump takes place to line 002.
- Line 007 ..... Terminates the program.

After execution of the above program, the data received from the external unit is output to the printer as follows.

```

XTB2E1-19. 91
XTB2E1-19. 91
XTB2E1-19. 91
XTB2E1-19. 91
XTB2E1-19. 91
XTB2E1-19. 91
XTB2E1-19. 91
XTB2E1-19. 91
XTB2E1-19. 91
XTB2E1-19. 91
XTB2E1-19. 91

```

# Chapter 7 FLOPPY DISK FUNCTIONS

This chapter describes floppy disk functions.

## Contents of Chapter 7

7.1	Floppy Disk Functions .....	7-2
7.1.1	Outline.....	7-2
7.1.2	Loading/Unloading a floppy disk.....	7-3
7.2	Storing into a Floppy Disk .....	7-4
7.3	Reading from a Floppy Disk .....	7-11
7.4	File List Display.....	7-16
7.5	File Deletion .....	7-17
7.6	Floppy Disk Initialization .....	7-18
7.7	File Formats .....	7-20
7.7.1	Waveforms files .....	7-20
7.7.2	Data files .....	7-25

## 7.1 Floppy Disk Functions

### 7.1.1 Outline

This equipment is provided with a floppy disk drive and can store the programs created by the program function, the waveforms displayed on this equipment and the waveforms stored in memory into a floppy disk and read them out from it.

These programs and waveforms are stored as MS-DOS format files on the disk. One waveform or program is stored as one file.

The waveforms of 3-dimensional display can be stored as a file in a lump.

The following table shows the types and sizes of the files to be stored in this equipment.

These files can coexist on the same disk.

Table 7-1 Types and Sizes of Files

Type	File name extension	File format	Size (in bytes)
Ordinary waveforms file	.WV3	Binary	(Note 1)
	.TXT	Text	(Note 1)
Program file	.PG3	Binary	14336
Data file	.DT3	ASCII	1024(Note 2)
Graphic file	.BMP	Binary	156672(Note 3)
	.TIF	Binary	156672(Note 3)
Setup info file	.ST3	Binary	1024
3D waveforms file	.3D3	Binary	(Note 1)
Long term measurement result file	.LT2	Text	(Note 1)

\*1 the capacity changes by quantity of data.

\*2 If data is added to an existing file repeatedly, the file size is increased gradually.

\*3 Indicates the file size if graphic file in the color mode is stored. If the file in monochrome mode is stored, its size is reduced to 38912 bytes.

The storage capacity of one floppy disk is shown below.

Table 7-2 Floppy Disk Capacity

Initialization type	Capacity (bytes)	Maximum number of files
1.2 Mbyte	1250304	191
1.44 Mbyte	1455616	223

Because this equipment uses only the root directory, the number of files that can be stored in one disk is equal to the maximum number of files that can be stored in the root directory. Table 7-2 shows the maximum number of files.

(It indicates the number of files when the files whose extensions are ".WV3", ".DT3" and ".ST3" are saved.)

The files having the extensions of ".PG3", ".3D3", ".BMP" and ".TIF" are relatively large in their size.

Therefore, the number of these files may be limited when saved on a floppy disk.

## 7.1.2 Loading/Unloading a floppy disk

Figure 7-1 shows an external view of the floppy disk and the floppy disk drive. After checking the direction of the floppy disk, insert it from the insertion port.

To pull it out, push the eject button shown in the figure.

### CAUTION

- Before loading/unloading a floppy disk, be sure to check that the access lamp of the drive is OFF. If the disk is pulled out in the lamp ON status, the contents stored in the disk may be destroyed.
- When the write inhibit notch is set to the write inhibit side, data store or file delete processing is impossible.

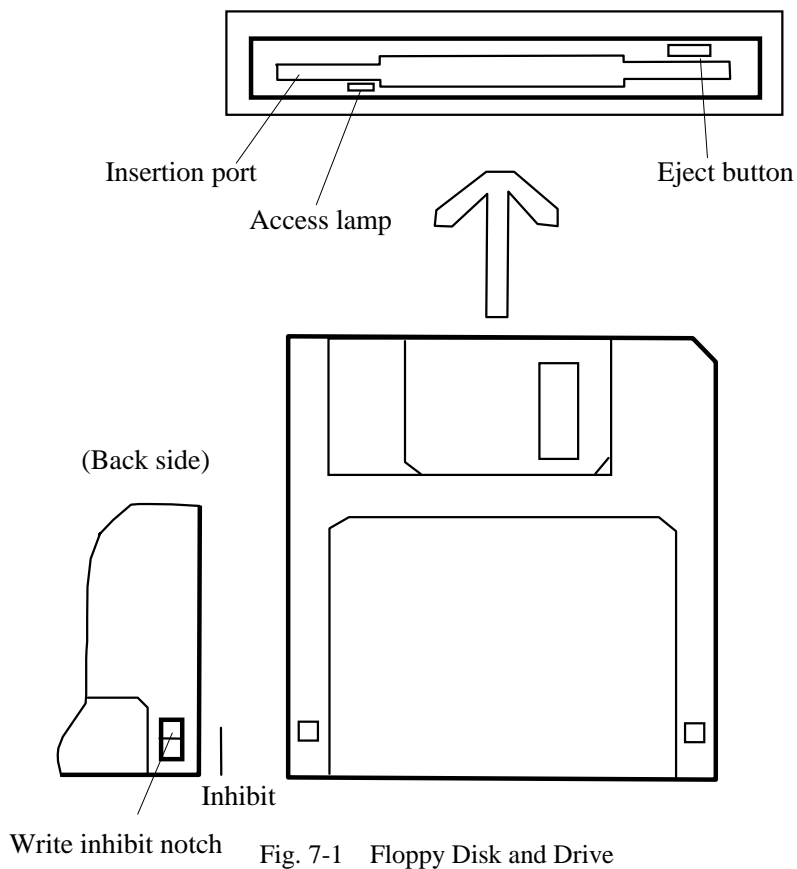

### CAUTION

- Clean the floppy disk once for approximately 3 months.
- For cleaning of the head, use the head cleaners marketed.
- Head cleaners available both in wet and dry types. Be advised that wet type cleaners remove stains on the head surface more effectively.
- For usage of the cleaner purchased, refer to the attached instruction manual.
- Don't try touch the magnetic surface of the floppy disk nor bring magnetized substance to it.
- Note that using a deteriorated or stained floppy disk can result in failure of the drive.

## 7.2 Storing into a Floppy Disk

To store the programs created by the program function, the waveforms displayed on the screen or waveforms in memory (MEM0 to MEM31) into a disk, observe the following procedure.

- (1) Press the [FLOPPY] switch.
- (2) The soft key menu changes as follows.
  - To store waveforms, press the <TRACE RD/WRT> key.  
(The 3 store types of binary, TEXT and ASCII are available.)
  - To store data (date/time, label, contents of data area, setting conditions), press the <DATA GRAPH RD/WRT> key to highlight the ' DATA' section.
  - To save the on-screen waveforms data (graphics) as they are, press the <DATA GRPH RD/WRT> key to highlight the ' GRPH' section.
  - To store programs, press the <PROGRAM/WRT> key.
  - To store setup information (parameter information and select status of all soft keys, user key registration information), press the <SETTING RD/WRT> key.
  - To store the long term measurement result, press the <LONG TERM RD/WRT> key.

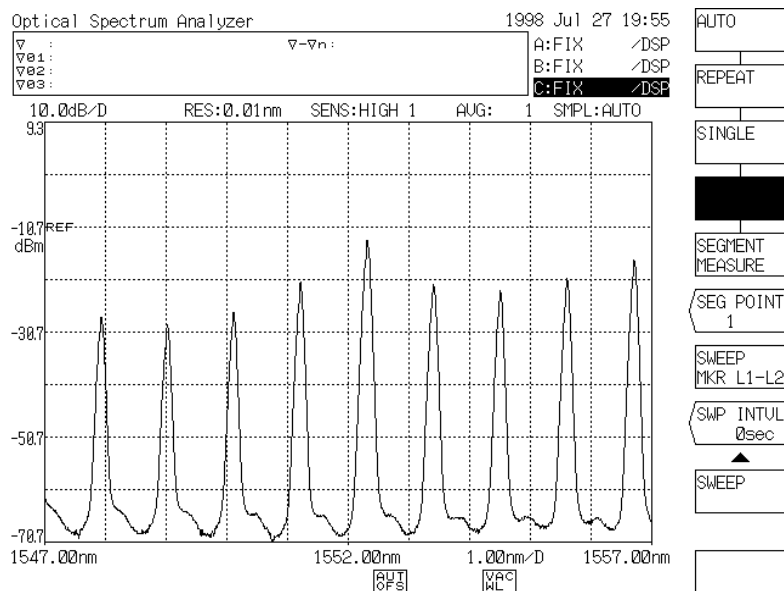

- (3) By pressing the <WRITE> key, the screen for storage is displayed according to the soft key selected in (2).
  - For waveform storage, select the type of storage source.  
When the <ABC → FD> key is selected, press this key once again and move the cursor to the type of the trace to be stored.  
When the <MEMORY → FD> key is selected, move the cursor to the waveform to be stored by the rotary knob or step keys and press the <CURSOR UP DOWN> key.  
Select the store type among BINARY, TEXT and ASCII by the <BIN TXT> key.  
For details of these formats, see Section 7.7.

- For program storage, move the cursor to the program to be stored by the rotary knob or step keys and press the <CURSOR UP DOWN> key.
- For data storage, select the contents to be stored by a soft key. For data/system information storage, the data of system information at the time when the [FLOPPY] switch was pressed is stored. It is not necessary to specify the file of storage source. Before data storage, select the storage data using soft keys.
- When the <RETURN> key is pressed, the screen of (2) is displayed again.

**- Screen for Waveform Storage  
(When <ABC → FD> is selected)**

Optical Spectrum Analyzer 1998 Jul 27 20:29

WRITE										B C→
TRACE A → W0000 .WU3										FD
TRACE LIST										MEMORY→
TR	CENTER [nm]	SPAN [nm/D]	REF	LSCL [D]	RES [nm]	AUG	SAMPL	SENS	ATTR	FD
A	1552.00	1.00	-10.7dB	10.0dB	0.01	1	4001	HIGH 1	MEAS	3D→FD
B	1552.00	1.00	-10.7dB	10.0dB	0.1	1	501	HIGH 2	MEAS	1st 2nd
C	1552.00	1.00	-10.7dB	10.0dB	0.01	1	2001	HIGH 1	MEAS	CURSOR UP DOWN

path:\				
NO.	FILE NAME	DATE & TIME	LABEL/PROGRAM NAME	ATTR
000	W0000 .WU3	<NEW FILE>		

FILE NAME

TXT

EXECUTE

RETURN

WRITE

FLOPPY

- |                                 |   |
|---------------------------------|---|
| TR : Type of trace              | NO. : File number                                   |
| CENTER : Mean wavelength        | FILE NAME : List of stored files                    |
| SPAN : Span (sweep width)       | DATE & TIME : Storage date and time of each file    |
| REF : Reference level           | LABEL/PROGRAM NAME                                  |
| LSCL : Level axis scale         | : Label and program name stored in each file.       |
| RES : Resolution                | ATTR : Type of the waveforms stored in each memory. |
| AVG : Number of averaging times | Number of waveform types :                          |
| SAMPL : Sampling count          | 13 (Refer to Table 5-1.)                            |
| SENS : Measuring sensitivity    |   |
| MON : Monochromator status      |   |

**- Screen for Waveform Storage  
(When <MEMORY → FD> is selected)**

Optical Spectrum Analyzer 1998 Jul 27 20:29

WRITE MEM00 → W0000 .WU3

MEMORY LIST		
NO	LABEL	ATTR
00		
01		
02		
03		
04		
05		
06		
07		
08		
09		
10		

path:\

NO.	FILE NAME	DATE & TIME	LABEL/PROGRAM NAME	ATTR
000	W0000 .WU3	<NEW FILE>		

**- Screen for Waveform Storage  
(When <3D → FD 1st 2nd> is selected)**

Optical Spectrum Analyzer 1998 Jul 27 20:30

WRITE 3D 1st → T0000 .3D3

path:\

NO.	FILE NAME	DATE & TIME	LABEL/PROGRAM NAME	ATTR
000	T0000 .3D3	<NEW FILE>		

**- Screen for Program Storage**

Optical Spectrum Analyzer 1998 Jul 27 20:30

WRITE PRG01 → P0000 .PG3

PROGRAM LIST			
US	NO	PROGRAM NAME	EXEC NO.
*	01	TEST PROGRAM	1
*	02	TEST PROGRAM	2
*	03		3
	04		4
	05		5
	06		6
	07		
	08		
	09		
	10		

path:\

NO.	FILE NAME	DATE & TIME	LABEL/PROGRAM NAME	ATTR
000	P0000 .PG3	<NEW FILE>		

- US : The mark \* is displayed at the number storing a program.
- EXEC NO. : Number registered in the program execute key (<EXEC1 (\*\*)> to <EXEC6 (\*\*)>).
- \*\* : Program No.

**- Screen for Data Storage**

Optical Spectrum Analyzer 1998 Jul 27 20:31

WRITE DATA → D0000 .DT3

path:\

NO.	FILE NAME	DATE & TIME	LABEL/PROGRAM NAME	ATTR
000	D0000 .DT3	<NEW FILE>		





- To create a new file and store it, move the cursor to the file name displayed as <NEW FILE> at the top.  
The new file name is first "W0000. WV3", "W0000. TXT" or "P0000. PG3" (program), "D0000. DT3" (data), "G0000.BMP" or "G0000TIF" (graphics), "S0000. ST3" (setup information), or "T0000. 3D3" (3-dimensional waveform), or " L0000. LT2" (long term measurement result). (The numeric portion in the file name is automatically given so as to avoid duplication with other files.)  
To change a file name, press the <FILE NAME> key. Then, the window for character input and the soft key menu appear in the same way as label input. Enter the file name in the same way as label input and press the <DONE> key.
- To change the contents of an existing file without creating a new file, move the cursor to this target file by the rotary knob or step keys.

### CAUTION

*To change a file name, use the characters usable for file names in MS-DOS.  
They are as shown below. (8 characters max.)*

```
!#$%&' ()-
0123456789a
ABCDEFGHIJKLMNOPQRSTUVWXYZ^_
abcdefghijklmnopqrstuvwxyz{ }
```

(4) Check that the "WRITE TRACE A → W0000. WAV" in the upper part of the screen has been changed into "Waveform/program/data/system information to be stored" → "File name".

- When the <EXECUTE> key is pressed, store processing is executed to the disk.
- When the <RETURN> key is pressed, the screen of (2) is displayed again without executing store processing.

If an existing file is selected in (3), the following display appears on the screen before execution of store processing.

To execute store processing, press the <YES> key. To cancel it, press the <NO> key.

Optical Spectrum Analyzer 1998 Jul 27 20:22

WRITE GRAPHIC → G0001 .BMP

path:\

NO.	FILE NAME	DATE & TIME	LABEL/PROGRAM NAME	ATTR
000	G0002 .BMP	<NEW FILE>		
001	G0000 .BMP	98.07.27 20:20		
002	G0001 .BMP	98.07.27 20:22		

OVERWRITE  
Are you sure ?

YES

NO

WRITE

FLOPPY

(5) After completion of store processing, the store screen is displayed continuously. After completion of store processing of setup into file, however, the waveform display returns to the screen of (2).

## 7.3 Reading from a Floppy Disk

To read out the programs or waveforms etc. stored in a disk, observe the following procedure.

- (1) Press the [FLOPPY] switch.
- (2) The soft key menu changes as follows.
  - To read a waveform, press the <TRACE RD/WRT> key.
  - To read out a program, press the <PROGRAM RD/WRT> key.
  - To read out data (date/time, label, contents of data area, setting conditions), press the <DATA GRAPH RD/WRT> key to highlight the data section.
  - To read out setup information (parameter information and select status of all soft keys, user key registration information), press the <SETTING RD/WRT> key.
  - To read the long term measurement result, press the <LONG TERM RD/WRT> key

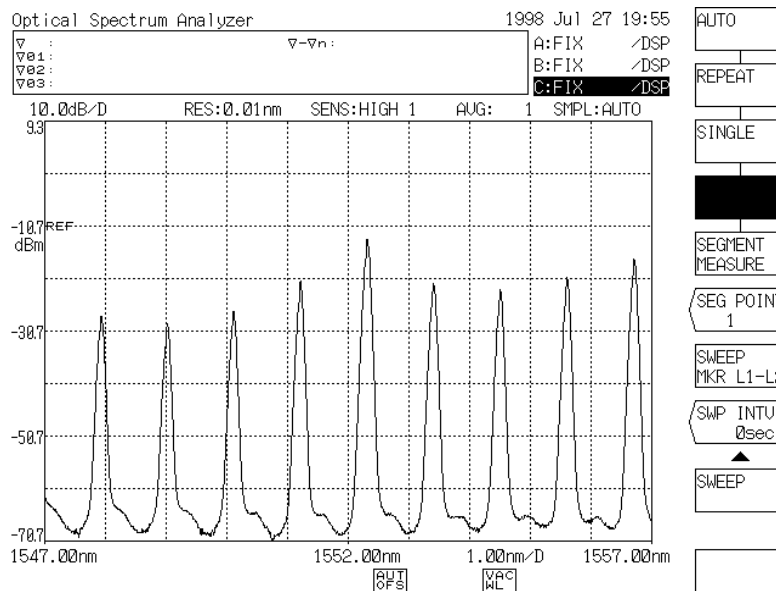

- (3) When the <READ> key is pressed, the screen for reading is displayed according to the soft key selected in (2).

The function of each soft key is the same as that for storage.

- Move the cursor to the file name to be read out by the rotary knob or step keys. To read out a program or waveform, press the <CURSOR UP DOWN> key after that.
- When the <RETURN> key is pressed, the screen of (2) is displayed again.

**- Screen for Waveform Reading  
(When <FD → ABC> is selected)**

Optical Spectrum Analyzer 1998 Jul 27 20:43

READ AUTO1 .WU3 → TRACE A

path:\

NO.	FILE NAME	DATE & TIME	LABEL/PROGRAM NAME	ATTR
000	AUTO1 .WU3	98.07.27 13:48	Optical Spectrum Analyzer	MEAS
001	AUTO .WU3	98.07.27 13:49	Optical Spectrum Analyzer	MEAS
002	HIGH2 .WU3	98.07.27 14:00	Optical Spectrum Analyzer	MEAS
003	QMSWEEP.WU3	98.07.27 13:22	Optical Spectrum Analyzer	MEAS
004	W0000 .WU3	98.07.27 15:11	Optical Spectrum Analyzer	MEAS
005	MANU .WU3	98.07.27 15:38	Optical Spectrum Analyzer	MEAS
006	NFFOR .WU3	98.07.27 16:28	Optical Spectrum Analyzer	MEAS
007	NFEND .WU3	98.07.27 16:28	Optical Spectrum Analyzer	MEAS
008	SMSR .WU3	98.07.27 16:32	Optical Spectrum Analyzer	MEAS
009	FILTA .WU3	98.07.27 16:42	Optical Spectrum Analyzer	MEAS
010	FILTB .WU3	98.07.27 16:42	Optical Spectrum Analyzer	MEAS
011	CURVEA .WU3	98.07.27 16:51	Optical Spectrum Analyzer	MEAS
012	CURVEB .WU3	98.07.27 16:51	Optical Spectrum Analyzer	CUFT

TRACE LIST

TR	CENTER [nm]	SPAN [nm/D]	REF	LSCL [D]	RES [nm]	AUG	SMP	SENS	ATTR
A	1552.39	0.10	-7.9dB	10.0dB	0.02	1	501	HIGH 1	MEAS
B	1552.39	0.10	-7.9dB	10.0dB	0.1	1	501	HIGH 2	MEAS
C	1552.39	0.10	-7.9dB	10.0dB	0.02	1	501	HIGH 1	MEAS

FD→  
B C

FD→  
MEMORY

FD→3D  
1st 2nd

CURSOR  
UP DOWN

EXECUTE

RETURN

READ

FLOPPY

**- Screen for Waveform Reading  
(When <FD → MEMORY> is selected)**

Optical Spectrum Analyzer 1998 Jul 27 20:43

READ AUTO1 .WU3 → MEM00

path:\

NO.	FILE NAME	DATE & TIME	LABEL/PROGRAM NAME	ATTR
000	AUTO1 .WU3	98.07.27 13:48	Optical Spectrum Analyze	MEAS
001	AUTO .WU3	98.07.27 13:49	Optical Spectrum Analyze	MEAS
002	HIGH2 .WU3	98.07.27 14:00	Optical Spectrum Analyze	MEAS
003	QMSWEEP.WU3	98.07.27 13:22	Optical Spectrum Analyze	MEAS
004	W0000 .WU3	98.07.27 15:11	Optical Spectrum Analyze	MEAS
005	MANU .WU3	98.07.27 15:38	Optical Spectrum Analyze	MEAS
006	NFFOR .WU3	98.07.27 16:28	Optical Spectrum Analyze	MEAS
007	NFEND .WU3	98.07.27 16:28	Optical Spectrum Analyze	MEAS
008	SMSR .WU3	98.07.27 16:32	Optical Spectrum Analyze	MEAS
009	FILTA .WU3	98.07.27 16:42	Optical Spectrum Analyze	MEAS

MEMORY LIST

NO	LABEL	ATTR
00	Optical Spectrum Analyzer	MEAS
01	Optical Spectrum Analyzer	MEAS
02	Optical Spectrum Analyzer	MEAS
03	Optical Spectrum Analyzer	MEAS
04	Optical Spectrum Analyzer	MEAS
05	Optical Spectrum Analyzer	MEAS
06	Optical Spectrum Analyzer	MEAS
07	Optical Spectrum Analyzer	MEAS
08	Optical Spectrum Analyzer	MEAS
09	Optical Spectrum Analyzer	MEAS
10	Optical Spectrum Analyzer	MEAS

FD→  
A B C

FD→3D  
1st 2nd

CURSOR  
UP DOWN

EXECUTE

RETURN

READ

FLOPPY

**- Screen for Waveform Reading  
(When <FD → 3D 1st 2nd> is selected)**

Optical Spectrum Analyzer 1998 Jul 27 20:44

READ T0000 .3D3 → 3D 1st				
path:\				
NO.	FILE NAME	DATE & TIME	LABEL/PROGRAM NAME	ATTR
000	T0000 .3D3	98.07.27 20:37	Optical Spectrum Analyze	MEAS

/FD→  
A B C

/FD→  
MEMORY

/FD→3D  
2nd

CURSOR  
UP DOWN

EXECUTE

RETURN

▲

READ

FLOPPY

**- Screen for Program Reading**

Optical Spectrum Analyzer 1998 Jul 27 20:44

READ P0000 .PG3 → PRG01				
path:\				
NO.	FILE NAME	DATE & TIME	LABEL/PROGRAM NAME	ATTR
000	P0000 .PG3	98.07.27 20:44	TEST PROGRAM	

CURSOR  
UP DOWN

EXECUTE

RETURN

▲

READ

FLOPPY

PROGRAM LIST			
US	NO	PROGRAM NAME	EXEC NO.
*	01	TEST PROGRAM	1
*	02	TEST PROGRAM	2
*	03	TEST PROGRAM	3
	04		4
	05		5
	06		6
	07		
	08		
	09		
	10		



## - Screen for Long Term Measurement Result Read

EDFA-OUT 1998 Jul 29 13:41

READ 001 .LT2 → LONG TERM				
path:\				
NO.	FILE NAME	DATE & TIME	LABEL/PROGRAM NAME	ATTR
000	001	.LT2 97.11.10 10:53		
001	000	.LT2 97.11.10 10:49		

EXECUTE  
RETURN  
▲  
READ  
FLOPPY

- To read out a waveform, select the type of a read source.  
When the <FD → ABC> key is selected, press it once again and move the cursor to the type of trace of the read source.  
When the <FD → MEMORY> key is selected, move the cursor to the memory of the read source by the rotary knob or step keys.
  - To read out a program, move the cursor to the memory of the read source by the rotary knob or step keys.  
To read out data or system information, it is not necessary to specify a read source.
- (4) Check that the "READ W0000 → TRACE A" display in the upper part of the screen has been changed into "File name to be read" → "Read source".
- When the <EXECUTE> key is pressed, read processing is executed for the disk.
  - When the <RETURN> key is pressed, the screen of (2) is displayed again without read processing.
- (5) After completion of the read processing, the screen of (2) or (3) is displayed again.
- In general, when a waveform has been read out (<FD→ABC> is selected) and when a program has been read out, the read screen (3) is displayed continuously. After completion of the read processing of setup into file., however, the display returns to the waveform screen (2).
  - When data has been read out, the screen changes into "DATA DISPLAY AREA" and the data is displayed. When the soft key <DONE> is pressed, the screen of (3) is displayed again.

### NOTE

*When 3-dimensional waveforms have been read out, the read waveforms are stored into memory 0 to 15 (1st) or 16 to 31 (2nd) (selected by the soft key <FD → 3D 1st 2nd>).*



## 7.4 File List Display

When the <DIRECTORY> key is pressed, a list of files stored in the disk can be seen.

- Press the [FLOPPY] switch and then the <DIRECTORY> key, and the following screen appears.

Optical Spectrum Analyzer					1998 Jul 27 20:47	
DIRECTORY					VOLUME NAME:AQ-6317	
path:\					270KB FREE	
NO.	FILE NAME	DATE & TIME	LABEL/PROGRAM NAME	ATTR		
000	AUTO1 .WU3	98.07.27 13:48	Optical Spectrum Analyze	MEAS	DELETE	
001	AUTO .WU3	98.07.27 13:49	Optical Spectrum Analyze	MEAS		
002	HIGH2 .WU3	98.07.27 14:00	Optical Spectrum Analyze	MEAS		
003	QMSWEEP.WU3	98.07.27 13:22	Optical Spectrum Analyze	MEAS		
004	W0000 .WU3	98.07.27 15:11	Optical Spectrum Analyze	MEAS		
005	MANU .WU3	98.07.27 15:38	Optical Spectrum Analyze	MEAS		
006	NFFOR .WU3	98.07.27 16:28	Optical Spectrum Analyze	MEAS		
007	NFFEND .WU3	98.07.27 16:28	Optical Spectrum Analyze	MEAS		
008	SMSR .WU3	98.07.27 16:32	Optical Spectrum Analyze	MEAS		
009	FILTA .WU3	98.07.27 16:42	Optical Spectrum Analyze	MEAS		
010	FILTB .WU3	98.07.27 16:42	Optical Spectrum Analyze	MEAS		
011	CURVEA .WU3	98.07.27 16:51	Optical Spectrum Analyze	MEAS		
012	CURVEB .WU3	98.07.27 16:51	Optical Spectrum Analyze	CUFT		
013	WDMWAU .BMP	98.07.27 18:54				
014	WDMLIST .BMP	98.07.27 18:55				
015	TRACELST.BMP	98.07.27 18:57			RETURN	
016	NORMDIS .BMP	98.07.27 18:58				
017	SPRTDISP.BMP	98.07.27 18:59			▲	
018	LABEL .BMP	98.07.27 19:00			DIRECTORY	
019	CLOCK .BMP	98.07.27 19:04				
020	WLCAL .BMP	98.07.27 19:05			FLOPPY	
021	COLOR .BMP	98.07.27 19:05				
022	NF .BMP	98.07.27 19:08				
023	CURVEFIT.BMP	98.07.27 19:12				

Top of screen	:	Displays the volume name given to the disk, and the residual capacity.
NO.	:	Displays the file number.
FILE NAME	:	Displays a list of files stored in the disk.
DATE & TIME	:	Displays the date and time of each file storage.
LABEL/PROGRAM NAME	:	Display the program name and label stored in each file.
ATTR	:	Displays the types of waveforms stored in each file.
<DELETE> key	:	Deletes files in the disk.
<RETURN> key	:	Returns to the screen displayed by pressing the [FLOPPY] switch after terminating the list display.

### NOTE

*Files other than those stored in this equipment are displayed. However, only the files existing in the root directory are displayed and the following files are not displayed.*

- Secret attribute file
- System file attribute file

## 7.5 File Deletion

To delete files in the disk, observe the following procedure.

- (1) Press the <DIRECTORY> key to display a list of files in the same way as 7.4 File List Display.
- (2) Move the cursor to a file name to be deleted by the rotary knob or step keys.
- (3) After completion of file name selection, check that the file name displayed in the upper part of the screen has been changed into the file name to be deleted and then press the <DELETE> key. The following is displayed.

Optical Spectrum Analyzer 1998 Jul 27 20:48

DELETE AUTO1 .WU3 VOLUME NAME:A0-6317 232kB FREE

path:\

NO.	FILE NAME	DATE & TIME	LABEL/PROGRAM NAME	ATTR
000	AUTO1 .WU3	98.07.27 13:48	Optical Spectrum Analyze	MEAS
001	AUTO .WU3	98.07.27 13:49	Optical Spectrum Analyze	MEAS
002	HIGH2 .WU3	98.07.27 14:00	Optical Spectrum Analyze	MEAS
003	QMSWEEP.WU3	98.07.27 13:22	Optical Spectrum Analyze	MEAS
004	W0000 .WU3	98.07.27 15:11	Optical Spectrum Analyze	MEAS
005	MANU .WU3	98.07.27 15:38	Optical Spectrum Analyze	MEAS
006	NFFOR .WU3	98.07.27 16:28	Optical Spectrum Analyze	MEAS
007	NFEND .WU3	98.07.27 16:28	Optical Spectrum Analyze	MEAS
008	SMSR .WU3	98.07.27 16:32	Optical Spectrum Analyze	MEAS
009	FILTA .WU3	98.07.27 16:42	Optical Spectrum Analyze	MEAS
010	FILTB .WU3	98.07.27 16:42	Optical Spectrum Analyze	MEAS
011	CURVEA .WU3	98.07.27 16:51	Optical Spectrum Analyze	MEAS
012	CURVEB .WU3	98.07.27 16:51	Optical Spectrum Analyze	CUFT
013	WDMWAU .BMP	98.07.27 18:54		
014	WDMLIST .BMP	98.07.27 18:55		
015	TRACELST.BMP	98.07.27 18:57		
016	NORMDIS .BMP	98.07.27 18:58		
017	SPRTDISP.BMP	98.07.27 18:59		
018	LABEL .BMP	98.07.27 19:05		
019	CLOCK .BMP	98.07.27 19:05		
020	WLCAL .BMP	98.07.27 19:05		
021	COLOR .BMP	98.07.27 19:05		
022	NF .BMP	98.07.27 19:08		
023	CURVEFIT.BMP	98.07.27 19:12		

DELETE  
Are you sure ?

DELETED

FLOPPY

- When the <YES> key is pressed, delete processing is executed.
  - To cancel it, press the <NO> key.
- (4) After completion of delete processing, the screen of (1) is displayed again.
    - To delete another file, repeat steps (2) and (3).

### NOTE

*Files other than those stored in this equipment can be deleted. However, only the files existing in the root directory can be deleted and the following files cannot be deleted (not displayed)*

- *READ ONLY attribute file*
- *Secret attribute file*
- *System file attribute file*
- *Subdirectory*

## 7.6 Floppy Disk Initialization

Before using a new disk, it must be initialized. For disk initialization, observe the following procedure.

- (1) Press the [FLOPPY] switch and then the <DISK INITIALIZE> key.
- (2) The following display appears.
  - When the <1.2 Mbyte EXECUTE> key is pressed, disk initialize execution is set to 1.2M bytes.
  - When the <1.44 Mbyte EXECUTE> key is pressed, disk initialize execution is set to 1.44M bytes.

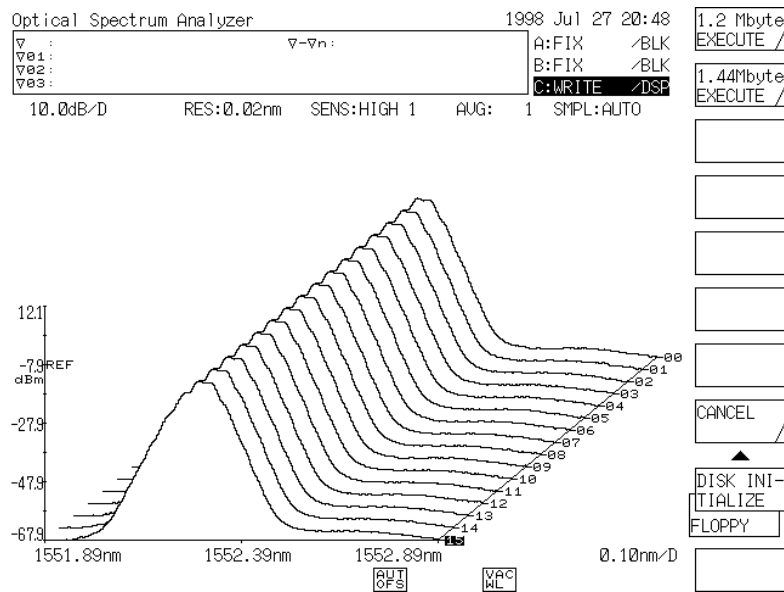

- (3) When any soft key is pressed in (2), the following display appears.
  - When the <YES> key is pressed, disk initialize processing is executed. (To stop it, press the <STOP> key.)
  - When the <NO> key is pressed, the screen displayed by pressing the [FLOPPY] switch is displayed again without executing initialize processing.

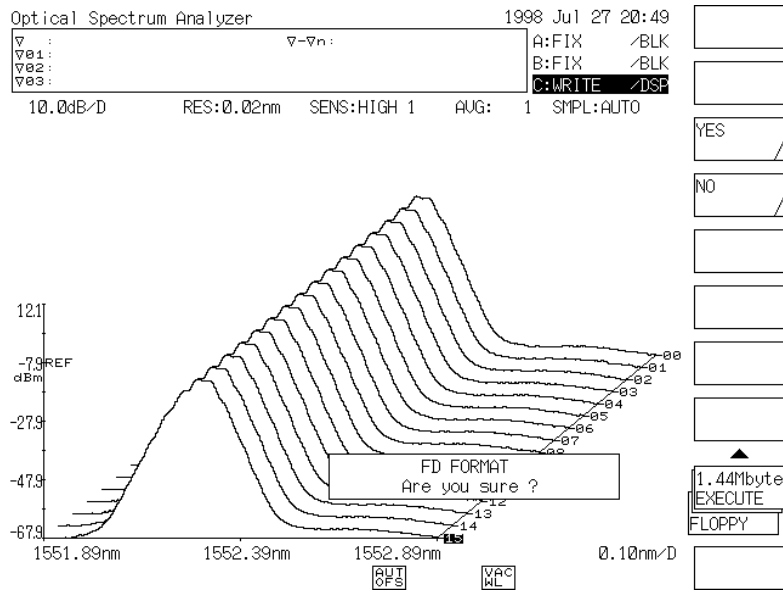

- (4) After completion of the initialize processing, the screen displayed by pressing the [FLOPPY] switch is displayed again.

### NOTE

*To a disk initialized in this equipment, the volume name "AQ63 17B" is given.*

### CAUTION

- *The floppy disks that are usable in this equipment are only of 3.5-inch 2HD.*
- *By executing initialize processing, all the information recorded in the disk is lost.*

## **7.7 File Formats**

### **7.7.1 Waveforms files**

When the trace waveforms are saved on a floppy disk, the data is saved in the internal format if the "BIN" format is selected by the <BIN TXT> key.

If the "TXT" format is selected by this key, the measured data is saved in the text format.

If the data is saved in the text format, the file size is increased. However, the files in this format are very easy to be processed by the tabulation calculation software and others on the PC during data analysis.

The following gives a data writing examples of trace waveforms in the "TXT" format.

Also, the standard data format is given.

**Data writing example of trace waveforms in text format:**

17TXT	}	Header information
1.3um FP-LD SPECTRAM		
00	}	Waveforms data of sample points (wavelength and level value)
1306.7400, -70.507		
1306.7450, -70.061		
1306.7500, -69.846		
1306.7550, -70.027		
1306.7600, -70.641		
1306.7650, -71.090		
1306.7700, -70.819		
1306.7750, -71.047		
1306.7800, -71.133		
1306.7850, -70.779		
...		
...		
...		
1316.7350, -72.773	}	Measuring conditions
1316.7400, -72.162		
"CTRWL", 1311.74		
"SPAN", 10.0		
"START WL", 1306.74		
"STOP WL", 1316.74		
"WLFREQ", 0		
"REFL", -20.0		
"LSCL", 10.0		
"RESLN", 0.01		
"AVG", 1		
"SMPLAUTO", 1		
"SMPL", 2001		
"HIGH 1"		
"NMSK", "OFF"		
"LBL", "1.3um FP-LD SPECTRUM"		
"MEAS"		
"LSUNT", 0		

(1) Header information

LATXT(CR)(LF) [File type]  
 \*\*\*...\*\*\* (CR)(LF) [Label description (up to 50 characters)]  
 \*\* (CR)(LF) [Waveforms type]

The waveforms types can be classified into the following groups:

No.	Waveforms type	No.	Waveforms type	No.	Waveforms type	No.	Waveforms type
00	WRITE	04	ROLL AVERAGE	08	B-A (LIN)	12	CURVE FIT
01	—	05	A- B (A/B)	09	A+B (LIN)	13	PEAK CURVE FIT
02	MAX HOLD	06	B- A (B/A)	10	NORMALIZE		
03	MIN HOLD	07	A- B (LIN)	11	DOMINANT		

(2) Waveforms data

\*\*\*\*.\*\*\*, ± \*\*\*\*.\*\*\* (CR)(LF) [Wavelength and level at first point]  
 \*\*\*\*.\*\*\*, ± \*\*\*\*.\*\*\* (CR)(LF) [Wavelength and level at second point]  
 :  
 \*\*\*\*.\*\*\*, ± \*\*\*\*.\*\*\* (CR)(LF) [Wavelength and level at 1001-th point]

Similar to the "Wavelength (20h space) Level", the waveforms data sets at the first to 1001-th points are separated from each other by a combination of CR (0Dh) and LF (0Ah) codes.

Wavelength format:..... \*\*\*\*.\*\*\*  
 Level format..... ± \*\*\*\*.\*\*\* (LOG scale)  
 \*.\*\*\*E± \*\* (LIN scale)

(3) Measuring conditions

- ① "CTRWL", \*\*\*\*.\*\*\* (CR)(LF) [Center wavelength ]
- ② "SPAN", \*\*\*.\*\*\* (CR)(LF) [Span]
- ③ "START WL", \*\*\*\*.\*\*\*
- ④ "STOP WL", \*\*\*\*.\*\*\*
- ⑤ "WLFREQ", \* [Level scale wavelength:0 frequency:1]
- ⑥ "REFL", -\*\*\*.\*\*\* (CR)(LF) [Reference (REF) level]
- ⑦ "LSCL", \*\*\*.\*\*\* (CR)(LF) [Main level scale]
- ⑧ "RESLN", \*\*\*.\*\*\* (CR)(LF) [Resolution]
- ⑨ "AVG", \*\*\*\*.\*\*\* (CR)(LF) [Averaging count]
- ⑩ "SMPLAUTO", \* (CR)(LF) [Sample count auto setting OFF:0 ON:1]
- ⑪ "SMPL", \*\*\*\*.\*\*\* (CR)(LF) [Sampling count]
- ⑫ "HIGH 3" (CR)(LF) [Measurement sensitivity]
- ⑬ "NMSK", -\*\*\*.\*\*\* (CR)(LF) [Noise mask value]
- ⑭ "LBL", "\*\*\*\*.\*\*\*" (CR)(LF) [Label description]
- ⑮ "MEAS" (CR)(LF) [Waveforms type]
- ⑯ "LSUNT", \* (CR)(LF) [Switching of display unit (0 for "dBm\*", 1 for "dBm/nm\*") ]

For the data formats of levels given in paragraphs ⑥ and ⑦, one of the following data is output depending on the level scale indication:

- **Main level scale**

LOG mode:

"REFL",-**.*(CR)(LF)	[Reference (REF) level]
"LSCL",**.*(CR)(LF)	[Main level scale]

LIN mode:

"REFL",-**.*(CR)(LF)	[Reference (REF) level]
"LSCL",**.*(CR)(LF)	[Main level scale]
"BASEL",****.*(CR)(LF)	[Main base level]

- **Sublevel scale**

LOG mode:

"REFL",-**.*(CR)(LF)	[Sub-reference level]
"SSCLG",**.*(CR)(LF)	[Sub-level scale]
"LOFST",**.*(CR)(LF)	[Sub-offset level]

LIN mode:

"REFL",-**.*(CR)(LF)	[Sub-reference level]
"SSCLN",*.****(CR)(LF)	[Sub-level scale]
"SMIN",**.*(CR)(LF)	[Sub-base level]

dB/km mode:

"REFL",-**.*(CR)(LF)	[Sub-reference level]
"SSKM",**.*(CR)(LF)	[Sub-level scale]
"OFSKM",***.*(CR)(LF)	[Sub-offset level]
"LENG",**.**(CR)(LF)	[Optical fiber length]

% mode:

"REEFL",-**.*(CR)(LF)	[Sub-reference level]
"SSPS",***.*(CR)(LF)	[Sub-level scale]
"SMINP",***.*(CR)(LF)	[Sub-base level]



For the measurement sensitivity format given in paragraph ⑫, one of the following data is output depending on the measurement sensitivity type:

"PLSLPF"(CR)(LF)	[LPF mode]
"PLSPKH",*** (CR)(LF)	[Peak Hold mode]
"PLSEXT"(CR)(LF)	[External Trigger mode]
"HIGH 1"(CR)(LF)	[HIGH SENS 1]
"HIGH 2"(CR)(LF)	[HIGH SENS 2]
"HIGH 3"(CR)(LF)	[HIGH SENS 3]
"NR_HLD"(CR)(LF)	[NORMAL RANGE HOLD]
"NR_AT"(CR)(LF)	[NORMAL RANGE AUTO]

For the waveforms type format given in paragraph ⑮, one of the following data is output depending on the waveforms type:

"MEAS"(CR)(LF)	[Write mode]
"MAXH"(CR)(LF)	[Max Value Detect mode]
"MINH"(CR)(LF)	[Min Value Detect mode]
"RAVG",*** (CR)(LF)	[Sequential Addition mode]
"A-B"(CR)(LF)	[Subtract A by B mode (LOG) ]
"B-A"(CR)(LF)	[Subtract B by A mode (LOG) ]
"A-BL"(CR)(LF)	[Subtract A by B mode (LIN) ]
"B-AL"(CR)(LF)	[Subtract B by A mode (LIN) ]
"A+BL"(CR)(LF)	[Add A by B mode (LIN) ]
"NORM"(CR)(LF)	[Normalizing waveforms display mode]
"DOMI"(CR)(LF)	[Visual sensitivity compensation waveforms display mode]
"CVFT",** (CR)(LF)	[Curve fit display mode]
"CVFTP",** (CR)(LF)	[Peak curve fit display mode ]

## CAUTION

*However, part of the waveforms and measuring conditions information may be lost if the files are saved in the TXT format.*

## 7.7.2 Data files

The data files are saved on a floppy disk in the ASCII format if the <DATE&TIME>, <LABEL>, <DATA AREA>, or <CONDITION> software key is selected.

The data not selected is written without any space.

The following gives a data file storage example and defines its format.

### Data file writing example:

```
"LADAT
"1994 May 06 09:51"
"AQ-4139(155) LD UNIT
"<FP-LD ANALYSIS> MODE : 9 SPEC WD : 3.854nm"
"MEAN WL : 1552.908nm TOTAL POWER : -3.53dBm"
" PK WL : 1552.000nm PK LVL : -8.04dBm"
"CTRWL 1552.00"
"SPAN 10.0"
"START WL 1547.00"
"STOP WL 1557.00"
"WLFREQ 0"
"REFL -16.0"
"LSCL 5.0"
"RESLN 0.1"
"AVG 1"
"SMPLAUTO 0"
"SMPL 501"
"NR_AT "
"NMSK OFF"
"MONO:SGL"
"MEAS"
"LSUNT 0"
```

----- Header information  
----- Date and time  
----- Label description

} Data area contents

} Measuring conditions

## Data file format

The following gives an example of data file format. The header information is saved on a floppy disk first, then the selected data is saved on the disk.

When an additional data is saved, the data other than the header information is written on the disk. The following details the data format.

- (1) Header information  
"LADAT"(CR)(LF) [File type]
- (2) When <DATE&TIME> key is pressed:  
"YYYY MMM DD HH:MM"(CR)(LF) [Date and time (year, month, day, and hours) ]
- (3) When <LABEL> key is pressed:  
"LABEL DATA 50 CHARACTERS"(CR)(LF) [Up to 50 label characters]

- (4) When <DATA AREA> key is pressed:

```
"<FP-LD ANALYSIS> MODE :9          SPEC WD  :    3.854nm"(CR)(LF)
"MEAN WL  : 1552.908nm          TOTAL POWER :  - 3.53dBm"(CR)(LF)
"PK WL    : 1552.000nm          PK LVL   :  - 8.04dBm"(CR)(LF)
```

The data area contents are written as they are. When the WDM analysis function is executed, the WDM list is written.

- (5) When the <CONDITION> key is pressed:
  - ① "CTRWL\*\*\*\*.\*\*(CR)(LF) [Center wavelength]
  - ② "SPAN\*\*\*\*\*"(CR)(LF) [Span]
  - ③ "START WL\*\*\*\*.\*\*(CR)(LF) [Start wavelength]
  - ④ "STOP WL\*\*\*\*.\*\*(CR)(LF) [Stop wavelength]
  - ⑤ "WLFREQ\*(CR)(LF) [Level scale wavelength:0 frequency:1]
  - ⑥ "REFL-\*.\*(CR)(LF) [Reference (REF) level]
  - ⑦ "LSCL\*.\*(CR)(LF) [Main level scale]
  - ⑧ "RESLN\*.\*(CR)(LF) [Resolution]
  - ⑨ "AVG\*\*\*\*\*"(CR)(LF) [Averaging count]
  - ⑩ "SMPLAUTO\*(CR)(LF) [Sample count auto setting OFF:0 ON:1]
  - ⑪ "SMPL\*\*\*\*\*"(CR)(LF) [Sampling count]
  - ⑫ "HIGH 3' "(CR)(LF) [Measurement sensitivity]
  - ⑬ "NMSK-\*.\*(CR)(LF) [Noise mask value]
  - ⑭ "MEAS"(CR)(LF) [Waveforms type]
  - ⑮ "LSUNT\*(CR)(LF) [Switching of display unit (0 for "dbm\*", 1 for "dBm/nm\*") ]

For the data formats of levels given in paragraphs ⑥ and ⑦, one of the following data is output depending on the level scale indication:

- **Main level scale**

LOG mode:

"REFL"-**.*(CR)(LF)	[Reference (REF) level]
"LSCL"**.*(CR)(LF)	[Main level scale]

LIN mode:

"REFL"-**.*(CR)(LF)	[Reference (REF) level]
"LSCL"**.*(CR)(LF)	[Main level scale]
"BASEL"****.*(CR)(LF)	[Main base level]

- **Sublevel scale**

LOG mode:

"REFL"-**.*(CR)(LF)	[Sub-reference level]
"SSCLG"**.*(CR)(LF)	[Sub-level scale]
"LOFST"**.*(CR)(LF)	[Sub-offset level]

LIN mode:

"REFL"**.*(CR)(LF)	[Sub-reference level]
"SSCLN"*.*.*.*.(CR)(LF)	[Sub-level scale]
"SMIN"**.*.*.*.(CR)(LF)	[Sub-base level]

dB/km mode:

"REFL"-**.*(CR)(LF)	[Sub-reference level]
"SSKM"**.*(CR)(LF)	[Sub-level scale]
"OFSKM"****.*(CR)(LF)	[Sub-offset level]
"LENG"**.*.*.*.(CR)(LF)	[Optical fiber length]

% mode:

"REEFL"-**.*(CR)(LF)	[Sub-reference level]
"SSPS"****.*(CR)(LF)	[Sub-level scale]
"SMINP"****.*(CR)(LF)	[Sub-base level]

For the measurement sensitivity format given in paragraph ⑫, one of the following data is output depending on the measurement sensitivity type:

"PLSLPF"(CR)(LF)	[LPF mode]
"PLSPKH"****(CR)(LF)	[Peak Hold mode]
"PLSEXT"(CR)(LF)	[External Trigger mode]
"HIGH 1"(CR)(LF)	[HIGH SENS 1]
"HIGH 2"(CR)(LF)	[HIGH SENS 2]
"HIGH 3"(CR)(LF)	[HIGH SENS 3]
"NR_HLD"(CR)(LF)	[NORMAL RANGE HOLD]
"NR_AT"(CR)(LF)	[NORMAL RANGE AUTO]

For the waveforms type format given in paragraph ⑪, one of the following data is output depending on the waveforms type:

"MEAS"(CR)(LF)	[Write mode]
"MAXH"(CR)(LF)	[Max Value Detect mode]
"MINH"(CR)(LF)	[Min Value Detect mode]
"RAVG"****(CR)(LF)	[Sequential Addition mode]
"A-B"(CR)(LF)	[Subtract A by B mode (LOG) ]
"B-A"(CR)(LF)	[Subtract B by A mode (LOG) ]
"A-BL"(CR)(LF)	[Subtract A by B mode (LIN) ]
"B-AL"(CR)(LF)	[Subtract B by A mode (LIN) ]
"A+BL"(CR)(LF)	[Add A by B mode (LIN) ]
"NORM"(CR)(LF)	[Normalizing waveforms display mode]
"DOMI"(CR)(LF)	[Visual sensitivity compensation waveforms display mode]
"CVFT"**(CR)(LF)	[Curve fit display mode]
"CVFTP"**(CR)(LF)	[Peak curve fit display mode]

# Chapter 8 MEASUREMENT EXAMPLES

This chapter describes functions taking measurement examples so that even an inexperienced operator may make measurement smoothly by this equipment.

## Contents of Chapter 8

8.1	Basic Measurement .....	8-2
8.1.1	Measurement by the [SWEEP] switch, <AUTO>key .....	8-2
8.1.2	Measurement by manual operations .....	8-4
8.1.3	Measuring sensitivity selection .....	8-6
8.1.4	Averaging times selection .....	8-8
8.2	Applied Measurement .....	8-9
8.2.1	Spectral width measurement.....	8-9
8.2.2	SMSR measurement.....	8-11
8.2.3	Loss wavelength characteristic measurement.....	8-13
8.2.4	Optical filter transmission factor measurement.....	8-18
8.3	PMD Measurement .....	8-21
8.3.1	Overview.....	8-21
8.3.2	Measurement system .....	8-21
8.3.3	Measurement procedure.....	8-21
8.4	Usage of Markers.....	8-23
8.4.1	Marker names.....	8-23
8.4.2	▽ marker .....	8-23
8.4.3	Wavelength line marker .....	8-25
8.4.4	Level line marker .....	8-26
8.4.5	Auto search .....	8-27
8.4.6	Wavelength difference and level difference measurement.....	8-28
8.5	Convenient Functions.....	8-29
8.5.1	Marker-to-marker sweep function.....	8-29
8.5.2	Marker-to-marker power measurement function.....	8-31
8.5.3	0 nm sweep function .....	8-32
8.5.4	Normalization display function.....	8-34
8.5.5	Three-dimensional display function.....	8-35

## 8.1 Basic Measurement

### 8.1.1 Measurement by the [SWEEP] switch, <AUTO>key

When the wavelength and level of input light are unknown, the <AUTO> key is used.

The measurement procedure is shown below.

- (1) Connect a light source to be measured to the [OPTICAL INPUT] connector.
- (2) Press the [SWEEP] switch and then the soft key <AUTO>.
- (3) This equipment analyzes the spectrum of the input light and automatically sets the mean wavelength, sweep width, reference level and resolution. Figure 8-1 shown a measurement example.  
After completion of automatic setting, the soft key select status changes from the <AUTO> key to the <REPEAT> key and sweep processing is executed repeatedly.  
(→ 5.1.1 [SWEEP] switch)
- (4) After completion of automatic setting, if you desire to change measuring conditions, change them by the [FUNCTION] section.

#### CAUTION

*When the unit is used for the first time or used again after being exposed to significant vibrations, make sure to warm it up first and then implement the alignment function prior to the operation.*

*Refer to 5.1.16(14) for the alignment function.*

### First sweep

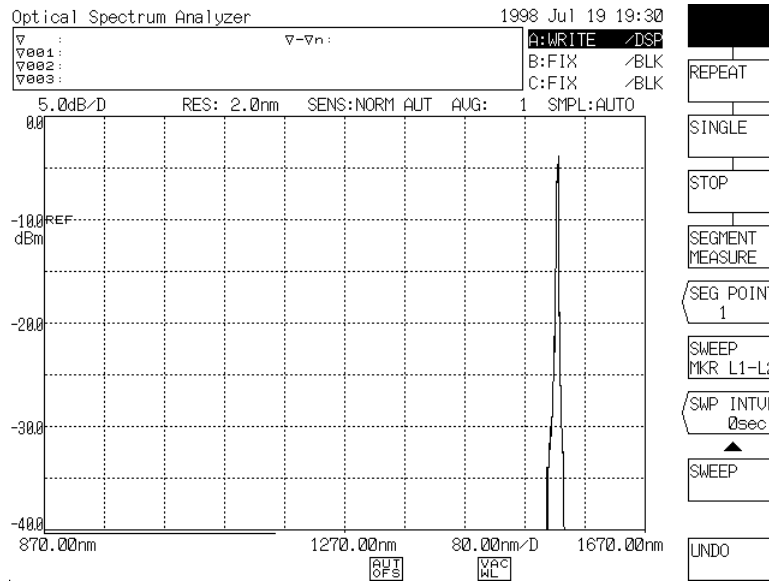

### Sweep after completion of automatic setting

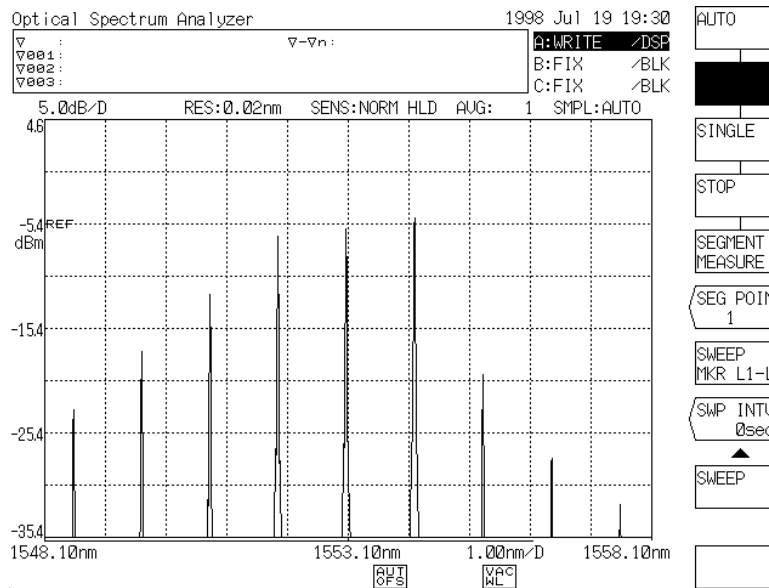

Fig. 8-1 Measurement Example by <AUTO> key



## 8.1.2 Measurement by manual operations

In case desired measuring conditions cannot be obtained by measurement using the <AUTO> key, set each measuring condition manually by using the switches in the [FUNCTION] section.

Taking LD light source (wavelength: approx. 1552 nm, level: approx. - 10 dBm) measurement as an example, the procedure will be described below.

### NOTE

*Do alignment after the warm-up when you move this equipment.*

*And, alignment is to do the built-in source.*

- (1) Connect the light source to be measured to the [OPTICAL INPUT] connector.
- (2) Press the [CENTER] switch and set the center wavelength of the light source by the rotary knob or step keys. In the case of this example, set the mean wavelength to 1552 nm.  
For this setting, you may enter [1] [5] [5] [2] [nm/ENTER] by the ten-key pad.
- (3) Press the [SPAN] switch and set a wider sweep width than the spectral width of the light source by the rotary knob or step keys. In the case of this example, set the sweep width to 100 nm.  
You may enter [1] [0] [0] [nm/ENTER] by the ten-key pad.
- (4) Press the [LEVEL] switch and set the light source level to the reference level by the rotary knob or step keys. In the case of this example, set - 10 dBm in the reference level.  
You may enter [- ] [1] [0] [nm/ENTER] or [ $\mu$ m/ENTER] by the ten-key pad.
- (5) Press the [LEVEL] switch and then the soft key <LVL SCALE>.  
Set the level scale to 5 dB/VID by the rotary knob or ten-key pad.  
You may enter [5] [nm/ENTER] or [ $\mu$ m/ENTER] by the ten-key pad.
- (6) Press the [SETUP] switch and then soft key <RESOLN>.  
Set the resolution to MINIMUM (2 nm) by the rotary knob or step keys.  
You may enter [2] [nm/ENTER] by the ten-key pad.
- (7) Press the [SETUP] key and then the soft key <AVERAGE TIMES>.  
Set the number of averaging times to 1 by the rotary knob or step keys.  
You may enter [1] [nm/ENTER] or [ $\mu$ m/ENTER] by the ten-key pad.
- (8) Press the [SETUP] switch and then the soft key <SENS>.  
Set the measuring sensitivity to NORM RANG HOLD by the rotary knob or step keys.
- (9) Press the [SWEEP] switch and then the soft key <REPEAT> to execute repeat sweep processing.
- (10) Watching the measurement result (waveform), change each measuring condition of (3) to (8) to a proper value.  
The setting standard is shown below:
  - The center wavelength is set to the peak wavelength of the waveform.
  - The sweep width is set to the range where the whole waveform is visible.

- The reference level is set to the peak level of the waveform.
- The resolution is set to the level where the waveforms do not change.
- For the number of averaging times, refer to 8.1.4 Averaging times selection.
- For the measuring sensitivity, refer to 8.1.3 Measuring sensitivity selection.

Figure 8-2 shows a measurement example using manual operations.

- (11) To stop the sweep processing, press the [SWEEP] switch and then the soft key <STOP>.

### First sweep

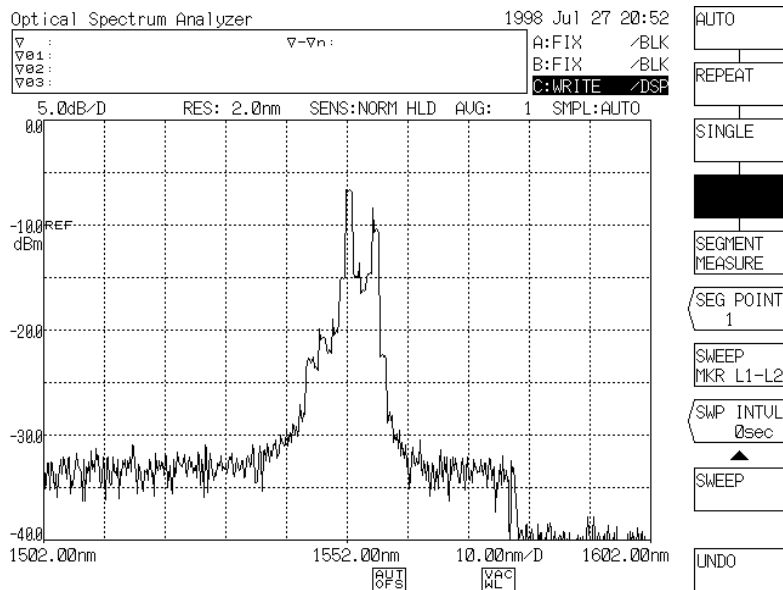

### Final waveform by manual setting

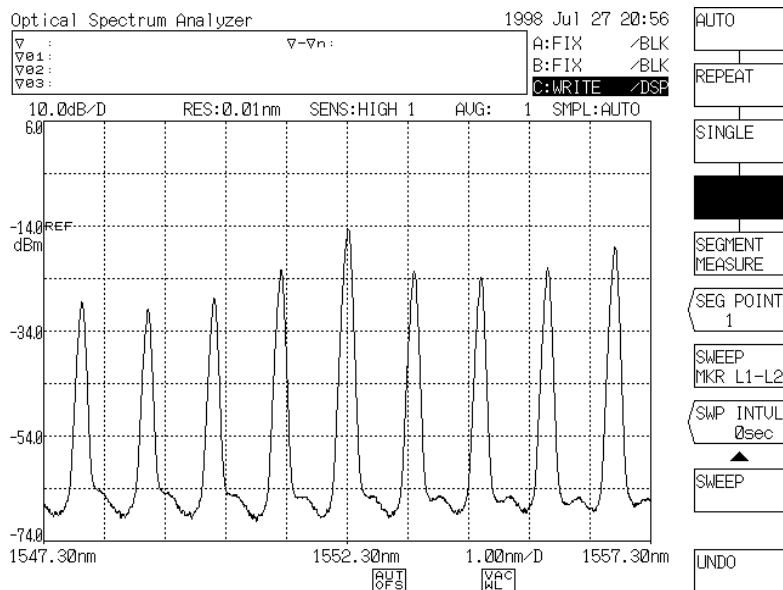

Fig. 8-2 Measurement Example Using Manual Operations

### 8.1.3 Measuring sensitivity selection

This equipment permits selecting 6 types of measuring sensitivity.

- (1) For measuring sensitivity selection, press the [SETUP] switch and then the soft key <SENS>. When the key is pressed, the current measuring sensitivity is displayed in the interrupt display section. One of NORMAL RANGE HOLD, NORMAL RANGE AUTO, HIGH1, HIGH2 and HIGH3 can be selected by the rotary knob or step keys. (→ 5.1.5 [SETUP] switch, (2) <SENS> key)
- Table 8-1 shows the contents of each measuring sensitivity.

Table 8-1 Measuring Sensitivity Selection

Measuring sensitivity	Contents	Measuring sensitivity display section
NORMAL RANGE HOLD	Measurement is made with the AMP range fixed.	SENS: NORM HLD
NORMAL RANGE AUTO	Measurement is made 3 times changing the AMP range internally and a combination of data measured in each range is displayed. When the number of averaging times is set to 2 or more by the <AVERAGE TIMES> key of the [SETUP] switch, measurement is made by auto range.	SENS: NORM AUT
MID	Measurement is made with the AMP range switched automatically.	SENS: MID
HIGH1	Measurements is made by the synchronous detection method internally chopping the light to be measured. "HIGH1", "HIGH2" or "HIGH3" is available depending on the auto range setting width and band width. "HIGH3" has the best measuring sensitivity but the lowest measuring speed.	SENS: HIGH1
HIGH2		SENS: HIGH2
HIGH3		SENS: HIGH3

- (2) Supposing that the standard measuring speed is provided when the measuring sensitivity is set at NORMAL ("NORMAL" : NORMAL RANGE HOLD, NORMAL RANGE AUTO) ; as the sensitivity becomes better, the measuring speed becomes lower in the order of MID, HIGH1, HIGH2 and HIGH3.

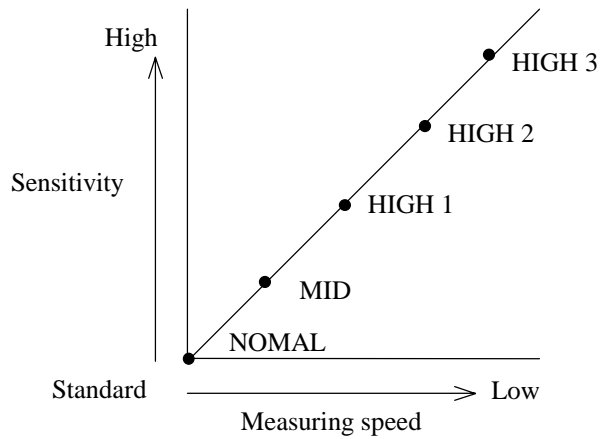

- (3) The selected measuring sensitivity is displayed in the measuring sensitivity display section in the lower part of the screen.

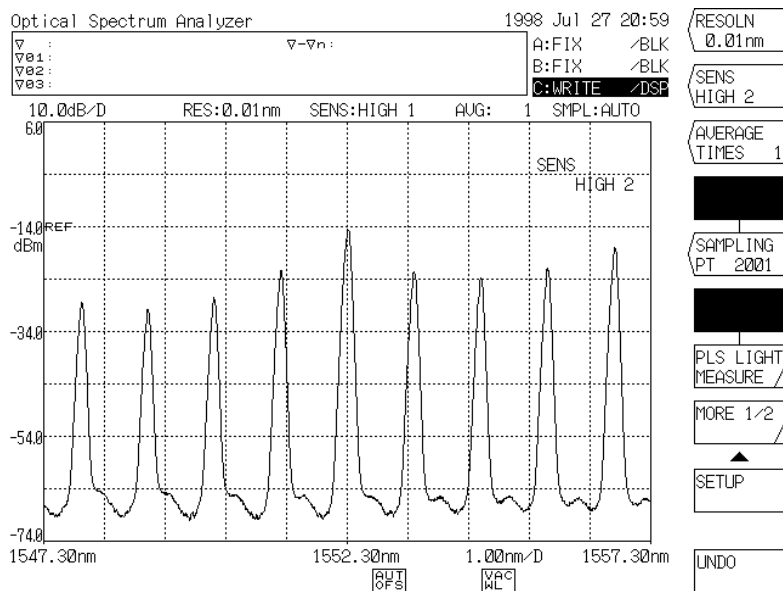

Display Made by Pressing <SENS> key

## 8.1.4 Averaging times selection

When the light source level fluctuates or the light source is modulated (below several kHz), the waveform is disturbed and this makes accurate measurement impossible.

In this case, increasing the number of averaging times permits accurate spectral measurement.

For selecting the number of averaging times, press the [SETUP] switch and then the soft key <AVERAGE TIMES>. Then, the current number of averaging times is displayed in the interrupt display section.

Any number can be selected in the range of 1 to 1000 by the rotary knob, step keys or ten-key pad.

(→ 5.1.7 [SETUP] switch, (3) <AVERAGE TIMES> key)

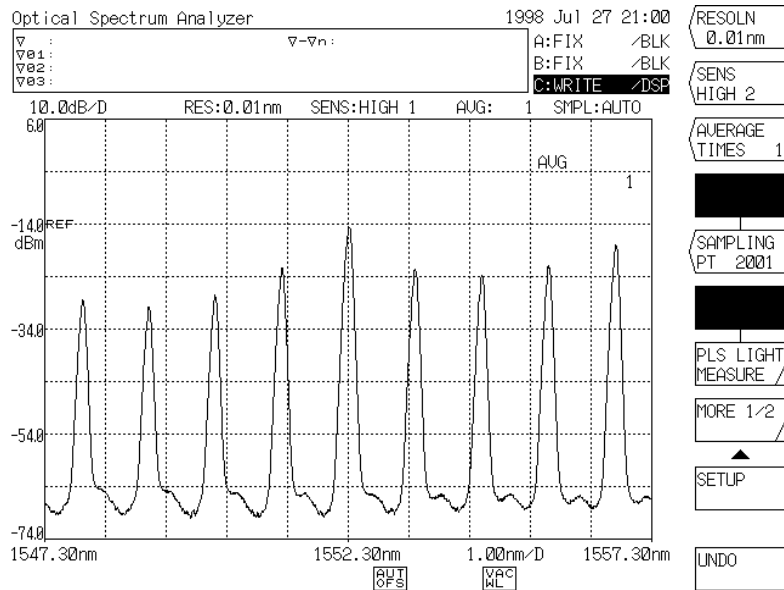

Display Made by Pressing <AVERAGE TIMES> key

## 8.2 Applied Measurement

### 8.2.1 Spectral width measurement

The spectral width of LD, LED, etc. can be measured.

- (1) To measure the spectral width of a waveform displayed on the screen, press the [ANALYSIS] switch.
- (2) After the switch is pressed, the soft key menu is displayed.  
The spectral width is calculated by an algorithm selected among the algorithms in Table 8-2 and the markers are displayed.

Table 8-2 Spectral Width Algorithms

Algorithm	Contents
ENV method	Obtains the spectral width from the envelope of the waveform.
THRESH method	Obtain the spectral width from the width of the point where the waveform intersects the threshold value.
RMS method	Obtains the spectral width from the standard deviation of the waveform.

- (3) To change the algorithm and threshold value or limit value, refer to 5.1.10 [ANALYSIS] switch.
- (4) When the [ANALYSIS] switch is pressed,  $\Delta\lambda$  value is displayed in data area.  
This value is regarded as the spectral width.  
Also,  $\lambda_c$  shown in the data area indicates the center of spectrum width  $\Delta\lambda$ .
- (5) To measure the spectral width at each sweep, cause the <AUTO ANALYSIS> key in the soft key menu displayed by pressing the [ANALYSIS] switch to be displayed in reverse video.  
This function is convenient for monitoring the spectral width while executing sweep processing.

## Spectral Width Measurement Example (1/2)

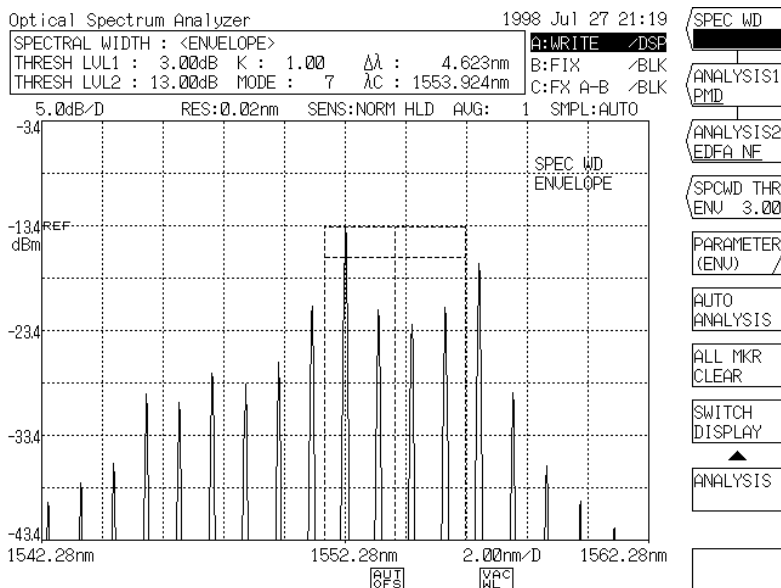

ENV method

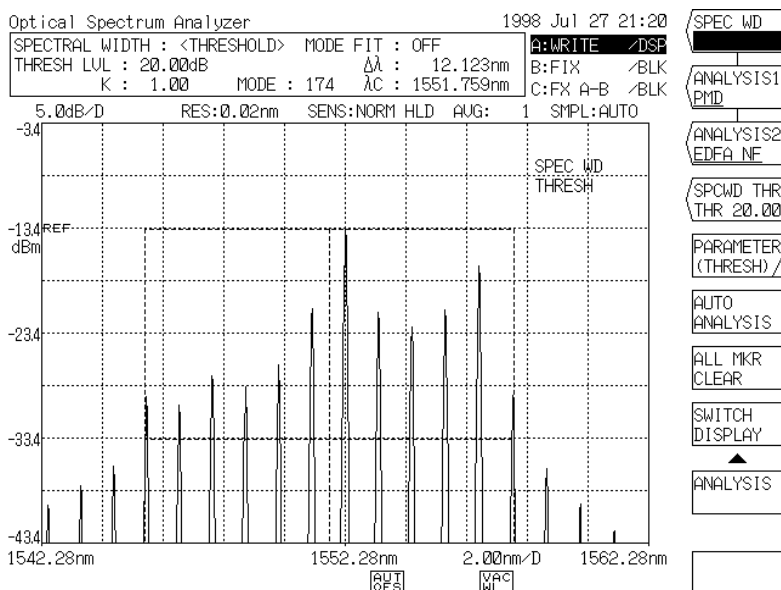

THRESHOLD method

## Spectral Width Measurement Example (2/2)

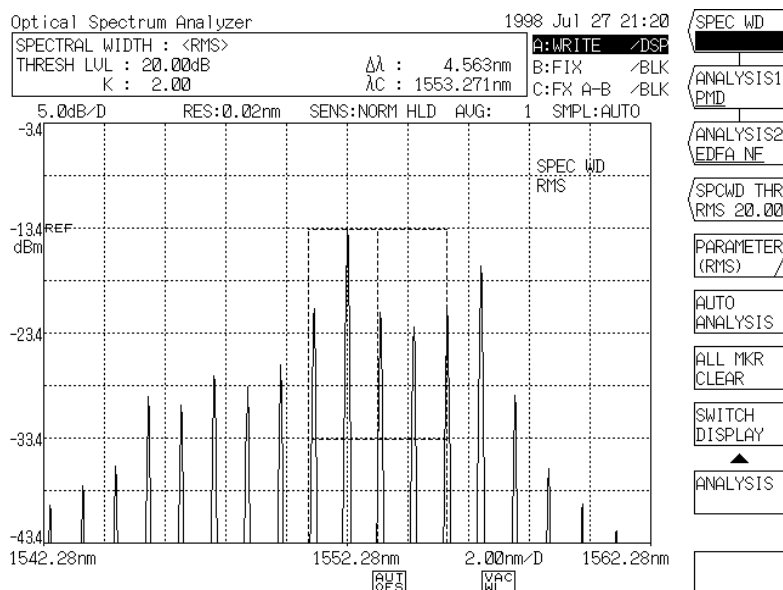

RMS method

## 8.2.2 SMSR measurement

This function can measure the SMSR of the DFB-LD.

### NOTE

*SMSR is an abbreviation for Side-Mode Suppression Ratio.  
The SMSR represents a level difference between the peak level and side mode level and used as a numeric value for performance evaluation of DFB-LD, etc.*

The procedure for SMSR measurement is as follows.

- (1) Press the [ANALYSIS] switch.
- (2) Press the <SMSR \*> key in the soft key menu.
- (3) The current set definition out of SMSR1 and 2 definitions is displayed in the interrupt display section and SMSR measurement is executed by this definition.
- (4) An SMSR definition can be selected by the rotary knob, step keys or ten-key pad.  
The markers are displayed in connection with this.
- (5) Each definition of SMSR 1 and 2 is shown in 1) and 2).



1) When SMSR1 is selected:

A level difference between the highest mode peak and the second highest mode peak (except mask setting range) is obtained by a single touch.

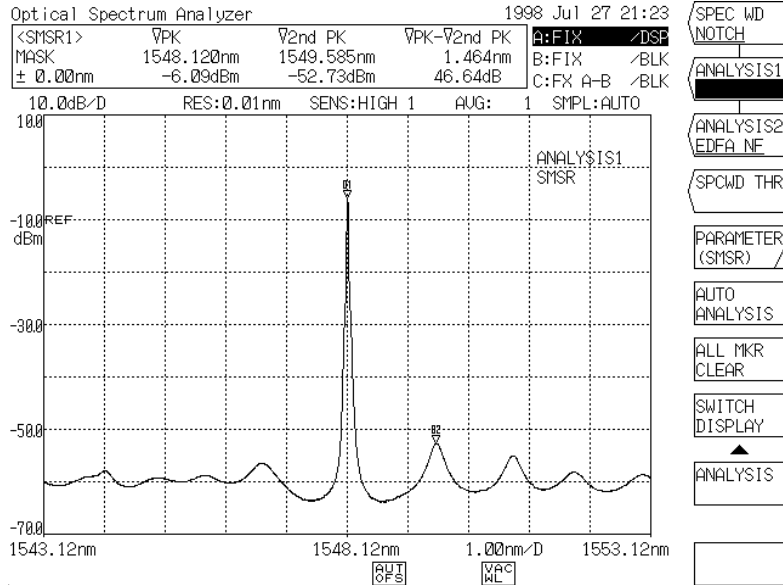

When SMSR1 is selected

2) When SMSR2 is selected:

A level difference between the highest mode peak and the higher of the right and left adjacent modes is obtained by a single touch.

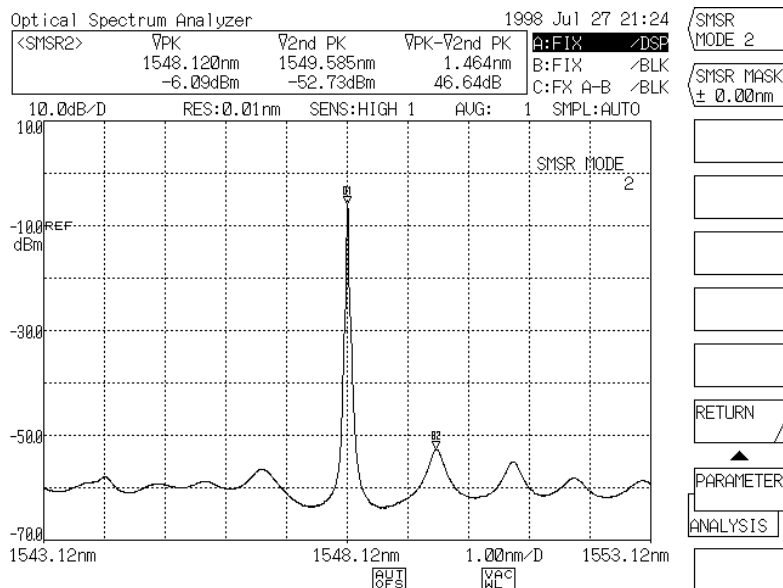

When SMSR2 is selected

## 8.2.3 Loss wavelength characteristic measurement

The loss wavelength characteristic of an optical fiber or the like can be measured by using the subtract operation function.

A measurement example is shown below.

In this case, loss wavelength characteristic measurement is made for SM fiber 10 km in the range of 700 to 1700 nm.

(1) Figure 8-3 shows a loss wavelength characteristic measurement system.

[Reference value measurement]

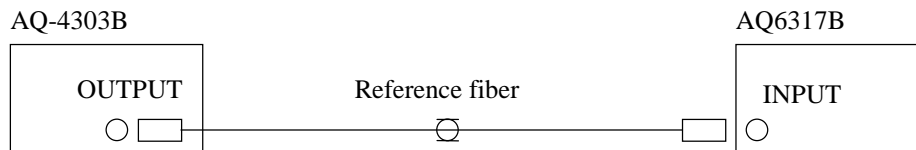

[Comparison value measurement]

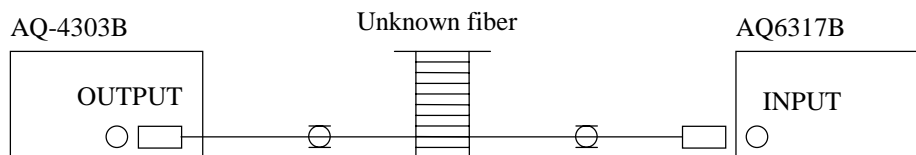

Fig. 8-3 Loss Wavelength Characteristic Measurement System

(2) Set the measuring conditions of this equipment as follows.

[CENTER] <START WL> : 700 nm

[CENTER] <STOP WL> : 1700 nm

[SETUP] <SAMPLING PT> : 1001, [SET UP] <RESOLN> : 2 nm

[REF LEVEL] : -60 dBm, [SET UP] <AVERAGE TIMES> : 1 time

[SENS] : HIGH 3, [LEVEL] <LVL SCALE> : 10 dBm/div

For the AQ-4303B white light source, set 400 to 1800 nm.

### NOTE

*When the range of 400 to 1800 nm is set for the AQ-4303B, all the internal filters turn off and light of all the 400 to 1800 nm band wavelengths is emitted.*

(3) Execute reference value measurement. The procedure for this measurement is as follows.

- ① As shown in the measurement system in Fig. 8-3 [Reference value measurement], connect this equipment to the AQ-4303B white light source by reference (short scale) fiber.
- ② Press the [TRACE] switch.
- ③ Set the display in reverse video to "A" by the <ACTIVE TRACE A B C> key. Then, the trace A becomes an active trace (measurement or setting enable trace).
- ④ Set the display in reverse video to "DISPLAY A" by the <DISPLAY A BLANK A> key. Then, the trace A waveform is displayed or becomes ready to be displayed on the screen.
- ⑤ Press the <WRITE A> key to reverse the soft key display and put the trace A into the write mode.
- ⑥ Press the [SWEEP] switch and the soft key <SINGLE>. Measure the reference spectrum.
- ⑦ Press the [TRACE] switch after sweep, and press the <FIX A> soft key to fix trace A.

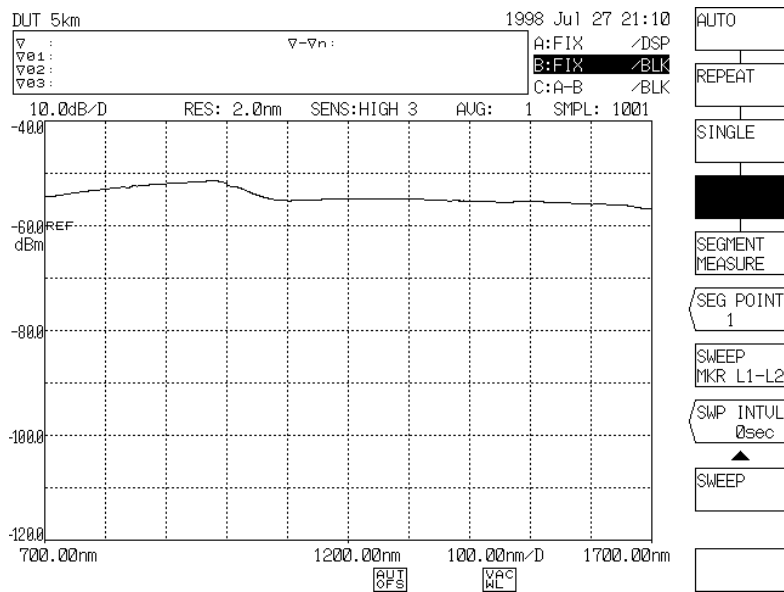

Reference Fiber Measurement Waveform

(4) Execute comparison value measurement. The procedure for this measurement is as follows.

- ① As shown in the measurement system in 8-3 [Comparison value measurement], change the fiber for connecting between this equipment and AQ-4303B white light source from the reference fiber to the fiber under measurement.
- ② Press the [TRACE] switch.
- ③ Set the display in reverse video to "B" by the <ACTIVE TRACE A B C> key. Then, the trace B becomes an active trace.
- ④ Set the display in reverse video to "B" by the <DISPLAY B LANK B> key. Then, the trace B waveform is displayed or becomes ready to be displayed on the screen.
- ⑤ Press the <WRITE B> key to reverse the soft key display and put the trace B into the write mode.
- ⑥ Press the [SWEEP] switch and then the soft key <SINGLE>. Measure the comparison spectrum.

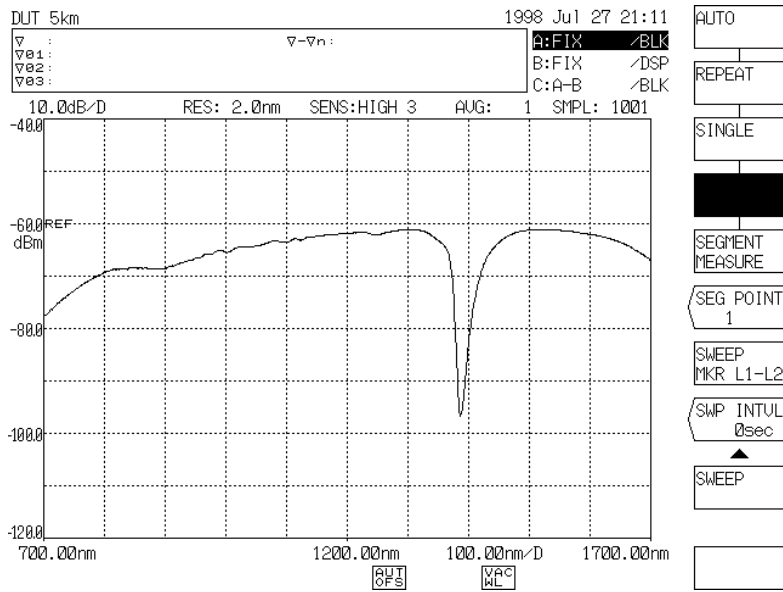

Measured Waveform of Fiber under Measurement

(5) Perform subtraction. The procedure for this measurement is as follows.

- ① Press the [TRACE] switch.
- ② Set the display in reverse video to "C" by the <ACTIVE TRACE A B C> key. Then, the trace C becomes an active trace.
- ③ Set the display in reverse video to "DISPLAY C" by the <DISPLAY C BLANK C> key. Then, the trace C waveform is displayed or becomes ready to be displayed on the screen.
- ④ When the <CALCULATE C> key is pressed, the comparison value is subtracted from the reference value and the result is copied to the trace C. (At this time, if <A- B (A/B) → C> of the soft key is not displayed in reverse video, press the soft key <A- B (A/B) → C>.)  
 The waveform resulting subtracting the spectrum of the trace B from the spectrum of the trace A is copied to the trace C and a subscale is displayed at the right of the screen.  
 (To display a subscale by auto scaling after subtraction, press the <AUTO SUB SCALE> key of the [LEVEL] switch to reverse it.)  
 The waveform displayed on the trace C represents the loss wavelength characteristic.

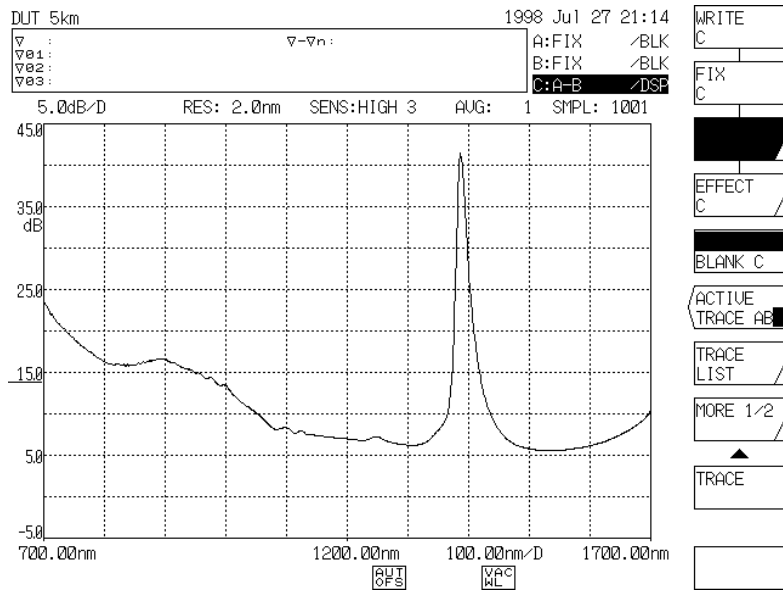

Display Made by Pressing <A- B (A/B) → C> key

(6) To change the displayed waveform into a desired scale, the subscale can be changed manually.

- ① To change the subscale, press the [LEVEL] switch and then the soft key <SUB LOG>. When the <SUB LOG> key is pressed, the current subscale value is displayed in the interrupt display section. The subscale value can be switched in the range of 0.1 dB/DIV to 10 dB/DIV with the medium value (underline) as a center by the rotary knob, step keys or ten-key pad. The waveform is also changed at that time.

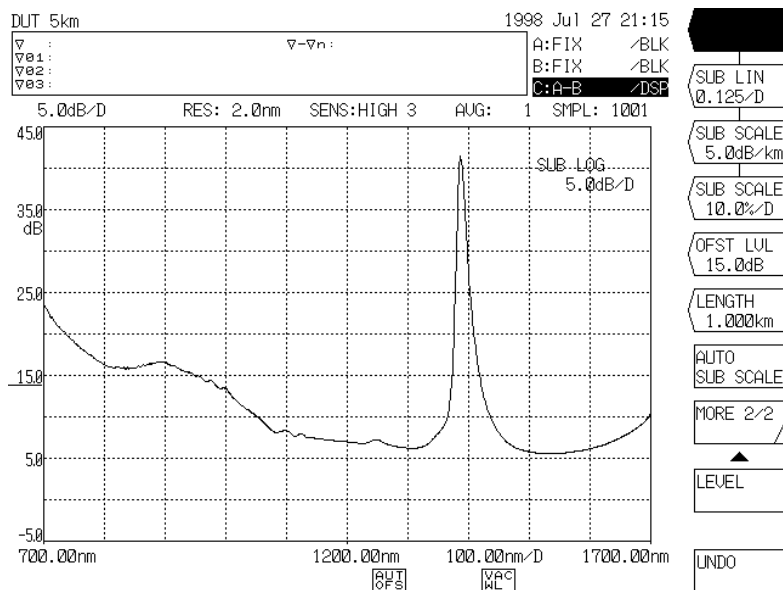

Scale Setting by <SUB LOG> key

- ② To change the offset value, press the [LEVEL] switch and then the soft key <OFST LVL>. When the <OFST LVL> key is pressed, the current offset value (the value equal to the underlined characters) is displayed in the interrupt display section. This value can be switched in the range of -99.9 dB to 99.9 dB by the rotary knob, step keys or ten-key pad. The subscale display section and waveform are also changed at that time.

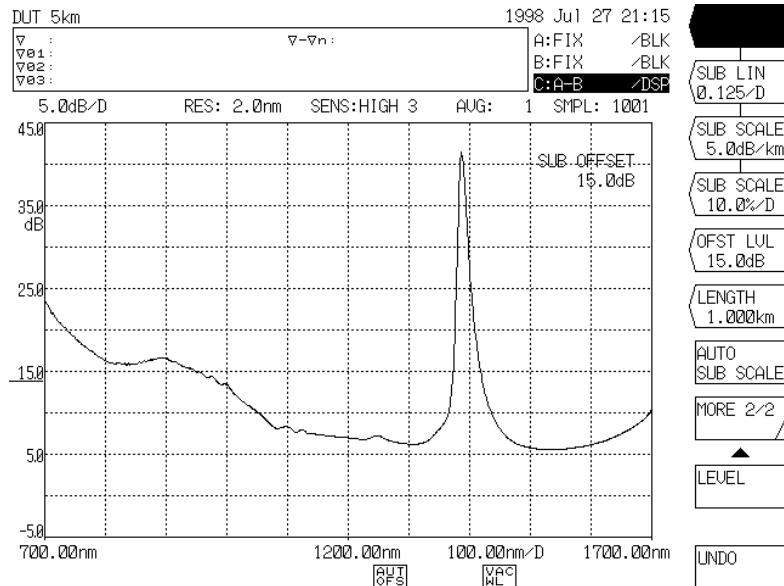

#### Offset Setting by <OFST LVL>

- (7) To display the scale for the loss in a unit length (1 km), use the <SUB SCALE\*\*.\*dB/km> key.
- ① When the <SUB SCALE \*\*.\*dB/km> key is pressed, the current sub scale value is indicated in the interrupt display area. The sub scale value can be changed from the center (underline) position within the range of 0.1 to 10.0 dB/km by the rotary knob, step keys, or numeric keys. The waveforms are also changed simultaneously.
- ② Press the <LENGTH\*\*.\*km> key to set the length of optical fiber under measurement. It can be set from 0.001 to 99.999 km by the rotary knob, step keys, or numeric keys. The on-screen waveforms has the loss wavelength characteristics in 1 km of optical fiber under test.
- ③ The offset can also be changed in the same procedure as Step ② of Paragraph (6).

## 8.2.4 Optical filter transmission factor measurement

The transmission factor of an optical filter can be measured by using the subtract operation function. A measurement example is shown below.

(For the subtract operation procedure, refer to 8.2.3 Loss wavelength characteristic measurement.)

- (1) Figure 8-4 shows a transmission factor measurement system.

[Reference value measurement]

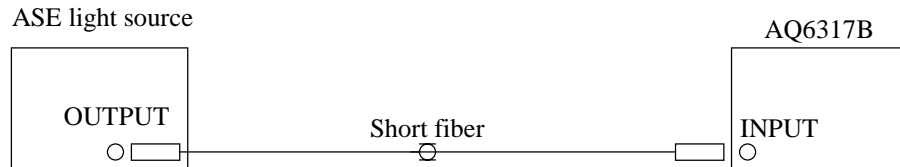

[Comparison value measurement]

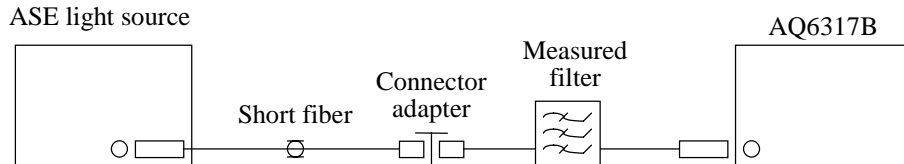
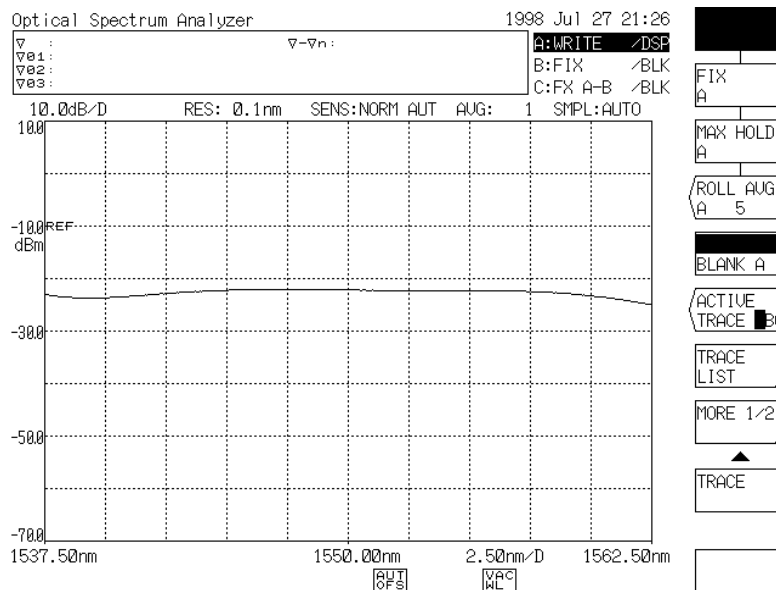

Fig. 8-4 Optical Filter Transmission Factor Measurement System

- (2) Perform the reference value measurement shown in Fig. 8-4 by the trace A. The waveform is shown below.



Reference Spectrum

- (3) As shown in Fig. 8-4, measure the comparison spectrum by the trace B after inserting an optical filter. The waveform is shown below.

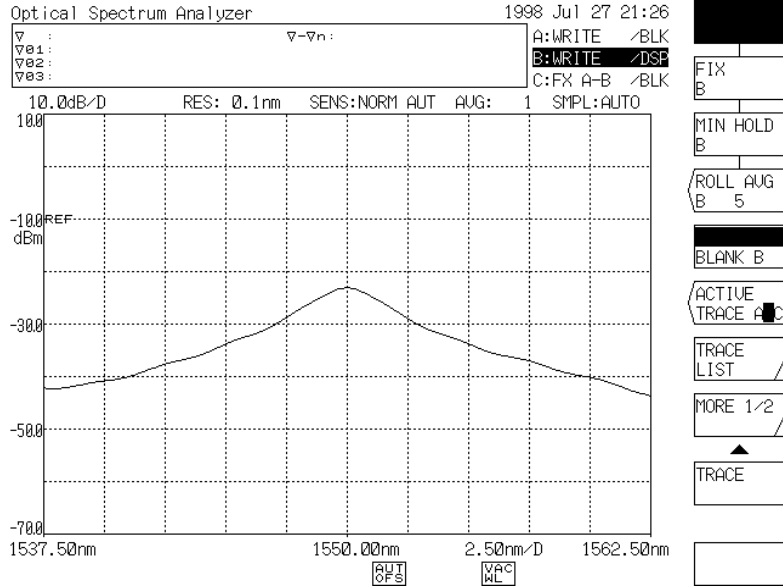

Comparison Spectrum

- (4) To subtract the reference value from the comparison value, press the [TRACE] switch and set the display in reverse video to "C" by the soft key <ACTIVE TRACE A B C>, and then press the <CALCULATE C> key. (At this time, if the soft key <B-A → C> is not displayed in reverse video, press the <B-A → C> key.) Then, the waveform resulting from subtracting the spectrum of the trace A from the spectrum of the trace B is displayed. The displayed waveform represents the transmission factor.

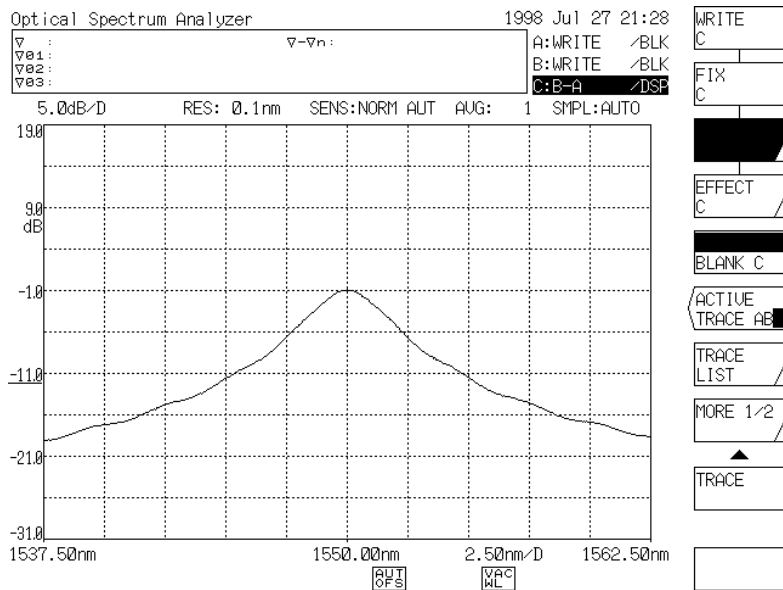

Optical Filter Transmission Factor



- (5) To perform auto scaling for the waveform that has undergone subtraction, refer to 8.2.3 Loss wavelength characteristic measurement.
- (6) To change the on-screen waveforms to the desired scale, manually set the subscale.  
The following explains how to change the subscale display to the percentage (%) mode.
- ① Press the [LEVEL] switch, and press the <SUB SCALE\*\*\*.\*/D> software key.  
The current sub scale value will be indicated in the interrupt display area.  
The sub scale value can be changed from 0.1 to 125.0%/D by the rotary knob, step keys, or numeric keys.  
The on-screen waveforms data is equal to the linear relational data multiplied by 100.  
The transparency rate of optical filter can be displayed in percentage.
- ② To change the bottom value of the subscale, press the <SCALE MIN \*\*\*.\*/> key.  
The current value will be indicated in the interrupt display area.  
The subscale value can be changed from 0 to the "/DIV" value of subscale multiplied by 10, by using the rotary knob, step keys, or numeric keys.

## 8.3 PMD Measurement

This equipment has the evaluation function of the polarization mode dispersion.

### 8.3.1 Overview

The polarization mode dispersion (PDM) of measured objects such as an optical fiber and the like can be calculated by combining with the wide band light source such as an ASE light source and high output LED light source, polarization controller, and analyzer.

### 8.3.2 Measurement system

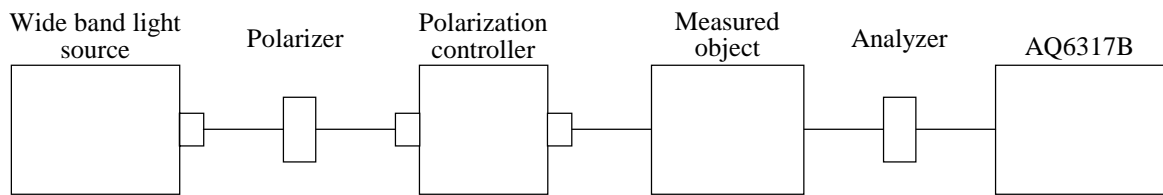

Fig. 8-5 PMD Measurement System

### 8.3.3 Measurement procedure

- ① Prepare the measurement system shown in Section 8. 3. 2.
- ② Set the necessary measurement conditions and measure the spectral width.  
Set the resolution to " approximately 0.05 nm" at this time.  
Match other wavelength settings with those of a light to be used.  
[SWEEP] selects the <REPEAT> key from the soft key menu of the switch.
- ③ Observing the waveform that is repeatedly swept, adjust the polarization controller so that the top and bottom (level difference between the maximum and minimum values) of a spectrum can be maximized.
- ④ After the polarization controller has been adjusted, sweep "<SINGLE>" by the [SWEEP] switch.
- ⑤ After the single sweep has terminated, press [ANALYSIS] and then the <ANALYSIS1 PMD>.  
The measurement spectrum automatically calculates the PMD.

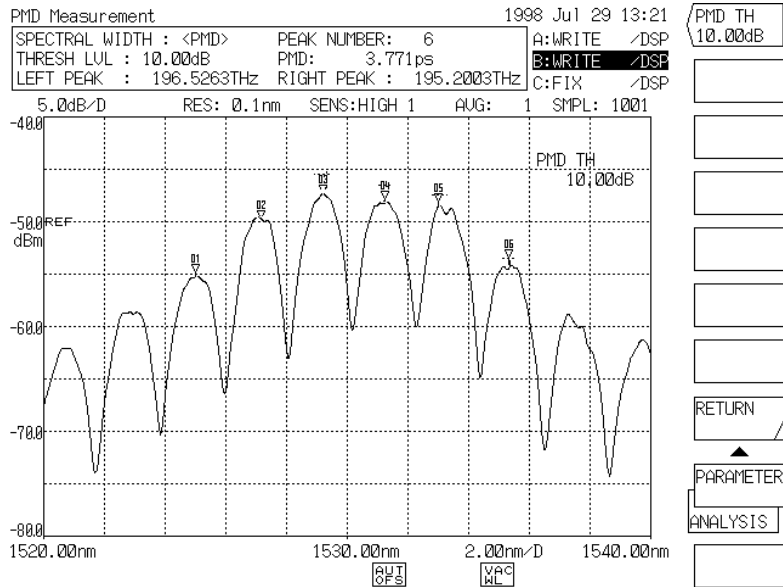

Fig.8-6 PMD Measurement Result

⑥ Threshold level setting

When measuring the PMD, the waveform that descends from the peak beyond a fixed position is not reflected in the measurement result. This fixed position is called threshold levels and is set using the "<PMD THRESH> key that is in the soft key of the <PARAMETER> key.

Besides, to recognize the fixed level differences on measured waveforms as the top and bottom differences, determine them using the <MODE DIFF> key at the <MORE 2/2> stage of the [PEAK SEARCH] switch.

The keys of the "<PMD THRESH> and <MODE DIFF> keys are shown below.

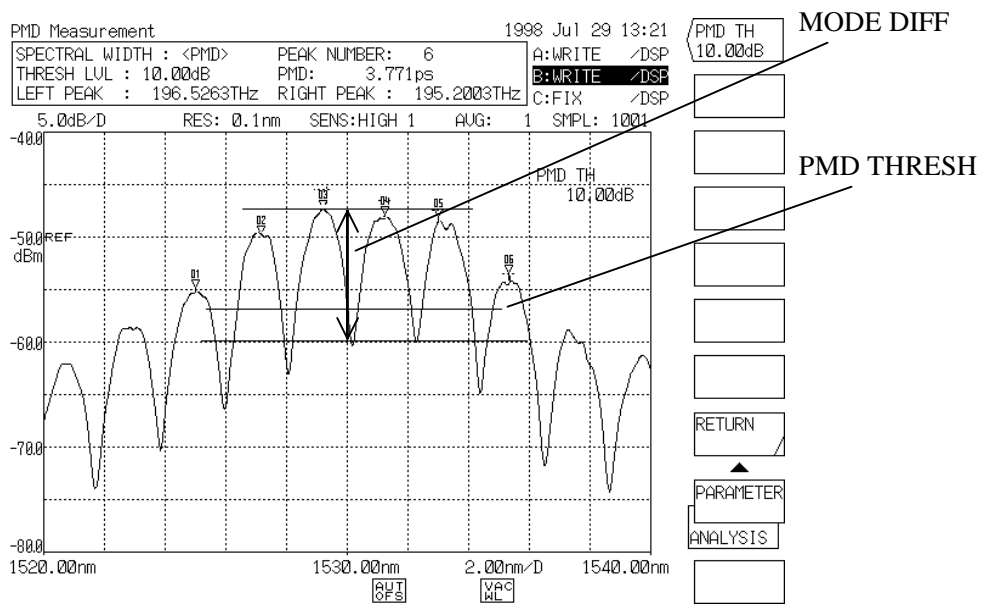

Fig.8-7 <PMD THRESH>Key and <MODE DIFF> Key

## 8.4 Usage of Markers

Using markers permit wavelength/level difference measurement, peak wavelength search, peak level search and spectral width search.

When using the markers, the [MARKER] switch of the [FUNCTION] section is used.

### 8.4.1 Marker names

There are two types of marker, namely, line marker and  $\nabla$  marker.

The line marker is classified into the wavelength line marker (for the axis of ordinates) and the level line marker (for the axis of abscissas). Two markers of each type are available.

The  $\nabla$  marker is classified into one moving marker and one hundred fixed markers.

A total of one hundred one markers can be used.

### 8.4.2 $\nabla$ marker

To search the peak wavelength and peak level (or bottom wavelength and bottom level) of the waveform displayed on the screen at the same time or to display the  $\nabla$  marker onto the screen, press the [PEAK SEARCH] switch or the [MARKER] switch.

Then, press the <MARKER> key in the displayed soft key menu.

The marker displayed by this operation is called "moving marker" which is moved in connection with the marker value (wavelength value and level value) on the data area by the rotary knob.

Move the moving marker to any optional position and press the <SET MKR 1,2> or <SET MARKER> key, and a fixed marker appears at that position.

- (1) When the <MARKER> key is pressed, the moving marker is displayed on the active trace waveform in the middle of the screen and the marker value is displayed in the data area if no moving marker is not displayed yet.

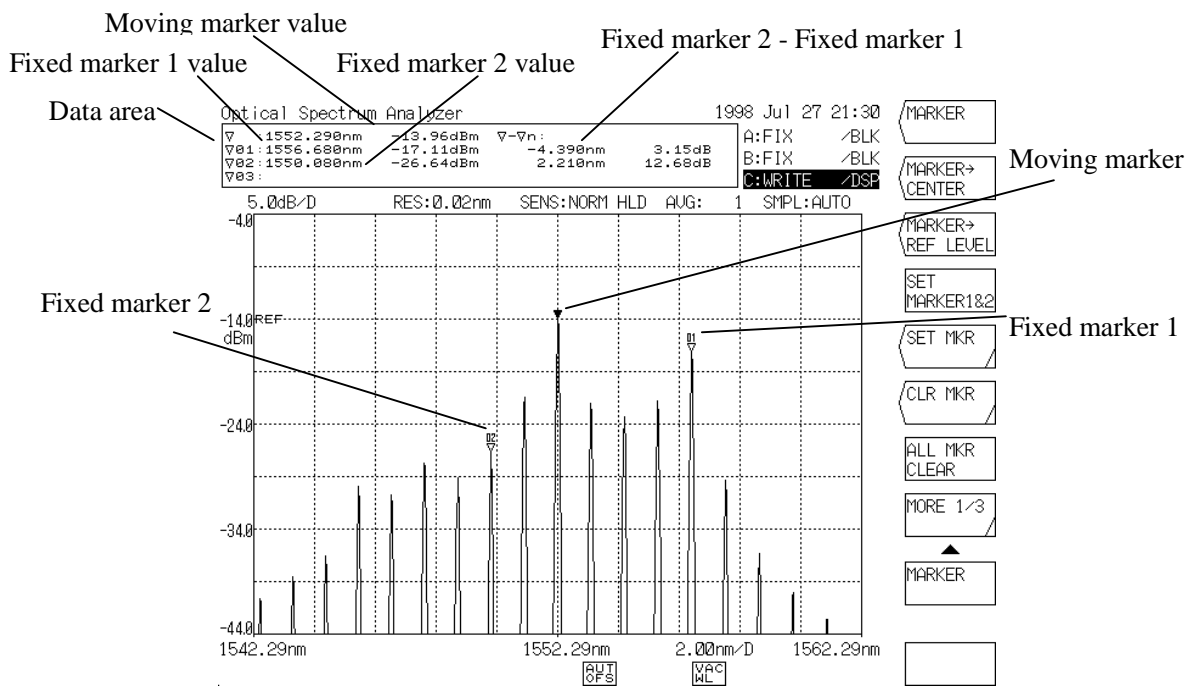

Example of ▽ Marker Display

- (2) The method of moving the moving marker is the same as that for the wavelength line marker.
- (3) When the <SET MKR 1, 2> key is pressed once, the fixed marker appears at the position of the moving marker. When it is pressed again, the fixed marker appears.
- (4) When the <SET MKR> key is pressed to select the fixed marker number by the rotary knob and ten-key pad and then the <ENTER> key is pressed, the fixed marker with an arbitrary number can be displayed.
- (5) The marker values of the moving and fixed markers are displayed in the data area.  
Up to three values of the fixed marker are displayed at a time.  
The data area is scrolled up or down by the step keys and the value of the remaining fixed marker can be displayed.
- (6) When the <CLR MKR> key is pressed to select the fixed marker number by the rotary knob and ten-key pad and then the <ENTER> key is pressed, the fixed marker with an arbitrary number can be cleared.
- (7) When the <MARKER CLEAR> key is pressed, all the ▽ markers and marker values displayed on the screen are cleared.

### 8.4.3 Wavelength line marker

To display the wavelength line marker onto the screen, press the [MARKER] switch and then the soft key <MORE 1/2>. In the soft key menu displayed by this operation, press the <LINE MARKER 1> or <LINE MARKER 2> key.

- When the key is pressed, the line marker is displayed at a 1/4 position from the left or right end of the screen and the marker value is displayed in the opposite position to the interrupt display section if the marker is not displayed yet. When both line markers 1 and 2 are displayed, difference of wavelength between them (L2 - L1) is shown below the marker value.

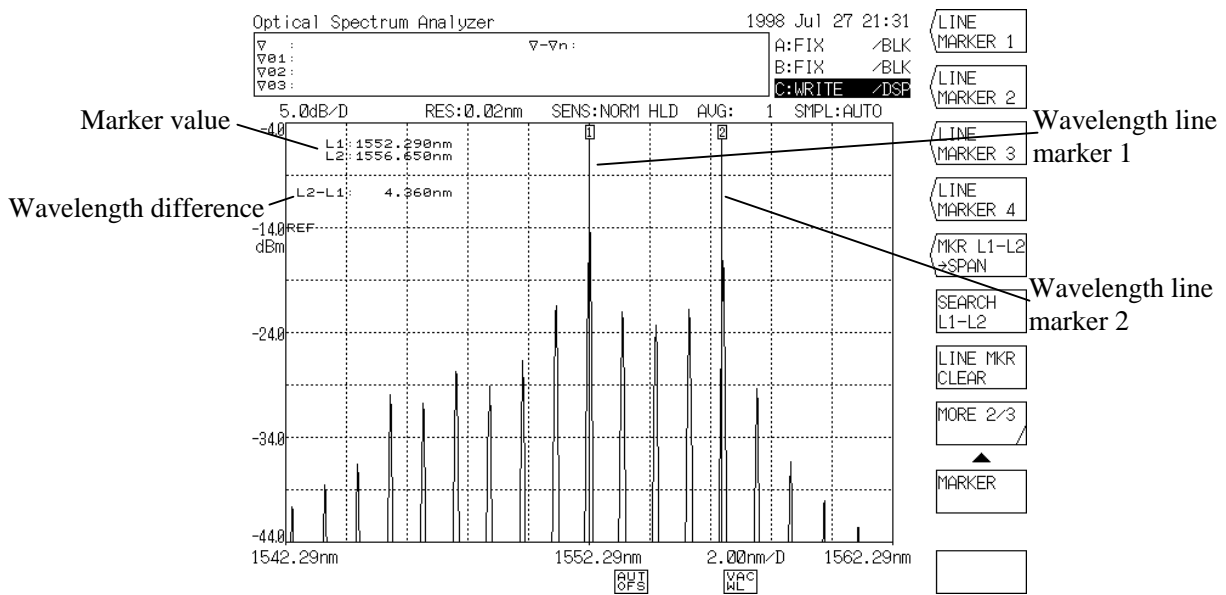

Example of Wavelength Line Marker Display

- Table 8-3 shows the method of moving the marker after it is displayed.

Table 8-3 Method of Moving Wavelength Line Marker

Wavelength line marker	Moving method
Movement to the right	Turn the rotary knob clockwise.
Movement to the left	Turn the rotary knob counterclockwise.

The marker value changed in real time in connection with the marker movement.

By pressing another key, the marker is fixed. When the same key is pressed once again, the marker is ready to move.

- When the <LINE MRK CLEAR> key is pressed, all the line markers and marker values on the screen are cleared.

## 8.4.4 Level line marker

To display the level line marker onto the screen, press the [MARKER] switch and then the soft key <MORE 1/2>.

In the soft key menu displayed by this operation, press the <LINE MARKER 3> or <LINE MARKER 4> key.

- (1) When the key is pressed, the level line marker is displayed at the  $\nabla$  marker position if the  $\nabla$  marker is displayed or at a 1/4 position from the upper or lower end of the screen if the  $\nabla$  marker is not displayed, and the marker value is displayed on the opposite position of the interrupt display section.

When both line markers 3 and 4 are displayed, difference of wavelength between them (L4 - L3) is shown below the marker value.

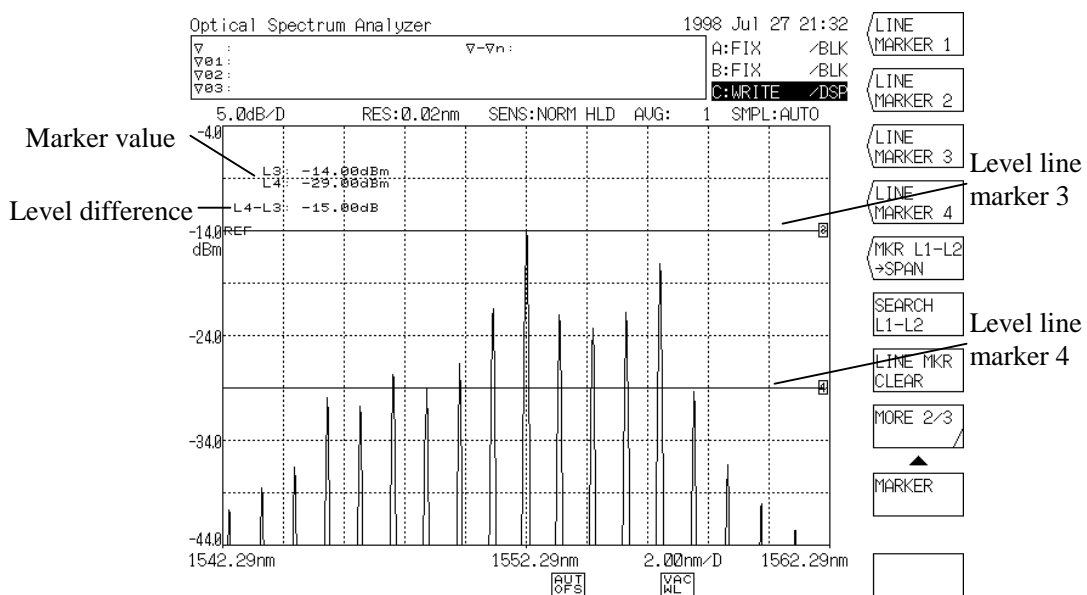

Example of Level Line Marker Display

- (2) Table 8-4 shows the method of moving the marker after it is displayed.

Table 8-4 Method of Moving Level Line Marker

Level line marker	Moving method
Movement to the up	Turn the rotary knob clockwise or press the step key [ $\uparrow$ ].
Movement to the down	Turn the rotary knob counterclockwise or press the step key [ $\downarrow$ ].

The marker value changed in real time in connection with the marker movement.

By pressing another key, the marker is fixed. When the same key is pressed once again, the marker is ready to move.

- (3) When the <LINE MRK CLEAR> key is pressed, all the line markers and marker values on the screen are cleared.

## 8.4.5 Auto search

The peak level and peak wavelength or the bottom level and bottom wavelength can be automatically searched at each sweep. This function is useful for observing changes of the peak level and peak wavelength while repeat sweep processing is continued.

- (1) Press the [PEAK SEARCH] switch and then the soft key <MORE 1/2>. In the soft key menu displayed by this operation, press the <AUTO SEARCH> key to display it in reverse video.
- (2) After the <AUTO SEARCH> key is pressed into a display in reverse video, press the [PEAK SEARCH] switch and then the soft key <PEAK SEARCH>. After that, the peak level and peak wavelength are automatically searched at each sweep and moving marker is displayed. After the [PEAK SEARCH] switch is pressed and also the soft key <BOTTOM SEARCH> is pressed, the bottom level and the bottom wavelength are automatically searched and the moving marker is displayed.
- (3) To clear the auto search mode, press the <AUTO SEARCH> key once again to reset its display in reverse video to the initial status.



## 8.4.6 Wavelength difference and level difference measurement

The wavelength difference and level difference can be measured by using the fixed marker.

- (1) Press the [PEAK SEARCH] switch or [MARKER] switch. In the soft key menu displayed by this operation, press the <MARKER> key to display the moving marker.
- (2) Move the moving marker to an optional position and press the <SET MARKER 1> key. Then, the fixed marker 1 appears at that position and both wavelength value and level value of the fixed marker 1 are displayed at  $\nabla$ 1 in the data area.
- (3) When the moving marker is moved further, the wavelength difference and level difference from the fixed marker 1 are displayed at the right end of the data area. The wavelength difference and level difference change in connection with the movement of the moving marker.

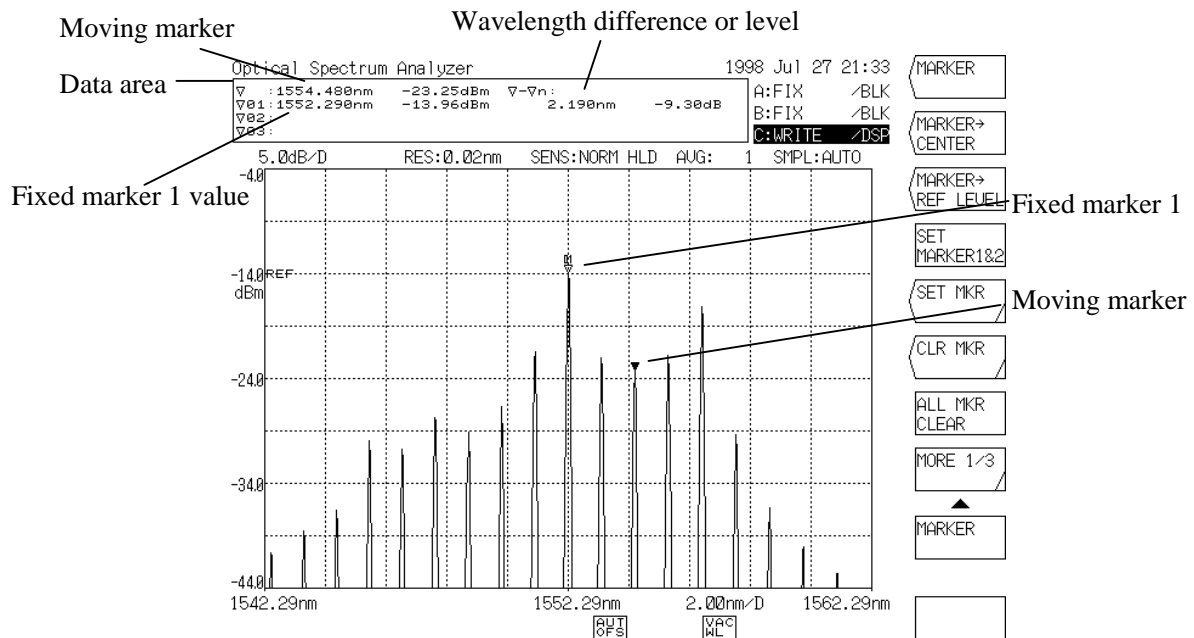

Wavelength Difference Measurement

- (4) Move the moving marker to an optional position and press the <SET MARKER 2> key. The fixed marker 2 appears at that position and the wavelength difference and level difference between the fixed marker 1, 2 and moving marker are displayed.

### NOTE

As a level difference, (fixed marker 2 - fixed marker 1) is displayed when the level axis is of LOG scale or (fixed marker 2 / fixed marker 1) is displayed when the level axis is of linear scale.

- (5) When the <MORE 2/3> or <MORE 3/3> key is pressed and the <OFFSET SPACING> key is used to select SPACING, the wavelength difference and level difference between the fixed markers are displayed.

## 8.5 Convenient Functions

### 8.5.1 Marker-to-marker sweep function

The marker-to-marker sweep function permits a sweep between the wavelength line marker 1 and wavelength line marker 2.

Because the sweep range is limited to the section between the marker 1 and marker 2, high-speed sweep processing can be executed.

This function is useful for observing variations in a specific portion of the spectrum.

(→ 5.1.1 [SWEEP] switch)

- (1) Set the wavelength line marker 1 and wavelength line marker 2 to both sides of the range to be swept.

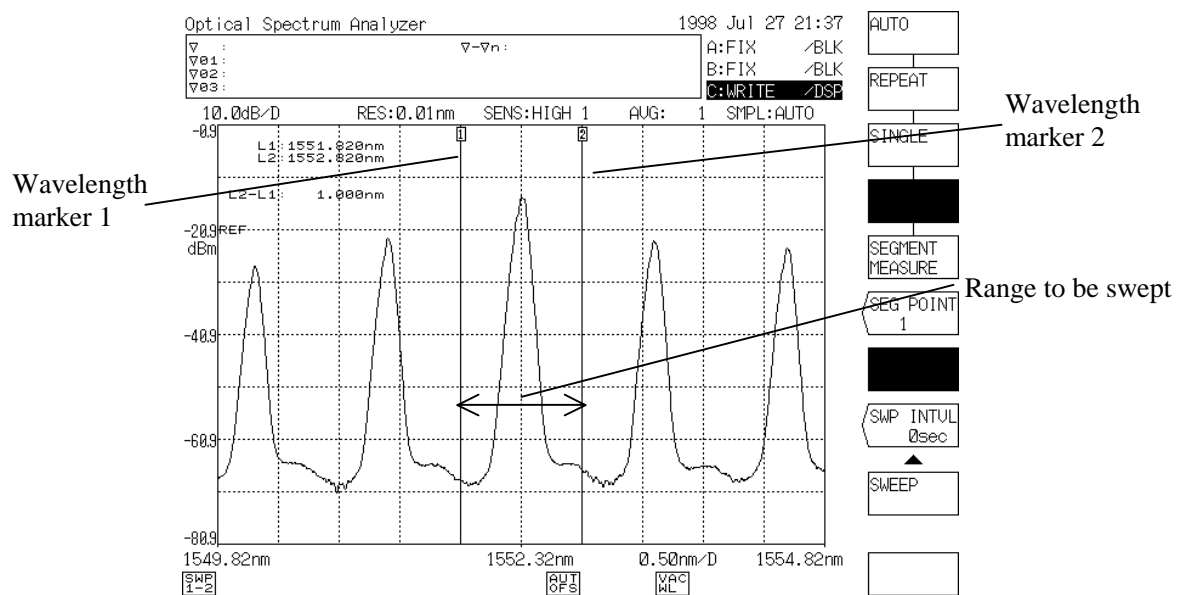

Marker-to-Marker Sweep Range Setting

- (2) Press the [SWEEP switch]. In the soft key menu displayed by this operation, press the <SWEEP MKR L1-L2> key to display it in reverse video. When the <REPEAT> or <SINGLE> key is pressed, the marker-to-marker sweep function is executed and a repeat or single sweep is performed between the wavelength line marker 1 and wavelength line marker 2.

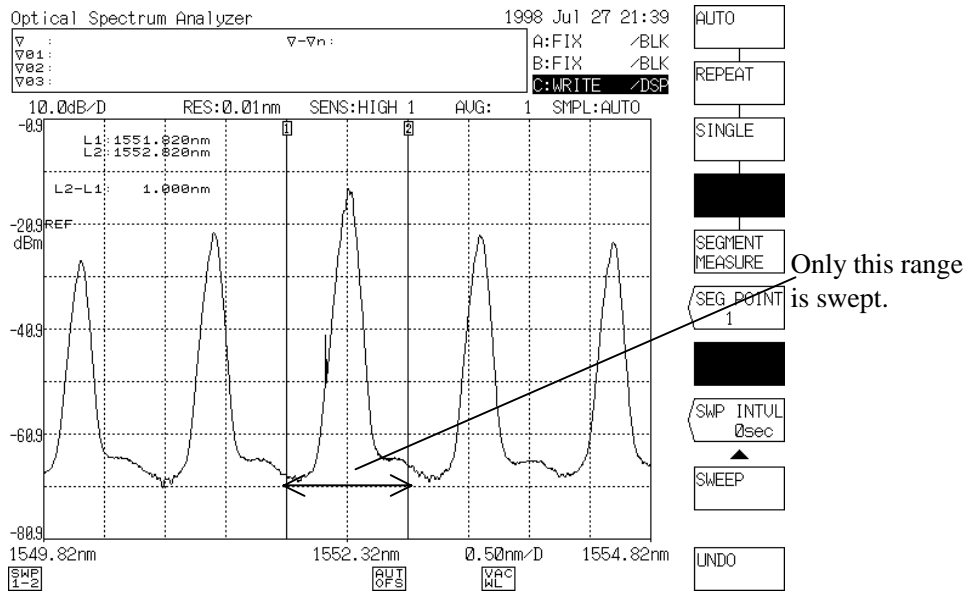

After Execution of Marker-to-Marker Sweep Function

- (3) To cancel the marker-to-marker sweep function, press the [SWEEP] switch. In the soft key menu displayed by this operation, press the <SWEEP MKR L1-L2> key again to reset its display in reverse video into the initial status. After the display in reverse video is reset to the initial status, the marker-to-marker sweep function is canceled and sweep processing is executed for all the range of the screen.

## 8.5.2 Marker-to-marker power measurement function

On a displayed waveform, the integrated power of the portion enclosed by the wavelength line marker 1 and wavelength marker 2 can be obtained.

(→ 5.1.10 [ANALYSIS] switch, (2)-2 <POWER> key)

This function is useful for ASE evaluation of an optical amplifier.

- (1) Set the wavelength line marker 1 and wavelength line marker 2 on both sides of the range where integrated power is to be measured.

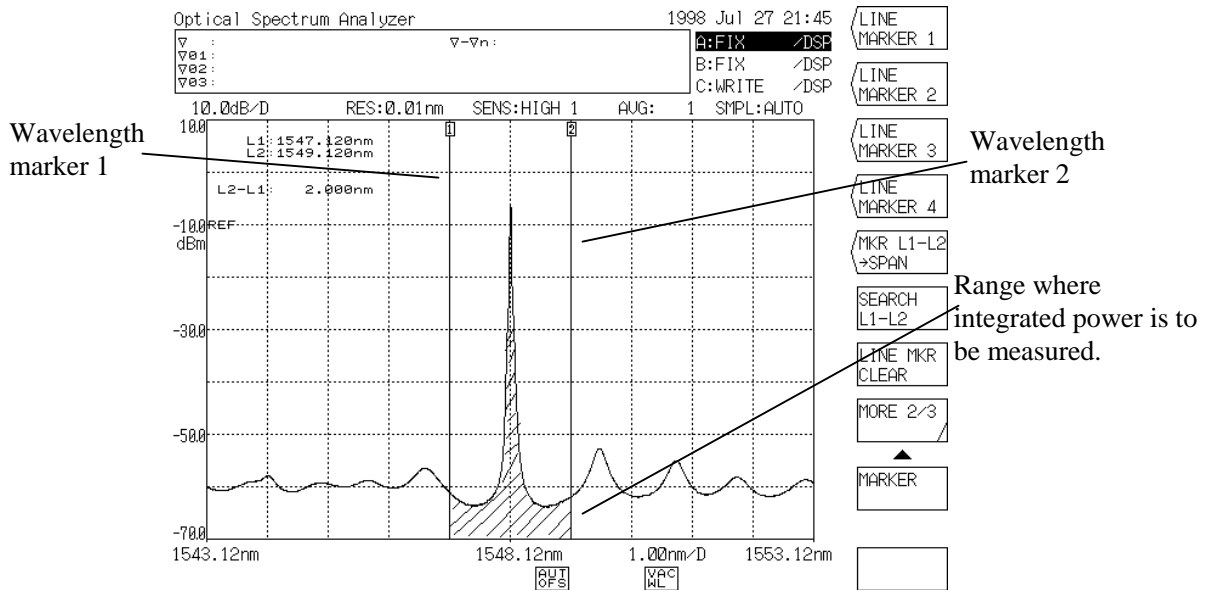

Marker-to-Marker Power Measurement Range Setting

- (2) Press the [MARKER] switch and then the soft key <MORE 1/2>. In the soft key menu displayed by this operation, press the <SEARCH L1-L2> key to display it in reverse video.
- (3) Press the [ANALYSIS] key. In the displayed soft key menu, press the <POWER> key to display it in reverse video. When the key is pressed, marker-to-marker power measurement is executed and the integrated power of the hatched portion in the above figure is calculated. The obtained integrated power value is displayed in the data area. When the <POWER> key is pressed unless the <SEARCH L1-L2> key is displayed in reverse video, integrated power calculation is performed for all range of the screen.

The integrated power value is displayed.

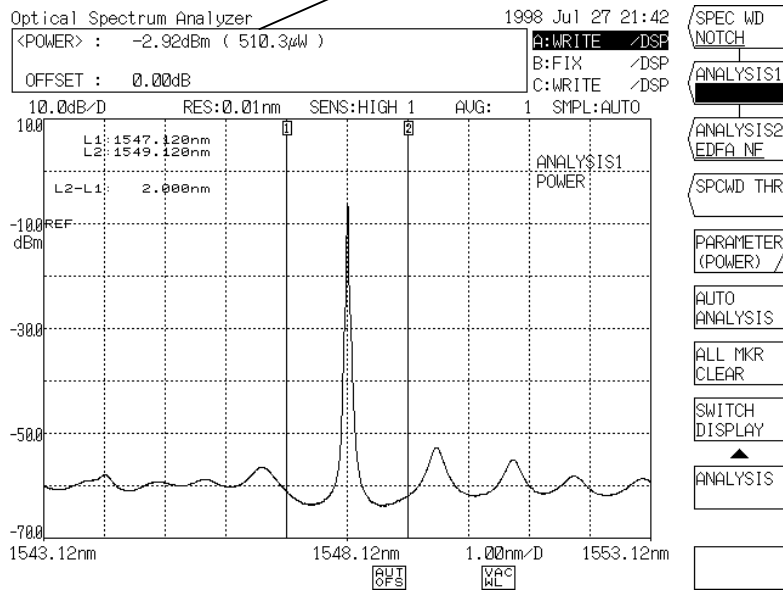

After Execution of Marker-to-Marker Power Measurement Function

- (4) To cancel the marker-to-marker power measurement function, press the [ANALYSIS] switch and then the spectral width search or SMSR measurement soft key to display it in reverse video. When the key is displayed in reverse video, the [ANALYSIS] switch executes the function of the soft key displayed in reverse video.

### 8.5.3 0 nm sweep function

This function measures a secular change of level with a specific wavelength, and is useful for optical axis alignment in entering the light source into an optical fiber.

(→ 5.1.4,5 [SPAN] switch)

Taking a case where the He-Ne gas laser (632.8 nm) space light enters an optical fiber as shown in Figure 8-8, as an example, this function will be explained below.

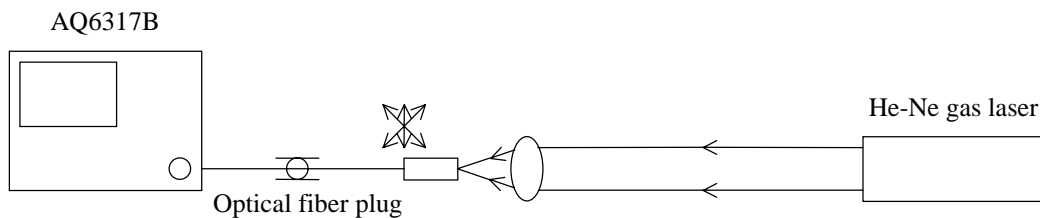
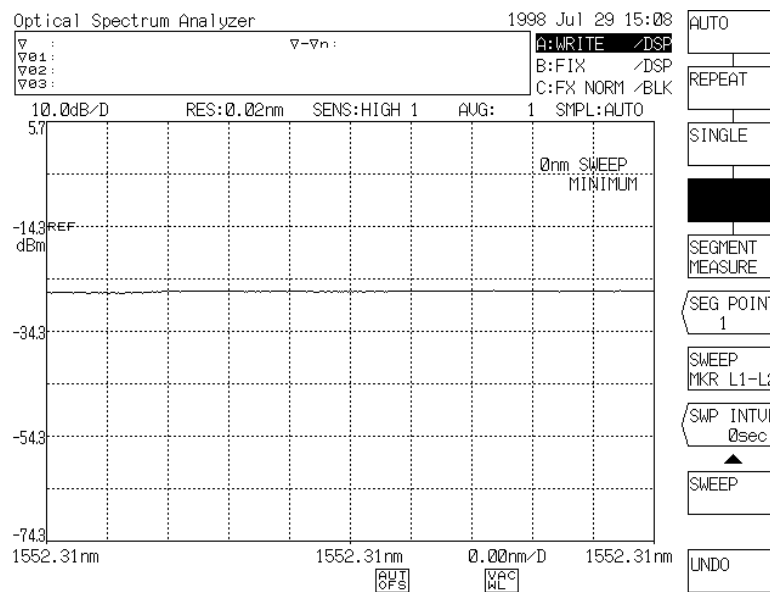

Fig. 8-8 Space Light Entering an Optical Fiber

- (1) Set the mean wavelength of this equipment to 632.8 nm and the resolution to 10 nm.
- (2) Set the sweep width to 0 nm, specifying a 0 nm sweep.  
When the sweep width is set to 0 nm, all of sweep start wavelength, mean wavelength and sweep end wavelength are set to 632.8 nm, so that the axis of abscissas becomes a time axis.
- (3) With the 0 nm sweep set, the time required for a sweep from the left end to the right end of the screen can be set by the <0 nm SWEEP TIME> key in the soft key menu displayed by pressing the [SPAN] switch.
- (4) Press the soft key <REPEAT> after pressing [SWEEP] key.  
When the switch is pressed, it is possible to observe a secular change of level at 632.8 nm at which repeat sweep processing is executed.



0 nm Sweep

- (5) While observing the displayed waveform, move the optical fiber plug slightly to cause the incident amount of the light source to go to the peak value.

## 8.5.4 Normalization display function

This function displays a waveform in normalized form.

(→ 5.1.11 [TRACE] switch, (30) <NORMALIZE C> key)

- (1) Display a waveform to be normalized onto the screen.

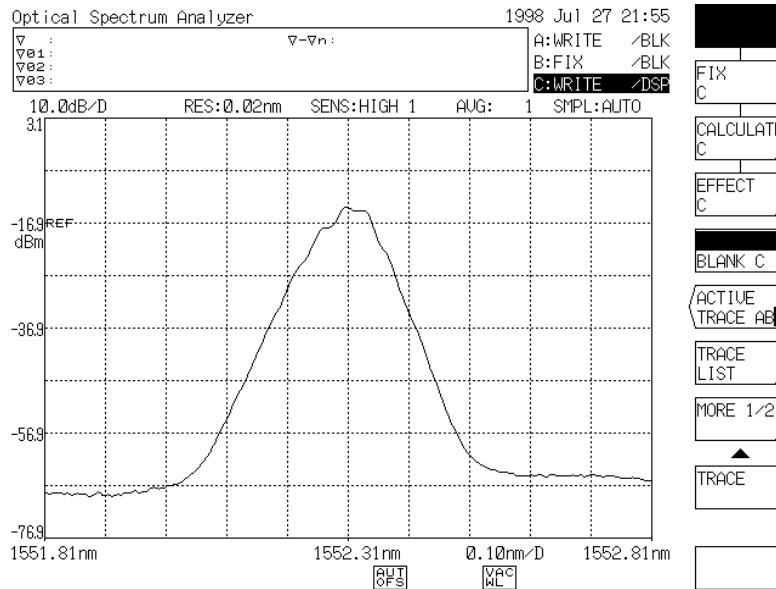

Before Execution of Normalize Display Function

- (2) Press the [TRACE] switch and then the <ACTIVE TRACE A B C> key. In the soft key menu displayed by this operation and setting the display in reverse video to "C", press the <EFFECT C> key.

Next, press the <NORMALIZE C> key.

When the key is pressed, the waveform peak is set to 1 dB when the subscale is a linear scale or to 0 dB when the subscale is a LOG subscale, and the waveform is normalized and then displayed.

"C:NORM/DSP (or BLK)" is displayed in the trace status display section. This indicates that the waveform has been processed by this function.

If the waveform level is too low, this function is not executed.

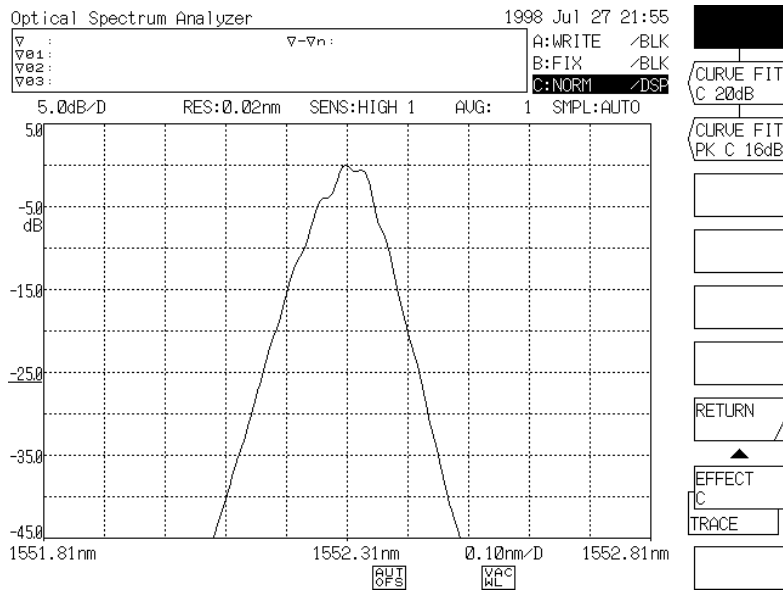

Display Made by Pressing <NORMALIZE C> key

### 8.5.5 Three-dimensional display function

The three-dimensional display function can simultaneously display 3 to 16 spectrums with the Z-axis (direction of depth) added to the normal display. (→ 5.1.12 [DISPLAY] switch, (3) 3D DISPLAY> key, (13) <ANGLE> key and (15) <Z-SCALE> key)

On the three-dimensional display, the newest waveform is displayed most forward at each sweep and the existing waveforms are fed backward one after another.

When a sweep is performed at time intervals, the Z axis represents the time elapsed.

Accordingly, a secular change of the light source spectrum can be observed.

When a sweep is performed changing light source parameters (temperature, LD bias current, etc.), the Z axis represents these parameters at measurement.

Taking a case where a secular change of spectrum is observed at intervals of 10 seconds by using the three-dimensional display function, as an example, this function will be explained as follows.

#### NOTE

*In the three-dimensional display mode, the waveforms displayed by the step keys can be selected by use of the marker. The parameters can be changed by the rotary control knob or numeric keys.*



- (1) On the ordinary display screen, set measuring conditions suitable for measuring the spectrum.

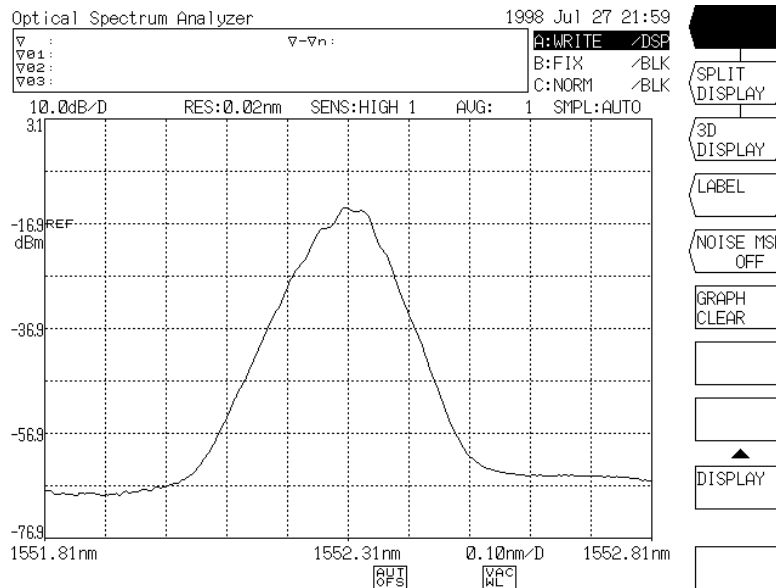

Measuring Condition Setting on Ordinary Screen

- (2) Press the [SWEEP] switch. In the soft key menu displayed by this operation, press the <SWP INTVL> key.  
Set the WAIT time to 10 s and press the [nm/ENTER] or [ $\mu$ m/ENTER] key.  
( $\rightarrow$  5.1.1 [SWEEP] switch, (8)<SWP INTVL> key)
- (3) Press the [DISPLAY] switch. In the soft key menu displayed by this operation, press the <3D DISPLAY> key.  
When the switch is pressed, the screen changes from the ordinary display screen to the 3-dimensional display screen.
- (4) Press the [SWEEP] switch. In the soft key menu displayed by this operation, press the <REPEAT> key.  
When the switch is pressed, a sweep is performed at intervals of 10 seconds and a waveform is displayed on the 3-dimensional display screen. It is possible to observe a secular change of the spectrum at intervals of 10 seconds.
- (5) To return the 3-dimensional display screen to the ordinary display screen, press the <STOP> key to stop the sweep and then press the [DISPLAY] switch. In the soft key menu displayed by this operation, press the <NORMAL DISPLAY> key.
- (6) For setting the display angle and the number of display spectrums for 3-dimensional display, refer to 5.1.12 [DISPLAY] switch, (13) <ANGLE> key, <15> <Z-SCALE> key.)

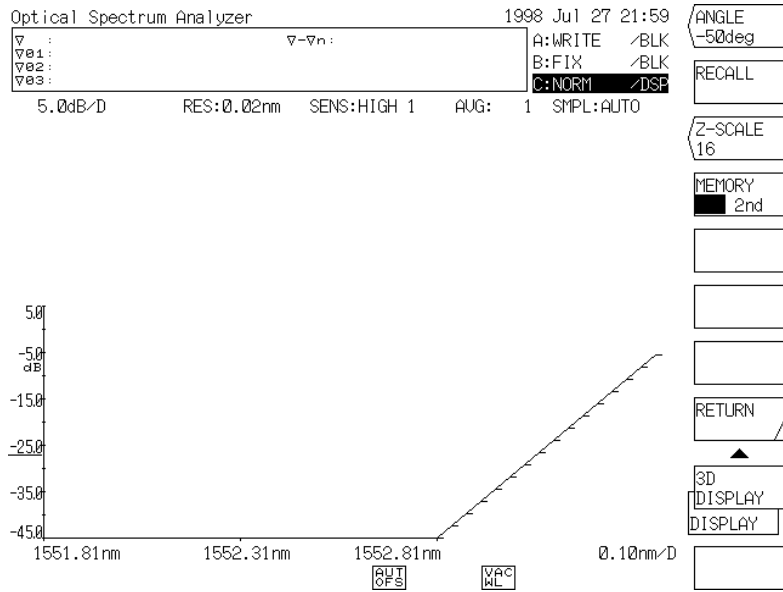

### Three-Dimensional Display Screen

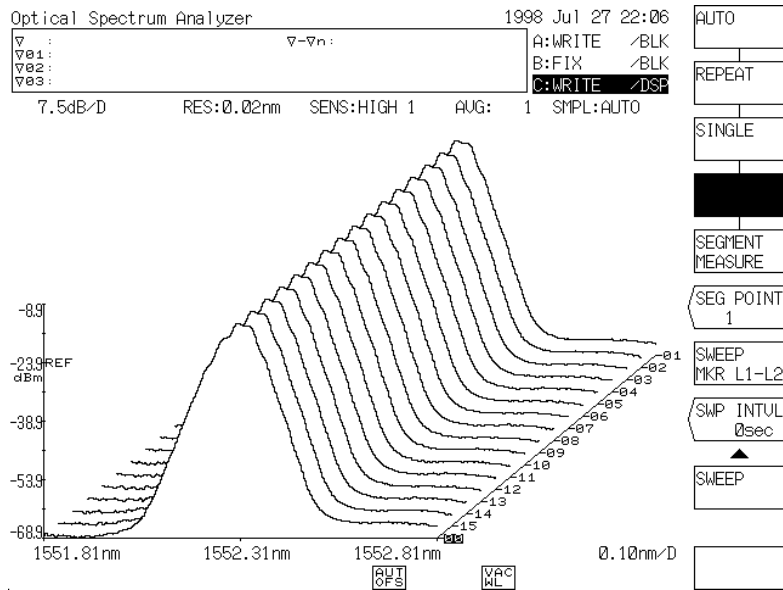

Display Made by Pressing <REPEAT> key (3-dimensional display screen)

# Chapter 9 GP-IB FUNCTIONS

This chapter describes the GP-IB functions.

## Contents of Chapter 9

9.1	GP-IB 1 Port and GP-IB 2 Port .....	9-2
9.2	Usage of GP-IB 1 Port .....	9-3
9.2.1	Interface functions of GP-IB 1 port.....	9-3
9.2.2	Connection to GP-IB system.....	9-3
9.2.3	Address setting.....	9-4
9.2.4	Local/remote function .....	9-4
9.2.5	Program codes (commands).....	9-4
9.2.6	Output data.....	9-41
9.2.7	Service request function.....	9-59
9.2.8	Precautions on programming.....	9-61
9.2.9	Programming examples.....	9-62
9.3	Usage of GP-IB 2 Port.....	9-71
9.3.1	Interface functions of GP-IB 2 port.....	9-71
9.3.2	Connection to GP-IB system.....	9-71
9.3.3	Address setting.....	9-72
9.3.4	Wavelength variable light source control.....	9-72
9.3.5	External unit control.....	9-72

## 9.1 GP-IB 1 Port and GP-IB 2 Port

This equipment can be controlled externally by the GP-IB (conforming to IEEE-488, and also can control other external units when this equipment itself functions as a controller.

There are two GP-IB ports (connectors) on the rear panel of this equipment.

- GP-IB 1  
Used to control this equipment remotely by a controller such as personal computer.  
This port connects the controller and other units to be controlled by this controller.
- GP-IB 2  
Used to control external units when this equipment itself functions as a controller.  
This port connects the X-Y plotter and external units to be controlled by the program functions of this equipment.

### CAUTION

- *Even if a controller such as a personal computer is connected to the GP-IB 2 port, it is impossible to control this equipment remotely.*
- *Even if external units to be controlled by the wavelength variable light source or program functions are connected to the GP-IB 1 port, they cannot be operated.*
- *These two GP-IB ports are independent of each other. Accordingly, it is impossible to send messages directly from a controller connected to the GP-IB 1 port to an external unit connected to the GP-IB 2 port.*

## 9.2 Usage of GP-IB 1 Port

### 9.2.1 Interface functions of GP-IB 1 port

Table 9-1 shows the interface functions of the GP-IB 1 port.

Table 9-1 Interface Functions of the GP-IB 1 Port

Code	Interface function
SH1	All send functions
AH1	All receive functions
T6	Basic talker Serial polling Talker release by MLA
L4	Basic listener Listener release by MTA
SR1	All service request functions
PL1	All remote/local functions
PP0	No parallel polling function
DC1	All device clear functions
DT1	All device trigger functions
C0	No controller function
E1	Open collector driver

### 9.2.2 Connection to GP-IB system

Turn off the power supply of this equipment and the power supplies of the units (e.g., controller) to be connected to this equipment. Connect the units to the GP-IB 1 connector on the back panel of this equipment by GP-IB cord.

Tighten the fixing screw of the connector firmly.

#### CAUTION

*If the GP-IB cord is connected or disconnected on the power ON status, this will cause a malfunction or failure to this equipment.*

### 9.2.3 Address setting

The GP-IB address is set by the <MY ADRS> key of the [SYSTEM] switch. When the soft key is pressed, the current address is displayed in the interrupt display section of the screen.

Set the address to 0 to 30 by the rotary knob, step keys or ten key pad.

### 9.2.4 Local/remote function

- (1) When REN and ATN are caused to go "true" by the controller and the listen address is sent, this equipment is put into the remote status.
- (2) In the remote status, all the panel switches and soft keys except the <LOCAL> key become ineffective. The [REMOTE] lamp comes on to indicate the remote status.
- (3) By pressing the <LOCAL> key, this equipment is returned to the local status and the switches on the panel are enabled.
- (4) When the GTL (Go To Local) message is sent from the controller or REN is caused to go "false", this equipment can also be returned to the local status.
- (5) When the LLO (Local Lock Out) message is sent from the controller, this equipment is put into the local lock out status. This status can not be returned to the local status by pressing the <LOCAL> key. To reset the local lock out status, cause REN to go "false" by the controller.

### 9.2.5 Program codes (commands)

- (1) Table 9-2 shows a program code (command) list of this equipment. If these program codes are sent from the controller in the remote status, this equipment performs the operations shown in the table.
- (2) Several program codes can be sent in connected form by using "," for connection. However, the receive buffer capacity of this equipment is 512 bytes. When the total number of characters except blanks (including control codes), an excess of program codes is ignored.
- (3) The following two delimiters are valid.
  - CRLF
  - EOI
- (4) Every blank is ignored.
- (5) All incorrect program codes are ignored.

Table 9-2 GP-IB Program Codes (1/36)

① [FUNCTION] section

Function	Control command	Explanation	Talker command	Talker output data format																
[SWEEP]																				
<AUTO>	AUTO	Starts an auto sweep.	} SWEEP?	Output of measurement status <table border="1"> <thead> <tr> <th>Status</th> <th>Output</th> </tr> </thead> <tbody> <tr> <td>STOP</td> <td>0</td> </tr> <tr> <td>SINGLE</td> <td>1</td> </tr> <tr> <td>REPEAT</td> <td>2</td> </tr> <tr> <td>AUTO</td> <td>3</td> </tr> <tr> <td>SEGMENT MEASURE</td> <td>4</td> </tr> <tr> <td>WL CAL</td> <td>11</td> </tr> <tr> <td>OPTICAL ALIGNMENT</td> <td>12</td> </tr> </tbody> </table>	Status	Output	STOP	0	SINGLE	1	REPEAT	2	AUTO	3	SEGMENT MEASURE	4	WL CAL	11	OPTICAL ALIGNMENT	12
Status	Output																			
STOP	0																			
SINGLE	1																			
REPEAT	2																			
AUTO	3																			
SEGMENT MEASURE	4																			
WL CAL	11																			
OPTICAL ALIGNMENT	12																			
<REPEAT>	RPT	Starts a repeat sweep.																		
<SINGLE>	SGL	Starts a single sweep.																		
<SEGMENT MEASURE>	SMEAS	Measures according to the set sampling count.																		
<STOP>	STP	Stops a sweep.																		
<SEG POINT****>	SEGP****	Sets the sampling count for measurement by SEGMENT MEASURE. ****: 1 to 20001 (1 step)	SEGP?	1 to 20001																
<SWEEP MKR L1-L2>	SWPM*	Selects ON or OFF for the marker-to-marker sweep function. ON...*: 1 OFF...*: 0	SWPM?	ON: 1, OFF: 0																
<SWP INTVL*****sec>	SWPI*****	Sets the time from a start of a sweep till a start of the next sweep in the repeat sweep mode. (Unit: sec) *****: 0 to 99999(1 step) 0 = MINIMUM	SWPI?	0 to 99999																

Table 9-2 GP-IB Program Codes (2/36)

Function	Control command	Explanation	Talker command	Talker output data format
<b>[CENTER]</b>				
<CENTER****.***nm>	CTRWL****.**	Sets the center wavelength (Unit: nm) ****.**: 600.00 to 1750.00 (0.01 step)	CTRWL?	600.00 to 1750.00
<CENTER****.***THz>	CTRF***.**	Sets the center frequency. (unit: THz) ***.***: 171.500 to 499.500 (0.001 step)	CTRF?	171.500 to 499.500
<START WL****.***nm>	STAWL****.**	Sets the measurement start wavelength. (Unit: nm) ****.**: 0.00 to 1750.00 (0.01 step)	STAWL?	0.00 to 1750.00
<START ***.***THz>	STAF***.**	Sets the measurement start frequency. (Unit: THz) ***.***: 1.000 to 499.500 (0.001 step)	STAF?	1.000 to 499.500
<STOP WL****.***nm>	STPWL****.**	Sets the measurement end wavelength. (Unit: nm) ****.**: 600.00 to 2350.00 (0.01 step)	STPWL?	600.00 to 2350.00
<STOP ***.***THz>	STPF***.**	Sets the measurement end frequency. (Unit: THz) ***.***: 171.500 to 674.500 (0.001 step)	STPF?	171.500 to 674.500
<PEAK→CENTER>	CTR=P	Sets the waveform peak to the center wavelength.	None	
<AUTO CENTER>	ATCTR*	Selects ON or OFF for the peak-center function at each sweep. PEAK→CENTER ON...*: 1 OFF...*: 0	ATCTR?	ON: 1, OFF: 0
<b>[SPAN]</b>				
<SPAN****.***nm>	SPAN****.*	Sets the span. (Unit: nm) ****.*: 0, 0.5 to 1200.0 (0.1 step)	SPAN?	0, 0.5 to 1200.0
<SPAN ***.***THz>	SPANF	Sets the span. (Unit: THz) ***.***: 0, 0.100 to 350.000 (0.001 step)	SPANF?	0, 0.100 to 350.000
<Δλ→SPAN>	SPN=W	Sets the span according to the spectral width.	None	
<0 nm SWEEP TIME**S>	ZSWPT**	Measurement time from the left end of the screen to the right end at a sweep with a span of 0 nm. (Unit: sec) **: 0 to 50 (1 step) 0 = MINIMUM	ZSWPT?	0 to 50



Table 9-2 GP-IB Program Codes (3/36)

Function	Control command	Explanation	Talker command	Talker output data format
[LEVEL]				
<REF LEVEL>	REFL***.*	Sets the reference level. [in LOG] (Unit: dBm) ***.*: -90.0 to 20.0 (0.1 step)	REFL?	-90.0 to 20.0
	REFLP*.**	Sets the reference level. [in linear] (Unit: pW) *.**: 1.00 to 9.99 (0.01 step) 10.0 to 99.9 (0.1 step) 100 to 999 (1 step)		PW 1.00 to 999
	REFLN*.**	Sets the reference level. [in linear] (Unit: nW) *.**: 1.00 to 9.99 (0.01 step) 10.0 to 99.9 (0.1 step) 100 to 999 (1 step)		NW 1.00 to 999
	REFLU*.**	Sets the reference level. [in linear] (Unit: μW) *.**: 1.00 to 9.99 (0.01 step) 10.0 to 99.9 (0.1 step) 100 to 999 (1 step)		UW 1.00 to 999
	REFLM*.**	Sets the reference level. [in linear] (Unit: mW) *.**: 1.00 to 9.99 (0.01 step) 10.0 to 100 (0.1 step)		MW 1.00 to 100
<LVL SCALE**.*dB/D>	LSCL**.*	Sets the scale of the level axis. **.*: 0.1 to 10.0 (0.1 step. Unit: dB/DIV) or LIN (linear scale)	LSCL?	0.1 to 10.0 a 0 (Linear scale)
<BASE LVL***.*mW>	BASL***.*	Sets the bottom scale value in Linear Scale mode. ***.*: 0 to REF LEVEL × 0.9	BASL?	PW 1.00 to 999    NW 1.00 to 999 UW 1.00 to 999    MW 1.00 to 999
<PEAK→REF LEVEL>	REF=P	Sets the peak level to the reference level.	None	
<AUTO REF LEVEL>	ATREF*	Selects ON or OFF for the PEAK→REF LEVEL function to be executed at each sweep. ON...*: 1    OFF...*: 0	ATREF?	ON: 1, OFF: 0

Table 9-2 GP-IB Program Codes (4/36)

Function	Control command	Explanation	Talker command	Talker output data format
[LEVEL]				
<dBm dBm/nm>	LSUNT*	Switches the level axis scale display between "dBm(W)" and "dBm/nm" (or "W/nm"). dBm(W) ....*: 0 dBm/nm (W/nm) ....*: 1	LSUNT?	dBm(W): 0 dBm/nm(W/nm): 1
<SUBLOG**.*dB>	SLOG**.*	Sets the subscale (at LOG) **.*: 0.1 to 10.0 (0.1 step)	SLOG?	0.1 to 10.0
<SUB LIN*.*D>	SLIN*.*	Sets the subscale (at LINEAR) *.*: 0.005 to 1.250 (0.005 step)	SLIN?	0.005 to 1.250
<SUB SCALE**.*dB/km>	SKM**.*	Sets the subscale to "dB/km". **.*: 0.1 to 10.0 (0.1 step)	SKM?	0.1 to 10.0
<SUB SCALE***.*%/D>	SPS***.*	Sets the subscale to "%/D". ***.*: 0.5 to 125.0 ( 0.1 step)	SPS?	0.5 to 125.0
<OFST LVL***.*dB>	LOFST***.*	Sets the offset level of the scale. (Unit: dB) ***.*: -99.9 to 99.9 (0.1 step)	LOFST?	-99.9 to 99.9
<OFST LVL***.*dB/km>	LOFSKM***.*	Sets an offset of subscale. (in dB/km) ***.*: -99.9 to 99.9 (0.1 step)	LOFSKM?	-99.9 to 99.9
<SCALE MIN***.*>	SMIN***.*	Sets the bottom scale value in Linear subscale mode. ***.*: 0 to (DIV) × 10	SMIN?	0 to 12.5
<SCALE MIN***.*%>	SMINP***.*	Sets the bottom scale value in "%" subscale mode. ***.*: 0 to (DIV) × 10	SMINP?	0 to 125
<LENGTH**.*km>	LNGT**.*	Sets an optical fiber length. **.*: 0.001 to 99.999 (0.001 step)	LNGT?	0.001 to 99.999
<AUTO SUBSCALE>	ATSCL*	Selects ON or OFF for the auto scaling display function ON....*: 1 OFF....*: 0	ATSCL?	ON: 1, OFF: 0

Table 9-2 GP-IB Program Codes (5/36)

Function	Control command	Explanation	Talker command	Talker output data format														
[SETUP]																		
<RESOLN*.**nm>	RESLN*.**	Sets the resolution. (Unit: nm) *.**: 0.01 to 2.0 (1-2-5 steps)	RESLN?	0.01 to 2.0														
<RESOLN ***GHz>	RESLNF***	Sets the resolution. (Unit: GHz) ***: 2, 4, 10, 20, 40, 100, 200, 400	RESLNF?	2, 4, 10, 20, 40, 100, 200, 400														
<SENS>		Sets the measuring sensitivity.	SENS?	Output of measuring sensitivity <table border="1"> <thead> <tr> <th>Measuring sensitivity</th> <th>Output</th> </tr> </thead> <tbody> <tr> <td>SENS HIGH1</td> <td>1</td> </tr> <tr> <td>SENS HIGH2</td> <td>2</td> </tr> <tr> <td>SENS HIGH3</td> <td>3</td> </tr> <tr> <td>SENS NORM RANG HOLD</td> <td>4</td> </tr> <tr> <td>SENS NORM RANG AUTO</td> <td>5</td> </tr> <tr> <td>SENS MID</td> <td>6</td> </tr> </tbody> </table>	Measuring sensitivity	Output	SENS HIGH1	1	SENS HIGH2	2	SENS HIGH3	3	SENS NORM RANG HOLD	4	SENS NORM RANG AUTO	5	SENS MID	6
Measuring sensitivity	Output																	
SENS HIGH1	1																	
SENS HIGH2	2																	
SENS HIGH3	3																	
SENS NORM RANG HOLD	4																	
SENS NORM RANG AUTO	5																	
SENS MID	6																	
SENS NORM RANGE HOLD	SNHD																	
SENS NORM RANGE AUTO	SNAT																	
SENS MID	SMID																	
SENS HIGH1	SHI1																	
SENS HIGH2	SHI2																	
SENS HIGH3	SHI3																	
<AVERAGE TIMES****>	AVG****	Sets the number of averaging times for measurement. ****: 1 to 1000 (1 step)	AVG?	1 to 1000														
<SAMPLING PT****>	SMPL****	Sets the sampling point for measurement. ****: 11 to 20001 (1 step) 0(auto)	SMPL?	11 to 20001,0														

Table 9-2 GP-IB Program Codes (6/36)

Function	Control command	Explanation	Talker command	Talker output data format								
[SETUP]												
<CW LIGHT MEASURE>	CLMES	Sets the CW light measurement mode.	} CWPLS?	<table border="1"> <thead> <tr> <th>Measurement mode</th> <th>Output</th> </tr> </thead> <tbody> <tr> <td>PULSE light measurement mode</td> <td>0</td> </tr> <tr> <td>CW light measurement mode</td> <td>1</td> </tr> </tbody> </table>	Measurement mode	Output	PULSE light measurement mode	0	CW light measurement mode	1		
Measurement mode	Output											
PULSE light measurement mode	0											
CW light measurement mode	1											
<PLS LIGHT MEASURE>	PLMES	Sets the PULSE light measurement mode.										
<LPF MODE>	LPF	Mode for measuring chop light by using a lowpass filter.	} PLMOD?	<table border="1"> <thead> <tr> <th>Measurement mode</th> <th>Output</th> </tr> </thead> <tbody> <tr> <td>LPF MODE</td> <td>0</td> </tr> <tr> <td>EXT TRG MODE</td> <td>1</td> </tr> <tr> <td>PEAK HOLD MODE</td> <td>2 + hold time</td> </tr> </tbody> </table>	Measurement mode	Output	LPF MODE	0	EXT TRG MODE	1	PEAK HOLD MODE	2 + hold time
Measurement mode	Output											
LPF MODE	0											
EXT TRG MODE	1											
PEAK HOLD MODE	2 + hold time											
<PEAK HOLD MODE>	PKHLD****	Mode for measuring chop light by using the peak hold method. ****[hold time (Unit: ms)]: 1 to 9999 (1 step)										
<EXT TRG MODE>	EXTRG	Mode for measuring chop light by an external trigger signal.										
<X SCALE UNIT>	XUNT*	Switches the display of the X-axis scale to the wavelength or frequency. For the wavelength : *: 0 For the frequency : *: 1	XUNT?	Wavelength : 0 Frequency : 1								
<TLS SYNCRO SWEEP>	TLSSYNC*	Selects ON or OFF for the TLS synchronization sweep function. ON.....*:1 OFF.....*:0	TLSSYNC?	ON:1 OFF:0								
<RESOLN CORRECT>	RESCOR*	Sets the resolution correction function OFF *:0 , ON *:1	RESCOR?	ON:1 OFF:0								
<MEAS WL AIR VAC>	MESWL*	Switches measurement wavelength (between air wavelength and vacuum wavelength) When AIR (air wavelength) is selected :0 When VAC (vacuum wavelength) is selected :1	MESWL?	AIR:0, VAC:1								

Table 9-2 GP-IB Program Codes (7/36)

Function	Control command	Explanation	Talker command	Talker output data format
[MARKER]				
<MARKER>	WMKR****.***	Sets the moving marker to the specified wavelength position. (Unit: nm) ****.***: 0.000 to 2350.000	} MKR?	Output of the wavelength (or frequency) and level at the moving marker position.
	FMKR***.***	Sets the moving marker to the specified frequency position. (Unit: THz) ***.***: 1.0000 to 674.5000		
<MARKER→CENTER>	CTR=M	Sets the wavelength of the moving marker to the center wavelength.	None	
<MARKER->REF LEVEL>	REF=M	Sets the level of the moving marker to the reference level.	None	
<SET MARKER1,2>	MKR1	Sets the moving marker to the fixed marker 1.	MKR1?	Output of the wavelength and level at the fixed marker 1.
	MKR2	Sets the moving marker to the fixed marker 2.	MKR2?	Output of the wavelength and level at the fixed marker 2.
<SET MKR ***>	MKR***	Sets the moving marker to the fixed maker ***. ***: 1 to 200 (1 step)	MKR?***	Output of the wavelength and level at the fixed marker ***.
<CLR MKR ***>	MCLR***	Clears the fixed marker ***. ***: 1 to 200 (1 step)	None	
<ALL MARKER CLEAR>	MKCL	Clears the moving marker, fixed markers and the marker values in the data area.	None	
<LINE MARKER1>	L1MK****.***	Sets the wavelength line marker 1. (Unit: nm) ****.***: 0.000 to 2350.000	L1MK?	As per Table 9-4 Output Data Format.
	L1FMK***.***	Sets the wavelength line marker 1. (Unit: THz) ***.***: 1.0000 to 674.5000		
<LINE MARKER2>	L2MK****.***	Sets the wavelength line marker 2. (Unit: nm) ****.***: 0.000 to 2350.000	L2MK?	As per Table 9-4 Output Data Format.
	L2FMK***.***	Sets the wavelength line marker 2. (Unit: THz) ***.***: 1.0000 to 674.5000		

Table 9-2 GP-IB Program Codes (8/36)

Function	Control command	Explanation	Talker command	Talker output data format
[MARKER]				
<LINE MARKER3>		Sets the level line marker 3.	L3MK?	As per Table 9-4 Output Data Format.
LOG scale	L3DBM****.**	****.**: -150.00 to 40.00 (dBm)		
SUBLOG scale	L3DB****.**	****.**: -139.90 to 139.90 (dB)		
LIN scale	L3LN*.*E±**	*.*E±**: 0 to 1.360E+02		
<LINE MARKER4>		Sets the level line marker 4.	L4MK?	
LOG scale	L4DBM****.**	****.**: -150.00 to 40.00 (dBm)		
SUBLOG scale	L4DB****.**	****.**: -139.90 to 139.90 (dB)		
LIN scale	L4LN*.*E±**	*.*E±**: 0 to 1.360E+02		
<MKRL1-L2→SPAN>	SP=LM	Sets the L1-L2 section to the sweep range.	None	
<SEARCH L1-L2>	SRLMK*	Sets whether or not to execute peak value detection between L1 and L2. ON...*: 1 OFF...*: 0	SRLMK?	ON: 1, OFF: 0
<LINE MKR CLEAR>	LMKCL	Clears the line markers and line marker values.	None	
<MARKER MULTI-MKR DISPLAY>	MLTMKR*	Switches the marker value display to the multi-marker display. OFF *: 0 ON *: 1	MLTMKR?	0: OFF, 1: ON
<MARKER OFFSET SPACING>	MKROS*	Displays the difference for the moving marker or adjacent marker. OFFSET *: 0 SPACING *: 1	MKROS?	0: OFFSET, 1: SPACING
<MARKER LVL DIGIT>	FIG*	Specifies the number of level display decimal digits of the marker. 1 digit *: 0, 2 digits *: 1, 3 digits *: 2	FIG?	0: 1 digit, 1: 2 digits, 2: 3 digits
<MKR LIST PRINT>	MKRPRT	Prints out the multi-marker value.	None	
<MKR AUTO UPDATE>	MKRUP	Makes the waveform track the fixed marker level position. OFF *:0, ON *:1	MKRUP?	0:OFF, 1:ON
<MKR UNIT nm THz>	MKUNT*	Sets the display unit of the wavelength marker value. nm *:0, THz *:1	MKUNT?	0:nm, 1:THz

Table 9-2 GP-IB Program Codes (9/36)

Function	Control command	Explanation	Talker command	Talker output data format						
[PEAK SEARCH]										
<PEAK SEARCH>	PKSR	Detects the MAX value of level.	} PKSR?	<table border="1"> <thead> <tr> <th></th> <th>Output</th> </tr> </thead> <tbody> <tr> <td>BOTTOM</td> <td>0</td> </tr> <tr> <td>PEAK</td> <td>1</td> </tr> </tbody> </table>		Output	BOTTOM	0	PEAK	1
	Output									
BOTTOM	0									
PEAK	1									
<BOTTOM SEARCH>	BTSR	Detects the MIN value of level.								
<NEXT SEARCH>	NSR	Detects the next largest value (or next smallest value)	None							
<NEXT SRCH RIGHT>	NSRR	Detects the largest value (or smallest value) on the right side of the moving marker.	None							
<NEXT SRCH LEFT>	MSRL	Detects the largest value (or smallest value) on the left side of the moving marker.	None							
<AUTO SEARCH>	ATSR*	Selects ON or OFF for the automatic detection of the peak/bottom function. ON *: 1 , OFF *: 0	ATSR?	ON: 1, OFF: 0						
<MODE DIFF**.**dB>	MODIF**.**	Sets the level difference for mode judgment. (Unit: dB) **.**: 0.01 to 50.00 (0.01 step)	MODIF?	0.01 to 50.00						

Table 9-2 GP-IB Program Codes (10/36)

Function	Control command	Explanation	Talker command	Talker output data format
[ANALYSYS]				
<SPEC WD*****>	SW*	Measures the spectrum width. ENVELOPE *: 0, THRESH *: 1, RMS *: 2, PEAK RMS *: 3, NOTCH *: 4	SW?	ENVELOPE: 0, THRESH: 1, RMS: 2, PEAK RMS: 3, NOTCH: 4
(ENVELOPE)	SWENV**.**	Measures the spectrum width in Envelope method. Threshold method **.*: 0.01 to 50.00 (0.01 step)	None	
<ENV TH1**.*dB>	ENVT1**.**	Sets a threshold (in dB) for spectrum width search in Envelope method. **.*: 0.01 to 50.00 (0.01 step)	ENVT1?	0.01 to 50.00
<ENV TH2**.*dB>	ENVT2**.**	Sets a truncation limit for spectrum width search in Envelope method. **.*: 0.01 to 50.00 (0.01 step)	ENVT2?	0.01 to 50.00
<ENV K**.**>	ENVK**.**	Sets a magnification ratio for spectrum width search in Envelope method. **.*: 1.00 to 10.00 (0.01 step)	ENVK?	1.00 to 10.00
(THRESH)	SWTHR**.**	Measures the spectrum width in Threshold method. **.*: Threshold value 0.01 to 50.00 (0.01 step)	None	
<THRESH TH**.*dB>	THRTH**.**	Sets a threshold (in dB) for spectrum width search in Threshold method. **.*: 0.01 to 50.00 (0.01 step)	THRTH?	0.01 to 50.00
<THRESH K**.**>	THRK**.**	Sets a magnification ratio for spectrum width search in Threshold method. **.*: 1.00 to 10.00 (0.01 step)	THRK?	1.00 to 10.00
<MODE FIT>	MODFT*	During spectrum width search in Threshold method (with the 1-time magnification): "1": Sets the marker to the peak of selected mode. "2": Sets the marker to the matching position of threshold level.	MODFT?	"1": Sets the marker to the mode peak. "0": Sets the marker to the matching position of threshold level.



Table 9-2 GP-IB Program Codes (11/36)

Function	Control command	Explanation	Talker command	Talker output data format
[ANALYSYS]				
<SPEC WD*****>				
(RMS)	SWRMS**.*	Measures the spectrum width in RMS method. **.*: truncation limit 0.01 to 50.00 (0.01 step)	None	
<RMS TH**.*dB>	RMSTH**.*	Sets a truncation limit (in dB) for spectrum width search in RMS method. **.*: 0.01 to 50.00 (0.01 step)	RMSTH?	0.01 to 50.00
<RMS K**.*>	RMSK**.*	Sets a magnification ratio for spectrum width search in RMS method. **.*: 1.00 to 10.00 (0.01 step)	RMSK?	1.00 to 10.00
(PEAK RMS)	SWPRM**.*	Measures the spectrum width in Peak RMS method. **.*: truncation limit 0.01 to 50.00 (0.01 step)	None	
<PK RMS**.*dB>	PRMTH**.*	Sets a truncation limit (in dB) for spectrum width search in Peak RMS method. **.*: 0.01 to 50.00 (0.01 step)	PRMTH?	0.01 to 50.00
<PK RMS K**.*>	PRMK**.*	Sets a magnification ratio for spectrum width search in Peak RMS method. **.*: 1.00 to 10.00 (0.01 step)	PRMK?	1.00 to 10.00
(NOTCH)	None	Measures the notch width.	None	
<NOTCH TH**.*dB>	NCHTH**.*	Sets a threshold (in dB) for notch width measurement. **.*: 0.01 to 50.00 (0.01 step)	NCHTH?	0.01 to 50.00
<PEAK/BOTTOM>	NCHMOD*	Sets the notch width measuring direction. PEAK *:0, BOTTOM *:1	NCHMOD?	0:PEAK, 1:BOTTOM

Table 9-2 GP-IB Program Codes (12/36)

Function	Control command	Explanation	Talker command	Talker output data format
[ANALYSYS]				
<ANALYSIS1*****>		Analyzes the parameters required for side mode suppress ratio, power measurement, and LD and LED indication.		
(SMSR)			None	
<SMSR*>	SMSR*	Sets the reference to measure the side mode suppress ratio. *: 1, 2	SMSR?	1, 2
<SMSR MASK ±**.**nm>	SSMSK**.**	Sets the mask range (in nm) close to the peak during SMSR1 measurement. **.**: 0 to 99.99 (0.01 step)	SSMSK?	0 to 99.99
(POWER)	PWR	Measures the marker-to-marker power.	None	
<PWR OFST**.**dB>	POFS**.**	Sets a compensation value (in dB) for marker-to-marker measurement. **.**: -10.00 to 10.00 (0.01 step)	POFS?	-10.00 to 10.00
(FP-LD) (See Table A1.)	FPAN	Analyzes the Fabry-Peror laser diode.	None	
(DFB-LD) (See Table A1.)	DFBAN	Analyzes the DFB laser diode.	None	
(LED) (See Table A1.)	LEDAN	Analyzes the light emitting diode (LED).	None	
(PMD)	PMD	Sets the PMD analysis.	None	
<PMDTH**.**dB>	PMDTH**.**	Sets the threshold of the PMD. (unit: dB) **.**: 0.01 to 50.00 (0.01 step)	PMDTH?	See the talker data format.

Table 9-2 GP-IB Program Codes (13/36)

Function	Control command	Explanation	Talker command	Talker output data format																								
[ANALYSYS]																												
<ANALYSIS2*****>		Executes NF calculation, color analysis, and WDM analysis.																										
(EDFA NF)	EDNF	Calculates the noise figure (NF).	None																									
<OFST(IN)***.***dB>	OFIN***.**	Sets an offset of signal light (in dB). ***.**: -99.99 to 99.99 (0.01 step)	OFIN?	-99.99 to 99.99																								
<OFST(OUT)***.***dB>	OFOUT***.**	Sets an offset of output light (in dB). ***.**: -99.99 to 99.99 (0.01 step)	OFOUT?	-99.99 to 99.99																								
<PLUS MSK**.**nm>	PLMSK**.**	Sets a mask range right to peak waveforms. **.**: 0 to 10.00 ( 0.01 step)	PLMSK?	0 to 10.00																								
<MINUS MSK**.** nm>	MIMSK**.**	Sets a mask range left to peak waveforms. **.**: 0 to 10.00 (0.01 step)	MIMSK?	0 to 10.00																								
<CVFT TYPE*****>	EDFCVF*	Sets the following curve fit types for NF calculation: <table border="1" data-bbox="990 805 1214 1002"> <tr><td></td><td>*</td></tr> <tr><td>GAUSSIAN</td><td>0</td></tr> <tr><td>LORENZIAN</td><td>1</td></tr> <tr><td>3RD POLY</td><td>2</td></tr> <tr><td>4TH POLY</td><td>3</td></tr> <tr><td>5TH POLY</td><td>4</td></tr> </table>		*	GAUSSIAN	0	LORENZIAN	1	3RD POLY	2	4TH POLY	3	5TH POLY	4	EDFCVF?	<table border="1" data-bbox="1691 790 1966 986"> <thead> <tr><th></th><th>Output</th></tr> </thead> <tbody> <tr><td>GAUSSIAN</td><td>0</td></tr> <tr><td>LORENZIAN</td><td>1</td></tr> <tr><td>3RD POLY</td><td>2</td></tr> <tr><td>4TH POLY</td><td>3</td></tr> <tr><td>5TH POLY</td><td>4</td></tr> </tbody> </table>		Output	GAUSSIAN	0	LORENZIAN	1	3RD POLY	2	4TH POLY	3	5TH POLY	4
	*																											
GAUSSIAN	0																											
LORENZIAN	1																											
3RD POLY	2																											
4TH POLY	3																											
5TH POLY	4																											
	Output																											
GAUSSIAN	0																											
LORENZIAN	1																											
3RD POLY	2																											
4TH POLY	3																											
5TH POLY	4																											
<CVFT THR**.**dB>	EDFTH**.**	Sets a threshold for curve fitting (in dB). **.**: 0.1 to 99.9 (0.1 step)	EDFTH?	0.1 to 99.9																								

Table 9-2 GP-IB Program Codes (14/36)

Function	Control command	Explanation	Talker command	Talker output data format																				
[ANALYSYS]																								
<ANALYSIS2*****>																								
(WDM)	WDMAN	Analyzes the WDM.	None																					
<OFFSET SPACING>	WDMOS*	Selects the display items on the WDM list. OFFSET *: 0, SPACING *: 1	WDMOS?	0: OFFSET, 1: SPACING																				
<REF CHNEL HIGHEST>	WDMRH	Sets the reference at the highest channel peak.	None																					
<REF CHNEL NO.***>	WDMRN***	Sets the reference at the "n-th" channel peak specified. ***: 1 to 200 (1 step)	WDMRN?	1 to 200																				
<DISPLAY *****>	WDMDISP*	Sets the display format of the WDM analysis result. <table border="1" style="margin-left: auto; margin-right: auto;"> <tr><td></td><td>*</td></tr> <tr><td>ABSOLUTE</td><td>0</td></tr> <tr><td>RELATIVE</td><td>1</td></tr> <tr><td>ABS&amp;REL</td><td>2</td></tr> <tr><td>DRIFT</td><td>3</td></tr> </table>		*	ABSOLUTE	0	RELATIVE	1	ABS&REL	2	DRIFT	3	WDMDISP?	<table border="1" style="margin-left: auto; margin-right: auto;"> <tr><td></td><td>*</td></tr> <tr><td>ABSOLUTE</td><td>0</td></tr> <tr><td>RELATIVE</td><td>1</td></tr> <tr><td>ABS&amp;REL</td><td>2</td></tr> <tr><td>DRIFT</td><td>3</td></tr> </table>		*	ABSOLUTE	0	RELATIVE	1	ABS&REL	2	DRIFT	3
	*																							
ABSOLUTE	0																							
RELATIVE	1																							
ABS&REL	2																							
DRIFT	3																							
	*																							
ABSOLUTE	0																							
RELATIVE	1																							
ABS&REL	2																							
DRIFT	3																							
<ITU-T TABLE REF TABLE>	WDMREF*	Sets the data to be referred to at the relative value displaying time. ITU-T *:0, REF *:1	WDMREF?	0:ITU-T 1:REF																				
<MAX/MIN RESET>	WDMMR	Resets the MAX/MIN data at the drift measuring time.	None																					
<WDM RESULT → REF DATA> <PRESET→ REF DATA> <ITU-T→REF DATA>	WDMREFDAT*	Sets the reference data. <table border="1" style="margin-left: auto; margin-right: auto;"> <tr><td></td><td>*</td></tr> <tr><td>WDM RESLT</td><td>0</td></tr> <tr><td>PRESET</td><td>1</td></tr> <tr><td>ITU-T</td><td>2</td></tr> </table>		*	WDM RESLT	0	PRESET	1	ITU-T	2	None													
	*																							
WDM RESLT	0																							
PRESET	1																							
ITU-T	2																							
<CH DETECT AUTO> <CH DETECT PRESET>	WDMCHAUT*	Sets the method of channel detection. PRESET *: 0 AUTO *: 1	WDMCHAUT?	0: PRESET 1: AUTO																				
<MAX NUM***>	WDMMAX***	Sets the maximum channel peak. ***: 1 to 200 (1 step)	WDMMAX?	1 to 200																				

Table 9-2 GP-IB Program Codes (15/36)

Function	Control command	Explanation	Talker command	Talker output data format
[ANALYSYS]				
<ANALYSIS2*****>				
(WDM)				
<THRESH**.*dB>	WDMTH**.*	Sets a threshold of channel peak (in dB). **.*: 0.1 to 50.00 (0.01 step)	WDMTH?	0.1 to 50.00
<MODE DIFF**.*dB>	WDMDIF**.*	Sets the minimum difference between top and bottom of waveforms (in dB) for channel peak detection. **.*: 0.00 to 50.00 (0.01 step)	WDMDIF?	0.0 to 50.0
<PRESET WL TABLE>	DUTCH***; ####.##	Sets the wavelength at channel number. *** : CHANNEL 1 to 200 (1 step) ####.## : WAVELENGTH (nm) 600.00 to 1750.00 (0.01 step)	DUTCH?***	600.00 to 1750.00
<PRESET WL TABLE>	DUTCHF***; ###.###	Sets the frequency at channel number. *** : CHANNEL 1 to 200 (1step) ###.### : FREQUENCY (THz) 171.5000 to 499.5000(0.001step)	DUTCHF?***	171.5000 to 499.5000
<SET ON/OFF>	WDMCHSW***;#	Sets the channel to ON or OFF. *** : CHANNEL 1 to 200(1 step) #: 0=OFF, 1=ON	WDMCHSW?***	OFF:0, ON:1
<WAVELEN/FREQ>	WDMUNT*	Selects the wavelength display or the frequency display. WAVELENGTH *:0 FREQUENCY *:1	WDMUNT?	WAVELENGTH:0 FREQUENCY:1
<TABLE PRINT>	WDMTCOPY	Prints out an active table.	WDMTCOPY?	ON(copy):1 OFF(except copy):0
<NOISE POI CTR FIX>	WDMNOI*	Selects noise measuring point. FIX *:0 , CENTER *:1	WDMNOI?	FIX:0 CENTER:1

Table 9-2 GP-IB Program Codes (16/36)

Function	Control command	Explanation	Talker command	Talker output data format
[ANALYSYS]				
<ANALYSIS2*****>				
(WDM)				
<NOISE POI **.**nm>	WDMNOIP**.**	Sets the noise measuring point. **.**:0.00 to 10.00 (0.01 step)	WDMNOIP?	0.00 to 10.00
<NOISE BW>	WDMNOIBW*.**	Sets the noise bandwidth. (Unit:nm) *.**:0.01 to 1.00 (0.01step)	WDMNOIBW?	0.01 to 1.00
<LEVEL PRESET>	DUTLEV**.**	Sets the preset level value. (Unit:dB) **.**:-90.00 to 20.00 (0.01step)	DUTLEV?	-90.00 to 20.00
<SNR PRESET>	DUTSNR**.**	Sets the preset snr value. (Unit:dB) **.**:0.00 to 50.00 (0.01step)	DUTSNR?	0.00 to 50.00
<DISP MASK ***>	WDMDSPMSK***	Sets the threshold value at the channel display masking time. *** : 10.00 to -100.00 (0.01 step) , -999.00(OFF)	WDMDSPMSK?	10.00 to -100.00, -999.00
<DUAL TRACE>	WDMDUAL*	Uses the both A and B traces for the WDM analysis. OFF *:0, ON *:1	WDMDUAL?	
<OUTPUT SLOPE>	WDMSLOPE*	Displays the least square approximate value line of the channel peak. OFF *:0, ON *:1	WDMSLOPE?	OFF:0 ON:1

Table 9-2 GP-IB Program Codes (17/36)

Function	Control command	Explanation	Talker command	Talker output data format
[ANALYSYS]				
<ANALYSIS2*****>				
(WDM-NF)	WNFAN	Execute the multi-channel NF analysis.	None	
<ASE POINT>	WNFNP**.**	Sets the ASE level measuring points. **.** : 0.00 to 10.00 (0.01 step)	WNFNP?	0.00 to 10.00
<OFFSET(IN)>	WNFOFI***.**	Set signal light offset values. ***.** : -99.99 to 99.99 (0.01 step)	WNFOFI?	-99.99 to 99.99
<OFFSET(OUT)>	WNFOFO***.**	Set output light offset values. ***.** : -99.99 to 99.99 (0.01 step)	WNFOFO?	-99.99 to 99.99
(FIL-PK)(See Table A1.)	FILPKAN	Executes the optical filter (PEAK) analysis.	None	
(FIL-BTM)(See Table A1.)	FILBTMAN	Executes the optical filter (BOTTOM) analysis.	None	
<AUTO ANALYSIS>	ATANA*	Automatically executes the selected function after sweep. ON *: 1 OFF *: 0	ATANA?	ON: 1, OFF: 0

Table 9-2 GP-IB Program Codes (18/36)

Table A1. FP-LD, DFB-LD, LED, FIL-PK, and FIL-BTM ANALYSIS Parameter Setup Commands (Parameter Setup Window)

Function	Control command	Explanation	Talker command
<PARAMETER (FP-LD)>	FPLD○; □; △;****	Sets the parameters in the FP-LD ANALYSIS window. ○ - 0: SPEC WIDTH, 1: MEAN WL, 2: TOTAL POWER, 3: MODE NO. □ - 0: ENV, 1: THRESH, 2: RMS, 3: PK RMS, 4: POWER △ - 0: TH1, 1: TH2, 2: K, 3: MODE FIT, 4: MODE DIFF, 5: OFST LEVEL **** : Set value	FPLD○?
<PARAMETER (DFB-LD)>	DFBLD○; □; △;****	Sets the parameters in the DFB-LD ANALYSIS window. ○ - 0: -XdB WIDTH, 1: SMSR □ - 0: ENV, 1: THRESH, 2: RMS, 3: PK RMS, 4: SMSR1, 5: SMSR2 △ - 0: TH, 1: TH2, 2: K, 3: MODE FIT, 4: MODE DIFF, 5: SMSR MASK **** : Set value	DFBLD○?
<PARAMETER (LED)>	LED○; □; △;****	Sets the parameters in the LED ANALYSIS window. ○ - 0: SPEC WIDTH, 1: MEAN WL, 2: TOTAL POWER □ - 0: ENV, 1: THRESH, 2: RMS, 3: PK RMS, 4: POWER △ - 0: TH1, 1: TH2, 2: K, 3: MODE FIT, 4: MODE DIFF, 5: OFST LEVEL **** : Set value	LED○?
<PARAMETER(FIL-PK)>	FILPK○;□;△;****	Sets parameters in the FIL-PK ANALYSIS window. ○ - 0: PEAK LVL, 1:PEAK WL, 2:MEAN WL, 3:SPEC WD, 4:CROSS TALK, 5:RIPPLE WD □ - 0:THRESH, 1:RMS, 2:PEAK LV, 3:ITU-T △ - 0:SW, 1:TH, 2:K, 3:MODE FIT, 4:MODE DIFF, 5:CH SPACE,6:SEARCH AREA **** : Set value	FILPK○?
<PARAMETER(FIL-BTM)>	FILBTM○;□;△;****	Sets parameters in the FIL-BTM ANALYSIS window. ○ - 0: BOTTOM LVL, 1:BOTTOM WL, 2:MEAN WL, 3:NOTCH WD, 4:CROSS TALK □ - 0:PEAK, 1:BOTTOM, 2:BOTTOM LV, 3:ITU-T △ - 0:SW, 1:TH, 2:MODE DIFF, 3:CH SPACE, 4:SEARCH AREA **** : Set value	FILBTM○?



Table 9-2 GP-IB Program Codes (19/36)

Function	Control command	Explanation	Talker command	Talker output data format																
<b>[TRACE]</b>																				
<WRITE A>	WRTA	Sets the trace A write mode.	TRA?	<table border="1"> <thead> <tr> <th></th> <th>Output</th> </tr> </thead> <tbody> <tr> <td>WRITE</td> <td>0</td> </tr> <tr> <td>FIX</td> <td>1</td> </tr> <tr> <td>MAX HLD</td> <td>2</td> </tr> <tr> <td>ROL AVG</td> <td>3 + number of AVG times</td> </tr> </tbody> </table>		Output	WRITE	0	FIX	1	MAX HLD	2	ROL AVG	3 + number of AVG times						
	Output																			
WRITE	0																			
FIX	1																			
MAX HLD	2																			
ROL AVG	3 + number of AVG times																			
<FIX A>	FIXA	Sets the trace A fixed data mode.																		
<MAX HOLD A>	MAXA	Sets the trace A MAX value detection mode.																		
<ROLL AVG A***>	RAVA***	Trace A sequential addition mode. *** (number of AVG times): 2 to 100 (1 step)																		
<DISPLAY A>	DSPA	Selects display or non-display for trace A.	DSPA?	<table border="1"> <thead> <tr> <th></th> <th>Output</th> </tr> </thead> <tbody> <tr> <td>BLANK</td> <td>0</td> </tr> <tr> <td>DISP</td> <td>1</td> </tr> </tbody> </table>		Output	BLANK	0	DISP	1										
	Output																			
BLANK	0																			
DISP	1																			
<BLANK A>	BLKA																			
<ACTIVE TRACE*>	ACTV*	Active trace selection <table border="1"> <thead> <tr> <th></th> <th>*</th> </tr> </thead> <tbody> <tr> <td>Trace A</td> <td>0</td> </tr> <tr> <td>Trace B</td> <td>1</td> </tr> <tr> <td>Trace C</td> <td>2</td> </tr> </tbody> </table>		*	Trace A	0	Trace B	1	Trace C	2	ACTV?	<table border="1"> <thead> <tr> <th></th> <th>Output</th> </tr> </thead> <tbody> <tr> <td>Trace A</td> <td>0</td> </tr> <tr> <td>Trace B</td> <td>1</td> </tr> <tr> <td>Trace C</td> <td>2</td> </tr> </tbody> </table>		Output	Trace A	0	Trace B	1	Trace C	2
	*																			
Trace A	0																			
Trace B	1																			
Trace C	2																			
	Output																			
Trace A	0																			
Trace B	1																			
Trace C	2																			
<WRITE B>	WRTB	Sets the trace B write mode.	TRB?	<table border="1"> <thead> <tr> <th></th> <th>Output</th> </tr> </thead> <tbody> <tr> <td>WRITE</td> <td>0</td> </tr> <tr> <td>FIX</td> <td>1</td> </tr> <tr> <td>MIN HLD</td> <td>2</td> </tr> <tr> <td>ROL AVG</td> <td>3 + number of AVG times</td> </tr> </tbody> </table>		Output	WRITE	0	FIX	1	MIN HLD	2	ROL AVG	3 + number of AVG times						
	Output																			
WRITE	0																			
FIX	1																			
MIN HLD	2																			
ROL AVG	3 + number of AVG times																			
<FIX B>	FIXB	Sets the trace B fixed data mode.																		
<MIN HOLD B>	MINB	Sets the trace B MIN value detection mode.																		
<ROLL AVG B***>	RAVB***	Sets the trace B sequential addition mode. *** (number of AVG times): 2 to 100 (1 step)																		

Table 9-2 GP-IB Program Codes (20/36)

Function	Control command	Explanation	Talker command	Talker output data format																						
[TRACE]																										
<DISPLAY B>	DSPB	Selection display or non-display for trace B.	DSPB?	<table border="1"> <thead> <tr> <th></th> <th>Output</th> </tr> </thead> <tbody> <tr> <td>BLANK</td> <td>0</td> </tr> <tr> <td>DISP</td> <td>1</td> </tr> </tbody> </table>		Output	BLANK	0	DISP	1																
	Output																									
BLANK	0																									
DISP	1																									
<BLANK B>	BLKB																									
<WRITE C>	WRTC	Sets the trace C write mode.	TRC?	<table border="1"> <thead> <tr> <th></th> <th>Output</th> </tr> </thead> <tbody> <tr> <td>WRITE</td> <td>0</td> </tr> <tr> <td>FIX</td> <td>1</td> </tr> <tr> <td>A-B</td> <td>2</td> </tr> <tr> <td>B-A</td> <td>3</td> </tr> <tr> <td>A-B (LIN)</td> <td>4</td> </tr> <tr> <td>B-A (LIN)</td> <td>5</td> </tr> <tr> <td>A+B (LIN)</td> <td>6</td> </tr> <tr> <td>NORMALIZE</td> <td>7</td> </tr> <tr> <td>CURVE FIT</td> <td>10 + limit value</td> </tr> <tr> <td>CURVE FIT PK</td> <td>110 + limit value</td> </tr> </tbody> </table>		Output	WRITE	0	FIX	1	A-B	2	B-A	3	A-B (LIN)	4	B-A (LIN)	5	A+B (LIN)	6	NORMALIZE	7	CURVE FIT	10 + limit value	CURVE FIT PK	110 + limit value
	Output																									
WRITE	0																									
FIX	1																									
A-B	2																									
B-A	3																									
A-B (LIN)	4																									
B-A (LIN)	5																									
A+B (LIN)	6																									
NORMALIZE	7																									
CURVE FIT	10 + limit value																									
CURVE FIT PK	110 + limit value																									
<FIX C>	FIXC	Sets the trace C fixed data mode.																								
<CALCULATE C>																										
<A-B→C>	A-BC	Copies the result obtained by subtracting trace B from trace A to the trace C. (LOG value calculation)																								
<B-A→C>	B-AC	Copies the result obtained by subtracting trace A from trace B to the trace C. (LOG value calculation)																								
<A-B(LIN)→C>	A-BCL	Copies the result obtained by subtracting trace B from trace A and to the trace C. (Linear value calculation)																								
<B-A(LIN)→C>	B-ACL	Copies the result obtained by subtracting trace A from trace B to the trace C. (Linear value calculation)																								
<A+B(LIN)→C>	A+BCL	Copies sum of trace A and trace B to trace C. (Linear value calculation)																								

Table 9-2 GP-IB Program Codes (21/36)

Function	Control command	Explanation	Talker command	Talker output data format						
[TRACE]										
<EFFECT C>										
<NORMALIZE C>	NORMC	Displays the data of trace C in normalized form.	} TRC?	See previous page.						
<CURVE FIT C**dB>	CVFTC**	Displays all the data of trace C after curve fit processing. (Unit: dB) **: 0 to 99 (1 step)								
<CURVE FIT PK C**dB>	CVPKC**	Displays only the data of the mode peak point on trace C after curve fit processing. (Unit: dB) **: 0 to 99 (1 step)								
<DISPLAY C>	DSPC	Selects display or non-display for trace C.	DSPC?	<table border="1"> <thead> <tr> <th></th> <th>Output</th> </tr> </thead> <tbody> <tr> <td>BLANK</td> <td>0</td> </tr> <tr> <td>DISP</td> <td>1</td> </tr> </tbody> </table>		Output	BLANK	0	DISP	1
	Output									
BLANK	0									
DISP	1									
<BLANK C>	BLKC									
<TRACE A→B>	B=A	Copies the trace A to the trace B.	None							
<TRACE A→C>	C=A	Copies the trace A to the trace C.	None							
<TRACE B→A>	A=B	Copies the trace B to the trace A.	None							
<TRACE B→C>	C=B	Copies the trace B to the trace C.	None							
<TRACE C→A>	A=C	Copies the trace C to the trace A.	None							
<TRACE C→B>	B=C	Copies the trace C to the trace B.	None							

Table 9-2 GP-IB Program Codes (22/36)

Function	Control command	Explanation	Talker command	Talker output data format								
[DISPLAY]												
<NORMAL DISPLAY>	NORMD	Sets the screen to the ordinary display mode.	DISP?	<table border="1"> <thead> <tr> <th></th> <th>Output</th> </tr> </thead> <tbody> <tr> <td>&lt;NORMAL&gt;</td> <td>0</td> </tr> <tr> <td>&lt;SPLIT&gt;</td> <td>1</td> </tr> <tr> <td>&lt;3D&gt;</td> <td>2</td> </tr> </tbody> </table>		Output	<NORMAL>	0	<SPLIT>	1	<3D>	2
	Output											
<NORMAL>	0											
<SPLIT>	1											
<3D>	2											
<SPLIT DISPLAY>	SPLIT	Sets the screen to the 2-split display mode.										
<TRACE A UP LOW>	ULTRA*	Sets the upper and lower sides of 2-split display for trace A. UP....*: 1 LOW....*: 0	ULTRA?	<table border="1"> <tbody> <tr> <td>UP: 1, LOW: 0</td> </tr> </tbody> </table>	UP: 1, LOW: 0							
UP: 1, LOW: 0												
<TRACE B UP LOW>	ULTRB*	Sets the upper and lower sides of 2-split display for trace B. UP....*: 1 LOW....*: 0	ULTRB?									
<TRACE C UP LOW>	ULTRC*	Sets the upper and lower sides of 2-split display for trace C. UP....*: 1 LOW....*: 0	ULTRC?									
<UPPER HOLD>	UHLD*	Fixes the scale after changing the upper-side trace of 2-split display to FIX. ON....*: 1 OFF....*: 0	UHLD?	ON: 1, OFF: 0								
<LOWER HOLD>	LHLD*	Fixes the scale after changing the lower-side trace of 2-split display to FIX. ON....*: 1 OFF....*: 0	LHLD?									

Table 9-2 GP-IB Program Codes (23/36)

Function	Control command	Explanation	Talker command	Talker output data format
[DISPLAY]				
<3D DISPLAY>	3D	Sets the screen to the 3-dimensional display mode.	DISP?	
<ANGLE***deg>	ANGL**	Sets the angle of 3-dimensional display. (Unit: deg) ***: -50 to 50 (10 steps)	ANGL?	-50 to 50
<RECALL>	3DRCL	Redisplays the waveform group cleared in the 3-dimensional display mode.	None	
<Z-SCALE**>	ZSCL**	Sets the number of waveforms in the 3-dimensional display mode. **: 3 to 16 (1 step)	ZSCL?	3 to 16
<MEMORY 1st 2nd>	MEM*	Sets the memory for 3-dimensional display. 1st...*: 0 2nd...*: 1	MEM?	1st: 0, 2nd: 1
<LABEL>	LBL'***...***'	Sets the label input mode. ***...***: Character string (50 max.)	LBL?	Character string on display
<ALL CLEAR>	LBLCL	Clears all the chracter strings in the label input area.	None	
<NOISE MSK****dBm>	NMSK****	Displays the waveforms below the set value in masked form. (Unit: dBm) ****: 0 to -100 (1step) OFF: -999	NMSK?	0 to -100 OFF: -999
<MASK LINE VERT HRZN>	MSKL*	Srts the method of MASK. VERT *:0 HRZN *:1	MSKL?	VERT :0 HRZN :1
<GRAPH CLEAR>	CLR	Clears then trace A, B and C.	None	

Table 9-2 GP-IB Program Codes (24/36)

Function	Control command	Explanation	Talker command	Talker output data format
[MEMORY]				
<SAVE>				
<SAVE A→MEM>	SAVEA**	Saves the trace A into memory. ** (memory address): 0 to 31 (1 step)	None	
<SAVE B→MEM>	SAVEB**	Saves the trace B into memory. ** (memory address): 0 to 31 (1 step)	None	
<SAVE C→MEM>	SAVEC**	Saves the trace C into memory. ** (memory address): 0 to 31 (1 step)	None	
<RECALL>				
<RECALL MEM→A>	RCLA**	Recalls the contents of memory to the trace A. ** (memory address): 0 to 31 (1 step)	None	
<RECALL MEM→B>	RCLB**	Recalls the contents of memory to the trace B. ** (memory address): 0 to 31 (1 step)	None	
<RECALL MEM→C>	RCLC**	Recalls the contents of memory to the trace C. ** (memory address): 0 to 31 (1 step)	None	

Table 9-2 GP-IB Program Codes (25/36)

Function	Control command	Explanation	Talker command	Talker output data format
[FLOPPY]				
<WRITE>				
<TRACE RD/WRT>				
<ABC→FD>	WR* ' <u>@@@@@</u> '	Records one of trace A, B and C to FD. *: A(trace A), B(trace B) or C(trace C) @-@: File name When the underlined part is omitted, the default file name is set.	None	
<MEMORY→FD>	WRMEM** ' <u>@@@@@</u> '	Records the contents of memory into FD. **(memory address): 0 to 31 (1 step) @-@: File name When the underlined part is omitted, the default file name is set.	None	
<3D→FD 1st 2nd>	WR3D* ' <u>@@@@@</u> '	Records the waveform group in the 3-dimensional display mode into FD. *: F(1st) or S(2nd) @-@: File name When the underlined part is omitted, the default file name is set.	None	
<BIN TXT>	TRFMT*	Selects a record format. BINARY...*: 0 TEXT...*: 2	TRFMT?	BINARY:0, TXT: 2
<PROGRAM RD/WRT>	WRPRG** ' <u>@@@@@</u> '	Records a program to FD. **: 1 to 20 (1 step) @-@: File name When the underlined part is omitted, the default file name is set.	None	

Table 9-2 GP-IB Program Codes (26/36)

Function	Control command	Explanation	Talker command	Talker output data format
[FLOPPY]				
<WRITE>				
<DATA RD/WRT>	WRDT ' <u>@@@@@@</u> '	Records data into FD. @-@: File name When the underlined part is omitted, the default file name is set.	None	
<DATA & TIME>	D&TDT*	Records the date and time into FD. ON...*: 1 OFF...*: 0	D&TDT?	ON: 1, OFF: 0
<LABEL>	LBLDT*	Records a label into FD. ON...*: 1 OFF...*: 0	LBLDT?	ON: 1, OFF: 0
<DATA AREA>	DTARA*	Records data into FD. ON...*: 1 OFF...*: 0	DTARA?	ON: 1, OFF: 0
<CONDITION>	CNDDT*	Records setting conditions into FD. ON...*: 1 OFF...*: 0	CNDDT?	ON: 1, OFF: 0
<ADD WRITE OVERWRITE>	DTAD*	Adds or overwrites a data file. ADD WRITE...*: 0, OVERWRITE...*: 1	DTAD?	0: ADD WRITE, 1: OVERWRITE
<LONG TERM RD/WRT>	WRTL ' <u>@@@@@@</u> '	Records the long term measurement result in the FD. @-@: File name When the underlined part is omitted, the default file name is set.		
<GRPH RD/WRT>	WRGR ' <u>@@@@@@</u> '	Saves a graphic file on an FD. @-@: File name When the underlined part is omitted, the default file name is set.	None	
<B&W> <PRESET COLOR> <SCREEN COLOR>	GRCOL*	Selects a graphic file color. B&W...*: 0, PRESET COLOR...*: 1, SCREEN COLOR...*: 2	GRCOL?	0: B&W, 1: PRESET COLOR 2: SCREEN COLOR
<BMP TIFF>	GRFMT*	Selects a graphic file format. BMT...*: 0, TIFF...*: 1	GRFMT?	0: BMP, 1: TIFF
<SETTING RD/WRT>	WRSET ' <u>@@@@@@</u> '	Records system information into FD. @-@: File name The default file name is used if under lined parameter is omitted.	None	



Table 9-2 GP-IB Program Codes (27/36)

Function	Control command	Explanation	Talker command	Talker output data format
[FLOPPY]				
<TRACE RD/WRT>				
<FD→ABC>	RD* '@@@@@'	Reads the data of FD into the set trace. *: A(trace A), B(trace B) or C(trace C) @-@: File name	None	
<FD→MEMORY>	RDMEM** '@@@@@'	Reads the data of FD into memory. **(memory address): 0 to 31 (1 step) @-@: File name	None	
<FD→3D 1st 2nd>	RD3D* '@@@@@'	Reads the waveform group in the 3-dimensional display from FD. *: F(1st) or S(2nd) @-@: File name	None	
<PROGRAM RD/WRT>	RDPRG** '@@@@@'	Reads a program from FD. **: 1 to 20 (1 step) @-@: File name	None	
<DATA RD/WRT>	RDDT '@@@@@'	Reads data from FD. @-@: File name	None	
<SETTING RD/WRT>	RDSET '@@@@@'	Reads system information from FD. @-@: File name ***: Extension	None	
<LONG TERM RD/WRT>	RDLT '@@@@@'	Reads long term measurement data from FD. @-@: File name	None	
<DIRECTORY>				
DELETE	DEL '@@@@@' ***'	Deletes the file stored in FD. @-@: File name	None	
<DISK INITIALIZE>	DSKIN*.*	Initializes FD. (Unit: Mbyte) *.*: 1.2 or 1.44	None	

Table 9-2 GP-IB Program Codes (28/36)

Function	Control command	Explanation	Talker command	Talker output data format
[PROGRAM]				
<PROGRAM EXECUTE>	EXEC**	Executes a program. ** (program file No.): 1 to 20	EXEC?	Run status: 1 Stop status: 0
<PROGRAM EXIT>	PREXT	Causes a program to pause.	None	
<DELETE>	PRDEL**	Deletes a program. ** (program file No.): 1 to 20	None	
[SYSTEM]				
<USER KEY DEFINE>				
{KEY DEF DONE}	KYDNE	Terminates the user key registration mode.	None	
<SET CLOCK>	DATE YR. MO. DY  TIME HH:MM	Set the built-in clock. YR(YEAR): 0 to 99, MO(MONTH): 1 to 12, DY(DAY): 1 to 31, HH(HOUR): 0 to 23, MM(MINUTE) : 0 to 59	DATE?  TIME?	Output of the current YR, MO and DY.  Output of the current HH:MM.
<SET COLOR>				
<DEFAULT COLOR*>	DEFCL*	Set the display color. * : 1 to 5 patterns	DEFCL?	1 to 5
<WL CAL>				
<BUILT-IN SOURCE>	WCALS	Calibrates a wavelength by the internal light source.	None	
<EXTERNAL SOURCE>	WCAL****.***	Waveform absolute value calibration by the external light source. (Unit: nm) ****.***: 600.000 to 1750.000 (0.001 step)	WCAL?	600.000 to 1750.000
<WL SHIFT>	WLSFT**.*	Sets the amount of waveform shift. (Unit: dB) **.*: -5.000 to 5.000 (0.001 step)	WLSFT?	-5.000 to 5.000
<LEVEL SHIFT>	LVSFT***.**	Sets the amount of level shift. (Unit: dB) ***.**: -60.00 to 60.00 (0.01 step)	LVSFT?	-60.00 to 60.00
<WL OFST TABLE>	WCALT****; #.###	Sets the wavelength calibration table. **** : Wavelengths 600 to 1750 (nm) #. ###: Offset value (nm) -0.200 to 0.200 (0.001 step)	WCALT?****	-0.200 to 0.200

Table 9-2 GP-IB Program Codes (29/36)

Function	Control command	Explanation	Talker command	Talker output data format
[SYSTEM]				
<LEV OFST TABLE>	LCALT****;#.###	Sets the level calibration table. **** : Wavelengths 600 to 1750 (nm) #. ###: Offset value (nm) -1.000 to 1.000 (0.001 step)	LCALT?****	-1.000 to 1.000
<OPTICAL ALIGNMENT>	OPALIGN	Adjusting optical axis of monochromator optical system employed on this unit.	None	
<AUTO OFFSET>	ATOFS*	Selects ON or OFF for the AMP auto offset function. ON ... *: 1 OFF ... *: 0	ATOFS?	ON:1, OFF:0
<BUZZER>				
<CLICK>	BZCLK*	Selects use or non-use of a click. ON ... *:1 OFF ... *:0	BZCLK?	ON:1, OFF:0
<WARNING>	BZWRN*	Selects use or non-use of an alarm. ON ... *:1 OFF ... *:0	BZWRN?	ON:1, OFF:0
<TLS ADRS>	TLSADR**	Sets the address of the wavelength variable light source. **: 0 to 30 (1 step)	TLSADR?	0 to 30
<GP-IB2 ADR>	GP2ADR**	Sets the GP-IB2 address . ** : 0 to 30 (1 step)	GP2ADR?	0 to 30
<UNCAL WARNING>	UCWRN*	Selects ON or OFF for UNCAL mark and warning display ON ... *:1 OFF ... *:0	UCWRN?	ON:1, OFF:0
<ACTUAL RES DISP>	ARESDSP*	Changes over the resolution ability value displays. OFF *:0, ON *:1	ARESDSP?	ON:1, OFF:0
<LOG LIMIT ***dB>	LOGLMT***	Sets the LOG data upper/lower limit value. *** : 100 or 210	LOGLMT?	100 or 210

Table 9-2 GP-IB Program Codes (30/36)

Function	Control command	Explanation	Talker command	Talker output data format
[ADVANCE]				
<LONG TERM SWEEP>				
<LONG TERM STA STP>	LTSWP	Starts the long term measurement function.	None	
<LONG TERM INTVL ****.*min >	LTINTVL****.*	Sets the measurement interval. (Unit: min) ****.*: 0.1 to 9999.9 (0.1 step)	LTINTVL?	0.1 to 9999.9
<LONG TERM RPT TIMES>	LTTIME****	Sets the repeated measurement interval. ****: 1 to 1000 (1 step)	LTTIME?	1 to 1000
<MULTI CH DISP.WEVELEN>	LTWL	Sets the wavelength display.	None	
<MULTI CH DISP.LEVEL>	LTL	Sets the level display.	None	
<MULTI CH DISP.SNR>	LTSNR	Sets the SNR display.	None	
<SINGLE CH DISPLAY>	LTCH***	Sets a channel during single channel display. 1 to 200 (1 step)	LTCH?	1 to 200
<ABSOLUTE>	LTABS	Display an absolute value.	None	
<RELATIVE>	LIREL	Displays a relative value.	None	
<REF DATA SET>	LIREFSET	Specifies the data of the cursor position for the reference data.	None	
<REF DATA INITIAL>	LIREFINI	Sets the preset value as the reference data.	None	
<WL LIMIT **.*nm>	LIRELLIM**.*	Sets the threshold of the wavelength drift. (Unit: nm) **.*: 0.00 to 99.99 (0.01 step)	LIRELLIM?	0.00 to 99.99
<LOW LIMIT ***.*dBm>	LIRELLOW***.*	Sets the lower limit of the level. (Unit: dBm) ***.*: -90.00 to -30.00 (0.01 step)	LIRELLOW?	-90.00 to -30.00
<UP LIMIT ***.*dBm>	LIRELHI***.*	Sets the upper limit of the level. (Unit: dBm) ***.*: -30.00 to 20.00 (0.01 step)	LIRELHI?	-30.00 to 20.00
<SNR LIMIT **.*dBm >	LIRESNRLIM**.*	Sets the lower limit of the SNR. (Unit: dB) **.*: 0.00 to 50.00 (0.01 step)	LIRESNRLIM?	0.00 to 50.00

Table 9-2 GP-IB Program Codes (31/36)

Function	Control command	Explanation	Talker command	Talker output data format
[ADVANCE]				
<LONG TERM SWEEP>				
<Y SCALE AUTO>	LTATSCL*	Sets the scale of the graph vertical axis. Manual scale *:0 Auto scale *:1	LTATSCL?	Manual scale : 0 Auto scale : 1
<WL CTR ****.*nm>	LTWLCTR****.*	Sets the Y-axis center wavelength on the wavelength display graph. ****.* : 600.00 to 1750.00 (0.01 step)	LTWLCTR?	600.00 to 1750.00
<WL SPAN ****.*nm>	LTWLSPAN****.*	Sets the Y-axis span on the wavelength display graph. ****.* : 0.0 to 1200.0 (0.1 step)	LTWLSPAN?	0.0 to 1200.0
<LVL CTR ***.*dBm>	LTLVLCTR***.*	Sets the Y-axis center level on the level display graph. ***.* : -90.00 to 20.00 (0.01 step)	LTLVLCTR?	-90.00 to 20.00
<LVL SCALE **.*dB/D>	LTLVLSCL**.*	Sets the Y-axis scale on the level display graph. **.* : 0.1 to 10.0 (0.1 step)	LTLVLSCL?	0.1 to 10.0
<SNR CTR ***.*dB>	LTSNRCTR***.*	Sets the Y-axis center level on the SNR display graph. ***.* : -90.00 to 20.00 (0.01 step)	LTSNRCTR?	-90.00 to 20.00
<SNR SCALE **.*dB/D>	LTSNRSCL**.*	Sets the Y-axis scale on the SNR display graph. **.* : 0.1 to 10.0 (0.1 step)	LTSNRSCL?	0.1 to 10.0
<AUTO SET>	LTATSET	Sets the same value as that at the automatic setting time on the graph scale.	None	
CURSOR MOVE (CHANNEL)	LTCHCUR***	Sets cursor of a channel in the long term measurement. 1 to 200 (1 step)	LTCHCUR?	1 to 200
CURSOR MOVE (NUMBER OF MEASUREMENT TIMES)	LTTMCUR****	Sets cursor of the number of long term measurement times. 1 to 1000 (1 step)	LTTMCUR?	1 to 1000

Table 9-2 GP-IB Program Codes (32/36)

Function	Control command	Explanation	Talker command	Talker output data format																
[ADVANCE]																				
<POWER METER>																				
<REPEAT>	PMPRT	Sets repeat measurement.	} PMST?	<table border="1"> <thead> <tr> <th></th> <th>Output</th> </tr> </thead> <tbody> <tr> <td>STOP</td> <td>0</td> </tr> <tr> <td>SINGLE</td> <td>1</td> </tr> <tr> <td>REPEAT</td> <td>2</td> </tr> </tbody> </table>		Output	STOP	0	SINGLE	1	REPEAT	2								
	Output																			
STOP	0																			
SINGLE	1																			
REPEAT	2																			
<SINGLE>	PMSGL	Sets single measurement.																		
<STOP>	PMSTP	Stops the power meter function.																		
<AREA*****>	AREA*	Sets the measuring range. <table border="1"> <thead> <tr> <th></th> <th>*</th> </tr> </thead> <tbody> <tr> <td>FULL</td> <td>0</td> </tr> <tr> <td>600 to 1000 nm</td> <td>2</td> </tr> <tr> <td>1000 to 1750 nm</td> <td>3</td> </tr> </tbody> </table>		*	FULL	0	600 to 1000 nm	2	1000 to 1750 nm	3	AREA?	<table border="1"> <thead> <tr> <th></th> <th>Output</th> </tr> </thead> <tbody> <tr> <td>FULL</td> <td>0</td> </tr> <tr> <td>600 to 1000 nm</td> <td>2</td> </tr> <tr> <td>1000 to 1750 nm</td> <td>3</td> </tr> </tbody> </table>		Output	FULL	0	600 to 1000 nm	2	1000 to 1750 nm	3
	*																			
FULL	0																			
600 to 1000 nm	2																			
1000 to 1750 nm	3																			
	Output																			
FULL	0																			
600 to 1000 nm	2																			
1000 to 1750 nm	3																			
<RELATIVE>	REL*	Selects absolute value or relative value for display value. The relative value is 0 dB at ON. ON (relative value)...*: 1 OFF (absolute value)...*: 0	REL?	ON (relative value): 1 OFF (absolute value): 0																
<MAX MIN RESET>	PMRST	Sets the maximum value and minimum value.	None																	
<dBm W>	PMUNT*	Sets the display unit. dBm (LOG value)...*: 0 W (linear value)...*: 1	PMUNT?	dBm: 0, W: 1																

Table 9-2 GP-IB Program Codes (33/36)

② Others

Function	Control command	Explanation	Talker command	Talker output data format												
[COPY]	COPY*	Outputs to the printer/plotter. ON ... * : 1      OFF ... * : 0	COPY?	ON (copy) : 1, OFF (except copy) : 0												
[FEED]	PRFED**	Printer paper feed ** : 1 to 10 (Amount of feed, Unit : × 5 mm)	None													
[HELP]	HELP*	ON or OFF for the explanatory statement display. Display ... * : 1    Clear ... * : 0	HELP?	Display : 1 Non-display : 0												
[COARSE]	CRS*	[COARSE] key of the rotary knob. ON ... * : 1      OFF ... * : 0	CRS?	ON : 1, OFF : 0												
Delimiter specification (Talker data)	SD*	Specifies the string delimiter. <table border="1" style="margin-left: auto; margin-right: auto;"> <tr><td></td><td>*</td></tr> <tr><td>,</td><td>0</td></tr> <tr><td>CRLF</td><td>1</td></tr> </table>		*	,	0	CRLF	1	SD?	<table border="1" style="margin-left: auto; margin-right: auto;"> <tr><td></td><td>Output</td></tr> <tr><td>,</td><td>0</td></tr> <tr><td>CRLF</td><td>1</td></tr> </table>		Output	,	0	CRLF	1
		*														
,	0															
CRLF	1															
	Output															
,	0															
CRLF	1															
	BD*	Specifies the block delimiter. <table border="1" style="margin-left: auto; margin-right: auto;"> <tr><td></td><td>*</td></tr> <tr><td>CRLF+EOI</td><td>0</td></tr> <tr><td>LF+EOI</td><td>1</td></tr> </table>		*	CRLF+EOI	0	LF+EOI	1	BD?	<table border="1" style="margin-left: auto; margin-right: auto;"> <tr><td></td><td>Output</td></tr> <tr><td>CRLF+EOI</td><td>0</td></tr> <tr><td>LF+EOI</td><td>1</td></tr> </table>		Output	CRLF+EOI	0	LF+EOI	1
	*															
CRLF+EOI	0															
LF+EOI	1															
	Output															
CRLF+EOI	0															
LF+EOI	1															
SRQ ON/OFF	SRQ*	Permission or inhibition of service request. ON (permission ... * : 1 OFF (inhibition) ... * : 0 Default = "OFF"	SRQ?	ON : 1, OFF : 0												
SRQ mask function	SRMSK***	Sets "1" in the bit to be masked. *** : 0 to 255	SRMSK?	0 to 255												

Table 9-2 GP-IB Program Codes (34/36)

Function	Control command	Explanation	Talker command	Talker output data format
Nonvolatile data initialization	INIT	Initializes data except program/memory.	None	
Hardware initialize	*RST	Initializes the hardware.	None	
identification	None	Outputs the equipment information.	*IDN?	See the output data format.
Talker data header information ON/OFF	HD*	Appends a header to the talker data for the output request command. ON ... * :1      OFF ... * : 0 Default = "OFF"	HD?	ON : 1, OFF : 0
Waveform data output request command	LDATA <u>R****_R****</u>	Trace A level data **** : 1 to 20001 R1-R20001 when the underlined part is omitted.		As per Table 9-4 Output data format.
	LDATB <u>R****_R****</u>	Trace B level data **** : 1 to 20001 R1-R20001 when the underlined part is omitted.		
	LDATC <u>R****_R****</u>	Trace C level data **** : 1 to 20001 R1-R20001 when the underlined part is omitted.		
	LMEM\$\$ <u>R****_R****</u>	Memory \$\$ level data \$\$: 0 to 31 **** : 1 to 20001 R1-R20001 when the underlined part is omitted.		
	WDATA <u>R****_R****</u>	Trace A wavelength data **** : 1 to 20001 R1-R20001 when the underlined part is omitted.		



Table 9-2 GP-IB Program Codes (35/36)

Function	Control command	Explanation	Talker command	Talker output data format	
Waveform data output request command	WDATB <u>R****_R****</u>	Trace B wavelength data **** : 1 to 20001 R1-R20001 when the underlined part is omitted.	/	As per Table 9-4 Output data format.	
	WDATC <u>R****_R****</u>	Trace C wavelength data **** : 1 to 20001 R1-R20001 when the underlined part is omitted.			
	WMEM\$\$ <u>R****_R****</u>	Memory \$\$ wavelength data \$\$ : 0 to 31      **** : 1 to 20001 R1-R20001 when the underlined part is omitted.			
	DTNUM A				11 to 20001
	DTNUM B				11 to 20001
	DTNUM C				11 to 20001
	DTNUM **				11 to 20001
	Log data digit count setup command	LDTDIG*			Sets the number of decimal digits during level data (log) output via GPIB port. "2" for two decimal digits immediately after power-on "3" for three decimal digits
Marker value output request command	MKR?	Requests the moving ▽ marker value.	/		
	MKR1?	Requests the fixed ▽ marker 1 value.			
	MKR2?	Request the fixed ▽ marker 2 value.			
	MKR?***	Request the fixed ▽ marker *** value. ***: 1 to 200 (1 step)			
	L1MK?	Requests the line marker 1 value (wavelength).			
	L2MK?	Requests the line marker 2 value (wavelength).			
	L3MK?	Requests the line marker 3 value (level).			
	L4MK?	Requests the line marker 4 value (level).			
Analysis result output request command	ANA?	Requests the analysis result.			

Table 9-2 GP-IB Program Codes (36/36)

Function	Control command	Explanation	Talker command	Talker output data format
FD directory information output request command	DIR?	Outputs the <DIRECTORY> execution result.	/	As per Table 9-4 Output data format.
FD-accessed file name output request command	FNAME?	Requests the file name previously read or written.		
Warning error No. output request command	WARN?	Requests the warning error number that lastly occurred.		
Resolution ability value output request command	ARES?	Requests outputting the resolution ability value in the present center wavelength setting.		
Alarm state output request command in the long-term measurement.	LTALM?	Request for alarm numbers in the long-term measurement.		
Alarm position data output request in long-term measurement.	LTALMDT?	Request for alarm position data in the long-term measurement.		

## 9.2.6 Output data

When this equipment is specified as a talker by the controller, the equipment outputs data. It is necessary to specify the contents of output data beforehand by program code.

Table 9-4 shows a list of output data request codes and output data formats.

When the power supply is turned on, the string delimiter for output data (delimiter between data) is set to ",", while the block delimiter (end character of data) is set to CRLF + EOI.

These settings are changeable. Table 9-3 shows delimiter specifying codes.

When the delimiter has been changed, "," and CRLF of the output data formats shown in Table 9-4 are changed into the changed delimiter.

Table 9-3 Delimiter Specifying Codes

Program code	Contents
SD0	Sets the string delimiter to ",".
SD1	Sets the string delimiter to CRLF.
BD0	Sets the block delimiter to CRLF + EOI.
BD1	Sets the block delimiter to LF + EOI.





Table 9-4 Output Data Formats (3/17)

Data output item	Output request command	Talker output data format	
Moving $\Delta$ marker value Fixed marker 1 value Fixed marker 2 value	MKR? MKR1? MKR2? MKR? <u>***</u> ***:1 to 200	<div style="border: 1px solid black; padding: 2px; margin-bottom: 10px; text-align: center;">Wavelength display for LOG scale</div> WMKR $\Delta$ $\Delta$ <u>****.***</u> (SD) <u>±***.***</u> (BD) WMKR1 $\Delta$ $\Delta$ <u>****.***</u> (SD) <u>±***.***</u> (BD) WMKR2 $\Delta$ $\Delta$ <u>****.***</u> (SD) <u>±***.***</u> (BD)  Wave-      Level length      (dBm or dB) (nm)	<div style="border: 1px solid black; padding: 2px; margin-bottom: 10px; text-align: center;">Wavelength display for LIN scale</div> WMKR $\Delta$ $\Delta$ <u>****.***</u> (SD)*. <u>***E±**</u> (BD) WMKR1 $\Delta$ $\Delta$ <u>****.***</u> (SD)*. <u>***E±**</u> (BD) WMKR2 $\Delta$ $\Delta$ <u>****.***</u> (SD)*. <u>***E±**</u> (BD)  Wave-      Level length      (dBm or dB) (nm)
Line marker 1 value (wavelength) Line marker 2 value (wavelength)	L1MK? L2MK?	<div style="border: 1px solid black; padding: 2px; margin-bottom: 10px; text-align: center;">When displayed in wevelength</div> LMKR1 $\Delta$ $\Delta$ <u>****.***</u> (BD) LMKR2 $\Delta$ $\Delta$ <u>****.***</u> (BD)  Wavelength (nm)	<div style="border: 1px solid black; padding: 2px; margin-bottom: 10px; text-align: center;">When displayed in wevelength</div> LFMK1 $\Delta$ $\Delta$ <u>***.***</u> (BD) LFMK2 $\Delta$ $\Delta$ <u>***.***</u> (BD)  Frequency (THz)
Line marker 3 value (level) Line marker 4 value (level)	L3MK? L4MK?	<div style="border: 1px solid black; padding: 2px; margin-bottom: 10px; text-align: center;">For LOG scale</div> LMKR3 $\Delta$ <u>±***.***</u> (BD) LMKR4 $\Delta$ <u>±***.***</u> (BD)  Level (dBm or dB)	<div style="border: 1px solid black; padding: 2px; margin-bottom: 10px; text-align: center;">For LIN scale</div> LFMK3 $\Delta$ $\Delta$ <u>*.***E±**</u> (BD) LFMK4 $\Delta$ $\Delta$ <u>*.***E±**</u> (BD)  Level (W or no unit)

9 - 44

Note: The talker output data format of this table has an underlined option (\*\*\*.\*\*\*).  
 If three decimal digits (LDTDIG 3) are specified for this option, the data of up to three decimal digits is output.

Table 9-4 Output Data Formats (4/17)

Data output item	Output request command	Talker output data format																		
Analysis result	ANA?	<p>(SPECTRAL WIDTH)</p> <p>When marker is expressed in wevelength :</p> <p>(Header)    <math>\Delta</math>****.***(SD)****.***(SD)***(BD)</p> <table border="0" style="margin-left: 40px;"> <tr> <td>Mean</td> <td>Spectral</td> <td>Number of</td> </tr> <tr> <td>wavelength</td> <td>width</td> <td>modes</td> </tr> <tr> <td>(nm)</td> <td>(nm)</td> <td></td> </tr> </table> <p>When marker is expressed in frequency :</p> <p>(Header)    <math>\Delta</math>***.****(SD)***.****(SD)***(BD)</p> <table border="0" style="margin-left: 40px;"> <tr> <td>Mean</td> <td>Spectral</td> <td>Number of</td> </tr> <tr> <td>wavelength</td> <td>width</td> <td>modes</td> </tr> <tr> <td>(THz)</td> <td>(THz)</td> <td></td> </tr> </table> <p>(Header)...    ENV        →    "SEEN"</p> <p>                  THRESH    →    "SWTH"</p> <p>                  RMS        →    "SWRM"</p> <p>                  PK RMS    →    "SWPR"</p>	Mean	Spectral	Number of	wavelength	width	modes	(nm)	(nm)		Mean	Spectral	Number of	wavelength	width	modes	(THz)	(THz)	
Mean	Spectral	Number of																		
wavelength	width	modes																		
(nm)	(nm)																			
Mean	Spectral	Number of																		
wavelength	width	modes																		
(THz)	(THz)																			

Table 9-4 Output Data Formats (5/17)

Data output item	Output request command	Talker output data format																		
Analysis result	ANA?	<p>(SMSR)</p> <p>When marker is expressed in wevelength :</p> <p>SMSR△<u>****.***(SD)</u>±<u>***.**(SD)</u><u>****.***(SD)</u>±<u>***.**(SD)</u></p> <table border="0"> <tr> <td>Peak wavelength (nm)</td> <td>Peak level (dBm)</td> <td>2nd peak wavelength (nm)</td> <td>2nd peak level (dBm)</td> </tr> </table> <p style="text-align: right;">****.***(SD)±<u>***.**(BD)</u></p> <table border="0"> <tr> <td>Wavelength difference (nm)</td> <td>Level difference (SMSR) (dB)</td> </tr> </table> <p>When marker is expressed in frequency :</p> <p>SMSR△<u>***.****(SD)</u>±<u>***.***(SD)</u><u>***.****(SD)</u>±<u>***.***(SD)</u></p> <table border="0"> <tr> <td>Peak wavelength (THz)</td> <td>Peak level (dBm)</td> <td>2nd peak wavelength (THz)</td> <td>2nd peak level (dBm)</td> </tr> </table> <p style="text-align: right;">***.****(SD)±<u>***.***(BD)</u></p> <table border="0"> <tr> <td>Wavelength difference (THz)</td> <td>Level difference (SMSR) (dB)</td> </tr> </table> <hr/> <table border="0"> <tr> <td>(POWER LOG scale)</td> <td>(POWER LIN scale)</td> </tr> <tr> <td>PDBM△±<u>***.***(BD)</u></td> <td>PLNW△*.***E±<u>***(BD)</u></td> </tr> <tr> <td>Power (dBm)</td> <td>Power (W)</td> </tr> </table>	Peak wavelength (nm)	Peak level (dBm)	2nd peak wavelength (nm)	2nd peak level (dBm)	Wavelength difference (nm)	Level difference (SMSR) (dB)	Peak wavelength (THz)	Peak level (dBm)	2nd peak wavelength (THz)	2nd peak level (dBm)	Wavelength difference (THz)	Level difference (SMSR) (dB)	(POWER LOG scale)	(POWER LIN scale)	PDBM△± <u>***.***(BD)</u>	PLNW△*.***E± <u>***(BD)</u>	Power (dBm)	Power (W)
Peak wavelength (nm)	Peak level (dBm)	2nd peak wavelength (nm)	2nd peak level (dBm)																	
Wavelength difference (nm)	Level difference (SMSR) (dB)																			
Peak wavelength (THz)	Peak level (dBm)	2nd peak wavelength (THz)	2nd peak level (dBm)																	
Wavelength difference (THz)	Level difference (SMSR) (dB)																			
(POWER LOG scale)	(POWER LIN scale)																			
PDBM△± <u>***.***(BD)</u>	PLNW△*.***E± <u>***(BD)</u>																			
Power (dBm)	Power (W)																			

Note: The talker output data format of this table has an underlined option (\*\*\*.\*\*\*).  
 If three decimal digits (LDTDIG 3) are specified for this option, the data of up to three decimal digits is output.



Table 9-4 Output Data Formats (6/17)

Data output item	Output request command	Talker output data format
Analysis result	ANA?	(EDFA NF) EDNF△ <u>***.**</u> (SD)***.** (SD)±***.**(SD) <u>***.**</u> (BD)  Gain            Measuring    ASE power    NF (dB)            resolution    (dBm)        (dB) (nm)            Dominant wavelength (nm)

9 - 47

Note: The talker output data format of this table has an underlined option (\*\*\*.\*\*).  
 If three decimal digits (LDTDIG 3) are specified for this option, the data of up to three decimal digits is output.



Table 9-4 Output Data Formats (8/17)

Data output item	Output request command	Talker output data format																																																																																																												
	ANA?	<p>When &lt;DISPLAY ABS&amp;REL&gt; soft key is selected:                      When marker is set to display the wavelength :                      WDM***<u>(SD)</u>****.***<u>(SD)</u>****.***<u>(SD)</u>****.***<u>(SD)</u>****.***<u>(SD)</u>****.***<u>(SD)</u>****.***<u>(SD)</u>****.***<u>(SD)</u>****....(BD)</p> <table border="0"> <tr> <td>Mode</td> <td>Absolute</td> <td>Relative</td> <td>Absolute</td> <td>Relative</td> <td>Absolute</td> <td>Relative</td> <td>Iteration of</td> </tr> <tr> <td>count</td> <td>wavelength</td> <td>wavelength</td> <td>level</td> <td>level</td> <td>SNR</td> <td>SNR</td> <td>Items 2 to 7</td> </tr> <tr> <td></td> <td>(nm)</td> <td>(nm)</td> <td>(dBm)</td> <td>(dB)</td> <td>(dB)</td> <td>(dB)</td> <td></td> </tr> </table> <p>When marker is set to display the frequency :                      WDM***<u>(SD)</u>****.***<u>(SD)</u>****.***<u>(SD)</u>****.***<u>(SD)</u>****.***<u>(SD)</u>****.***<u>(SD)</u>****.***<u>(SD)</u>****.***<u>(SD)</u>****....(BD)</p> <table border="0"> <tr> <td>Mode</td> <td>Absolute</td> <td>Relative</td> <td>Absolute</td> <td>Relative</td> <td>Absolute</td> <td>Relative</td> <td>Iteration of</td> </tr> <tr> <td>count</td> <td>frequency</td> <td>frequency</td> <td>level</td> <td>level</td> <td>SNR</td> <td>SNR</td> <td>Items 2 to 7</td> </tr> <tr> <td></td> <td>(THz)</td> <td>(THz)</td> <td>(dBm)</td> <td>(dB)</td> <td>(dB)</td> <td>(dB)</td> <td></td> </tr> </table> <p>When &lt;DISPLAY DRIFT&gt; soft key is selected:                      When marker is set to display the wavelength :                      WDM***<u>(SD)</u>****.***<u>(SD)</u>****.***<u>(SD)</u>****.***<u>(SD)</u>****.***<u>(SD)</u>****.***<u>(SD)</u>****.***<u>(SD)</u>****.***<u>(SD)</u>****....(BD)</p> <table border="0"> <tr> <td>Mode</td> <td>Relative</td> <td>Maximum</td> <td>Minimum</td> <td>MAX-MIN</td> </tr> <tr> <td>count</td> <td>wavelength</td> <td>wavelength</td> <td>wavelength</td> <td>wavelength</td> </tr> <tr> <td></td> <td>(nm)</td> <td>(nm)</td> <td>(nm)</td> <td>(nm)</td> </tr> </table> <p>***<u>(SD)</u>****.***<u>(SD)</u>****.***<u>(SD)</u>****.***<u>(SD)</u>****.***<u>(SD)</u>****.***<u>(SD)</u>****.***<u>(SD)</u>****.***<u>(SD)</u>****....(BD)</p> <table border="0"> <tr> <td>Relative</td> <td>Maximum</td> <td>Minimum</td> <td>MAX-MIN</td> <td>Iteration of</td> </tr> <tr> <td>level</td> <td>level</td> <td>level</td> <td>level</td> <td>Items 2 to 9</td> </tr> <tr> <td>(dB)</td> <td>(dB)</td> <td>(dB)</td> <td>(dB)</td> <td></td> </tr> </table> <p>When marker is set to display the frequency :                      WDM***<u>(SD)</u>****.***<u>(SD)</u>****.***<u>(SD)</u>****.***<u>(SD)</u>****.***<u>(SD)</u>****.***<u>(SD)</u>****.***<u>(SD)</u>****.***<u>(SD)</u>****....(BD)</p> <table border="0"> <tr> <td>Mode</td> <td>Relative</td> <td>Maximum</td> <td>Minimum</td> <td>MAX-MIN</td> </tr> <tr> <td>count</td> <td>frequency</td> <td>frequency</td> <td>frequency</td> <td>frequency</td> </tr> <tr> <td></td> <td>(THz)</td> <td>(THz)</td> <td>(THz)</td> <td>(THz)</td> </tr> </table> <p>***<u>(SD)</u>****.***<u>(SD)</u>****.***<u>(SD)</u>****.***<u>(SD)</u>****.***<u>(SD)</u>****.***<u>(SD)</u>****.***<u>(SD)</u>****.***<u>(SD)</u>****....(BD)</p> <table border="0"> <tr> <td>Relative</td> <td>Maximum</td> <td>Minimum</td> <td>MAX-MIN</td> <td>Iteration of</td> </tr> <tr> <td>level</td> <td>level</td> <td>level</td> <td>level</td> <td>Items 2 to 9</td> </tr> <tr> <td>(dB)</td> <td>(dB)</td> <td>(dB)</td> <td>(dB)</td> <td></td> </tr> </table>	Mode	Absolute	Relative	Absolute	Relative	Absolute	Relative	Iteration of	count	wavelength	wavelength	level	level	SNR	SNR	Items 2 to 7		(nm)	(nm)	(dBm)	(dB)	(dB)	(dB)		Mode	Absolute	Relative	Absolute	Relative	Absolute	Relative	Iteration of	count	frequency	frequency	level	level	SNR	SNR	Items 2 to 7		(THz)	(THz)	(dBm)	(dB)	(dB)	(dB)		Mode	Relative	Maximum	Minimum	MAX-MIN	count	wavelength	wavelength	wavelength	wavelength		(nm)	(nm)	(nm)	(nm)	Relative	Maximum	Minimum	MAX-MIN	Iteration of	level	level	level	level	Items 2 to 9	(dB)	(dB)	(dB)	(dB)		Mode	Relative	Maximum	Minimum	MAX-MIN	count	frequency	frequency	frequency	frequency		(THz)	(THz)	(THz)	(THz)	Relative	Maximum	Minimum	MAX-MIN	Iteration of	level	level	level	level	Items 2 to 9	(dB)	(dB)	(dB)	(dB)	
Mode	Absolute	Relative	Absolute	Relative	Absolute	Relative	Iteration of																																																																																																							
count	wavelength	wavelength	level	level	SNR	SNR	Items 2 to 7																																																																																																							
	(nm)	(nm)	(dBm)	(dB)	(dB)	(dB)																																																																																																								
Mode	Absolute	Relative	Absolute	Relative	Absolute	Relative	Iteration of																																																																																																							
count	frequency	frequency	level	level	SNR	SNR	Items 2 to 7																																																																																																							
	(THz)	(THz)	(dBm)	(dB)	(dB)	(dB)																																																																																																								
Mode	Relative	Maximum	Minimum	MAX-MIN																																																																																																										
count	wavelength	wavelength	wavelength	wavelength																																																																																																										
	(nm)	(nm)	(nm)	(nm)																																																																																																										
Relative	Maximum	Minimum	MAX-MIN	Iteration of																																																																																																										
level	level	level	level	Items 2 to 9																																																																																																										
(dB)	(dB)	(dB)	(dB)																																																																																																											
Mode	Relative	Maximum	Minimum	MAX-MIN																																																																																																										
count	frequency	frequency	frequency	frequency																																																																																																										
	(THz)	(THz)	(THz)	(THz)																																																																																																										
Relative	Maximum	Minimum	MAX-MIN	Iteration of																																																																																																										
level	level	level	level	Items 2 to 9																																																																																																										
(dB)	(dB)	(dB)	(dB)																																																																																																											

Table 9-4 Output Data Formats (9/17)

Data output item	Output request command	Talker output data format
	ANA?	<p>(FIL-PK)</p> <p>When marker is set to display the wavelength :</p> <p>FILPK△****.***<u>(SD)</u>±***.***<u>(SD)</u>****.***<u>(SD)</u>****.***<u>(SD)</u></p> <p>Peak Peak Center Spectral wavelength level wavelength width (nm) (dBm) (nm) (nm)</p> <p>±***.***<u>(SD)</u>±***.***<u>(SD)</u> ±***.***<u>(BD)</u></p> <p>Cross talk(left) Cross Ripple (dB) talk(right) width (dB) (dB)</p> <p>When marker is set to display the frequency :</p> <p>FILPK△****.***<u>(SD)</u>±***.***<u>(SD)</u>****.***<u>(SD)</u>****.***<u>(SD)</u></p> <p>Peak Peak Center Spectral frequency level frequency width (THz) (dBm) (THz) (THz)</p> <p>±***.***<u>(SD)</u>±***.***<u>(SD)</u> ±***.***<u>(BD)</u></p> <p>Cross talk(left) Cross Ripple (dB) talk(right) width (dB) (dB)</p>

9 - 50

Note: The talker output data format of this table has an underlined option (\*\*\*.\*\*\*).  
 If three decimal digits (LDTDIG 3) are specified for this option, the data of up to three decimal digits is output.

Table 9-4 Output Data Formats (10/17)

Data output item	Output request command	Talker output data format
	ANA?	<p>(FIL-BTM)</p> <p>When marker is set to display the wavelength :</p> <p>FILBM△ <u>****.***</u>(SD) ± <u>***.***</u>(SD) <u>****.***</u>(SD) <u>****.***</u>(SD)</p> <p>Bottom Bottom Center Notch</p> <p>wavelength level wavelength width</p> <p>(nm) (dBm) (nm) (nm)</p> <p>± <u>***.***</u>(SD) ± <u>***.***</u>(BD)</p> <p>Cross talk(left) Cross</p> <p>(dB) talk(right)</p> <p>(dB)</p> <p>When marker is set to display the frequency :</p> <p>FILBM△ <u>****.***</u>(SD) ± <u>***.***</u>(SD) <u>****.***</u>(SD) <u>****.***</u>(SD)</p> <p>Bottom Bottom Center Notch</p> <p>frequency level frequency width</p> <p>(THz) (dBm) (THz) (THz)</p> <p>± <u>***.***</u>(SD) ± <u>***.***</u>(BD)</p> <p>Cross talk(left) Cross</p> <p>(dB) talk(right)</p> <p>(dB)</p>

9 - 51

Note: The talker output data format of this table has an underlined option (\*\*\*\*.\*\*\*).  
 If three decimal digits (LDTDIG 3) are specified for this option, the data of up to three decimal digits is output.

Table 9-4 Output Data Formats (11/17)

Data output item	Output request command	Talker output data format
		<p>(WDM-NF)</p> <p>WDMNF△ <u>***</u>(SD)<u>****</u>.<u>***</u>(SD)±<u>***</u>.<u>**</u>(SD)±<u>***</u>.<u>**</u>(SD)±<u>***</u>.<u>**</u>(SD)±<u>***</u>.<u>**</u>(SD)</p> <p>Mode Channel Input level Output ASE power  count wavelength (dBm) level (dBm)  (nm)</p> <p><u>****</u>.<u>***</u>(SD)±<u>***</u>.<u>**</u>(SD)±<u>***</u>.<u>**</u>(SD)..... (BD)</p> <p>Measured Gain NF Iteration of  resolution (dB) (dB) Items 2 to 9  (nm)</p> <hr/> <p>(NOTCH)</p> <p>When marker is set to display the wavelength :</p> <p>SWNC<u>****</u>.<u>***</u>(SD)<u>****</u>.<u>***</u>(BD)</p> <p>Center Notch  wavelength width  (nm) (nm)</p> <p>When marker is set to display the frequency :</p> <p>SWNC<u>****</u>.<u>***</u>(SD)<u>****</u>.<u>***</u>(BD)</p> <p>Center Notch  frequency width  (THz) (THz)</p>

9 - 52

Note: The talker output data format of this table has an underlined option (\*\*\*.\*\*).  
If three decimal digits (LDTDIG 3) are specified for this option, the data of up to three decimal digits is output.

Table 9-4 Output Data Formats (12/17)

Data output item	Output request command	Talker output data format												
Analysis result	ANA?	<p>(FP-LD ANALYSIS)</p> <p>When marker is expressed in wevelength :</p> <p>FPLD△<u>****.***(SD)****.***(SD)±<u>****.***(SD)****.***(SD) ±<u>****.***(SD)****(BD)</u></u></u></p> <table border="0"> <tr> <td>Spectral width (nm)</td> <td>Peak wavelength (nm)</td> <td>Peak level (dBm)</td> <td>Mean wavelength (nm)</td> <td>Total power (dBm)</td> <td>Number of modes</td> </tr> </table> <p>When marker is expressed in frequency</p> <p>FPLD△<u>***.****(SD)***.****(SD)±<u>***.***(SD)***.****(SD) ±<u>***.***(SD)****(BD)</u></u></u></p> <table border="0"> <tr> <td>Spectral width (THz)</td> <td>Peak wavelength (THz)</td> <td>Peak level (dBm)</td> <td>Mean wavelength (THz)</td> <td>Total power (dBm)</td> <td>Number of modes</td> </tr> </table>	Spectral width (nm)	Peak wavelength (nm)	Peak level (dBm)	Mean wavelength (nm)	Total power (dBm)	Number of modes	Spectral width (THz)	Peak wavelength (THz)	Peak level (dBm)	Mean wavelength (THz)	Total power (dBm)	Number of modes
		Spectral width (nm)	Peak wavelength (nm)	Peak level (dBm)	Mean wavelength (nm)	Total power (dBm)	Number of modes							
Spectral width (THz)	Peak wavelength (THz)	Peak level (dBm)	Mean wavelength (THz)	Total power (dBm)	Number of modes									
<p>(DFB-LD ANALYSIS)</p> <p>When marker is expressed in wevelength :</p> <p>DFB△△<u>****.***(SD)****.***(SD)±<u>****.***(SD)****.***(SD) ±<u>****.***(BD)</u></u></u></p> <table border="0"> <tr> <td>Spectral width (nm)</td> <td>Peak wavelength (nm)</td> <td>Peak level (dBm)</td> <td>Mode offset (nm)</td> <td>SMSR (dB)</td> </tr> </table> <p>When marker is expressed in frequency :</p> <p>DFB△△<u>***.****(SD)***.****(SD)±<u>***.***(SD)***.****(SD) ±<u>***.***(BD)</u></u></u></p> <table border="0"> <tr> <td>Spectral width (THz)</td> <td>Peak wavelength (THz)</td> <td>Peak level (dBm)</td> <td>Mode offset (THz)</td> <td>SMSR (dB)</td> </tr> </table>	Spectral width (nm)	Peak wavelength (nm)	Peak level (dBm)	Mode offset (nm)	SMSR (dB)	Spectral width (THz)	Peak wavelength (THz)	Peak level (dBm)	Mode offset (THz)	SMSR (dB)				
Spectral width (nm)	Peak wavelength (nm)	Peak level (dBm)	Mode offset (nm)	SMSR (dB)										
Spectral width (THz)	Peak wavelength (THz)	Peak level (dBm)	Mode offset (THz)	SMSR (dB)										

Note: The talker output data format of this table has an underlined option (\*\*\*\*.\*\*\*).  
 If three decimal digits (LDTDIG 3) are specified for this option, the data of up to three decimal digits is output.

Table 9-4 Output Data Formats (13/17)

Data output item	Output request command	Talker output data format										
Analysis result	ANA?	<p>(LED ANALYSIS)</p> <p>When marker is expressed in wevelength :</p> <p>LED△△<u>****.***</u>(SD)<u>****.***</u>(SD)<u>±****.***</u>(SD)<u>****.***</u>(SD) <u>±****.***</u> (BD)</p> <table border="0"> <tr> <td>Spectral width (nm)</td> <td>Peak wavelength (nm)</td> <td>Peak level (dBm)</td> <td>Mean wavelength (nm)</td> <td>Total power (dBm)</td> </tr> </table> <p>When marker is expressed in frequency :</p> <p>LED△△<u>***.****</u>(SD)<u>* ** .****</u>(SD)<u>±****.***</u>(SD)<u>* * .****</u>(SD) <u>±****.***</u> (BD)</p> <table border="0"> <tr> <td>Spectral width (THz)</td> <td>Peak wavelength (THz)</td> <td>Peak level (dBm)</td> <td>Mean wavelength (THz)</td> <td>Total power (dBm)</td> </tr> </table>	Spectral width (nm)	Peak wavelength (nm)	Peak level (dBm)	Mean wavelength (nm)	Total power (dBm)	Spectral width (THz)	Peak wavelength (THz)	Peak level (dBm)	Mean wavelength (THz)	Total power (dBm)
		Spectral width (nm)	Peak wavelength (nm)	Peak level (dBm)	Mean wavelength (nm)	Total power (dBm)						
Spectral width (THz)	Peak wavelength (THz)	Peak level (dBm)	Mean wavelength (THz)	Total power (dBm)								
<p>(PMD ANALYSIS)</p> <p>PMD△<u>***.****</u>(SD)<u>****.****</u>(SD)<u>****.***</u>(BD)</p> <table border="0"> <tr> <td>Left-hand mode peak (THz)</td> <td>Right-hand mode peak (THz)</td> <td>PMD(PS)</td> </tr> </table>	Left-hand mode peak (THz)	Right-hand mode peak (THz)	PMD(PS)									
Left-hand mode peak (THz)	Right-hand mode peak (THz)	PMD(PS)										
Measurement condition of LONG TERM measurement result	LTST?	<p>LTST△<u>***</u>(SD)<u>****</u>(SD)<u>****</u>(BD)</p> <table border="0"> <tr> <td>Number of channels</td> <td>Number of repetitions</td> <td>Repeated time interval</td> </tr> </table>	Number of channels	Number of repetitions	Repeated time interval							
Number of channels	Number of repetitions	Repeated time interval										
LONG TERM measurement result	<p>LTDAT?****</p> <p>****: Data number (1 to 1000)</p>	<p>LTDAT△<u>***</u>(SD)<u>****.***</u>(SD)<u>±****.***</u>(SD)<u>***.***</u>(SD)----(BD)</p> <table border="0"> <tr> <td>Number of channels</td> <td>Peak wavelength (nm)</td> <td>Peak level (dBm)</td> <td>SNR (dBm)</td> <td>Repeat items 2 to 4.</td> </tr> </table>	Number of channels	Peak wavelength (nm)	Peak level (dBm)	SNR (dBm)	Repeat items 2 to 4.					
Number of channels	Peak wavelength (nm)	Peak level (dBm)	SNR (dBm)	Repeat items 2 to 4.								
Alarm state in LONG TERM measurement	LTALM?	<p>* : The number of Alarm states. (The sum of two values written below)</p> <p>0: Non alarm, 1:Wavelength drift is over the threshold, 2:Level is over the upper limit, 4: Level is under the lower limit, 8:SNR is under the lower limit</p>										

Note: The talker output data format of this table has an underlined option (\*\*\*\*.\*\*\*).  
 If three decimal digits (LDTDIG 3) are specified for this option, the data of up to three decimal digits is output.



Table 9-4 Output Data Formats (14/17)

Data output item	Output request command	Talker output data format
Alarm position data in LONG TERM measurement	LTALMDT?	LTALMDT** <u>(SD)</u> *** <u>(SD)</u> ** <u>(SD)</u> -----(BD) Number of alarm channels CH. Alarm number Repeat items 2 to 3.
Analysis parameters	FPLD*?	(FP-LD) FPLD##*(SD)* <u>(SD)</u> **** <u>(SD)</u> **** <u>(SD)</u> **** <u>(SD)</u> * <u>(SD)</u> **** <u>(SD)</u> ****(BD) 1st option: Parameter to be set 0:SPEC WIDTH 1:MEAN WL 2:TOTAL POWER 3:MODE NO. 2nd option: Algorithm 0:ENV 1:THRESH 2:RMS 3:PEAK RMS 4:POWER 3rd option: TH (dB) 4th option: TH2 (dB) 5th option: K 6th option: MODE FIT, 0=OFF, 1=ON 7th option: MODE DIFF (dB) 8th option: OFFSET LEVEL (dB)
Analysis parameters	DFBLD*?	(DFB-LD) DFBLD#*(SD)* <u>(SD)</u> **** <u>(SD)</u> **** <u>(SD)</u> **** <u>(SD)</u> * <u>(SD)</u> **** <u>(SD)</u> ****(BD) 1st option: Parameter to be set 0:-XdB WIDTH 1:SMSR 2nd option: Algorithm 0:ENV 1:THRESH 2:RMS 3:PEAK RMS 4:SMSR1 5: SMSR2 3rd option: TH (dB) 4th option: TH2 (dB) 5th option: K 6th option: MODE FIT, 0=OFF, 1=ON 7th option: MODE DIFF (dB) 8th option: SMSR MASK (nm)

9 - 55

Note: The talker output data format of this table has an underlined option (\*\*\*, \*\*).

If three decimal digits (LDTDIG 3) are specified for this option, the data of up to three decimal digits is output.

Table 9-4 Output Data Formats (15/17)

Data output item	Output request command	Talker output data format
Analysis parameters	LED*?	<p>(LED)</p> <p>LED###*(SD)*(SD)****(SD)****(SD)****(SD)*(SD)****(SD)****(BD)</p> <p>1st option: Parameter to be set 0:SPEC WIDTH 1:MEAN WL 2:TOTAL POWER</p> <p>2nd option: Algorithm 0:ENV 1:THRESH 2:RMS 3:PEAK RMS 4:POWER</p> <p>3rd option: TH (dB)</p> <p>4th option: TH2 (dB)</p> <p>5th option: K</p> <p>6th option: MODE FIT, 0=OFF, 1=ON</p> <p>7th option: MODE DIFF (dB)</p> <p>8th option: SMSR MASK (nm)</p>
Analysis parameters	FILPK*?	<p>(FIL-PK)</p> <p>FILPK△*(SD)*(SD)*(SD)****(SD)****(SD)*(SD)****(SD)****(SD)****(BD)</p> <p>1st option: Parameter to be set 0:PEAK LVL 1:PEAK WL 2:MEAN WL 3:SPEC WD 4:CROSS TALK 5:RIPPLE WIDTH</p> <p>2nd option: Algorithm 0:THRESH 1:RMS 2:PEAK LVL 3:ITU-T</p> <p>3rd option: SW, 0=OFF, 1=ON</p> <p>4th option: TH (dB)</p> <p>5th option: K</p> <p>6th option: MODE FIT, 0=OFF, 1=ON</p> <p>7th option: MODE DIFF (dB)</p> <p>8th option: CH SPACE(nm)</p> <p>9th option: SEARCH AREA(nm)</p>

9 - 56

Note: The talker output data format of this table has an underlined option (\*\*\*, \*\*).

If three decimal digits (LDTDIG 3) are specified for this option, the data of up to three decimal digits is output.

Table 9-4 Output Data Formats (16/17)

Data output item	Output request command	Talker output data format	
Analysis parameters	FILBM*?	(FIL-BTM) FILBM△*(SD)*(SD)*(SD)****(SD)****(SD)*(SD)****(SD)****(SD)****(BD) 1st option: Parameter to be set 0:BOTTOM LVL 1:BOTTOM WL 2:MEAN WL 3:NOTCH WIDTH 4:CROSS TALK 2nd option: Algorithm 0:PEAK 1:BOTTOM 2:BOTTOM LVL 3:ITU-T 3rd option: SW, 0=OFF, 1=ON 4th option: TH (dB) 5th option: MODE DIFF (dB) 6th option: CH SPACE(nm) 7th option: SEARCH AREA(nm)	
Power meter function measurement data	PMTR? MAXP? MINP?	Absolute value LOG scale PMDBM△± <u>***.**</u> (BD) Power (dBm)	Absolute value LIN scale PMLNW△*.***E±**(BD) Power (W)
		Relative value LOG scale PMDB△△± <u>***.**</u> (BD) Power (dBm)	Relative value LIN scale PMLN△△*.***E±**(BD) Power (Unit not specified)
		<ul style="list-style-type: none"> <li>• In OVER, numeral section is replaced by "OVR".</li> <li>• In UNDER, numeral section is replaced by "UND".</li> </ul>	

9 - 57

Note: The talker output data format of this table has an underlined option (\*\*\*.\*\*).

If three decimal digits (LDTDIG 3) are specified for this option, the data of up to three decimal digits is output.



## 9.2.7 Service request function

When measurement is completed, print or plot processing is completed or printer paper is used up, this function sends out an SRQ signal. After that, when serial polling is performed from the controller, the function sends out a status byte. Table 9-5 shows the contents of the status byte.

SRQ transmission can be enabled or disabled by a program code.

When the power supply is turned on, the SRQ send disable status is set. Table 9-6 shows the program codes related to SRQ transmission.

The contents of the status byte are cleared when serial polling is performed or a DCL or SDC message is received in the SQR send enable status.

Table 9-5 Program Codes Related to SRQ Transmission

Program code	Contents
SRQ1	The transmission of SRQ signal is enabled.
SRQ0	The transmission of SRQ signal is disabled.

### 1. SRQ function of GP-IB 1 port

When the device message "SRQ1" is received and the SRQ send mode is set, the status byte shown below plus the RQS bit are set for each cause, thereby making a service request.

#### ① Function and setting condition of each bit

bit 7	bit 6	bit 5	bit 4	bit 3	bit 2	bit 1	bit 0
0	RQS	BUFOVR	0	CMDERR	WARN	DONE	DT RDY

Table 9-6 Contents of Status Byte

Bit	Function and setting condition	Clear timing
bit 7	0	
bit 6	Sends an SRQ signal.	<ul style="list-style-type: none"> <li>• Upon execution of serial pulling</li> <li>• Upon receipt of DCL or SDC</li> </ul>
bit 5	When receiving data exceeding the receive buffer capacity of 512 bytes, "1" is set.	<ul style="list-style-type: none"> <li>• Upon execution of serial polling</li> <li>• Upon receipt of DCL or SDC</li> <li>• At a start of measurement</li> </ul>
bit 4	0	
bit 3	When a command data error occurs, "1" is set.	<ul style="list-style-type: none"> <li>• Upon execution of serial polling</li> <li>• Upon receipt of DCL or SDC</li> <li>• At a start of measurement</li> </ul>
bit 2	When a warning error (including program execute error) occurs, "1" is set. For the contents of the warning, its number can be output by the talker command "WARN?".	<ul style="list-style-type: none"> <li>• When the warning error display disappears</li> <li>• Upon execution of serial polling</li> <li>• Upon receipt of DCL or SDC</li> <li>• At a start of measurement</li> </ul>
bit 1	When the execution of the FD copy program terminates or when a setup operation for optical output is completed, "1" is set.	<ul style="list-style-type: none"> <li>• Upon execution of serial polling</li> <li>• Upon receipt of DCL or SDC</li> <li>• At a start of measurement</li> </ul>
bit 0	When a sweep is completed, "1" is set.	<ul style="list-style-type: none"> <li>• Upon execution of serial polling</li> <li>• Upon receipt of DCL or SDC</li> <li>• At a start of measurement</li> </ul>

② Mask function for each bit

If the bit to be masked is set to "1" by the GP-IB command "SRMSK\*\*\* (0 to 255)", each bit cannot be set even upon occurrence of each cause.

For example, when bit 0 and bit 2 are masked by the "SRMSK5" command and the corresponding cause occurs, this bit is not set. When the cause is related to only the contents of the masked bit, the RQS bit (bit 6) is not set, too.

When mask data includes bit 6, the RQS bit is not set even in the SRQ send enable status.

2. SRQ function of GP-IB 2 port

The SRQ send function of the GP-IB 2 port is not available.

However, serial polling can be executed by the program function.

3. Device clear function

Upon receipt of DCL or SDC, initialization is executed in the same way as POWER ON resetting.

4. Device trigger function

Upon receipt of GET, single sweep processing is performed.

## 9.2.8 Precautions on programming

- (1) The program codes corresponding to the functions that are disabled in the manual operation mode are ignored. In this case, a WARNING message is displayed on the screen in the same way as in the manual operation mode.
- (2) When the seep, print and plot program codes and other program codes are sent continuously, the latter program codes will be executed at once before completion of sweep, print and plot processing. In particular, in the print or plot status, most commands are invalid. To know whether the sweep, print or plot processing is completed or not, use the service request function.
- (3) Before using the service request function, permit SRQ transmission at the beginning of a program and perform serial polling, and then read the status byte unreally. The contents of the status byte are held until serial polling is started. In this period, the SRQ signal is not cleared. Accordingly, when an SRQ signal is generated before program execution, first read the status byte unreally. Otherwise, an SRQ signal becomes hard to generate after that.
- (4) String delimiter specification, block delimiter specification, data output request setting and SRQ end enable status setting are reset to the initial status when the power supply is turned off.

## 9.2.9 Programming examples

The following gives the typical GP-IB programming examples where the NEC's PC-9801 and IBM PS/2 PC's (having the National Instruments' GP-IB interface board) are used.

These programs set the measuring conditions on the AQ6317B, sweeps for a single time, and displays the measured data (both the waveforms and the measuring conditions) on the controller CRT screen.

(1) If the NEC's PC-9801 series PC is used as the controller

```
1000 ' AQ6317B OPTICAL SPECTRUM ANALYZER
1010 '      GP-IB EXAMPLE PROGRAM
1020 '      FOR PC-9801 SERIES
1030 '
1040 DIM A(1001)
1050 SCREEN 3: CLS 3: CONSOLE 0,25,0,1
1060 ISET IFC
1070 ISET REN
1080 CMD DELIM=0
1090 ADRS=1
1100 '
1110 PRINT@ ADRS;"CTRWL1550.00,SPAN20.0,REFL-15.0, LSCL5.0, RESLNO.1, AVGL, SNHD,
SMPL1001"
1120 PRINT@ ADRS;"WRTA,DSPA,FIXB,BLKB,FXIC,BLKC"
1130 '
1140 PRINT@ ADRS;"SRQ1" : POLL ADRS,S
1150 PRINT@ ADRS;"SGL"
1160 POLL ADRS,S
1170 IF S<>65 THEN 1160
1180 '
1190 PRINT@ ADRS;"SD1,LDATA"
1200 INPUT@ ADRS;DUMMY$
1210 FOR I=1 TO 1001
1220   INPUT@ ADRS;DT$
1230   A(I)=VAL(DT$)
1240 NEXT I
1250 '
1260 PRINT@ ADRS;"CTRWL?"
1270 INPUT@ ADRS;CTR$
1280 CTR=VAL(CTR$)
1290 PRINT@ ADRS;"SPAN?"
1300 INPUT@ ADRS;SPAN$
1310 SPAN=VAL(SPAN$)
1320 PRINT@ ADRS;"REFL?"
1330 INPUT@ ADRS;REF$
1340 REF=VAL(REF$)
1350 PRINT@ ADRS;"LSCL?"
1360 INPUT@ ADRS;LSCL$
1370 LSCL=VAL(LSCL$)
1380 PRINT@ ADRS;"RESLN?"
1390 INPUT@ ADRS;RES$
1400 RES=VAL(RES$)
1410 PRINT@ ADRS;"AVG?"
```



```

1420 INPUT@ ADRS;AVG$
1430 AVG=VAL(AVG$)
1440 PRINT@ ADRS;"SMPL?"
1450 INPUT@ ADRS;SMPL$
1460 SMPL=VAL(SMPL$)
1470 PRINT@ ADRS;"SENS?"
1480 INPUT@ ADRS;SENS$
1490 IF SENS$="1" THEN SENS$="HIGH 1"
1500 IF SENS$="2" THEN SENS$="HIGH 2"
1510 IF SENS$="3" THEN SENS$="HIGH 3"
1520 IF SENS$="4" THEN SENS$="NORM HLD"
1530 IF SENS$="5" THEN SENS$="NORM AUT"
1540
1550
1560
1570
1580 START=CTR-SPAN/2
1590 STP=CTR+SPAN/2
1600 REF1=REF+LSCL*2 : YMAX=REF1
1610 REF2=REF-LSCL*2
1620 REF3=REF-LSCL*4
1630 REF4=REF-LSCL*6 : YMIN=REF4
1640 '
1650 VIEW(48,16)-(560,336)
1660 WINDOW(1, -YMAX)-(1001, -YMIN)
1670 LINE(1, -YMAX)-(1001, -YMIN),5,B
1680 LINE(1001,-(REF+LSCL))-(1,-(REF+LSCL)),5,,&H9999
1690 LINE(1001,-REF)-(1,-REF),5,,&HF99F
1770 FOR I=1 TO 5
1710   LINE(1001,-(REF-LSCL*I))-(1,-(REF-LSCL*I)),5,,&H9999
1720 NEXT I
1730 FOR I=1 TO 9
1740   LINE(1+I*100,-YMAX)-(1+I*100,-YMIN),5,,&H9999
1750 NEXT I
1760 '
1770 LINE(1,-A(1))-(1,-A(1)),6
1780 FOR I=1 TO 1001
1790   LINE -(I,-A(I)),6
1800 NEXT I
1810 '
1820 COLOR 7
1830 LOCATE 3,0
1840 PRINT USING "##.##dB/D";LSCL
1850 LOCATE 21,0
1860 PRINT USING "RES:##.##nm  SENS:$    & AVG:####  SMPL:####"; RES, SENS$,
AVG,SMPL
1870 LOCATE 1,1
1880 PRINT USING "###.##";REF1
1890 LOCATE 1,6
1900 PRINT USING "###.##";REF
1910 LOCATE 3,7
1920 PRINT "dBm"
1930 LOCATE 1,11

```

```
1940 PRINT USING "###.#";REF2
1950 LOCATE 1,16
1960 PRINT USING "###.#";REF3
1970 LOCATE 1,20
1980 PRINT USING "###.#";REF4
1990 LOCATE 1,21
2000 PRINT USING "####.##nm    SPACE(7 digits)    ####.##nm    ###.##nm/D
###.##nm ";START,CTR,SPAN/10,STP
2010 END
```

## Explanation of each program line

Line 1040	Declares an array of the measuring waveforms data.
Line 1050	Initializes the screen.
Line 1060	Initializes the GP-IB interface by issuing IFC.
Line 1070	Sets the REN to True.
Line 1080	Sets the CRLF block delimiter for program code output.
Line 1090	Assigns the AQ6317B address to variable ADRS. (This example sets value 1.)
Line 1110	Sends a program code to the AQ6317B and sets the measuring conditions. This example sets the following: Center wavelength : 1550.00 nm, Sweep width : 20.0 nm, Reference level : - -15.0 dBm Level scale : 5.0 dB/div., Resolution : 0.1 nm, Averaging count : 1 time Measuring sensitivity : Normal Range Hold, Sampling point: 1001
Line 1120	Sends a program code to the AQ6317B and sets the following tracing conditions. Trace A : Write mode with display Trace B : Fixed mode with no display Trace C : Fixed mode with no display
Line 1140	Reads the status byte before measurement.
Line 1150	Sends a program code to the AQ6317B and sweeps for a single time.
Lines 1160 and 1170	Read the status byte and wait for a sweep end.
Line 1190	Sets the CRLF string delimiter for data output, and requests for an output of trace-A waveforms data.
Lines 1200 to 1240	Read the waveforms data and assigns them in array A (I).
Lines 1260 to 1570	Read the measuring conditions and assign them in each variable.
Lines 1580 and 1590	Determines the wavelength at the beginning and end of measurement.
Lines 1600 to 1630	Determine the level (except for the reference level) displayed on the level axis.
Line 1650	Specifies the graphics display range on the controller screen.
Line 1660	Determines the coordinates of the specified range.
Line 1670	Draws a ruled line around the graphics.
Lines 1680 to 1720	Draw a level scale of the graphics. The reference level is drawn by dotted and dashed lines, but the others are drawn by dotted lines.
Lines 1730 to 1750	Draw a wavelength scale of the graphics.
Lines 1770 to 1800	Draw the measured waveforms.
Lines 1820 to 2000	Display the measuring conditions around the graphics.

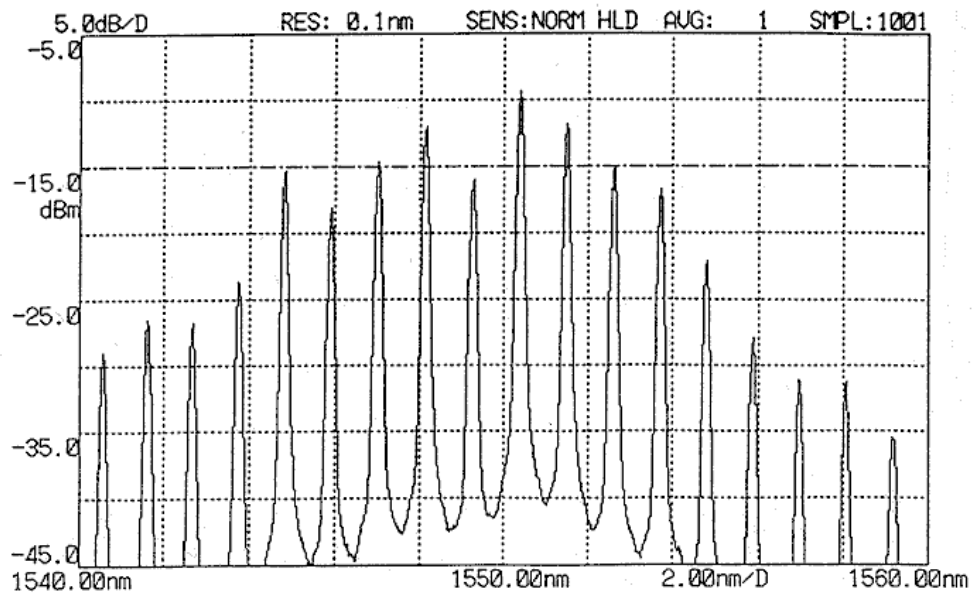

Program execution results (displayed on the controller screen)

(2) If the IBM PC/2 series PC is used as the controller

```
1000 '          AQ6317B Optical Spectrum Analyzer
1010 '          GP-IB Example Program
1020 '          For IBM PS/2 Series (BASICA)
1030 '          (Merge this program with "DECL.BAS")
1040 DIM A(1001)
1050 SCREEN 9: CLS
1060 '
1070 DEV$="DEV1" : CALL IBFIND(DEV$,ND%)
1080 '
1090 CMD$="CTRWL1550.00,SPAN20.0,REFL-15.0,LSCL5.0,RESLNO.1,AVG1,SNHD,
        SMPL1001,SRQ1"+CHR$(13)+CHR$(10)
1100 CALL IBWRT(ND%,CMD$)
1110 CMD$="WRTA,DSPA,FIXB,BLKB,FXIC,BLKC"+CHR$(13)+CHR$(10)
1120 CALL IBWRT(ND%,CMD$)
1130 '
1140 CALL IBRSP(ND%,SP%)
1150 CMD$="SGL"+CHR$(13)+CHR$(10) : CALL IBWRT(ND%,CMD$)
1160 MASK%=&H800 : CALL IBWAIT(ND%,MASK%)
1170 '
1180 V%=ASC(",")+&H400 : CALL IBEOS (ND%,V%)
1190 CMD$="LDATA"+CHR$(13)+CHR$(10) : CALL IBWRT(ND%,CMD$)
1200 DUMMY$=SPACE$(7) : CALL IBRD(ND%,DUMMY$)
1210 FOR I=1 TO 1001
1220   DT$=SPACE$(9) : CALL IBRD(ND%,DT$)
1230   A(I)=VAL(DT$)
1240 NEXT I
1250 '
1260 V%=0 : CALL IBEOS(ND%,V%)
1270 CMD$="CTRWL?" +CHR$(13)+CHR$(10) : CALL IBWRT(ND%,CMD$)
1280 ST$=SPACE$(9) : CALL IBRD(ND%,ST$)
1290 CTR=VAL(ST$)
1300 CMD$="SPAN?" +CHR$(13)+CHR$(10) : CALL IBWRT(ND%,CMD$)
1310 ST$=SPACE$(8) : CALL IBRD(ND%,ST$)
1320 SPAN=VAL(ST$)
1330 CMD$="REFL?" +CHR$(13)+CHR$(10) : CALL IBWRT(ND%,CMD$)
1340 ST$=SPACE$(7) : CALL IBRD(ND%,ST$)
1350 REF=VAL(ST$)
1360 CMD$="LSCL?" +CHR$(13)+CHR$(10) : CALL IBWRT(ND%,CMD&)
1370 ST$=SPACE$(6) : CALL IBRD(ND%,ST$)
1380 LSCL=VAL(ST$)
1390 CMD$="RESLN?" +CHR$(13)+CHR$(10) : CALL IBWRT(ND%,CMD$)
1400 ST$=SPACE$(6) : CALL IBRD(ND%,ST$)
1410 RES=VAL(ST$)
1420 CMD$="AVG?" +CHR$(13)+CHR$(10) : CALL IBWRT(ND%,CMD$)
1430 ST$=SPACE$(6) : CALL IBRD(ND%,ST$)
1440 AVG=VAL(ST$)
1450 CMD$="SMPL?" +CHR$(13)+CHR$(10) : CALL IBWRT(ND%,CMD$)
1460 ST$=SPACE$(6) : CALL IBRD(ND%,ST$)
1470 SMPL=VAL(ST$)
1480 CMD$="SENS?" +CHR$(13)+CHR$(10) : CALL IBWRT(ND%,CMD$)
1490 ST$=SPACE$(3) : CALL IBRD(ND%,ST$)
1500 IF ST$="1"+CHR$(13)+CHR$(10) THEN SENS$="HIGH 1"
```

```

1510 IF ST$="2"+CHR$(13)+CHR$(10) THEN SENS$="HIGH 2"
1520 IF ST$="3"+CHR$(13)+CHR$(10) THEN SENS$="HIGH 3"
1530 IF ST$="4"+CHR$(13)+CHR$(10) THEN SENS$="NORM HLD"
1540 IF ST$="5"+CHR$(13)+CHR$(10) THEN SENS$="NORM AUT"
1590 START=CTR-SPAN/2
1600 STP=CTR+SPAN/2
1610 REF1=REF+LSCL*2 : YMAX=REF1
1620 REF2=REF-LSCL*2
1630 REF3=REF-LSCL*4
1640 REF4=REF-LSCL*6 : YMIN=REF4
1650 '
1660 VIEW (48,16)-(560,272)
1670 WINDOW (1,YMIN)-(1001,YMAX)
1680 LINE (1,YMIN)-(1001,YMAX),3,B
1690 LINE(1,(REF+LSCL))-(1001,(REF+LSCL)),3,,&H9999
1700 LINE(1,REF)-(1001,REF),3,,&HF99F
1710 FOR I=1 TO 5
1720  LINE (1,(REF-LSCL*I))-(1001,(REF-LSCL*I)),3,,&H9999
1730 NEXT I
1740 FOR I=1 TO 9
1750  LINE (1+I*100,YMIN)-(1+I*100,YMAX),3,,&H9999
1760 NEXT I
1770 '
1780 LINE(1,A(1))-(1,A(1)),14
1790 FOR I=1 TO 1001
1800  LINE -(I,A(I)),14
1810 NEXT I
1820 '
1830 COLOR 15
1840 LOCATE 1,4
1850 PRINT USING "##.##dB/D";LSCL
1860 LOCATE 1,22
1870 PRINT USING "RES:##.##nm  SENS:¥  ¥ AVG:####  SMPL:####";RES,SENS$,A
VG,SMPL
1880 LOCATE 2,2
1890 PRINT USING "###.##";REF1
1900 LOCATE 6,2
1910 PRINT USING "###.##";REF
1920 LOCATE 7,4
1930 PRINT "dBm"
1940 LOCATE 11,2
1950 PRINT USING "###.##";REF2
1960 LOCATE 16,2
1970 PRINT USING "###.##";REF3
1980 LOCATE 20,2
1990 PRINT USING "###.##";REF4
2000 LOCATE 21,2
2010 PRINT USING "#####.##nm  SPACE(7 digits)  #####.##nm  ###.##nm/D
###.##nm";START,CTR,SPAN/10,STP
2020 END

```

## Explanation of each program line

Line 1040	Declares an array of the measuring waveforms data.
Line 1050	Initializes the screen.
Line 1070	Opens the DEV1 file.
Lines 1090 to 1100	Sends a program code to the AQ6317B and sets the measuring conditions. This example sets the following: Center wavelength : 1550.00 nm, Sweep width : 20.0 nm Reference level : - 15.0 dBm, Level scale : 5.0 dB/div. Resolution : 0.1 nm, Averaging count : 1 time Measuring sensitivity : Normal Range Hold, Sampling point
Lines 1110 to 1120	Send program codes to the AQ6317B and set the following tracing conditions. Trace A : Write mode with display Trace B : Fixed mode with no display Trace C : Fixed mode with no display
Line 1140	Reads the status byte before measurement.
Line 1150	Sends a program code to the AQ6317B and sweeps for a single time.
Line 1160	Waits for a sweep end.
Lines 1180 and 1190	Set the CRLF string delimiter for data output, and request for an output of trace-A waveforms data.
Lines 1200 to 1240	Read the waveforms data and assigns them in array A (I).
Lines 1260 to 1580	Request for an output of measuring conditions, read the measuring conditions, and assign them in each variable.
Lines 1590 and 1600	Determine the wavelength at the beginning and end of measurement.
Lines 1610 to 1640	Determine the level (except for the reference level) displayed on the level axis.
Line 1660	Specifies the graphics display range on the controller screen.
Line 1670	Determines the coordinates of the specified range.
Line 1680	Draws a ruled line around the graphics.
Lines 1690 to 1730	Draws a level scale of the graphics. The reference level is drawn by dotted and dashed lines, but the others are drawn by dotted lines.
Lines 1740 to 1760	Draw a wavelength scale of the graphics.
Lines 1780 to 1810	Draw the measured waveforms.
Lines 1830 to 2010	Display the measuring conditions around the graphics.

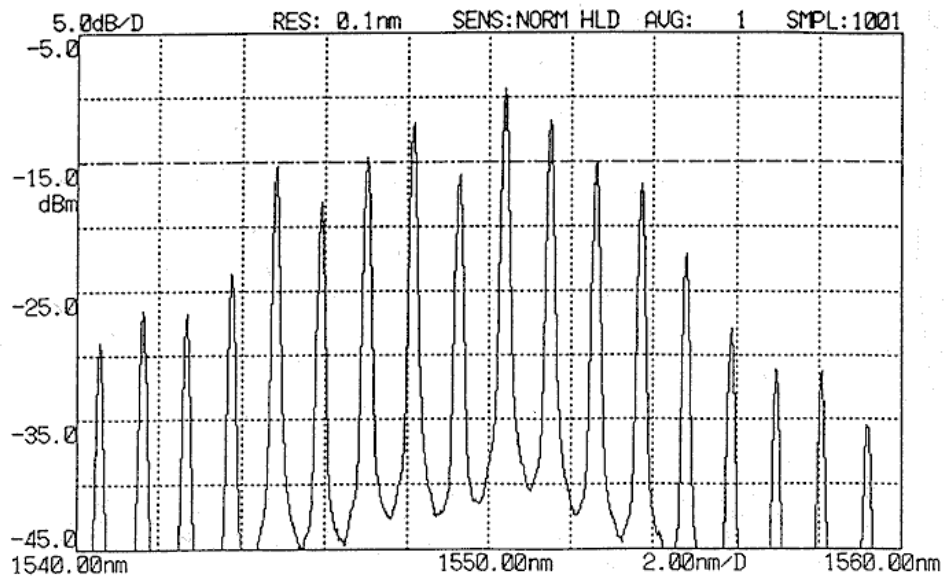

Program execution results (displayed on the controller screen)



## 9.3 Usage of GP-IB 2 Port

### 9.3.1 Interface functions of GP-IB 2 port

Table 9-7 shows the interface functions of the GP-IB 2 port.

Table 9-7 Interface Functions of GP-IB 2 Port

Code	Interface function
SH1	All send functions
AH1	All receive functions
T4	Basic talker
L2	Basic listener
SR0	No service request function
RL0	No remote/local function
PP0	No parallel poll function
DC0	No device clear function
DT0	No device trigger function
C1	System controller
C2	IFC transmission Controller in-charge
C3	REN transmission
C11	Interface message transmission Control reception Control transfer
E1	Handshake synchronous control Open collector driver

### 9.3.2 Connection to GP-IB system

To the [GP-IB 2] port, connect the wavelength variable light source and the GP-IB units to be controlled by program function.

Turn off the power supply of this equipment and the power supplies of the units to be connected to this equipment.

Connect the units to the GP-IB 2 connector on the rear side of this equipment by the GP-IB cord.

Tighten the fixing screw of the connector firmly.

## CAUTION

*If the GP-IB cord is connected or disconnected in the power ON status, this will cause a malfunction or failure to this equipment.*

### 9.3.3 Address setting

The address of the [GP-IB 2] port can be selected in the range of 0 to 30 . For the X-Y plotter and other units that this equipment controls, the address can be selected in the range of 0 to 30.

### 9.3.4 Wavelength tunable laser source control

Using the <TLS SYNC SWEEP> key of the [SETUP] switch, it is possible to have the wavelength tunable laser source (other) synchronized with the sweeps of this equipment.

The address for the wavelength tunable laser source can be set within the range of 0 through 30 using the <TLS ADRS> key of the switch.

For more details, refer to Section 5.6 "Synchronous measurement function with the wavelength tunable laser source".

### 9.3.5 External unit control

The external units connected to the GP-IB 2 port can be controlled by using the program function.

For details, refer to Chapter 6 Program Function.

# Chapter 10 PRINCIPLE AND CIRCUIT CONFIGURATION

This chapter describes the principle of measurement and circuit configuration.

## Contents of Chapter 10

10.1	Configuration and Principle of Monochromator.....	10-2
10.1.1	Principle of monochromator .....	10-2
10.1.2	Signal detector .....	10-3
10.2	Circuit Configuration.....	10-4
10.3	Precautions on Measurement.....	10-5
10.3.1	Types of optical fiber usable in this equipment .....	10-5
10.3.2	Restriction on resolution.....	10-5
10.3.3	Absolute level accuracy .....	10-6
10.3.4	Effective range of level axis when the measuring sensitivity is set to NORMAL RANGE HOLD.....	10-6
10.3.5	Stray light in the SENS:NORMAL mode.....	10-7
10.3.6	Ripple around 1380 nm .....	10-8
10.3.7	Level accuracy below fiber cable cutoff wavelength (short wave length) .....	10-8
10.3.8	Waveform observed in 0.01nm Resolution.....	10-8
10.3.9	Numerical Aperture (NA) of Input Optical Fiber and Level Measured Value.....	10-9

## 10.1 Configuration and Principle of Monochromator

### 10.1.1 Principle of monochromator

This equipment is provided with a Zollner-Thurnar's type monochromator.

Figure 10-1 shows the basic configuration.

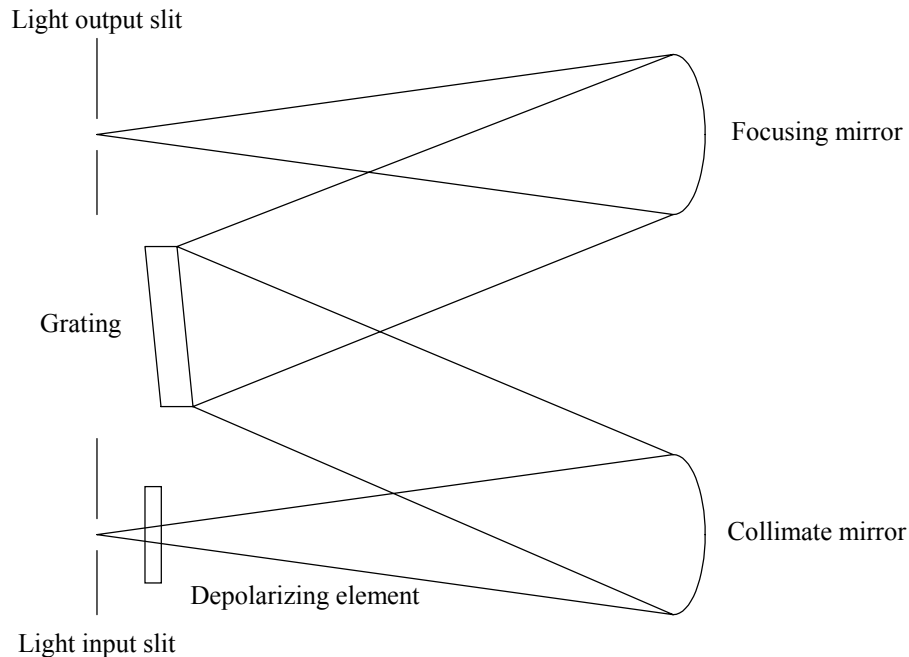

Fig. 10-1 Basic Configuration of Monochromator

The light input from the light input slit is changed into parallel light by the collimate mirror and enters the grating. The grating provided with innumerable grooves on the surface of a flat mirror reflects light at a different angle depending on the wavelength.

Therefore, the focusing mirror is arranged so as to receive only the light reflected in a specific direction and the light output slit is arranged at the position where the reflected light of the focusing mirror is focalized. This permits taking out only specific wavelength component by the slit.

The wavelength that can be transmitted through the slit can be changed by turning the grating, while the wavelength resolution can be changed by changing the widths of the light input slit and light output slit.

This equipment is designed in such a way that the optical fiber core may function as a slit without using a light input slit. For the collimate mirror and focusing mirror, axis parabolic mirrors free from axis are used to suppress aberration. Furthermore, the depolarizing element is provided in the input section to convert input light into a polarization-free status, thereby lowering the dependency on polarization.

Light is passed twice through the monochromator, so that excellent wavelength resolution can be obtained.

## 10.1.2 Signal detector

The light coming out from the monochromator is led to the signal detector.

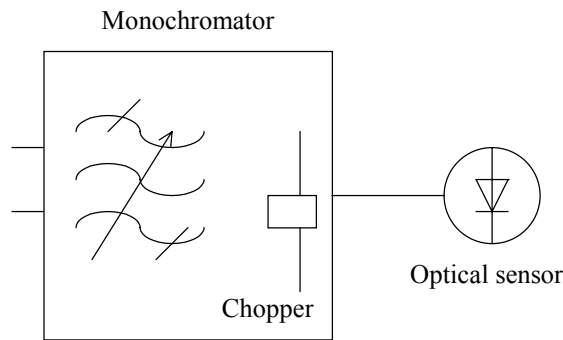

Fig. 10-2 Signal Detector Configuration

When the measuring sensitivity is set to HIGH1 to 3, light chopping is performed by the optical chopper built in the monochromator. With this, the electric output of the optical sensor becomes an AC signal and the effects of offset and drift of the optical sensor and AMP circuit are reduced.

Only the chopping frequency component is taken out by the synchronous detector circuit and passed through a low-pass filter, thereby attaining high sensitivity. The chopping frequency is set to 270 Hz.

When the measuring sensitivity is set to NORM, the optical chopper does not function but detection is not required, so that the AMP can respond quickly, thereby increasing the measuring speed.

The AMP offset status is automatically canceled at certain intervals of time. At this time, the sweep stops for about 4 seconds. The offset cancel operation can be cleared by the user and also can be performed by key operation when it is necessary. (→ 5.1.16 (11) <AUTO OFFSET> key)

## 10.2 Circuit Configuration

Figure 10-5 shows the circuit configuration of this equipment.

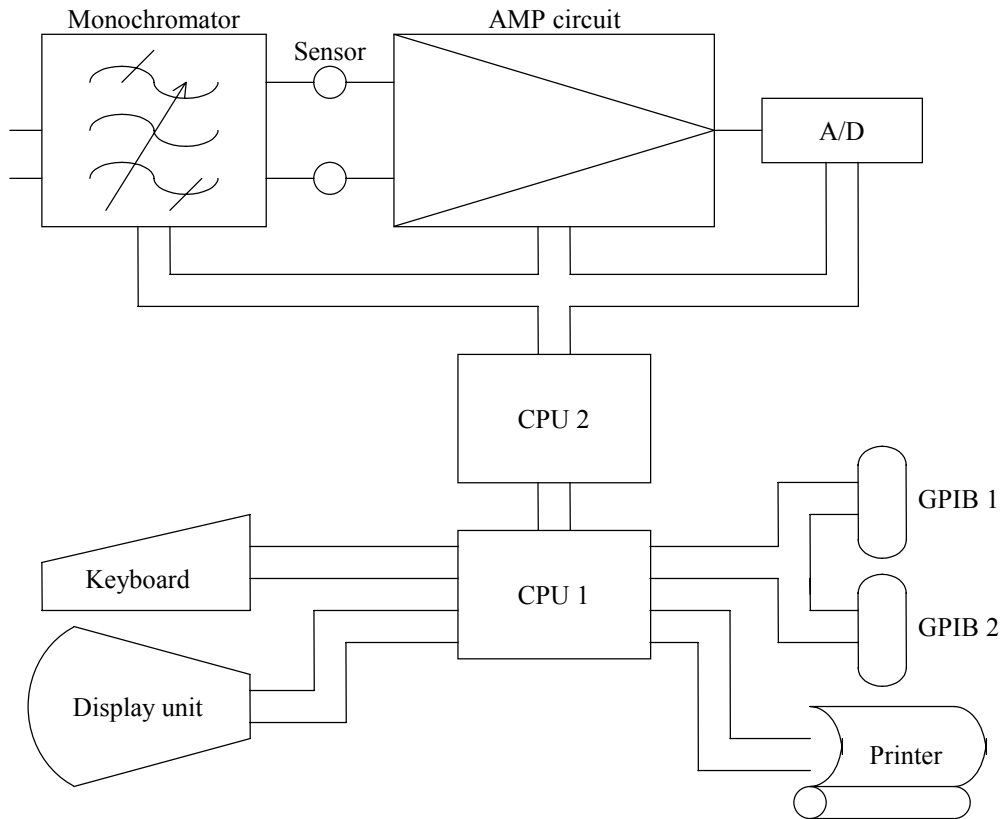

Fig. 10-3 Circuit Configuration of this Equipment

The grating of the monochromator controls the angle by means of a stepping motor.

The stepping motor is used to set a width to the slit, too. The stepping motor is also used to control the chopper and optical switch.

Out of the light entering from the [OPTICAL INPUT] connector, only the wavelength component to be measured by the monochromator is taken out and converted into an electric signal by the light receiver.

Then, the signal is amplified to a level fit for A/D conversion by the AMP circuit.

The amplified signal is converted into a digital signal by the A/D conversion circuit.

As a gain of the AMP circuit, an optimum value is selected by setting the reference level.

When the measuring sensitivity is set to HIGH1 to 3, auto gain adjustment is made by following up the input level, thereby enlarging the dynamic range.

The control circuit consists of a 32-bit CPU and a 16-bit CPU. The CPU1 controls the whole, key input, GP-IB ports, display unit and printer, while the CPU2 controls the monochromator, light receiver, AMP circuit and A/D conversion circuit.

## 10.3 Precautions on Measurement

This equipment is designed for different purposes but has some restrictions. Be careful about the following items at measurement.

### 10.3.1 Types of optical fiber usable in this equipment

This equipment can use the single mode optical fiber with a core diameter of 5 to 10  $\mu\text{m}$  and the GI fiber with core diameters of 50 and 62.5  $\mu\text{m}$  for the optical input. If another optical fiber is used, the performance is restricted. The following table shows the adaptability of typical optical fibers and restrictions.

This equipment is designed exclusively for optical fiber input. Such means as inputting gas laser beams directly to the optical input connector and causing the LED to adhere to the optical connector unit cannot be used instead of inputting light using an optical fiber. Note that the optical spectrum measured by these means is not trustworthy at all.

For space light measurement, input space light to an optical fiber and then to this equipment.

Various adapters for this purpose are available. (→ Table 1-2 Option List)

Table 10-1 Adaptability of Optical Fibers and Restrictions

Type of optical fiber		Adaptability	Maximum resolution	Absolute level accuracy
Type	Core diameter			
SM	5	○	0.015	○
SM	9	○	0.015	○
SM	10	○	0.015	◎
GI	50	○	0.05	△
GI	62.5	○	0.05	△
SI	50	△	0.05	×
SI	80	△	0.1	×
SI	100	△	0.2	×
SI	200	△	0.5	×
SI	400	△	1.0	×
SI	800	△	2.0	×

### 10.3.2 Restriction on resolution

The maximum resolution of this equipment is 0.015 nm, which is a value when the SM fiber is used.

In case a fiber with a larger core diameter is used, the maximum resolution is restricted as shown in Table 10-1.

Even if the resolution is set to a lower value than the table, the measurement level becomes inaccurate but the resolution is not improved.

In particular, when entering space light, it is advantageous to use a fiber with a larger core diameter but there is a restriction on resolution.

### 10.3.3 Absolute level accuracy

The absolute level of this equipment is calibrated by SM 10  $\mu\text{m}$  fiber.

The level accuracy, when the other fibers are used, is out of specification.

As a matter of practical efficiency, any SM fiber other than the SM 10  $\mu\text{m}$  fiber will provide an almost accurate level.

The GI fiber will provide a rather accurate level if the light source is of low coherence (low monochromatism) like white light, natural light and LED. In case of laser light which is of high monochromatism, interference occurs in the fiber and the intensity distribution of radiated light from the fiber end varies with fiber forms. Accordingly, when the fiber is moved, the measurement level may change.

Fibers with a large core diameter have a small monochromator NA values, so that only a part of the light output from the fiber cannot be measured and the measurement level becomes small.

However, the measurement level is accurate as an optical spectrum viewed relatively.

### 10.3.4 Effective range of level axis when the measuring sensitivity is set to NORMAL RANGE HOLD

When the measuring sensitivity is set to NORMAL RANGE HOLD or in the pulse light measurement mode, the gain of the internal amplifier is fixed. Accordingly, the effective range of measured data is limited into the range of the following expression specifying the set value of reference level as R (dBm).

$$R - 30 < (\text{Effective range}) < R + 10$$

When the level scale is set to 10 dB/DIV, the display exceeds the effective range, so that the 10 dB part from the upper end of the screen and the 30 dB part from the lower end become inaccurate.

For this reason, when the measuring sensitivity is set to NORMAL RANGE HOLD, the level scale should be used at 5 dB/DIV or less. If the setting exceeds 5 dB/DIV, a warning message is displayed and the data of the upper and lower parts of the screen cannot be displayed correctly.

To display an accurate spectrum at 10 dB/DIV, set the measuring sensitivity to HIGH1 to 3.

When the measuring sensitivity is set to NORMAL RANGE AUTO, an approximate form of spectrum at 10 dB/DIV can be known quickly.



### 10.3.5 Stray light in the SENS:NORMAL mode

If you select the SENS:NORMAL HOLD or NORMAL AUTO for the measurement gain, optical noises can uniformly appear in the lower spectrum level (see Figure 10-4). Also in the same mode, optical noises with the spectrum level of approximately lower than their original level by 30 to 50 dB can appear in the position 100 to 200 nm away from the peak wavelength. Widening the resolution can result in increasing optical noise component, too. Thus, when it is required to reduce optical noises, a narrower resolution must be specified. If you select the HIGH 1 to 3 for the gain, above mentioned optical noises won't be present (see Figure 10-5).

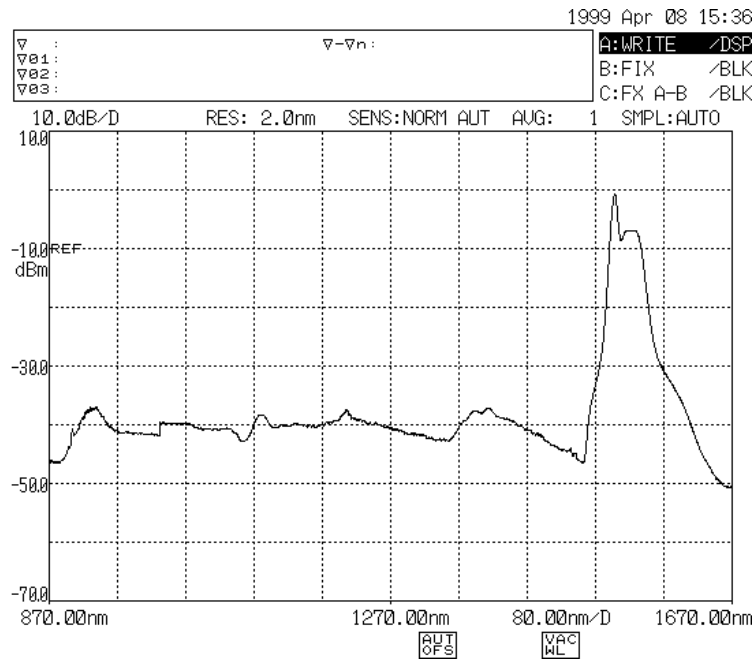

Fig.10-4 Waveform Observed in the SENS:NORM Mode

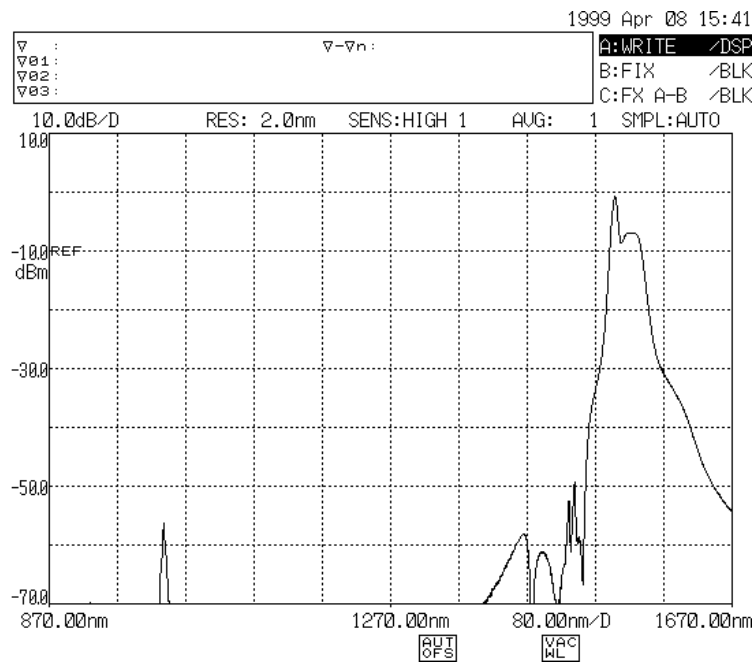

Fig.10-5 Waveform Observed in the SENS:HIGH 1 Mode

### 10.3.6 Ripple around 1380 nm

As the optical beam around 1380 nm is absorbed by a water (OH group) existing in the monochromator, a ripple may be formed on the measured waveforms.

The basic solution is the setup of wider resolution for ripple averaging.

For LED measurement, please set 2nm to the resolution

### 10.3.7 Level accuracy below fiber cable cutoff wavelength (short wave length)

When a gas laser source or an LD optical source having the high coherence is measured, the level may become inaccurate due to the speckle pattern noise.

If it has occurred, improve the coupling performance and the level accuracy will be improved.

### 10.3.8 Waveform Observed in 0.01nm Resolution

If the resolution is set to 0.01 nm and measurement is taken of a light source (such as DFB laser) having a spectral band width narrower than 0.01 nm, a minute maximum value can appear in trailing edge of the waveform (see Figure 10-6).

It results from characteristics of the optical system and not a failure. This phenomena does not affect the unit performance including the resolution and dynamic range.

You can eliminate it by widening the resolution.

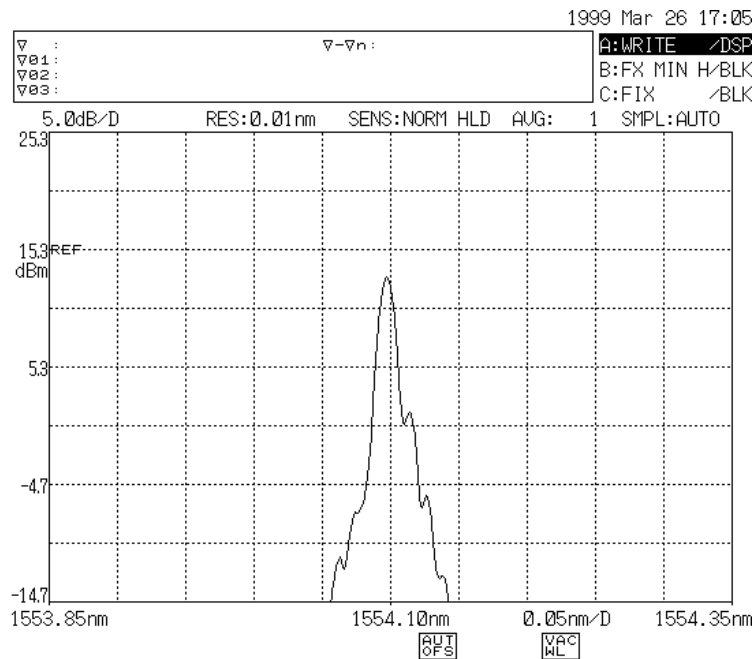

Fig.10-6 Waveform Observed in 0.01 nm resolution

### 10.3.9 Numerical Aperture (NA) of Input Optical Fiber and Level Measured Value

Level measurement error of this equipment varies with the numerical aperture (NA) of optical fiber to be connected to the optical input connector as shown in Figure 10-7. The absolute level of this equipment has been calibrated with the 10/125 $\mu$ m single mode optical fiber (B1.1 type defined on IEC60793-2, PC polished, Mode field diameter 9.5 $\mu$ m, NA: 0.104~0.107). Even in case of single mode optical fiber, the level accuracy deviates from the specification when the NA value is not in this range.

When level is measured after an optical fiber of unknown NA is connected to this device, the level can be measured correctly if the level shift amount of this equipment is set as follows:

- (1) Prepare the light source (wavelength: 1310nm or 1550nm) of narrow spectral width of DFB-LD, etc.
- (2) Connect this device to the light source with an optical fiber cord and set the wavelength resolution of this equipment to 2nm. Start the measurement and obtain the peak level value.
- (3) Remove the optical fiber cord from this equipment and connect it to the optical power meter and measure the optical power value.
- (4) Find the difference between the peak level value obtained with this device and the power value obtained with the optical power meter, and set the difference as the level shift amount of this equipment ( $\rightarrow$ 5.1.16 <LEVEL SHIFT> key).

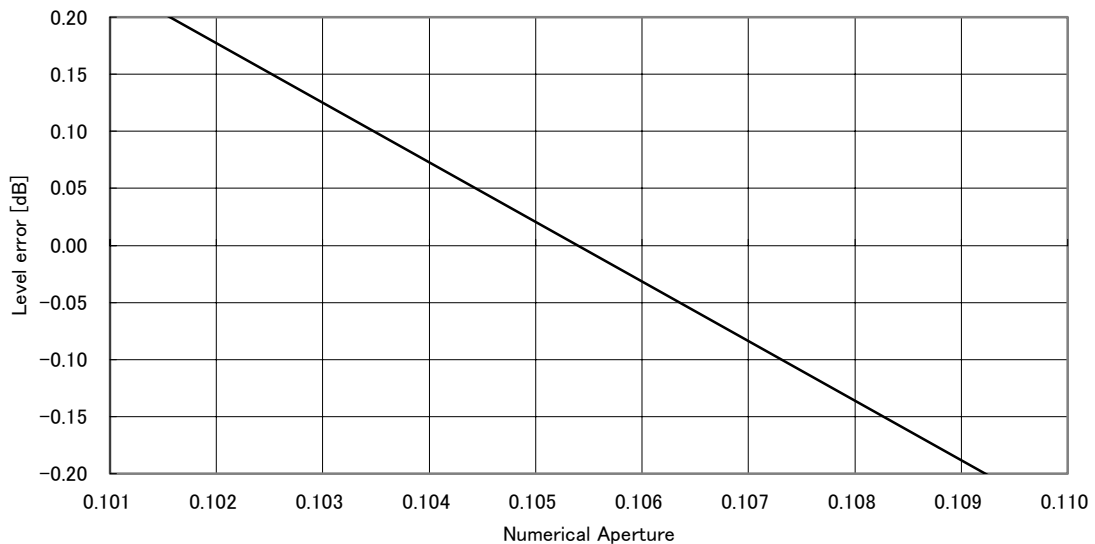

Fig.10-7 Numerical Aperture of Input Optical Fiber and Level Error (Typical Characteristic)

# CHAPTER 11 MAINTENANCE

This chapter describes the mechanical inspection and operation check of this equipment.

## Contents of Chapter 11

11.1	Mechanical Inspection .....	11-2
11.2	Operation Check .....	11-3
11.2.1	Check at power-on .....	11-3
11.2.2	Operation check of switches.....	11-3
11.2.3	Wavelength accuracy check .....	11-3
11.2.4	Level accuracy check .....	11-4

## **11.1 Mechanical Inspection**

This section externally inspects the appearance and mechanical operation of the operator panel in this equipment. For the appearance, the visual inspection is used to check that no damage and deformation can be seen and inspect the presence of loosened switches, connectors, and other assembly parts and whether or not the equipment can smoothly be operated.

If an abnormality is detected, immediately inform our company of the contents.

## 11.2 Operation Check

### 11.2.1 Checking at power-on

This equipment performs a self-check such as a monochromater operation check and internal memory check until the initial screen is switched to the normal display screen after the power has turned on.

Usually, after the power has turned on, the initial screen is switched to the normal display screen for approximately one minute.

When an abnormality occurred, the initial screen is not switched to the normal display screen even if several minutes elapse after the power has turned on and continues displaying the initial screen.

When an abnormality also occurred, error messages are displayed and the operation is stopped.

If an abnormality is detected, immediately inform our company (head office, branch, or sales office) of the contents.

### 11.2.2 Operation check of switches

Thoroughly operate each switch and check that this equipment is operated.

### 11.2.3 Wavelength accuracy check

Check the wavelength accuracy using the following measurement system.

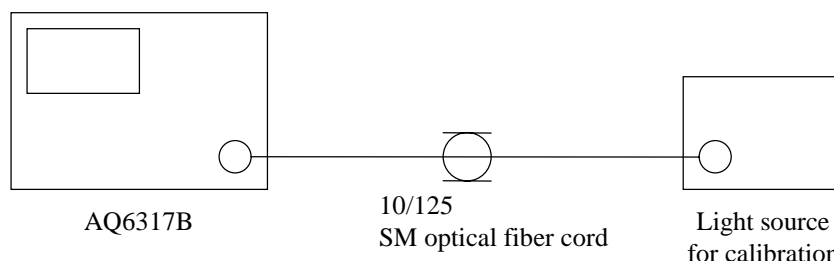

Connect the 10/125 SM optical fiber cord between the CALIBRATION OUTPUT connector and INPUT connector of this equipment.

- (1) Measure the light source for calibration whose accurate wavelength is known such as gas laser and check that the peak wavelength of the display waveform matches the wavelength of the light source for calibration (within the wavelength accuracy).
- (2) When the wavelength error increases, calibrate the wavelength in the following procedure.  
Press the [SYSTEM] switch and select the <WL CAL> key of the soft key. In this case, use the soft key menu to be displayed to press the key with the same wavelength as the light source for calibration.  
When the <EXECUTE> key of the soft key is pressed, the wavelength calibration is executed.
- (3) If the wavelength calibration function cannot be executed because the wavelength error exceeds  $\pm 5$  nm and if the wavelength error is generated in another wavelength after the wavelength calibration has been executed, the monochromater needs to be readjusted. Accordingly, contact our company.

## 11.2.4 Level accuracy check

Check the level accuracy using the following measurement system.

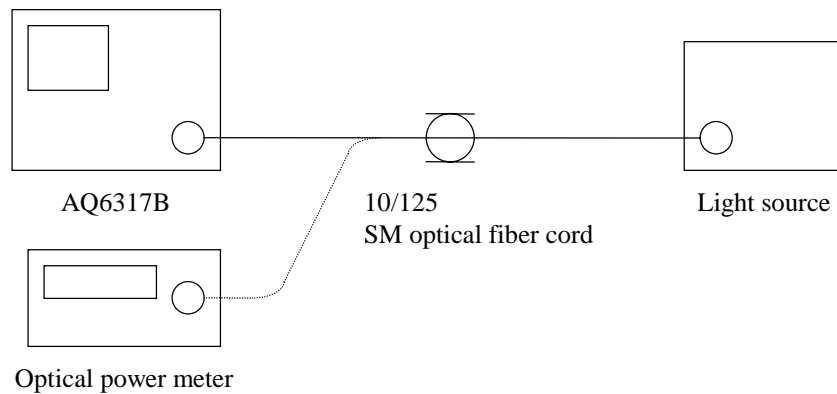

- (1) Prepare one of the two light sources of 1310 and 1550 nm. However, prepare light sources with narrow spectrums (for example, gas laser and DFB-LD) so that all spectrums can be contained between 2 nm and 2 nm.
- (2) Connect the light source and this equipment with the SM fiber cord and set the resolution of this equipment to 2 nm. Make a measurement and obtain the peak level value.
- (3) Remove the SM optical fiber cord from this equipment and connect it to the optical power meter. Make a measurement and obtain the power value.
- (4) Check that the peak level value obtained by this equipment matches the power value obtained by the optical power meter (within the level accuracy).