



Advanced Test Equipment Corp.

www.atecorp.com 800-404-ATEC (2832)

GE

Sensing & Inspection Technologies

# Druck DPI 610/615

Portable Pressure Calibrator Series

User manual - K0415

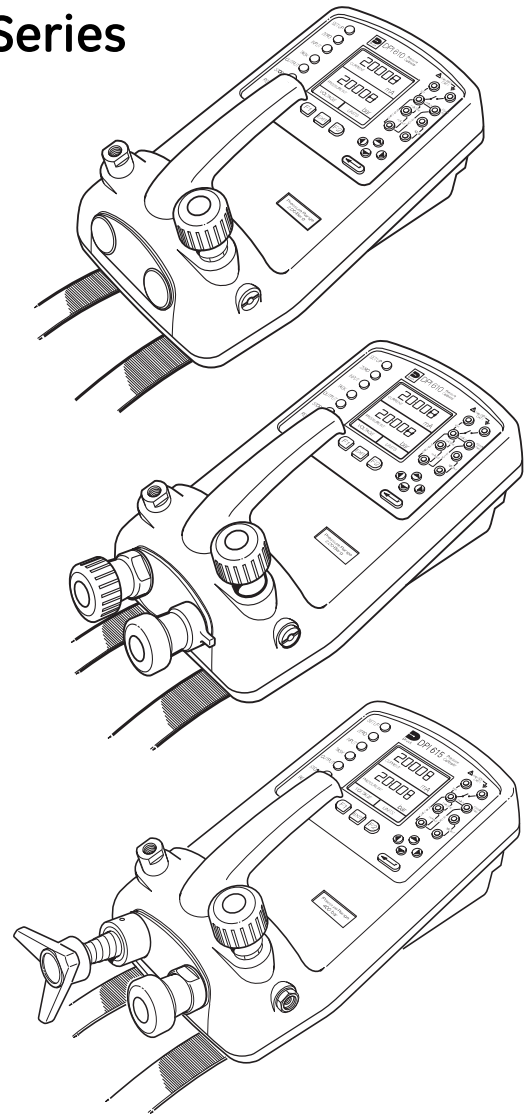



## **English**

To select the manual in an available language go to:

[//www.gesensing.com/toolsupport/manuals.htm](http://www.gesensing.com/toolsupport/manuals.htm)

## **Français**

Pour choisir le manuel dans une langue disponible, accédez à :

[//www.gesensing.com/toolsupport/manuals.htm](http://www.gesensing.com/toolsupport/manuals.htm)

## **Deutsch**

Um das Handbuch in einer vorhandenen Sprache auszuwählen, gehen Sie zu:

[//www.gesensing.com/toolsupport/manuals.htm](http://www.gesensing.com/toolsupport/manuals.htm)

## **Italiano**

Per scaricare il manuale in una delle lingue disponibili consultare la pagina:

[//www.gesensing.com/toolsupport/manuals.htm](http://www.gesensing.com/toolsupport/manuals.htm)

## **Español**

Para seleccionar el manual en uno de los idiomas disponibles vaya a:

[//www.gesensing.com/toolsupport/manuals.htm](http://www.gesensing.com/toolsupport/manuals.htm)

## **Português**

Para selecionar o manual em uma língua disponível vá:

[//www.gesensing.com/toolsupport/manuals.htm](http://www.gesensing.com/toolsupport/manuals.htm)

## **Polski**

Aby wybrać podręcznik w dostępnym języku, przejdź do strony:

[//www.gesensing.com/toolsupport/manuals.htm](http://www.gesensing.com/toolsupport/manuals.htm)

## **Язык**

Для выбора руководства на имеющемся языке зайдите на web-сайт

[//www.gesensing.com/toolsupport/manuals.htm](http://www.gesensing.com/toolsupport/manuals.htm)

## **语言**

选择手册的语言，请访问：

[//www.gesensing.com/toolsupport/manuals.htm](http://www.gesensing.com/toolsupport/manuals.htm)

## **言語**

利用可能な言語のマニュアルを選択するには次のサイトへアクセスしてください：

[//www.gesensing.com/toolsupport/manuals.htm](http://www.gesensing.com/toolsupport/manuals.htm)

# Safety

The manufacturer has designed this equipment to be safe when operated using the procedures detailed in this manual. Do not use this equipment for any other purpose than that stated.

This publication contains operating and safety instructions that must be followed to ensure safe operation and to maintain the equipment in a safe condition. The safety instructions are either warnings or cautions issued to protect the user and the equipment from injury or damage.

Use suitably qualified \* technicians and good engineering practice for all procedures in this publication.

## Pressure

Do not apply pressures greater than the safe working pressure to this equipment.

## Maintenance

The equipment must be maintained using the procedures in this publication. Further manufacturer's procedures should be carried out by authorized service agents or the manufacturer's service departments.

[www.gesensing.com](http://www.gesensing.com)

For technical advice contact the manufacturer.

\* *A qualified technician must have the necessary technical knowledge, documentation, special test equipment and tools to carry out the required work on this equipment.*

## Symbols



This equipment meets the requirements of all relevant European safety directives. The equipment carries the CE mark.



This symbol, on the instrument, indicates that the user should refer to the user manual. This symbol, in this manual, indicates a hazardous operation.

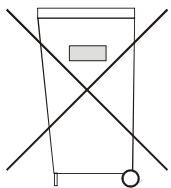

This symbol, on the instrument, indicates do not throw-away in domestic bin, hazardous material, dispose correctly in accordance with local regulations.

# Specification

## **Safe working pressure**

20 bar range (300 psi)	1.75 x full-scale
350 bar range (5000 psi)	1.2 x full-scale
400 bar range (6000 psi)	1.5 x full-scale
All other ranges	2 x full-scale

## **Accuracy**

Combined non-linearity, hysteresis and repeatability

±70 mbar range (2 inHg)	0.05% F.S.
up to ±150 mbar (4.4 inHg)	0.05% span
200 mbar to 20 bar (3 psi to 300 psi) [Calibrator]:	0.025% F.S.
35 bar to 700 bar (500 psi to 10000 psi) [Indicator]	0.025% F.S.
70 bar to 400 bar (1000 psi to 6000 psi) [Hydraulic]	0.025% F.S.

## **Pressure Ranges**

Refer to the pressure range matrix in the data sheet.

## **Temperature Effects**

±0.004% of reading/°C (averaged over -10° to +40°C w.r.t. 20°C)
±0.002% of reading/°F (averaged over +14° to 104°F w.r.t. 68°F)

## **Power supply**

Batteries 6 x 1.5 V C cells, alkaline (up to 60 hours nominal use at 20°C)  
Rechargeable NiCad battery pack (20 hours nominal use) supplied with charger/  
adaptor, supplies power to instrument while charging batteries.

## **Voltage Inputs**

Range:	±50V
Accuracy	±0.05% rdg, ±0.004% F.S.
Resolution	100µV max

## **Voltage Outputs**

Range:	±10V
Accuracy	±0.1%
Load	10mA
Range:	±24V
Accuracy	±5%
Load	26mA

## **Current Inputs**

Range:	±55mA
Accuracy	±0.05% rdg, ±0.004% F.S.
Resolution	1µA max

## **Current Output**

Range:	24mA
Accuracy	±0.05% rdg, ±0.01% F.S.
Resolution	1µA max

## Specification (contd.)

### **Display**

Size: 60 x 60 mm (2.36" x 2.36") LCD Graphics  
Reading  $\pm 99999$ , update rate 2 readings/sec

### **Environment**

Operating Temperature:  $-10^{\circ}\text{C}$  to  $50^{\circ}\text{C}$  ( $+14^{\circ}\text{F}$  to  $122^{\circ}\text{F}$ )  
Calibrated Temperature:  $-10^{\circ}\text{C}$  to  $40^{\circ}\text{C}$  ( $+14^{\circ}\text{F}$  to  $104^{\circ}\text{F}$ )  
Storage Temperature:  $-20^{\circ}\text{C}$  to  $60^{\circ}\text{C}$  ( $-4^{\circ}\text{F}$  to  $140^{\circ}\text{F}$ )  
Calibration Temperature:  $21^{\circ}\text{C} \pm 2^{\circ}\text{C}$  ( $70^{\circ}\text{F} \pm 4^{\circ}\text{F}$ )

### **Sealing**

Sealed to IP54 (NEMA 4)

### **Physical**

Size: 300 x 170 x 140 mm (11.8" x 6.7" x 5.5")  
Weight: 3 kg (6.6lb)

## **Introduction**

### **General**

Description of Procedures	1
---------------------------	---

## **Summary of Functions**

Using the Guide	2
OPERATOR CONTROLS	3
DISPLAY	3
HARD KEY FUNCTIONS	4
SOFT KEYS	5
CURSOR KEYS	5
ELECTRICAL CONNECTIONS	6

## **Getting Started**

Fitting Batteries	7
Switching On	7
Change Pressure Units	8
Voltage and Current Measurement	8
Typical Calibration Set-up (Pressure to Voltage)	9
Zero Display Reading	9

## **Task Selection**

Task Key	10
Using Task Functions	10
Set Units	10
Set 24 Volts	10
Cal Mode (DPI 615 versions only)	11
Basic Mode (Task BASIC)	11

## **Taking Measurements**

Pressure Transmitter (P-I) Task	12
Voltage Output Pressure Transmitter (P-V) Task	12
Pressure Converter (P-P) Task	13
Current to Pressure Converter (I-P) Task	14
Pressure Switch Test (P-Switch) Task	14
Pressure Switch Testing with Contact Resistance Measurement	15
Pressure to Display (P-Display) Task	16
Leak Test (Leak Test) Task	17
Transmitter Simulator (TX SIM) Task	18
Relief Valve Test (REL VALVE) Task	19

## Advanced Task

General	20
Select Input	20
Ambient Temperature Measurement	20
Process Functions	21
Tare Process Function	22
Min/Max Process Function	23
Filter Process Function	23
Flow Function	24
% Span	24
Select Output	25
Electrical Outputs (Loop Power)	25
mA Step	26
mA Ramp	27
mA Value	28
24 Volt	28
Define New Task	29
Clear Task	29

## Memory Operations

Saving Display or Data Log	30
Store Operations (Screen Snapshots)	30
Recalling Stored Data (Screen Snapshots)	30
Datalog Operations	31
Auto Log (Timer)	31
Manual Logging	31
Recall Data Log Files	32
Uploading Data Log Files	33
Delete Data Log and Procedure Files	33
Downloading Procedure Files (DPI 615 versions only)	34
Running Procedure Files (DPI 615 versions only)	35
Recalling Data Files	36

## Using Set-up

General	37
Store Mode	37
Contrast	37
Settings - Select Set-up Option	38
<i>Units</i>	38
<i>Define Special Units</i>	38
<i>Language</i>	39
<i>RS232</i>	39
<i>Powerdown</i>	40



Calibration	40
Date and Time (Real Time Clock)	41
<i>Date Format</i>	41
<i>Set Date</i>	41
<i>Set Time</i>	41
Backlight	42
<b>Calibration</b>	
General	43
Calibration Check	43
Calibration Adjustment	43
General Procedures	44
Using The Calibration Menu	45
Change PIN	45
Pressure	46
Voltage Input Range (5 Volts)	47
Voltage Input Range (50 Volts)	49
Current Input Range (55 mA)	51
Current Output Range (24 mA)	53
Temperature	56
External Pressure Range	57
Add External Sensor	58
<b>Hydraulic Calibrator Versions</b>	
Introduction	61
Safety Instructions	62
Preparation for Use	62
Bleeding the System	63
Draining the Hydraulic Fluid	64
Flushing, Replenishing or Changing the Hydraulic Fluid	65
<b>Low Pressure Calibrator Versions</b>	
Introduction	69
Preparation for Use Low Volume Systems	70
Method of Testing with Low Volume Systems	70
Preparation for Use Larger Volume Systems	72
Method of Testing with Larger Volume Systems	74
Calibration	75
Calibrate Internal Pressure Range	75
<b>Appendix 1 - Datalog File Example</b>	
Typical Uploaded Datalog File (DPI 610)	79
Typical Uploaded Procedure Data File (DPI 615)	80



## General

The versions of the DPI 610 and DPI 615 instruments are: pneumatic indicator, pneumatic calibrator, hydraulic calibrator and low pressure pneumatic calibrator. All instruments measure and display pneumatic and hydraulic pressure applied to the test port or to an externally connected pressure sensor. Pressure measurement can be absolute, gauge and sealed gauge and in ranges from 2.5 mbar to 700 bar (1.0 inH<sub>2</sub>O to 10000 psi).

The calibrator versions of this instrument contain pneumatic or hydraulic pressure generation components to produce pneumatic pressure ranges between -1 to 20 bar (-14.5 psi to 300 psi) and hydraulic pressure ranges up to 400 bar (6000 psi).

The electrical connections, on the front of the instrument, enable the instrument to measure ±50 volts d.c. and ±55 mA and produce 10 volts d.c. or 24 volts d.c. and a maximum of 24 mA. An integral sensor provides measurement of ambient temperature. Additional sensors (option B1) connect to an external connector and extend the pressure measurement range and include differential pressure measurement. The instrument has an RS232 connector to enable uploading of test data to a compatible documenting system. The DPI 615 has the ability to download, from a PC, pre-defined calibration and test routines. Six alkaline C size batteries or (option A) rechargeable batteries with a charger/adaptor, power the instrument.

### Important Notice

Zinc-carbon and zinc-chloride cells should **NOT** be used in this instrument.  
Use only the battery types as shown in the table on page 7.

## Description of Procedures

In the procedures outlined in this user guide, hard (fixed function) and soft (variable function) key operations are shown in bold type (e.g.) **TASK** and **F1**. These statements mean press the **TASK** key and press the **F1** key. Soft key operations can be allocated to both the F1 and F2 keys. Where a specific soft function is referred to it is written in bold italics (e.g.) **PROCESS**.

This instrument has a number of operating modes that are described in a simplified form in the following sections. Diagrams accompanying the procedures give typical selection sequences and shaded controls indicate that this control key should be pressed in the appropriate sequence. Diagrams should be read from left to right, top to bottom where appropriate. A shaded display soft box indicates that the function key immediately below that soft box should be pressed (either **F1** for the left hand soft box or **F2** for the right).

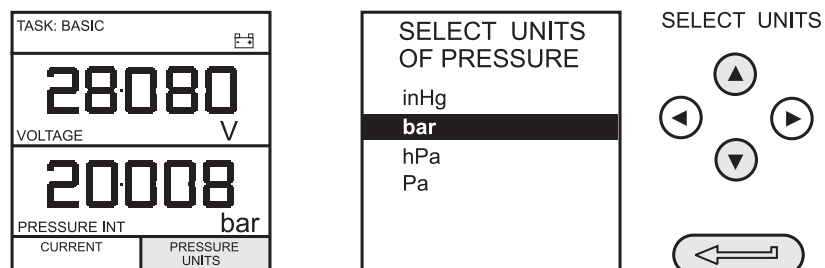

In the above diagram the following key sequence is indicated.

- Press the **F2** key (the key immediately below the **PRESSURE UNITS** soft box).
- Use the **Up** and **Down** cursor keys (only) to select the required option. (If all keys shaded, use all these keys to select or enter data).
- Press the **ENTER** key.

## Using this guide

The following key symbols are used in the procedure diagrams that follow:

### SELECT VALUE

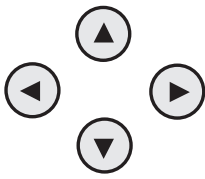

Shaded cursor keys indicate that a combination of these four keys, Up, Down, Left and Right should be used to (e.g.) enter an alpha numeric value or to select a function.

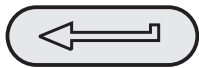

Indicates the **ENTER** key. Used to confirm an operation or a selection. Shading indicates key operation.



Exit key, used to clear current menu selection and return to next menu level above current level. Used as an escape key from current operation. Shading indicates key operation.



Hardkey (total 7). Legend beside key symbol indicates function. Shading indicates key operation.

## Maximum Instrument Ratings

The following table shows the maximum measurement input ratings of the instrument that should not be exceeded.

PRESSURE	120% FULL SCALE
VOLTAGE	50 V d.c.
CURRENT	55 mA d.c.

**Note 1:** The display flashes if the input pressure, voltage or current overrange.

**Note 2:** Max applied voltage for external loop supply = 30V dc (see page 8).

OPERATOR CONTROLS (Figure 1 and 2)

These divide into two groups, the operator/display controls (Figure 1) and the pressure/vacuum generation components (Figure 2). The operator controls and a typical display, common to all instrument versions, is shown below.

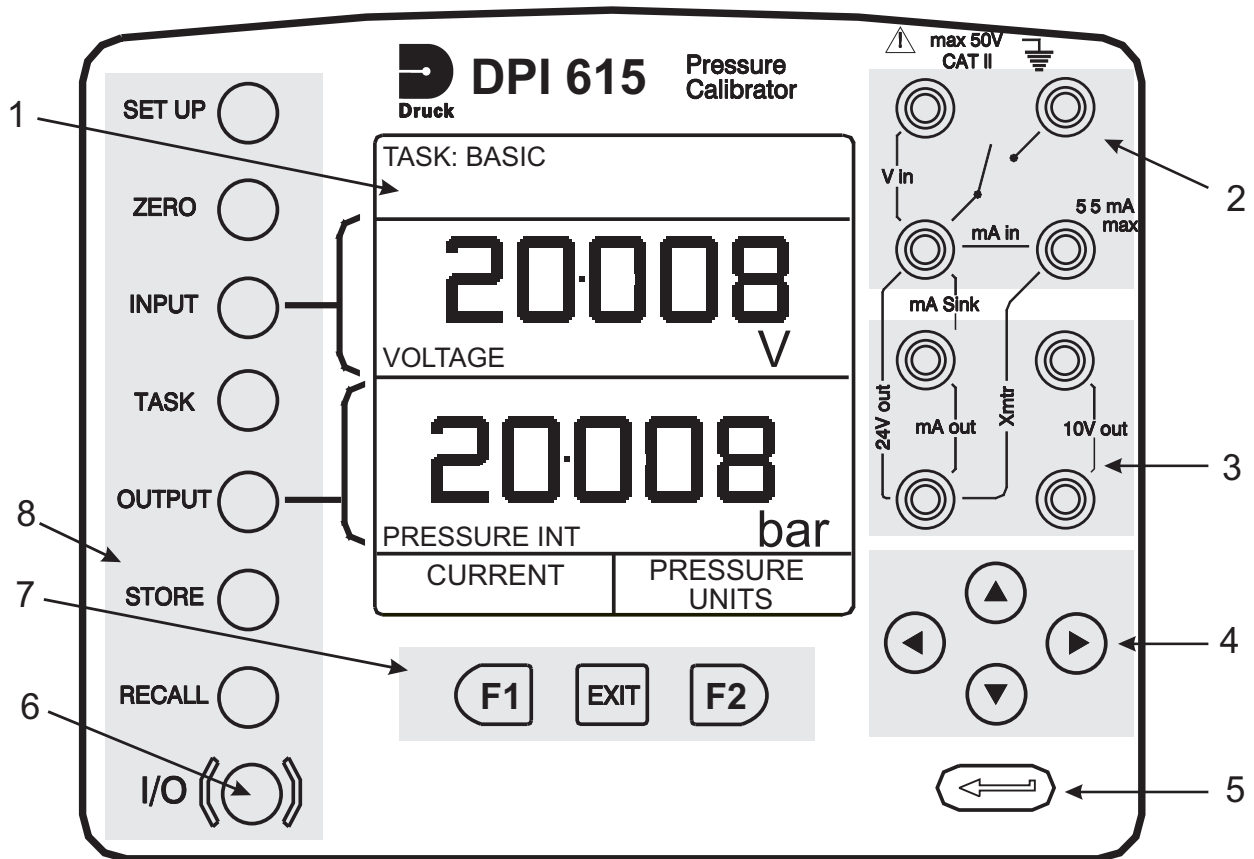

- 1 Display      2 Electrical Input Sockets      3 Electrical Output Sockets      4 Cursor
- 5 Enter Key    6 On/Off Key                              7 Function (soft) Keys      8 Hard Keys

Figure 1 - DPI 610/615 Key-pad

Display

The display section of the instrument basically divides into four distinct sections. The two main sections of the display are used to display a *input* and an *output*. The remaining sections show the status display area and define the soft key functions. A typical display is shown below:

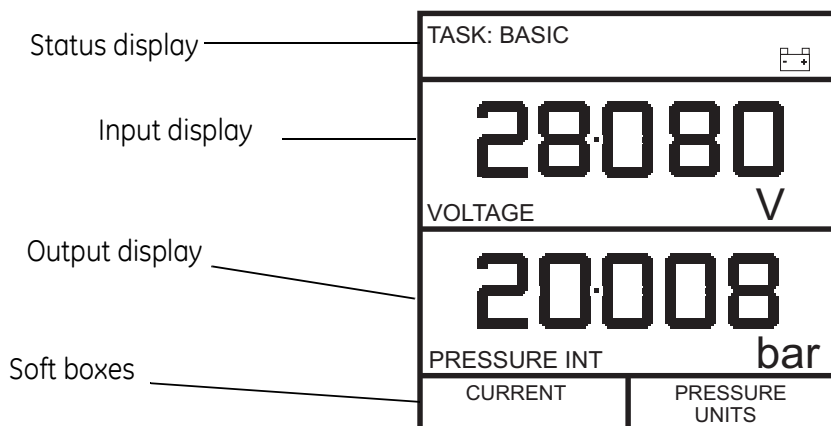

## HARD KEY FUNCTIONS (Figure 1)

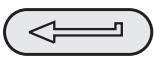
Key	Function	Page reference
I/O	This key is used to turn the instrument ON and OFF.	7
SETUP*	The <b>SETUP</b> key provides access to the instrument's general configuration parameters that are set up to certain default parameters on delivery.	37
ZERO	The <b>ZERO</b> key can be used to zero either the selected input or output display, if the display reading is within 5% of zero. Attempts to zero a larger offset result in an error message, <b>Zero too large</b> .	9
INPUT*	The <b>INPUT</b> key is used to select the input parameter to be displayed.	20, 21
TASK	The <b>TASK</b> key is used as a means of rapidly configuring the instrument for a number of different types of external device calibration. There are twenty task configurations available, eleven of which are pre-programmed and nine are user definable	10
OUTPUT*	The <b>OUTPUT</b> key is used to select output parameter to be displayed.	25-28
STORE*	Depending upon how the instrument's <b>STORE</b> mode is setup, this key is used either to store up to 20 display screens (in <b>SNAPSHOT</b> mode), or to manually log a screen in <b>DATALOG</b> mode.	30-36
RECALL*	This key is used to recall a previously stored screen to the display. Depending on the <b>STORE</b> mode set-up, operation of this key recalls either the snapshot of a previously stored screen or datalog file. In <b>STORE</b> mode, selection displays the last screen stored. By using the cursor keys, the operator can scroll either forward or back through memory locations.	30, 32-36
ENTER 	The <b>ENTER</b> key is used either to enter data (accept entered data), or, in conjunction with the soft keys, to accept a given selection.	2
EXIT	The <b>EXIT</b> key operates in conjunction with all the other hard and soft keys to exit from the current screen or menu level, to the level immediately preceding it. To quit completely from any menu level, press <b>EXIT</b> until the <b>MEASURE/SOURCE</b> screen is displayed.	2

\* These key functions are not available in BASIC mode

## SOFT KEYS (Figure 1)

Three soft keys, designated **F1**, **EXIT** and **F2**, are situated immediately below the display as shown below. These keys have their function allocated by the instrument software which is indicated in the bottom of the display (Voltage for **F1** and Units for **F2** in this example). They are used to select menu (program) options and are fully described under the appropriate section headings.

## CURSOR KEYS (Figure 1)

The cursor keys consist of a block of four keys, designated **up ▲**, **down ▼**, **left ◀** and **right ▶**. In programs where options need to be selected from a list, (e.g.) the **TASK** selection program, the **up ▲** and **down ▼** cursor keys are used to highlight one of the options, from which it can be selected by the **ENTER** key. In **TASK** mode, where more than one page of options are provided, the **left ◀** and **right ▶** cursor keys will switch between pages.

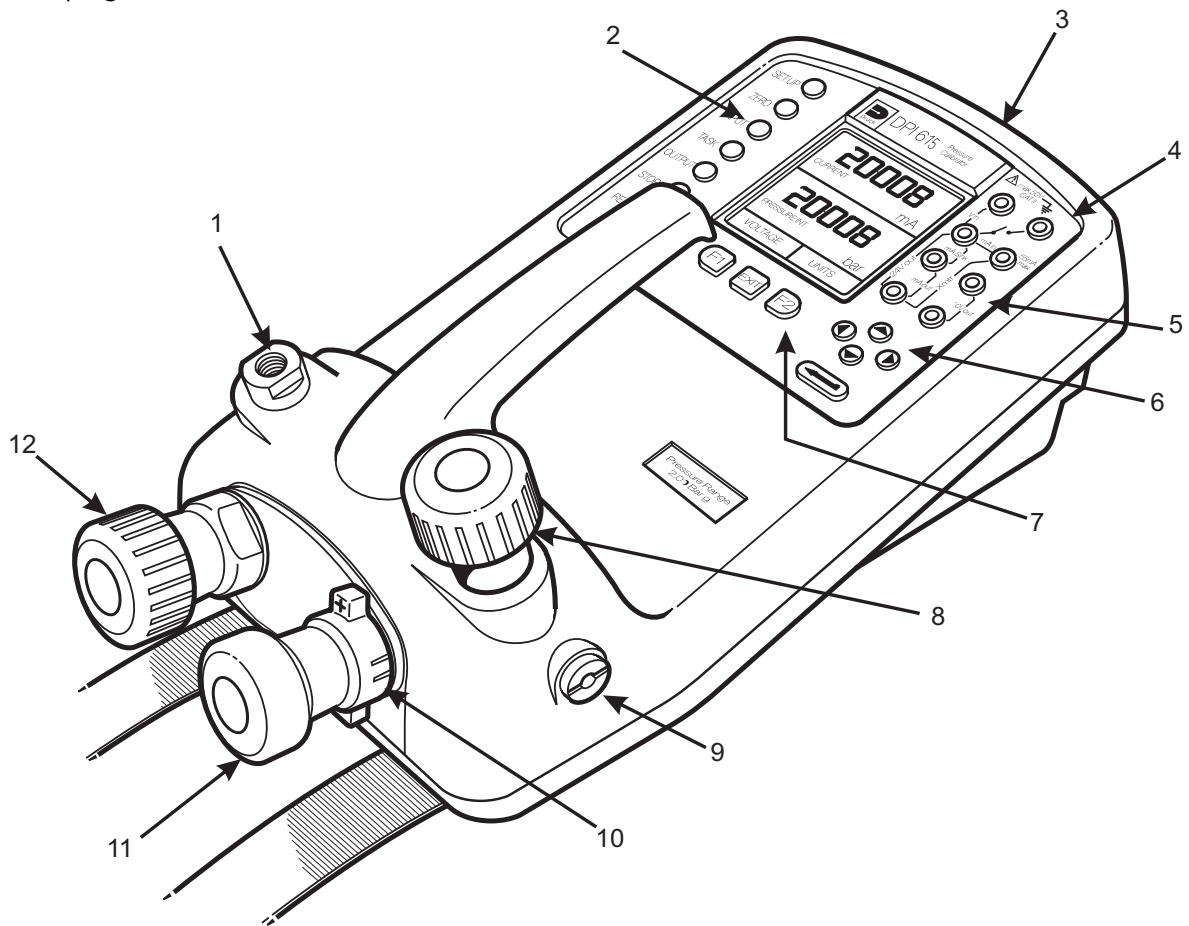

- |   |   |
|---|---|
| 1 Test port, connect to unit under test | 2 Hard keys                                   |
| 3 Cover (external interfaces)           | 4 Electrical inputs                           |
| 5 Electrical outputs                    | 6 Cursor keys                                 |
| 7 Function (soft) keys                  | 8 Release valve (releases pressure through 9) |
| 9 Vent port                             | 10 Select positive or negative pressure       |
| 11 Pump                                 | 12 Fine pressure adjuster                     |

**Figure 2 - DPI 610/615 Calibrator Controls**

# INTRODUCTION

# Summary of Functions

## ELECTRICAL CONNECTIONS

- 1 Cover, closed when not using connectors
- 2 External transducer
- 3 RS232 connector
- 4 Temperature sensor
- 5 DC power input

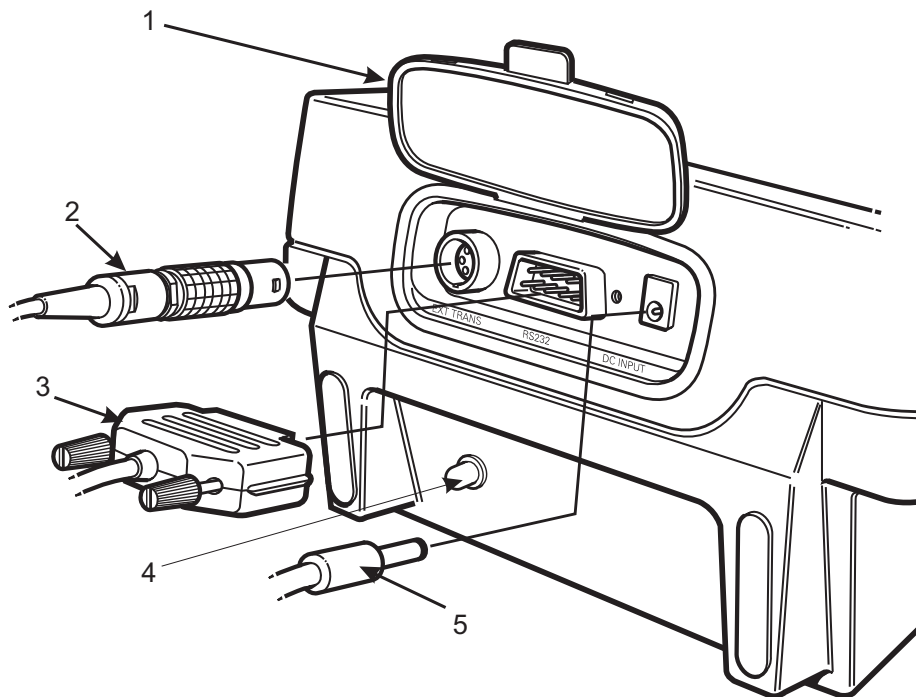

**Figure 3 - Electrical System Connections**

Measurement inputs and Source outputs are made via the control panel sockets as shown below.

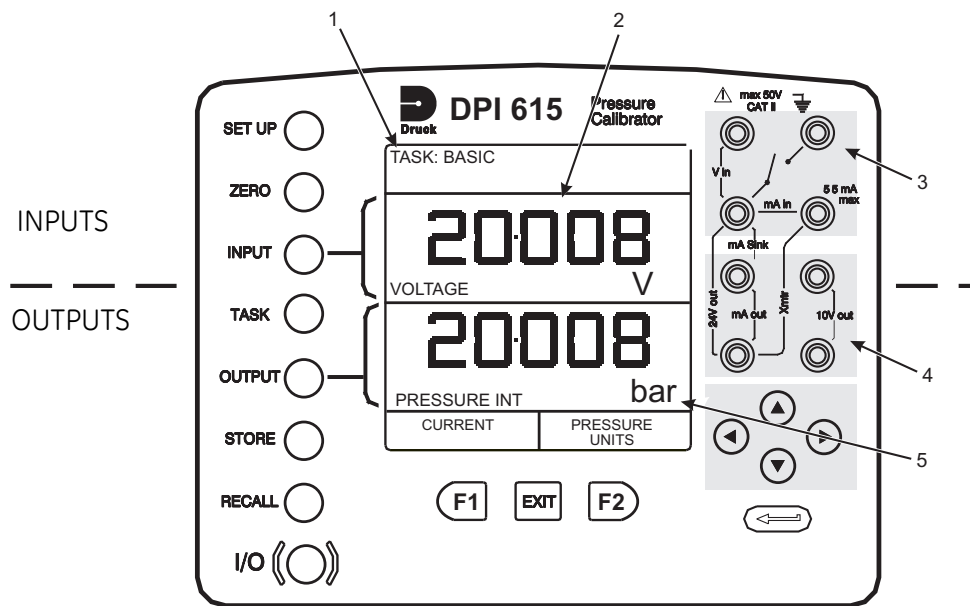

- 1 Status display
- 2 Input display
- 3 Electrical input sockets
- 4 Electrical output sockets
- 5 Output display

**Figure 4 - Electrical Measurement Inputs/Outputs**



# Getting Started

## Fitting Batteries

- 1 Cover fixing screws.
- 2 Rechargeable NiCad pack Part no. 191-126
- 3 Six alkaline C-cells Type no. LR14.

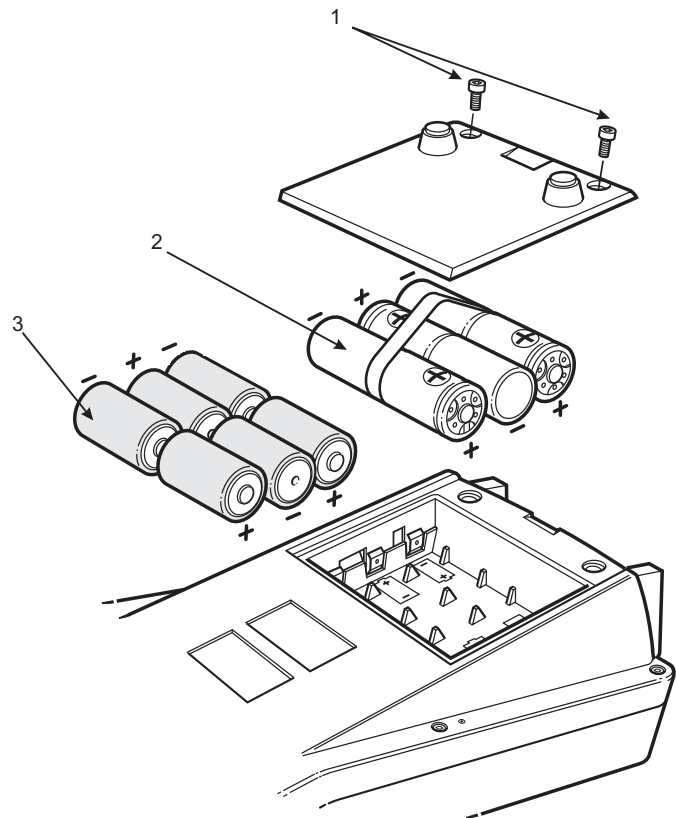

**Caution:** Old batteries can leak and cause corrosion. Never leave discharged batteries in the instrument.

**Note:** After fitting a rechargeable NiCad battery pack the display may show the battery low indication caused by the battery pack not being fully charged. Use the power adaptor/charger to fully charge the pack.

## Switching On

Press the **I/O** switch on the front panel and proceed as follows.

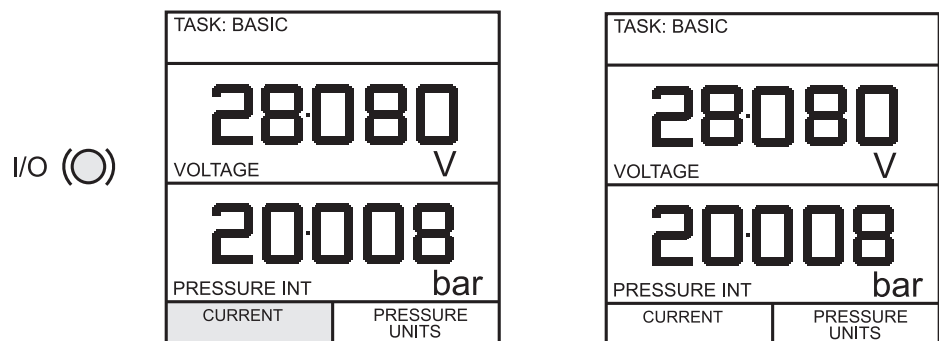

The first time the instrument powers up, it will be in **BASIC** mode with the main screen displaying voltage in the input display area and pressure in the output display area. To switch to **CURRENT** as input, press **F1** as shown. Similarly, **F1** to return to **VOLTAGE**.

**Note:** No other keys are active in this mode and the instrument can only be reconfigured by pressing the **TASK** key and selecting another mode.

# Getting Started

## Change Pressure Units

To change the pressure units proceed as follows. If the four units displayed are not the units required, press **TASK** and select any task, other than **BASIC**, press **SETUP** and proceed as detailed on page 37. To return to **BASIC** mode, press **TASK** and select **BASIC**.

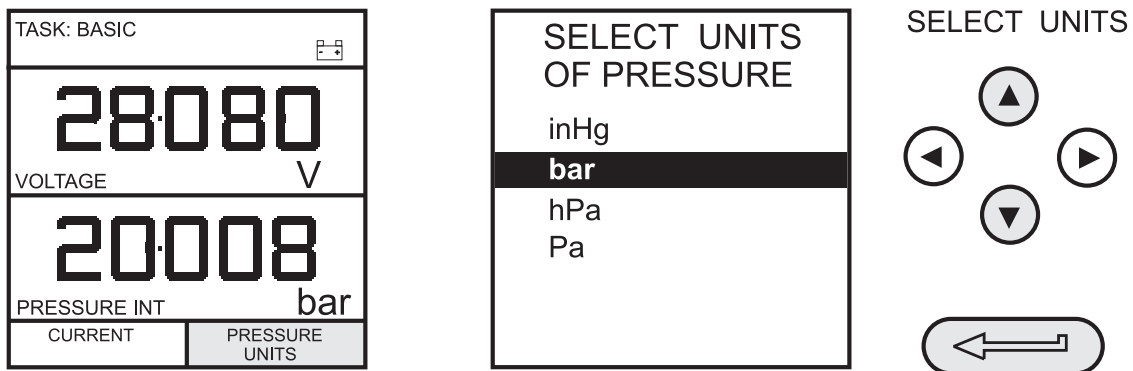

In **BASIC** mode, the instrument is configured to carry out basic Pressure to Voltage (**P to V**) or Pressure to Current (**P to I**) tests, a typical test procedure follows.

## Voltage and Current Measurement

Connect the electrical input sockets as follows for voltage and current measurements. Use the test leads provided and **DO NOT** push bare wires into the sockets.

**Note:** Maximum applied voltage = 50V dc., Maximum input current = 55mA dc

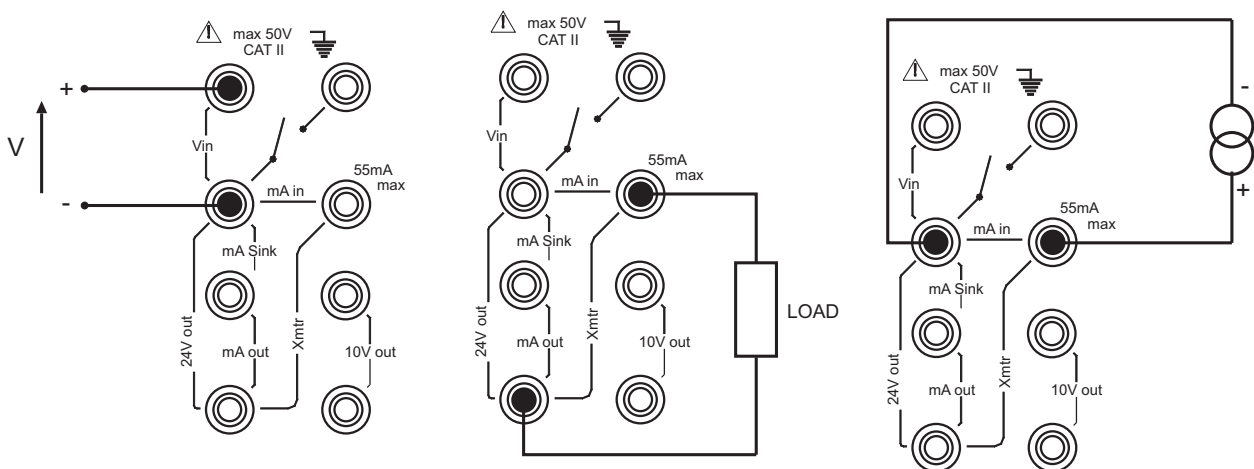

**Note:** Maximum applied voltage for external loop supply = 30V dc

# Getting Started

## Typical Calibration Set-up (Pressure to Voltage)

Connect a device under test to the instrument as shown below:

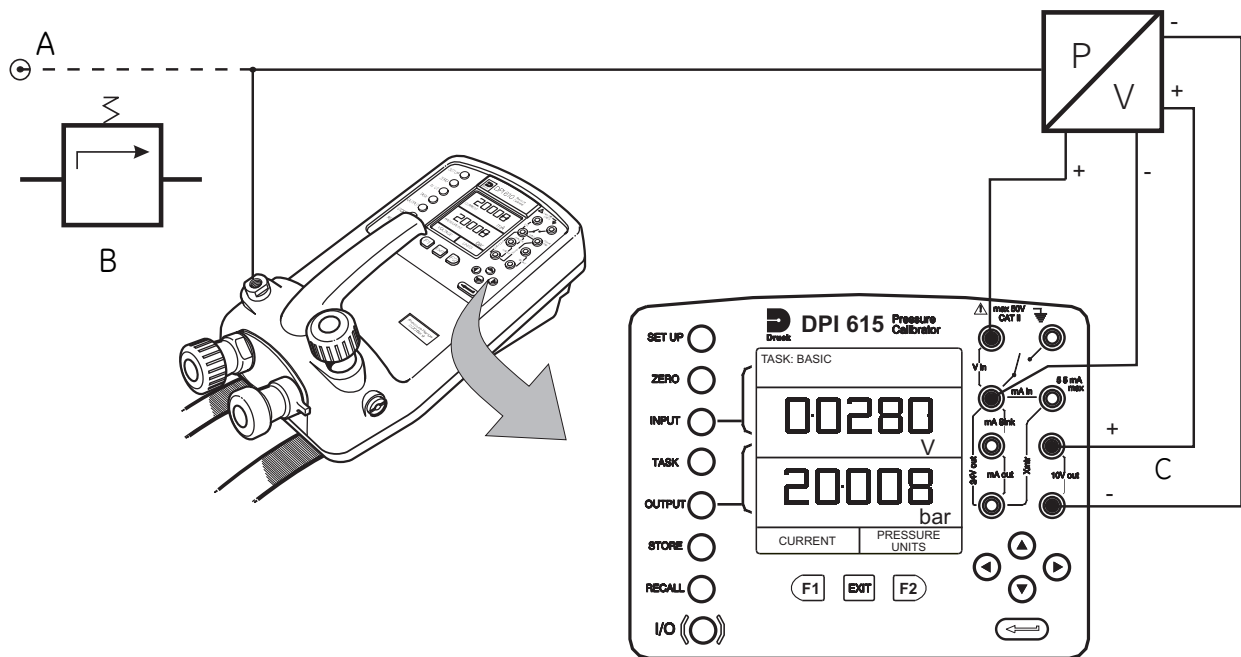

A - External pressure source (indicator instruments only)    B - Pressure regulator  
C - Excitation 10V

### General procedure

- Use the hand-pump to pressurize the system to the required level as indicated on the display. Allow the display to settle and screw the volume adjuster in or out as a fine adjustment to the required pressure. Record the input (e.g.) **Voltage**, reading at each applied pressure.

### Zero Display Reading

Both the input and output readings can be set to zero using the **ZERO** key and if the displayed reading is within 5% of zero. To zero either the **INPUT** or **OUTPUT** displays, proceed as follows:



# Task Selection

## TASK key

The TASK key is used to set-up the instrument for a number of specific types of test. There are two modes **BASIC** and **ADVANCED** and nine other specific types of test that automatically configure the instrument on selection from the **TASK** menu. The tasks available under the **TASK** menu are held on three pages shown below. To select a task from the menu, press the **TASK** key, position the cursor over the required task and press the **ENTER** key as shown below. Use the right/left cursor keys to switch between pages.

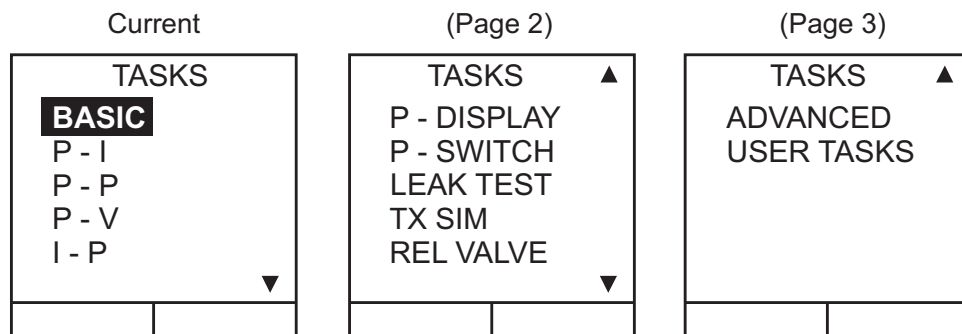

## Using Task Functions

Specific tasks are selected as shown above. The following diagrams show how to connect the unit under test (UUT) for each task selectable under the **TASK** menu.

Input and output units, where applicable, can be selected by pressing either the **INPUT** or **OUTPUT** keys as shown below. The output key also provides the facility of turning the 24V output supply ON and OFF. When not in use, the 24V supply output should be turned OFF to conserve battery power.

## Set Units

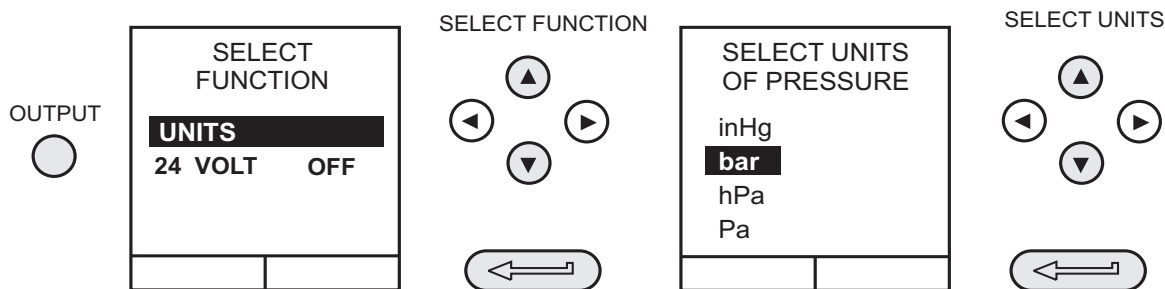

**Note:** If the four units displayed are not the units required, press **SETUP**, select **SETTINGS** and refer to page 38.

## Set 24 Volts

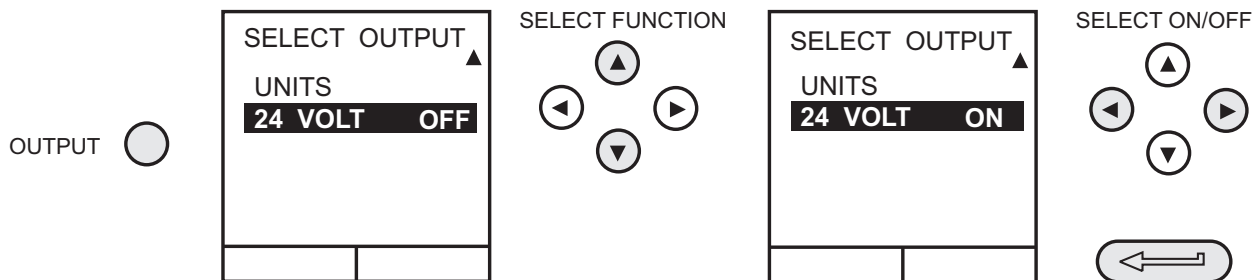

## Task Selection

### Cal mode (DPI 615 versions only)

Cal mode, which is available in tasks P-I, P-P, P-V, P-P, P-DISPLAY and P-SWITCH, provides a method of setting-up test parameters manually. Downloaded test procedures can also automatically set-up and turn on the Cal Mode function. The method of turning on and setting-up Cal Mode is shown below for a P-I task. The method is similar for all the other tasks available in Cal Mode.

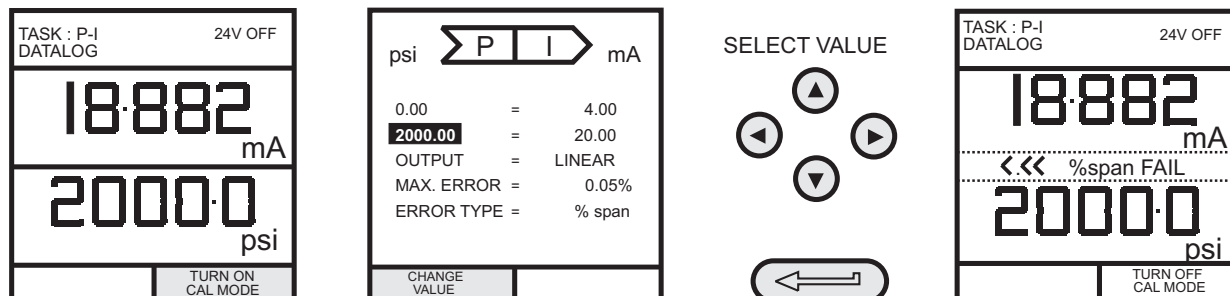

Pressing the F1 key (TURN ON CAL MODE), provides the set-up screen for the CAL mode. Initially, the cursor is placed in the UUT SPAN field to allow the required span range to be entered. The corresponding values for the UUT output parameter (current) are then set, followed by the maximum error value and error type (% rdg or % span). When all test parameters have been set-up, the screen changes to display the input and output and the test results. The test result can only be displayed to within a range of  $\pm 9.99\%$ . If the test result is outside this range, either the left pointing (-ve error) or right pointing (+ve error) chevrons are displayed. Within this error band, the actual tolerance value is displayed. Test results can either be stored as snapshots or logged as datalog files, depending upon how the instrument has been set-up.

### Basic Mode (Task BASIC)

This instrument powers up in this mode the first time that it is used. To select **BASIC** from any other task, press the **TASK** key and select **BASIC** and press the **ENTER** key. **BASIC** mode is fully described in the **Getting Started**, section (see page 7).

# Taking Measurements

## Pressure Transmitter (P-I) Task

Select the P-I task from the task menu and connect the Unit Under Test (UUT) to the calibrator as shown below.

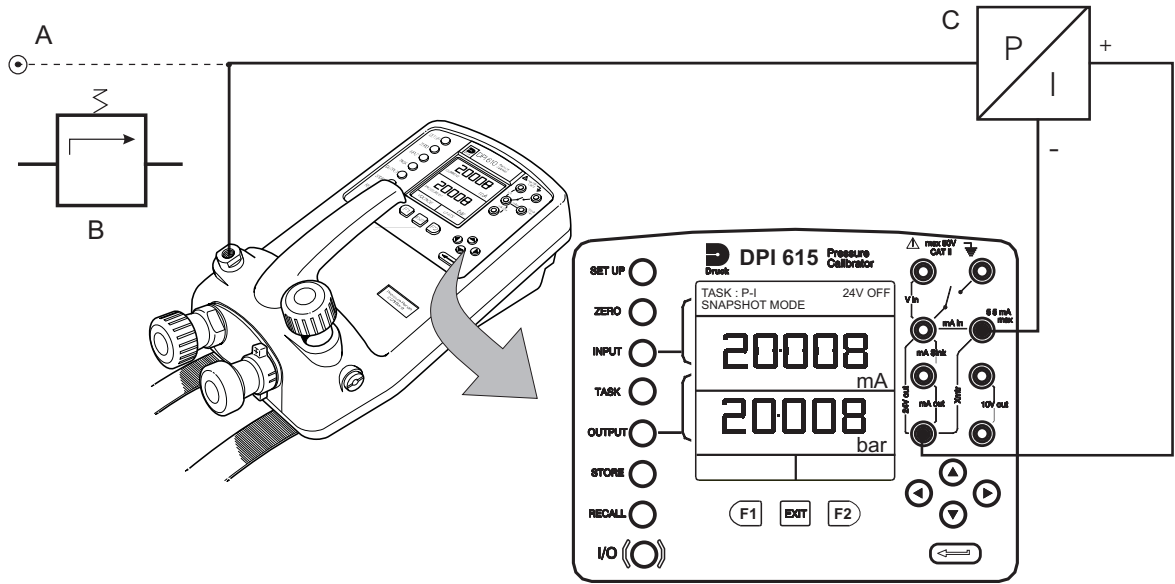

A - External pressure source (indicator instruments only)      B - Pressure regulator  
 C - Pressure to current 24V device

- If required, select the output units as described on page 10.
- If applicable, turn on Cal Mode and set-up test parameters as detailed on page 11.

## Voltage Output Pressure Transmitter (P-V) Task

Select the P-V task from the task menu and connect the UUT to the calibrator as shown below. Voltage output transducers with a 10 V supply and outputs of  $\pm 10$  V can be calibrated using the 10V output sockets (supply) and the transducer output connected to a voltmeter (refer to Method on page 13 for a test procedure).

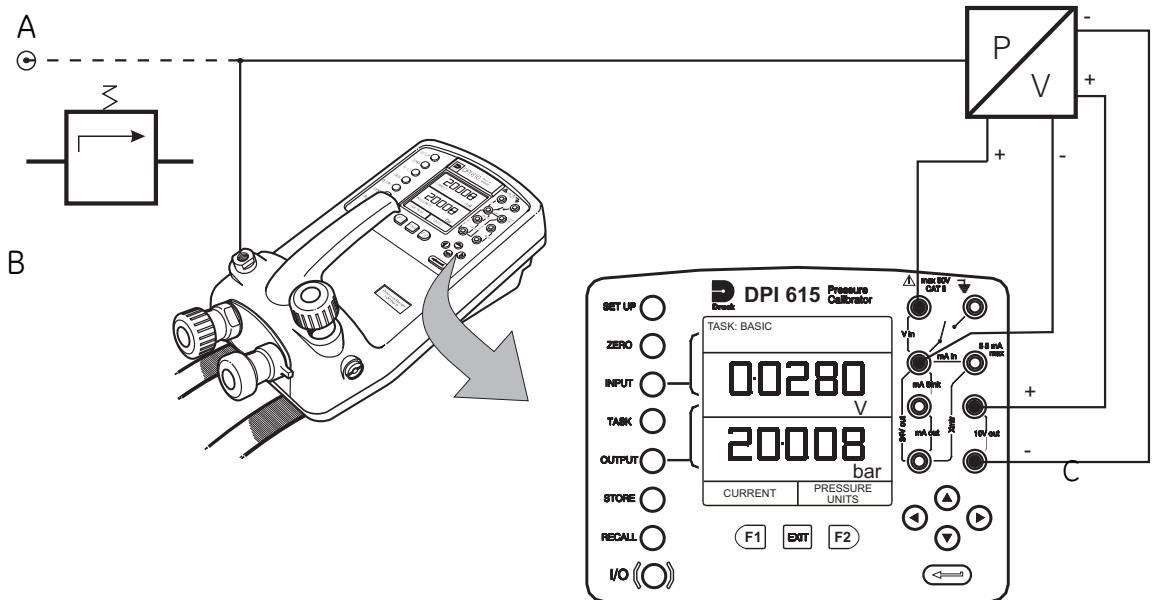

A - External pressure source (indicator instruments only)      B - Pressure regulator  
 C - Excitation 10V

- If required, select the output units as described on page 10.
- If applicable, turn on Cal Mode and set-up test parameters as detailed on page 11.

# Taking Measurements

## Pressure Converter (Pressure to Pressure) Task

Select the P-P task from the task menu and connect the UUT to the calibrator as shown below. Testing a converter requires one pressure to be applied to the unit under test (UUT) and another (converter output) to be measured. The additional measurement is provided by the external transducer option.

### Method

- Connect the UUT to the calibrator and plug the external transducer into the calibrator as shown below.

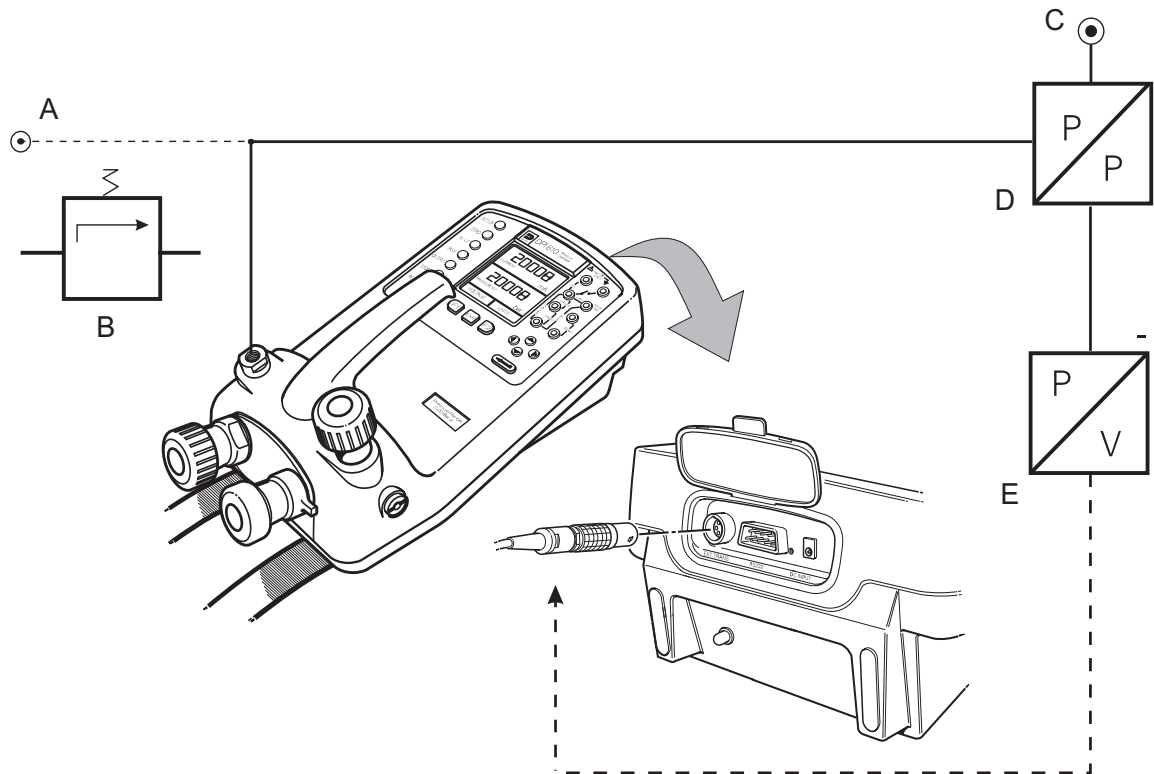

A - External pressure source (indicator instruments only)

B - Pressure regulator

D - Pressure to pressure device

C - External pressure supply

E - External transducer

- Press the TASK key and select the P-P task. Providing the external transducer has been calibrated and its parameters stored in the calibrator, the display shows **External** pressure in the input window and calibrator **Output** pressure in the output window. If an error message "NO SENSOR OR CAL INVALID" is displayed, this indicates that the external transducer has not been entered and/or calibrated with the calibrator. Refer to page 45 for details of adding an external transducer. **If an external transducer change is made, switch the calibrator off and then on to load new transducer data.**

- If required, select the input and output units as described on page 10.

- If applicable, turn on Cal Mode and set-up test parameters as detailed on page 11.

**Note:** Match pressure ranges to give required accuracy and avoid overpressure. If external pressure is required as the output and internal pressure the input, use **ADVANCED** mode for this set-up.

# Taking Measurements

## Current to Pressure Converter (I-P) Task

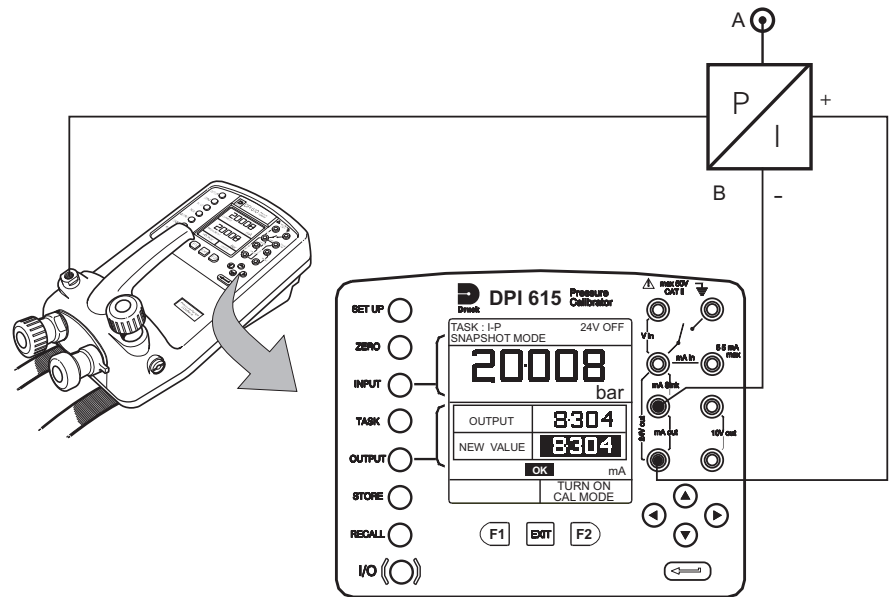

A - External pressure supply                      B - Pressure to current device (24V)

- Use the **up** ▲ and **down** ▼ cursor keys to adjust the loop current to the required value. Alternatively, press **ENTER** and use cursor keys to enter a finite value. Cursor keys can then be used to nudge the output either up or down. If required, change pressure units with INPUT key.

## Pressure Switch Test (P-SWITCH) Task

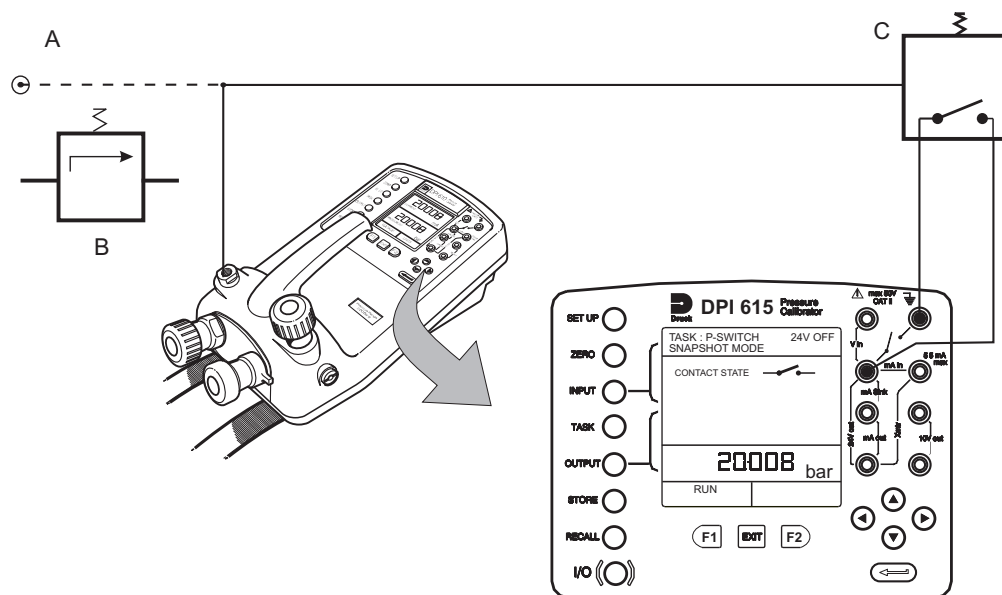

A - External pressure source (indicator instruments only)                      B - Pressure regulator                      C - Pressure switch under test

- Contact state will be shown on display. When contacts close, buzzer sounds.
- To run switch test, close vent valve and press the **RUN** (F1) key.
- Using the hand-pump, increase the applied pressure to just below the switch operating point. Screw the volume adjuster in until the switch operates (the display then shows the operating pressure of the switch).
- Reduce pressure until the switch releases (indicated by the switch symbol). The display then shows the release pressure and the hysteresis value.



# Taking Measurements

## Pressure Switch Testing with Contact Resistance Measurement

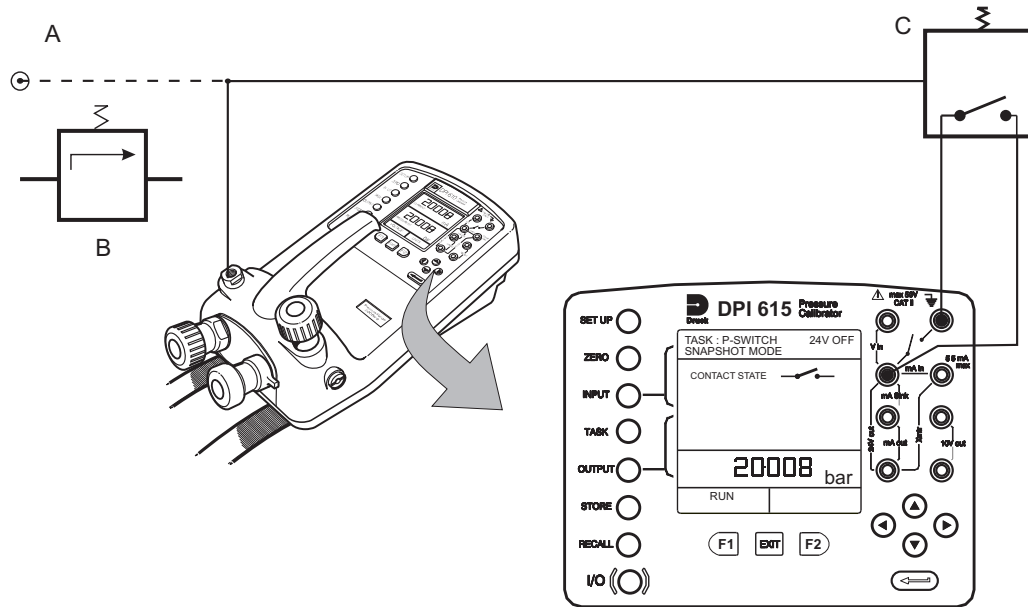

A - External pressure source (indicator instruments only) B - Pressure regulator

C - Pressure switch under test

To perform switch test with contact resistance measurement, select P-SWITCH and proceed as follows:

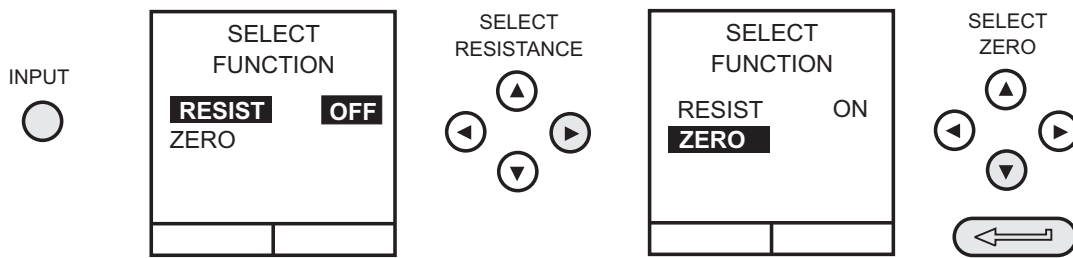

To ensure accurate measurements it is recommended that the zero procedure (that compensates for the resistance of the test leads) is carried out before performing this test.

**Note:** Allow sufficient time after contact closure for the resistance to stabilize.

<p>Connect Vin +, SW + and mA in + together.</p> <p>Connect switch test leads across switch symbol.</p> <p><b>Open circuit test leads</b></p> <p>Press ENTER to continue.</p>	<p>Now short test leads.</p> <p>Press ENTER to continue.</p>	<p>Switch Resistance input now ready for use.</p> <p>Open circuit test leads.</p> <p>Press ENTER to continue.</p>	<table border="1"> <tr> <td>TASK : P-SWITCH</td> <td>24V OFF</td> </tr> <tr> <td colspan="2">SNAPSHOT MODE</td> </tr> <tr> <td colspan="2">CONTACT STATE </td> </tr> <tr> <td colspan="2" style="text-align: center;"><b>20008</b> bar</td> </tr> <tr> <td>RUN</td> <td></td> </tr> </table>	TASK : P-SWITCH	24V OFF	SNAPSHOT MODE		CONTACT STATE		<b>20008</b> bar		RUN	
TASK : P-SWITCH	24V OFF												
SNAPSHOT MODE													
CONTACT STATE													
<b>20008</b> bar													
RUN													

The switch test is performed in the same way as the previous section, except that the contact resistance is measured and displayed with the results.

TASK : P-SWITCH	24V OFF
SNAPSHOT MODE	
CONTACT STATE	
CLOSED AT	15.060 bar
OPENED AT	14.059 bar
HYSTERESIS	1.001 bar
RESISTANCE	3 mΩ
<b>8002</b> bar	
RUN	

# Taking Measurements

## Pressure to Display (P - Display) Task

P-Display is a special application of Datalog. To use this mode, select Datalog from the Store Mode menu as detailed on page 37. Connect the UUT to the instrument as shown below and, if required, turn on and set-up Cal Mode (see page 11).

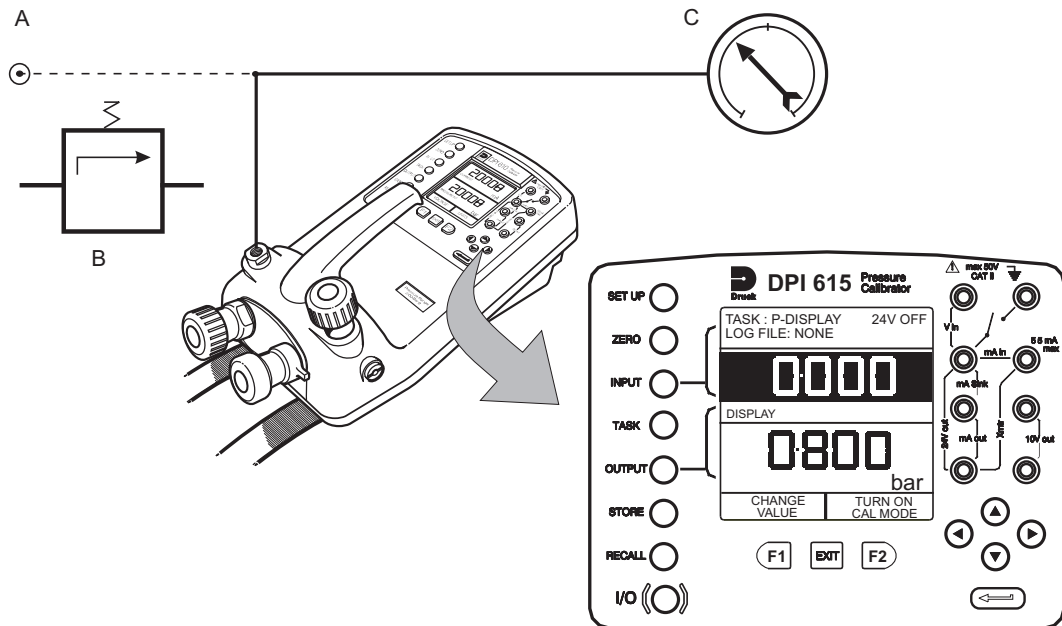

A - External pressure source (indicator instruments only)    B - Pressure regulator  
C - Dial gauge under test

- Press **TASK** and select **P-DISPLAY**. If required, use **OUTPUT** key to change pressure units.
- Set-up a data log file as detailed on page 31.

**Note:** *TRIGGER* field, automatically set to **KEYPRESS**, cannot be changed.

- Apply a series of test pressures to the device under test. Enter displayed reading at each pressure and log each point:

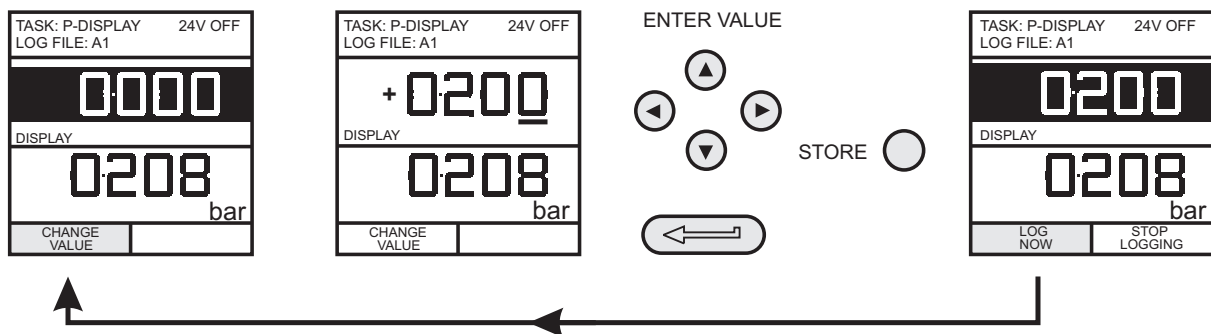

- After logging final test point, terminate as follows:

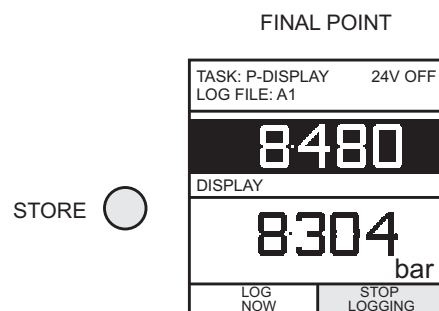

# Taking Measurements

## Leak Test (LEAK TEST) Task

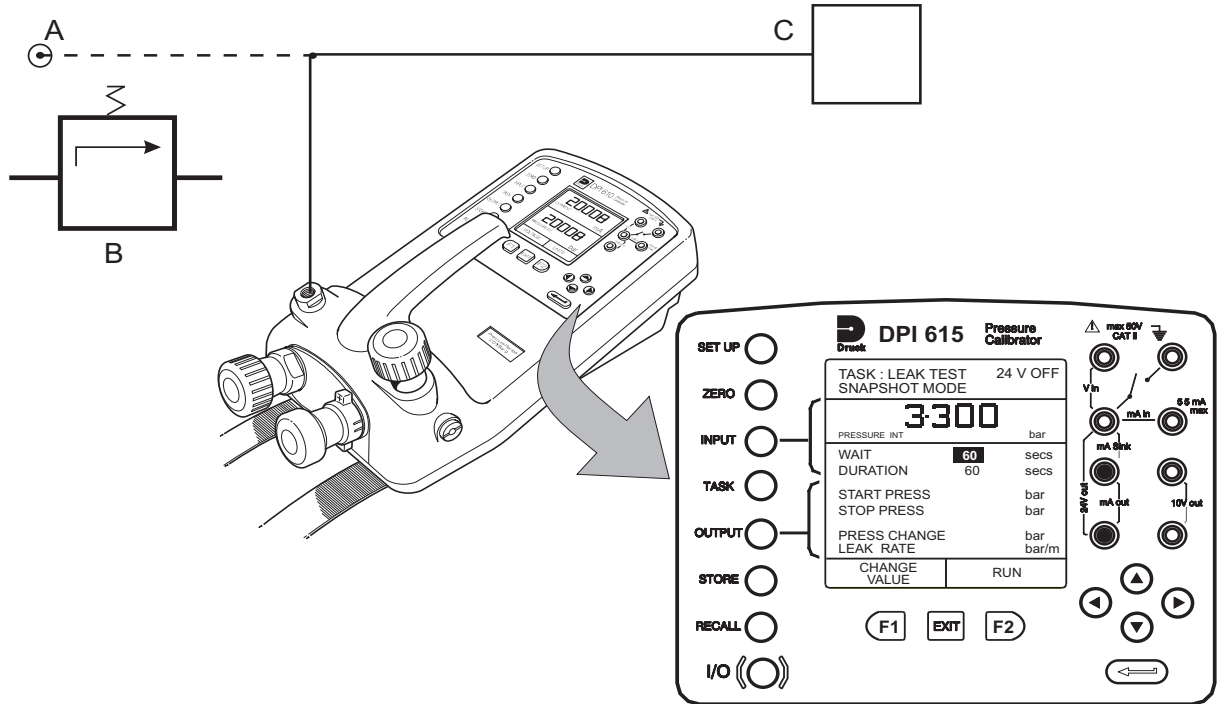

A - External pressure source (indicator instruments only)      B - Pressure regulator  
 C - Unit/system under test

- If required, use the **INPUT** key to change pressure units.
- Set-up the leak test **WAIT** and **DURATION** times to the required values as shown below. Recommended minimum wait period - 3 minutes.

TASK : LEAK TEST		24 V OFF	
SNAPSHOT MODE			
PRESSURE INT		0.304 bar	
WAIT	180	secs	
DURATION	60	secs	
START PRESS		bar	
STOP PRESS		bar	
PRESS CHANGE		bar	
LEAK RATE		bar/m	
CHANGE VALUE	RUN		

SET WAIT TIME

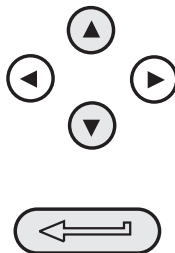

TASK : LEAK TEST		24 V OFF	
SNAPSHOT MODE			
PRESSURE INT		0.304 bar	
WAIT	180	secs	
DURATION	60	secs	
START PRESS		bar	
STOP PRESS		bar	
PRESS CHANGE		bar	
LEAK RATE		bar/m	
CHANGE VALUE	RUN		

SET DURATION

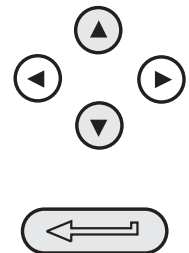

- Close the vent valve and pressurize the unit/system to the required **LEAK TEST** pressure.
- Press the **RUN (F2)** key to start the leak test. When completed, the beeper sounds and the leak test results are written to the display.

# Taking Measurements

## Transmitter Simulation (TX SIM) Task

Provides a current output proportional to the calibrator's measured output pressure (indicated pressure on indicator only version). Select task **TX SIM**. Press **EXIT** to skip set-up screen if parameters are correct.

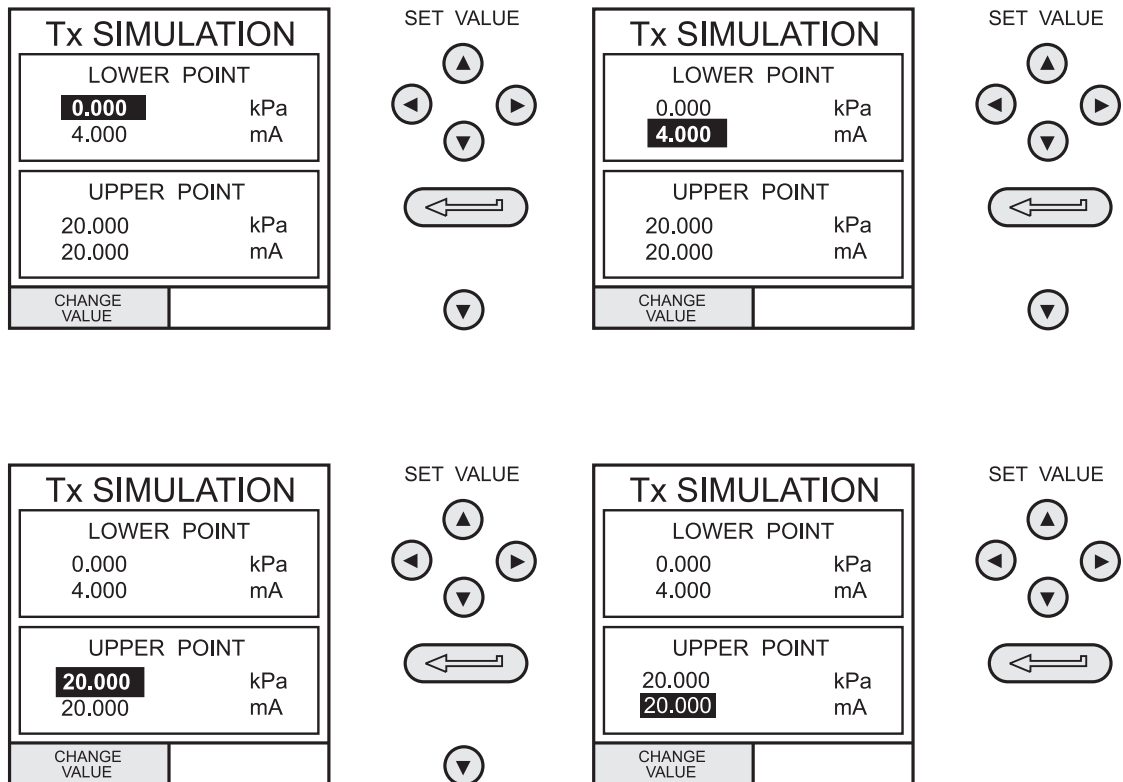

On completion of **TX SIM** set-up, the display is configured as follows:

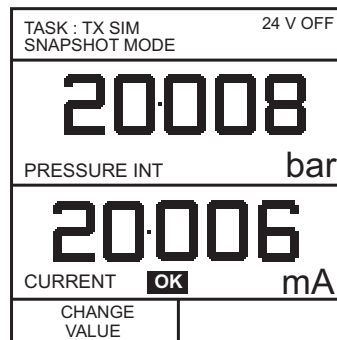

Set-up the output loop as detailed on page 25 and, if necessary, turn on the internal electrical supply.

To subsequently change any of the **TX SIM** scaling parameters, press **CHANGE VALUE** (F1) to obtain the TX Simulation display.

To change the pressure units, press **INPUT** and select the required scale units. If the required scale units are not listed, press **SETUP**, select **SETTINGS** and proceed as detailed on page 38.

# Taking Measurements

## Relief Valve Test (REL VALVE) Task

To carry out a relief valve test, press **TASK** and select **REL VALVE**. Connect the output pressure port of the instrument to an external system as shown below:

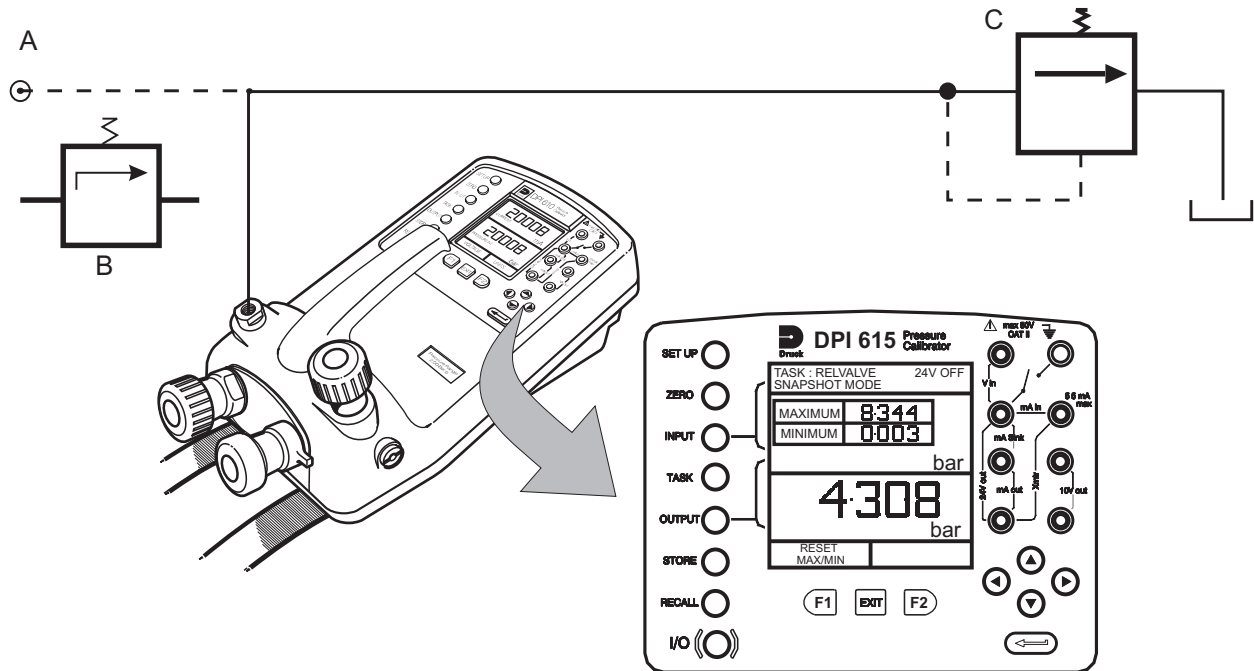

A - External pressure source (indicator instruments only)    B - Pressure regulator  
C - Relief valve under test

- To change the pressure units, if required, press **INPUT** and select the required units using the cursor keys.
- If necessary, turn on the 24 Volt internal supply by pressing **OUTPUT**, select **24 VOLT** and switch **ON** with the right cursor button and press **ENTER**.
- Close the vent valve and, using the hand-pump or external pressure supply, apply pressure to the relief valve under test.
- When the relief valve operates, the maximum recorded pressure indicates the operating point of the valve.

**Note:** The **STORE** key can be used for this purpose. Use right cursor key initially, followed by up/down keys to enter Snapshot text).

- Record the test results.
- Open vent valve to release test pressure.

**Note:** If using external pressure supply, isolate supply before opening the vent valve.

## General

Advanced task allows the user to configure the instrument to monitor one of a number of different input measurements and outputs (sources). Additionally, five process functions, Tare, Max/Min, Filter, Flow and % Span can be applied to the input functions.

## Select Input

To display an input channel, select **ADVANCED** task from the task menu. The display shows the list of the input selections and, if available, the **PROCESS** soft box (F1) and the **UNITS** soft box (F2).

The following procedure shows the method of input channel selection and the method of changing units:

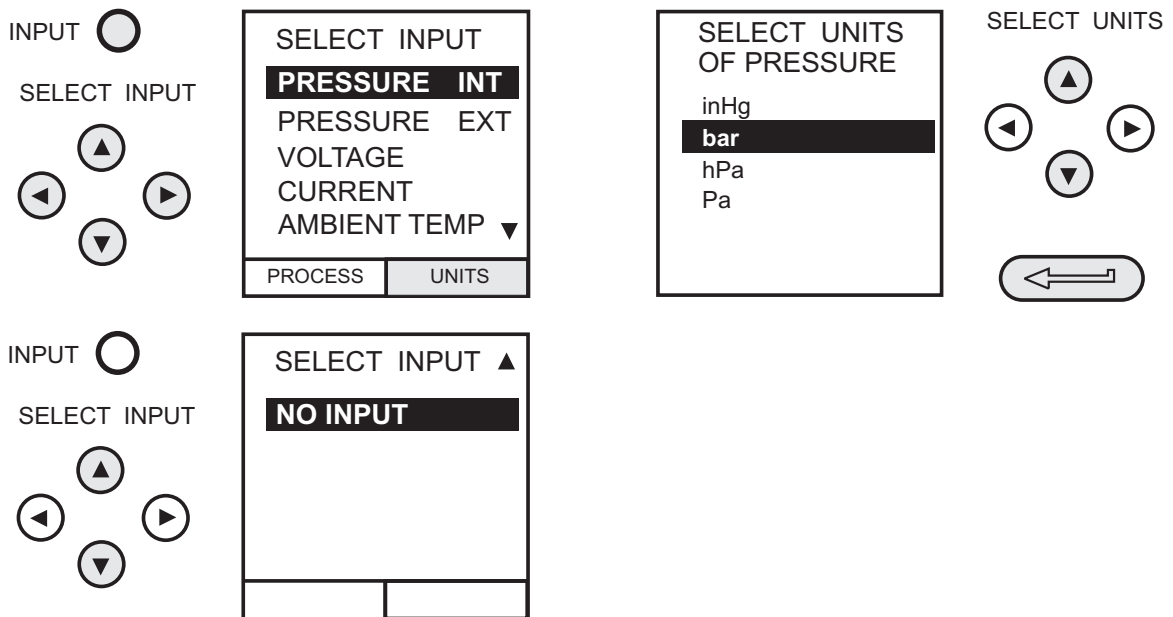

**Note:** Left/right arrow keys function as page up/down keys.

Refer to pages 21 to 24 for details of process functions.

## Ambient Temperature Measurement

To set-up the instrument to read ambient temperature, proceed as follows:

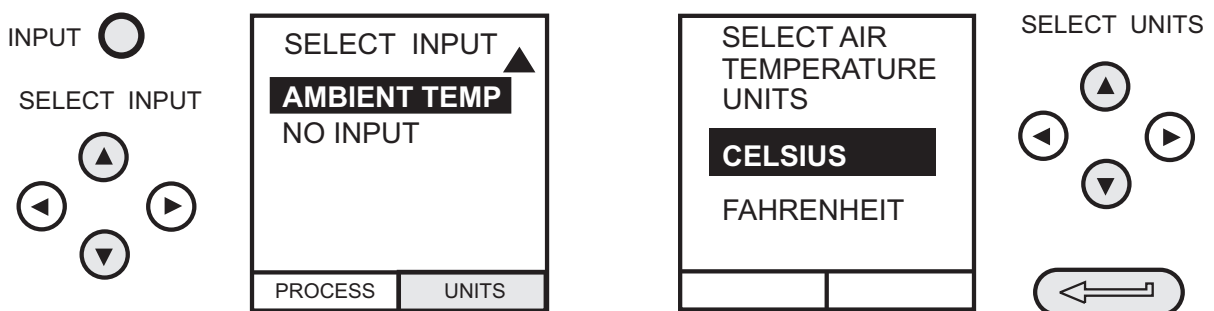

**Note:** Make sure the temperature reading has stabilized.

## Process Functions

If required, the following process functions are available on the input display but **only** in **ADVANCED** task. If the instrument is in any other mode i.e. BASIC or any other task mode, the input and output displays must first be configured in **ADVANCED** task.

**Note:** *PROCESS functions are not available to the output channel.*

A summary of the process functions follows:

- Tare** Allows either the current display value or a manually entered value to be tared off display parameter reading.
- Max/Min** Displays running Max/Min and present display values simultaneously. Resettable via F1 key.
- Filter** Applies low pass filter function to displayed parameter. Filter characteristics (*Settling time and Band*) are user programmable.
- Flow** Applies square root function to displayed parameter.
- % Span** Converts displayed parameter reading to a percentage of span. Span definable via the F1 key.

Following selection of **ADVANCED** from the task menu, press the **INPUT** key. Use the **up** ▲ or **down** ▼ cursor keys to select the required input. Press the **PROCESS** (F1) key and use the **left** ◀ or **right** ▶ cursor keys to enable the process on/off:

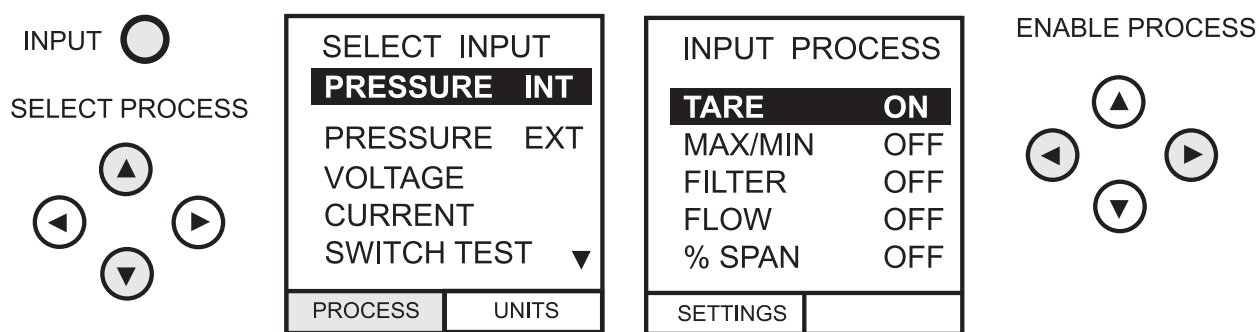

Press **ENTER** to switch the process ON with existing settings or F1 to change process settings (where applicable).

## Tare Process Function

To set-up a Tare function, enable **TARE** from the process menu and press F1 to enter the Tare **SETTINGS** functions.

Disable **TARE** by entering process menu and turning the function **OFF**.

**Note:** Last TARE setting is retained and will be applied when function is next enabled.

**Tare Current Input Reading** To tare off the current display reading, proceed as follows:

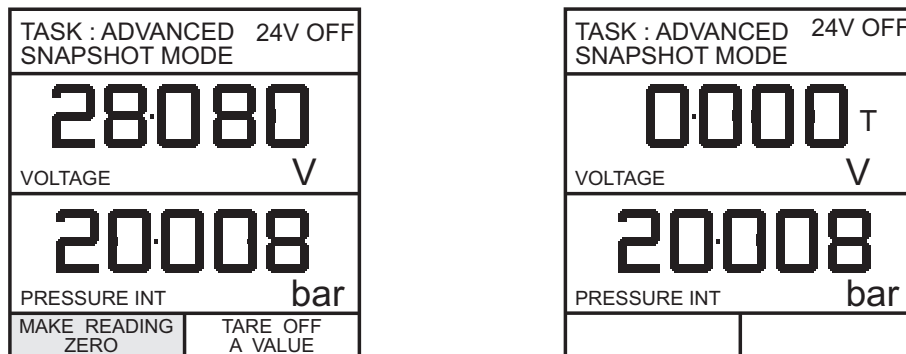

**Tare Off An Entered Value** To tare off an entered value, proceed as follows:

**Note:** Display shows the last entered Tare value.

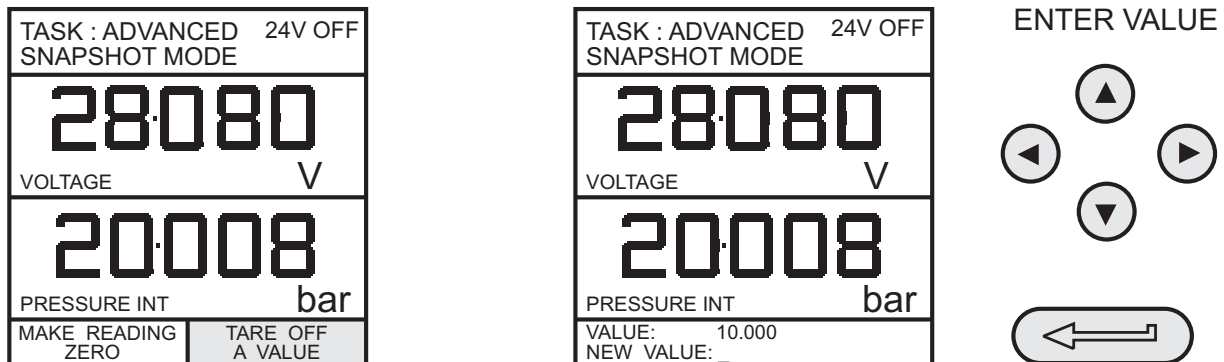



## Max/Min Process Function

To set-up an input display to show max/min and present input reading, enable MAX/MIN from the process menu and press F1 (SETTINGS) to provide **RESET** function. The display now shows the max/min values as follows:

TASK : ADVANCED 24V OFF	
SNAPSHOT MODE	
MAXIMUM	8304
PRESENT	4.308
MINIMUM	0003
VOLTAGE <span style="float: right;">V</span>	
<b>8.304</b>	
PRESSURE INT <span style="float: right;">bar</span>	
RESET	
MAX/MIN	

Reset Max/Min display at any time by pressing the F1 key.

To quit max/min, press **INPUT**, select **MAX/MIN** from process menu and switch the function off.

## Filter Process Function

To apply the low pass filter to a selected input, enable **FILTER** from the process menu and press F1 (SETTINGS) to provide access to the filter parameters. Two settings are required, *Time to Settle* and *Band*.

To examine the current filter settings and exit without change, press the **EXIT** key.

The set-up procedure is as follows:

<b>SET FILTER</b>	
TIME TO SETTLE	
TIME =	<b>2</b> Seconds
BAND = MAX AMPLITUDE OF NOISE TO BE FILTERED, CHANGES GREATER THAN BAND BYPASS THE FILTER	
BAND =	1.5 % FS
CHANGE VALUE	

SELECT VALUE

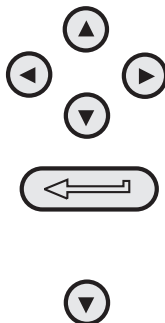

<b>SET FILTER</b>	
TIME TO SETTLE	
TIME =	2 Seconds
BAND = MAX AMPLITUDE OF NOISE TO BE FILTERED, CHANGES GREATER THAN BAND BYPASS THE FILTER	
BAND =	<b>1.5</b> % FS
CHANGE VALUE	

SELECT VALUE

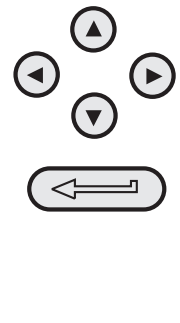

## Flow Function

To apply the flow function to a selected input, enable **FLOW** from the process menu and press **ENTER**. The square root symbol is displayed beside the input value to indicate that the **FLOW** function is active:

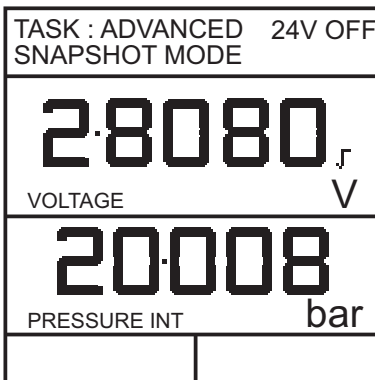

To cancel **FLOW**, press **INPUT** and turn function OFF at the process menu.

## %Span

To convert a selected input display from a numerical value to a percentage of full-scale reading, enable **SPAN** from the process menu and press F1 (SETTINGS) to provide access to the span definition parameters. Two span definitions are required, **Zero** and **Full Scale**.

To leave span at current setting, press **EXIT**.

To define zero and full-scale settings, proceed as follows:

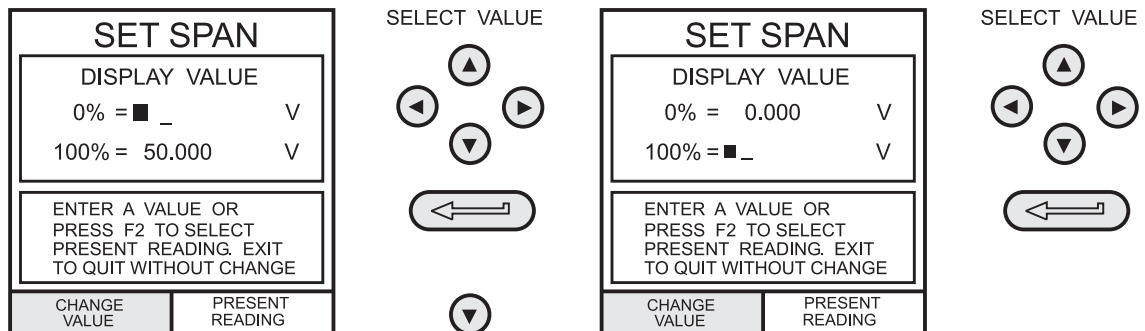

To cancel **%SPAN**, press **INPUT** and turn function OFF at the process menu.

## Select Output

To display an output channel, select **ADVANCED** mode from the task menu. The display shows the list of output selections and, if available, the **UNITS** soft box (F2).

The following procedure shows the method of output channel selection from two pages of options. The second page can be obtained directly from the first by pressing the **right**

▶ cursor key:

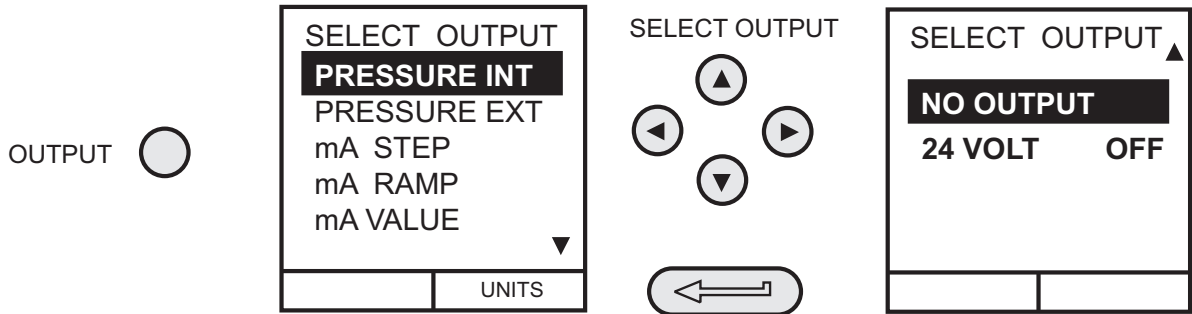

**Note:** Left ◀ and right ▶ keys function as page up/down keys.

To change the output units (*pressure channels only*), select the channel with the cursor keys and press F2 before pressing **ENTER**.

## Electrical Outputs (Loop Power)

For all the electrical outputs, the output loop can be powered either by the instrument's internal 24V supply (sourcing) or alternatively, from an external supply (current sinking). To conserve battery power, the 24V internal supply should be switched off (even when not being used to power an external loop).

External connections to the front panel of the instrument are shown below for both sourcing and sinking applications:

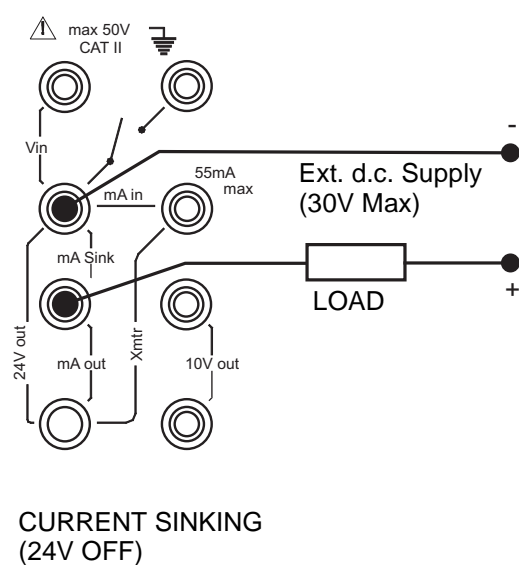
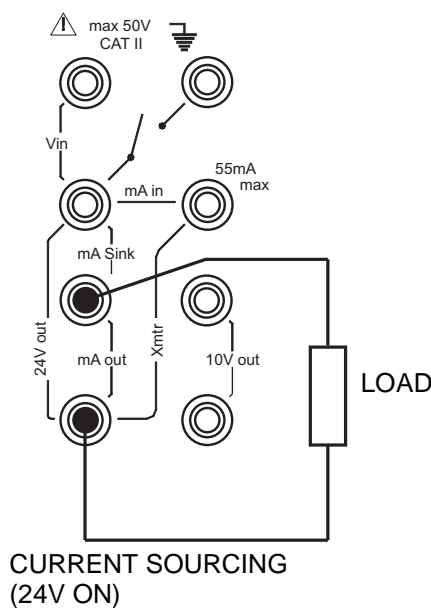

## mA Step

To select one of the electrical output programs, press the **OUTPUT** key and proceed as follows:

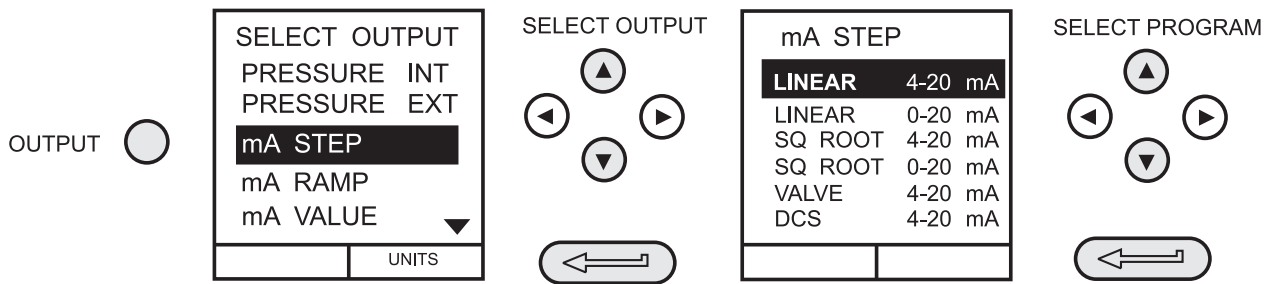

On selection of (e.g.) Linear, the output display window changes to show the selected program of output currents:

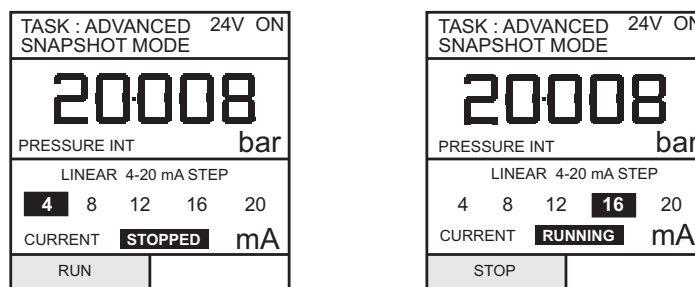

- For current sourcing applications, turn on the 24V supply as shown on page 28. For current sinking applications, connect an external supply as shown on page 25 and leave the 24V supply switched **OFF**.
- Press **RUN** (F1) to run program. A flashing status display **CHECK LOOP** indicates a fault in the external loop i.e. supply fault or open circuit.  
**Note:** *The dwell time at each step is approximately 10 seconds.*
- Press **STOP** (F1) when running to stop at any point. Press **RUN** (F1) to resume.

## mA Ramp

Press the **OUTPUT** key and select **mA RAMP** as shown previously in mA Step.

- Define ramp required by entering **START** and **END** current values as shown below:

TASK : ADVANCED 24V OFF SNAPSHOT MODE	
8.304	
PRESSURE INT bar	
START	4000
OUTPUT	0.000
END	20000
CURRENT	STOPPED mA
START	

ENTER VALUE

TASK : ADVANCED 24V OFF SNAPSHOT MODE	
8.304	
PRESSURE INT bar	
START	4000
OUTPUT	0.000
END	20000
CURRENT	STOPPED mA
START	

ENTER VALUE

- For current sourcing applications, turn on the 24V supply as shown on page 28. For current sinking applications, connect an external supply as shown on page 25 and leave the 24V supply switched **OFF**.
- Press **START** (F1) to run the program. A status display **CHECK LOOP** indicates a fault in the external loop i.e. supply fault or open circuit.

**Note:** The ramp cycle (min to max or max to min), is approximately 60 seconds.

TASK : ADVANCED 24V OFF SNAPSHOT MODE	
8.304	
PRESSURE INT bar	
START	4000
OUTPUT	0.000
END	20000
CURRENT	STOPPED mA
START	

ENTER VALUE

TASK : ADVANCED 24V OFF SNAPSHOT MODE	
8.304	
PRESSURE INT bar	
START	4000
OUTPUT	8.334
END	20000
CURRENT	RAMPING mA
STOP	

ENTER VALUE

- Press **STOP** (F1) when running to stop at any point. Press **CONTINUE** (F1) to resume from point of pause or **RESET** (F2) to return to start point.

TASK : ADVANCED 24V OFF SNAPSHOT MODE	
8.304	
PRESSURE INT bar	
START	4000
OUTPUT	0.000
END	20000
CURRENT	STOPPED mA
STOP	

ENTER VALUE

TASK : ADVANCED 24V OFF SNAPSHOT MODE	
8.304	
PRESSURE INT bar	
START	4000
OUTPUT	8.334
END	20000
CURRENT	PAUSED mA
CONTINUE	RESET

ENTER VALUE

## mA Value

Press the **OUTPUT** key and select **mA VALUE** from the output menu. The procedure is shown below:

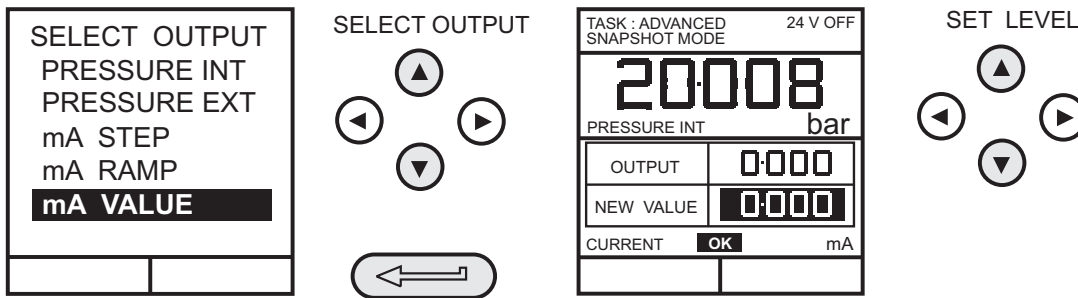

- For current sourcing applications, turn on the 24V supply as shown below. For current sinking applications, connect an external supply as shown on page 25 and leave the 24V supply switched OFF.
- Use **up** ▲ and **down** ▼ cursor keys to adjust output current level. While the loop is made, a status display indicates **OK**. A status display **CHECK LOOP** indicates a fault in the external loop i.e. supply fault or open circuit.

## 24 Volt

Press the **OUTPUT** key and select **24 VOLT** from the Output menu. The procedure is shown below:

**Note:** The 24V selection is located on the second page of output functions.

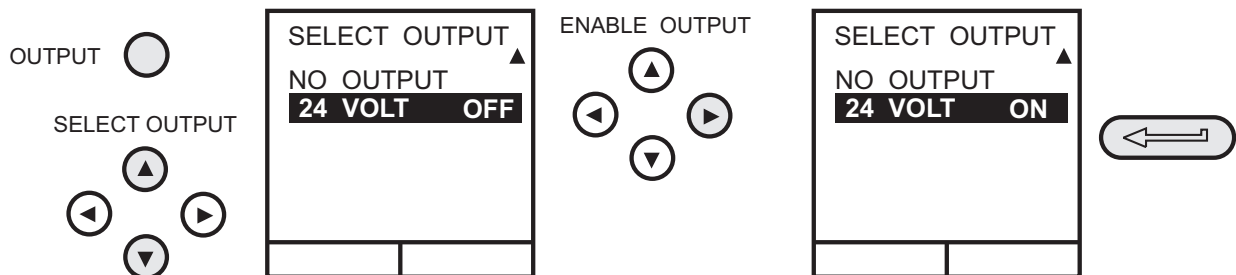

**Note:** To conserve battery power, keep the 24V supply switched off when not in use (even if the output is unloaded).

## Define New Task

To define a new task, proceed as follows.

- Select **ADVANCED** from **TASKS** menu.
- Using the **INPUT** key, select the required input for the input display and set-up any process functions required.
- Using the **OUTPUT** key, select the required output for the output display.
- Press **TASK** and select **free**. Enter new task name as follows:

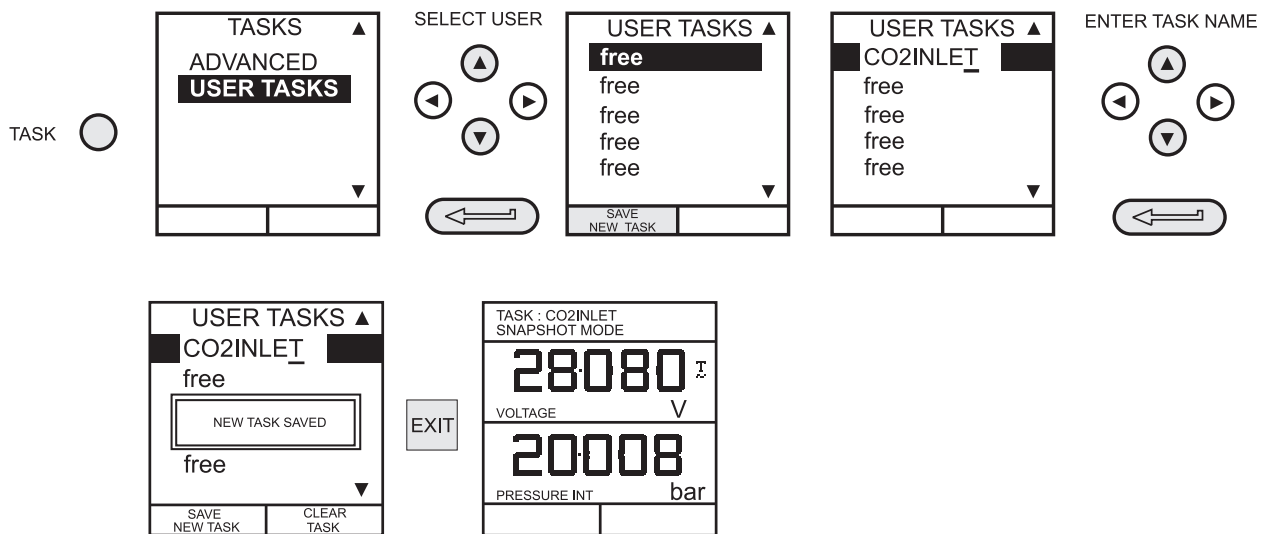

On completion of this procedure, the display reverts to newly set-up task as shown:

## Clear Task

To clear a user defined task, select **TASK** and proceed as follows:

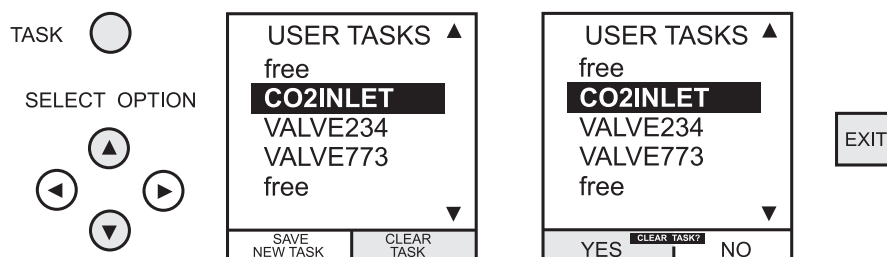

## Saving Display or Data Log

In Store Mode three memory operations can be set-up: **None**, **Snapshot** and **Data Log**. Refer to **Using Setup** for details.

## Store Operations (Screen Snapshots)

To store any display (menu displays excepted), press the **STORE** key. This saves the current display to the next available location. Supporting text (10 characters) may be appended. Twenty memory locations are available on a cyclic buffer. When all 20 have been used, store operations overwrite existing locations, starting at *Location 1*.

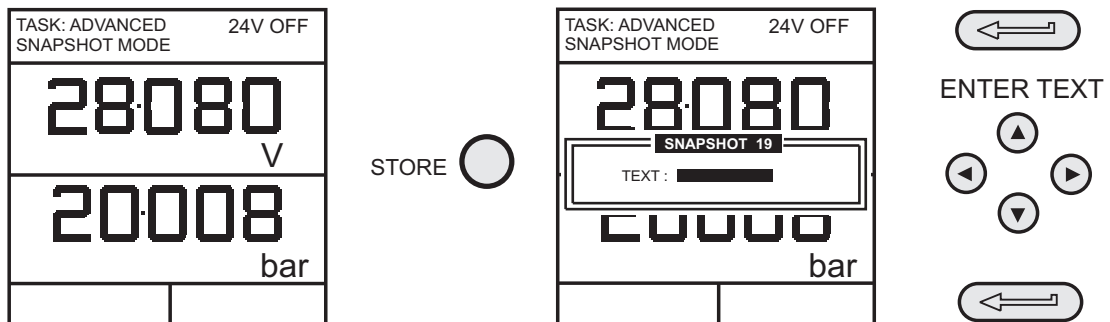

## Recalling Stored Data (Screen Snapshots)

To recall a previously stored display, press the **RECALL** key. This recalls the last display saved. Press the **left** ◀ or **right** ▶ cursor keys to recall the previous or next locations respectively. To exit **RECALL**, press the **EXIT** key:

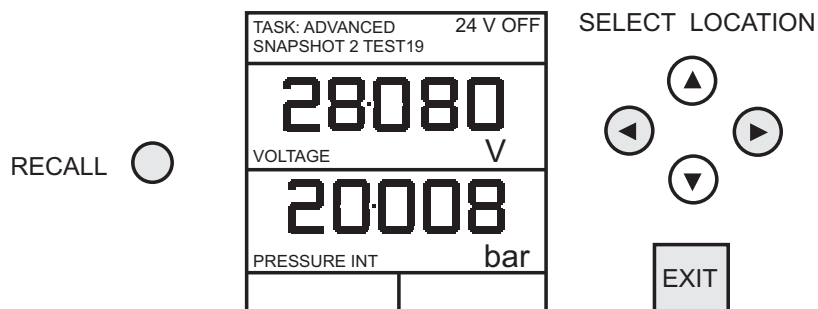



## Data Log Operations

Data Log is a special application of store mode that enables the calibrator to either automatically log displays at preset time intervals or to manually log a display on operation of the **STORE** key. Logged data is written to a user specified file.

To set-up a Data Log file, proceed as follows:

- Select a task, other than **BASIC**. If using **ADVANCED**, set-up required output parameters.
- Use **SETUP** to select Data Log from the Store Mode Menu (see page 37).

### Auto Log (Timer)

Press **STORE** and set up the Data Log file parameters as shown below. Use **CHANGE VALUE** (F1) followed by cursor keys to set field values. For Auto Log, set **TRIGGER** field to **PERIODIC**.

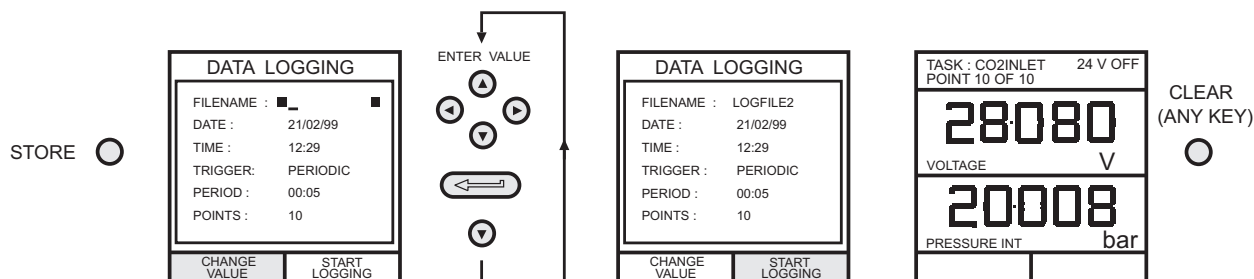

### Manual Logging

Enter the file details as shown above and select **KEYPRESS** for **TRIGGER** field. Screen reverts to displayed parameters showing set-up file as shown below:

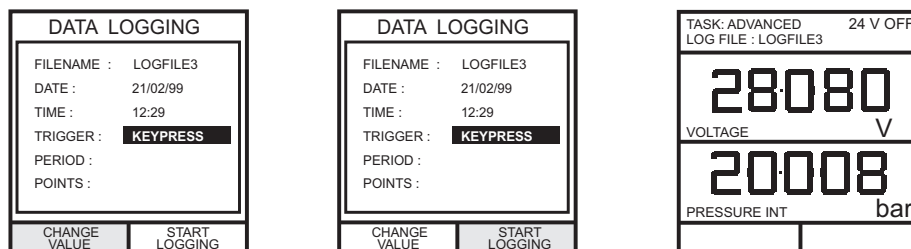

Use a combination of **STORE** and **LOG NOW** (F1) to log events as follows:

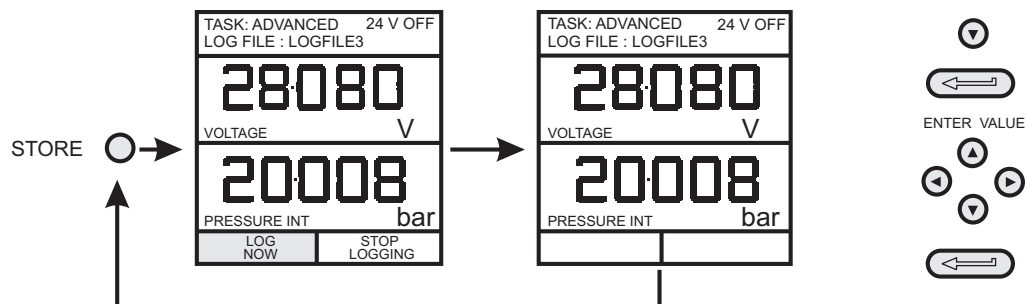

## Recall Data Log Files

To recall a Data Log file to the display, ensure that **DATA LOG** is selected from the SETUP menu and proceed as follows:

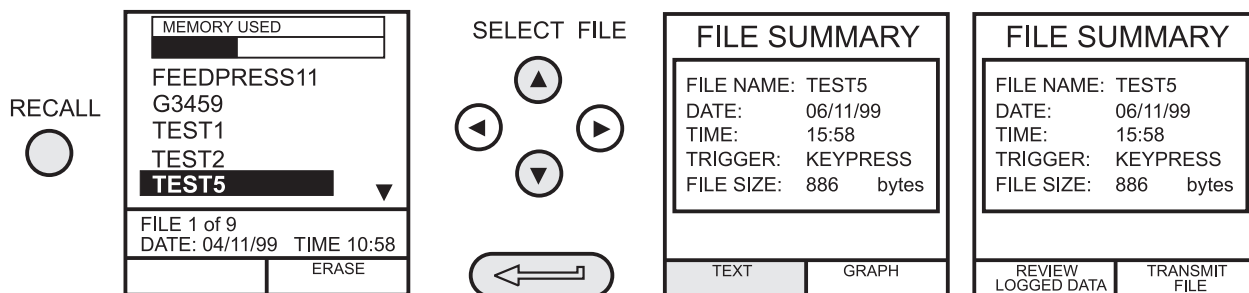

Data Log files can be displayed either as text (stored screens) or in graphical form. To display as text, proceed as follows from the File Summary menu. Select Auto Step to automatically review each screen at 1 second intervals or use the **left** ◀ or **right** ▶ cursor keys to manually review.

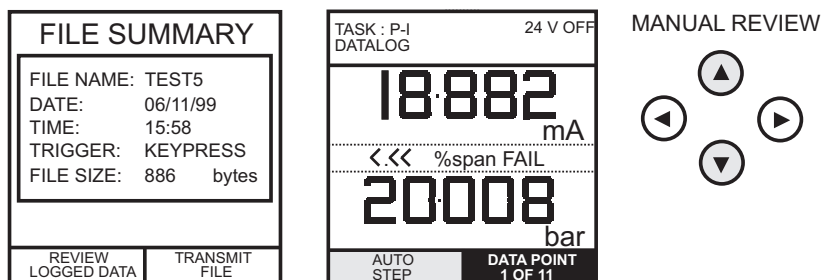

To display logged data in graphical form, on screen, proceed as follows from the File Summary menu:

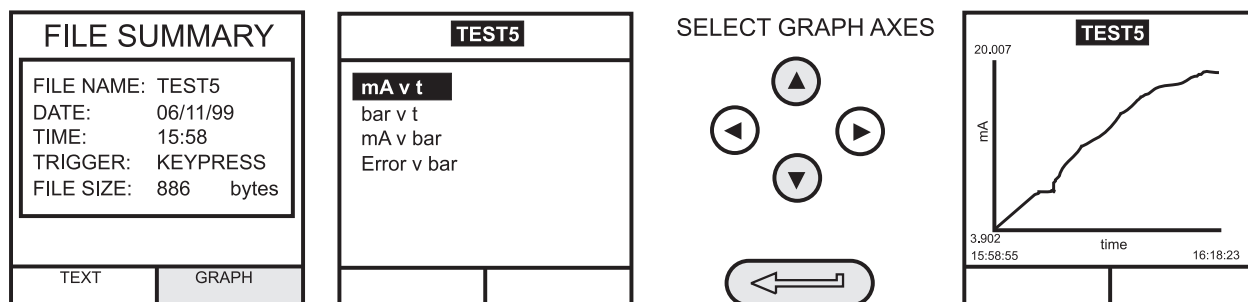

## Uploading Data Log Files

Connect the RS232 socket of the instrument to either the COM1 or COM2 port of the PC. Ensure that the RS232 parameters at the PC end match those of the instrument. The RS232 parameters of the instrument can be checked as detailed on page 39. Set-up a file on the PC to receive the data, (e.g.) in the *Windows® Terminal* program.

To upload a file, proceed as follows. Appendix 1 give details of a typical uploaded data log file.

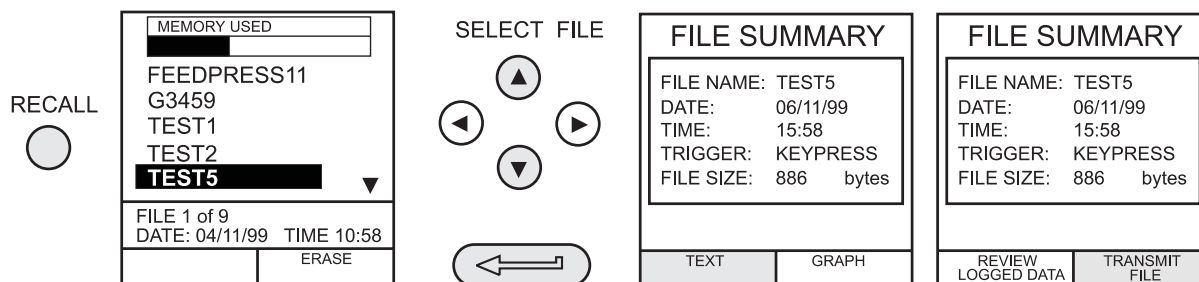

## Delete Data Log and Procedure Files

To delete a Data Log file, or a procedure file (DPI 615 only), proceed as follows. Alternatively, to delete all logged files simultaneously, select **ERASE ALL FILES** (F2) at the erase screen.

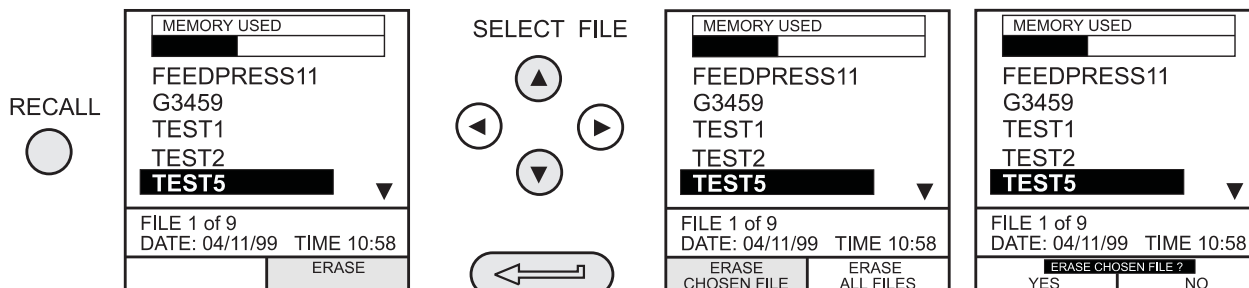

## Downloading Procedure Files (DPI 615 instruments only)

Complete test procedures may be downloaded from a PC to the DPI 615 instrument via the RS232 port. A procedure consists of a number of Druck Universal Command Interface (DUCI) commands that are usually assembled by a linking management software application (e.g.) **Druck Intecal**.

Before downloading a procedure, the instrument must be in the REMOTE mode. To place the instrument into REMOTE mode, proceed as follows:

- Connect the instrument's RS232 port to a free COM port on a PC.
- Ensure that the COMMS parameters of the PC match those of the instrument (refer to page 39).
- Ensure that the instrument is not already running a procedure. If it is, quit the procedure.
- Download the procedure. Procedures are stored in the Data Log directory.

The following sequence shows a typical download sequence that starts with the instrument in LOCAL mode.

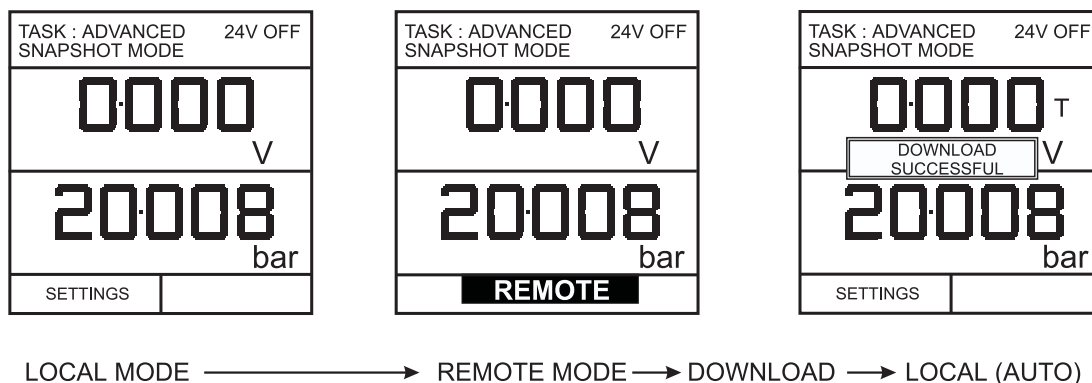

After the procedure file has been downloaded, the instrument is usually returned to the LOCAL mode by the last command in the procedure file. If the instrument remains in REMOTE mode, switch it OFF and ON to reset it.

## Running Procedure Files (DPI 615 instruments only)

To run a procedure, make sure the instrument is set to the Store mode, Data Log (see page 37), and proceed as follows:

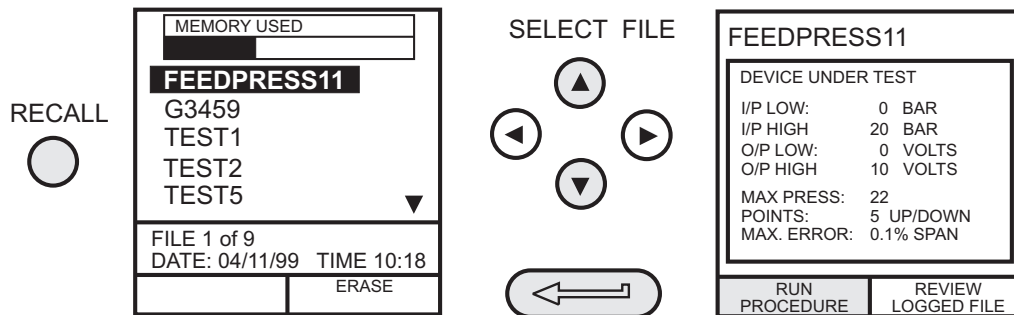

After selecting F1, proceed by entering the User ID and Serial Number and then select F1 (Continue) and follow the on-screen procedural instructions:

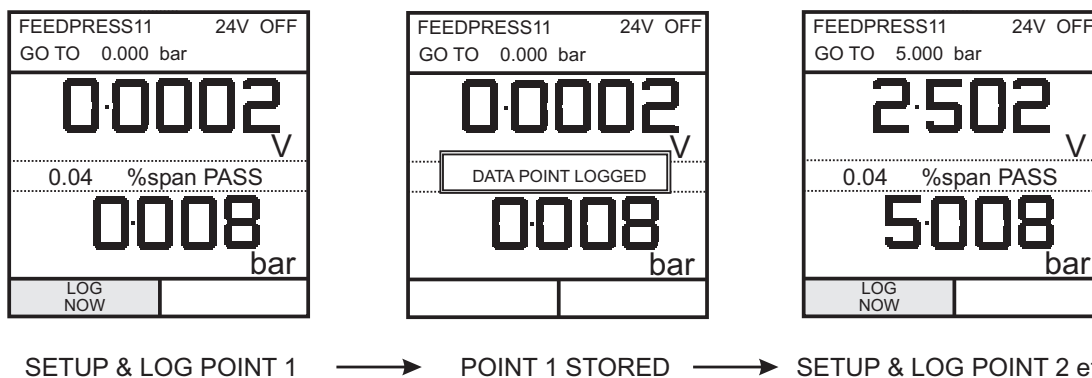

When the test procedure for a given UUT has been completed, the result of running the first test is stored as an AS FOUND file. This file cannot be overwritten. Any subsequent tests on the device are stored as an AS LEFT file that is overwritten each time the procedure on this device is run.

When recalling the results of a procedure, the choice of AS FOUND or AS LEFT is provided (refer to page 36).

## Recalling Data Files (DPI 615 instruments only)

Data or results files generated by running procedures are stored in the instrument's Data Log directory. To recall a data file to the display, ensure that **DATA LOG** is selected from the SETUP menu and proceed as follows:

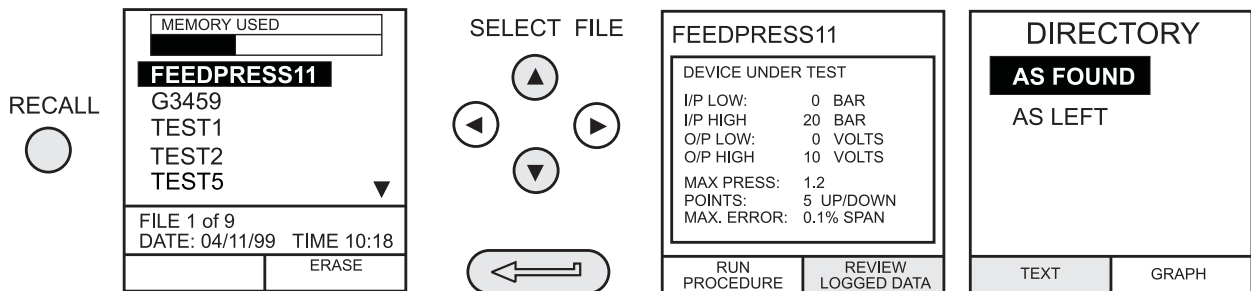

Use the cursor keys to select either the AS FOUND option or the AS LEFT option for display. AS FOUND is the result of the first run of a procedure and AS LEFT is the result of the last time the procedure was run.

Procedure data files can be displayed either as text (stored screens) or in graphical form. To display as text, select the **TEXT** option (F1) from the directory and proceed as follows from the File Summary menu. Select **AUTO STEP** (F1) to automatically review each screen at 1 second intervals or use the **left** ◀ or **right** ▶ cursor keys to manually review.

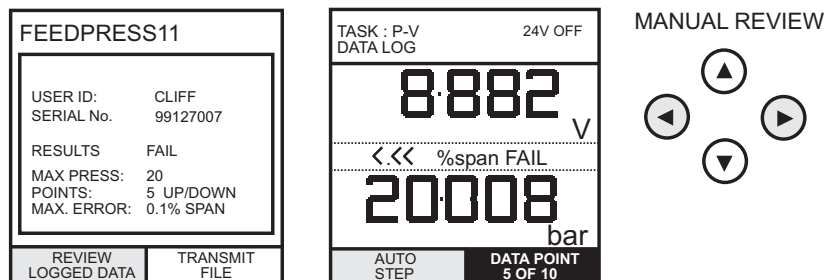

To transmit the selected logged data via the RS232 interface, connect the instrument to a free port on an external PC, ensure that the instrument's RS232 parameters match those of the PC.

To display logged data in graphical form, on screen, select **GRAPH** (F2) from the directory and proceed as follows:

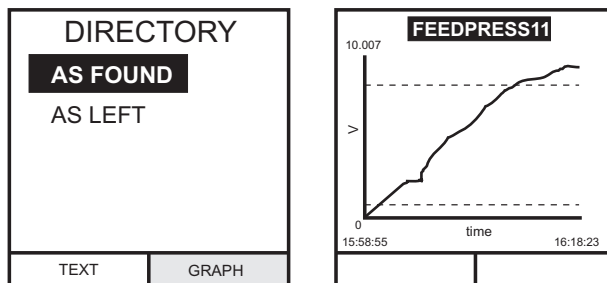

# Using Set-up

## General

**SETUP** mode is available in all modes except **BASIC** and permits the changing of the following instrument parameters.

- Store Mode - None, Snapshot, Data Log.
- Contrast.
- Settings - Units, Language, RS232 parameters, Powerdown and Calibration Routines (*Refer to page 43 for Calibration details*).
- Date and Time (Real Time Clock).
- Backlight Management - On, Off and Timed.

## Store Mode

Select **STORE MODE** from the Set-up menu and select required mode as follows:

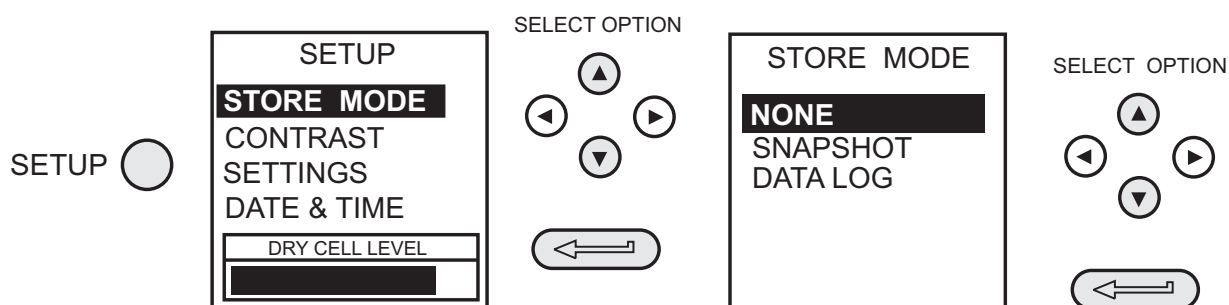

## Contrast

Select **CONTRAST** from the Set-up menu and proceed as follows:

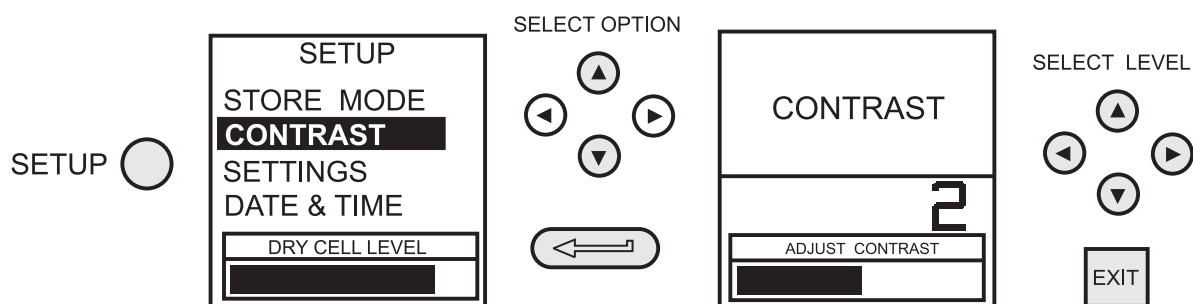

# Using Set-up

## Settings - Select Setup Option

To select one of the **SETTINGS** options from the set-up menu, proceed as follows:

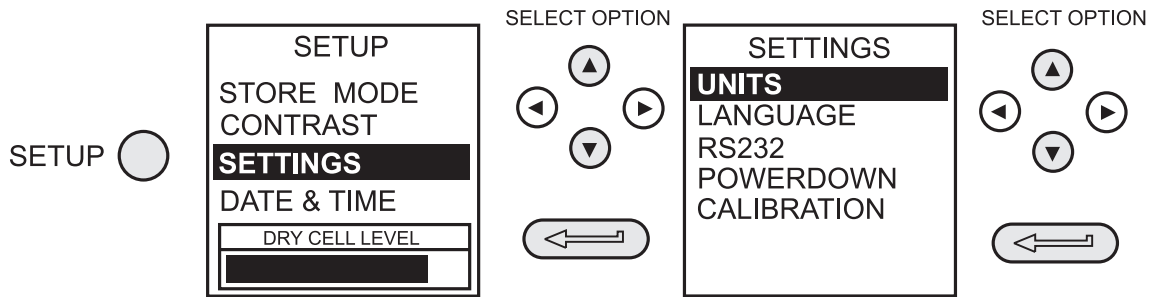

## Units

Select **UNITS** from the **SETTINGS** menu and proceed as follows:

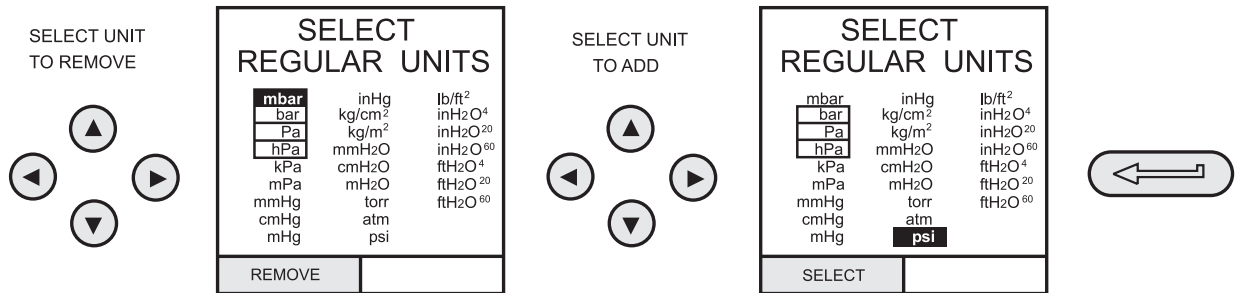

## Define Special Units

Select **UNITS** from the **SETTINGS** menu and select **SPECIAL UNITS** and proceed as follows:

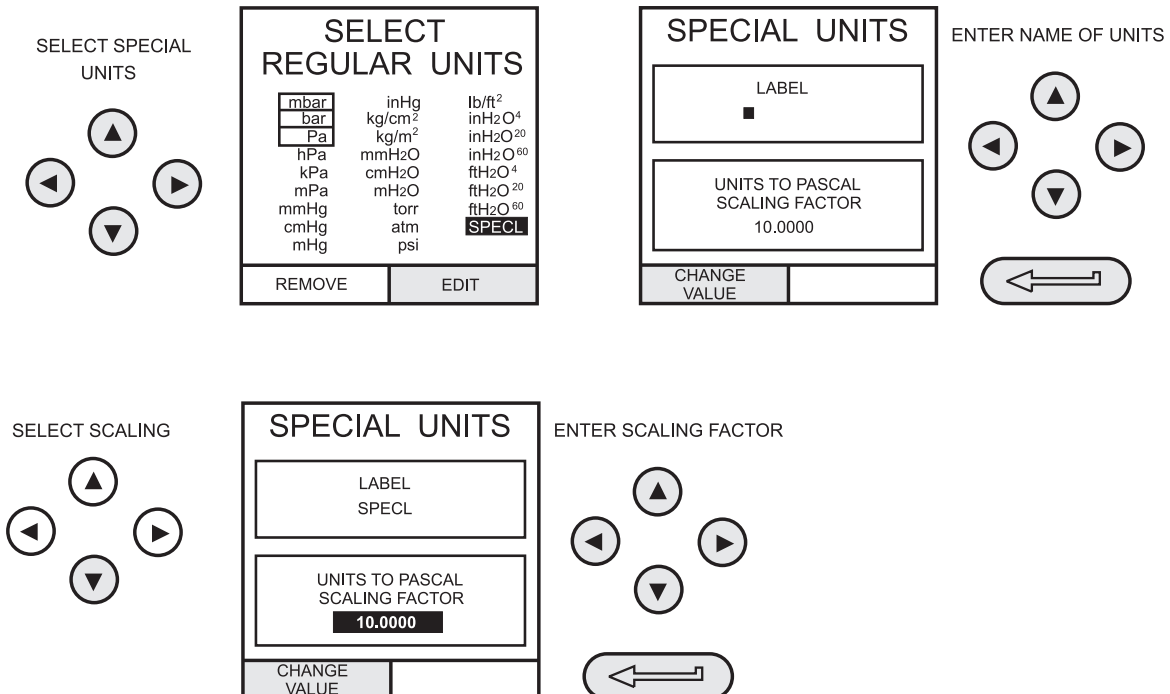



# Using Set-up

## Language

Select the **LANGUAGE** version required from the **SETTINGS** menu and proceed as follows:

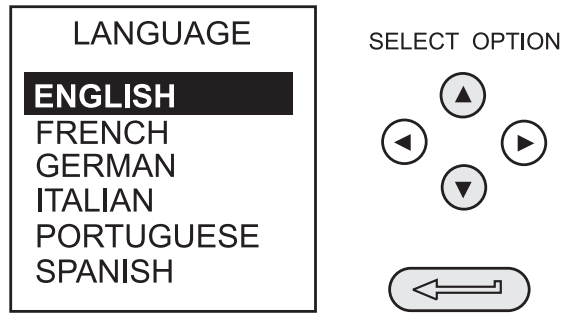

## RS232

Select **RS232** from the **SETTINGS** Menu and proceed as follows:

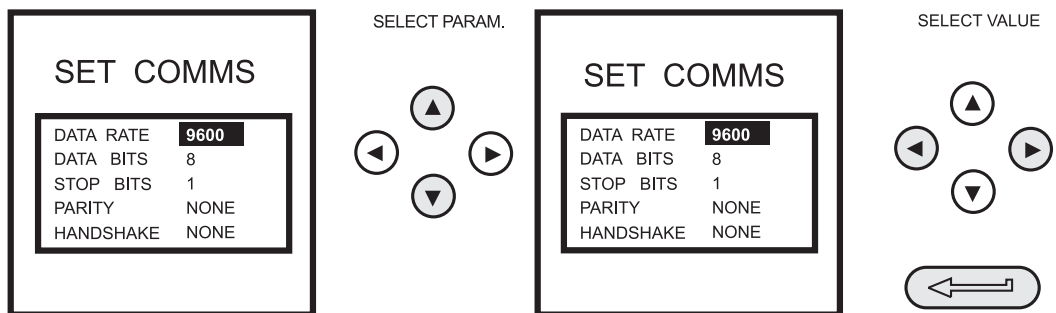

### Notes:

- *Communications default settings are shown above.*
- *If a communications problems occurs at a particular baud rate, change the baud rate on the instrument and PC to a lower rate.*

# Using Set-up

## Powerdown

Select **POWERDOWN** from the **SETTINGS** menu and proceed as follows:

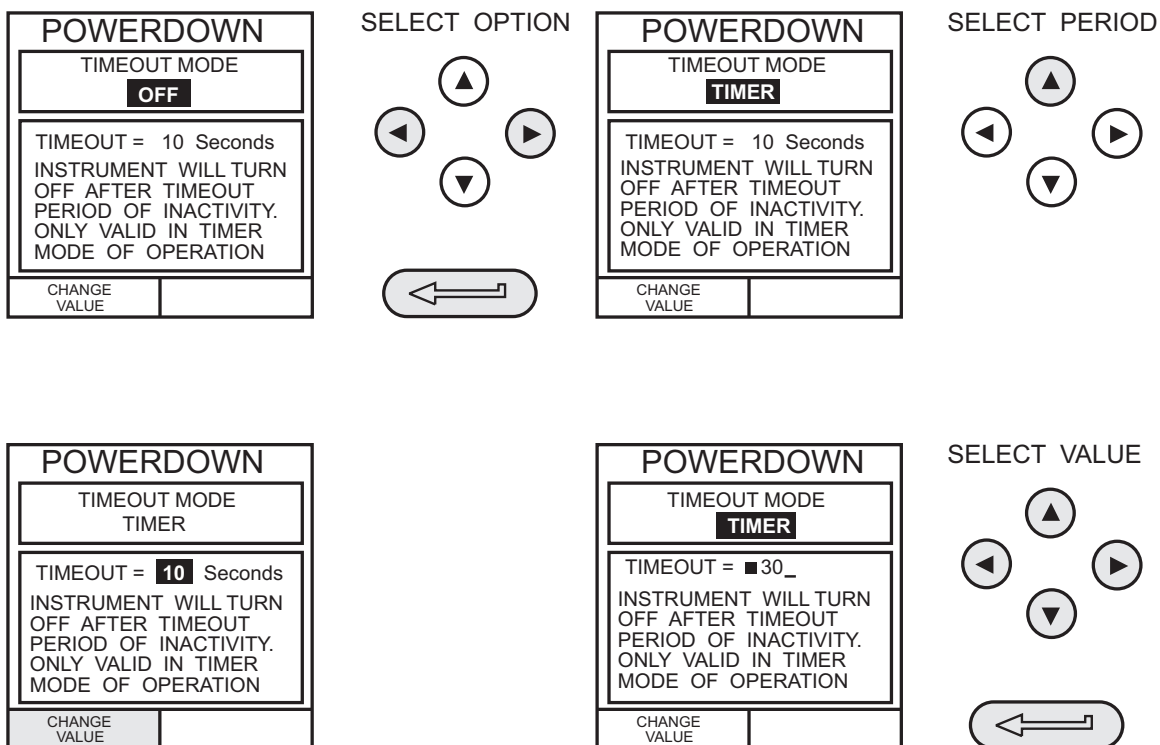

If selected to **TIMER** mode, following a period of inactivity, the instrument automatically powers off after the preset **TIMER** period.

If selected **OFF**, auto power off is inhibited and once switched on, the instrument remains **ON** until it is manually switched **OFF**.

## Calibration

Refer to page 43 for a full description of the calibration procedures.

# Using Set-up

## Date and Time (Real Time Clock)

### Date Format

To set-up the real time clock, select **DATE & TIME** from the set-up menu and, using the **▶** key, set the required date format:

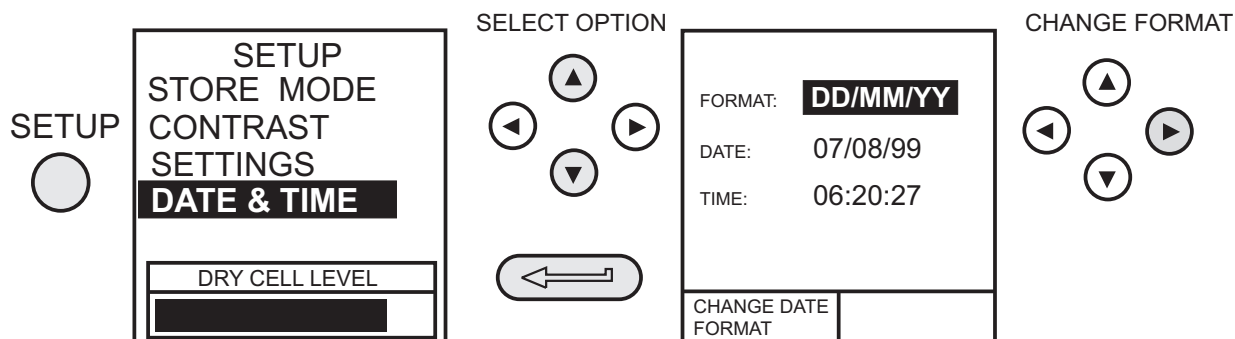

### Set Date

Select **DATE** from the **DATE & TIME** menu and, using the cursor keys, change the date as shown below. The **up ▲** and **down ▼** keys change the numerical value of the selected digit (indicated by the underline cursor) and the **left ◀** and **right ▶** keys select the required digit position.

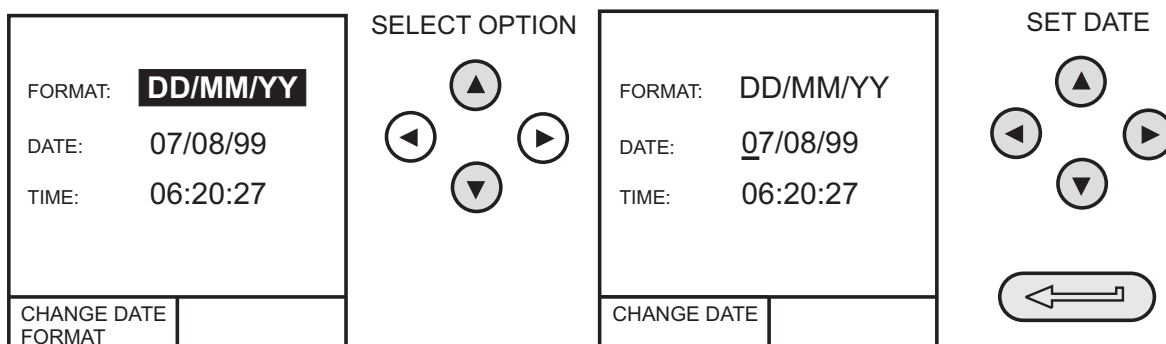

### Set Time

Select **TIME** from the **DATE & TIME** menu and, using the cursor keys, change the time as shown below. The **up ▲** and **down ▼** keys change the numerical value of the selected digit (indicated by the underline cursor) and the **left ◀** and **right ▶** keys select the required digit position.

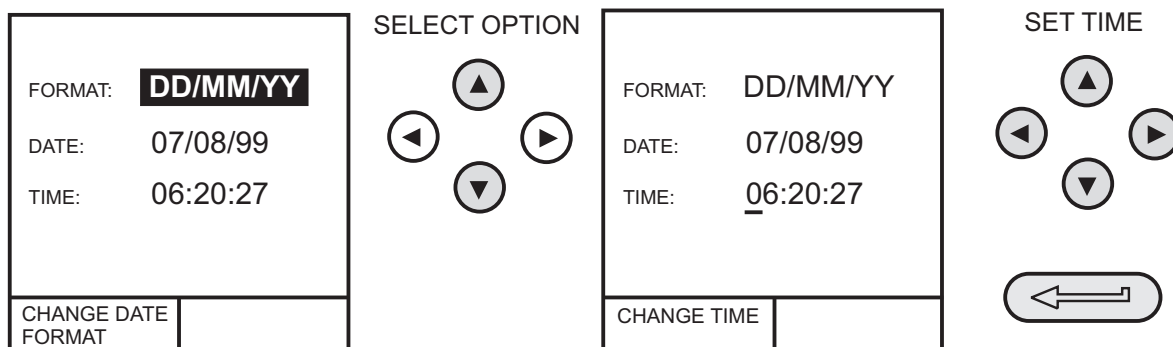

# Using Set-up

## Backlight

Select **BACKLIGHT** from the set-up menu and proceed as follows:

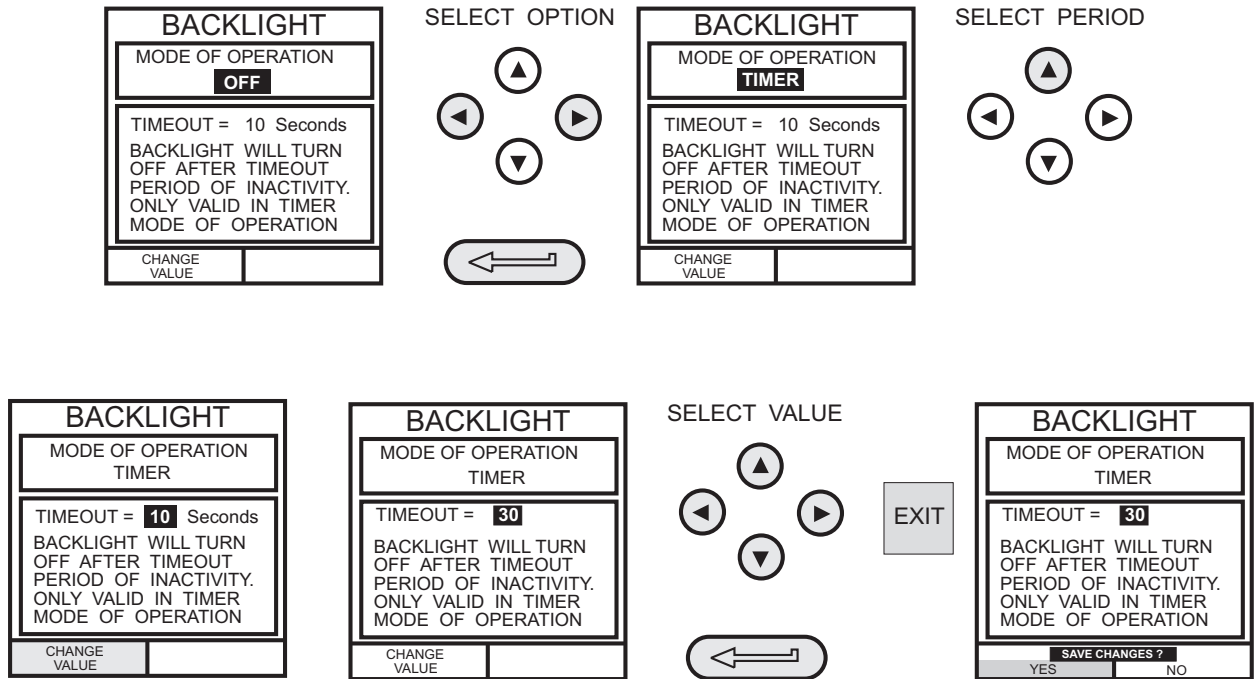

If **TIMER** mode is selected, any key press switches on the backlight for the **TIMER** period.

If **ON** is selected, the backlight remains on permanently and, if **OFF** is selected, the backlight remains permanently off.

# Calibration

## General

The instrument is supplied by the manufacturer, complete with calibration certificate(s). A calibration period of 12 months is recommended. The actual calibration interval depends on instrument usage and the total measurement uncertainty acceptable for the specified application.

The DPI 610 and DPI 615 are very precise measuring instruments and the test equipment and conditions of test must be suitable for the type of work. A Class A compensated deadweight tester must be used. The calibration check and calibration adjustment should be carried out in a controlled environment by a calibration technician\*.

The manufacturer offers a comprehensive and, if required, UKAS accredited calibration service.

\* *A calibration technician must have the necessary technical knowledge, documentation, special test equipment and tools to carry out the calibration work on this equipment.*

## Calibration Check

At the chosen calibration interval, the instrument readings should be compared with a known pressure standard.

The recommended method starts at 0, increasing in 20% steps to 100% full-scale and then decreasing in 20% steps to 0.

Note any deviations between the instrument and the pressure standard and consider traceability (accuracy to a National Standard).

If, after a calibration check, the results exceed the tolerance in the specification (or other suitable performance standard), carry out a calibration adjustment.

## Calibration Adjustment

If the instrument is operating correctly, only zero and full-scale calibration will vary. Any excessive non-linearity or temperature effects indicate a fault. The instrument should be returned to a qualified service agent.

## Guide to Calibration Procedures

- Use high quality **Repeatable and Linear** pressure sources and allow adequate thermal stabilization time before calibration (minimum 1 hour).
- Conduct the calibration in a temperature controlled and preferably, humidity controlled environment. Recommended temperature is **21°C, ±2°C (70°F, ±4°F)**.
- Use deadweight testers carefully and away from draughts.
- Review and become familiar with the whole calibration procedure before commencing the calibration process.
- The calibration routines cannot be accessed when the instrument is in **BASIC** mode. Use the **TASK** key to select another mode (e.g.) **ADVANCED** before accessing the **CALIBRATION** mode.

# Calibration

## Test Equipment

The calibration procedures require the following test equipment.

Test Equipment and Instrument Parameter/Range	Calibration Equipment Accuracy	Calibration Uncertainty
Digital Voltmeter - 5V input	±30 *ppm ±1 digit	±10 *ppm ±5µV
Digital Voltmeter - 50V input	±45 *ppm ±1 digit	±11 *ppm ± 110 µV
Digital milliammeter - 55mA input	±150 *ppm ±4 digit	±100 *ppm ± 1nA
Digital milliammeter - 24mA output	±150 *ppm ±4 digit	±160 *ppm ± 1nA
Precision thermometer - ambient temperature	±0.2°C	± 0.1°C ±1 digit
Deadweight tester - pressure internal/external	Class A deadweight	<0.025%

\*ppm = parts per million

**Table 1 Internal/External Pressure Transducer Verification**

Nominal applied value as a% of ±full-scale	Permissible deviation	
	PC*, HC* and Indicator Versions	LP* Versions and external LPE 9400 sensors
0% (10% for absolute ranges)	± 0.025% FS	± 0.05% span
20%	± 0.025% FS	± 0.05% span
40%	± 0.025% FS	± 0.05% span
60%	± 0.025% FS	± 0.05% span
80%	± 0.025% FS	± 0.05% span
100%	± 0.025% FS	± 0.05% span
80%	± 0.025% FS	± 0.05% span
60%	± 0.025% FS	± 0.05% span
40%	± 0.025% FS	± 0.05% span
20%	± 0.025% FS	± 0.05% span
0% (10% for absolute ranges)	± 0.025% FS	± 0.05% span

PC\* = Pressure Calibrator    HC\* = Hydraulic Calibrator    LP\* = Low Pressure Calibrator

# Calibration

## Using the Calibration Menu

The calibration routines are selected from the Settings menu as detailed on page 38. Enter the calibration PIN number, initially set to **4321**, press  and the display shows the Calibration Menu.

### PIN security

To prevent unauthorised access, it is recommended that the PIN number be changed as soon as possible.

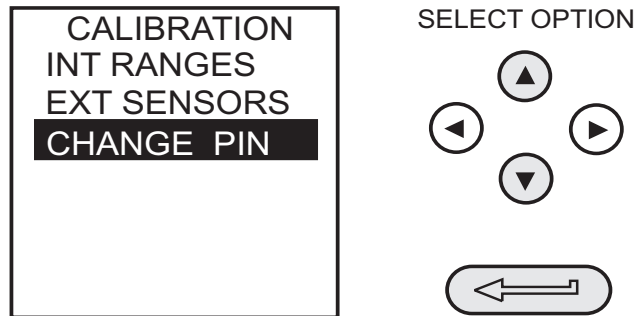

## Change PIN

To change the PIN code, select **CHANGE PIN** from the calibration menu and proceed as follows:

**Note:** To set and verify a new PIN, the new PIN code must be entered twice.

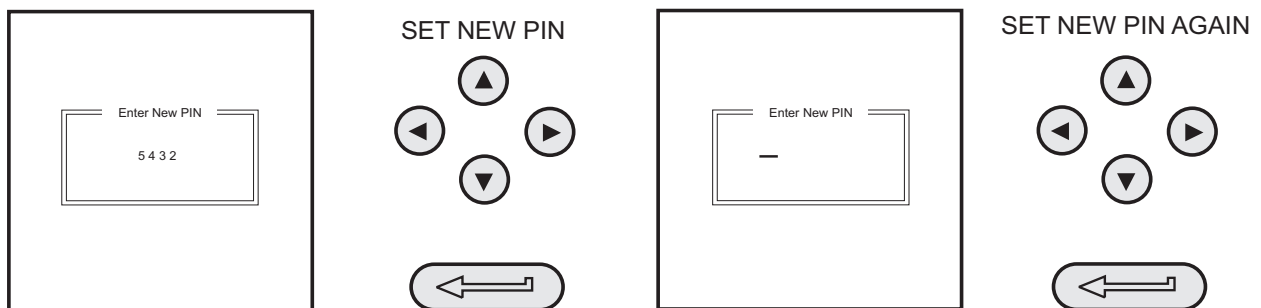

- If the second code entered differs from the first, the new PIN will not be set.



## Calibrate Internal Ranges

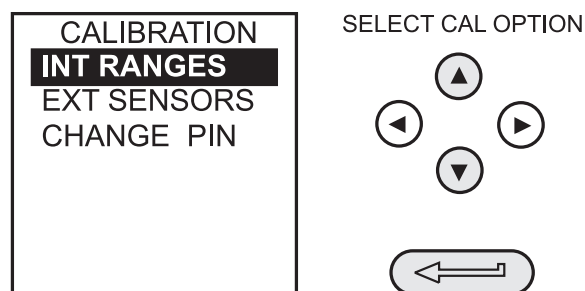

Select the **INT RANGES** from the menu as shown above and follow the calibration procedure on the display.

# Calibration

## Internal Pressure Range

Use the following procedure for calibrating the internal pressure range.

**Note:** If calibrating the hydraulic calibrator version, the calibrator must first be primed as detailed on pages 59 to 66.

- (1) Connect the outlet port of the instrument to a pressure standard.
- (2) Allow the instrument's temperature to stabilize for a minimum of 1 hour.
- (3) Switch the instrument on, enter **CALIBRATION** mode and select **INT RANGES** from the **CALIBRATION** menu and then **PRESSURE INT**.

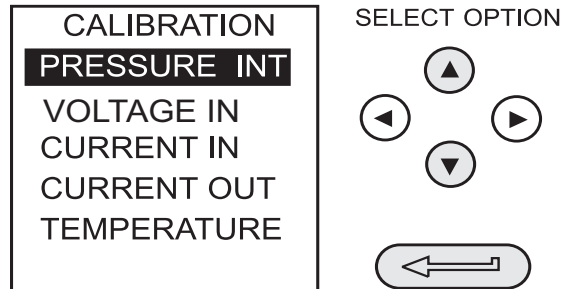

- (4) Apply zero pressure and store the zero point:

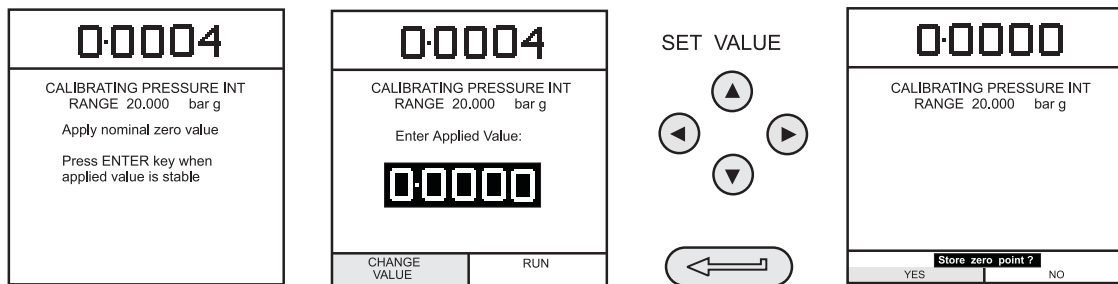

- (5) Close the vent valve, apply full-scale pressure and store the full-scale point:

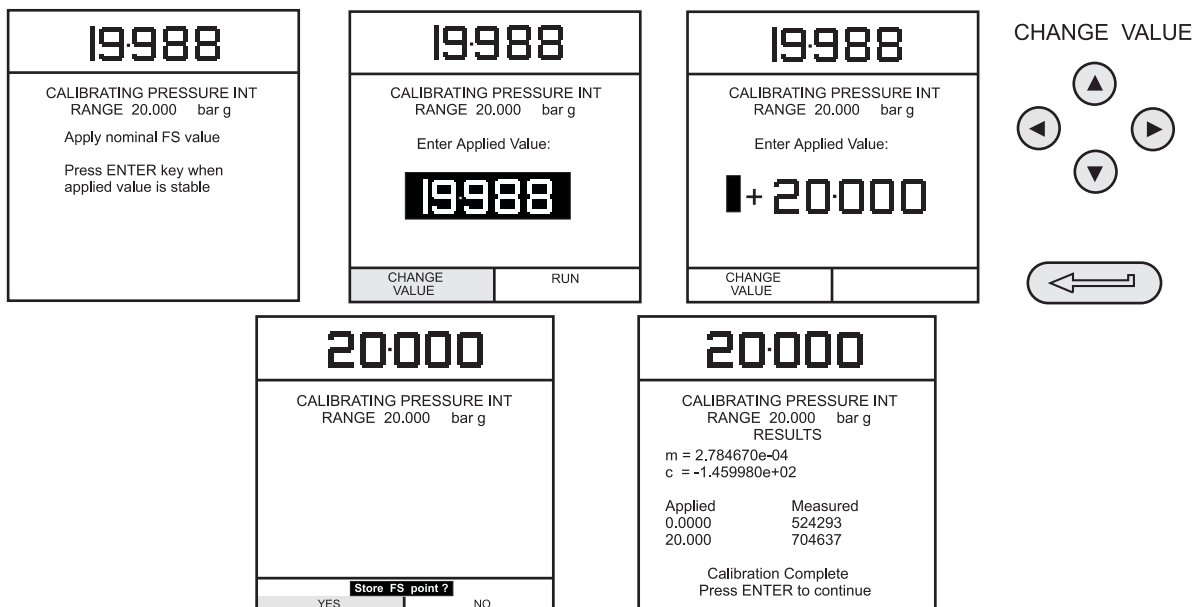

- (6) Press the **ENTER** key to accept the calibration. Press the **EXIT** key four times to quit **CALIBRATION** and **SETUP** modes.
- (7) Check calibration by applying test pressures in Table 1, page 44.



# Calibration

## Voltage Input Range (5 Volts)

Use the following procedure for calibrating the internal 5 Volt range.

- (1) Switch the instrument on, enter **CALIBRATION** mode and select **INT RANGES** from the **CALIBRATION** menu as shown on page 45.

- (2) Select 5V range for calibration:

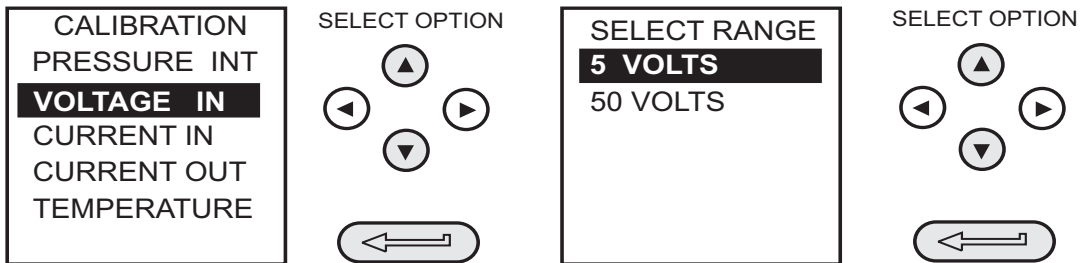

- (3) Link the voltage input terminals with a short lead and enter the zero point:

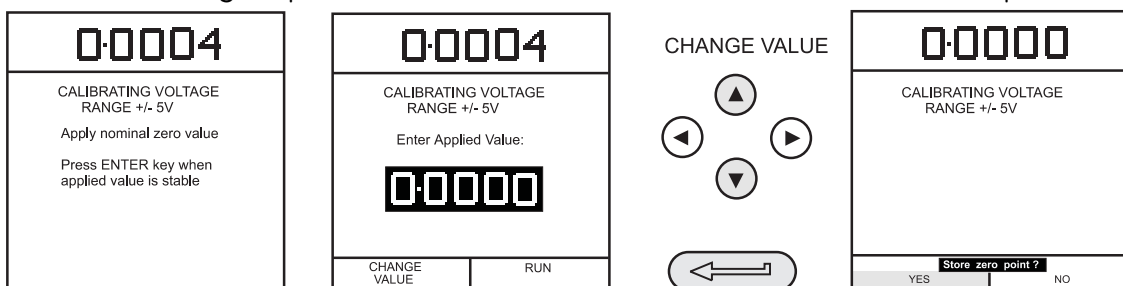

- (4) Remove the shorting link from the voltmeter terminals, connect the Vin terminals of the instrument to a variable voltage source and connect a digital voltmeter across the source:

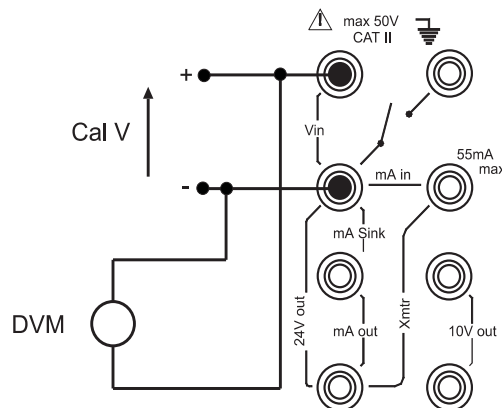

# Calibration

- (5) Set the variable supply voltage to  $5V \pm 0.1V$  and enter the measured full-scale voltage applied:

The calibration process is shown through five sequential screen displays:

- Screen 1:** Displays '49884'. Text: 'CALIBRATING VOLTAGE RANGE +/- 5V', 'Apply nominal FS value', 'Press ENTER key when applied value is stable'. Buttons: 'CHANGE VALUE', 'RUN'.
- Screen 2:** Displays '49884'. Text: 'CALIBRATING VOLTAGE RANGE +/- 5V', 'Enter Applied Value:'. Input: '5.0000'. Buttons: 'CHANGE VALUE', 'RUN'.
- Screen 3:** Displays '49884'. Text: 'CALIBRATING VOLTAGE RANGE +/- 5V', 'Enter Applied Value:'. Input: '+ 49844'. Buttons: 'CHANGE VALUE'.
- Screen 4:** Displays '49844'. Text: 'CALIBRATING VOLTAGE RANGE +/- 5V'. Prompt: 'Store FS point?'. Buttons: 'YES', 'NO'.
- Screen 5:** Displays '49844'. Text: 'CALIBRATING VOLTAGE RANGE +/- 5V RESULTS', 'm = 1.359372e-05', 'c = -7.128004e+00', 'Applied Measured', '0.0000 524360', '4.9844 875081', 'Calibration Complete Press ENTER to continue'.

To the right of the screens is a control pad labeled 'CHANGE VALUE' with four directional arrow buttons (up, down, left, right) and a long left-pointing arrow button at the bottom.

- (6) Press the **ENTER** key to accept the calibration. Press the **EXIT** key once to return to the calibration menu or four times to quit the **CALIBRATION** and **SETUP** modes.
- (7) Verify the instrument calibration by applying the test voltages given in Table 2 (page 50), to the voltmeter (after both voltage ranges have been calibrated).
- (8) Disconnect the calibration/test equipment.

# Calibration

## Voltage Input Range (50 Volts)

Use the following procedure for calibrating the internal 50 Volt range.

(1) Switch the instrument on, enter **CALIBRATION** mode and select **INT RANGES** from the **CALIBRATION** menu as shown on Page 45.

(2) Select 50V range for calibration:

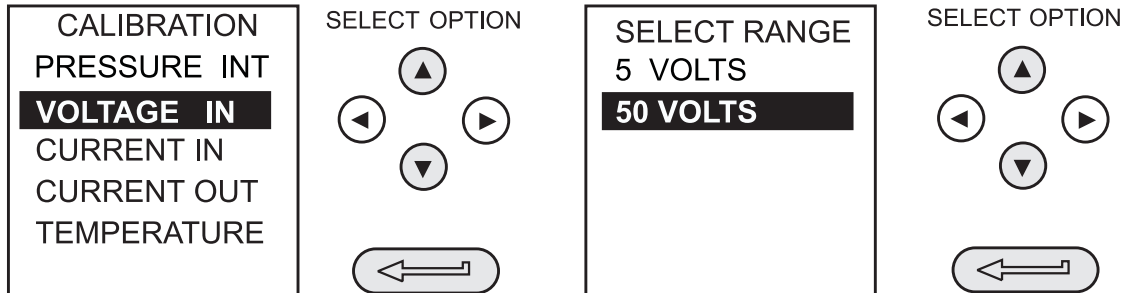

(3) Link the voltage input terminals with a short lead and enter the zero point:

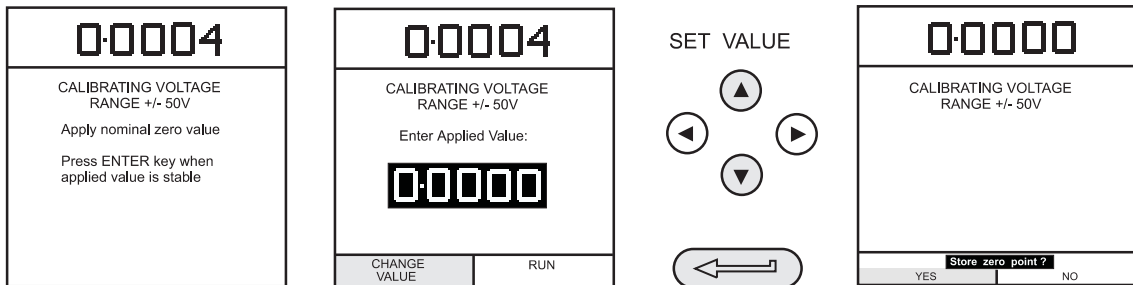

(4) Remove the shorting link from the voltmeter terminals, connect the Vin terminals of the instrument to a variable voltage source and connect a digital voltmeter across the source:

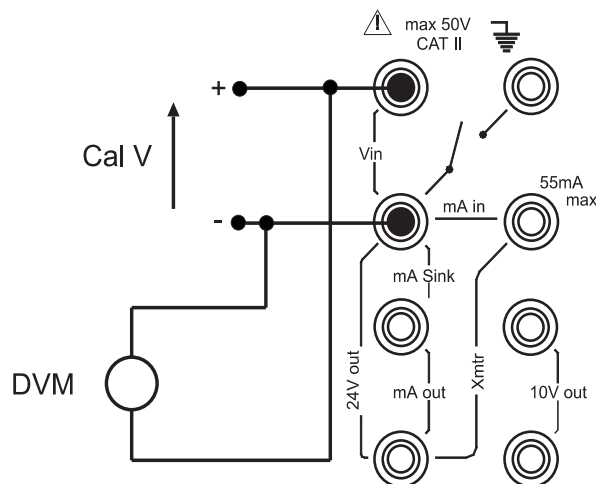

# Calibration

- (5) Set the variable supply voltage to  $50V \pm 0.1V$  and enter the measured full-scale voltage:

- (6) Press the **ENTER** key to accept the calibration. Press the **EXIT** key four times to quit the **CALIBRATION** and **SETUP** modes.
- (7) Verify the instrument calibration by applying the test voltages given in Table 2 to the voltmeter (after both voltage ranges have been calibrated).
- (8) Disconnect the calibration/test equipment.

Voltage Calibration 50V Range Verification Tolerances		Voltage Calibration 5V Range Verification Tolerances	
Applied Voltage	Permissible Deviation	Applied Voltage	Permissible Deviation
-50	$\pm 0.05\% \text{ rdg}, \pm 0.004\% \text{ FS}$	-5	$\pm 0.05\% \text{ rdg}, \pm 0.004\% \text{ FS}$
-40	$\pm 0.05\% \text{ rdg}, \pm 0.004\% \text{ FS}$	-4	$\pm 0.05\% \text{ rdg}, \pm 0.004\% \text{ FS}$
-30	$\pm 0.05\% \text{ rdg}, \pm 0.004\% \text{ FS}$	-3	$\pm 0.05\% \text{ rdg}, \pm 0.004\% \text{ FS}$
-20	$\pm 0.05\% \text{ rdg}, \pm 0.004\% \text{ FS}$	-2	$\pm 0.05\% \text{ rdg}, \pm 0.004\% \text{ FS}$
-10	$\pm 0.05\% \text{ rdg}, \pm 0.004\% \text{ FS}$	-1	$\pm 0.05\% \text{ rdg}, \pm 0.004\% \text{ FS}$
0	$\pm 0.05\% \text{ rdg}, \pm 0.004\% \text{ FS}$	0	$\pm 0.05\% \text{ rdg}, \pm 0.004\% \text{ FS}$
10	$\pm 0.05\% \text{ rdg}, \pm 0.004\% \text{ FS}$	1	$\pm 0.05\% \text{ rdg}, \pm 0.004\% \text{ FS}$
20	$\pm 0.05\% \text{ rdg}, \pm 0.004\% \text{ FS}$	2	$\pm 0.05\% \text{ rdg}, \pm 0.004\% \text{ FS}$
30	$\pm 0.05\% \text{ rdg}, \pm 0.004\% \text{ FS}$	3	$\pm 0.05\% \text{ rdg}, \pm 0.004\% \text{ FS}$
40	$\pm 0.05\% \text{ rdg}, \pm 0.004\% \text{ FS}$	4	$\pm 0.05\% \text{ rdg}, \pm 0.004\% \text{ FS}$
50	$\pm 0.05\% \text{ rdg}, \pm 0.004\% \text{ FS}$	5	$\pm 0.05\% \text{ rdg}, \pm 0.004\% \text{ FS}$

**Table 2 Electrical Voltage Input Calibration Tolerances**

# Calibration

## Current Input Range (55 mA)

Use the following procedure for calibrating the current input range.

(1) Switch the instrument on, enter **CALIBRATION** mode and select **INT RANGES** from the **CALIBRATION** menu as shown on Page 45.

(2) Select **CURRENT IN** range for calibration:

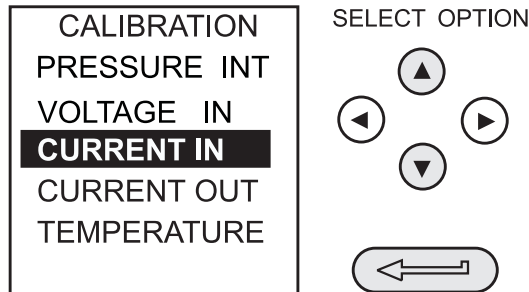

(3) Open circuit the **mA in** terminals and enter the zero point:

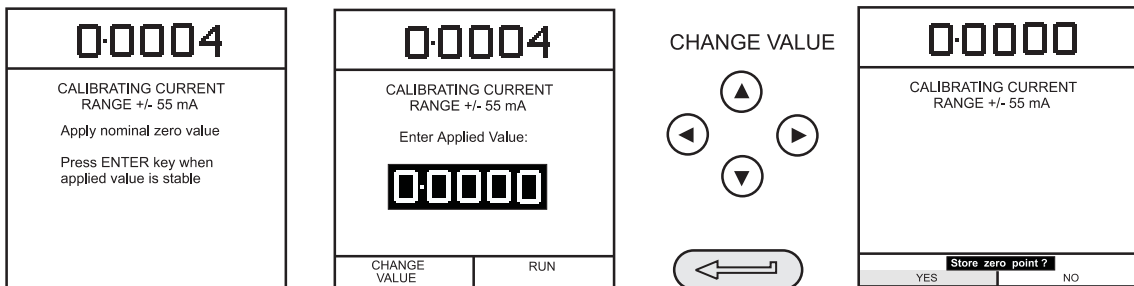

(4) Connect the mA in terminals of the instrument to a variable current source and connect a digital milliammeter in series with the supply:

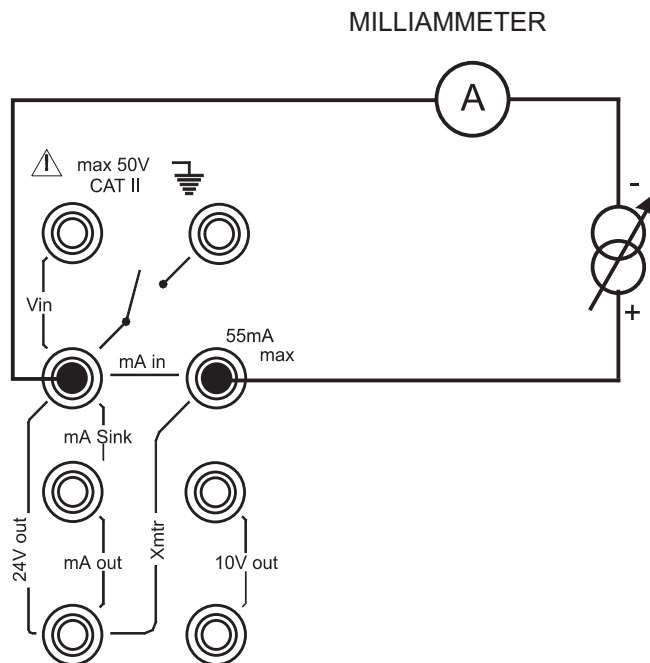

# Calibration

- (5) Set the input current to  $55 \pm 0.1\text{mA}$  and enter the measured full-scale input current:

The first screenshot shows the display with '54984' and the text: 'CALIBRATING CURRENT RANGE +/- 55 mA', 'Apply nominal FS value', and 'Press ENTER key when applied value is stable'. The second screenshot shows '54984' and 'Enter Applied Value:' with '55.000' entered. The third screenshot shows '54984' and 'Enter Applied Value:' with '+54944' entered. To the right is a control pad with four directional arrows and a 'CHANGE VALUE' button.

The first screenshot shows '54984' and 'CALIBRATING CURRENT RANGE +/- 55 mA' with a 'Store FS point?' prompt and 'YES'/'NO' options. The second screenshot shows '54984' and 'CALIBRATING CURRENT RANGE +/- 55 mA RESULTS' with the following data: 'm = 2.784670e-04', 'c = -1.459980e+02', 'Applied 0.0000 54.984', 'Measured 524293 704637', and 'Calibration Complete Press ENTER to continue'.

- (6) Press the **ENTER** key to accept the calibration. Press the **EXIT** key four times to quit the **CALIBRATION** and **SETUP** modes.
- (7) Verify the instrument calibration by applying the test currents given in Table 3 to the milliammeter.
- (8) Disconnect the calibration/test equipment.

Current Calibration, 55mA Range Verification Tolerances	
Applied Current (mA)	Permissible Deviation
-55	$\pm 0.05\% \text{ rdg} \pm 0.004\% \text{ FS}$
-45	$\pm 0.05\% \text{ rdg} \pm 0.004\% \text{ FS}$
-35	$\pm 0.05\% \text{ rdg} \pm 0.004\% \text{ FS}$
-25	$\pm 0.05\% \text{ rdg} \pm 0.004\% \text{ FS}$
-15	$\pm 0.05\% \text{ rdg} \pm 0.004\% \text{ FS}$
-5	$\pm 0.05\% \text{ rdg} \pm 0.004\% \text{ FS}$
0	$\pm 0.05\% \text{ rdg} \pm 0.004\% \text{ FS}$
5	$\pm 0.05\% \text{ rdg} \pm 0.004\% \text{ FS}$
15	$\pm 0.05\% \text{ rdg} \pm 0.004\% \text{ FS}$
25	$\pm 0.05\% \text{ rdg} \pm 0.004\% \text{ FS}$
35	$\pm 0.05\% \text{ rdg} \pm 0.004\% \text{ FS}$
45	$\pm 0.05\% \text{ rdg} \pm 0.004\% \text{ FS}$
55	$\pm 0.05\% \text{ rdg} \pm 0.004\% \text{ FS}$

Table 3 Electrical Current Input Calibration Tolerances

# Calibration

## Current Output Range (24 mA)

Use the following procedure for calibrating the current output range.

- (1) Switch the instrument on, enter CALIBRATION mode and select INT RANGES from the CALIBRATION MENU as shown on page 45.
- (2) Select CURRENT OUT range for calibration:

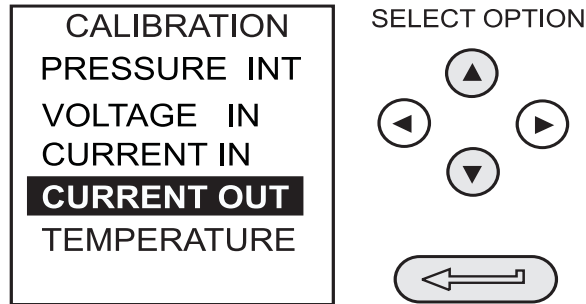

- (3) Connect a digital milliammeter to the instrument as shown below.

**Note:** On standard instruments, during a current out calibration routine, the 24V dc output is automatically turned on.

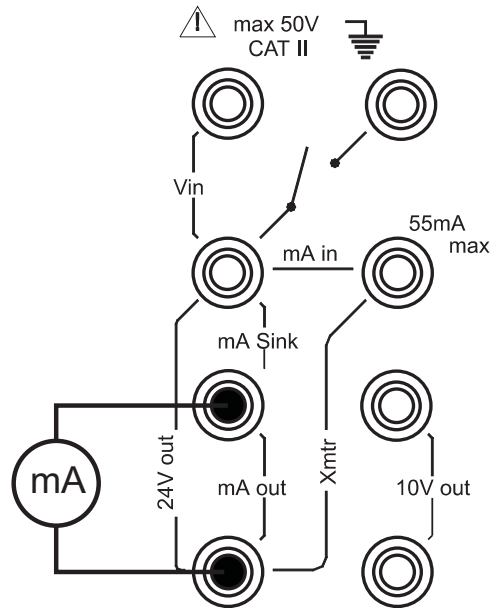

# Calibration

- (4) Measure the 10% full-scale output current and enter the value measured on the external milliammeter:

- (5) Measure the 90% full-scale output current and enter the value measured on the external milliammeter

- (6) Press the **ENTER** key to accept the calibration. Press the **EXIT** key four times to quit the **CALIBRATION** and **SETUP** modes.
- (7) Verify the instrument's output current calibration by setting up the loop test currents as shown in Table 4 and checking the set values against the milliammeter standard.
- (8) Press the **OUTPUT** key, select **24 VOLT** and turn the 24V supply to **ON**. Proceed as follows:



# Calibration

- (9) Set the loop output current to 5 mA as shown below and check that the output current, measured on the milliammeter standard is within the limits given in Table 4.

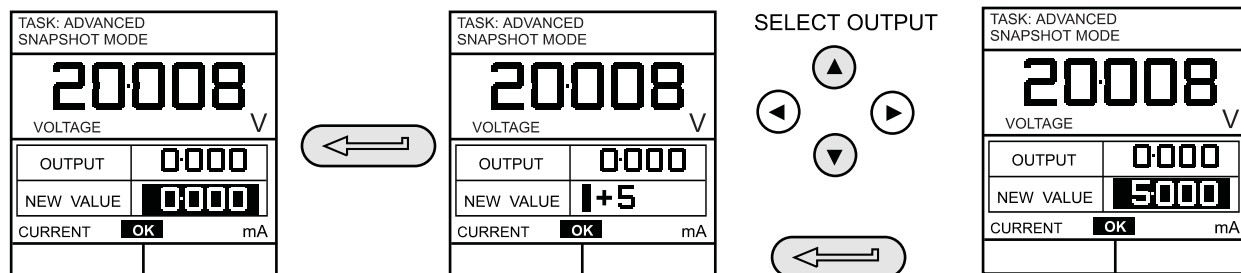

- (10) Repeat (9) for all output values given in Table 4.

Current Output Calibration, 24mA Range Verification Tolerances	
Applied Current (mA)	Permissible Deviation
0	$\pm 0.05\% \text{ rdg} \pm 0.01\% \text{ FS}$
5	$\pm 0.05\% \text{ rdg} \pm 0.01\% \text{ FS}$
10	$\pm 0.05\% \text{ rdg} \pm 0.01\% \text{ FS}$
15	$\pm 0.05\% \text{ rdg} \pm 0.01\% \text{ FS}$
20	$\pm 0.05\% \text{ rdg} \pm 0.01\% \text{ FS}$
24	$\pm 0.05\% \text{ rdg} \pm 0.01\% \text{ FS}$
20	$\pm 0.05\% \text{ rdg} \pm 0.01\% \text{ FS}$
15	$\pm 0.05\% \text{ rdg} \pm 0.01\% \text{ FS}$
10	$\pm 0.05\% \text{ rdg} \pm 0.01\% \text{ FS}$
5	$\pm 0.05\% \text{ rdg} \pm 0.01\% \text{ FS}$
0	$\pm 0.05\% \text{ rdg} \pm 0.01\% \text{ FS}$

**Table 4 Electrical Current Output Calibration Tolerances**

- (11) Disconnect the calibration/test equipment.

# Calibration

## Ambient Temperature Channel

Use the following procedure for calibrating the ambient temperature measurement channel.

- (1) Switch the instrument on, enter the **CALIBRATION** mode and select **TEMPERATURE**:

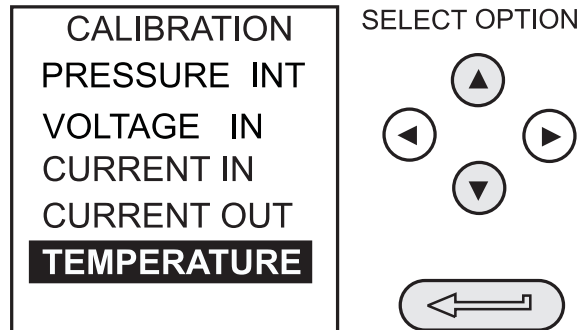

- (2) Allow the instrument's temperature to stabilize in the calibration environment for at least one hour.
- (3) Read the environmental temperature on a calibrated digital thermometer and enter the recorded value as shown below. Example shown for a measured ambient temperature of 21.5° Celsius.

**Note:** Only one temperature point is required.

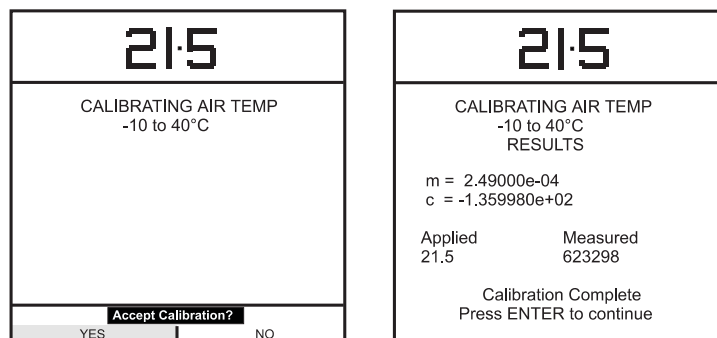
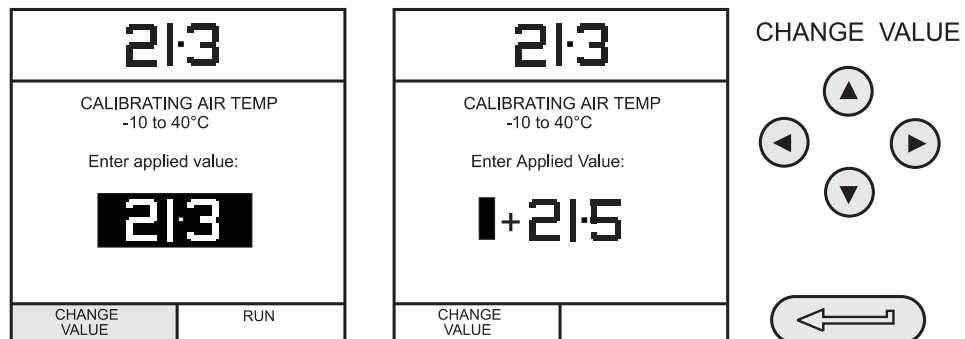

- (4) Press the **ENTER** key to accept the calibration. Press the **EXIT** key once to return to the calibration menu or four times to quit the **CALIBRATION** and **SETUP** modes.

# Calibration

## Calibrate External Sensors

Use the following procedure for calibrating external pressure sensors.

- (1) Connect the required external transducer to the EXT TRANSDUCER socket located on the rear of the instrument.
- (2) Allow the instrument's temperature and the temperature of the external transducer to stabilize in the calibration environment for a minimum of 1 hour.
- (3) Switch the instrument on, enter **CALIBRATION** mode and select **EXT SENSORS** from the **CALIBRATION** menu:

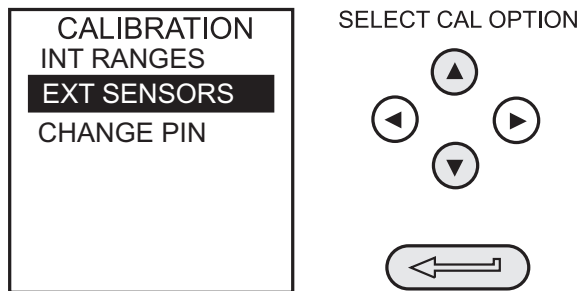

- (4) Select the transducer to be calibrated from the transducer menu using the cursor keys and press ENTER:

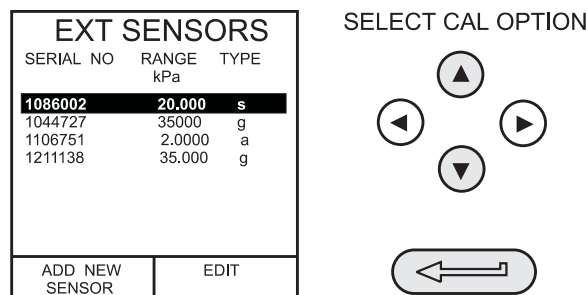

If the sensor to be calibrated is not in the directory, or no sensors are listed in the directory, press the **F1** key (ADD NEW SENSOR). This will place the sensor in the directory, allowing it to then be selected.

- (5) Connect the pressure standard to the inlet of the external transducer, apply the zero point pressure and store the zero point:

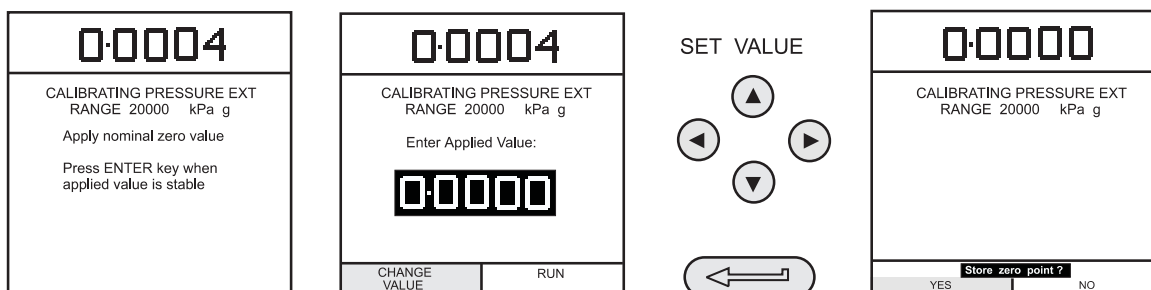

- (6) Apply the full-scale pressure to the external transducer and store the full-scale (FS) point.

- (7) Release the applied pressure and disconnect the pressure reference. Press the **ENTER** key to accept the calibration. Press the **EXIT** key once to return to the calibration menu or four times to quit the **CALIBRATION** and **SETUP** modes.
- (8) Check the calibration of the external transducer by applying the test pressures as detailed in Table 1, page 44.

### Add External Sensor

To add an external sensor to the directory of external sensors, proceed as follows:

- Connect the required external transducer to the EXT TRANSDUCER socket located on the rear of the instrument.

Digitally compensated transducers will be downloaded into the directory as soon as the F1 key is operated. Data for other types can be edited by selecting **EDIT** (F2). If the data cannot be edited a warning message (INVALID ACTION) is displayed.

# Hydraulic Calibrator Versions

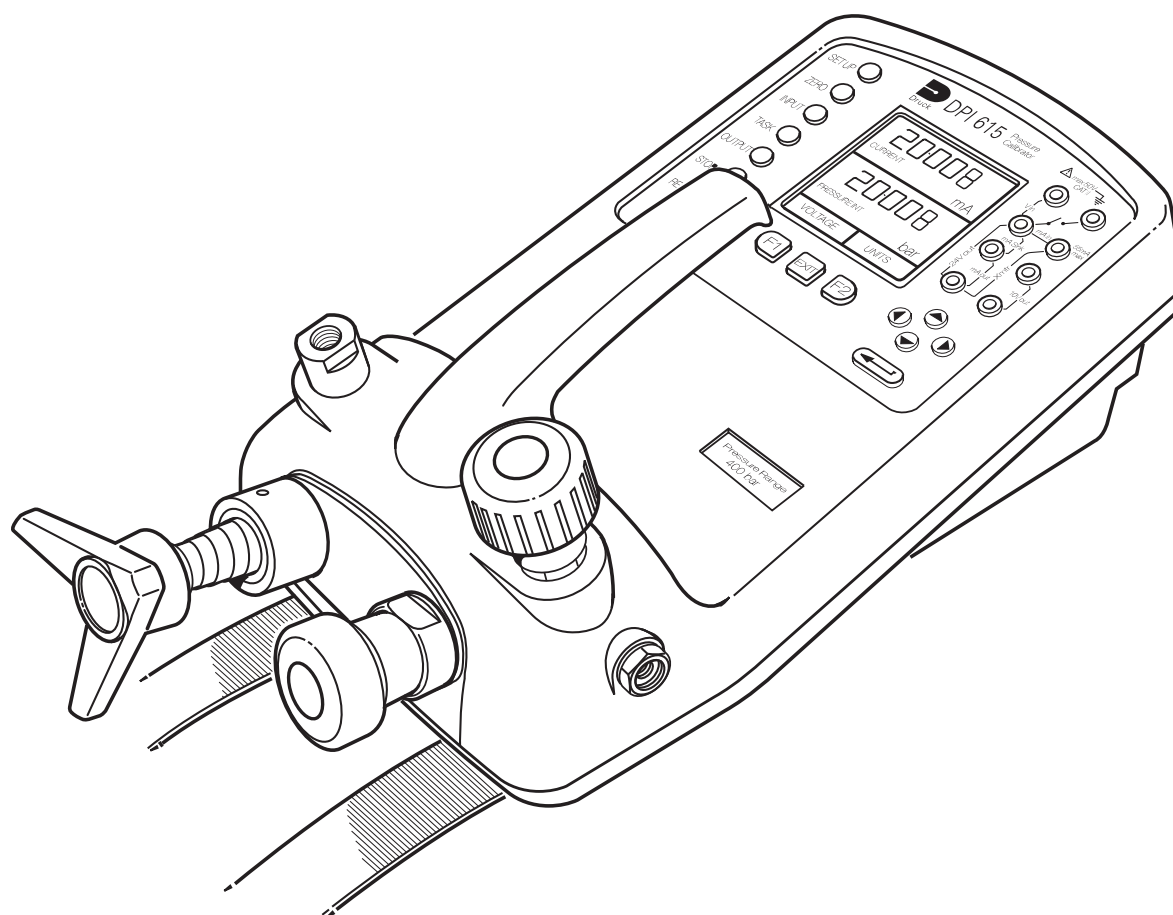

**This page intentionally left blank**

## Introduction (Figure A1)

These versions of the DPI 610 and DPI 615 Calibrators provide manual generation of hydraulic pressure and consist of a screw-press with a priming pump and isolation valve.

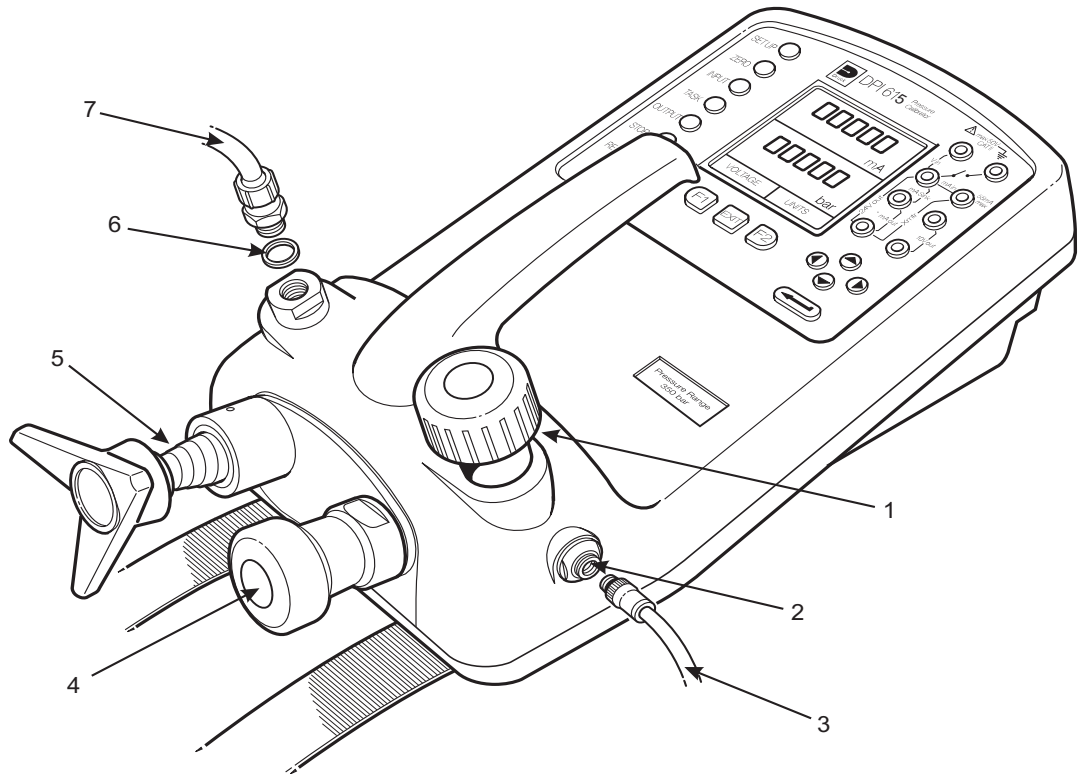

- 1 Isolation valve    2 Priming port    3 Bleed hose assembly    4 Priming pump
- 5 Screw-press    6 Bonded seal    7 UUT/system under test

**Figure A1 - DPI 610/615 HC Connections**

The internal hydraulic parts are brass, stainless steel, copper, nylon and fluorocarbon rubber (Viton). The hydraulic fluid can be either demineralized water or one of the hydraulic fluids listed below:

**Caution: Only use the recommended hydraulic fluids.**

**DO NOT mix hydraulic fluids.**

ISO 3448 Viscosity grade	Approx. SAE Viscosity Classification	Shell	Esso (Exxon)	Mobil
VG10	5W	Tellus R10	Nuto H10	Velocite No. 6
VG15		Tellus T15 Tellus V15	Nuto H15	
VG22		Tellus 22 Tellus R22	Nuto H22	DTE 22
VG32	10W	Tellus V32	Nuto H32	DTE Oil Light DTE 24
VG37		Tellus 37 Tellus R37 Tellus T37 Tellus V37		

**Table A1 - Recommended Hydraulic Fluids**

## Safety Instructions

### WARNING

HYDRAULIC FLUID IS INJURIOUS. OBSERVE RELEVANT HEALTH AND SAFETY PRECAUTIONS. USE APPROPRIATE PROTECTIVE BARRIERS AND EYE PROTECTION.

BEFORE APPLYING PRESSURE, EXAMINE ALL FITTINGS AND EQUIPMENT FOR DAMAGE AND ENSURE THAT ALL EQUIPMENT IS TO THE CORRECT PRESSURE RATING.

DO NOT EXCEED THE MAXIMUM WORKING PRESSURE OF THE INSTRUMENT (INDICATED ON START-UP SCREEN AT SWITCH-ON).

**Caution:** Observe absolute cleanliness when using the instrument. Severe damage can be caused if equipment connected to this instrument is contaminated. Connect only clean equipment to the instrument. To avoid any contamination, an external filter is recommended.

### Preparation for Use (Figure A1)

- Use an appropriate seal and connect the bleed hose assembly (3) to the priming port.
- Make sure that the screw-press (5) is wound fully in (clockwise).
- Make sure that the isolation valve (1) is open (fully counter clockwise).
- Use a bonded seal (6) and connect the unit or system under test (7) to the pressure port.

### WARNING

MAKE SURE THAT THE CONNECTING LINE TO THE EXTERNAL DEVICE OR SYSTEM IS CAPABLE OF WITHSTANDING THE LINE PRESSURE TO BE APPLIED.

*Note:* A bleed point must be provided on the external device.



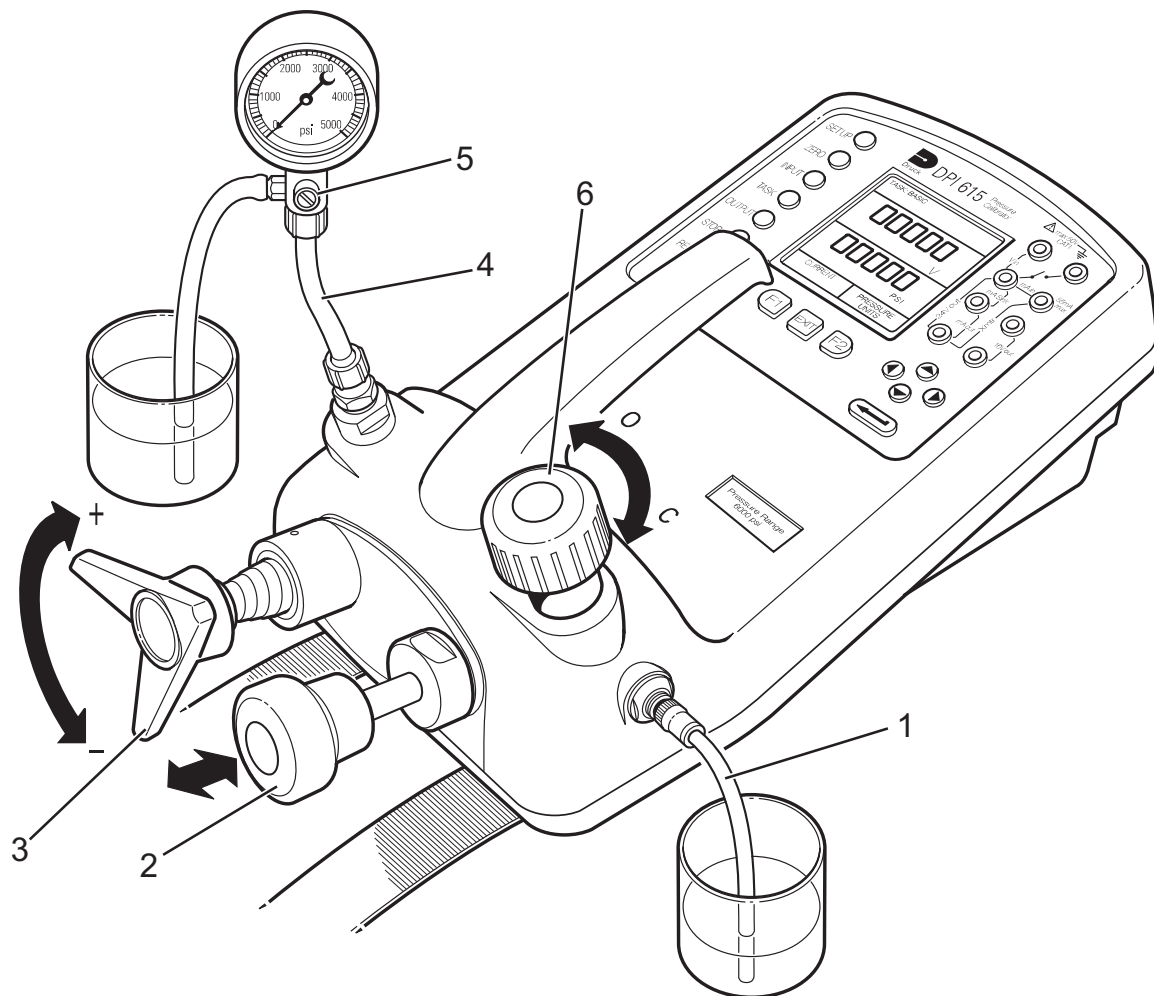

- |   |                       |   |                 |   |                 |
|---|-----------------------|---|-----------------|---|-----------------|
| 1 | Bleed hose assembly   | 2 | Priming pump    | 3 | Screw-press     |
| 4 | UUT/system under test | 5 | UUT bleed valve | 6 | Isolation valve |
| O | - Open                | C | - Closed        |   |                 |

**Figure A2 - Priming/Test Set-up**

### Bleeding the System (Figure A2)

Before any measurements can be made, the hydraulic system needs to be primed and bled free of air. During the following operations, prepare for fluid spillage and provide a suitable receptacle for collecting the spillage.

1. Prepare for use as detailed on page 62.
2. Fill a suitable container with clean hydraulic fluid and place the bleed hose assembly (1) connected to the priming port into the fluid.
3. Open the UUT bleed valve (5) and, if possible, fit a hose to the bleed point and locate the hose end in a container of the same hydraulic fluid.
4. Use the priming pump (2), to pump hydraulic fluid into the instrument and the connected system. Monitor the hydraulic fluid level, ensuring that the bleed hose assembly (1) stays below the fluid level and is not allowed to suck in air. Top-up hydraulic fluid level as necessary.

## Hydraulic Calibrator Versions

## Operation

5. Continue use of the priming pump (2) until only hydraulic fluid and no air is expelled from the bleed point.
6. Close the UUT bleed valve (5) when the priming pump (2) is at the bottom of its stroke (fully pushed in) and slowly wind out the screw-press (3) to its fullest extent to draw in further hydraulic fluid (approx. 7cc or 0.43 in<sup>3</sup>).
7. Switch the instrument **ON** and, still using the priming pump (2), pressurize the system to approximately 2 bar (30 psi).
8. Close the isolation valve (6) disconnect the bleed hose assembly (1) from the priming port.

### Operation

To obtain a pressure reading, proceed as follows.

1. Switch the instrument **ON** and select the required **TASK**.
2. Rotate the screw-press clockwise to increase the applied pressure.

**Note:** *When hydraulic fluid is compressed and flows through a restriction, there is an increase in temperature that affects the pressure. Allow sufficient time for this pressure reading to stabilize before recording or logging a reading.*

3. After testing, reduce the pressure in the system to zero by turning the screw-press counter clockwise. Before disconnecting the UUT, open the isolation valve.
4. Remove the connection to the UUT and fit a blanking plug into the instrument's pressure port. Clean any spilt fluid off the instrument case.

### Draining the Hydraulic Fluid (Figure A3)

To drain the hydraulic fluid from the instrument, proceed as follows:

1. Turn the isolation valve (4) fully counter clockwise. Turn the instrument onto the left hand side (pressure port nearest to the work bench). Place receptacle below the pressure port to collect hydraulic fluid.
2. Drain the system by slowly winding in the screw-press (3) and then depressing the priming pump (2) plunger to expel any fluid remaining in the instrument.
3. If necessary, apply an air line to the priming port to clear any remaining fluid out of the instrument.

## Flushing - Replenishing or Changing the Hydraulic Fluid (Figure A3)

If necessary, to remove any contaminants, flush out the hydraulic system as follows.

- a. Connect the bleed hose assembly (1) to the priming port and a bleed hose to the pressure port as shown below:

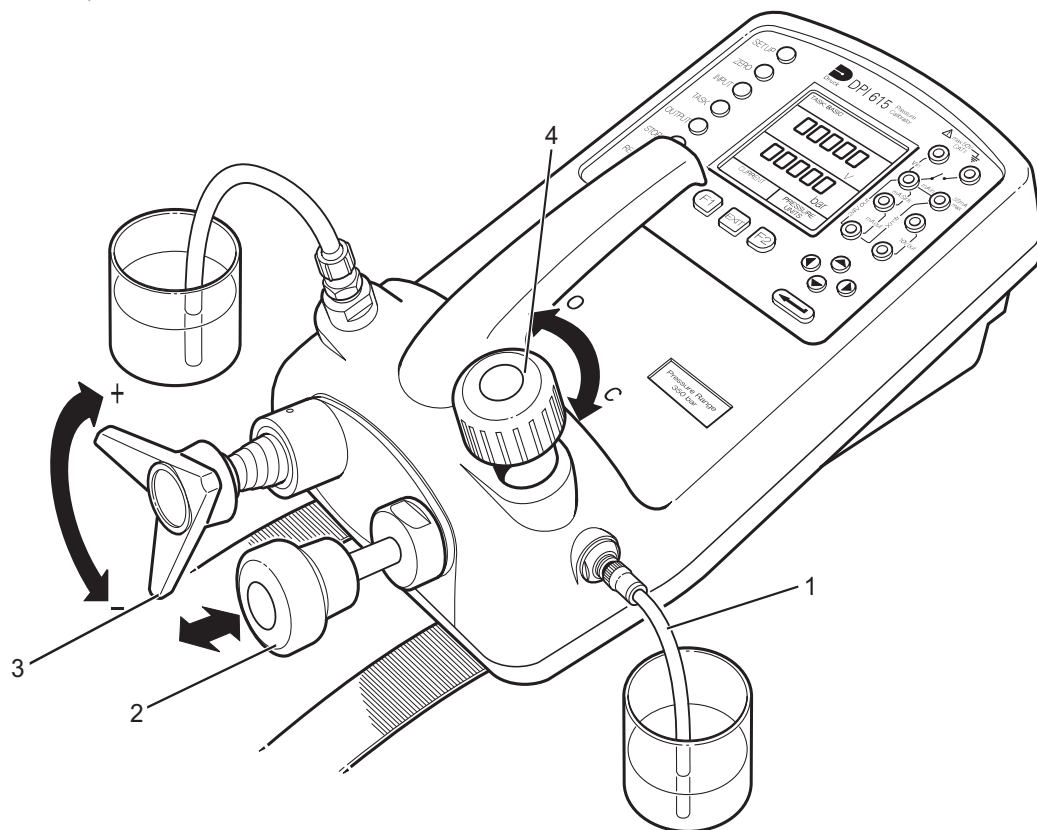

- |   |                     |   |              |   |             |   |                 |
|---|---------------------|---|--------------|---|-------------|---|-----------------|
| 1 | Bleed hose assembly | 2 | Priming pump | 3 | Screw-press | 4 | Isolation valve |
| O | - Open              | C | - Closed     |   |             |   |                 |

**Figure A3 - Flushing/Filling Connections**

- b. Fill the priming fluid container with clean hydraulic fluid of the required type. Use the priming pump (2), to pump fresh hydraulic fluid through the system until clean hydraulic fluid, free of air bubbles, emerges into the container at the output port. Discard the contaminated fluid expelled during this process.
- c. Remove the bleed hose assembly (1) located to the output port and, to prevent the ingress of any contaminant, fit a blanking plug in its place.
- d. Close the isolation valve (4) and remove the bleed hose assembly (1) from the priming inlet.
- e. Clean off any surplus oil that may have spilled onto the instrument casing.

The instrument is now ready for operation or storage. If storing, apply a label detailing the type of hydraulic fluid contained in the instrument. **For long term storage, it is recommended that the instrument be drained and stored empty.**

**This page intentionally left blank**

# Low Pressure Calibrator Versions

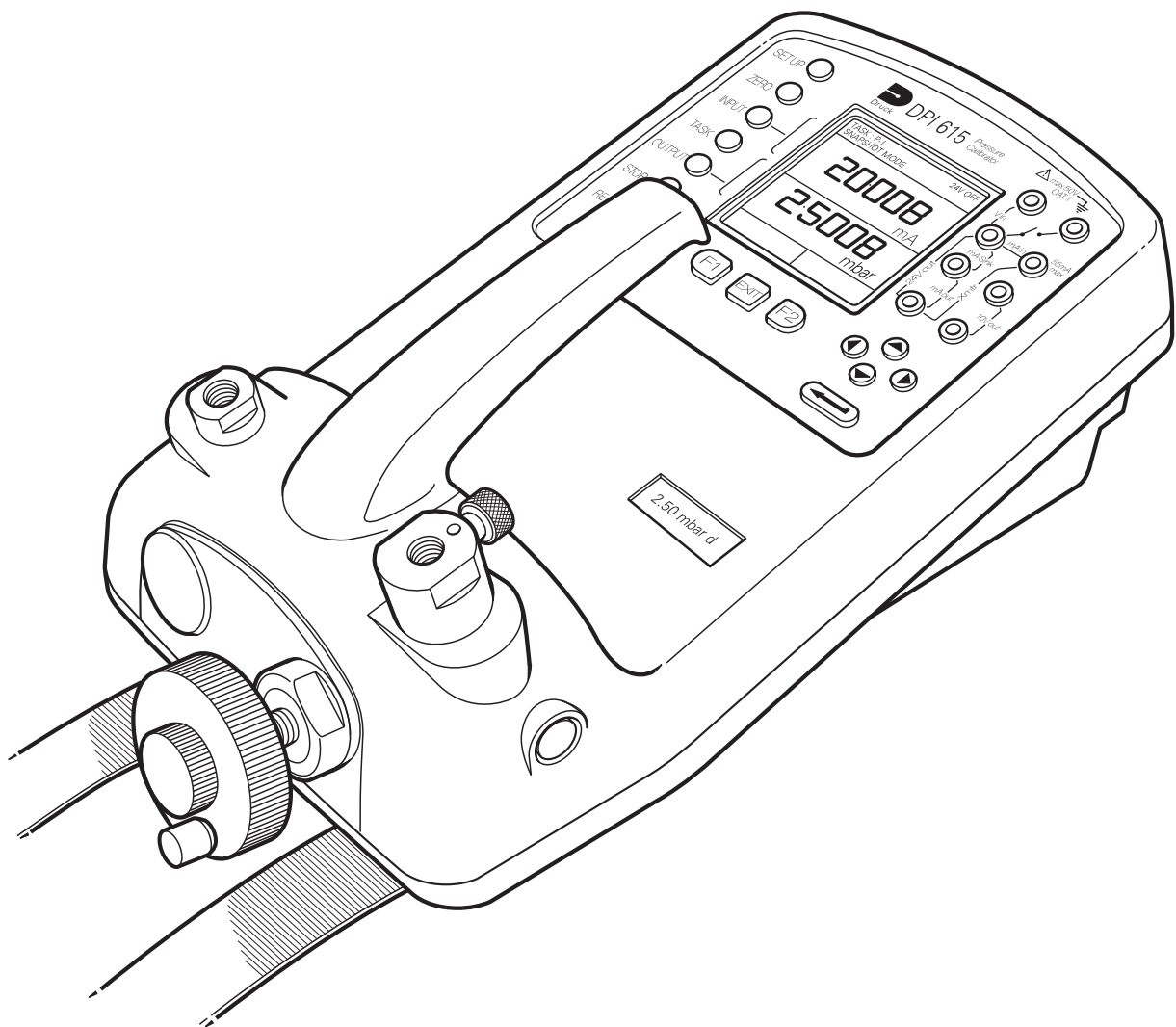

**This page intentionally left blank**

# Low Pressure Calibrator Versions

## Introduction (Figure B1)

These versions of the DPI 610 and DPI 615 Calibrator measure and display low differential pneumatic pressures applied to the pressure port. The differential pressure measurement ranges can be: 2.5, 12.5, 25, 50, 75 or 150 mbar (1.0, 5.0, 10.0, 20.0, 30.0 and 60.0 inH<sub>2</sub>O).

For low volume external systems or devices, test pressures are generated by an integral two-stage (coarse/fine) volume adjuster. For larger volume external systems or devices, test pressures are generated by an external, hand-operated, pneumatic pump.

An internal pressure limiter operates at 120% of the full-scale, positive or negative test pressure. If this over-pressure remains for more than approximately 1 second, a valve within the calibrator opens, directly connecting the positive and negative pressure ports together, to release the excess pressure. When the pressure decreases to within the operational limits, the valve automatically closes to allow normal operation to restart.

This section should be read in conjunction with the operation and calibration sections of this manual. All the operational features described for the standard calibrator are available on this low pressure version of the calibrator.

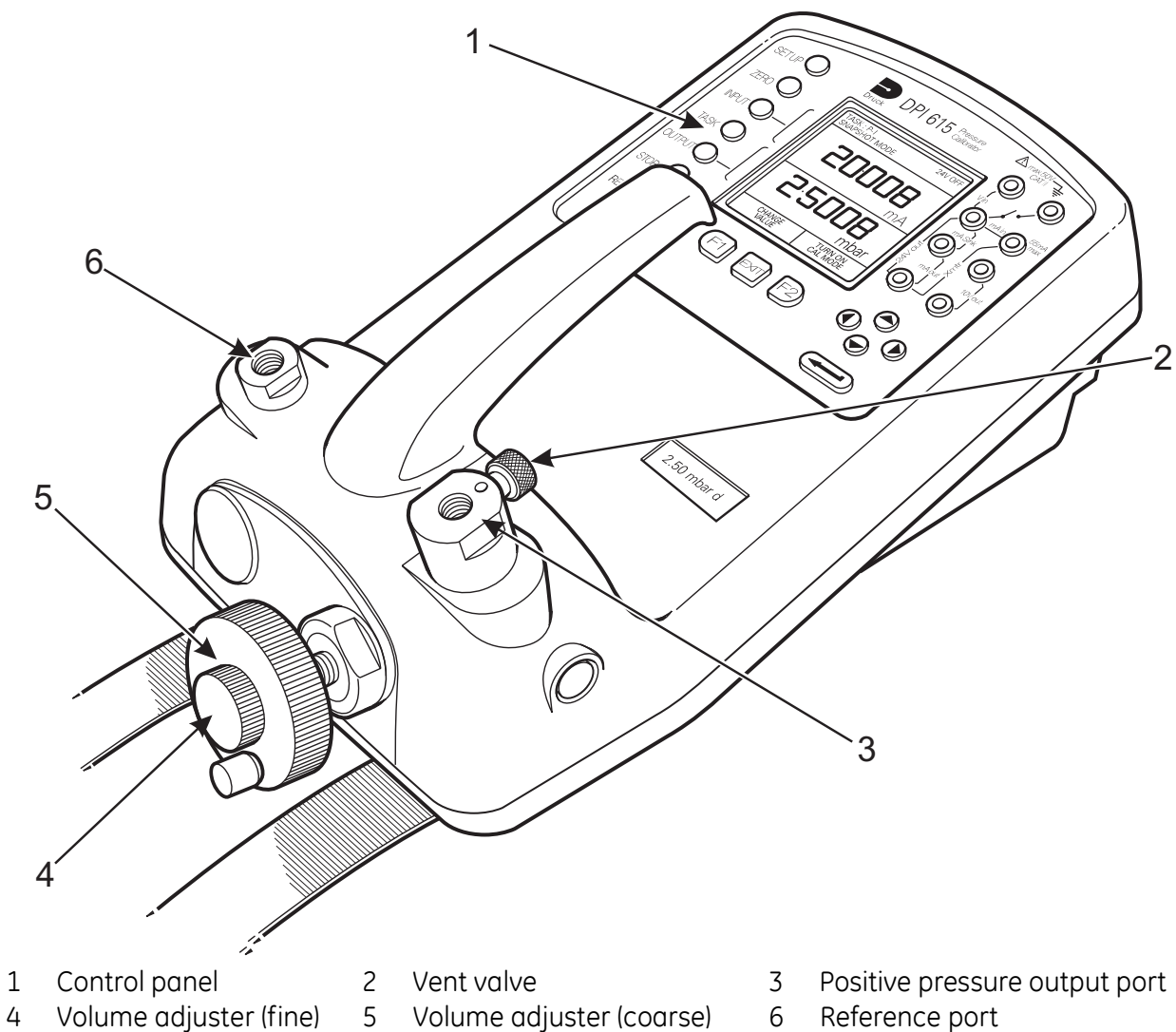

**Figure B1 - Calibrator Controls**

## Preparation for Use Low Volume Systems

**Caution:** This calibrator can produce a maximum differential pressure of 120% full-scale. Make sure any component connected to this calibrator can withstand this maximum differential pressure.

- Use the TASK key to set-up the calibrator for an appropriate test:

**Example:**

P-DISPLAY.

- To record test data for other tasks, set-up the calibrator to either Data log or Snapshot as required, refer to pages 30 or 31.
- Fit an appropriate pressure fitting to both the positive (+) and negative (-) ports using a bonded seal as shown in Figure B2. Ensure that both fittings are tight.
- To generate pressure, start with the volume adjuster wound fully out.
- To generate vacuum, start with the volume adjuster wound fully in.
- Ensure that the vent valve is open (fully counter-clockwise).
- Connect the device or system under test to both the reference (-) and the pressure port (+). Connect the ribbed arm of the double tubing to the high (+) pressure input of the device under test.

**Note:** To minimize temperature effects, always use double tubing, separating the arms of the tubing only by the minimum amount necessary to make the pressure connections. A typical application, P-DISPLAY, showing test connections to a Magnehelic pressure gauge are shown in Figure B2.

## Method of Testing with Low Volume Systems

- Connect the device under test to the calibrator and prepare for test as detailed above.
- Close the vent valve (turn fully clockwise).
- Zero the calibrator by pressing the ZERO key as in the sequence below:

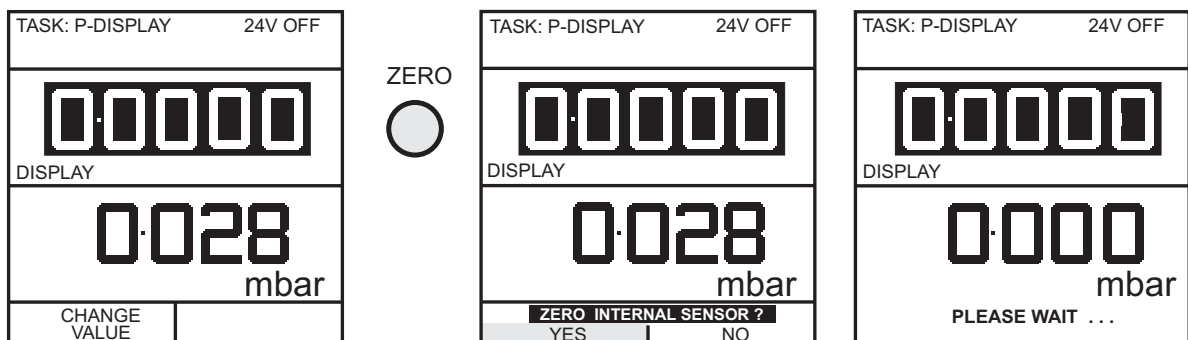



# Low Pressure Calibrator Versions

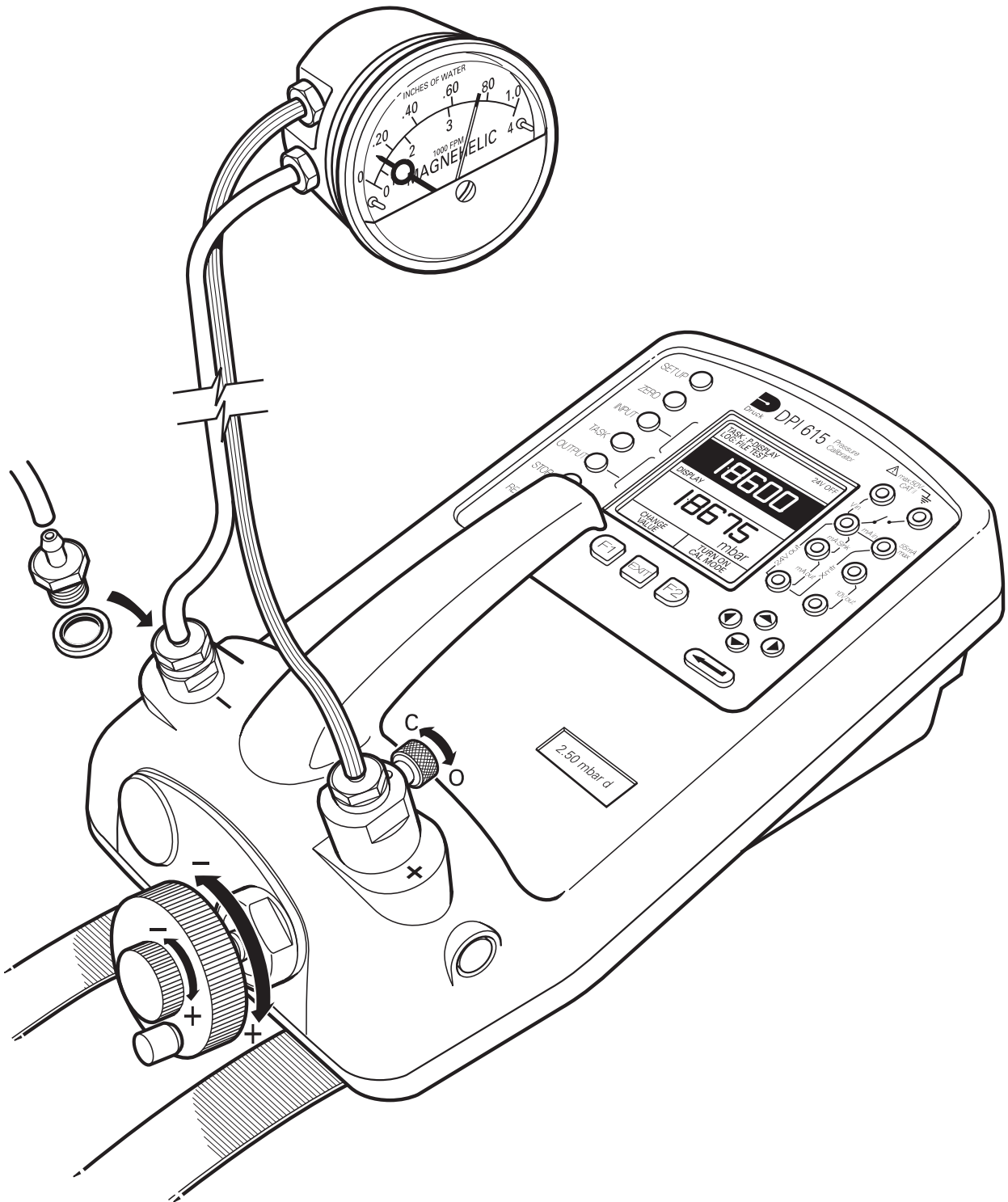

C - Closed

O - Open

Figure B2 - Test Connections

## Method of Testing with Low Volume Systems (continued)

- Turn the volume adjuster coarse control clockwise (counter-clockwise for vacuum) to set-up the required test pressure. Use the volume adjuster fine control to adjust the test pressure of the calibrator to exactly the required value.
- Use the TASK key to set-up the calibrator for an appropriate test:

### **Example:**

P-DISPLAY

- To record test data for other tasks, set-up the calibrator to either Data log or Snapshot as required (refer to pages 30 or 31). If required, and for DPI 615 calibrators only, switch on Cal Mode (refer to pages 11, 34 and 35).
- Turn the volume adjuster clockwise to set-up any additional test pressures required. The recommended method starts at 0, increasing to 10%, 25%, 50%, 75% and 100% full-scale and then decreasing to 75%, 50%, 25%, 10% and 0.

**Note:** *To release the output pressure at any point during a test or series of tests, open the vent valve. Allow sufficient time for the connected system to vent (very important when connected to larger system volumes, >0.25 litres [15 cubic inches]).*

## Preparation for Use with Larger Volume Systems

- Set-up the calibrator to record the test data, using either Data log or Snapshot facilities refer to pages 30 or 31. If required, and for DPI 615 calibrators only, switch on Cal Mode (refer to pages 11, 34 and 35).
- Fit the appropriate pressure fitting to both the positive (+) and negative (-) ports using a bonded seal as shown in Figure B3. Make sure that both pressure fittings are tight.
- Turn the volume adjuster (counter-clockwise) to approximately half-way (approximately 30mm (1") of thread showing).
- Make sure that the vent valve is open (fully counter-clockwise).
- Connect the hand-pump and tee-piece as shown in Figure B3. Connect the device or system under test to both the reference (-) and the pressure port (+) as shown. Connect the ribbed arm of the double tubing to the high (+) pressure input of the device under test.

**Note:** *To minimize temperature effects, always use double tubing, separating the arms of the tubing only by the minimum amount necessary to make the pressure connections. See Figure B3.*

# Low Pressure Calibrator Versions

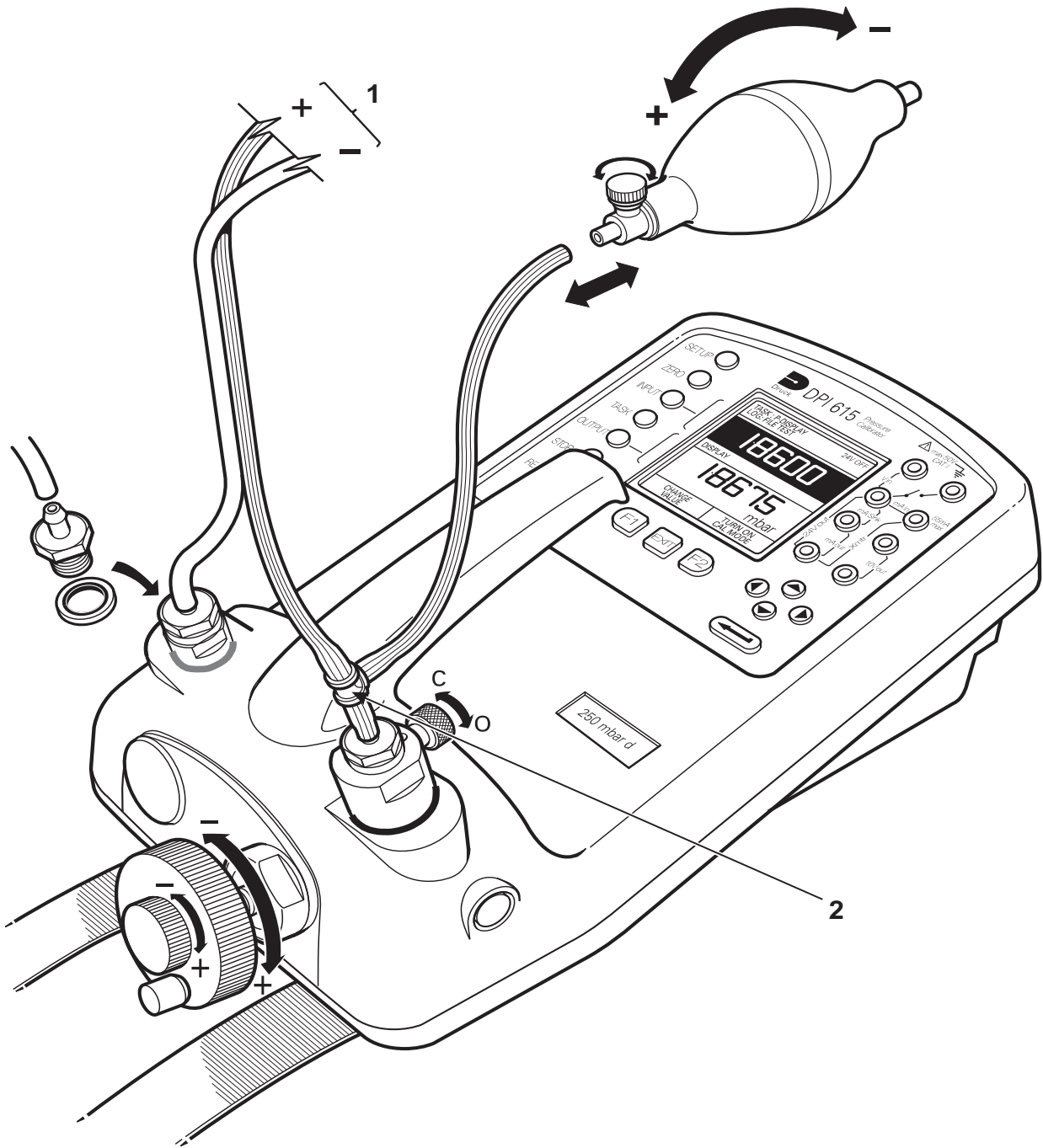

- |  |            |
|--|------------|
| 1 - To device/system under test                | C - Closed |
| 2 - Tee-piece inserted in positive output line | O - Open   |

**Figure B3 - Hand-pump Connections**

## Method of Testing with Larger Volume Systems

- Connect the device or external system under test to the calibrator and prepare for test as detailed on Page 72.

**Note:** To apply a negative differential pressure, connect the tee piece (refer to Figure B3), to the negative port and use the hand-pump to apply a positive pressure to the negative port.

- Close the vent valve (turn fully clockwise).
- Zero the calibrator by pressing the ZERO key as in the sequence below:

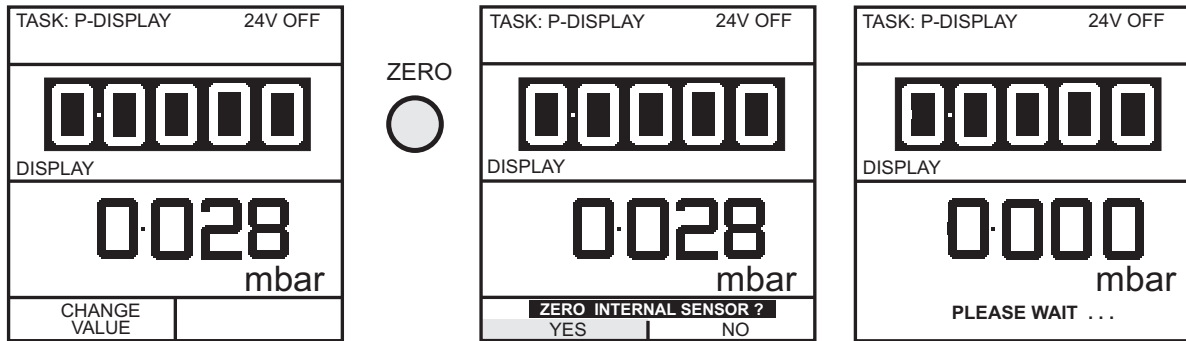

**CAUTION:** TO AVOID THE APPLICATION OF TRANSIENT OVER-PRESSURE PULSES TO SENSITIVE EXTERNAL SYSTEMS, SQUEEZE THE HAND-PUMP SLOWLY.

- Close the pump valve and operate the hand-pump to pressurize or depressurize the device or system under test to just above/below the required level.
- Adjust the output pressure to the required level by using the volume adjuster as a fine adjustment. Allow a short period for the pressure to stabilize before fine trimming.

**Note:** The larger the external volume, the less effect the volume adjuster will have on the output pressure.

- Record the test result using either data log or snapshot facility as required.
- Use the pump and volume adjuster to set-up any additional test pressures required. The recommended method starts at 0, increasing to 10%, 25%, 50%, 75% and 100% full-scale and then decreasing to 75%, 50%, 25%, 10% and 0. Record the results for each test pressure.

**Note:** To release the output pressure at any point during a test or series of tests, open the vent valve. Allow a few seconds for the connected system to vent. With larger volume systems connected, first disconnect both the reference and positive pressure lines from the calibrator and then reconnect before zeroing.

# Low Pressure Calibrator Versions

## Calibration

The calibration routines for the DPI 610 and DPI 615 Low Pressure calibrators are as described in calibration page 43, with the exception of the internal pressure range. The calibration procedure for the internal pressure range requires the application of five test pressures as detailed below.

**Note:** Refer to page 43 for the general procedures of calibrating the instrument. Refer to Table 1, page 44 for the transducer verification.

### Calibrate Internal Pressure Range

To calibrate the internal pressure range:

- Connect the outlet port of the instrument to a pressure standard.
- Switch the instrument **ON**.
- Allow at least one hour for the temperature of the instrument to stabilize.
- Select **SETUP** and enter the **SETTINGS** menu.

**Note:** *SETUP cannot be selected from BASIC mode.*

- Select **CALIBRATION** from the **SETTINGS** menu and enter the calibration PIN number (refer to page 45 for PIN number details).
- Select **PRESSURE INT** from the **CALIBRATION** menu (refer to page 46).
- Apply negative full-scale pressure to the instrument. Store the negative full-scale point:

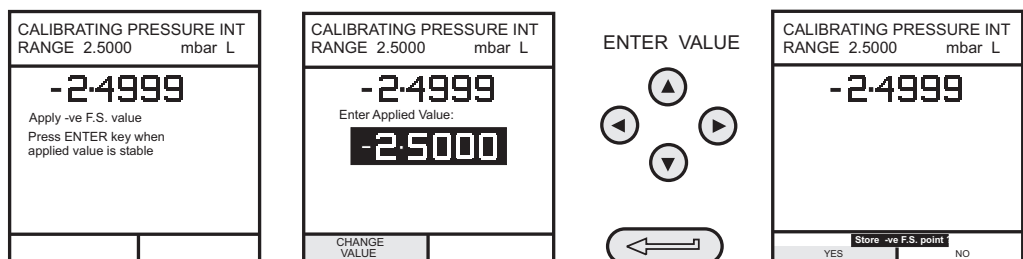

- Apply negative, half full-scale pressure to the instrument and store the negative half full-scale point:

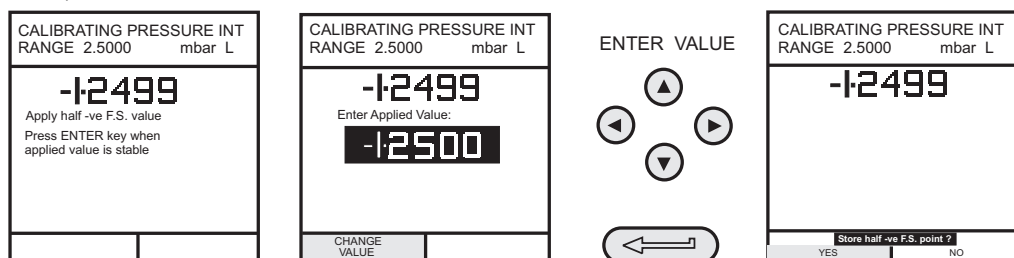

- Apply a nominal zero pressure to the instrument and store the zero point:

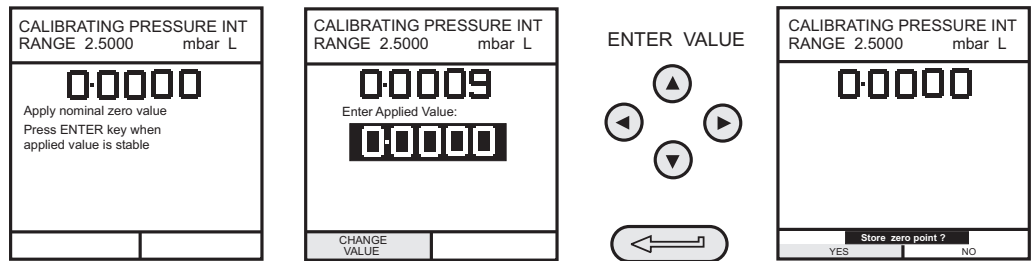

- Apply the positive, half full-scale pressure to the instrument and store the positive, half full-scale point:

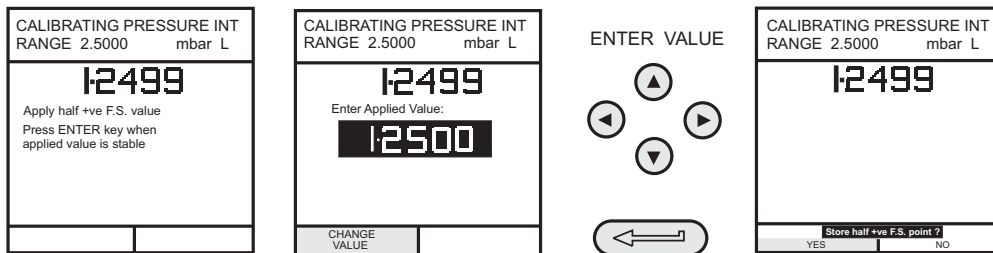

- Apply positive full-scale pressure to the instrument and store the full-scale point:

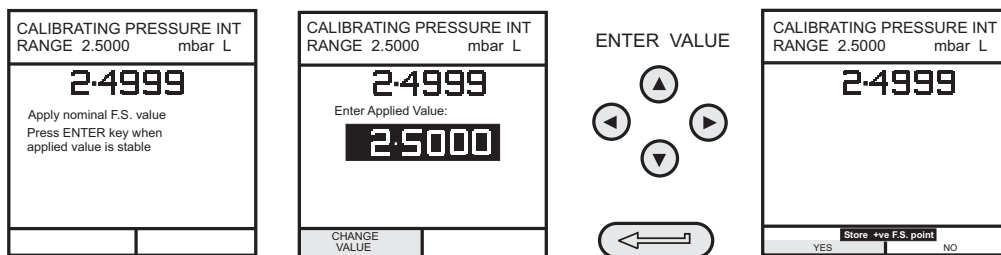

- After application of the final calibration pressure, the calibration results are displayed as shown below. To view the second page of calibration data press **MORE** (F1). Press **ENTER** to complete the pressure calibration procedure.

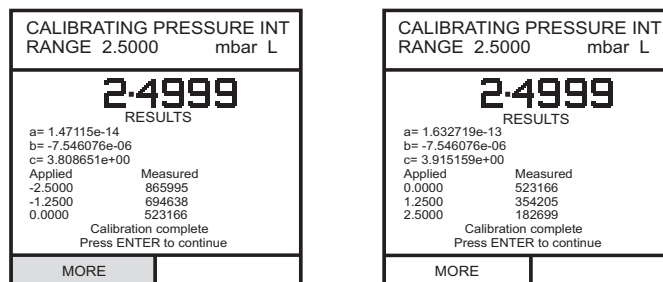

# Appendix 1

## DATA LOG FILE EXAMPLE

**This page intentionally blank**



## Typical Uploaded Data log File (DPI 610)

The following gives details of a typical data file upload.

FILENAME: TEST 5  
DATE: 05/11/1999  
TIME: 15:58  
TRIGGER: KEYPRESS  
AMBIENT TEMP : 24.1 C

NO. OF POINTS 11  
RECORD TYPE 0  
CURRENT mA PRESSURE INT bar

3.902	0.008	-0.65	%span	05/11/1999	15:58:55
6.076	2.311	1.42	%span	05/11/1999	16:00:03
7.598	4.404	0.47	%span	05/11/1999	16:00:57
8.085	5.023	0.41	%span	05/11/1999	16:01:45
9.949	7.249	0.94	%span	05/11/1999	16:02:42
13.002	11.300	-0.23	%span	05/11/1999	16:03:30
17.005	16.102	0.77	%span	05/11/1999	16:05:00
17.766	17.106	0.51	%span	05/11/1999	16:06:07
17.812	17.105	0.80	%span	05/11/1999	16:07:49
18.532	17.965	1.00	%span	05/11/1999	16:16:35
20.007	20.212	-1.02	%span	05/11/1999	16:18:23

The Record Type number contained in the header is a 16-bit field, with the individual bits representing result formats as detailed below.

Record Type 1	P-Display
Record Type 2	Switch Test
Record Type 4	Leak Test
Record Type 8	Input channel: Min/Max ON
Record Type 120	Combination of all input process functions
Record Type 896	Combination of all output process functions
Record Type 1024	mA step mode
Record Type 2048	mA value mode
Record Type 4096	mA ramp mode
Record Type 8192	no input selected
Record Type 16384	no output selected

## Typical Uploaded Procedure Data File (DPI 615)

The following gives details of a typical data file upload.

FILENAME: TEST 6  
DATE: 05/11/1999  
TIME: 15:58  
TRIGGER: KEYPRESS  
AMBIENT TEMP : 24.1 C

NO. OF POINTS 11  
RECORD TYPE 0  
CURRENT mA PRESSURE INT bar

3.902	0.008	-0.65	%span	PASS	05/11/1999	15:58:55
6.076	2.311	1.42	%span	FAIL	05/11/1999	16:00:03
7.598	4.404	0.47	%span	PASS	05/11/1999	16:00:57
8.085	5.023	0.41	%span	PASS	05/11/1999	16:01:45
9.949	7.249	0.94	%span	PASS	05/11/1999	16:02:42
13.002	11.300	-0.23	%span	PASS	05/11/1999	16:03:30
17.005	16.102	0.77	%span	PASS	05/11/1999	16:05:00
17.766	17.106	0.51	%span	PASS	05/11/1999	16:06:07
17.812	17.105	0.80	%span	PASS	05/11/1999	16:07:49
18.532	17.965	1.00	%span	PASS	05/11/1999	16:16:35
20.007	20.212	-1.02	%span	FAIL	05/11/1999	16:18:23

The Record Type number contained in the header is a 16-bit field, with the individual bits representing result formats as detailed below.

Record Type 1	P-Display
Record Type 2	Switch Test
Record Type 4	Leak Test
Record Type 8	Input channel: Min/Max ON
Record Type 120	Combination of all input process functions
Record Type 896	Combination of all output process functions
Record Type 1024	mA step mode
Record Type 2048	mA value mode
Record Type 4096	mA ramp mode
Record Type 8192	no input selected
Record Type 16384	no output selected