

## Connecting the 34401A to a PC using Agilent Connection Expert

Agilent Connection Expert (ACE) is an Agilent IO Libraries utility that configures the IO interface between the 34401A and your PC. The IO Libraries are contained on the Agilent Automation-Ready CD or may be downloaded from the Agilent Developer Network website at: <http://adn.tm.agilent.com>.

1. Install the Agilent IO Libraries on your PC and connect a GPIB cable between the PC and the 34401A.
2. From the PC taskbar, click the Agilent IO Control icon and select 'Agilent Connection Expert' from the menu.



3. Select the PC's GPIB interface and select 'Add Instrument' from the Connection Expert menu bar.

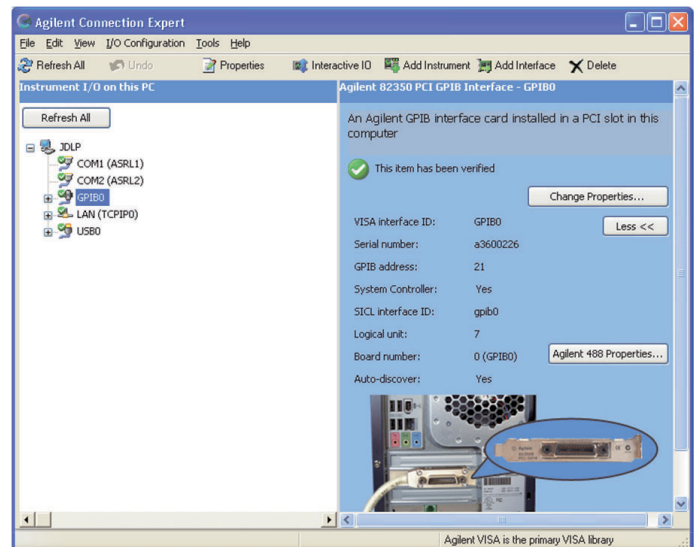

4. Select the GPIB0 interface and then select the 34401A GPIB address (factory setting = 22).

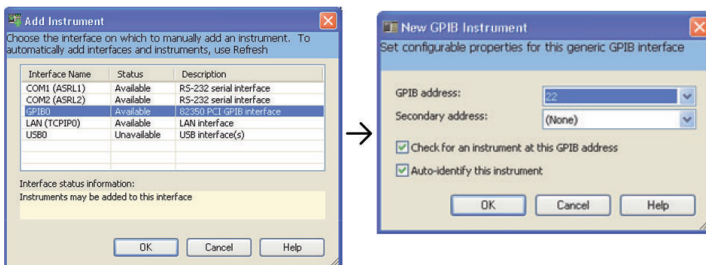

5. To verify the IO connection, open 'Interactive IO' and send the \*IDN? command to the 34401A by selecting "Send & Read".

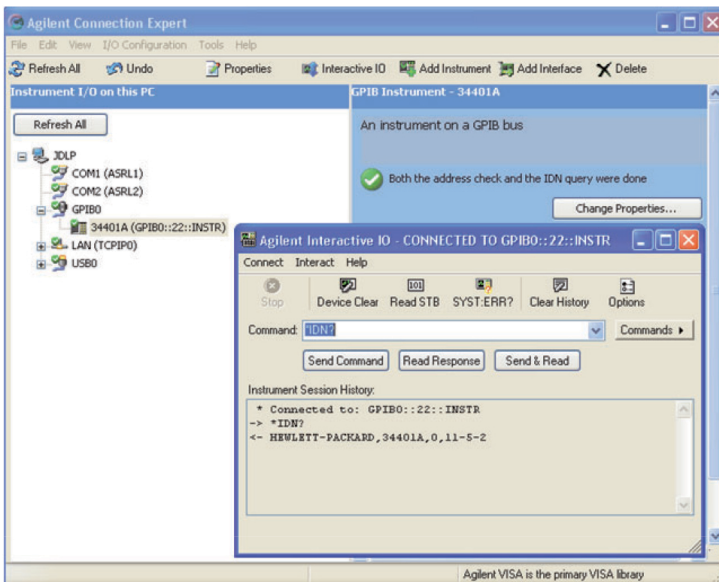

6. Use the 'Options' tab to increase the timeout period for commands with execution times > 5 ms (e.g. \*TST?).

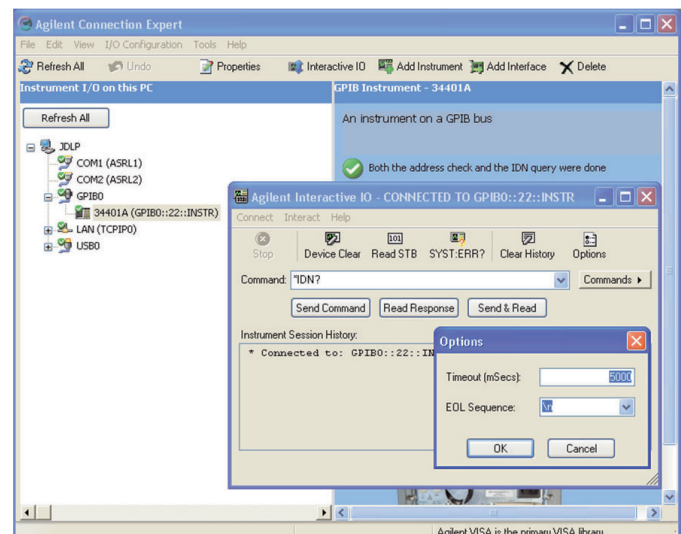

## Safety Summary

Do not defeat power cord safety ground feature. Plug in to a grounded (earthed) outlet. Do not use product in any manner not specified by the manufacturer.

Do not install substitute parts or perform any unauthorized modification to the product. Return the product to Agilent Technologies or a designated repair center for service to ensure that safety features are maintained.

### WARNING

A WARNING notice denotes a hazard. It calls attention to an operating procedure, practice, or the like that, if not correctly performed or adhered to, could result in personal injury or death. Do not proceed beyond a WARNING notice until the indicated conditions are fully understood and met.

### CAUTION

A CAUTION notice denotes a hazard. It calls attention to an operating procedure, practice, or the like that, if not correctly performed or adhered to, could result in damage to the product or loss of important data. Do not proceed beyond a CAUTION notice until the indicated conditions are fully understood and met.

### Symbols



Earth Ground



Chassis Ground



Risk of electric shock



Refer to manual for additional safety information.

**CAT II (300 v)** IEC Measurement Category II. Inputs can be connected to mains (up to 300 VAC) under Category II overvoltage conditions.

### WARNING

**Main Power and Test Input Disconnect:** Unplug product from wall outlet, remove power cord, and remove all probes from all terminals before servicing. Only qualified, service-trained personnel should remove the cover from the instrument.

**Line and Current Protection Fuses:** For continued protection against fire, replace the line fuse and the current-protection fuse only with fuses of the specified type and rating.

**Front/Rear Switch:** Do not change the position of the Front/Rear switch on the front panel while signals are present on either the front or rear set of terminals. Switching while high voltages or currents are present may cause instrument damage and lead to the risk of electric shock.

**IEC Measurement Category II.** The HI and LO input terminals may be connected to mains under IEC Measurement Category II overvoltage conditions for measurement of line voltages up to 300 VAC. To avoid the danger of electric shock, do not connect the inputs to mains for line voltages above 300 VAC. Connect to mains only at an outlet, or in a device connected to such an outlet, on a branch circuit protected by a circuit breaker. See "Safety Notices" in the *User's Guide* for further information.

**Protection Limits:** To avoid instrument damage and the risk of electric shock, do not exceed any of the protection limits indicated on the terminal panel and defined in the *User's Guide*.

### ADDITIONAL SAFETY INFORMATION

For further information, refer to the "Safety Notices" section in the *Agilent 34401A User's Guide*.



# Agilent 34401A 6½ Digit Multimeter Quick Start Tutorial



**Product Reference CD-ROM.** All product documentation, software, and examples are included on the *Agilent 34401A Product Reference CD-ROM*.

## 1. Preparing for Use

### Connect the Power Cord.

Then plug in the instrument.

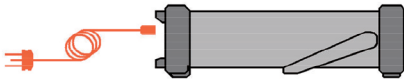

*Line voltage switch is set at factory for country of destination – verify setting before applying power.*

### Adjust the Carry Handle.

Grasp the handle by the sides and *pull outward*:



Then adjust the handle to the desired position:

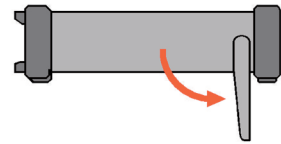

### Connect the Test Leads to the Input Terminals.

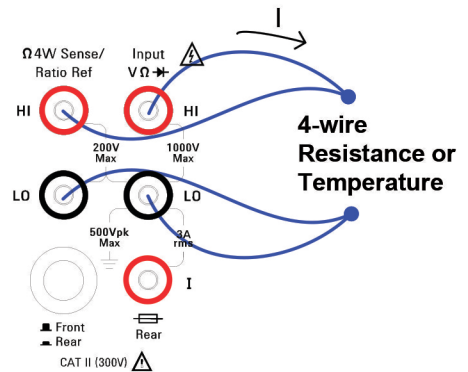
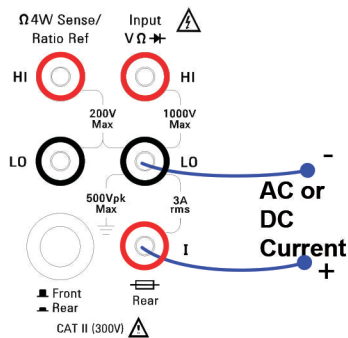
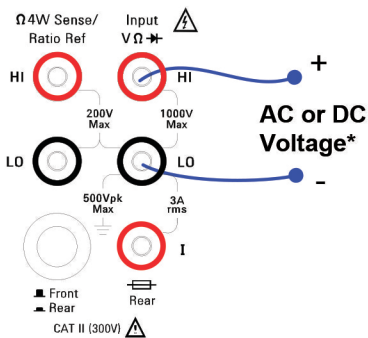

\* Also used for capacitance, continuity, diode test, frequency, 2-wire resistance, and 2-wire temperature measurements.

See "Safety Summary" on the back of this tutorial.

Turn  
Page for  
Step 2

## 2. Power, Input Terminal Selection, and Local Control



- turns the 34401A on and off. A self-test occurs during the power-on sequence.



- selects the front or rear panel terminals as the input to the 34401A.



- transfers instrument control from the computer (remote) to the front panel (local).

Example: display indicating remote operation and rear panel terminals selected.

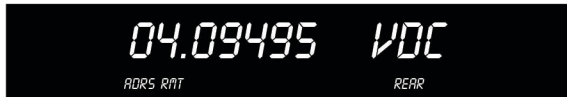

## 3. Setting the Function

The measurement function is set using the following keys:

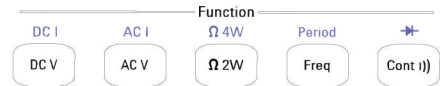

- when preceded by the "Shift" key the functions shown above the keys are selected.

Example: Period function selected



## 4. Setting the Range and Resolution

The measurement **range** is unique to the selected function. The range is set using the following keys:



- selects between auto-range and manual range

- manually decreases the range

- manually increases the range

Example: display indicating 10 volt range, 4 digit resolution



**Resolution** is the number of digits the 34401A can measure or display. Resolution is also unique to the function selected and is set using the following keys:



- selects 4 digit resolution

- selects 5 digit resolution

- selects 6 digit resolution

For increased measurement speed, select 4 digits. For increased accuracy, select 6 digits.

## 5. Math Operations

Selected math operations are available from the 34401A front panel using the keys:

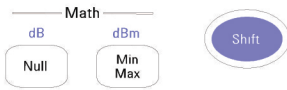

**Null** - value subtracted from the measurement (Math menu: NULL VALUE)  
reading = measurement – null value

**Min Max** - displays minimum and maximum values for the triggered set of readings.

Example: maximum value indicated with Math operation 'Min/Max' enabled

05.02287 MAX

MATH

dB



- dB measurement relative to value in 'dB Relative' register (register value is first db measurement after dB function is enabled).

dBm



- dBm measurement relative to a resistance referenced to 1 mW (Math menu: dBm REF R).

reading =  $10\text{Log}_{10}(\text{measurement}^2 / \text{reference resistance} / 1\text{mW})$

Example: dBm measurement @ ~ 3 VDC - 600Ω reference resistance

11.7842 DBm

MATH

## 6. Triggering

Measurements are triggered from the front panel using the following keys:



**Single Trig** - disables auto-triggering (default) and issues a single trigger to the 34401A each time the key is pressed.

**Auto/Hold** - **Auto**: enables auto-triggering if the 34401A is in single trigger mode (above).

**Auto/Hold** - **Hold**: displays the measurement after three consecutive readings within the sensitivity band (Trigger menu: READ HOLD).

## 34401A Power-on and Reset States

### Measurement Configuration

Function	DCV
AC Filter	20 Hz
Range	Autorange
Resolution	5 digits, slow mode
Integration Time	10 PLCs
Autozero	On
Input Resistance	10 MΩ
Continuity Threshold	10Ω

### Math Operations

State	Off
Function	Null
dBm Reference Resistance	600Ω
Registers	Cleared

### Triggering

Trigger Source	Auto-trigger
Trigger Delay	Automatic
Samples Per Trigger	1
Reading Hold Sensitivity	0.10% of range

### Other

Reading Memory	Cleared
----------------	---------

## Menu Navigation

The front panel menu provides access to a subset of the 34401A functionality. The menu is navigated using the following keys:

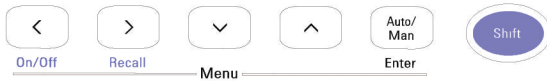

Sequence:

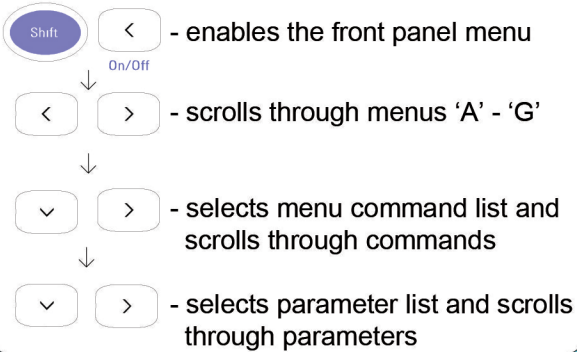

Auto/Man Enter - selects (saves) parameter and exits the menu (Enter is not a shifted function).

Shift Recall - enables menu (if off) and recalls the last command displayed when the menu was exited.

Note: for numeric parameters (0-9):

> ↓ ↑ - selects and increments/decrements each digit individually

Example: number of reading samples increased to 5

## Front Panel Menu Reference

### A: MEAS MENU

1: AC FILTER > 2: CONTINUITY > 3: INPUT R > 4: RATIO FUNC > 5: RESOLUTION

### B: MATH MENU

1: MIN-MAX > 2: NULL VALUE > 3: dB REL > 4: dBm REF R > 5: LIMIT TEST > 6: HIGH LIMIT > 7: LOW LIMIT

### C: TRIG MENU

1: READ HOLD > 2: TRIG DELAY > 3: N SAMPLES

### D: SYS MENU

1: RDGS STORE > 2: SAVED RDGS > 3: ERROR > 4: TEST > 5: DISPLAY > 6: BEEP > 7: COMMA > 8: REVISION > 9: STORE STATE > 10: RCL STATE > 11: POWER ON

### E: I/O MENU

1: GPIB ADDR > 2: INTERFACE > 3: BAUD RATE > 4: PARITY > 5: LANGUAGE

### F: CAL MENU

1: SECURED > [1: UNSECURED > 2: CALIBRATE] > 3: CAL COUNT > 4: MESSAGE