



**Advanced Test Equipment Rentals**  
**www.atecorp.com 800-404-ATEC (2832)**

**FLUKE®**

**1520**  
*MegOhmMeter*

**Users Manual**

September 2000 Rev.2, 2/03  
© 2000-2003 Fluke Corporation. All rights reserved. Printed in USA  
All product names are trademarks of their respective companies.



## ***Table of Contents***

<b>Title</b>	<b>Page</b>
Unpacking the Meter.....	1
Safety Information and Symbols .....	3
Key functions .....	6
Display .....	8
Using the Meter .....	10
Connecting to the Circuit Under Test .....	10
Auto-Shut-Off.....	12
Measuring Insulation Resistance .....	12
Measuring Low Resistance .....	16
Measuring Resistance.....	18
Measuring Voltage .....	18
Checking the Battery.....	19
Maintaining the Meter .....	20
Cleaning.....	20
Replacing and Disposing of the Batteries.....	21
Testing and Replacing the Fuse.....	24
Replacement Parts and Optional Accessories .....	27
Principle of Measurement for Resistance.....	28
Service Centers .....	28
Specifications.....	29



## ***List of Tables***

<b>Table</b>	<b>Title</b>	<b>Page</b>
1.	Key and Switch Descriptions.....	6
2.	Display Description .....	8

## ***List of Figures***

<b>Figure</b>	<b>Title</b>	<b>Page</b>
1.	Shipment Content .....	2
2.	Display .....	9
3.	Connecting to the Circuit Under Test .....	11
4.	Display Example .....	19
5.	Replacing the Batteries.....	23
6.	Replacing the Fuse .....	26

# Fluke 1520

## *Unpacking the Meter*

The Fluke Model 1520 MegOhmMeter (hereafter, “the meter”) is a handheld instrument designed primarily to make resistance/insulation resistance measurements.

The MegOhmMeter includes the following items, see Figure 1:

- 2 test leads, red and black, 1.5 m
- 2 test probes, red and black
- 2 alligator clips, red and black
- Hand strap
- Carrying case
- CD ROM (Not Pictured)

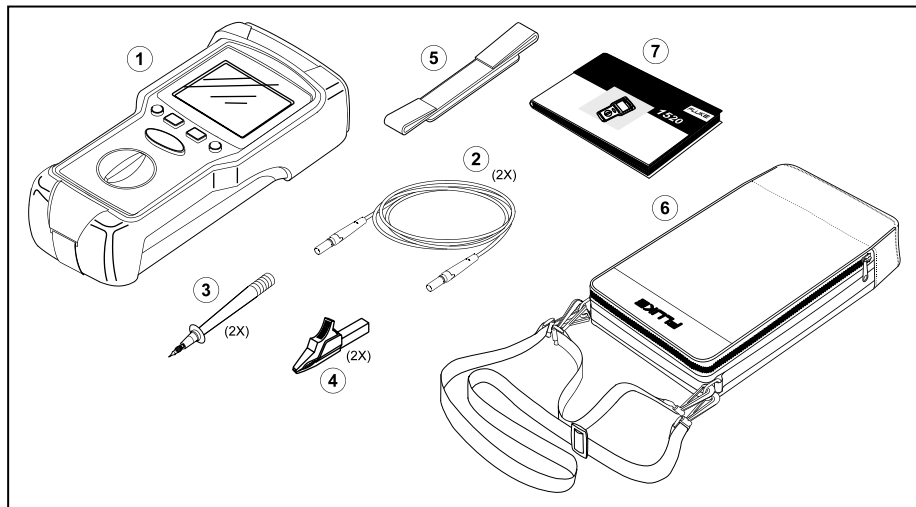











acf02f.eps

**Figure 1. Shipment Content**

## Safety Information and Symbols

A **Caution** identifies conditions and actions that may damage the Meter. A **Warning** identifies conditions and actions that pose hazard(s) to the user. International symbols on the Meter and in the manual are explained below.

	Risk of electric shock		Earth
	See manual		Fuse
	Equipment protected by double or reinforced Insulation		AC or DC
	Battery		Recycling information
	Conforms to CSA C22.2 No 1010.1-92 + Amendment 2 1997, UL 3111 and ANSI/ISA SP82.01 1994	VDE	Conforms to VDE EN61010 (Pending)
	Conforms to EU directives		Conforms to UL 3111.1
CAT III	OVERVOLTAGE (Installation) CATEGORY III, Pollution Degree 2 per IEC1010-1 refers to the level of Impulse Withstand Voltage protection provided. Equipment of OVERVOLTAGE CATEGORY III is equipment in fixed installations (e.g., electricity meter and primary over-current protection equipment).		



**⚠ Safety Information**

Use of instrument in a manner not specified by the manufacturer may impair safety features/protection provided by the equipment. Read the following safety information carefully before using or servicing the instrument. To avoid electric shock or fire, do the following:





- **Avoid working alone.**
- **Inspect the test leads for damaged insulation or exposed metal. Check test lead continuity. Damaged leads must be replaced. Do not use the Meter if it looks damaged.**
- **Be careful when working above 30 V ac rms, 42 V ac peak and 60 V dc. Such voltages pose a shock hazard.**
- **When using the probes, keep your fingers away from probe contacts. Keep your fingers behind the finger guards on the probes.**
- **Measurements can be adversely affected by impedances of additional operating circuits connected in parallel or by transient currents.**
- **Verify operation prior to measuring hazardous voltages (voltages above 30 V ac rms, 42 V ac peak and 60 V dc).**

**⚠ Safety Information (cont.)**





- **Place test leads in proper input terminals.**
- **Disconnect the live test lead before disconnecting the neutral test lead.**
- **Do not use the Meter if the battery indicator (  ) shows a battery empty condition.**
- **Use only Fluke recommended batteries and fuse.**
- **Do not use the Meter with any parts or cover removed.**
- **Do not use the Meter around explosive gas, vapor or dust.**
- **Disconnect the test leads from power sources and from the Meter before changing the batteries or fuse.**
- **Do not use the Meter in a wet environment.**
- **Use only Fluke specified test leads.**

## Key functions

**Table 1. Key and Switch Descriptions**

	<p><b>Rotary switch</b> To select a measurement function.</p>
	<p>Used for the Insulation Resistance and Low Resistance test functions. Press and hold this button until the main reading is stable.</p>
	<p>Locks the test in Insulation Resistance or Low Resistance function. To lock: press and hold TEST, then press LOCK and simultaneously release both buttons. The icon  <b>LOCK</b> appears on the display.</p> <ul style="list-style-type: none"><li>• Insulation Resistance- this mode continuously applies the test voltage to the circuit to be tested. The beeper sounds every 2 seconds to remind you that you are in the Lock mode.</li><li>• Low Resistance- this mode continuously applies the test current to the circuit to be tested.</li></ul> <p>To unlock: press LOCK or TEST again.</p>

**Table 1 (continued)**

	<p><b>Resistance Beeper function</b> Turns the Beeper function ON and OFF. When ON, the  icon appears on the display and the Meter beeps at short circuit.</p>
	<p><b>Low Resistance function</b> Turns the test lead resistance compensation ON. The  icon appears on the display. To compensate, touch the probe tips together, then press and hold ZERO until the Meter beeps. The main display indicates <b>0.00</b>.</p>
	<p><b>Backlight button</b> Turns the display backlight ON and OFF.</p>

## Display

Table 2 and Figure 2 describe the display.

**Table 2. Display Description**

1	Voltage applied to the probes in Insulation Resistance function.
2	Low Resistance/Resistance function indicator.
3	Resistance reading held from the last measurement in Insulation Resistance or Low Resistance function.
4	Beeper symbol shows if beeper function is turned on in Resistance function.
5	Zero symbol is on if test leads are zeroed out.
6	Main reading display for all functions.
7	Analog bar graph displays resistance on a logarithmic scale and voltage on a linear scale. The value always tracks the main reading.
8	High voltage warning symbol flashes if voltage $\geq 30$ V ac or dc is present on the probes.
9	Battery life indicator. Displays briefly when the Meter is first switched to a function. Displays the amount of battery voltage left in increments of 25 %.
10	Lock symbol is on if the TEST mode is locked in Insulation or Low Resistance functions.

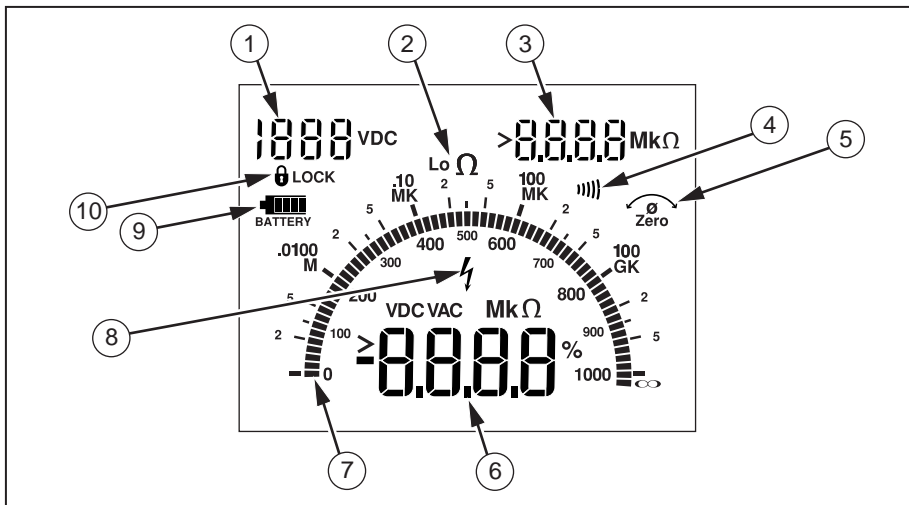

Figure 2. Display

ac12f.eps

## **Using the Meter**

### **Connecting to the Circuit Under Test**

Figure 3 shows the proper connections.

**⚠ Warning**

**To prevent electric shock when performing resistance tests, remove all power from the circuit to be measured.**

**⚠ Warning**

**To prevent electric shock, first connect the test leads to the Meter inputs before you make connection to the circuit under test.**

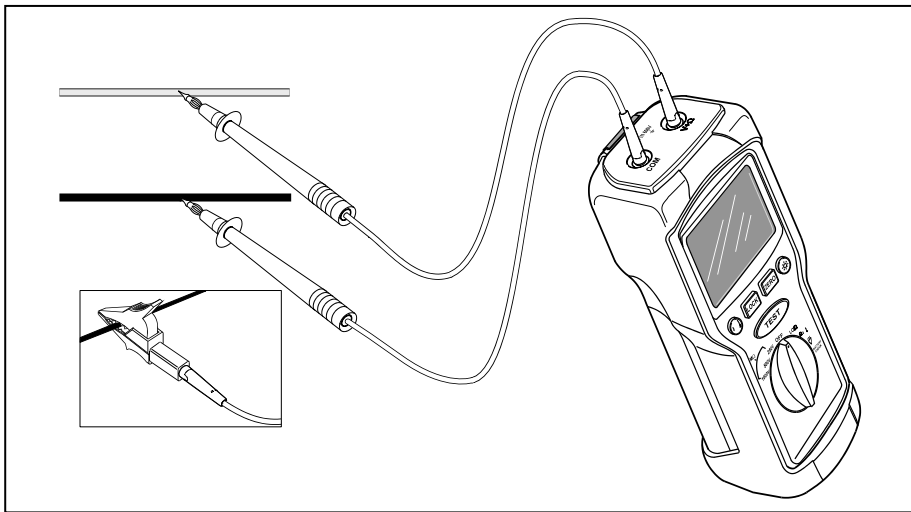

acf04f.eps

**Figure 3. Connecting to the Circuit Under Test**



### **Auto-Shut-Off**

The Meter automatically turns off after 15 minutes of non-use. In Lo Ohms mode, the meter turns off after 5 minutes of non-use. To turn the meter back on, turn the rotary switch to OFF, then to the desired function.

### **Measuring Insulation Resistance**

#### **Warning**

- **Measuring insulation resistance requires the application of potentially dangerous voltages to the circuit. This may include exposed bonded metalwork.**
- **Before proceeding, ensure that the installation is correctly wired and no personnel are endangered by any tests.**

To measure insulation resistance, do the following:

1. Select the test voltage.
2. Connect the probes to the circuit to be measured.  
The meter automatically detects if the circuit is energized, and displays the detected voltage.

**⚠ Warning**

**A repetitive beep and the flashing high voltage symbol (⚡) warn the user if voltage more than 30 V ac or dc is present. If the voltage is > 30 V ac or dc, remove the voltage from the circuit under test before proceeding with the next step.**

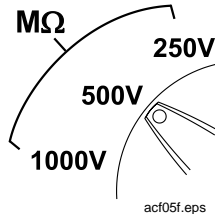

3. Push and hold the TEST button. The upper left display shows the test voltage applied to the circuit under test. The main display shows the resistance.

*Note*

*The display shows - - - until the TEST button is pushed.*

The Meter beeps when the reading is stable. The upper right display shows the same resistance reading as the main display.

When resistance is higher than the maximum display range, the meter reacts as follows:

- If the 250V range is selected, the display reads **>1000 MΩ**.
- If the 500V range, is selected, the display reads **>2000 MΩ**.
- If the 1000V range, is selected, the display reads **>4000 MΩ**.

4. While keeping the probes on the test points, release the TEST button.

The circuit now discharges through the Meter, while the main reading shows the decreasing voltage.

Keep the probes touched to the test points until the circuit is completely discharged (the main display shows - - - -).

The upper right display holds the resistance reading until a new test is started or a different function is selected.

### **Using the LOCK Function to Measure Insulation Resistance**

The LOCK function holds the test voltage on the probes. Use LOCK to make long duration measurements without having to push and hold the TEST button.

To use the LOCK function:

1. Press the TEST button, then press the LOCK button, and then release both simultaneously.

#### **⚠ Warning**

**In this mode a potentially dangerous voltage is continuously applied to the probes.**

**In this mode, if the probes are disconnected from the circuit, the Meter cannot discharge any potentially dangerous capacitive voltages left on the circuit.**

#### **Caution**

**In this mode the Meter cannot indicate if the circuit is live.**

**Ensure that the circuit is de-energized before connecting the test probes in this mode.**

2. Press LOCK or TEST to disengage the lock function.

## Measuring Low Resistance

To measure low resistance:

1. Zero out the test lead resistance (see Table 1).
2. Connect the probes to the circuit to be measured.  
If voltage is present on the probes, the voltage is displayed.

### **⚠ Warning**

**A repetitive beep and the flashing high voltage symbol ( $\text{⚡}$ ) warn the user if voltage more than 30 V ac or dc is present. If the voltage is  $> 30$  V ac or dc, remove the voltage from the circuit under test before proceeding with the next step.**

3. Press and hold the TEST button. A single beep indicates a stable reading. The resistance shows on the main display. If the resistance is higher than  $40 \Omega$ ,  $>40 \Omega$  is displayed.
4. Release the TEST button. The upper right display holds the resistance reading until a new test is started or a different function is selected.

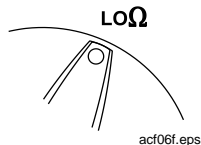

5. Exchange the red (+) and black (-) probes on the circuit and repeat steps 3 and 4 to reverse the polarity of the test current. The reading should be the same as the previous. This test is useful to detect corroded connections, which can cause different readings for both polarities.

### ***Using the LOCK Function to Measure Resistance***

The LOCK function is used to continuously supply the test current to the circuit to be tested. This is useful for making several measurements in succession without having to push and hold the TEST button for each measurement.

1. Press the TEST button, then press the LOCK button, then release both simultaneously.
2. You can now probe the desired test locations in succession.
3. Press LOCK or TEST to disengage the lock function.

#### **Caution**

**The Meter cannot indicate if the circuit is live in this mode.**

**Ensure that the circuit is de-energized before connecting the test probes in this mode or the fuse may blow.**

### Measuring Resistance

1. Connect the probes to the circuit to be measured. Measure voltage first to ensure that no hazardous voltage is present, then switch to Ohms.
2. If the resistance is approximately 30  $\Omega$  or less, the Meter beeps. To turn off the beeper, press the beeper button. If the resistance is higher than 4000  $\Omega$ , **>4000  $\Omega$**  is displayed.

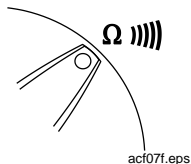

### Measuring Voltage

1. Connect the probes to the circuit to be measured.
2. If the voltage is higher than 660 V, **>660 V** is displayed.

#### **⚠ Warning**

**The Meter indicates either ac or dc voltage. If the voltage being measured has both an ac and dc component, the Meter displays only the largest component of the measured signal.**

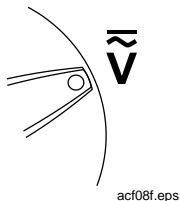

### Checking the Battery

This function tests the battery under simulated load per EN61557. Disconnect all test leads from any circuit.

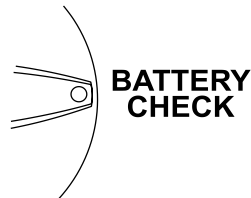

acf09f.eps

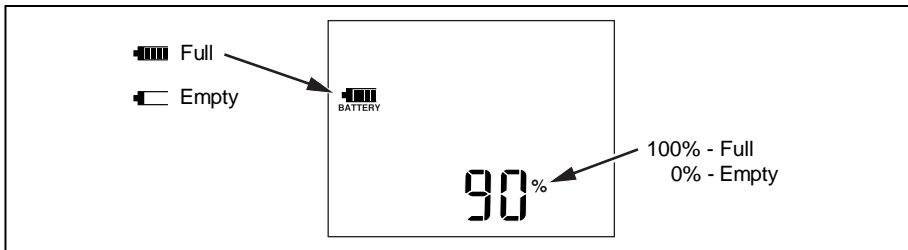

acf13f.eps

Figure 4. Display Example



## **Maintaining the Meter**

This section provides basic maintenance information, including fuse and battery replacement instructions.

### **Caution**

**Do not attempt to repair or service your Meter unless you are qualified to do so and have the relevant calibration, performance test, and service information.**

### **Cleaning**

Clean only with soap and water. Remove any residue afterwards.  
Periodically wipe the case with a damp cloth and mild detergent.  
Do not use abrasives or solvents.

## Replacing and Disposing of the Batteries

### Warning

To avoid electric shock, disconnect the test leads from the inputs before opening the Meter for battery replacement.

To avoid false readings, which could lead to possible electric shock or personal injury, replace the batteries as soon as the battery empty indicator  appears.



*This Meter contains alkaline batteries. Do not dispose of these batteries with other solid waste. Used batteries should be disposed of by a qualified recycler or hazardous materials handler. Contact your authorized Fluke Service center for recycling information.*

The Meter uses four alkaline C cell batteries (supplied). To replace the batteries, do the following (see Figure 5):

1. Turn the rotary switch to the OFF position.
2. Disconnect test leads from any power source.
3. Remove the holster.

4. Place the Meter face down on a nonabrasive surface and loosen the two screws with a flat-blade screwdriver.
5. Lift the battery access lid away from the Meter.
6. Replace the C cells as shown in Figure 5. Observe the battery polarity shown in the battery compartment.
7. Secure the battery access lid back in position with the two screws.

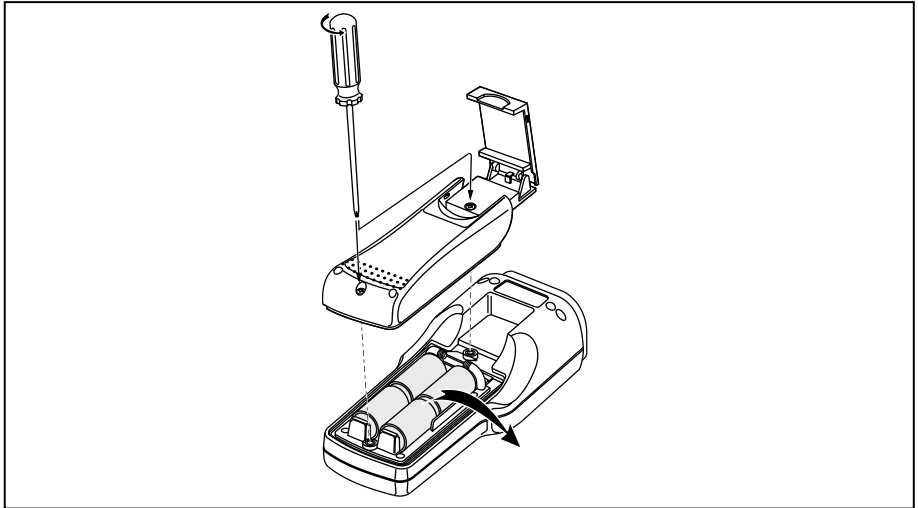

acf10f.eps

**Figure 5. Replacing the Batteries.**

## Testing and Replacing the Fuse

### Warning

To avoid electric shock, disconnect the test leads from the inputs before opening the Meter for fuse replacement.

To prevent personal injury or damage to the Meter, install **ONLY** Fluke specified fuse identified in the “Replacement Parts and Optional Accessories” section.

Before replacing the fuse, test it as described in the next section.

### Testing the Fuse

Use the following procedure to test the internal fuse of the Meter.

1. Turn the rotary switch to the Lo  $\Omega$  Function.
2. Connect the test leads to the input terminals and short them together. Press TEST.
3. The display should indicate approximately 0.5  $\Omega$ . If the display reads **>40  $\Omega$** , replace the fuse as described next and test again.

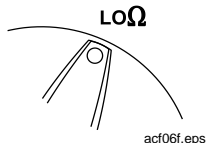

## *Replacing the Fuse*

### **⚠ Warning**

**To avoid electric shock, personal injury or damage to the Meter, use ONLY the specified fuse, and in accordance with the following procedure.**

If the previous fuse test indicates that the fuse is defective (resistance > 40  $\Omega$ ), replace the fuse as follows:

1. Turn the rotary switch to the OFF position.
2. Disconnect test leads from any power source.
3. Follow Steps 2 - 5 to remove the battery access lid as described under "Replacing and Disposing of the Batteries".
4. Unscrew the bottom cover as shown in Figure 6.
5. Remove the fuse as shown in Figure 6.
6. Replace with a new fuse.
7. Place the bottom cover on and secure the screws.
8. Insert the batteries. Observe the battery polarity shown in the battery compartment.
9. Secure the battery access lid.
10. Test the fuse as described under "Testing the Fuse".

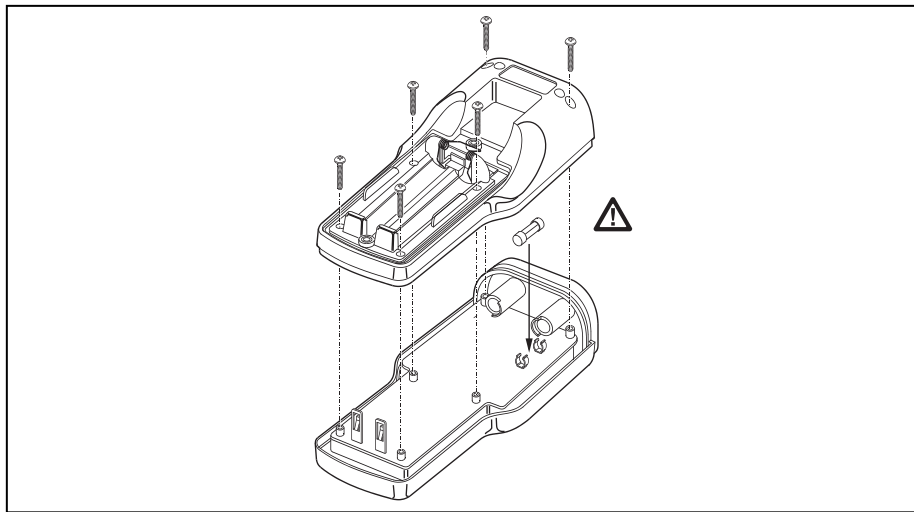

acf11f.eps

**Figure 6. Replacing the Fuse**

**Replacement Parts and Optional Accessories**

<b>Replacement Part</b>	<b>Part Number</b>
Battery 1.5 V Alkaline Size C	423582
Test Lead set	669058
Test Probe, 1 kV, lantern tip, red	803459
Test Probe, 1 kV, lantern tip, black	803467
Alligator Clip, red	803434
Alligator Clip, black	803442
Carrying Case	603115
Holster	670643
Hand Strap	669069
⚠ Fuse, 6 mm x 32 mm (0.25 x 1.25 inch), 0.5 A, 660 V, Fast Acting, 50 A Minimum Interrupt rating  OR ⚠ Fuse, 6 mm x 32 mm (0.25 x 1.25 inch), 0.5 A, 750 V, Fast Acting	NA     1556096
<b>Optional Accessories</b>	<b>Part Number</b>
Harness	669074
Tool Pack	669903

⚠ For safety, use exact replacement only.



### **Principle of Measurement for Resistance**

The Meter measures resistance by inducing a current in the circuit under test, measuring the resultant potential across the circuit, and then calculating the resistance of the circuit. The resistance is then established by performing the following calculation:

$$R = \frac{V}{I} \text{ (Ohm's Law)}$$

### **Service Centers**

To locate an authorized service center, visit us on the World Wide Web:

[www.fluke.com](http://www.fluke.com)

or call Fluke using any of the phone numbers listed below:

USA: 1-888-99-FLUKE (1-888-993-5853)

Canada: 1-800-36-FLUKE (1-800-363-5853)

Europe: +31 402-678-200

Japan: +81-3-3434-0181

Singapore: +65-738-5655

Anywhere in the world: +1-425-446-5500

## Specifications

Environmental	
Operating Temperature	-10 °C to +50 °C
Storage Temperature	-40 °C to +70 °C
Temperature Coefficient	0.10 x (specified accuracy)/ °C (< 18 °C or > 28 °C)
Relative Humidity: Non condensing (< 10 °C) 90 % RH (10 °C to 30 °C) 75 % RH (30 °C to 40 °C) 45 % RH (40 °C to 50 °C)(Without Condensation)	
Dust/water resistance	IP42 per IEC 529
Operating Altitude	2000 m
Storage Altitude	12000 m

<b>Mechanical Specifications</b>	
Size	23,4 x 10 x 6,4 cm (9.2 x 3.9 x 2.5 in)
Weight	1 kg (2.2 lbs.)
Drop requirement	Per IEC 1010-1
Shock and Vibration	Conforms to MIL-PREF-28800F class 3 & 4

<b>Safety Specifications</b>	
Electrical Safety	Meets all requirements of EN61010-1, 1995 and EN61557, 1997
Maximum Operating Voltage	600 V ac or dc between any terminal and earth ground
Protection Levels	CAT III, 600 V, Pollution Degree 2 per EN61010-1

<b>Electromagnetic Compatibility (EMC)</b>	
Immunity & Emmissions	EN 61326-1 (Unspecified for Field strength in excess of 2V/m)
ESD	EN61000-4-2 Satisfies Criteria B

<b>Electrical Specifications</b>	
Battery	C Size 1.5 V alkaline, ANSI/NEDA-14A, IEC-LR14 (4 pieces)
Fuse	6 mm x 32 mm (0.25 x 1.25 inch), 0.5 A 660 V, Fast Acting, 50 A Minimum Interrupt rating
<b>Insulation Resistance</b>	
Display Ranges	4.000 M $\Omega$ , 40.00 M $\Omega$ , 400.0 M $\Omega$ , 4000 M $\Omega$
Measurement Range (per EN61557-2)	0.250 M $\Omega$ to 4000 M $\Omega$
Resolution	0.001 M $\Omega$ to 10 M $\Omega$
Accuracy	2 % + 2 counts 0.250 M $\Omega$ to 100.0 M $\Omega$
	10 % + 2 counts + 1 %/1000 M $\Omega$ 100.0 M $\Omega$ to 4000 M $\Omega$
Analog Bar Graph	0 to $\infty$

Test Voltages	250 V, 500 V, 1000 V
Accuracy	+20 %, -0 %
Nominal Current	1 mA
Number of measurements	5,000
Circuitry Protection	test inhibited if $\geq 30$ V ac or dc at inputs
<b>Lo <math>\Omega</math></b>	
Display Range	40.00 $\Omega$
Measurement Range	0.10 $\Omega$ to 40.00 $\Omega$
Accuracy	2 % + 2 counts
Resolution	0.01 $\Omega$
Analog Bar Graph	0 to 100 $\Omega$
Open Circuit Voltage	6 V typical
Short Circuit Current	200 mA minimum, (0.2 to 2.0 $\Omega$ for >20% battery capacity remaining).
Test Leads Zero	2 $\Omega$
Number of measurements	5,000
Circuitry Protection	test inhibited if $\geq 30$ V ac or dc at inputs

<b>Voltage</b>	
Range	600 V, dc, 50/60 Hz
Resolution	1 V
Accuracy	2 % + 2 counts
Analog Bar Graph	0 to 1000 V
<b>Resistance</b>	
Range	4000 $\Omega$
Accuracy	2 % + 2 counts
Resolution	1 $\Omega$
Analog Bar Graph	0 to 10 k $\Omega$
Beeper	On at $\approx 30 \Omega$ or less

### **Limited Warranty & Limitation of Liability**

Each Fluke product is warranted to be free from defects in material and workmanship under normal use and service. The warranty period is three years and begins on the date of shipment. Parts, product repairs and services are warranted for 90 days. This warranty extends only to the original buyer or end-user customer of a Fluke authorized reseller, and does not apply to fuses, disposable batteries or to any product which, in Fluke's opinion, has been misused, altered, neglected, contaminated, or damaged by accident or abnormal conditions of operation or handling. Fluke warrants that software will operate substantially in accordance with its functional specifications for 90 days and that it has been properly recorded on non-defective media.

Fluke authorized resellers shall extend this warranty on new and unused products to end-user customers only but have no authority to extend a greater or different warranty on behalf of Fluke. Warranty support is available if product is purchased through a Fluke authorized sales outlet or Buyer has paid the applicable international price. Fluke reserves the right to invoice Buyer for importation costs of repair/replacement parts when product purchased in one country is submitted for repair in another country.

Fluke's warranty obligation is limited, at Fluke's option, to refund of the purchase price, free of charge repair, or replacement of a defective product which is returned to a Fluke authorized service center within the warranty period. To obtain warranty service, contact your nearest Fluke authorized service center to obtain return authorization information, then send the product to that service center, with a description of the difficulty, postage and insurance prepaid (FOB Destination), to the nearest Fluke authorized service center. Fluke assumes no risk for damage in transit. Following warranty repair, the product will be returned to Buyer, transportation prepaid (FOB Destination). If Fluke determines that the failure was caused by neglect, misuse, contamination, alteration, accident or abnormal condition of operation or handling, including overvoltage failures caused by use outside of the product's specified rating, or normal wear and tear of mechanical components, Fluke will provide an estimate of repair costs and obtain authorization before commencing the work. Following repair, the product will be returned to

the Buyer transportation prepaid and the Buyer will be billed for the repair and return transportation charges (FOB Shipping Point).

THIS WARRANTY IS BUYER'S SOLE AND EXCLUSIVE REMEDY AND IS IN LIEU OF ALL OTHER WARRANTIES, EXPRESS OR IMPLIED, INCLUDING BUT NOT LIMITED TO ANY IMPLIED WARRANTY OF MERCHANTABILITY OR FITNESS FOR A PARTICULAR PURPOSE. FLUKE SHALL NOT BE LIABLE FOR ANY SPECIAL, INDIRECT, INCIDENTAL OR CONSEQUENTIAL DAMAGES OR LOSSES, INCLUDING LOSS OF DATA, ARISING FROM ANY CAUSE OR THEORY.

Since some countries or states do not allow limitation of the term of an implied warranty, or exclusion or limitation of incidental or consequential damages, the limitations and exclusions of this warranty may not apply to every buyer. If any provision of this Warranty is held invalid or unenforceable by a court or other decision-maker of competent jurisdiction, such holding will not affect the validity or enforceability of any other provision.

Fluke Corporation  
P.O. Box 9090  
Everett, WA 98206-9090  
U.S.A.

Fluke Europe B.V.  
P.O. Box 1186  
5602 BD Eindhoven  
The Netherlands

11/99



