



**Advanced Test Equipment Rentals**  
 www.atecorp.com 800-404-ATEC (2832)

# WT1800

High Performance Power Analyzer



## Broad Ranging Power Measurements with One Unit

<b>Basic Power Accuracy</b>	<b>±0.1%</b>
<b>DC Power Accuracy</b>	<b>±0.05%</b>
<b>Voltage/Current Bandwidth</b>	<b>5 MHz*1 (-3 dB, Typical)</b>
<b>Sampling Rate</b>	<b>2 MS/s (16-bit)</b>
<b>Input Elements</b>	<b>Max. 6</b>
<b>Current Measurement</b>	<b>100 μ A to 55 A</b>
<b>Fast data Capturing</b>	<b>5 ms Response *Max.1ms (When External Sync ON)</b>

### Innovative Functions Help Improve Measurement Efficiency

Motor, Inverter, Lighting, EV/HEV, Battery, Power Supply, Aircraft, New Energy, Power Conditioner

For more information, please visit.

**tmi.yokogawa.com**

Test & Measurement Instruments



\*1: Excluding direct current input with the 50 A input element

High Performance Power Analyzer WT1800



# New WT1800 Precision Power Analyzer Offers High-performance, Wide-range, and 6 Power Inputs

## New Functions Greatly Help Improve Measurement Efficiency



## Many features are available that are a first in the power measurement industry\*1

### Measurement High-precision, wide-range, fast-sampling, simultaneous harmonic measurement

- 5-fold wider than previous model\***
  - Voltage and current frequency bandwidth 5 MHz (-3 dB, typical)**  
Faster switching frequencies increasingly require measurements in a wider range. The WT1800 provides a voltage and current frequency bandwidth (5 MHz) 5-fold wider than the previous measurement range and is capable of more correctly capturing fast switching signals.
- 2/3 of previous model\***
  - Reduction of low power-factor error to 0.1% of apparent power (2/3 of previous model)**  
A power-factor error is one of the important elements to ensure high-accuracy measurements even at a low power factor. The WT1800 has achieved a power-factor error (0.1%) that is 2/3 of the previous model, in addition to a high basic power accuracy of ±0.1%.
- Inheritance**
  - Wide voltage and current range allowing direct input**  
Direct input of measurement signals makes it possible to measure very small current that can hardly be measured with a current sensor. The WT1800 provides a direct input voltage range from 1.5 V to 1000 V (12 ranges) and a direct input current range from 10 mA to 5 A (9 ranges) or from 1 A to 50 A (6 ranges).
- 5-fold wider than previous model\***
  - 0.1 Hz low-speed signal power measurement and max. 50 ms high-speed data collection**  
The frequency lower limit has been reduced to 0.1 Hz from the previous 0.5 Hz (5-fold lower than the previous model) to meet the requirement for power measurements at a low speed. Furthermore, high-speed data collection at a data update rate of up to 50 ms has been inherited. In addition to normal measurement data, up to the 500th order harmonic data can be measured and saved simultaneously. The data update rate can be selected from nine options from 50 ms to 20 s. \* Harmonic measurement at the 50 ms data update rate is possible up to the 100th order.
- First in industry**
  - Particular voltage and current range selectable**  
Wide voltage and current input ranges have the advantage of extending the measurement application range. However, the downside is that the response time of the auto range tends to slow down. A range configuration function solves this problem. Since only the selected range (effective measurement range) can be used, the range can be changed up or down more quickly.
- NEW**
  - msec response for transient phenomena analysis (/HS option)**  
The /HS option provides fast data capturing with ms response.  
Current WT series can measure three phase values like voltage, current and power every 50ms period correctly, however, 50ms data update rate is not enough for analyzing transient phenomena of motors and other devices recently.

For details, see Pages 5

For details, see Pages 11

\* Comparison with Yokogawa's previous model WT1600

\*1: Applicable to a general-purpose high-precision three-phase power analyzer as of February 2011 (according to Yokogawa's survey)

# Support for Energy Conservation Technologies and Sustainable Energy Development

### First in industry Dual Harmonic Measurement

The perspective of the efficient use of energy is boosting demand for inverters to convert 50 Hz or 60 Hz AC power to DC power, grid connection controllers to control reverse power flow occurring due to excess power, and battery chargers/dischargers.

The WT1800 is capable of simultaneously measuring the harmonic distortion of the input and output current of these devices. Challenging the common wisdom that "harmonic measurement is limited to a single line," the WT1800 is capable of performing two-line simultaneous harmonic measurements. The WT1800 is also capable of measuring up to the 500th order harmonic even at high fundamental frequencies such as a 400 Hz frequency.



For details, see Pages 5 and 6

### First in industry Customize Display Screen

With Yokogawa's previous power analyzer model, you have to select numerical formats such as 4-value, 8-value, and 16-value view to display screens, so you cannot flexibly display a screen to view the desired parameter in the desired size and at the desired position.

The WT1800 has broken the mold and is capable of reading user-created image files (BMP) as display screens to allow viewing data in a flexible format. Thus the display screen can be customized in a more user-friendly and easy-to-read manner.



For details, see Pages 5

## Many features are available that are a first in the power measurement industry\*1

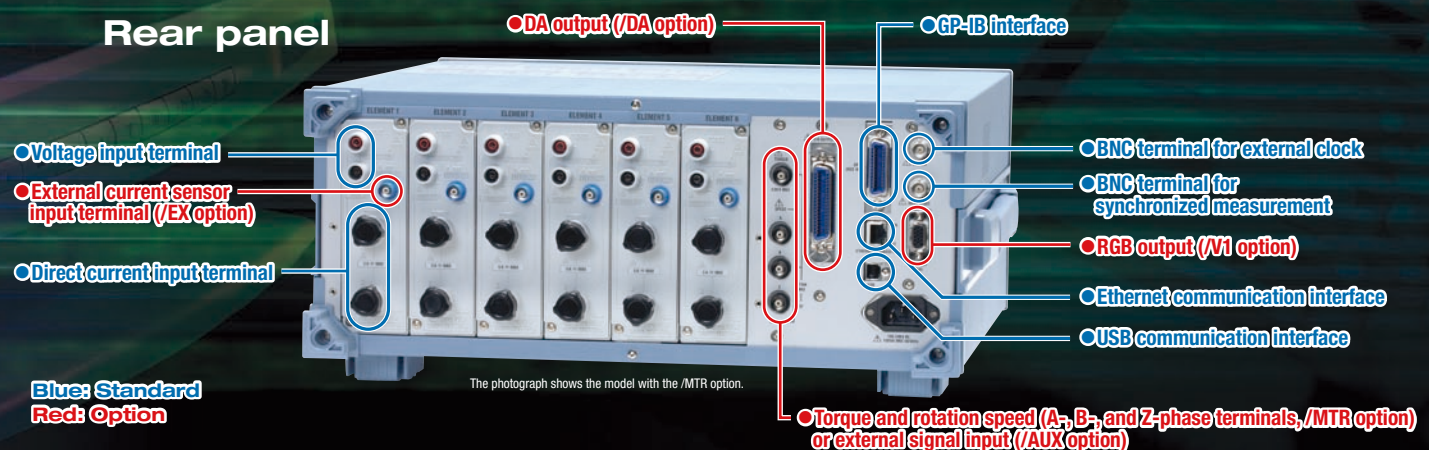

Blue: Standard  
Red: Option

The photograph shows the model with the /MTR option.

### Functions New functions greatly support power measurements

- First in industry**
  - Dual harmonic measurement (option)**  
The industry's first two-line simultaneous harmonic measurement is available, in addition to simultaneous measurement of harmonic and normal measurement items such as voltage, current, and power values. Previously, harmonic measurements of input and output signals had to be performed separately. With the WT1800, harmonic measurements of input and output can be performed simultaneously.
- NEW**
  - Two-channel external signal input is available for power measurement and analog signal data measurement (option available in combination with the motor evaluation function)**  
Power measurements can be performed together with physical quantity data such as solar irradiance or wind power in wind generation.
- NEW**
  - Electrical angle measurement is also supported. Motor evaluation function allowing A-phase, B-phase, and Z-phase inputs (option available in combination with external signal input)**  
Pulse or analog signals can be input for rotation speed and torque signal measurements. The motor evaluation function of the WT1800 makes it possible to detect the rotation direction and measure the electrical angle, which is not possible with Yokogawa's previous model.

For details, see Pages 5 and 6

For details, see Page 9

For details, see Page 7

### Saving/Communication A wide variety of communication and data saving functions

- First in industry**
  - User-defined event function**  
For the first time in the high-precision power analyzer industry, an event trigger function is available to meet the requirement to capture only a particular event. For example, a trigger can be set for measured values that fall out of the power value range from 99 W to 101 W and only data that meets the trigger condition can be stored, printed, or saved to a USB memory device.
- GP-IB, Ethernet, and USB communication functions available as standard**

For details, see Pages 4 and 8

First in industry means functions and capabilities available for the first time in the high-precision three-phase power analyzers (according to Yokogawa's survey).

#### List of Available Functions

- Standard feature
- Option
- Software (sold separately)

Voltage range 1.5-1000V	Current range 1-50A 10mA-5A	External sense range 0.05-10V/EX	Power Frequency range 1MHz	Voltage/Current Frequency bandwidth 5MHz (typical)	Inputs 1,2,3,4,5,6	Basic Power Accuracy ±0.1%	Crest factor 300(6)	Display 8.4-XGA	Update rate 50ms-20s	Harmonic 12ch	Dual Harmonics 12ch
Delta Computation /DT	Add-on Frequency /FH	Motor Evaluation Speed Torque /MTR	Auxiliary Inputs Analog 2 inputs /IUS	USB memory	Internal Memory 32MB	Printer /PS	RGB /V1	Comm USB	Comm GP-IB	Comm Ethernet	Software WT Viewer 760122



# All Data of 6-input, Single/Three-phase Devices can be Viewed on a Single Screen

## Important Information is Displayed in a Concentrated Format on High Resolution 8.4-inch XGA Display

A high resolution display with a resolution about 2.6-fold higher than Yokogawa's previous model is employed. More setting information and measurement data can be displayed.

\* Comparison with Yokogawa's previous model WT1600



### A lot of information can be displayed on a single screen

Measurement data can be displayed on a single screen, along with the respective detailed setting information of 6 inputs, such as a voltage range, current range, synchronization source, wiring system, and filter. You do not need to switch display screens frequently to confirm the settings.

### Data update rate changeable

With the WT1800, the data update rate can be selected from 9 options from the fastest data update rate of 50 ms to an update rate of 20 s for low-speed measurements. For example, if you want to save the average data at a 1-minute interval and inappropriately set the update rate of 50 ms, measurement results may be not correct because data can be saved only at a 1-minute interval (once every 20 times). Such a risk can be avoided by setting the update rate that is suited to the interval at which you want to save data.

### Line filter Capture an original signal masked by high frequency component

NEW

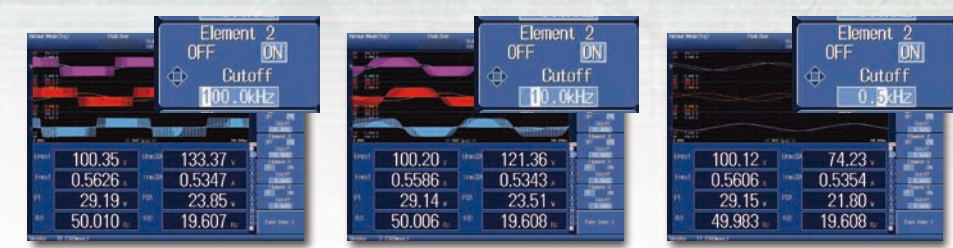

In power evaluation such as an inverter waveform and distorted waveform, measurement values are affected by high frequency component. A new digital filter function makes it possible to remove unnecessary high frequency components superimposed on signals. A filter can be independently set for each input element. An analog filter for 1 MHz/300 kHz, and digital filter that can be set from 100 Hz to 100 kHz in increments of 100 Hz are available as standard.

### Range configuration function High-speed range setting suited to input signals

NEW

A new range configuration function is available. It allows you to select a particular voltage and current input range (effective measurement range). Eliminating unnecessary ranges has made it possible to achieve optimal range setting that is faster than Yokogawa's previous model\*. This allows more quicker tracking of signal changes. If the peak goes over the limit, you can switch to a preset range. This is effective in reducing the production time for a repeat test, such as setting to OFF, 100 V, OFF and so on, which is performed frequently on the production line.

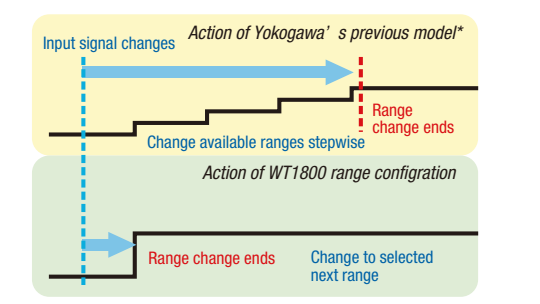

\* Comparison with Yokogawa's previous model WT1600

## A Wide Variety of Display Formats Ranging from Numerical to Custom Display

### Numerical and harmonic bar graphs

NEW

#### Dual harmonic measurement

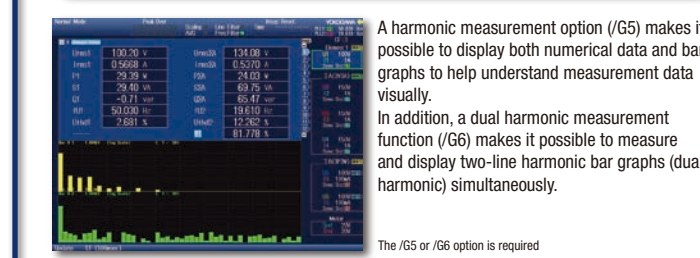

The /G5 or /G6 option is required

### Waveform

NEW

#### Support for 6 split screen displays

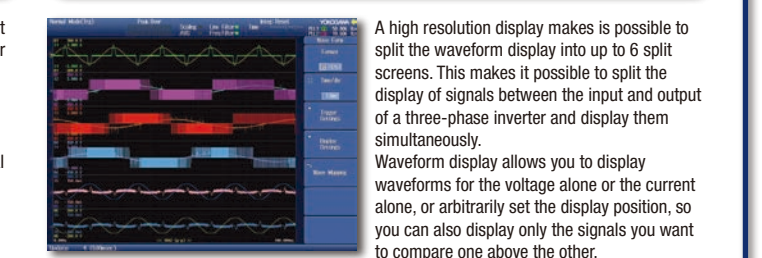

A high resolution display makes it possible to split the waveform display into up to 6 split screens. This makes it possible to split the display of signals between the input and output of a three-phase inverter and display them simultaneously. Waveform display allows you to display waveforms for the voltage alone or the current alone, or arbitrarily set the display position, so you can also display only the signals you want to compare one above the other.

### Dual vector

NEW

#### Simultaneous two vector displays

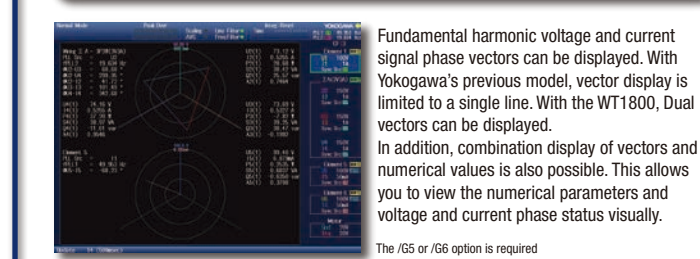

The /G5 or /G6 option is required

### Trend

#### Capture efficiency changes visually

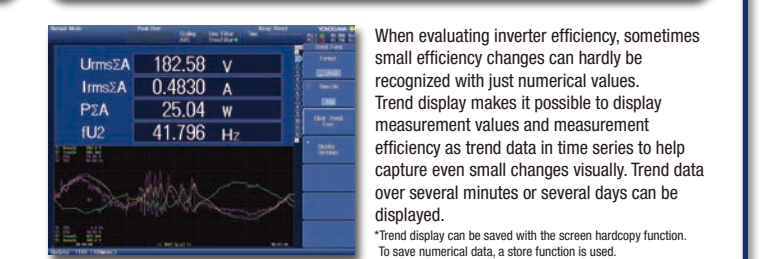

When evaluating inverter efficiency, sometimes small efficiency changes can hardly be recognized with just numerical values. Trend display makes it possible to display measurement values and measurement efficiency as trend data in time series to help capture even small changes visually. Trend data over several minutes or several days can be displayed. \*Trend display can be saved with the screen hardcopy function. To save numerical data, a store function is used.

### Setting information

NEW

#### Combination display of Information and Numerical screens

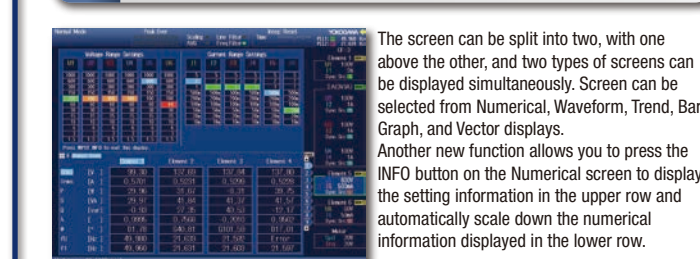

The screen can be split into two, with one above the other, and two types of screens can be displayed simultaneously. Screen can be selected from Numerical, Waveform, Trend, Bar Graph, and Vector displays. Another new function allows you to press the INFO button on the Numerical screen to display the setting information in the upper row and automatically scale down the numerical information displayed in the lower row.

### Custom

NEW

#### Customize display screen

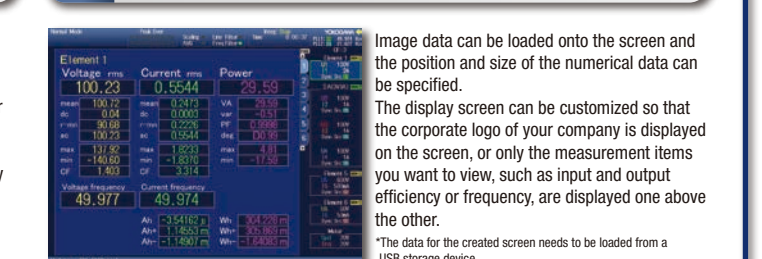
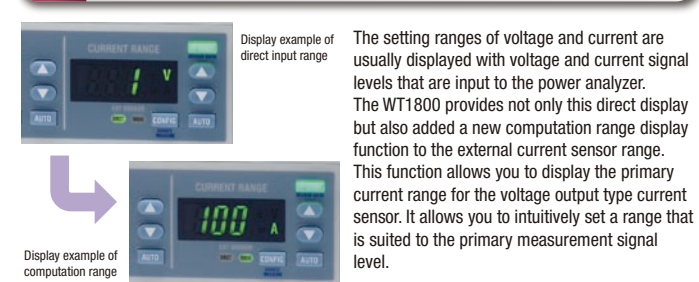

Image data can be loaded onto the screen and the position and size of the numerical data can be specified. The display screen can be customized so that the corporate logo of your company is displayed on the screen, or only the measurement items you want to view, such as input and output efficiency or frequency, are displayed one above the other. \*The data for the created screen needs to be loaded from a USB storage device.

### Computation range display

Innovative function

#### Direct display of primary current values



The setting ranges of voltage and current are usually displayed with voltage and current signal levels that are input to the power analyzer. The WT1800 provides not only this direct display but also added a new computation range display function to the external current sensor range. This function allows you to display the primary current range for the voltage output type current sensor. It allows you to intuitively set a range that is suited to the primary measurement signal level.

### User-defined event function

Innovative function

#### Capture only a particular event

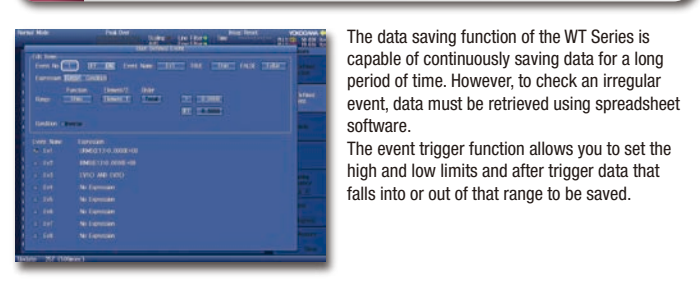

The data saving function of the WT Series is capable of continuously saving data for a long period of time. However, to check an irregular event, data must be retrieved using spreadsheet software. The event trigger function allows you to set the high and low limits and after trigger data that falls into or out of that range to be saved.

### Individual null function

Innovative function

#### Function to reset only a particular input signal to zero

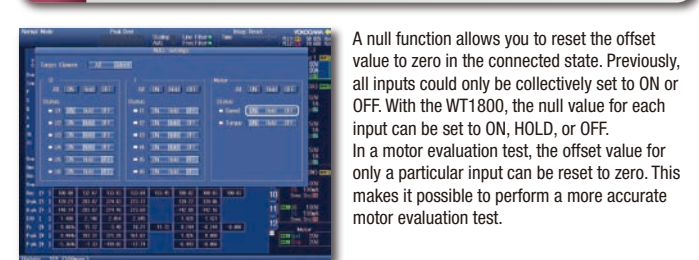

A null function allows you to reset the offset value to zero in the connected state. Previously, all inputs could only be collectively set to ON or OFF. With the WT1800, the null value for each input can be set to ON, HOLD, or OFF. In a motor evaluation test, the offset value for only a particular input can be reset to zero. This makes it possible to perform a more accurate motor evaluation test.

### Help function

New function

#### Display the manual on the screen

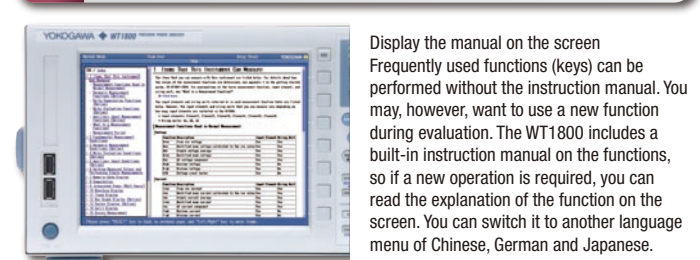

Display the manual on the screen. Frequently used functions (keys) can be performed without the instruction manual. You may, however, want to use a new function during evaluation. The WT1800 includes a built-in instruction manual on the functions, so if a new operation is required, you can read the explanation of the function on the screen. You can switch it to another language menu of Chinese, German and Japanese. English help menu supports measurement



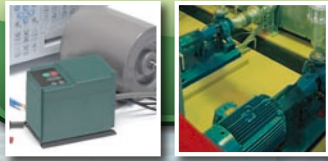

# Input/Output Efficiency Measurements of Inverters, Matrix Converters, Motors, Fans, and Pumps

\*Also refer to the features of other applications.

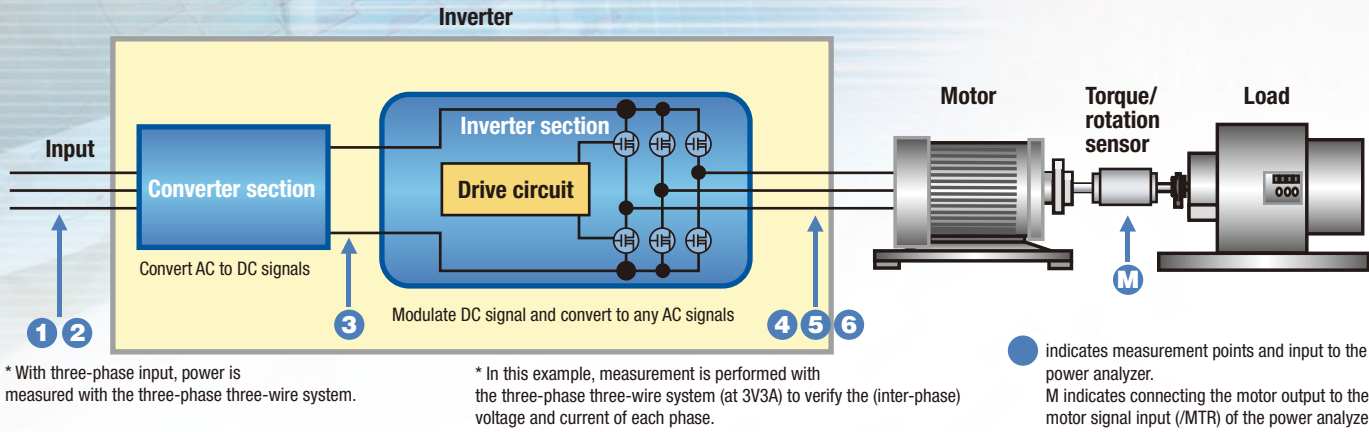

\* With three-phase input, power is measured with the three-phase three-wire system.

\* In this example, measurement is performed with the three-phase three-wire system (at 3V3A) to verify the (inter-phase) voltage and current of each phase.

**Overview** The WT1800 is capable of performing up to 6 power input measurements to make it possible to perform an inverter efficiency test between the input and output in inverter evaluation. In addition, a motor evaluation function (option) makes it possible to simultaneously monitor voltage, current, and power changes, as well as rotation speed and torque changes.

## Advantages of WT1800

### 5 MHz range and 2 MS/s high-speed sampling

The vertical resolution in power measurements is one of the important elements for high-precision measurements. The WT1800 is capable of 16-bit high resolution and approximately 2 MHz sampling to make it possible to measure faster signals with higher precision.

Voltage/  
current range  
5 MHz

Approx.  
2 MS/s 16-bit

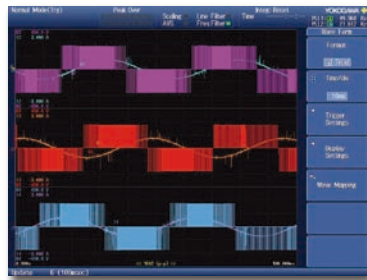

### Up to the 500th order harmonic measurement (/G5 and /G6 options)

Yokogawa's previous model\* provides two different measurement modes, called Normal and Harmonic, and each of the measurements is performed separately. The WT1800 makes it possible to simultaneously measure voltage, current fundamental wave, harmonic components, and harmonic distortion factor (THD) in the Harmonic measurement mode, along with the conventional voltage and current RMS values in the Normal measurement mode. You do not need to switch modes and can measure all data at high speed. In addition, up to the 500th order harmonic can be measured for fundamental frequencies.

\*Comparison with Yokogawa's previous model WT1600

Simultaneous  
harmonic

Up to the  
500th order



### Boost converter efficiency and inverter efficiency evaluation

To evaluate the inputs and outputs of inverters including boost converters, at least 5 power measurement inputs are required. The WT1800 provides 6 inputs to make it possible to evaluate all aspects of inverters. In addition, a new individual null function makes it possible to set the DC offset only on a particular input channel as the null value. This makes it possible to perform more accurate measurements.

6-input

Efficiency  
measurement

Individual  
null function



### Dual harmonic measurement (/G6 option)

In previous models, harmonic measurement has been limited to a single line. The WT1800 is capable of performing two-line simultaneous harmonic measurements with one unit for the first time in the industry. The ability to simultaneously measure harmonics for the input and output signals not only reduces the switching time but also makes it possible to perform simultaneous data analysis for the input and output, which has not been possible with the previous models.

The following measurements can be performed for up to the 500th order  
Single harmonic measurement (/G5 option)  
Dual harmonic measurement (/G6 option)

Dual harmonic  
measurement

Simultaneous  
input/output  
measurement

Up to the  
500th order



### Delta computation function (/DT option)

Differential  
voltage/current

It is possible to obtain the differential voltage, line voltage, phase voltage, etc. by obtaining the sums and differences of instantaneous measurement values of voltage and current in each element.

Star-delta  
conversion

● Differential voltage/current: Differential voltage and current between two elements are computed in the three-phase three-wire system.

● Line voltage/phase current: Line voltage and phase current that are not measured are computed in the three-phase three-wire system (Figure 1).

● Star-delta conversion: Line voltage is computed from the phase voltage using the three-phase four-wire system data.

● Delta-star conversion: Phase voltage is computed from the line voltage in the three-phase three-wire system (3V3A system) (Figure 2).

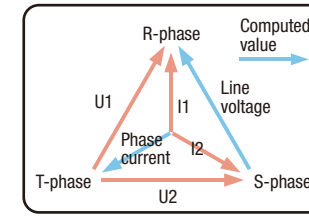

Figure 1 Line voltage/phase current

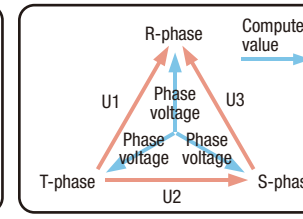

Figure 2 Delta-star conversion

### Typical Product Configuration

\*For detailed specifications, see the page on the specifications. You need to provide a cable for voltage measurements when wiring.

Direct input measurements at less than 50 A: WT1806-06-D-HE/B5/G6/DT/V1/MTR  
6 power inputs, current measurement range 10 mA to 55 A, built-in printer, dual harmonic, delta computation, RGB output, motor evaluation function  
Measurements at more than 50 A using a current sensor: WT1806-60-D-HE/B5/G6/DT/V1/MTR  
6 power inputs, current measurement range 100 μA to 5.5 A (measure AC/DC current sensor output), built-in printer, dual harmonic, delta computation, RGB output, motor evaluation function

## Support for Performance Testing of Multiple Home Appliances

\*Also refer to the features of other applications.



1 to 6 home appliances

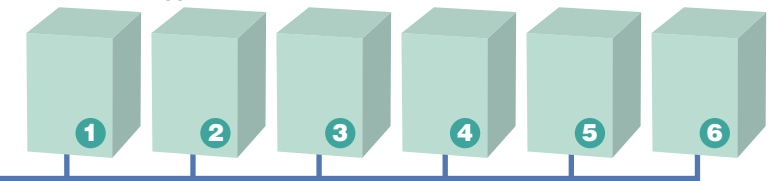

### Overview

To perform high precision power evaluation on the production line, a single WT1800 unit does the work for up to six single-phase power analyzers to measure voltage, current, power, frequency, power factor, and harmonic distortion factor\*. Also an independent integration function is available for each input element to start and stop integration. Since data can be collected remotely by communicating with just a single WT1800 unit, it is easy to create programs.

All-channel  
frequency  
measurement\*

\*The /G5 or /G6 option is required for the harmonic distortion factor measurement. Also, the /F0 option is required to measure four or more frequencies.

## Advantages of WT1800

### Standby and operation power measurements of up to six devices with a single unit

Power measurements of up to six devices can be performed with a single unit. In standby power measurement, 1 mA or less measurement is supported since measurements can be performed from an effective input of 1% of the small current range in the rated 10 mA range. Also, an average active power function allows you to calculate the mean power\* by intermittent oscillation control signals.

\*User-defined computation is used.

Standby power

Average  
active power

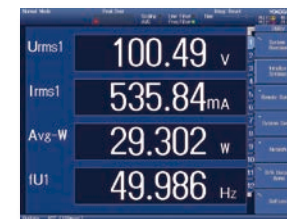

### Combined use with ScopeCorder for analog output (/DA option)

20-channel  
output  
16-bit resolution

DA zoom

A D/A output connector on the rear panel allows you to convert a measurement value to ±5 V (rated value), 16-bit high resolution DC voltage value and output it. Up to 20 items can be output simultaneously.

Also, the ability to set the upper and lower limits for an arbitrary range of input signals and scale up and down the D/A output in the range from -5 V to +5 V allows you to enlarge a changing part of the input signals to monitor it with a ScopeCorder, etc.

\* 0 to 5 V is fixed for some items, such as frequency measurement.

### Typical Product Configuration

\*For detailed specifications, see the page on the specifications. You need to provide a cable for voltage measurements when wiring.

WT1806-06-M-HE/EX6/B5/G6/FQ/V1/DA: 6 power inputs, current measurement range 10 mA to 55 A, or clamp measurement (with a clamp input terminal), built-in printer, all-channel frequency measurement (x12), RGB output, dual harmonic, DA output \*An external input terminal (EX) allows you to perform both direct input measurement and clamp measurement. \*Direct input and current sensor input cannot be connected simultaneously.





# Power Generation and Conversion Efficiency Measurements in New Energy Markets, including Photovoltaic and Wind Power Generation

\*Also refer to the features of other applications.

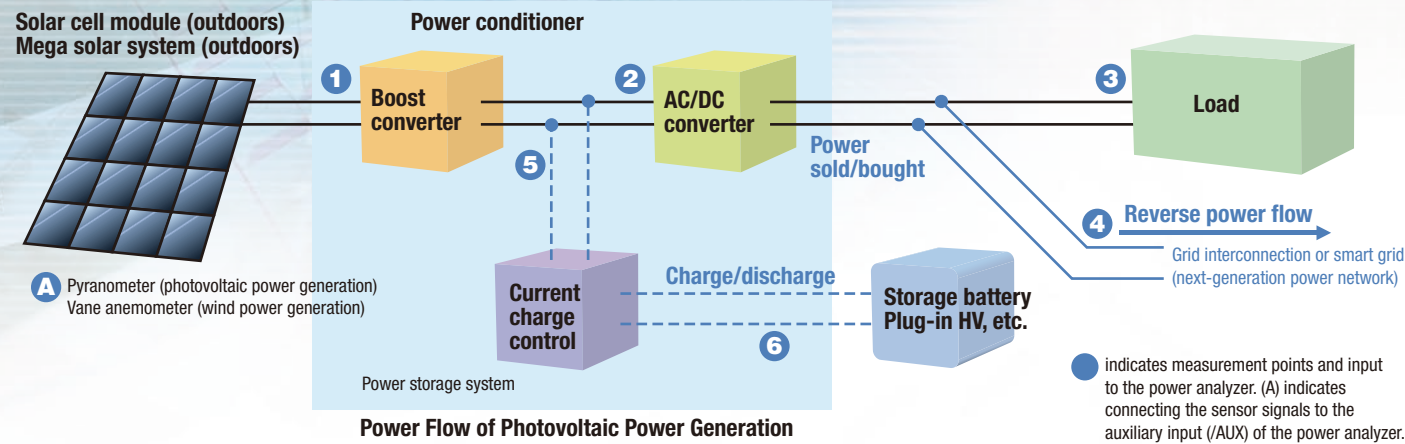

**Overview** Energy generated by photovoltaic cell modules and wind turbines is converted from DC to AC by a power conditioner. Furthermore, the voltage is converted by a charge control unit for the storage battery. Minimizing losses in these conversions improves efficiency in the overall energy system. The WT1800 is capable of providing up to 6 channels of power inputs per unit to make it possible to measure the voltage, current, power, and frequency (for AC) before and after each converter, as well as converter efficiency and charging efficiency.

## Advantages of WT1800

### Max. 1000 V/50 A × 6-line direct measurement

Wide voltage/current range

Direct input terminals in a voltage range from 1.5 V to 1000 V and current range from 10 mA to 5 A or 1 A to 50 A make it possible to perform high-precision measurements without using a current sensor.

Efficiency measurement

Furthermore, power conditioner evaluation requires multiple-channel power measurements, such as inputs/outputs from a boost converter, inverter, and storage battery. The WT1800 is capable of providing up to 6 channels of power inputs to make it possible to simultaneously perform power measurements at multiple points with one unit. In addition, two units can be operated in synchronization for multi-channel power evaluation.

Synchronized operation

### Power integration (power sold and bought/charge and discharge) measurements

Power sold/bought

A power integration function makes it possible to measure the amount of power sold/bought in grid interconnection and of battery charge/discharge. The WT1800 provides a current integration (q), apparent power integration (WS), reactive power integration (WQ), as well as effective power integration capable of integration in the power sold/bought and charge/discharge modes.

Charge/discharge

Furthermore, a user-defined function makes it possible to calculate the Average active power within the integration period. This makes it possible to more accurately measure the power consumption of an intermittent oscillation control unit in which power fluctuates greatly.

Average active power

### Trigger when an error occurs (User-defined event function)

Data saving when an error occurs

An event trigger function is helpful in verifying that voltage or current changes are within the design tolerance range. Setting the normal power generation range as a judgment condition (trigger) detects measurement data that falls out of that range and save it to the memory.

### Maximum Power Peak Tracking (MPPT) measurement

MPPT

Maximum power peak value

In photovoltaic power generation, an MPPT control is performed to effectively utilize voltage generated by photovoltaic cells in an attempt to maximize the harvested power. The WT1800 is capable of measuring not only the voltage, current, and power but also the voltage, current, and power peak values (plus (+) and minus (-) sides, respectively). Also, the maximum power peak value (plus (+) and minus (-) sides) can be measured.

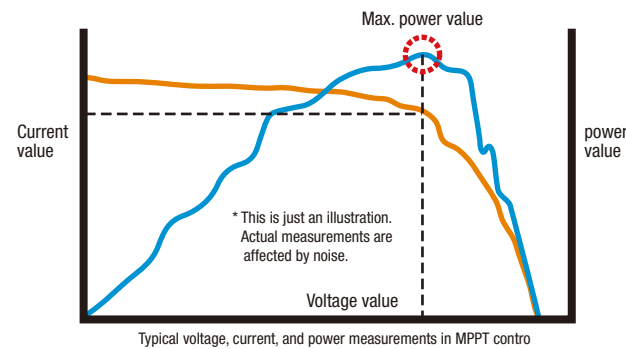

U1	97.52 V	I1	80.58 A
P1	0.3166 W	P2	0.5288 W
P1pk+	28.39 W	P1pk-	21.66 W
P2pk+	79.16 W	P2pk-	72.25 W
P3	20.73 W	P4	33.94 W
P5	0.9196 W	P6	34.02 W
P7	50.003 W	P8	21.612 W

Typical measurement of power value (P1), plus (+) side (P+pk) and minus (-) side (P-pk) of max. power peak value

### Ripple factor and power loss measurements using user-defined function

A user-defined function makes it possible to compute not only the conversion efficiency but also the power loss, DC voltage and DC current ripple factors between the input and output. This is helpful in multiplying a factor or slightly changing the arithmetic expression according to the purpose. Up to 20 arithmetic expressions can be set. Display names for the arithmetic operations F1, F2, and so on can be changed freely.

Ripple factor

Power loss



- Typical arithmetic expressions
  1. DC voltage ripple factor =  $[(\text{Voltage peak value (+)} - \text{Voltage peak value (-)}) / 2 \times \text{DC voltage value (mean)}] \times 100$
  2. Power loss = Output power - Input power

Typical Product Configuration \*For detailed specifications, see the page on the specifications. You need to provide a cable for voltage measurements when wiring.

Direct input measurements at less than 50 A: WT1806-06-F-HE/EX6/B5/G6/AUX  
 6 power inputs, current measurement range 10 mA to 55 A, or clamp measurement (with clamp input terminals), built-in printer, dual harmonic, auxiliary input  
 Measurement at more than 50 A using a current sensor: WT1806-60-F-HE/EX6/B5/G6/AUX  
 6 power inputs, current measurement range 100 μA to 5.5 A (measure AC/DC current sensor output), external current sensor input (for clamp measurement), built-in printer, dual harmonic, external signal input  
 \*Direct input and current sensor input cannot be connected simultaneously.

## Power Measurements of Fluorescent and Light Emitting Diode (LED) Lights

\*Also refer to the features of other applications.

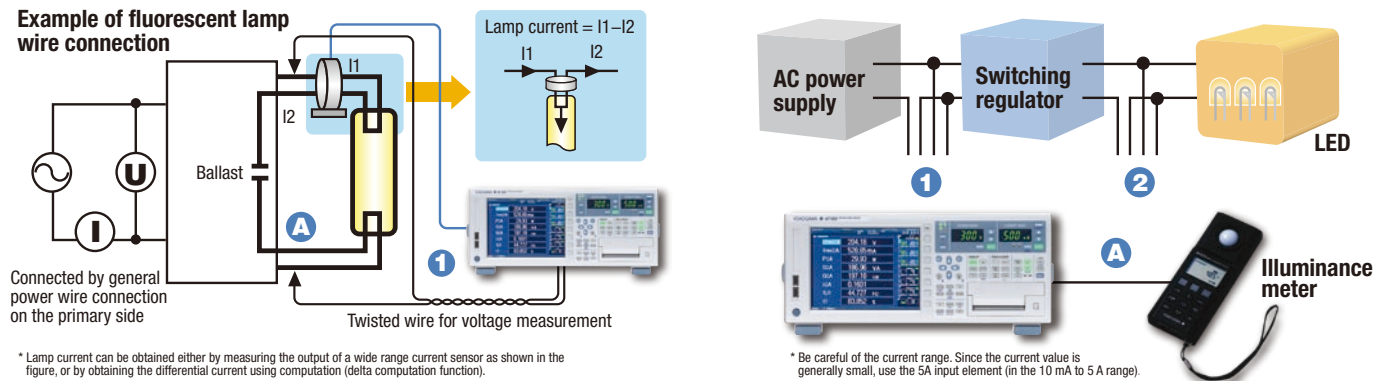

**Overview** Since the switching frequency of fluorescent lamp is sometimes as fast as approximately tens of kHz, a wide range power measurement is required. Also, sometimes dimming control by a PWM modulation circuit is performed for the LED lights. The WT1800 provides a wide range from DC to up to 5 MHz to allow you to evaluate these kinds of harmonic signals.

## Advantages of WT1800

### Tube current measurements of fluorescent lamps (/DT option)

A ballast uses harmonic frequency signals to illuminate the fluorescent lamp. The frequency is generally as fast as tens of kHz. A wide range capability of power measurement is important to reliably capture the signals. Also, since tube current cannot be measured directly, it is obtained either by measuring the difference between the output current of the ballast and the cathode current using a current sensor, or by using the delta computation of the WT1800 (/DT option).



Note: Tube current is obtained by the computation of a difference in the instantaneous values instead of the effective current values.

5 MHz range

Tube current measurement

Delta computation Differential current

### Light emitting efficiency and power measurements of LED lights (/AUX option)

It is important for LED lights to increase the light emitting efficiency while at the same time reducing the current and power consumption. The WT1800 allows you to measure voltage, current, and power, as well as compute the light emitting efficiency (lamp efficiency) by connecting the output of an illuminance meter, etc. to the external signal input terminal (/AUX option).

DC/AC

Light emitting efficiency

U1	100.64 V	I1	4.9077 A
P1	103.79 W	P2	1.8865 W
P3	10.258 W	P4	9.251 W
P5	49.992 W	P6	30.569 W

Typical Product Configuration \*For detailed specifications, see the page on the specifications. You need to provide a cable for voltage measurements when wiring.

WT1806-06-H-HE/EX6/G6/DT/DA: 6 power inputs, current input range 10 mA to 55 A, or clamp measurement (with a clamp input terminal), dual harmonic, delta computation (differential current measurement), DA output \*Direct input and current sensor input cannot be connected simultaneously.



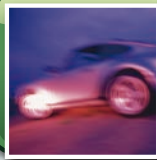

# Input/Output Efficiency Measurements of Inverter Motors for Hybrid Electric Vehicles (HEV), Electric Vehicles (EV), and Plug-in Hybrid Electric Vehicles (PHEV)

\*Also refer to the features of other applications.

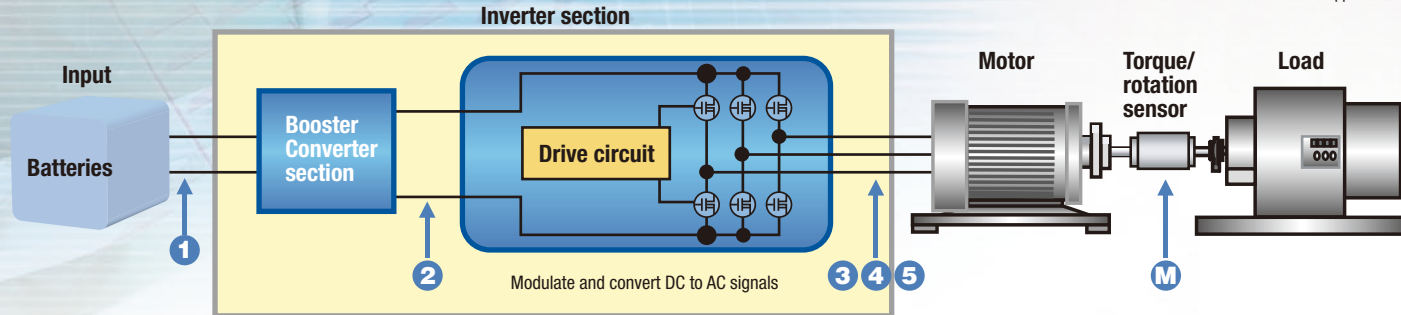

**Overview**

The WT1800's ability to perform up to 6 power input measurements makes it possible to evaluate the battery's charge and discharge characteristics, and test and evaluate the efficiency between the input and output of inverters. A motor evaluation function (MTR option) makes it possible to simultaneously monitor changes in the voltage, current, and power, as well as changes in the rotation speed and torque.

**Advantages of WT1800**



**Inverter, motor, and DC/DC converter efficiency measurements**

A single WT1800 unit is capable of measuring the effective power, frequency, and motor output in order to measure the total efficiency, including inverter and motor efficiency and battery DC/DC conversion efficiency. DC power accuracy has been improved to ±0.05% to ensure more accurate measurements.

- Inverter/motor efficiency measurements
- DC power ±0.05%
- AC power ±0.1%



**Offset correction measurement by null function**

After you finish connecting the wires for inverter motor testing, you may find a value will not become zero due to the influence of the ambient environment or other reasons and the offset value will be applied inappropriately even before starting measurements. With the previous power analyzer model\*, there is no choice other than to turn all inputs on and off collectively, so unintended offset adjustment is performed even for inputs for which you do not want adjust. With the WT1800, only an input for which you want to perform offset adjustment can be turned on and off.

\*Comparison with Yokogawa's previous model WT1600

**Harmonic measurements from a 0.5 Hz low frequency (/G5 and /G6 options)**

In motor testing, evaluation is performed at various rotation speeds from low to high speeds. The WT1800 supports the lower limit frequency of 0.5 Hz to make it possible to measure harmonics at a very low motor rotation speed without using an external sampling clock.

- Harmonic measurements from 0.5 Hz



**Battery charge and discharge measurements**

In integrated measurement, the battery charge and discharge can be evaluated. Instantaneous positive and negative values captured at an approximately 2 MS/s high-speed sampling rate are integrated, respectively, and each of the total values is displayed.

- Battery charge/discharge
- Approx. 2 MS/s high-speed sampling

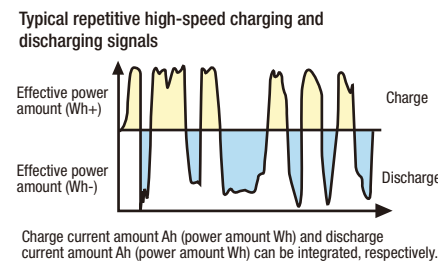

**DA output and remote control (/DA option)**

Sometimes you may want to check changes in data, along with other measurement data (temperature, etc) at the same time when you acquire communication data, such as voltage, current, power, and efficiency data. A DA output function allows you to retrieve analog signals on up to 20 channels. Also, remote control signals make it possible to control the start, stop, and reset of integration by external analog signals. Furthermore, integration can be linked by inputting an analog trigger signal from another device.

- 20-channel output
- Integration by remote control

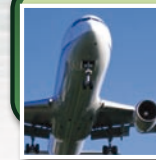

# Harmonic Measurements of Aircraft Power Systems

\*Also refer to the features of other applications.

**Overview**

High order harmonic measurements are important in the aircraft industry. The WT1800 provides a function to measure up to 150 kHz harmonics and allows you to measure up to the 500th order harmonic.

**Advantages of WT1800**

**Measurement of up to the 255th order component even at a 1 kHz fundamental wave (/G5 and G/6 options)**

Up to the 500th order harmonic can be measured at a 400 Hz fundamental frequency. Also, up to the 255th order harmonic can be measured at 1 kHz. Up to 150 kHz harmonic measurements are supported for aircraft testing that requires high order harmonic measurements.



- 150 kHz harmonic
- 400 Hz fundamental wave Up to the 500th order
- 1 kHz fundamental wave Up to the 255th order

Typical Product Configuration \*For detailed specifications, see the page on the specifications. You need to provide a cable for voltage measurements when wiring.

WT1806-60-H-HE/G6/DA: 6 power inputs, current input range 100 µA to 5.5 A (measurement using a current sensor), dual harmonic, DA output



# Fast Date Capturing performance

**ms response capability (/HS Option)**

- ms response
- HS filter

A New High Speed data capturing /HS option can measure ΣUrms, ΣIrms and ΣP from single phase (DC signal) and three phase devices every 5 ms (When External Synchronization is OFF) or, 1 ms to 100 ms when External Synchronization is ON (depending on the frequency of the clock signal). It outputs data in 1 s blocks to internal/external memory or to a PC through a communications interface. The average characteristic is set using the cutoff frequency of the HS filter for measured data during 5 ms or 1 ms to 100 ms period. The cutoff frequency can be varied from 1 Hz to 1,000 Hz in 1 Hz steps.

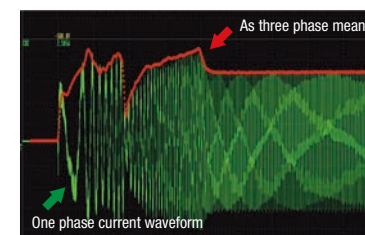

Comparison between a phase current waveform and three phase current values of every 5ms

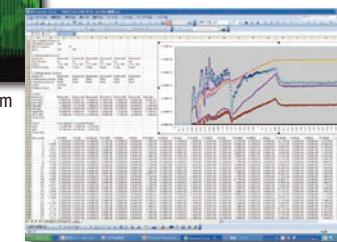

Data analysis and graph drawing by data calculation software



# Power Measurements of Green IT Data Center Servers

\*Also refer to the features of other applications.

**Overview**

New large data centers based on cloud computing are being constructed while the importance of energy conservation is growing. Since the WT1800 is capable of measuring up to 6 power inputs, the current and power consumption of up to six servers can be measured with a single unit. The standard GP-IB, USB, and Ethernet communication functions allow the operator to monitor data in multiple locations by collecting data via communication.

**Advantages of WT1800**

**Integrated Power and Harmonic Distortion Factor Measurements**

The WT1800 is capable of measuring long hours of integrated current (Ah) and power (Wh) in order to understand the amount of power consumption. It is not only possible to measure 50/60 Hz AC signals, but also perform high precision DC measurement indispensable for the DC power supply evaluation. Also, the /AUX option input allows you to monitor heat generation, etc. In addition, a DA output function (/DA option) allows you to output analog signals to an external recorder (ScopeCorder, etc.) and perform long hours of monitoring of current and power along with the temperature and other data.

- Integrated current
- Integrated power DC current ±0.05%
- Harmonic distortion factor

Typical Product Configuration \*For detailed specifications, see the page on the specifications. You need to provide a cable for voltage measurements when wiring.

WT1806-06-H-HE/EX6/G6/DA: 6 power inputs, current input range 10 mA to 55 A, or clamp measurement (with a clamp input terminal), dual harmonic, DA output

\*An external input terminal (EX) allows you to measure both direct input measurement and clamp measurement. \*Direct input and current sensor input cannot be connected simultaneously.

# 760122 WTViewer Software

**Multi-channel synchronized measurements using WTViewer**

- Two-unit synchronized operation
- 12-power measurements

WTViewer is application software that allows you to read numerical data measured with a WT1800 Precision Power Analyzer to a PC via Ethernet, GP-IB, or USB communication, and display and save the numerical values. Up to 12 power inputs can be measured simultaneously in synchronized measurements between two units. Also, the ability to collect data of up to four WT1800 units allows you to measure the conversion efficiency, power, and power loss of up to 24 power inputs.

Note: Make sure the model and suffix codes of the two units are the same.

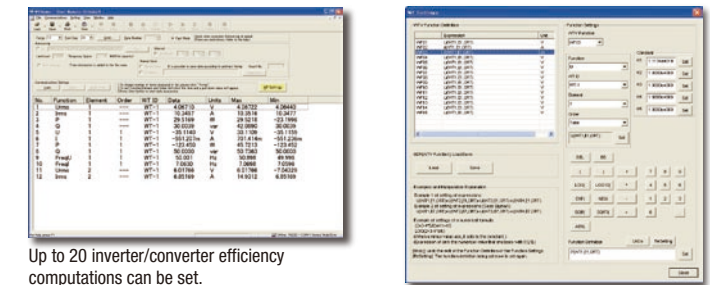

Up to 20 inverter/converter efficiency computations can be set.

- Computation setting examples
- Inverter discharge efficiency ID1P Σ A/ID1P1 × 100[%]
- Converter charge efficiency ID2P1/D2P Σ A × 100[%]
- Inverter charge efficiency ID1P1/ID1P Σ A × 100[%], Motor efficiency ID1Pm/ID1P Σ A × 100[%]

	Measurable number of units	FTP server function
GP-IB connection	1 to 4 units	×
Ethernet communication	1 to 4 units	○
USB communication	1 to 4 units	×

\*Memory media (USB storage device) is required.

Typical Product Configuration \*For detailed specifications, see the page on the specifications. You need to provide a cable for voltage measurements when wiring.

WT1805-50-H-HE/B5/G6/DT/DA/MTR: 5 power inputs, current input range 100 µA to 5.5 A (measuring AC/DC current sensor output), built-in printer, dual harmonic, delta computation, DA output, motor evaluation function



## Comparison between WT1600 and WT1800

### Comparison with the previous model (main changes)

	WT1800	WT1600
Voltage input terminal	Plug-in terminal (safety terminal)	Plug-in terminal (safety terminal)
Current input terminal	Large binding post	Large binding post
External sensor input terminal	Insulated BNC connector (option)	Insulated BNC connector (standard)
Basic voltage/current accuracy	+/-0.1%	+/-0.1%
Basic power accuracy	+/-0.05%	+/-0.1%
Frequency range	DC, 0.1 Hz to 1 MHz	DC, 0.5 Hz to 1 MHz
Voltage/Current frequency range (-3 dB, typical)	5 MHz (-3 dB, typical)	No definition
Sampling speed	approximately 2 MS/s	approximately 200 kS/s
Wiring setting method	Selects wiring and element numbers	Selects wiring system pattern
Selects specified range	Yes	N/A
Effective input range	1% to 110% of range rating	1% to 110% of range rating
Screen size and resolution	8.4-inch (1024x768)	6.4-inch (640x480)
Data update rate	50 m, 100 m, 200 m, 500 m, 1, 2, 5, 10, 20 [sec]	50 m, 100 m, 200 m, 500 m, 1, 2, 5 [sec]
Line filter	OFF, digital filter 100 Hz to 100 kHz (100 Hz step) analog filter 300 kHz, 1 MHz	OFF, 500 Hz, 5.5 kHz, 50 kHz
Frequency filter	OFF, 100 Hz or 1 kHz	OFF or ON
Harmonic measurement	/G5 option or /G6 option	Standard
Harmonic mode	Simultaneous normal and harmonic measurement	Selects normal or harmonic mode
Fundamental frequency of the PLL source	0.5 Hz to 2600 Hz (internal sampling clock) (without external sampling clock function)	1 to 10 Hz (use external sampling clock) 10 Hz to 440 Hz (internal sampling clock)
Upper limit of the measured order	Up to 500 order	Up to 100 order
Harmonic analysis number	select from 1 system (/G5 option) or 2 systems (/G6 option)	1 system
Integration	Active power, current, apparent power, reactive power	Active power, current
Integration mode	Charge/discharge, sold/bought mode	Charge/discharge mode
Delta computation function	/DT option	Standard
Auto printing function	Yes	N/A
Screen print-out function	Built-in printer	Built-in printer, Ethernet network printer
Printer width/length	80 mm / 10 m	80 mm / 10 m
Crest factor (CF=peak/minimum rms)	300	300
Average (moving average)	Sets between from 2 to 64 counts	Selects from 8, 16, 32 or 64 counts
Store function	Store	Store / Recall
Store items	Numeric	Numeric, waveform (1002 peak to peak data)
Screen shot image format	BMP, PNG and JPEG	TIFF, BMP, Post Script, PNG and JPEG
Frequency measurements	3 sources (standard), 12 sources (/FQ option)	3 sources (standard)
Rotation speed input	A-phase, B-phase, Z-phase input (/MTR option)	1 input (/MTR option)
Universal analog inputs	Two analog inputs (/AUX option)	N/A
SCSI interface	N/A	Yes (/C7)
Internal HDD	N/A	Yes (10 GB, /C10)
DA output channels numbers	20 ch (/DA option)	30 ch (/DA option)
DA output resolution	16 bits	12 bits
Data memory	Direct save to USB device up to 1 GB (file size)	approximately 11 MB (internal), FDD, HDD
Communication command compatibility	Approximately 90% command compatibility	---
GP-IB communication	Standard	Standard (select GP-IB or RS-232)
Ethernet communication	Standard (No HDD and No SCSI)	Option (with HDD and SCSI option)
Ethernet communication protocol	VX11	Yokogawa original protocol
USB communication	USB-TMC	N/A
RS232 communication	N/A	Standard (select GP-IB or RS-232)

\* There are restrictions on some specifications and functions. For details, refer to the specifications.  
\* A table comparing commands between the two models will be published on the Products page of the Yokogawa website.

## Comparison of Power Analyzer WT Series and PZ

### Comparison of the specifications and functions of the WT series and the PZ4000

	WT1800	WT3000	WT500	WT210/WT230	PZ4000
Basic power accuracy (50/60 Hz)	0.1% of reading +0.05% of range	0.02% of reading +0.04% of range	0.1% of reading +0.1% of range	0.1% of reading +0.1% of range	0.1% of reading +0.025% of range
DC power accuracy	0.05% of reading +0.1% of range	0.05% of reading +0.1% of range	0.1% of reading +0.1% of range	0.3% of reading +0.2% of range	0.2% of reading +0.1% of range
Power frequency range	DC, 0.1 Hz to 1 MHz	DC, 0.1 Hz to 1 MHz	DC, 0.5 Hz to 100 kHz	DC, 0.5 Hz to 100 kHz	DC, 0.1 Hz to 1 MHz
Voltage/Current frequency range	5 MHz (typical)	1 MHz	100 kHz	100 kHz	5 MHz (typical)
Input elements	1, 2, 3, 4, 5, 6	1, 2, 3, 4	1, 2, 3	1 (WT210), 2 or 3 (WT230)	5 MHz (typical) 1, 2, 3, 4, or 1, 2, 3 +Motor module
Voltage range	1.5, 3, 6, 10, 15, 30, 60, 100, 150, 300, 600, 1000 [V]	15, 30, 60, 100, 150, 300, 600, 1000 [V]	15, 30, 60, 100, 150, 300, 600, 1000 [V]	15, 30, 60, 100, 150, 300, 600 [V]	30, 60, 120, 200, 300, 600, 1200, 2000 [Vpk]
Current range (direct input)	10 m, 20 m, 50 m, 100 m, 200 m, 500 m, 1, 2, 5 [A] or, 1, 2, 5, 10, 20, 50 [A]	5 m, 10 m, 20 m, 50 m, 0.1, 0.2, 0.5, 1, 2 [A] or, 0.5, 1, 2, 5, 10, 20, 30 [A]	500 m, 1, 2, 5, 10, 20, 40 [A]	5 m, 10 m, 20 m, 50 m, 0.1, 0.2, 0.5, 1, 2, 5, 10, 20 [A] (WT210) 0.5, 1, 2, 5, 10, 20 [A] (WT230)	5 A module: 0.1, 0.2, 0.4, 1, 2, 4, 10 [Apk] (5 A rms) 20 A module: 0.1, 0.2, 0.4, 1, 2, 4, 10 [Apk] (5 A rms) 1, 2, 4, 10, 20, 40, 100 [Apk] (20 A rms)
Current range (external sensor input)	50 m, 100 m, 250 m, 500 m, 1, 2.5, 5, 10 [V] (opt.)	50 m, 100 m, 200 m, 500 m, 1, 2, 5, 10 [V]	50 m, 100 m, 200 m, 500 m, 1, 2, 5, 10 [V] (opt.)	50 m, 100 m, 200 m [V] or 2.5, 5, 10 [V] (opt.)	0.1, 0.2, 0.4, 1 [Vpk]
Guaranteed accuracy range for voltage and current	1% to 110%	1% to 130%	1% to 110%	1% to 130%	5% to 70% (peak range)
Main measurement parameters	Voltage, current, active power, reactive power, apparent power, power factor, phase angle, frequency, peak voltage, peak current, crest factor, integration (Wh, Ah, varh, Vah)	Voltage, current, active power, reactive power, apparent power, power factor, phase angle, frequency, peak voltage, peak current, crest factor, integration (Wh, Ah, varh, Vah)	Voltage, current, active power, reactive power, apparent power, power factor, phase angle, frequency, peak voltage, peak current, crest factor, integration (Wh, Ah, varh, Vah)	Voltage, current, active power, reactive power, apparent power, power factor, phase angle, frequency, peak voltage, peak current, crest factor, integration (Wh, Ah)	Voltage, current, active power, reactive power, apparent power, power factor, phase angle, frequency, peak voltage, peak current, crest factor
Crest factor	Maximum 300	Maximum 300	Maximum 300	Maximum 300	Maximum 20
MAX hold	Yes	Yes	Yes	Yes	No
Voltage RMS/MEAN simultaneous measurement	Yes	Yes	Yes	No	Yes
Average active power	Yes (user defined uncton)	Yes (user defined uncton)	Yes (user defined uncton)	Yes	No
Active power integration (WP) (Wh)	Yes	Yes	Yes	Yes	No
Apparent power integration (WS) (VAh)	Yes	Yes	Yes	No	No
Reactive power integration (WD) (varh)	Yes	Yes	Yes	No	No
Frequency measurement	3 ch (up to 12 channels with option /FQ)	2 ch (up to 8 channels with option /FQ)	2 ch (up to 6 channels with option /FQ)	1 ch	2 ch / module
Efficiency measurement	Yes	Yes	Yes	Yes (WT230)	Yes
Motor evaluation	Torque, A / B / Z phase signal inputs (/MTR), 6 inputs, and motor evaluation (opt.)	Torque, rotating speed input (/MTR), 4 inputs, and motor evaluation (opt.)	No	No	Torque and rotational velocity input (requires sensor input module 253771) (opt.)
Auxiliary inputs	Yes (2 inputs) (opt.)	No	No	No	No
FFT spectral analysis	No	Yes (/G6) (opt.)	No	No	Yes
User-defined functions	Yes (20 functions)	Yes (20 functions)	Yes (8 functions)	No	Yes (4 functions)
Display	8.4-inch XGA TFT color LCD	8.4-inch XGA TFT color LCD	5.7-inch VGA TFT color LCD	7-segment display	6.4-inch XGA TFT color LCD
Display format	Yes (numeric, waveform, trend) /G5 (opt.) or /G6 (opt.) (bar graph, vector)	Yes (numeric, waveform, trend) /G6 (opt.) (bar graph, vector)	Yes (numeric, waveform, trend) /G5 (opt.) (bar graph, vector)	numeric (3 values)	Yes (numeric, waveform, trend, X-Y, bar graph, vector)
Sampling frequency	Approximately 2 MS/s	Approximately 200 kS/s	Approximately 100 kS/s	Approximately 50 kS/s	Maximum 5 MS/s
Harmonic measurement	(/G5) (opt.)	(/G6) (opt.)	(/G5) (opt.)	(/HRM) (opt.)	Yes
Dual harmonic measurement	(/G6) (opt.)	No	No	No	No
IEC standards-compliant harmonic measurement	No	(/G6) (opt.) (10 cycle / 50 Hz, 12 cycle / 60 Hz, 16 cycles (50 and 60 Hz))	No	No	No
IEC flicker measurement	No	(/FL) (opt.)	No	No	No
Cycle by cycle measurement	No	(/CC) (opt.)	No	No	No
Delta calculation function	(/DT) (opt.)	(/DT) (opt.)	(/DT) (opt.)	No	Yes
DA outputs	20 channels (/DA) (opt.)	20 channels (/DA) (opt.)	No	4 channels (/DA4) (opt.) (WT210) 12 channels (/DA12) (opt.) (WT230)	No
Storage (internal memory for storing data)	Approximately 32 MB	Approximately 30 MB	Approximately 20 MB	Maximum 600 samples (WT210) Maximum 300 samples (WT230) * Only reading in the WT is possible.	None, but acquisition memory has 100 kW/channel (up to 4 MW/channel can be installed with /M3 option)
Interfaces	GP-IB, USB, Ethernet RGB output (/V1) (opt.)	GP-IB, RS-232 (/C2) (opt.) USB (/C12) (opt.), VGA output (/V1) (opt.) Ethernet (/C7) (opt.)	USB, GP-IB (/C1) (opt.) Ethernet (/C7) (opt.) VGA output (/V1) (opt.)	GP-IB or RS-232 (WT210) (opt.) GP-IB or RS-232 (WT230)	GP-IB, RS-232, Centronics, SCSI (/C7) (opt.)
Synchronous measurement	Yes	Yes	No	No	Yes
Data update interval	50 m, 100 m, 200 m, 500 m, 1, 2, 5, 10, 20 [S]	50 m, 100 m, 250 m, 500 m, 1, 2, 5, 10, 20 [S]	100 m, 200 m, 500 m, 1, 2, 5 [S]	100 m, 250 m, 500 m, 1, 2, 5 [S]	Depends on waveform acquisition length and calculations
Removable storage	USB	PC card interface, USB (/C5) (opt.)	USB	No	FDD
Built-in printer	front side (/B5) (opt.)	front side (/B5) (opt.)	No	No	top side (/B5) (opt.)

There are limitations on some specifications and functions. See the individual product catalogs for details. (opt.) : Optional

## Characteristics comparison

### Examples of frequency characteristics of the WT series and the PZ4000

Examples of frequency and power accuracy characteristics

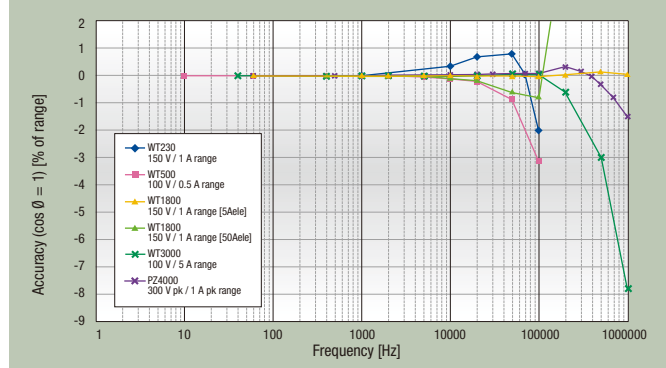

Total power error with rated range input for an arbitrary power factor (at 50/60 Hz)

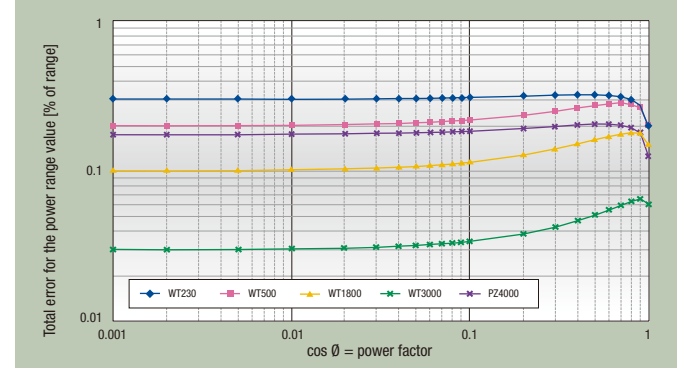

Influence of the common-mode voltage on the readings

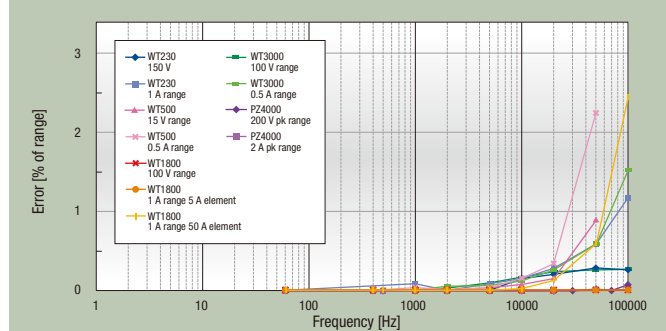

Example of the frequency and power accuracy for zero power factor

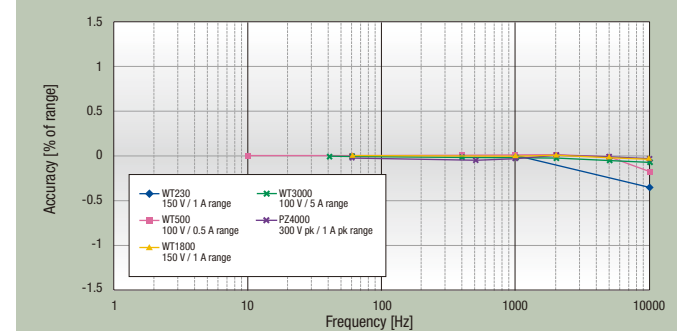

### Comparison of the accuracy and range between the WT series and PZ

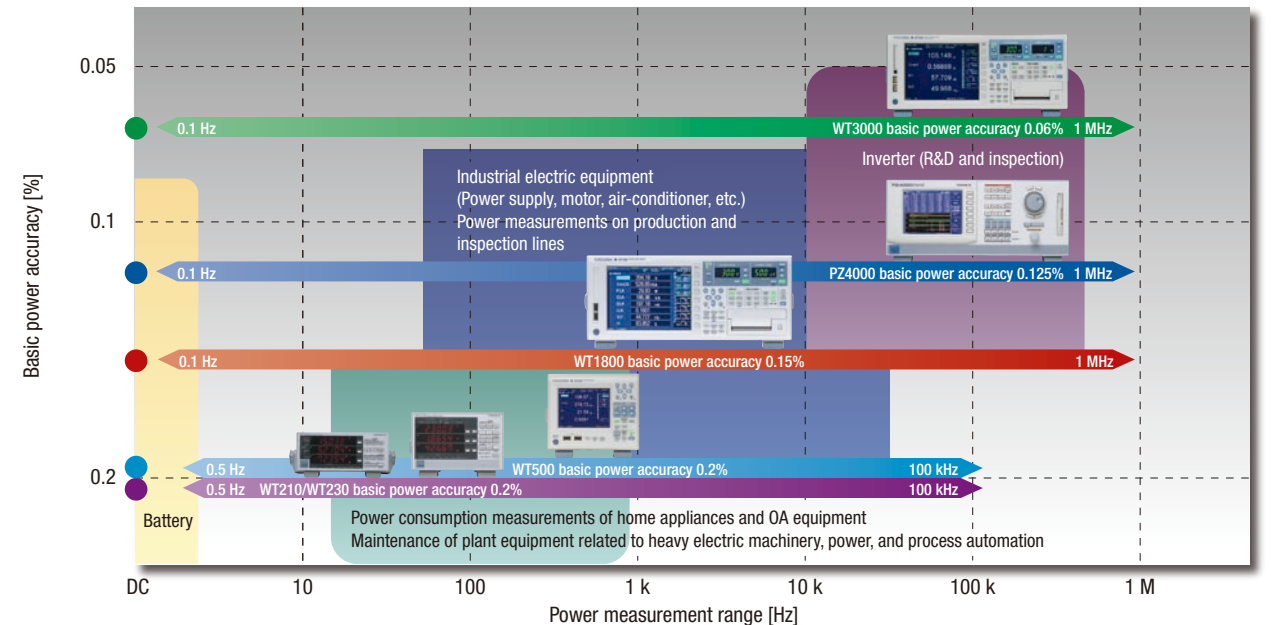



## SUPPORTS Crest Factor 6

The crest factor is the ratio of the waveform peak value and the RMS value.

$$\text{Crest factor (CF, peak factor)} = \frac{\text{waveform peak}}{\text{RMS value}}$$

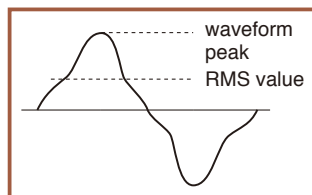

When checking the measurable crest factor of our power measuring instruments, please refer to the following equation.

$$\text{Crest factor (CF)} = \frac{\{\text{measuring range} \times \text{CF setting (3 or 6)}\}}{\text{measured value (RMS)}}$$

\* However, the peak value of the measured signal must be less than or equal to the continuous maximum allowed input

\* The crest factor on a power meter is specified by how many times peak input value is allowed relative to rated input value. Even if some measured signals exist whose crest factors are larger than the specifications of the instrument (the crest factor standard at the rated input), you can measure signals having crest factors larger than the specifications by setting a measurement range that is large relative to the measured

signal. For example, even if you set CF = 3, CF 5 or higher measurements are possible as long as the measured value (RMS) is 60% or less than the measuring range. Also, for a setting of CF = 3, measurements of CF = 300 are possible with the minimum effective input (1% of measuring range).

## Calculation Method of Voltage and Current and Procedure to Set Synchronous Source

AC signals are repeatedly changing waveforms in terms of instantaneous values. An averaging calculation by the repeated periods is required to be performed to measure the power value of the AC signals. The WT1800 uses an ASSP method to perform averaging processing by the periods for the instantaneous data measured at an approximately 2 MS/s rate to obtain the measurement value.

### ASSP Method

An ASSP (Average for the Synchronous Source Period) method is used to calculate the measurement value by performing calculation processing for the sampling data within the data update period (with the exception of the integrated power value WP and integrated current value q in the DC mode). This method uses a frequency measurement circuit to detect the period of the input signal set in the synchronous source and performs calculation using the sampling data in the interval equivalent to the integral multiple of the input period. Since the ASSP method basically is able to obtain the measurement value by just performing an averaging calculation for the interval of one period, it is effective for a short data update period or efficient measurement of low frequency signals. If this method cannot detect the period of the set synchronous source signal correctly, the measurement values will not be correct. Therefore, it is necessary to check to make sure the frequency of the synchronous source signal is measured and displayed correctly. For the notes of the settings of the synchronous source signal and frequency filter, refer to the instruction manual.

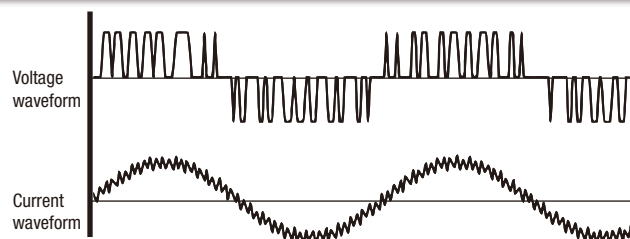

### Setting Synchronous Source

In the case of such a signal, the synchronous source is set to the current signal side with less harmonic components. Even if harmonic components (noise) are superimposed on the current waveforms, measurements can be stabilized by turning on the frequency filter to detect a zero crossing reliably. When the frequency measurement results are correct and stable, you can consider the filter settings are right. A frequency filter also functions as a filter to detect a zero crossing of the synchronous source. That's why a frequency filter is also called a synchronous source filter or a zero crossing filter.

## Selecting formulas for calculating apparent power and reactive power

There are several types of power—active power, reactive power, and apparent power. Generally, the following equations are satisfied:

$$\begin{aligned} \text{Active power } P &= UI \cos \theta & (1) \\ \text{Reactive power } Q &= UI \sin \theta & (2) \\ \text{Apparent power } S &= UI & (3) \end{aligned}$$

In addition, these power values are related to each other as follows:

$$(\text{Apparent power } S)^2 = (\text{Active power } P)^2 + (\text{Reactive power } Q)^2 \quad (4)$$

U: Voltage RMS  
I: Current RMS  
θ: Phase between current and voltage

Three-phase power is the sum of the power values in the individual phases.

These defining equations are only valid for sinewaves. In recent years, there has been an increase in measurements of distorted waveforms, and users are measuring sinewave signals less frequently. Distorted waveform measurements provide different measurement values for apparent power and reactive power depending on which of the above defining equations is selected. In addition, because there is no defining equation for power in a distorted wave, it is not necessarily clear which equation is correct. Therefore, three different formulas for calculating apparent power and reactive power for three-phase four-wire connection are provided with the WT1800.

### ● TYPE1 (method used in normal mode with older WT Series models)

With this method, the apparent power for each phase is calculated from equation (3), and reactive power for each phase is calculated from equation (4). Next, the results are added to calculate the power.

$$\begin{aligned} \text{Active power: } P\Sigma &= P1+P2+P3 \\ \text{Apparent power: } S\Sigma &= S1+S2+S3 (=U1 \times I1 + U2 \times I2 + U3 \times I3) \\ \text{Reactive power: } Q\Sigma &= Q1+Q2+Q3 (= \sqrt{(U1 \times I1)^2 - P1^2} + \sqrt{(U2 \times I2)^2 - P2^2} + \sqrt{(U3 \times I3)^2 - P3^2}) \end{aligned}$$

\*S1, S2, and S3 are calculated with a positive sign for the leading phase and a negative sign for the lagging phase.

### ● TYPE2

The apparent power for each phase is calculated from equation (3), and the results are added together to calculate the three-phase apparent power (same as in TYPE1). Three-phase reactive power is calculated from three-phase apparent power and three-phase active power using equation (4).

$$\begin{aligned} \text{Active power: } P\Sigma &= P1+P2+P3 \\ \text{Apparent power: } S\Sigma &= S1+S2+S3 (=U1 \times I1 + U2 \times I2 + U3 \times I3) \\ \text{Reactive power: } Q\Sigma &= \sqrt{S\Sigma^2 - P\Sigma^2} \end{aligned}$$

### ● TYPE3 (method used in harmonic measurement mode with WT1600 and PZ4000)

This is the only method in which the reactive power for each phase is directly calculated using equation (2). Three-phase apparent power is calculated from equation (4).

$$\begin{aligned} \text{Active power: } P\Sigma &= P1+P2+P3 \\ \text{Apparent power: } S\Sigma &= \sqrt{P\Sigma^2 + Q\Sigma^2} \\ \text{Reactive power: } Q\Sigma &= Q1+Q2+Q3 \end{aligned}$$

## Inputs

Item	Specification
Input terminal type	Voltage Plug-in terminal (safety terminal)
	Current • Direct input: Large binding post • External current sensor input: Insulated BNC connector
Input type	Voltage Floating input, resistive potential method
	Current Floating input, shunt input method
	Measurement range
Measurement range	Voltage 1.5 V, 3 V, 6 V, 10 V, 15 V, 30 V, 60 V, 100 V, 150 V, 300 V, 600 V, 1000 V (for crest factor 3) 0.75 V, 1.5 V, 3 V, 5 V, 7.5 V, 15 V, 30 V, 50 V, 75 V, 150 V, 300 V, 500 V (for crest factor 6)
	Current • Direct input: 50 A input element 1 A, 2 A, 5 A, 10 A, 20 A, 50 A (for crest factor 3) 500 mA, 1 A, 2.5 A, 5 A, 10 A, 25 A (for crest factor 6) 5 A input element 10 mA, 20 mA, 50 mA, 100 mA, 200 mA, 500 mA, 1 A, 2 A, 5 A (for crest factor 3) 5 mA, 10 mA, 25 mA, 50 mA, 100 mA, 250 mA, 500 mA, 1 A, 2.5 A (for crest factor 6) • External current sensor input: 50 mV, 100 mV, 200 mV, 500 mV, 1 V, 2 V, 5 V, 10 V (for crest factor 3) 25 mV, 50 mV, 100 mV, 250 mV, 500 mV, 1 V, 2.5 V, 5 V (for crest factor 6)
	Instrument loss
	Voltage Input resistance: Approx. 2 M Input capacitance: Approx. 10 pF
	Current • Direct input: 50 A input element: Approximately 2 mΩ + approximately 0.07 μH 5 A input element: Approximately 100 mΩ + approximately 0.07 μH • External current sensor input: Approximately 1 mΩ
	Instantaneous maximum allowable input (20 ms or less)
	Voltage Peak voltage of 4 kV or RMS of 2 kV, whichever is lower
	Current • Direct input (50 A input element): Peak current of 450 A or RMS of 300 A, whichever is lower • Direct input (5 A input element): Peak current of 30 A or RMS of 15 A, whichever is lower • External current sensor input: Peak current is less than 10 times the range
	Instantaneous maximum allowable input (1 second or less)
	Voltage Peak voltage of 3 kV or RMS of 1.5 kV, whichever is lower
Current • Direct input (50 A input element): Peak current of 150 A or RMS of 55 A, whichever is lower • Direct input (5 A input element): Peak current of 10 A or RMS of 7 A, whichever is lower • External current sensor input: Peak current is less than 10 times the range	
Continuous maximum allowable input	
Voltage Peak voltage of 2 kV or RMS of 1.1 kV, whichever is lower If the frequency of the input voltage exceeds 100 kHz, (1200-f) Vrms or less The letter f indicates the frequency of the input voltage and the unit is kHz.	
Current • Direct input (50 A input element): Peak current of 150 A or RMS of 55 A, whichever is lower • Direct input (5 A input element): Peak current of 10 A or RMS of 7 A, whichever is lower • External current sensor input: Peak current is less than 5 times the range	
Continuous maximum common mode voltage (50/60 Hz)	
1000 Vrms	
Influence from common voltage	
Apply 1000 Vrms for input terminal and case with the voltage input terminals shorted, the current input terminals open, and the external current sensor input terminals shorted.	
• 50/60 Hz: ±0.01% of range or less • Reference value up to 100 kHz: ±{(maximum rated range) / (rated range) × 0.001 × (% of range) or less. For external current sensor input, add max. rated range / rated range × (0.0125 × log (f × 1000) - 0.021%) of range. However, 0.01% or more. The unit of f is kHz. The maximum rated range within the equation is 1000 V or 50 A or 5 A or 10 V.	
Line filter	
Select OFF, 100 Hz to 100 kHz (in increments of 100 Hz), 300 kHz, or 1 MHz	
Frequency filter	
Select OFF, 100 Hz, or 1 kHz	
A/D converter	
Simultaneous voltage and current input conversion Resolution: 16-bit Conversion speed (sampling period): Approximately 500 ns. See harmonic measurement items for harmonic measurement.	
Range switching	
A range can be set for each input element	
Auto range functions	
Range up	
• When the measured values of Urms and Irms exceed 110% of the range • When the peak value of the input signal exceeds approximately 330% of the range (or approximately 660% for crest factor 6)	
Range down	
When the following conditions are met, the range setting switches down.	
• When the measured values of U RMS and I RMS fall to 30% or less of the range • When the measured values of U RMS and I RMS fall to 105% or less of the lower range (range to which the range setting switches down) • When the measured values of Upk and Ipk fall to 300% or less of the lower range (600% or less for crest factor 6)	

## Display

Item	Specification
Display	8.4-inch color TFT LCD display
Total number of pixels*	1024 (horizontal) × 768 (vertical) dots
Display update rate	Same as the data update rate.
	1) The display update interval of numeric display alone is 200 ms to 500 ms (which varies depending on the number of display items) when the data update rate is 50 ms, 100 ms, and 200 ms.
	2) The display update interval of display items other than numeric display (including custom displays) is approximately 1 second when the data update rate is 50 ms, 200 ms, and 500 ms.

\*Up to approximately 0.002% of the pixels on the LCD may be defective.

## Display Items

### Calculation Functions

Measurement Function	Single-phase 3-wire	3-phase 3-wire	3-phase 3-wire (3-voltage 3-current measurement)	3-phase 4-wire
Voltage U Σ [V]	(U1+U2)/2	(U1+U2+U3)/3		
Current I Σ [A]	(I1+I2)/2	(I1+I2+I3)/3		
Active power P Σ [W]	P1+P2			P1+P2+P3
Apparent Power S Σ [VA]	S1-S2	√3/2 (S1+S2)	√3/3 (S1+S2+S3)	S1+S2+S3
Reactive Power Q Σ [var]	TYPE3	√(PΣ²+QΣ²)		
	TYPE1	Q1+Q2		Q1+Q2+Q3
	TYPE2	√(SΣ²-PΣ²)		
Corrected Power Pc Σ [W]	TYPE3	Q1+Q2		Q1+Q2+Q3
	TYPE1	Q1+Q2		Q1+Q2+Q3
Integrated Power WP [Wh]	WP1+WP2			WP1+WP2+WP3
Integrated Power (Positive) WP+ Σ [Wh]	When WPTYPE is set to CHARGE/DISCHARGE WP+1+WP+2			WP+1+WP+2+WP+3
Integrated Power (Negative) WP- Σ [Wh]	When WPTYPE is set to CHARGE/DISCHARGE WP-1+WP-2			WP-1+WP-2+WP-3
Integrated Current q Σ [Ah]	q1+q2			q1+q2+q3
Integrated Current (Positive) q+ [Ah]	q+1+q+2			q+1+q+2+q+3
Integrated Current (Negative) q- [Ah]	q-1+q-2			q-1+q-2+q-3
Integrated reactive Power WQ Σ [varh]	1/N Σ I QΣ (n) I × Time			
	Q Σ (n) indicates the Σ function of the nth reactive power, N indicates the number of data updates, and the unit of Time is h			
Integrated apparent Power WS Σ [VAh]	1/N Σ SΣ (n) × Time			
	S Σ (n) indicates the Σ function of the nth apparent power, N indicates the number of data updates, and the unit of Time is h			
Power Factor Σ	P Σ / S Σ			
Phase angle θ Σ [°]	COS⁻¹ (P Σ / S Σ)			

Note 1) The instrument's apparent power (S), reactive power (Q), power factor (λ), and phase difference (θ) are calculated using measured values of voltage, current, and active power. (However, reactive power is calculated directly from sampled data when TYPE3 is selected.) Therefore, when distorted waveforms are input, these values may be different from those of other measuring instruments based on different measuring principals.

Note 2) The value of Q for each phase in the Q Σ calculation is calculated with a preceding minus sign (-) when the current input leads the voltage input, and a plus sign when it lags the voltage input, so the value of Q Σ may be negative.

### Numerical Display

#### Measurement functions obtained for each input element

Item	Symbol and Meaning
Voltage (V)	Urms: True RMS value, Urmn: Rectified mean value calibrated to the RMS value, Udc: Simple mean value, Urmn: Rectified mean value, Uac: AC component
Current (A)	Urms: True RMS value, Imn: Rectified mean value calibrated to the RMS value, Idc: Simple mean value, Irmn: Rectified mean value, Iac: AC component
Active power (W)	P
Apparent power (VA)	S
Reactive power (var)	Q
Power factor	λ
Phase angle (°)	θ
Frequency (Hz)	fU (FreqU): Voltage frequency, fI (FreqI): Current frequency Three fU and fI of all elements included can be measured simultaneously. A frequency measurement option allows you to simultaneously measure all fU and fI of all elements. Unselected signals are displayed with "....." indicating no data.

Maximum and minimum voltage values (V)	U+pk: Maximum voltage value, U-pk: Minimum voltage value
Maximum and minimum current values (A)	I+pk: Maximum current value, I-pk: Minimum current value
Maximum and minimum power values (W)	P+pk: Maximum power value, P-pk: Minimum power value
Crest factor	CFU: Voltage crest factor, CFI: Current crest factor
Corrected power (W)	Pc
Integration	Time: Integration time WP+: Sum of the amount of both positive and negative power WP-: Sum of negative P (amount of power returned to the grid) q+: Sum of the amount of both positive and negative current q-: Sum of negative I (amount of current) q-: Sum of negative I (amount of current) WS: Amount of apparent power WQ: Amount of reactive power However, the amount of current is integrated by selecting any one of Irms,Imn,Idc,Iac, and Irmn depending on the setting of the current mode.



# Specifications

Measurement function (Σ function) obtained for each connected unit (Σ A, Σ B, Σ C)	
Item	Symbol and Meaning
Voltage (V)	Urms Σ: True RMS value, Umn Σ: Rectified mean value calibrated to the RMS value, Udc Σ: Simple mean value, Urmn: Rectified mean value, Uac Σ: AC component
Current (A)	Irms Σ: True RMS value, Imn Σ: Rectified mean value calibrated to the RMS value, Idc Σ: Simple mean value, Irmn Σ: Rectified mean value, Iac Σ: AC component
Active power (W)	P Σ
Apparent power (VA)	S Σ
Reactive power (var)	Q Σ
Power factor	λ Σ
Corrected power (W)	Pc Σ
Integration	Applicable standards IEC76-1 (1976), IEC76-1 (1993) Time Σ: Integration time WP Σ: Sum of the amount of both positive and negative power WP+ Σ: Sum of positive P (amount of power consumed) WP- Σ: Sum of negative P (amount of power returned to the grid) q Σ: Sum of the amount of both positive and negative current q+ Σ: Sum of positive I (amount of current) q- Σ: Sum of negative I (amount of current) WS Σ: Integration of S Σ WQ Σ: Integration of Q Σ

## Harmonic Measurement (Option)

Measurement function obtained for each input element	
Item	Symbol and Meaning
Voltage (V)	U (k): RMS value of the harmonic voltage of order k <sup>-1</sup> , U: Voltage RMS value (Total value <sup>-2</sup> )
Current (A)	I (k): RMS value of the harmonic current of order k, I: Current RMS value (Total value)
Active power (W)	P (k): Active power of the harmonic of order k, P: Active power (Total value)
Apparent power (VA)	S (k): Apparent power of the harmonic of order k, S: Total apparent power (Total value)
Reactive power (var)	Q (k): Reactive power of the harmonic of order k, Q: Total reactive power (Total value)
Power factor	λ (k): Power factor of the harmonic of order k, λ: Total power factor (Total value)
Phase angle (°)	θ (k): Phase angle between the harmonic voltage and current of order k, θ: Total phase angle θ U (k): Phase angle of each harmonic voltage U (k) relative to the fundamental wave U (1) θ I (k): Phase angle of each harmonic current I (k) relative to the fundamental wave I (1)
Impedance of the load circuit ( )	Z (k): Impedance of the load circuit for the harmonic of order k
Resistance and reactance of the load circuit ( )	Rs (k): Resistance of the load circuit to the harmonic of order k when the resistance R, the inductance L, and the capacitor C are connected in series Xs (k): Reactance of the load circuit to the harmonic of order k when the resistance R, the inductance L, and the capacitor C are connected in series Rp (k): Resistance of the load circuit to the harmonic of order k when the resistance R, the inductance L, and the capacitor C are connected in parallel Xp (k): Reactance of the load circuit to the harmonic of order k when the resistance R, the inductance L, and the capacitor C are connected in parallel
Harmonic content [%]	UhdF (k): Ratio of the harmonic voltage U (k) to U (1) or U IhdF (k): Ratio of the harmonic current I (k) to I (1) or I PhdF (k): Ratio of the active harmonic power P (k) to P (1) or P
Total harmonic distortion [%]	Uthd: Ratio of the total harmonic <sup>-3</sup> voltage to U (1) or U Ithd: Ratio of the total harmonic current to I (1) or I Pthd: Ratio of the total harmonic active power to P (1) or P
Telephone harmonic factor	Uthf: Voltage telephone harmonic factor, Ithf: Current telephone harmonic factor Applicable standard: IEC34-1 (1996)
Telephone influence factor	Utif: Voltage telephone influence factor, Itif: Current telephone influence factor Applicable standard: IEEE Std 100 (1996)
Harmonic voltage factor <sup>-4</sup>	hvf: harmonic voltage factor
Harmonic current factor <sup>-4</sup>	hcf: harmonic current factor
K-factor	Ratio of the sum of the squares of weighted harmonic components to the sum of the squares of the orders of harmonic current

\*1: Order k is an integer in the range from 0 to the upper limit value for the measured order. The 0th order is a DC current component (dc). The upper limit value for the measured order is automatically determined up to the 500th order depending on the frequency of the PLL source.

\*2: The total value is calculated by obtaining the fundamental wave (the 1st order) and all harmonic components (from the 2nd order to the upper limit value for the measured order). Also, the DC component (dc) can be added to the equation.

\*3: The total harmonic is calculated by obtaining the total harmonic component (from the 2nd order to the upper limit value for the measured order)

\*4: The equations may vary depending on the definitions in the standards, etc. Check the standards for details.

**Measurement function indicating the phase difference of the fundamental wave between the voltage and current between input elements**  
This is a measurement function indicating the phase angle of the fundamental wave U (1) or I (1) of another element to the fundamental wave U(1) of the element with the smallest number among input elements assigned to the connected unit. The following table shows measurement functions for the connected unit with a combination of the elements 1, 2, and 3.

Item	Symbol and Meaning
Phase angle U1-U2 (°)	θU1-U2: Phase angle of the fundamental wave (U2 (1)) of the voltage of the element 2 to the fundamental wave (U1 (1)) of the voltage of the element 1
Phase angle U1-U3 (°)	θU1-U3: Phase angle of the fundamental wave (U3 (1)) of the voltage of the element 3 to U1 (1)
Phase angle U1-I1 (°)	θU1-I1: Phase angle of the fundamental wave (I1 (1)) of the current of the element 1 to U1 (1)
Phase angle U2-I2 (°)	θU2-I2: Phase angle of the fundamental wave (I2 (1)) of the current of the element 2 to U2 (1)
Phase angle U3-I3 (°)	θU3-I3: Phase angle of the fundamental wave (I3 (1)) of the current of the element 3 to U3 (1)
EaU1 to EaU6 (°), EaI1 to EaI6 (°)	Phase angle θ of the fundamental waves of U1 to I6 based on the rise of the Z terminal input in the motor evaluation function (option). N is the set value for the number of poles in the motor evaluation function.

Measurement function (Σ function) obtained for each connected unit (Σ A, Σ B, Σ C)	
Item	Symbol and Meaning
Voltage (V)	U Σ (1): RMS of the harmonic voltage of order 1, U Σ: RMS of the voltage (Total value <sup>-1</sup> )
Current (A)	I Σ (1): RMS of the harmonic current of order 1, I Σ: RMS of the current (Total value)
Active power (W)	P Σ (1): Harmonic active power of order 1, P Σ: Total active power (Total value)
Apparent power (VA)	S Σ (1): Harmonic apparent power of order 1, S Σ: Total apparent power (Total value)
Reactive power (var)	Q Σ (1): Harmonic reactive power of order 1, Q Σ: Total reactive power (Total value)
Power factor	λ Σ (1): Harmonic power factor of order 1, λ Σ: Total power factor (Total value)

\*1: The total value is calculated by obtaining the fundamental wave (the 1st order) and all harmonic components (from the 2nd order to the upper limit value for the measured order). Also, the DC component (dc) can be added to the equation.

## Delta Calculation (Option)

Item	Delta Calculation Setting	Symbol and Meaning
Voltage (V)	difference	Δ U1: Differential voltage between u1 and u2 determined by computation
	3P3W->3V3A	Δ U1: Line voltage that is not measured but can be computed for a three-phase, three-wire system
	DELTA->STAR	Δ U1, Δ U2, Δ U3: Phase voltage that can be computed by a three-phase, three-wire (3V3A) system Δ U Σ = (Δ U1 + Δ U2 + Δ U3)/3
STAR->DELTA	Δ U1, Δ U2, Δ U3: Line voltage that can be computed for a three-phase, four-wire system Δ U Σ = (Δ U1 + Δ U2 + Δ U3)/3	
	difference	Δ I1: Differential current between i1 and i2 determined by computation
	3P3W->3V3A	Δ I: Phase current that is not measured
DELTA->STAR	Δ I: Neutral line current	
	STAR->DELTA	Δ I: Neutral line current
	difference	---
3P3W->3V3A	---	
	DELTA->STAR	Δ P1, Δ P2, Δ P3: Phase power determined by computation for a three-phase, three-line (3V3A) system Δ P Σ = Δ P1 + Δ P2 + Δ P3
	STAR->DELTA	---

## Waveform/Trend

Item	Specification
Waveform display	Displays the waveforms of the voltage and current from elements 1 through 6, torque, speed, AUX1, and AUX2.
Trend display	Displays trends in numerical data of the measurement functions in a sequential line graph. Number of measurement channels: Up to 16 parameters

## Bar Graph/Vector (Option)

Item	Specification
Bar graph display	Displays the size of each harmonic in a bar graph.
Vector display	Displays the vector of the phase difference in the fundamental waves of voltage and current.

## Accuracy

### Voltage and Current

Item	Specification	
Accuracy (six-month)	Conditions Temperature: 23±5°C, Humidity: 30 to 75%RH, Input waveform: Sine wave, Power factor (λ): 1, Common mode voltage: 0 V, Crest factor: 3, Line filter: OFF Frequency filter: 1 kHz or less when ON, after warm-up. After zero level compensation or range value changed while wired. The unit of f within the accuracy equation is kHz.	
Voltage	Frequency	Accuracy ±(Measurement reading error + Setting range error)
	DC	±(0.05% of reading + 0.1% of range)
Frequency	0.1 Hz ≤ f < 10 Hz	±(0.1% of reading + 0.2% of range)
	10 Hz ≤ f < 45 Hz	±(0.1% of reading + 0.1% of range)
	45 Hz ≤ f ≤ 66 Hz	±(0.1% of reading + 0.05% of range)
	66 Hz < f ≤ 1 kHz	±(0.1% of reading + 0.1% of range)
	1 kHz < f ≤ 50 kHz	±(0.3% of reading + 0.1% of range)
	50 kHz < f ≤ 100 kHz	±(0.6% of reading + 0.2% of range)
	100 kHz < f ≤ 500 kHz	±((0.006 × f) of reading + 0.5% of range)
	500 kHz < f ≤ 1 MHz	±((0.022 × f - 8)% of reading + 1% of range)
	Frequency bandwidth	5 MHz (-3 dB, typical)
	Current	Frequency
DC		±(0.05% of reading + 0.1% of range)
0.1 Hz ≤ f < 10 Hz		±(0.1% of reading + 0.2% of range)
10 Hz ≤ f < 45 Hz		±(0.1% of reading + 0.1% of range)
45 Hz ≤ f ≤ 66 Hz		±(0.1% of reading + 0.05% of range)
66 Hz < f ≤ 1 kHz		±(0.1% of reading + 0.1% of range)
1 kHz < f ≤ 50 kHz		±(0.3% of reading + 0.1% of range)
50 kHz < f ≤ 100 kHz		±(0.6% of reading + 0.2% of range)
100 kHz < f ≤ 500 kHz		±((0.00725 × f - 0.125)% of reading + 0.5% of range)
500 kHz < f ≤ 1 MHz		±((0.022 × f - 8)% of reading + 1% of range)

Item	Specification		
Influence of power factor (λ)	When λ = 0	Apparent power reading × 0.1% for the range from 45 to 66 Hz For frequencies other than the above (Reference values) 5 A input element and external sensor inputs: Apparent power reading × (0.1 + 0.05 × f (kHz))% Direct input of the 50 A input element: Apparent power reading × (0.1 + 0.3 × f (kHz))%	
	When 0 < λ < 1	Power reading × [(Power reading error %) + (Power range error %) × (Power range/Apparent power reading) + (tan θ × (Influence % when λ = 0))] θ is the phase angle between the voltage and current.	
	Influence of line filter	When the cutoff frequency (fc) is 100 Hz to 100 kHz	Voltage/current Up to (fc/2) Hz: Add 2 × [1 - √(1/(1 + (f/fc) <sup>4</sup> ))] × 100 + (20 × f/300 k)% of reading Power Up to (fc/2) Hz: Add 4 × [1 - √(1/(1 + (f/fc) <sup>4</sup> ))] × 100 + (40 × f/300 k)% of reading When the cutoff frequency (fc) is 300 kHz and 1 MHz
		Voltage/current Up to (fc/10) Hz: Add (20 × f/fc)% of reading Power Up to (fc/10) Hz: Add (40 × f/fc)% of reading	
	Lead/lag phase detection (D (LEAD)/G (LAG) of the phase angle)	The phase lead and lag can be detected correctly when the voltage and current input signals are as follows.	
		• Sine wave • 50% or more of the measurement range (100% or more for crest factor 6) • Frequency: 20 Hz to 10 kHz • Phase angle: ±(5° to 175°)	
	Symbol s for the reactive power Q I calculation	The symbol s shows the lead/lag of each element, and "-" indicates leading.	
	Temperature coefficient	±0.03% of reading/°C at 5 to 18°C or 28 to 40°C	

## Power

Item	Specification	
Accuracy (six-month)	Conditions Same as the accuracy of the voltage and current	
Frequency	Accuracy ±(Reading error + Measurement range error)	
	DC	±(0.05% of reading + 0.1% of range)
	0.1 Hz ≤ f < 10 Hz	±(0.3% of reading + 0.2% of range)
	10 Hz ≤ f < 45 Hz	±(0.1% of reading + 0.2% of range)
	45 Hz ≤ f ≤ 66 Hz	±(0.1% of reading + 0.05% of range)
	66 Hz < f ≤ 1 kHz	±(0.2% of reading + 0.1% of range)
	1 kHz < f ≤ 50 kHz	±(0.3% of reading + 0.2% of range) 50 mV, 100 mV, 200 mV range of the external current sensor input ±(0.5% of reading + 0.2% of range) Direct input of the 50 A input element ±((0.1 × f + 0.2)% of reading + 0.2% of range)
	50 kHz < f ≤ 100 kHz	±(0.7% of reading + 0.3% of range) Direct input of the 50 A input element ±((0.3 × f - 9.5)% of reading + 0.3% of range)
	100 kHz < f ≤ 200 kHz	±((0.0105 × f - 0.25)% of reading + 1% of range) Direct input of the 50 A input element ±((0.09 × f + 11)% of reading + 1% of range)
	200 kHz < f ≤ 500 kHz	±((0.0105 × f - 0.25)% of reading + 1% of range) Direct input of the 50A input element: It does not define accuracy.
500 kHz < f ≤ 1 MHz	±((0.048 × f - 20)% of reading + 2% of range) Direct input of the 50A input element: It does not define accuracy.	

- Add the following value to the above accuracy for the external current sensor range.  
Current DC accuracy: 50 μV  
Power DC accuracy: 50 μV/External current sensor range rating) × 100% of range
- Add the following value to the above accuracy for the direct current input range.  
50 A input element  
Current DC accuracy: 1 mA  
Power DC accuracy: (1 mA/Direct current input range rating) × 100% of range  
5 A input element  
Current DC accuracy: 10 μA  
Power DC accuracy: (10 μA/Direct current input range rating) × 100% of range
- Accuracy of the waveform display data, Upk and Ipk  
Add the following value to the above accuracy (reference value). The effective input range is within ±300% of range (within ±600% for crest factor 6)  
Voltage input: {1.5 × √(15/range) + 0.5}% of range  
Direct current input range  
50 A input element; 3 × √(1/range)% of range + 10 mA  
5 A input element: {10 × √(10 mV/range) + 0.5}% of range  
External current sensor input range  
50 mV to 200 mV range: {10 × √(0.01/range) + 0.5}% of range  
500 mV to 10 V range: {10 × √(0.05/range) + 0.5}% of range
- Influence from a temperature change after zero level compensation or range change  
Add the following value to the above accuracy.  
Voltage DC accuracy: 0.02% of range/°C  
DC accuracy of the direct current input  
50 A input element: 1 mA/°C  
5 A input element: 10 μA/°C  
DC accuracy of the external current sensor input: 50 μV/°C  
DC power accuracy: Influence from the voltage × Influence from the current
- Influence from the self-heating caused by voltage input
- Add the following value to the voltage and power accuracy.  
AC input signal: 0.0000001 × U<sup>2</sup> % of reading  
DC input signal: 0.0000001 × U<sup>2</sup> % of reading + 0.0000001 × U<sup>2</sup> % of range  
U is the voltage reading (V).

- The influence from the self-heating continues until the temperature of the input resistor decreases, even if the voltage input changes to a small value.
- Influence from the self-heating caused by current input  
Add the following value to the current and power accuracy of the 50 A element.  
AC input signal: 0.00006 × I<sup>2</sup> % of reading  
DC input signal: 0.00006 × I<sup>2</sup> % of reading + 0.004 × I<sup>2</sup> mA  
Add the following value to the current and power accuracy of the 5 A element.  
AC input signal: 0.006 × I<sup>2</sup> % of reading  
DC input signal: 0.006 × I<sup>2</sup> % of reading + 0.004 × I<sup>2</sup> % of reading  
I is the current reading (A).
- The influence from the self-heating continues until the temperature of the shunt resistor decreases, even if the current input changes to a small value.
- Addition to the accuracy according to the data update rate  
Add 0.1% of reading when the data update rate is 50 ms and 0.05% of reading when 100 ms.
- Range of guaranteed accuracy by frequency, voltage, and current  
All accuracies between 0.1 Hz and 10 Hz are reference values.  
If the voltage exceeds 750 V at 30 kHz to 100 kHz, the voltage and power values are reference values.  
If the current exceeds 20 A at DC, 10 Hz to 45 Hz, or 400 Hz to 100 kHz, the current and power accuracies are reference values.
- Accuracy for crest factor 6: Same as the range accuracy of crest factor 3 for twice the range.

Effective input range	Udc and Idc: 0 to ±110% of the measurement range Urms and Irms: 1 to 110% of the measurement range Umn and Imn: 10 to 110% of the measurement range Urmn and Irmn: 10 to 110% of the measurement range Power DC measurement: 0 to ±110% AC measurement: ±110% of the power range when the voltage and current range is 1 to 110%. However, the synchronization source level shall meet the input signal level of frequency measurement. Each of the lower limits is doubled for crest factor 6.
Max. display value	140% of the voltage and current range rating
Min. display value	Displays the following values relative to the measurement range. • Urms, Uac, Irms, Iac: Up to 0.3% (up to 0.6% for crest factor 6) • Umn, Urmn, Imn, Irmn: Up to 2% (up to 4% for crest factor 6) Below that, zero suppress. Current integration value q also depends on the current value.
Measurement lower limit frequency	Data update rate: 50 ms 100 ms 200 ms 500 ms Measurement lower limit frequency: 45 Hz 25 Hz 12.5 Hz 5 Hz Data update rate: 1 s 2 s 5 s 10 s 20 s Measurement lower limit frequency: 2.5 Hz 1.25 Hz 0.5 Hz 0.2 Hz 0.1 Hz
Accuracy of apparent power S	Voltage accuracy + Current accuracy
Accuracy of reactive power Q	Accuracy of apparent power + √(1.0004 - λ <sup>2</sup> ) - √(1 - λ <sup>2</sup> ) × 100 % of range
Accuracy of power factor λ	± [(λ - λ/1.0002) + λcosθ - cos {θ + sin <sup>-1</sup> (influence of power factor of power when λ = 0%/100)}] ± 1 digit when voltage and current is at rated input of the measurement range. θ is the phase difference of voltage and current.
Accuracy of phase angle θ	± [  θ - (cos-1 (λ/1.0002))   + sin <sup>-1</sup> (influence of power factor of power when λ = 0%/100) ] deg ± 1 digit, when voltage and current is at the rated input of the measurement range.
One-year accuracy	Multiply the reading error of the six-month accuracy by a factor of 1.5

## Functions

### Measurement Functions and Conditions

Item	Specification
Crest factor	300 (relative to the minimum valid input) 3 or 6 (when inputting the rated values of the measurement range)
Measurement period	Interval for determining the measurement function and performing calculations. • The measurement period is set by the zero crossing of the reference signal (synchronization source) excluding watt hour WP and ampere hour q during DC mode • Harmonic display The measurement period is from the beginning of the data update interval to 1024 or 8192 points at the harmonic sampling frequency.
Wiring	1P2W (single-phase, two-wire), 1P3W (single-phase, 3-wire), 3P3W (3-phase, 3-wire), 3P4W (3-phase, 4-wire), 3P3W (3V3A) (3-phase, 3-wire, 3-volt/3-amp measurement) However, the number of available wiring systems varies depending on the number of installed input elements.
Scaling	When inputting output from external current sensors, VT, or CT, set the current sensor conversion ratio, VT ratio, CT ratio, and power coefficient in the range from 0.0001 to 99999.9999.
Averaging	• The average calculations below are performed on the normal measurement parameters of voltage U, current I, power P, apparent power S, and reactive power Q. Power factor λ and phase angle are determined by calculating the average of P and S. • Select exponential or moving averaging. Exponential average Select an attenuation constant from 2 through 64. Moving average Select the number of averages from 8 through 64. • Harmonic measurement Only exponential averaging is available.
Data update rate	Select 50 ms, 100 ms, 200 ms, 500 ms, 1 s, 2 s, 5 s, 10 s, or 20 s.
Response time	At maximum, twice the data update rate (only during numerical display)
Hold	Holds the data display.
Single	Executes a single measurement during measurement hold.
Zero level compensation/Null	Compensates the zero level. Null compensation range: ±10% of range Null can be set individually for each of the following input signals. • Voltage and current of each input element • Rotation speed and torque • AUX1 and AUX2

### Frequency Measurement

Item	Specification	
Number of measurement	Select up to three frequencies of the voltage or current input to the input elements for measurement. If the frequency option is installed, the frequencies of the voltages and currents being input to all input elements can be measured.	
Measurement method	Reciprocal method	
Measurement range	Data update rate	Measuring range
	50 ms	45 Hz ≤ f ≤ 1 MHz
100 ms	25 Hz ≤ f ≤ 1 MHz	
200 ms	12.5 Hz ≤ f ≤ 500 kHz	
500 ms	5 Hz ≤ f ≤ 200 kHz	
1 s	2.5 Hz ≤ f ≤ 100 kHz	
2 s	1.25 Hz ≤ f ≤ 50 kHz	
5 s	0.5 Hz ≤ f ≤ 20 kHz	
10 s	0.25 Hz ≤ f ≤ 10 kHz	
20 s	0.15 Hz ≤ f ≤ 5 kHz	
Accuracy	±0.06% of reading ±0.1 mHz When the input signal level is 30% or more of the measurement range (60% or more for crest factor 6). However: The input signal is 50% or more of the range. • The frequency is smaller or equal to 2 times of above lower frequency • 10 mA range setting of 5 A input element • 1 A range setting of 50 A input element The 100 Hz frequency filter is ON at 0.15 Hz to 100 Hz, and the 1 kHz frequency filter is ON at 100 Hz to 1 kHz.	
Display resolution	99999	
Min. frequency resolution	0.0001 Hz	
Frequency measurement filter	Select OFF, 100 Hz or 1 kHz	

### Integration

Item	Specification
Mode	Select a mode from Manual, Standard, Continuous (repeat), Real Time Control Standard, and Real Time Control Continuous (Repeat).



# Specifications

Integration timer	Integration can be stopped automatically using the timer setting. 0000h00m00s to 10000h00m00s
Count over	If the integration time reaches the maximum integration time (10000 hours), or if the integration value reaches max/min display integration value <sup>1)</sup> , the elapsed time and integration value is saved and the operation is stopped. *1: WP : ±999999 MWh q : ±999999 MAh WS : ±999999 MVAh WQ : ±999999 Mvarh
Accuracy	±(Normal measurement accuracy + 0.02% of reading)
Timer accuracy	±0.02% of reading

## Harmonic Measurement (Option)

Item	Specification
Measured source	All installed elements
Method	PLL synchronization method (without external sampling clock function)
Frequency range	Fundamental frequency of the PLL source is in the range of 0.5 Hz to 2.6 kHz.
PLL source	<ul style="list-style-type: none"> <li>Select the voltage or current of each input element or the external clock.</li> <li>If the /G6 option is selected, two PLL sources can be selected, and dual harmonic measurement can be performed. If the /G5 option is selected, one PLL source is selectable.</li> <li>Input level <ul style="list-style-type: none"> <li>15 V or more of range for voltage input.</li> <li>50 mA or more of range for direct current input.</li> <li>200 mV or more of range for external current sensor input.</li> <li>50% or more of the measurement range rating for crest factor 3.</li> <li>100% or more of the measurement range rating for crest factor 6.</li> <li>20 Hz to 1 kHz for the 1 A or 2 A range of the 50 A input element.</li> </ul> </li> <li>The frequency filter ON condition is the same as with frequency measurement.</li> </ul>
FFT data length	1024 when the data update rate is 50 ms, 100 ms, or 200 ms 8192 when the data update rate is 500 m, 1 s, 2 s, 5 s, 10 s, or 20 s
Window function	Rectangular
Anti-aliasing filter	Set using a line filter

Sample rate, window width, and upper limit of the measured order

1024 FFT points (data update rate 50 ms, 100 ms, 200 ms)			
Fundamental frequency	Sampling rate	Window width	Upper limit of measured order
15 Hz to 600 Hz	f*1024	1	500th order
600 Hz to 1200 Hz	f*512	2	255th order
1200 Hz to 2600 Hz	f*256	4	100th order

However, the maximum measured order is 100 at a data update rate of 50 ms.

8192 FFT points (data update rate 500 m, 1 s, 2 s, 5 s, 10 s, 20 s)			
Fundamental frequency	Sampling rate	Window width	Upper limit of measured order
0.5 Hz to 1.5 Hz	f*8192	1	500th order
1.5 Hz to 5 Hz	f*4096	2	500th order
5 Hz to 10 Hz	f*2048	4	500th order
10 Hz to 600 Hz	f*1024	8	500th order
600 Hz to 1200 Hz	f*512	16	255th order
1200 Hz to 2600 Hz	f*256	32	100th order

Item	Specification
Accuracy	Add the following accuracy to the normal measurement accuracy.
When the line filter is OFF	
Frequency	Voltage
0.5 Hz ≤ f < 10 Hz	0.05% of reading + 0.25% of range
10 Hz ≤ f < 45 Hz	0.05% of reading + 0.25% of range
45 Hz ≤ f ≤ 66 Hz	0.05% of reading + 0.25% of range
66 Hz < f ≤ 440 Hz	0.05% of reading + 0.25% of range
440 Hz < f ≤ 1 kHz	0.05% of reading + 0.25% of range
1 kHz < f ≤ 10 kHz	0.5% of reading + 0.25% of range
10 kHz < f ≤ 100 kHz	0.5% of range
100 kHz < f ≤ 260 kHz	1% of range
Current	0.05% of reading + 0.25% of range
Power	0.1% of reading + 0.5% of range

• When the line filter is ON  
Add the accuracy of the line filter to the accuracy of when the line filter is OFF

All the items below apply to any of the tables.

- When the crest factor is set to 3
- When λ (power factor) = 1
- Power figures that exceed 2.6 kHz are reference values.
- For the voltage range, add the following values.  
Voltage accuracy: 25 mV  
Power accuracy: (25 mV/voltage range rating) × 100% of range
- For the direct current input range, add the following values.  
5 A element  
Current accuracy: 50 μA  
Power accuracy: (50 μA/current range rating) × 100% of range  
50 A element  
Current accuracy: 4 mA  
Power accuracy: (4 mA/current range rating) × 100% of range
- For the external current sensor range, add the following values.  
Current accuracy: 2 mV  
Power accuracy: (2 mV/external current sensor range rating) × 100% of range
- Add (n/500)% of reading to the n-th component of the voltage and current, and add (n/250)% of reading to the n-th component of the power.
- Accuracy when the crest factor is 6: Same as when the range is doubled for crest factor 3
- The guaranteed accuracy range by frequency and voltage/current is the same as the guaranteed range of normal measurement.
- The adjacent orders of the input order may be affected by the side rope.
- For n-th order component input when the PLL source frequency is 2 Hz or more, add ((n/(m+1))/50)% of (the n-th order reading) to the (n+m)th order and (n-m)th order of the voltage and current, and add ((n/(m+1))/25)% of (the n-th order reading) to the (n+m)th order and (n-m)th order of the power.
- For n-th order component input when the PLL source frequency is less than 2 Hz, add ((n/(m+1))/20)% of (the n-th order reading) to the (n+m)th order and (n-m)th order of the voltage and current, and add ((n/(m+1))/10)% of (the n-th order reading) to the (n+m)th order and (n-m)th order of the power.

## Motor Evaluation Function (Option)

Item	Specification
Input terminal	Torque, speed (A, B, Z)
Input resistance	Approximately 1 M
Input connector type	Insulated BNC

## Analog Input (Speed is input to the A terminal)

Item	Specification
Range	1 V, 2 V, 5 V, 10 V, 20 V
Input range	±110%
Line filter	OFF, 100, 1 kHz
Continuous maximum allowable input	±22 V
Maximum common mode voltage	±42 Vpeak
Sampling rate	Approximately 200 kS/s
Resolution	16-bit
Accuracy	±(0.05% of reading + 0.05% of range)
Temperature coefficient	±0.03% of range/°C

## Pulse Input

Speed is input to the A terminal if the direction is not detected. If the direction is detected, the A and B phases of the rotary encoder are input to the A and B terminals. The Z phase is input to the Z terminal of the rotary encoder for electric angle measurement.

Item	Specification
Input range	±12 Vpeak
Frequency measurement range	2 Hz to 1 MHz
Maximum common mode voltage	±42 Vpeak
Accuracy	±(0.05 + f/500)% of reading ±1 mHz
Rise of the Z terminal input and electric angle measurement start time	Within 500 ns
Detection level	H level: Approximately 2 V or more L level: Approximately 0.8 V or less
Pulse width	500 ns or more
Harmonic measurement option (/G5 or /G6) is required for electric angle measurement.	

## Auxiliary Input (Option)

Item	Specification
Input terminal	AUX1/AUX2
Input type	Analog
Input resistance	Approximately 1 M
Input connector type	Insulated BNC
Range	50 m, 100 m, 200 m, 500 m, 1 V, 2 V, 5 V, 10 V, 20 V
Input range	±110%
Line filter	OFF/100 Hz/1 kHz
Continuous maximum allowable input	±22 V
Common mode voltage	±42 V
Sampling rate	Approximately 200 kS/s
Resolution	16-bit
Accuracy	±(0.05% of reading + 0.05% of range) • Add 20 μV/°C to the change in temperature after zero level compensation or range change.
Temperature coefficient	±0.03% of range/°C

## DA Output and Remote Control (Option)

### DA Output

Item	Specification
D/A conversion resolution	16-bit
Output voltage	±5 V FS (max. approximately ±7.5 V) relative to each rated value
Update rate	Same as the data update rate
Output	20 channels (Output parameter can be set for each channel)
Accuracy	± (Accuracy of each measurement function + 0.1% of FS) FS=5 V
Minimum load	100 k
Temperature coefficient	±0.05% of FS/°C
Continuous maximum common mode voltage	±42 Vpeak or less

### Remote Control

Item	Specification
Signal	EXT START, EXT STOP, EXT RESET, INTEG BUSY, EXT HOLD, EXT SINGLE, EXT PRINT
Input level	0 to 5 V

## Calculation and Event Function

Item	Specification
User-defined function	Compute the numerical data (up to 20 equations) with a combination of measurement function symbols and operators.
Efficiency calculation	Up to 4 efficiencies can be displayed by setting measurement parameters for the efficiency equations.
User-defined event	Event: Set conditions for measured values. The functions triggered by the event are Auto Print, Store, and DA Output.

## High Speed Data Capturing Function (Option)

Item	Specification
Cycle of data capture	5ms (When External Sync OFF) 1ms to 100ms (When External Sync ON, If synchronized with external signal from MEAS START terminal)
Data update rate	1sec (It displays the last numeric data during the 1 sec period)
Meas. parameter	Voltage, Current, Power for each element and Sigma* Torque and speed /Pm (/MTR), AUX1 and AUX2 /AUX * select voltage/current measurement mode from DC /RMS /MEAN /R-MEAN
Wiring	Single phase 2 wire (DC signal), Three phase 3 wire (3V3A), Three phase 4 wire
Line Filter	Always ON (Cut off frequency is 300kHz and lower)
Data output	Internal RAM (approx. 30MB), external USB storage PC through GP-IB, Ethernet of USB communication I/F (Every 1 sec data block continuously)

Data measured time	1 to 10000000, or infinite
Data capturing start	Turn on STAT key of HS Setting menu Satisfy trigger conditions after received I/F command
Trigger	Mode: AUTO/NORMAL/OFF, Source: U1 to U6/I1 to I6/EXT, Slope: Rising edge/Falling Edge/both edges, Level: +/- 100.0%
HS filter	OFF, ON (Cut off: 1Hz to 1000Hz, 1Hz unit setting)

## Display

### Numerical Display

Item	Specification
Display digit (display resolution)	less than 60000: 5 digits 60000 or more: 4 digits
Number of display items	Select 4, 8, 16, Matrix, ALL, Harmonic Single List, Harmonic Dual List, and Custom

### Waveform Display

Item	Specification
Display format	Peak-to-peak compression data If the time axis is set so that there will be insufficient sampling data, the part lacking data is filled with the preceding sampling data.
Sampling rate	Approximately 2 MS/s
Time axis	Range from 0.05 ms to 2 s/div. However, 1/10 or less of the data update rate.
Trigger	<ul style="list-style-type: none"> <li>Trigger type: Edge type</li> <li>Trigger mode: Select OFF, Auto, and Normal. Automatically turned OFF during integration.</li> <li>Trigger source: Select voltage or current input to the input element or external clock</li> <li>Trigger slope: Select Rise, Fall, or Rise/Fall</li> <li>Trigger Level: Set the trigger level in the range of ±100% from the center of the screen (from top to bottom of the screen) if the trigger source is the voltage or current input to the input element. The set resolution is 0.1%.</li> </ul>
Time axis zoom function	Not available

\* Waveforms can be represented faithfully all up to approximately 100 kHz because the sampling rate is approximately 2 MS/s.

## Data Store Function

Item	Specification		
Store	Store numerical data in media. (Media: USB storage device, max. 1 GB)		
Store interval	50 ms (when waveform display is OFF) to 99 hours 59 minutes 59 seconds		
Storage time when using 1 GB memory (Numerical Store and Waveform Display OFF)			
Number of measurement channels	Number of measurement items (each channel)	Storage interval	Storable time (Approx.)
3 ch	5	50 ms	5 days
3 ch	20	50 ms	56 hours
3 ch	Each harmonic component data of DC to the 100th order of voltage, current, and power	50 ms	4 hours
6 ch	5	1 sec	86 days
6 ch	20	1 sec	24 days
6 ch	Each harmonic component data of DC to the 100th order of voltage, current, and power	1 sec	40 hours
6 ch	Each harmonic component data of DC to the 100th order of voltage, current, and power	100 ms	49 minutes

\*One piece of data is 4 bytes, and the limit to the number of store operations is 9999999 counts.

## File Function

Item	Specification
Save	Save setting information, waveform display data, numerical data, and screen image data to media
Read	Read the saved setting information from media.

## Auxiliary I/O

### I/O Section for Master/Slave Synchronization Signals

Item	Specification
Connector type	BNC connector: Applicable to both master and slave
I/O level	TTL: Applicable to both master and slave
Measurement start delay time	Within 15 sample intervals: Applicable to master Within 1 μs + 15 sample intervals: Applicable to slave

### External Clock Input

Item	Specification
Common	
Connector type	BNC connector
Input level	TTL

### When a synchronization source for normal measurement is used as the external clock for input

Item	Specification
Frequency range	Same as the measurement range of frequency measurement.
Input waveform	Square waveform with a duty ratio of 50%

### When a PLL source for harmonic measurement is used as the external clock for input

Item	Specification
Frequency range	Harmonic measurement (/G5 or /G6) option: 0.5 Hz to 2.6 kHz
Input waveform	Square waveform with a duty ratio of 50%

Item	Specification
Trigger	
Minimum pulse width	1 μs
Trigger delay time	Within (1 μs + 15 sample intervals)

## RGB Output (Option)

Item	Specification
Connector type	D-sub 15-pin (receptacle)
Output format	Analog RGB output

## Computer Interface

### GP-IB Interface

Item	Specification
Compatible devices	National Instruments <ul style="list-style-type: none"> <li>PCI-GPIB or PCI-GPIB+</li> <li>PCle-GPIB or PCle-GPIB+</li> <li>PCMClA-GPIB and PCMClA-GPIB+</li> <li>GPIB-USB-HS</li> </ul>
Electrical and mechanical specifications	Use an NI-488.2M Version 1.60 or later driver

Conforms to the IEE Standard 488-1978 (JIS C 1901-1987)

Functional specifications	SH1, AH1, T6, L4, SR1, RL1, PPO, DC1, DT1, CO
Protocol	Conforms to the IEEE Standard 488.2-1992
Encoding	SO (ASCII)
Mode	Addressable mode
Address	0 to 30
Clearing remote mode	Remote mode can be cleared by pressing the LOCAL key (except during Local Lockout)

### Ethernet Interface

Item	Specification
Number of communication ports	1
Connector type	RJ-45 connector
Electrical and mechanical specifications	Conforms to the IEEE802.3
Transmission method	Ethernet 1000BASE-T, 100BASE-TX, 10BASE-T
Communication protocol	TCP/IP
Applicable services	FTP server, DHCP, DNS, remote control (VXI-11), SNMP, FTP client

### USB PC Interface

Item	Specification
Number of ports	1
Connector	Type B connector (receptacle)
Electrical and mechanical specifications	Conforms to the USB Rev. 2.0
Applicable transfer standards	HS (High Speed) mode (480 Mbps), FS (Full Speed) mode (12 Mbps)
Applicable protocols	USBTCM-USB488 (USB Test and Measurement Class Ver.1.0)
Applicable system environment	The PC must run the Japanese or English version of Windows 7 (32-bit), Vista (32-bit), or XP (SP2 or later, 32-bit), and be equipped with a USB port.

## USB for Peripheral Devices

Item	Specification
Number of ports	2
Connector type	USB type A connector (receptacle)
Electrical and mechanical specifications	Conforms to USB Revision 2.0
Applicable transfer standards	HS (High Speed) mode (480 Mbps), FS (Full Speed) mode (12 Mbps), LS (Low Speed) mode (1.5 Mbps)
Applicable devices	Mass storage device conforming to USB Mass Storage Class Version 1.1 109 and 104 keyboards conforming to USB HID Class Version 1.1 Mouse conforming to USB HID Class Version 1.1
Power supply	5 V, 500 mA (for each port). However, devices that exceed the maximum current consumption of 100 mA cannot be connected to two ports simultaneously.

## Built-in Printer (Option)

Item	Specification
Printing method	Thermal line dot method
Dot density	8 dots/mm
Paper width	80 mm
Effective recording width	72 mm
Auto Print	Allows you to set the interval time for printing to automatically print the measured values. The start/stop time can also be set.

## General Specifications

Item	Specification
Warm-up time	Approximately 30 minutes
Operation environment	Temperature: 5 to 40°C Humidity: 20 to 80%RH (no condensation)
Operating altitude	2000 m or less
Installation location	Indoors
Storage environment	Temperature: -25 to 60°C Humidity: 20 to 80%RH (no condensation)
Rated power supply voltage	100 to 240 VAC
Allowable power supply voltage fluctuation range	90 to 264 VAC
Rated power supply frequency	50/60 Hz
Allowable power supply frequency fluctuation range	48 to 63 Hz
Maximum power consumption	150 VA (when using a built-in printer)
Dimensions (see section 12.13)	Approximately 426 mm (W) × 177 mm (H) × 459 mm (D) (Excluding the handle and other projections when the printer is stored in the cover)
Weight	Approximately 15 kg (including the main body, 6 input elements, and options)
Battery backup	Setting information and built-in clock continue to operate with a lithium backup battery.



## Typical Voltage/Current Connections

### Measurement using current sensor

#### Connection example

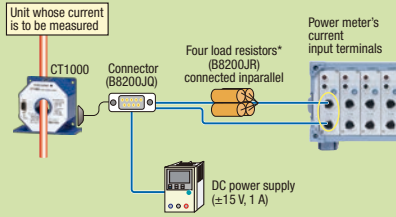

\* A burden resistor is required for the CT1000, CT200, CT60, and 751574.

### Measurement using clamp-on probe

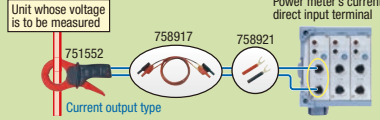

### Current measurement using direct input terminal

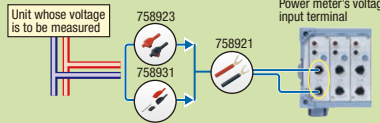

### Measurement using voltage input terminal

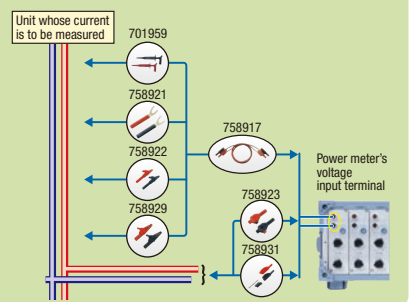

## Model and Suffix Codes

Model	Suffix codes	Description
WT1801	-01	WT1800 Single input element
		50 A
	-10	5 A
WT1802		WT1800 2 input elements
	-02	50 A 50 A
	-11	5 A 50 A
	-20	5 A 5 A
WT1803		WT1800 3 input elements
	-03	50 A 50 A 50 A
	-12	5 A 50 A 50 A
	-21	5 A 5 A 50 A
	-30	5 A 5 A 5 A
WT1804		WT1800 4 input elements
	-04	50 A 50 A 50 A 50 A
	-13	5 A 50 A 50 A 50 A
	-22	5 A 5 A 50 A 50 A
	-31	5 A 5 A 5 A 50 A
	-40	5 A 5 A 5 A 5 A
WT1805		WT1800 5 input elements
	-05	50 A 50 A 50 A 50 A 50 A
	-14	5 A 50 A 50 A 50 A 50 A
	-23	5 A 5 A 50 A 50 A 50 A
	-32	5 A 5 A 5 A 50 A 50 A
	-41	5 A 5 A 5 A 5 A 50 A
WT1806		WT1800 6 input elements
	-06	50 A 50 A 50 A 50 A 50 A 50 A
	-15	5 A 50 A 50 A 50 A 50 A 50 A
	-24	5 A 5 A 50 A 50 A 50 A 50 A
	-33	5 A 5 A 5 A 50 A 50 A 50 A
	-42	5 A 5 A 5 A 5 A 50 A 50 A
	-51	5 A 5 A 5 A 5 A 5 A 50 A
-60	5 A 5 A 5 A 5 A 5 A 5 A	
Power cord	-D	UL/CSA standard
	-F	VDE standard
	-R	AS standard
	-Q	BS standard
	-H	GB standard
	Languages	-HE
-HG		German menu
-HC		Chinese menu
Options		Standard option
	/EX1	External current sensor input for WT1801
	/EX2	External current sensor input for WT1802
	/EX3	External current sensor input for WT1803
	/EX4	External current sensor input for WT1804
	/EX5	External current sensor input for WT1805
	/EX6	External current sensor input for WT1806
	/B5	Built-in printer
	/G5	Harmonic Measurement
	/G6	Simultaneous Dual Harmonic Measurement
	/DT	Delta Computation
/FQ	Add-on Frequency Measurement	
/V1	RGB output	
/DA	20-channel DA Outputs	
/MTR	Motor Evaluation Function	
/AUX	Auxiliary Sensor Inputs	
/HS	High speed data capturing	

\* The numbers in the "Description" column have the following meanings.

50 A: 50 A input element, 5 A: 5 A input element  
Elements are inserted in the order shown starting on the left side on the back.

\* GPIB, Ethernet and USB communication come standard.

Note: Adding input elements after initial product delivery will require rework at the factory. Please choose your models and configurations carefully, and inquire with your sales representative if you have any questions

#### Standard accessories

Power cord, Rubber feet, current input protective cover, User's manual, expanded user's manual, communication interface user's manual, printer roll paper (provided only with /B5), connector (provided only with /DA) Safety terminal adapter 758931 (provided two adapters in a set times input element number)

User's manuals [Start guide (booklet), function /operation, communication manuals (electric file)]

## Accessory (sold separately)

Model/parts number	Product	Description	Order Qty
758917	Test read set	A set of 0.8 m long, red and black test leads	1
758922	Small alligator-clip	Rated at 300 V and used in a pair	1
758929	Large alligator-clip	Rated at 1000 V and used in a pair	1
758923	Safety terminal adapter	(spring-hold type) Two adapters to a set	1
758931	Safety terminal adapter	(screw-fastened type) Two adapters to a set	1
758921	Fork terminal adapter	Banana-fork adapter, Two adapters to a set	1
701959	Safety mini-clip	Hook type, Two in a set	1
758924	Conversion adapter	BNC-banana-jack (female) adapter	1
366924	BNC-BNC cable	1 m	1
366925	BNC-BNC cable	2 m	1
B9284LK	External sensor cable	Current sensor input connector, Length 0.5 m	1
B9316FX	Printer roll paper	Thermal paper, 10 meters (1 roll)	10

▲ Due to the nature of this product, it is possible to touch its metal parts. Therefore, there is a risk of electric shock, so the product must be used with caution.

\* Use these products with low-voltage circuits (42 V or less).

## Rack Mount

Model	Product	Description
751535-E4	Rack mounting kit	For EIA
751535-J4	Rack mounting kit	For JIS

### CT1000 AC/DC Current sensor

Current: 1000 Apk  
Basic Accuracy:  
 $\pm(0.05\% \text{ of rdg} + 30 \mu\text{A})$   
Measurement Range:  
DC to 300 kHz  
Input/output ratio: 1500: 1



### 751574 Current transducer

Current: 600 Apk  
Basic Accuracy:  
 $\pm(0.05\% \text{ of rdg} + 40 \mu\text{A})$   
Measurement Range:  
DC to 100 kHz  
Input/output ratio: 1500: 1



### CT200 AC/DC Current sensor

Current: 200 Apk  
Basic Accuracy:  
 $\pm(0.05\% \text{ of rdg} + 30 \mu\text{A})$   
Measurement Range:  
DC to 500 kHz  
Input/output ratio: 1000: 1



### CT60 AC/DC Current sensor

Current: 60 Apk  
Basic Accuracy:  
 $\pm(0.05\% \text{ of rdg} + 30 \mu\text{A})$   
Measurement Range:  
DC to 800 kHz  
Input/output ratio: 600: 1



## Exterior WT1800

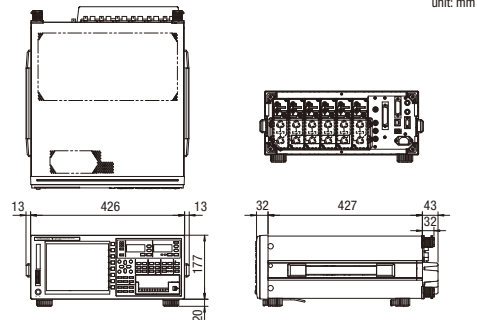

## Yokogawa's Approach to Preserving the Global Environment

- Yokogawa's electrical products are developed and produced in facilities that have received ISO14001 approval.
- In order to protect the global environment, Yokogawa's electrical products are designed in accordance with Yokogawa's Environmentally Friendly Product Design Guidelines and Product Design Assessment Criteria.

## NOTICE

- Before operating the product, read the user's manual thoroughly for proper and safe operation.
- If this product is for use with a system requiring safeguards that directly involve personnel safety, please contact the Yokogawa sales offices.

# YOKOGAWA

YOKOGAWA METERS & INSTRUMENTS CORPORATION

Global Sales Dept. /Phone: +81-42-534-1413 Facsimile: +81-42-534-1426

E-mail: tm@cs.jp.yokogawa.com

YOKOGAWA CORPORATION OF AMERICA Phone: (1)-770-253-7000, Fax: (1)-770-254-0928

YOKOGAWA EUROPE B.V. Phone: (31)-88-4641000, Fax: (31)-88-4641111

YOKOGAWA ENGINEERING ASIA PTE. LTD. Phone: (65)-62419933, Fax: (65)-62412606

Subject to change without notice.

[Ed : 02/b] Copyright ©2011

Printed in Japan, 108(KP)