



**Advanced Test Equipment Rentals**  
**www.atecorp.com 800-404-ATEC (2832)**



**ROHDE & SCHWARZ**

Test and Measurement  
Division

## **Operating Manual**

# **MICROWAVE SIGNAL GENERATOR**

## **R&S SMR20**

1104.0002.20

## **R&S SMR27**

1104.0002.27

## **R&S SMR30**

1104.0002.30

## **R&S SMR40**

1104.0002.40

Printed in the Federal  
Republic of Germany



## **Tabbed Divider Overview**

### **Contents**

#### **Data Sheet**

**Safety Instructions**

**Certificate of Quality**

**EC Certificate of Conformity**

**List of R&S Representatives**

### **Short Tutorial About How to Use the Manual**

#### **Divider**

<b>1</b>	<b>Chapter 1</b>	<b>Preparation for Use</b>
<b>2</b>	<b>Chapter 2</b>	<b>Introduction to Operation</b>
<b>3</b>	<b>Chapter 3</b>	<b>Manual Operation</b>
<b>4</b>	<b>Chapter 4</b>	<b>Functions</b>
<b>5</b>	<b>Chapter 5</b>	<b>Remote Control – Basics</b>
<b>6</b>	<b>Chapter 6</b>	<b>Remote Control – Commands</b>
<b>7</b>	<b>Chapter 7</b>	<b>Remote Control – Programming Examples</b>
<b>8</b>	<b>Chapter 8</b>	<b>Maintenance</b>
<b>9</b>	<b>Chapter 9</b>	<b>Error Messages</b>
<b>10</b>	<b>Chapter 10</b>	<b>Index</b>



# Contents

<b>1 Putting into Operation.....</b>	<b>1.1</b>
<b>General Instructions .....</b>	<b>1.1</b>
Unpacking the Instrument.....	1.1
<b>Supply Voltage .....</b>	<b>1.1</b>
<b>How to Ensure EMC.....</b>	<b>1.1</b>
<b>Power Fuses .....</b>	<b>1.2</b>
<b>Switching On/Off the Instrument.....</b>	<b>1.2</b>
Initial Status .....	1.2
<b>RAM With Battery Back-Up .....</b>	<b>1.2</b>
<b>Preset Setting .....</b>	<b>1.3</b>
<b>Functional Test .....</b>	<b>1.3</b>
<b>Mounting into a 19" Rack.....</b>	<b>1.3</b>
<b>Explanation of Front and Rear Panel.....</b>	<b>1.4</b>
Elements of the Front Panel .....	1.4
Elements of the Rear Panel.....	1.9
<b>2 Short Tutorial .....</b>	<b>2.1</b>
<b>Sample Setting for First Users .....</b>	<b>2.1</b>
<b>3 Manual Operation .....</b>	<b>3.1</b>
<b>Design of the Display .....</b>	<b>3.1</b>
<b>Basic Operating Steps.....</b>	<b>3.2</b>
Calling the menus .....	3.2
Selection and Change of Parameters.....	3.3
Quick Selection of Menu (QUICK SELECT).....	3.4
Use of [FREQ] and [LEVEL] Keys .....	3.5
Use of [RF ON/OFF] and [MOD ON/OFF].....	3.5
Changing Unit of Level .....	3.5
Correction of Input .....	3.6
<b>List Editor .....</b>	<b>3.7</b>
Select List .....	3.8
Delete List.....	3.8
Edit List .....	3.9
<b>SAVE/RECALL – Storing/Calling of Instrument Settings.....</b>	<b>3.14</b>
<b>Menu Summary .....</b>	<b>3.15</b>

<b>4 Instrument Functions</b> .....	<b>4.1</b>
<b>RF Frequency</b> .....	<b>4.1</b>
Frequency Offset and Multiplier.....	4.2
<b>RF Level</b> .....	<b>4.3</b>
Level Offset.....	4.5
Non-Interrupting Level Setting.....	4.5
Switching On/Off Automatic Level Control (Alc).....	4.6
User Correction (Ucor).....	4.8
[RF ON/OFF] Key.....	4.9
<b>Modulation - General</b> .....	<b>4.10</b>
Modulation Sources.....	4.10
Simultaneous Modulation.....	4.11
Mutual Switch-Off of Modulation Types.....	4.11
[MOD ON/OFF] Key.....	4.12
<b>Analog Modulation</b> .....	<b>4.13</b>
Amplitude Modulation.....	4.13
Frequency Modulation.....	4.14
Pulse Modulation.....	4.15
Pulse Generator.....	4.16
LF Generator.....	4.18
<b>Digital Modulations ASK and FSK</b> .....	<b>4.19</b>
<b>LF Output</b> .....	<b>4.21</b>
<b>IF Input</b> .....	<b>4.22</b>
<b>PULSE/VIDEO Output</b> .....	<b>4.23</b>
<b>Sweep</b> .....	<b>4.25</b>
Setting the Sweep Range (Start Freq, Stop Freq, Center Freq, Span).....	4.25
Selecting Linear/Logarithmic Sweep (Lin, Log Spacing).....	4.26
Operating Modes (Mode).....	4.26
Sweep Inputs.....	4.27
Sweep Outputs.....	4.27
RF Sweep.....	4.29
Level Sweep.....	4.31
LF Sweep.....	4.32
<b>List Mode</b> .....	<b>4.34</b>
Operating Modes (Mode).....	4.34
Inputs/Outputs.....	4.35
<b>Memory Sequence</b> .....	<b>4.38</b>
Operating Modes (Mode).....	4.38
External Trigger.....	4.39
<b>Utilities</b> .....	<b>4.42</b>
Display.....	4.42
System.....	4.42
IEC/IEEE-Bus Address (System - GPIB).....	4.43
Parameters of RS-232-C Interface (System - RS232).....	4.44
Suppression of Indications and Clearing of Memories (System - Security).....	4.45
Indication of IEC/IEEE-Bus Language (System - Language).....	4.45

Internal/External Reference Frequency (RefOsc) .....	4.46
Passwords for Accessing Protected Functions (Protect) .....	4.47
Calibration (Calib) .....	4.48
Display of Module Versions (Diag - Config).....	4.49
Display of Voltages of Test Points (Diag-TPoint) .....	4.50
Display of Service Data (Diag-Param).....	4.51
Test .....	4.52
Assigning Modulations to the [MOD ON/OFF] Key (ModKey) .....	4.53
Setting the Auxiliary Inputs/Outputs (AUX-I/O).....	4.54
Setup (Setup).....	4.55
<b>Help System .....</b>	<b>4.56</b>
<b>Status .....</b>	<b>4.56</b>
<b>5 Remote Control – Basic Information .....</b>	<b>5.1</b>
<b>Brief Instructions .....</b>	<b>5.1</b>
IEC/IEEE Bus .....	5.1
RS-232-C Interface.....	5.2
<b>Switchover to Remote Control .....</b>	<b>5.3</b>
Remote Control via IEC/IEEE Bus.....	5.3
Setting the Device Address.....	5.3
Indications during Remote Control .....	5.3
Return to Manual Operation.....	5.4
Remote Control via RS-232-C Interface.....	5.4
Setting the Transmission Parameters .....	5.4
Indications during Remote Control .....	5.4
Return to Manual Operation.....	5.4
<b>Messages.....</b>	<b>5.5</b>
Interface Messages .....	5.5
Device Messages (Commands and Device Responses) .....	5.5
<b>Structure and Syntax of Device Messages .....</b>	<b>5.6</b>
Introduction to SCPI.....	5.6
Structure of Commands .....	5.6
Structure of Command Lines.....	5.9
Responses to Queries .....	5.9
Parameters .....	5.10
Overview of Syntax Elements.....	5.12
<b>Instrument Model and Command Processing .....</b>	<b>5.13</b>
Input Unit .....	5.13
Command Recognition .....	5.14
Data Set and Instrument Hardware .....	5.14
Status Reporting System .....	5.14
Output Unit.....	5.15
Command Sequence and Command Synchronization.....	5.15
<b>Status Reporting System .....</b>	<b>5.16</b>
Structure of an SCPI Status Register .....	5.16
Overview of Status Registers .....	5.18

Description of Status Registers .....	5.19
Status Byte (STB) and Service Request Enable Register (SRE) .....	5.19
IST Flag and Parallel Poll Enable Register (PPE) .....	5.20
Event Status Register (ESR) and Event Status Enable Register (ESE).....	5.20
STATus:OPERation-Register .....	5.21
STATus:QUEStionable Register.....	5.21
Use of Status Reporting System .....	5.22
Service Request, Making Use of Hierarchy Structure .....	5.22
Serial Poll .....	5.22
Parallel Poll .....	5.23
Query by Means of Commands .....	5.23
Error Queue Query .....	5.23
Reset Values of Status Reporting System .....	5.24
<b>Interfaces .....</b>	<b>5.25</b>
IEC/IEEE-Bus Interface .....	5.25
Characteristics of Interface.....	5.25
Bus Lines .....	5.25
Interface Functions .....	5.26
Interface Messages .....	5.27
RS-232-C Interface.....	5.28
Characteristics of Interface.....	5.28
Signal Lines .....	5.28
Transmission Parameters.....	5.29
Interface Functions .....	5.29
Handshake.....	5.30
<b>6 Remote Control – Description of Commands .....</b>	<b>6.1</b>
<b>Notation .....</b>	<b>6.1</b>
<b>Common Commands.....</b>	<b>6.3</b>
<b>ABORt-System .....</b>	<b>6.6</b>
<b>DIAGnostic-System.....</b>	<b>6.7</b>
<b>DISPLAY-System.....</b>	<b>6.9</b>
<b>INPut-System.....</b>	<b>6.10</b>
<b>MEMory-System.....</b>	<b>6.10</b>
<b>OUTPut-System.....</b>	<b>6.11</b>
<b>SOURce System.....</b>	<b>6.13</b>
SOURce:AM Subsystem .....	6.13
SOURce:CORRection Subsystem .....	6.15
SOURce:DM Subsystem .....	6.17
SOURce:FM Subsystem .....	6.19
SOURce:FREQUency Subsystem .....	6.21
SOURce:LIST Subsystem .....	6.24
SOURce:MARKer Subsystem .....	6.27
SOURce:POWer Subsystem.....	6.29
SOURce:PULM Subsystem.....	6.32
SOURce:PULSe Subsystem .....	6.33
SOURce:ROSCillator Subsystem.....	6.34
SOURce:SWEEp Subsystem .....	6.35



<b>SOURce2 System</b> .....	<b>6.38</b>
SOURce2:FREQuency Subsystem .....	6.38
SOURce2:FUNcTION Subsystem .....	6.40
SOURce2:MARKer Subsystem .....	6.41
SOURce2:SWEEp Subsystem .....	6.42
<b>STATus-System</b> .....	<b>6.44</b>
<b>SYSTEM System</b> .....	<b>6.46</b>
<b>TEST System</b> .....	<b>6.51</b>
<b>TRIGger System</b> .....	<b>6.52</b>
<b>List of Commands</b> .....	<b>6.56</b>
<b>7 Remote Control - Programming Examples</b> .....	<b>7.1</b>
<b>Including IEC-Bus Library for QuickBasic</b> .....	<b>7.1</b>
<b>Initialization and Default Status</b> .....	<b>7.1</b>
Initiate Controller.....	7.1
Initiate Instrument.....	7.1
<b>Transmission of Instrument Setting Commands</b> .....	<b>7.2</b>
<b>Switchover to Manual Control</b> .....	<b>7.2</b>
<b>Reading out Instrument Settings</b> .....	<b>7.2</b>
<b>List Management</b> .....	<b>7.3</b>
<b>Command synchronization</b> .....	<b>7.3</b>
<b>Service Request</b> .....	<b>7.4</b>
<b>Operating the Generator in the IEC-Bus Controller Mode</b> .....	<b>7.6</b>
<b>8 Maintenance</b> .....	<b>8.1</b>
<b>Cleaning the Outside</b> .....	<b>8.1</b>
<b>Storing and Packing</b> .....	<b>8.1</b>
<b>9 Error Messages</b> .....	<b>9.1</b>
<b>List of Error Messages</b> .....	<b>9.2</b>
SCPI-Specific Error Messages .....	9.2
SMR-Specific Error Messages .....	9.6
<b>10 Index</b> .....	<b>10.1</b>

**Tables**

Table 4-1	Input connectors for external modulation .....	4.10
Table 4-2	Status messages for deviation from nominal at external modulation inputs .....	4.11
Table 4-3	Modulation types which cannot be active simultaneously .....	4.12
Table 4-4	List mode, typical list .....	4.34
Table 4-5	Memory sequence; example of list.....	4.38
Table 5-1	Synchronization by means of *OPC, *OPC? and *WAI.....	5.15
Table 5-2	Meaning of the bits used in the status byte .....	5.19
Table 5-3	Meaning of the bits used in the event status register .....	5.20
Table 5-4	Resetting of instrument functions .....	5.24
Table 5-5	Interface functions .....	5.26
Table 5-6	Universal commands.....	5.27
Table 5-7	Addressed commands .....	5.27
Table 5-8	Control characters for RS-232-C interface.....	5.29
Table 6-1	Common Commands .....	6.3
Table 6-2	Device Response to *OPT? .....	6.4

## Figures

Fig. 1-1	Front panel view .....	1.4
Fig. 1-2	Rear panel view.....	1.9
Fig. 2-1	Display for AM setting.....	2.3
Fig. 2-2	Display for pattern setting.....	2.5
Fig. 3-1	Design of the display .....	3.1
Fig. 3-2	Modulation - AM Menu .....	3.2
Fig. 3-3	List menu.....	3.7
Fig. 3-4	Select List window .....	3.8
Fig. 3-5	Delete List window.....	3.8
Fig. 3-6	Edit function Insert.....	3.10
Fig. 3-7	Fill editing function.....	3.11
Fig. 3-8	Edit editing function .....	3.12
Fig. 3-9	Delete editing function .....	3.13
Fig. 4-1	Frequency menu (preset setting) .....	4.1
Fig. 4-2	Typical setups with frequency offset and frequency multiplier .....	4.2
Fig. 4-3	Level menu, with option SMR-B15, attenuator 20 GHz.....	4.3
Fig. 4-4	Typical setup with level offset.....	4.5
Fig. 4-5	Basic principle of level control of SMR .....	4.6
Fig. 4-6	Example of external level control with power meter .....	4.6
Fig. 4-7	Level - Alc menu (preset setting).....	4.7
Fig. 4-8	Level - Ucor menu .....	4.8
Fig. 4-9	Ucor - Level menu .....	4.9
Fig. 4-10	Modulation - AM menu (preset setting) .....	4.13
Fig. 4-11	Modulation - FM menu (preset setting) .....	4.14
Fig. 4-12	Modulation - Pulse menu (preset setting).....	4.15
Fig. 4-13	Signal example 1: single pulse, Pulse mode = Auto Trig .....	4.17
Fig. 4-14	Signal example 2: double pulse, Pulse mode = Ext Trig, Slope = Pos .....	4.17
Fig. 4-15	Signal example 3: single pulse, Pulse Mode = Ext Gated.....	4.17
Fig. 4-16	Digital Mod - Ask menu (preset setting) .....	4.19
Fig. 4-17	Digital Mod - Fsk menu (preset setting) .....	4.20
Fig. 4-18	LfOutput menu (preset setting) .....	4.21
Fig. 4-19	IFInput menu (preset setting) .....	4.22
Fig. 4-20	PulseOutput menu.....	4.23
Fig. 4-21	Example of sweep signal.....	4.28
Fig. 4-22	Example of sweep signal.....	4.29
Fig. 4-23	Sweep - Freq menu.....	4.29
Fig. 4-24	Sweep - Level menu.....	4.31
Fig. 4-25	Sweep - Lfgen menu .....	4.32

Fig. 4-26	Example of signal in list mode: Mode = Ext Step .....	4.35
Fig. 4-27	List menu .....	4.36
Fig. 4-28	List menu – selection window .....	4.37
Fig. 4-29	MemSeq menu (preset setting) .....	4.40
Fig. 4-30	MemSeq menu – selection window .....	4.41
Fig. 4-31	Utilities menu .....	4.42
Fig. 4-32	Utilities - Display menu .....	4.42
Fig. 4-33	Utilities - System menu .....	4.42
Fig. 4-34	Utilities - System - GPIB - Address menu .....	4.43
Fig. 4-35	Utilities - System - RS232 menu .....	4.44
Fig. 4-36	Utilities - System - Security menu .....	4.45
Fig. 4-37	Utilities - RefOsc menu (preset setting) .....	4.46
Fig. 4-38	Utilities - Protect menu (preset setting) .....	4.47
Fig. 4-39	Utilities - Calib menu (preset setting) .....	4.48
Fig. 4-40	Utilities - Diag - Config menu .....	4.49
Fig. 4-41	Utilities – Diag – TPoint menu .....	4.50
Fig. 4-42	Utilities - Diag - Param menu .....	4.51
Fig. 4-43	Menu Utilities - Test .....	4.52
Fig. 4-44	Utilities - ModKey menu (preset setting) .....	4.53
Fig. 4-45	Utilities - AuxIO menu .....	4.54
Fig. 4-46	Utilities - Setup menu .....	4.55
Fig. 4-47	STATUS menu .....	4.56
Fig. 5-1	Tree structure of SCPI command systems .....	5.7
Fig. 5-2	Device model for remote control via the IEC/IEEE bus .....	5.13
Fig. 5-3	Status register model .....	5.16
Fig. 5-4	Overview of status registers .....	5.18
Fig. 5-5	Pin assignment of IEC/IEEE-bus interface .....	5.25
Fig. 5-6	Pin assignment of RS-232-C interface .....	5.28
Fig. 5-7	Wiring of data, control and signalling lines for hardware handshake .....	5.30
Fig. 9-1	ERROR page .....	9.1



**Before putting the product into operation for the first time, make sure to read the following**



## **S a f e t y I n s t r u c t i o n s**

Rohde & Schwarz makes every effort to keep the safety standard of its products up to date and to offer its customers the highest possible degree of safety. Our products and the auxiliary equipment required for them are designed and tested in accordance with the relevant safety standards. Compliance with these standards is continuously monitored by our quality assurance system. This product has been designed and tested in accordance with the EC Certificate of Conformity and has left the manufacturer's plant in a condition fully complying with safety standards. To maintain this condition and to ensure safe operation, observe all instructions and warnings provided in this manual. If you have any questions regarding these safety instructions, Rohde & Schwarz will be happy to answer them.

Furthermore, it is your responsibility to use the product in an appropriate manner. This product is designed for use solely in industrial and laboratory environments or in the field and must not be used in any way that may cause personal injury or property damage. You are responsible if the product is used for an intention other than its designated purpose or in disregard of the manufacturer's instructions. The manufacturer shall assume no responsibility for such use of the product.

The product is used for its designated purpose if it is used in accordance with its operating manual and within its performance limits (see data sheet, documentation, the following safety instructions). Using the products requires technical skills and knowledge of English. It is therefore essential that the products be used exclusively by skilled and specialized staff or thoroughly trained personnel with the required skills. If personal safety gear is required for using Rohde & Schwarz products, this will be indicated at the appropriate place in the product documentation.

### **Symbols and safety labels**

Observe operating instructions	Weight indication for units >18 kg	Danger of electric shock	Warning! Hot surface	PE terminal	Ground	Ground terminal	Attention! Electrostatic sensitive devices

Supply voltage ON/OFF	Standby indication	Direct current (DC)	Alternating current (AC)	Direct/alternating current (DC/AC)	Device fully protected by double/reinforced insulation

## Safety Instructions

Observing the safety instructions will help prevent personal injury or damage of any kind caused by dangerous situations. Therefore, carefully read through and adhere to the following safety instructions before putting the product into operation. It is also absolutely essential to observe the additional safety instructions on personal safety that appear in other parts of the documentation. In these safety instructions, the word "product" refers to all merchandise sold and distributed by Rohde & Schwarz, including instruments, systems and all accessories.

### Tags and their meaning

DANGER	This tag indicates a safety hazard with a high potential of risk for the user that can result in death or serious injuries.
WARNING	This tag indicates a safety hazard with a medium potential of risk for the user that can result in death or serious injuries.
CAUTION	This tag indicates a safety hazard with a low potential of risk for the user that can result in slight or minor injuries.
ATTENTION	This tag indicates the possibility of incorrect use that can cause damage to the product.
NOTE	This tag indicates a situation where the user should pay special attention to operating the product but which does not lead to damage.

These tags are in accordance with the standard definition for civil applications in the European Economic Area. Definitions that deviate from the standard definition may also exist. It is therefore essential to make sure that the tags described here are always used only in connection with the associated documentation and the associated product. The use of tags in connection with unassociated products or unassociated documentation can result in misinterpretations and thus contribute to personal injury or material damage.

### Basic safety instructions

1. The product may be operated only under the operating conditions and in the positions specified by the manufacturer. Its ventilation must not be obstructed during operation. Unless otherwise specified, the following requirements apply to Rohde & Schwarz products:  
prescribed operating position is always with the housing floor facing down, IP protection 2X, pollution severity 2, overvoltage category 2, use only in enclosed spaces, max. operation altitude max. 2000 m. Unless specified otherwise in the data sheet, a tolerance of  $\pm 10\%$  shall apply to the nominal voltage and of  $\pm 5\%$  to the nominal frequency.
2. Applicable local or national safety regulations and rules for the prevention of accidents must be observed in all work performed. The product may be opened only by authorized, specially trained personnel. Prior to performing any work on the product or opening the product, the product must be disconnected from the supply network. Any adjustments, replacements of parts, maintenance or repair must be carried out only by technical personnel authorized by Rohde & Schwarz. Only original parts may be used for replacing parts relevant to safety (e.g. power switches, power transformers, fuses). A safety test must always be performed after parts relevant to safety have been replaced (visual inspection, PE conductor test, insulation resistance measurement, leakage current measurement, functional test).
3. As with all industrially manufactured goods, the use of substances that induce an allergic reaction (allergens, e.g. nickel) such as aluminum cannot be generally excluded. If you develop an allergic reaction (such as a skin rash, frequent sneezing, red eyes or respiratory difficulties), consult a physician immediately to determine the cause.

## Safety Instructions

4. If products/components are mechanically and/or thermally processed in a manner that goes beyond their intended use, hazardous substances (heavy-metal dust such as lead, beryllium, nickel) may be released. For this reason, the product may only be disassembled, e.g. for disposal purposes, by specially trained personnel. Improper disassembly may be hazardous to your health. National waste disposal regulations must be observed.
5. If handling the product yields hazardous substances or fuels that must be disposed of in a special way, e.g. coolants or engine oils that must be replenished regularly, the safety instructions of the manufacturer of the hazardous substances or fuels and the applicable regional waste disposal regulations must be observed. Also observe the relevant safety instructions in the product documentation.
6. Depending on the function, certain products such as RF radio equipment can produce an elevated level of electromagnetic radiation. Considering that unborn life requires increased protection, pregnant women should be protected by appropriate measures. Persons with pacemakers may also be endangered by electromagnetic radiation. The employer is required to assess workplaces where there is a special risk of exposure to radiation and, if necessary, take measures to avert the danger.
7. Operating the products requires special training and intense concentration. Make certain that persons who use the products are physically, mentally and emotionally fit enough to handle operating the products; otherwise injuries or material damage may occur. It is the responsibility of the employer to select suitable personnel for operating the products.
8. Prior to switching on the product, it must be ensured that the nominal voltage setting on the product matches the nominal voltage of the AC supply network. If a different voltage is to be set, the power fuse of the product may have to be changed accordingly.
9. In the case of products of safety class I with movable power cord and connector, operation is permitted only on sockets with earthing contact and protective earth connection.
10. Intentionally breaking the protective earth connection either in the feed line or in the product itself is not permitted. Doing so can result in the danger of an electric shock from the product. If extension cords or connector strips are implemented, they must be checked on a regular basis to ensure that they are safe to use.
11. If the product has no power switch for disconnection from the AC supply, the plug of the connecting cable is regarded as the disconnecting device. In such cases, it must be ensured that the power plug is easily reachable and accessible at all times (length of connecting cable approx. 2 m). Functional or electronic switches are not suitable for providing disconnection from the AC supply. If products without power switches are integrated in racks or systems, a disconnecting device must be provided at the system level.
12. Never use the product if the power cable is damaged. By taking appropriate safety measures and carefully laying the power cable, ensure that the cable cannot be damaged and that no one can be hurt by e.g. tripping over the cable or suffering an electric shock.
13. The product may be operated only from TN/TT supply networks fused with max. 16 A.
14. Do not insert the plug into sockets that are dusty or dirty. Insert the plug firmly and all the way into the socket. Otherwise this can result in sparks, fire and/or injuries.
15. Do not overload any sockets, extension cords or connector strips; doing so can cause fire or electric shocks.
16. For measurements in circuits with voltages  $V_{\text{rms}} > 30 \text{ V}$ , suitable measures (e.g. appropriate measuring equipment, fusing, current limiting, electrical separation, insulation) should be taken to avoid any hazards.
17. Ensure that the connections with information technology equipment comply with IEC 950/EN 60950.
18. Never remove the cover or part of the housing while you are operating the product. This will expose circuits and components and can lead to injuries, fire or damage to the product.

## Safety Instructions

19. If a product is to be permanently installed, the connection between the PE terminal on site and the product's PE conductor must be made first before any other connection is made. The product may be installed and connected only by a skilled electrician.
20. For permanently installed equipment without built-in fuses, circuit breakers or similar protective devices, the supply circuit must be fused in such a way that suitable protection is provided for users and products.
21. Do not insert any objects into the openings in the housing that are not designed for this purpose. Never pour any liquids onto or into the housing. This can cause short circuits inside the product and/or electric shocks, fire or injuries.
22. Use suitable overvoltage protection to ensure that no overvoltage (such as that caused by a thunderstorm) can reach the product. Otherwise the operating personnel will be endangered by electric shocks.
23. Rohde & Schwarz products are not protected against penetration of water, unless otherwise specified (see also safety instruction 1.). If this is not taken into account, there exists the danger of electric shock or damage to the product, which can also lead to personal injury.
24. Never use the product under conditions in which condensation has formed or can form in or on the product, e.g. if the product was moved from a cold to a warm environment.
25. Do not close any slots or openings on the product, since they are necessary for ventilation and prevent the product from overheating. Do not place the product on soft surfaces such as sofas or rugs or inside a closed housing, unless this is well ventilated.
26. Do not place the product on heat-generating devices such as radiators or fan heaters. The temperature of the environment must not exceed the maximum temperature specified in the data sheet.
27. Batteries and storage batteries must not be exposed to high temperatures or fire. Keep batteries and storage batteries away from children. If batteries or storage batteries are improperly replaced, this can cause an explosion (warning: lithium cells). Replace the battery or storage battery only with the matching Rohde & Schwarz type (see spare parts list). Batteries and storage batteries are hazardous waste. Dispose of them only in specially marked containers. Observe local regulations regarding waste disposal. Do not short-circuit batteries or storage batteries.
28. Please be aware that in the event of a fire, toxic substances (gases, liquids etc.) that may be hazardous to your health may escape from the product.
29. Please be aware of the weight of the product. Be careful when moving it; otherwise you may injure your back or other parts of your body.
30. Do not place the product on surfaces, vehicles, cabinets or tables that for reasons of weight or stability are unsuitable for this purpose. Always follow the manufacturer's installation instructions when installing the product and fastening it to objects or structures (e.g. walls and shelves).
31. Handles on the products are designed exclusively for personnel to hold or carry the product. It is therefore not permissible to use handles for fastening the product to or on means of transport such as cranes, fork lifts, wagons, etc. The user is responsible for securely fastening the products to or on the means of transport and for observing the safety regulations of the manufacturer of the means of transport. Noncompliance can result in personal injury or material damage.
32. If you use the product in a vehicle, it is the sole responsibility of the driver to drive the vehicle safely. Adequately secure the product in the vehicle to prevent injuries or other damage in the event of an accident. Never use the product in a moving vehicle if doing so could distract the driver of the vehicle. The driver is always responsible for the safety of the vehicle; the manufacturer assumes no responsibility for accidents or collisions.
33. If a laser product (e.g. a CD/DVD drive) is integrated in a Rohde & Schwarz product, do not use any other settings or functions than those described in the documentation. Otherwise this may be hazardous to your health, since the laser beam can cause irreversible damage to your eyes. Never try to take such products apart, and never look into the laser beam.





**Por favor lea imprescindiblemente antes de la primera puesta en funcionamiento las siguientes informaciones de seguridad**



## Informaciones de seguridad

Es el principio de Rohde & Schwarz de tener a sus productos siempre al día con los standards de seguridad y de ofrecer a sus clientes el máximo grado de seguridad. Nuestros productos y todos los equipos adicionales son siempre fabricados y examinados según las normas de seguridad vigentes. Nuestra sección de gestión de la seguridad de calidad controla constantemente que sean cumplidas estas normas. Este producto ha sido fabricado y examinado según el comprobante de conformidad adjunto según las normas de la CE y ha salido de nuestra planta en estado impecable según los standards técnicos de seguridad. Para poder preservar este estado y garantizar un funcionamiento libre de peligros, deberá el usuario atenerse a todas las informaciones, informaciones de seguridad y notas de alerta. Rohde&Schwarz está siempre a su disposición en caso de que tengan preguntas referentes a estas informaciones de seguridad.

Además queda en la responsabilidad del usuario utilizar el producto en la forma debida. Este producto solamente fue elaborado para ser utilizado en la industria y el laboratorio o para fines de campo y de ninguna manera deberá ser utilizado de modo que alguna persona/cosa pueda ser dañada. El uso del producto fuera de sus fines definidos o despreciando las informaciones de seguridad del fabricante queda en la responsabilidad del usuario. El fabricante no se hace en ninguna forma responsable de consecuencias a causa del maluso del producto.

Se parte del uso correcto del producto para los fines definidos si el producto es utilizado dentro de las instrucciones del correspondiente manual del uso y dentro del margen de rendimiento definido (ver hoja de datos, documentación, informaciones de seguridad que siguen). El uso de los productos hace necesarios conocimientos profundos y el conocimiento del idioma inglés. Por eso se deberá tener en cuenta de exclusivamente autorizar para el uso de los productos a personas péritas o debidamente minuciosamente instruidas con los conocimientos citados. Si fuera necesaria indumentaria de seguridad para el uso de productos de R&S, encontrará la información debida en la documentación del producto en el capítulo correspondiente.

### Símbolos y definiciones de seguridad

Ver manual de instrucciones del uso	Informaciones para maquinaria con un peso de > 18kg	Peligro de golpe de corriente	¡Advertencia! Superficie caliente	Conexión a conductor protector	Conexión a tierra	Conexión a masa conductora	¡Cuidado! Elementos de construcción con peligro de carga electrostática

potencia EN MARCHA/PARADA	Indicación Stand-by	Corriente continua DC	Corriente alterna AC	Corriente continua/alterna DC/AC	El aparato está protegido en su totalidad por un aislamiento de doble refuerzo

## Informaciones de seguridad

Tener en cuenta las informaciones de seguridad sirve para tratar de evitar daños y peligros de toda clase. Es necesario de que se lean las siguientes informaciones de seguridad concienzudamente y se tengan en cuenta debidamente antes de la puesta en funcionamiento del producto. También deberán ser tenidas en cuenta las informaciones para la protección de personas que encontrarán en otro capítulo de esta documentación y que también son obligatorias de seguir. En las informaciones de seguridad actuales hemos juntado todos los objetos vendidos por Rohde&Schwarz bajo la denominación de „producto“, entre ellos también aparatos, instalaciones así como toda clase de accesorios.

### Palabras de señal y su significado

PELIGRO	Indica un punto de peligro con gran potencial de riesgo para el usuario. Punto de peligro que puede llevar hasta la muerte o graves heridas.
ADVERTENCIA	Indica un punto de peligro con un potencial de riesgo mediano para el usuario. Punto de peligro que puede llevar hasta la muerte o graves heridas .
ATENCIÓN	Indica un punto de peligro con un potencial de riesgo pequeño para el usuario. Punto de peligro que puede llevar hasta heridas leves o pequeñas
CUIDADO	Indica la posibilidad de utilizar mal el producto y a consecuencia dañarlo.
INFORMACIÓN	Indica una situación en la que deberían seguirse las instrucciones en el uso del producto, pero que no consecuentemente deben de llevar a un daño del mismo.

Las palabras de señal corresponden a la definición habitual para aplicaciones civiles en el ámbito de la comunidad económica europea. Pueden existir definiciones diferentes a esta definición. Por eso se debiera tener en cuenta que las palabras de señal aquí descritas sean utilizadas siempre solamente en combinación con la correspondiente documentación y solamente en combinación con el producto correspondiente. La utilización de las palabras de señal en combinación con productos o documentaciones que no les correspondan puede llevar a malinterpretaciones y tener por consecuencia daños en personas u objetos.

### Informaciones de seguridad elementales

1. El producto solamente debe ser utilizado según lo indicado por el fabricante referente a la situación y posición de funcionamiento sin que se obstruya la ventilación. Si no se convino de otra manera, es para los productos R&S válido lo que sigue: como posición de funcionamiento se define principalmente la posición con el suelo de la caja para abajo , modo de protección IP 2X, grado de suciedad 2, categoría de sobrecarga eléctrica 2, utilizar solamente en estancias interiores, utilización hasta 2000 m sobre el nivel del mar.  
A menos que se especifique otra cosa en la hoja de datos, se aplicará una tolerancia de  $\pm 10\%$  sobre el voltaje nominal y de  $\pm 5\%$  sobre la frecuencia nominal.
2. En todos los trabajos deberán ser tenidas en cuenta las normas locales de seguridad de trabajo y de prevención de accidentes. El producto solamente debe de ser abierto por personal périto autorizado. Antes de efectuar trabajos en el producto o abrirlo deberá este ser desconectado de la corriente. El ajuste, el cambio de partes, la manutención y la reparación deberán ser solamente efectuadas por electricistas autorizados por R&S. Si se reponen partes con importancia para los aspectos de seguridad (por ejemplo el enchufe, los transformadores o los fusibles), solamente podrán ser sustituidos por partes originales. Despues de cada recambio de partes elementales para la seguridad deberá ser efectuado un control de

## Informaciones de seguridad

- seguridad (control a primera vista, control de conductor protector, medición de resistencia de aislamiento, medición de medición de la corriente conductora, control de funcionamiento).
3. Como en todo producto de fabricación industrial no puede ser excluido en general de que se produzcan al usarlo elementos que puedan generar alergias, los llamados elementos alergénicos (por ejemplo el níquel). Si se produjeran en el trato con productos R&S reacciones alérgicas, como por ejemplo urticaria, estornudos frecuentes, irritación de la conjuntiva o dificultades al respirar, se deberá consultar inmediatamente a un médico para averiguar los motivos de estas reacciones.
  4. Si productos / elementos de construcción son tratados fuera del funcionamiento definido de forma mecánica o térmica, pueden generarse elementos peligrosos (polvos de sustancia de metales pesados como por ejemplo plomo, berilio, níquel). La partición elemental del producto, como por ejemplo sucede en el tratamiento de materias residuales, debe de ser efectuada solamente por personal especializado para estos tratamientos. La partición elemental efectuada inadecuadamente puede generar daños para la salud. Se deben tener en cuenta las directivas nacionales referentes al tratamiento de materias residuales.
  5. En el caso de que se produjeran agentes de peligro o combustibles en la aplicación del producto que debieran de ser transferidos a un tratamiento de materias residuales, como por ejemplo agentes refrigerantes que deben ser repuestos en periodos definidos, o aceites para motores, deberán ser tenidas en cuenta las prescripciones de seguridad del fabricante de estos agentes de peligro o combustibles y las regulaciones regionales para el tratamiento de materias residuales. Cuiden también de tener en cuenta en caso dado las prescripciones de seguridad especiales en la descripción del producto.
  6. Ciertos productos, como por ejemplo las instalaciones de radiación HF, pueden a causa de su función natural, emitir una radiación electromagnética aumentada. En vista a la protección de la vida en desarrollo deberían ser protegidas personas embarazadas debidamente. También las personas con un bypass pueden correr peligro a causa de la radiación electromagnética. El empresario está comprometido a valorar y señalar áreas de trabajo en las que se corra un riesgo de exposición a radiaciones aumentadas de riesgo aumentado para evitar riesgos.
  7. La utilización de los productos requiere instrucciones especiales y una alta concentración en el manejo. Debe de ponerse por seguro de que las personas que manejen los productos estén a la altura de los requerimientos necesarios referente a sus aptitudes físicas, psíquicas y emocionales, ya que de otra manera no se pueden excluir lesiones o daños de objetos. El empresario lleva la responsabilidad de seleccionar el personal usuario apto para el manejo de los productos.
  8. Antes de la puesta en marcha del producto se deberá tener por seguro de que la tensión preseleccionada en el producto equivalga a la de la red de distribución. Si es necesario cambiar la preselección de la tensión también se deberán en caso de cambio cambiar los fusibles correspondientes del producto.
  9. Productos de la clase de seguridad I con alimentación móvil y enchufe individual de producto solamente deberán ser conectados para el funcionamiento a tomas de corriente de contacto de seguridad y con conductor protector conectado.
  10. Queda prohibida toda clase de interrupción intencionada del conductor protector, tanto en la toma de corriente como en el mismo producto ya que puede tener como consecuencia el peligro de golpe de corriente por el producto. Si se utilizaran cables o enchufes de extensión se deberá poner al seguro, que es controlado su estado técnico de seguridad.
  11. Si el producto no está equipado con un interruptor para desconectarlo de la red, se deberá considerar el enchufe del cable de distribución como interruptor. En estos casos deberá asegurarse de que el enchufe sea de fácil acceso y nabejo (medida del cable de distribución aproximadamente 2 m). Los interruptores de función o electrónicos no son aptos para el corte de la red eléctrica. Si los productos sin interruptor están integrados en construcciones o instalaciones, se deberá instalar el interruptor al nivel de la instalación.

## Informaciones de seguridad

12. No utilice nunca el producto si está dañado el cable eléctrico. Asegure a través de las medidas de protección y de instalación adecuadas de que el cable de eléctrico no pueda ser dañado o de que nadie pueda ser dañado por él, por ejemplo al tropezar o por un golpe de corriente.
13. Solamente está permitido el funcionamiento en redes de distribución TN/TT aseguradas con fusibles de como máximo 16 A.
14. Nunca conecte el enchufe en tomas de corriente sucias o llenas de polvo. Introduzca el enchufe por completo y fuertemente en la toma de corriente. Si no tiene en consideración estas indicaciones se arriesga a que se originen chispas, fuego y/o heridas.
15. No sobrecargue las tomas de corriente, los cables de extensión o los enchufes de extensión ya que esto pudiera causar fuego o golpes de corriente.
16. En las mediciones en circuitos de corriente con una tensión de entrada de  $U_{eff} > 30 \text{ V}$  se deberá tomar las precauciones debidas para impedir cualquier peligro (por ejemplo medios de medición adecuados, seguros, limitación de tensión, corte protector, aislamiento etc.).
17. En caso de conexión con aparatos de la técnica informática se deberá tener en cuenta que estos cumplan los requisitos de la EC950/EN60950.
18. Nunca abra la tapa o parte de ella si el producto está en funcionamiento. Esto pone a descubierto los cables y componentes eléctricos y puede causar heridas, fuego o daños en el producto.
19. Si un producto es instalado fijamente en un lugar, se deberá primero conectar el conductor protector fijo con el conductor protector del aparato antes de hacer cualquier otra conexión. La instalación y la conexión deberán ser efectuadas por un electricista especializado.
20. En caso de que los productos que son instalados fijamente en un lugar sean sin protector implementado, autointerruptor o similares objetos de protección, deberá la toma de corriente estar protegida de manera que los productos o los usuarios estén suficientemente protegidos.
21. Por favor, no introduzca ningún objeto que no esté destinado a ello en los orificios de la caja del aparato. No vierta nunca ninguna clase de líquidos sobre o en la caja. Esto puede producir corto circuitos en el producto y/o puede causar golpes de corriente, fuego o heridas.
22. Asegúrese con la protección adecuada de que no pueda originarse en el producto una sobrecarga por ejemplo a causa de una tormenta. Si no se verá el personal que lo utilice expuesto al peligro de un golpe de corriente.
23. Los productos R&S no están protegidos contra el agua si no es que exista otra indicación, ver también punto 1. Si no se tiene en cuenta esto se arriesga el peligro de golpe de corriente o de daños en el producto lo cual también puede llevar al peligro de personas.
24. No utilice el producto bajo condiciones en las que pueda producirse y se hayan producido líquidos de condensación en o dentro del producto como por ejemplo cuando se desplaza el producto de un lugar frío a un lugar caliente.
25. Por favor no cierre ninguna ranura u orificio del producto, ya que estas son necesarias para la ventilación e impiden que el producto se caliente demasiado. No pongan el producto encima de materiales blandos como por ejemplo sofás o alfombras o dentro de una caja cerrada, si esta no está suficientemente ventilada.
26. No ponga el producto sobre aparatos que produzcan calor, como por ejemplo radiadores o calentadores. La temperatura ambiental no debe superar la temperatura máxima especificada en la hoja de datos.

## Informaciones de seguridad

27. Baterías y acumuladores no deben de ser expuestos a temperaturas altas o al fuego. Guardar baterías y acumuladores fuera del alcance de los niños. Si las baterías o los acumuladores no son cambiados con la debida atención existirá peligro de explosión (atención celulas de Litio). Cambiar las baterías o los acumuladores solamente por los del tipo R&S correspondiente (ver lista de piezas de recambio). Baterías y acumuladores son deshechos problemáticos. Por favor tirenlos en los recipientes especiales para este fin. Por favor tengan en cuenta las prescripciones nacionales de cada país referente al tratamiento de deshechos. Nunca sometan las baterías o acumuladores a un corto circuito.
28. Tengan en consideración de que en caso de un incendio pueden escaparse gases tóxicos del producto, que pueden causar daños a la salud.
29. Por favor tengan en cuenta que en caso de un incendio pueden desprenderse del producto agentes venenosos (gases, líquidos etc.) que pueden generar daños a la salud.
30. No sitúe el producto encima de superficies, vehículos, estantes o mesas, que por sus características de peso o de estabilidad no sean aptas para él. Siga siempre las instrucciones de instalación del fabricante cuando instale y asegure el producto en objetos o estructuras (por ejemplo paredes y estantes).
31. Las asas instaladas en los productos sirven solamente de ayuda para el manejo que solamente está previsto para personas. Por eso no está permitido utilizar las asas para la sujecion en o sobre medios de transporte como por ejemplo grúas, carretillas elevadoras de horquilla, carros etc. El usuario es responsable de que los productos sean sujetados de forma segura a los medios de transporte y de que las prescripciones de seguridad del fabricante de los medios de transporte sean tenidas en cuenta. En caso de que no se tengan en cuenta pueden causarse daños en personas y objetos.
32. Si llega a utilizar el producto dentro de un vehículo, queda en la responsabilidad absoluta del conductor que conducir el vehículo de manera segura. Asegure el producto dentro del vehículo debidamente para evitar en caso de un accidente las lesiones u otra clase de daños. No utilice nunca el producto dentro de un vehículo en movimiento si esto pudiera distraer al conductor. Siempre queda en la responsabilidad absoluta del conductor la seguridad del vehículo y el fabricante no asumirá ninguna clase de responsabilidad por accidentes o colisiones.
33. Dado el caso de que esté integrado un producto de laser en un producto R&S (por ejemplo CD/DVD-ROM) no utilice otras instalaciones o funciones que las descritas en la documentación. De otra manera pondrá en peligro su salud, ya que el rayo laser puede dañar irreversiblemente sus ojos. Nunca trate de descomponer estos productos. Nunca mire dentro del rayo laser.

## Certified Quality System

**DIN EN ISO 9001 : 2000**  
**DIN EN 9100 : 2003**  
**DIN EN ISO 14001 : 1996**

**DQS REG. NO 001954 QM/ST UM**

### QUALITÄTSZERTIFIKAT

*Sehr geehrter Kunde,*

Sie haben sich für den Kauf eines Rohde & Schwarz-Produktes entschieden. Hiermit erhalten Sie ein nach modernsten Fertigungsmethoden hergestelltes Produkt. Es wurde nach den Regeln unseres Managementsystems entwickelt, gefertigt und geprüft.

Das Rohde & Schwarz Managementsystem ist zertifiziert nach:

DIN EN ISO 9001:2000  
DIN EN 9100:2003  
DIN EN ISO 14001:1996

### CERTIFICATE OF QUALITY

*Dear Customer,*

you have decided to buy a Rohde & Schwarz product. You are thus assured of receiving a product that is manufactured using the most modern methods available. This product was developed, manufactured and tested in compliance with our quality management system standards.

The Rohde & Schwarz quality management system is certified according to:

DIN EN ISO 9001:2000  
DIN EN 9100:2003  
DIN EN ISO 14001:1996

### CERTIFICAT DE QUALITÉ

*Cher Client,*

vous avez choisi d'acheter un produit Rohde & Schwarz. Vous disposez donc d'un produit fabriqué d'après les méthodes les plus avancées. Le développement, la fabrication et les tests respectent nos normes de gestion qualité.

Le système de gestion qualité de Rohde & Schwarz a été homologué conformément aux normes:

DIN EN ISO 9001:2000  
DIN EN 9100:2003  
DIN EN ISO 14001:1996



**ROHDE & SCHWARZ**

# Customer Support

## Technical support – where and when you need it

For quick, expert help with any Rohde & Schwarz equipment, contact one of our Customer Support Centers. A team of highly qualified engineers provides telephone support and will work with you to find a solution to your query on any aspect of the operation, programming or applications of Rohde & Schwarz equipment.

## Up-to-date information and upgrades

To keep your Rohde & Schwarz equipment always up-to-date, please subscribe to our electronic newsletter at

<http://www.rohde-schwarz.com/www/response.nsf/newsletterpreselection>

or request the desired information and upgrades via email from your Customer Support Center (addresses see below).

## Feedback

We want to know if we are meeting your support needs. If you have any comments please email us and let us know [CustomerSupport.Feedback@rohde-schwarz.com](mailto:CustomerSupport.Feedback@rohde-schwarz.com).

---

### USA & Canada

Monday to Friday (except US public holidays)

8:00 AM – 8:00 PM Eastern Standard Time (EST)

Tel. from USA 888-test-rsa (888-837-8772) (opt 2)

From outside USA +1 410 910 7800 (opt 2)

Fax +1 410 910 7801

E-mail [Customer.Support@rsa.rohde-schwarz.com](mailto:Customer.Support@rsa.rohde-schwarz.com)

### East Asia

Monday to Friday (except Singaporean public holidays)

8:30 AM – 6:00 PM Singapore Time (SGT)

Tel. +65 6 513 0488

Fax +65 6 846 1090

E-mail [Customersupport.asia@rohde-schwarz.com](mailto:Customersupport.asia@rohde-schwarz.com)

### Rest of the World

Monday to Friday (except German public holidays)

08:00 – 17:00 Central European Time (CET)

Tel. from Europe +49 (0) 180 512 42 42

From outside Europe +49 89 4129 13776

Fax +49 (0) 89 41 29 637 78

E-mail [CustomerSupport@rohde-schwarz.com](mailto:CustomerSupport@rohde-schwarz.com)



# Adressen/Addresses

## FIRMENSITZ/HEADQUARTERS

(Tel) Phone  
(Fax) Fax  
E-mail

Rohde & Schwarz GmbH & Co. KG  
Mühlendorfstraße 15 · D-81671 München  
Postfach 80 14 69 · D-81614 München

(Tel) +49 (89) 41 29-0  
(Fax) +49 89 4129-121 64  
info@rohde-schwarz.com

## WERKE/PLANTS

Rohde & Schwarz Messgerätebau GmbH  
Riedbachstraße 58 · D-87700 Memmingen  
Postfach 1652 · D-87686 Memmingen

(Tel) +49 (8331) 108-0  
(Fax) +49 (8331) 108-11 24  
info.rsdmb@rohde-schwarz.com

Rohde & Schwarz GmbH & Co. KG  
Werk Teisnach  
Kaikenrieder Straße 27 · D-94244 Teisnach  
Postfach 1149 · D-94240 Teisnach

(Tel) +49 (9923) 857-0  
(Fax) +49 (9923) 857-11 74  
info.rsdts@rohde-schwarz.com

Rohde & Schwarz GmbH & Co. KG  
Dienstleistungszentrum Köln  
Graf-Zeppelin-Straße 18 · D-51147 Köln  
Postfach 98 02 60 · D-51130 Köln

(Tel) +49 (2203) 49-0  
(Fax) +49 (2203) 49 51-229  
info.rsd@rohde-schwarz.com  
schwarz.com-service.rsd@rohde-schwarz.com

## TOCHTERUNTERNEHMEN/SUBSIDIARIES

Rohde & Schwarz Vertriebs-GmbH  
Mühlendorfstraße 15 · D-81671 München  
Postfach 80 14 69 · D-81614 München

(Tel) +49 (89) 41 29-137 74  
(Fax) +49 (89) 41 29-137 77  
customersupport@rohde-schwarz.com

Rohde & Schwarz International GmbH  
Mühlendorfstraße 15 · D-81671 München  
Postfach 80 14 60 · D-81614 München

(Tel) +49 (89) 41 29-129 84  
(Fax) +49 (89) 41 29-120 50  
info.rusis@rohde-schwarz.com

Rohde & Schwarz Engineering and Sales GmbH  
Mühlendorfstraße 15 · D-81671 München  
Postfach 80 14 29 · D-81614 München

(Tel) +49 (89) 41 29-137 11  
(Fax) +49 (89) 41 29-137 23  
info.rse@rohde-schwarz.com

R&S BICK Mobilfunk GmbH  
Fritz-Hahne-Str. 7 · D-31848 Bad Münder  
Postfach 2062 · D-31844 Bad Münder

(Tel) +49 (5042) 998-0  
(Fax) +49 (5042) 998-105  
info.rsbeck@rohde-schwarz.com

Rohde & Schwarz FTK GmbH  
Wendenschlossstraße 168, Haus 28  
D-12557 Berlin

(Tel) +49 (30) 658 91-122  
(Fax) +49 (30) 655 50-221  
info.ftk@rohde-schwarz.com

Rohde & Schwarz SIT GmbH  
Agastraße 3  
D-12489 Berlin

(Tel) +49 (30) 658 84-0  
(Fax) +49 (30) 658 84-183  
info.sit@rohde-schwarz.com

R&S Systems GmbH  
Graf-Zeppelin-Straße 18 · D-51147 Köln  
Postfach 98 02 60 · D-51130 Köln

(Tel) +49 (2203) 49-5 23 25  
(Fax) +49 (2203) 49-5 23 36  
info.rssys@rohde-schwarz.com

## ADRESSEN WELTWEIT/ADDRESSES WORLDWIDE

**Albania** siehe/see Austria

**Algeria** Rohde & Schwarz  
Bureau d'Alger  
5B Place de Laperrine  
16035 Hydra-Alger

(Tel) +213 (21) 48 20 18  
(Fax) +213 (21) 69 46 08

**Antilles (Neth.)** siehe / see Mexico

**Argentina** Precision Electronica S.R.L.  
Av. Pde Julio A. Roca 710 - 6° Piso  
1067 Buenos Aires

(Tel) +541 (14) 331 10 67  
(Fax) +541 (14) 334 51 11  
alberto.lombardi@prec-elec.com.ar

**Australia** Rohde & Schwarz (Australia) Pty. Ltd.  
Sales Support  
Unit 6  
2-8 South Street  
Rydalmere, N.S.W. 2116

(Tel) +61 (2) 88 45 41 00  
(Fax) +61 (2) 96 38 39 88  
sales@rsa.us.rohde-schwarz.com

**Austria** Rohde & Schwarz-Österreich Ges.m.b.H.  
Am Europlatz 3  
Gebäude B  
1120 Wien

(Tel) +43 (1) 602 61 41-0  
(Fax) +43 (1) 602 61 41-14  
rs-austria@rsoe.rohde-schwarz.com

**Azerbaijan** Rohde & Schwarz Azerbaijan  
Liaison Office Baku  
ISR Plaza, 5th floor  
340 Nizami Str.  
370000 Baku

(Tel) +994 (12) 93 31 38  
(Fax) +994 (12) 93 03 14  
rs-azerbaijan@rsd.rohde-schwarz.com

**Bangladesh** BIL Consortium Ltd.  
Corporate Office  
House-33, Road-4, Block-F  
Banani, Dhaka-1213

(Tel) +880 (2) 881 06 53  
(Fax) +880 (2) 882 82 91

**Barbados** siehe / see Mexico

**Belarus** siehe/see Ukraine

**Belgium** Rohde & Schwarz Belgium N.V.  
Excelsiorlaan 31 Bus 1  
1930 Zaventem

(Tel) +32 (2) 721 50 02  
(Fax) +32 (2) 725 09 36  
info@rsb.rohde-schwarz.com

**Belize** siehe / see Mexico

**Bermuda** siehe/see Mexico

**Bosnia-Herzegovina** siehe/see Slovenia

**Brazil** Rohde & Schwarz Do Brasil Ltda.  
Av. Alfredo Egidio de Souza Aranha (Bd. Aranha)  
1° andar - Santo Amaro  
04726-170 Sao Paulo - SP

(Tel) +55 (11) 56 44 86 11  
(Fax) +55 (11) 56 44 86 25 (sales)  
(Fax) +55 (11) 56 44 86 36  
sales-brazil@rsdb.rohde-schwarz.com

**Brunei** George Keen Lee Equipment Pte Ltd.  
#11-01 BP Tower  
396 Alexandra Road  
Singapore 119954

(Tel) +656 276 06 26  
(Fax) +656 276 06 29  
gkleqpt@singnet.com.sg

**Bulgaria** Rohde & Schwarz  
Representation Office Bulgaria  
39, Fridtjof Nansen Blvd.  
1000 Sofia

(Tel) +359 (2) 96 343 34  
(Fax) +359 (2) 963 21 97  
rs-bulgaria@rsbg.rohde-schwarz

**Canada** Rohde & Schwarz Canada Inc.  
555 March Rd.  
Kanata, Ontario K2K 2M5

(Tel) +1 (613) 592 80 00  
(Fax) +1 (613) 592 80 09  
sales@rscanada.ca

**Chile** Dymeq Ltda.  
Av. Larrain 6666  
Santiago

(Tel) +56 (2) 339 20 00  
(Fax) +56 (2) 339 20 10  
dymeq@dymeq.com

**China** Rohde & Schwarz China Ltd.  
Representative Office Beijing  
6F, Parkview Center  
2 Jiangtai Road  
Chao Yang District  
Beijing 100016

(Tel) +86 (10) 64 31 28 28  
(Fax) +86 (10) 64 37 98 88  
info.rschina@rsbp.rohde-schwarz.com

Rohde & Schwarz China Ltd.  
Representative Office Shanghai  
Room 807-809, Central Plaza  
227 Huangpi North Road  
Shanghai 200003

(Tel) +86 (21) 63 75 00 18  
(Fax) +86 (21) 63 75 91 70  
May.Zhu@rsbp.rohde-schwarz.com

Rohde & Schwarz China Ltd.  
Representative Office Guangzhou  
Room 2903, Metro Plaza  
183 Tian He North Road  
Guangzhou 510075

(Tel) +86 (20) 87 55 47 58  
(Fax) +86 (20) 87 55 47 59  
Winnie.Lin@rsbp.rohde-schwarz.com





# Adressen/Addresses

<b>India</b>	Rohde & Schwarz India Pvt. Ltd. Mumbai Office B-603, Remi Bizcourt, Shah Industrial Estate, Off Veera Desai Road Andheri West Mumbai - 400 058	(Tel) +91 (22) 26 30 18 10 (Fax) +91 (22) 26 73 20 81 rsindiam@rsnl.net	<b>Kazakhstan</b>	Rohde & Schwarz Kazakhstan Representative Office Almaty Pl. Respubliki 15 480013 Almaty	(Tel) +7 (32) 72 67 23 54 (Fax) +7 (32) 72 67 23 46 rs-kazakhstan@rsd-rohde-schwarz.com
<b>Indonesia</b>	PT Rohde & Schwarz Indonesia Graha Paramita 5th Floor Jln. Denpasar Raya Blok D-2 Jakarta 12940	(Tel) +62 (21) 252 36 08 (Fax) +62 (21) 252 36 07 sales@rsbj.rohde-schwarz.com-services@rsbj.rohde-schwarz.com	<b>Kenya</b>	Excel Enterprises Ltd Dunga Road P.O.Box 42 788 Nairobi	(Tel) +254 (2) 55 80 88 (Fax) +254 (2) 54 46 79
<b>Iran</b>	Rohde & Schwarz Iran Liaison Office Tehran Groundfloor No. 1, 14th Street Khaled Eslamboli (Vozara) Ave. 15117 Tehran	(Tel) +98 (21) 872 42 96 (Fax) +98 (21) 871 90 12 alfred.korff@rsd.rohde-schwarz.com	<b>Korea</b>	Rohde & Schwarz Korea Ltd. 83-29 Nonhyun-Dong, Kangnam-Ku  Seoul 135-010	(Tel) +82 (2) 34 85 19 00 (Fax) +82 (2) 547 43 00 sales@rskor.rohde-schwarz.com-service@rskor.rohde-schwarz.com
<b>Ireland</b>	siehe/see United Kingdom		<b>Kuwait</b>	Group Five Trading & Contracting Co. Mezzanine Floor Al-Bana Towers Ahmad Al Jaber Street Sharq	(Tel) +965 (244) 91 72/73/74 (Fax) +965 (244) 95 28 jk_agarwal@yahoo.com
<b>Israel</b>	Eastronics Ltd. Measurement Products 11 Rozanis St. P.O.Box 39300 Tel Aviv 61392	(Tel) +972 (3) 645 87 77 (Fax) +972 (3) 645 86 66 david_hasky@easx.co.il	<b>Latvia</b>	Rohde & Schwarz Danmark A/S Latvian Branch Office Merkela iela 21-301 1050 Riga	(Tel) +371 (7) 50 23 55 (Fax) +371 (7) 50 23 60 latvia@rsdk.rohde-schwarz.com
	J.M. Moss (Engineering) Ltd. Communications Products 9 Oded Street P.O.Box 967 52109 Ramat Gan	(Tel) +972 (3) 631 20 57 (Fax) +972 (3) 631 40 58 jmoss@zahav.net.il	<b>Lebanon</b>	Rohde & Schwarz Liaison Office Riyadh P.O.Box 361 Riyadh 11411	(Tel) +966 (1) 465 64 28 Ext. 303 (Fax) +966 (1) 465 64 28 Ext. 229 chris.porzky@rsd.rohde-schwarz.com
<b>Italy</b>	Rohde & Schwarz Italia S.p.a. Centro Direzionale Lombardo Via Roma 108 20060 Cassina de Pecchi (MI)	(Tel) +39 (02) 95 70 41 (Fax) +39 (02) 95 30 27 72 rsi.info@rsi.rohde-schwarz.com		Netcom P.O.Box 55199 Op. Ex-Presidential Palace Horch Tabet Beirut	(Tel) +961 (1) 48 69 99 (Fax) +961 (1) 49 05 11 tohme.sayar@netcomm.tv
	Rohde & Schwarz Italia S.p.a. Via Tiburtina 1182 00156 Roma	(Tel) +39 (06) 41 59 81 (Fax) +39 (06) 41 59 82 70 rsi.info@rsi.rohde-schwarz.com	<b>Liechtenstein</b>	siehe/see Switzerland	
<b>Jamaica</b>	siehe / see Mexico		<b>Lithuania</b>	Rohde & Schwarz Danmark A/S Lithuanian Branch Office Lukiskiu 5-228 2600 Vilnius	(Tel) +370 (5) 239 50 10 (Fax) +370 (5) 239 50 11 lithuania@rsdk.rohde-schwarz.com
<b>Japan</b>	Rohde & Schwarz Japan K.K. Tokyo Office 711 Bldg., Room 501 (5th floor) 7-11-18 Nishi-Shinjuku Shinjuku-ku Tokyo 160-0023	(Tel) +81 (3) 59 25 12 88 (Fax) +81 (3) 59 25 12 90 scj.support@rsjp.rohde-schwarz.com	<b>Luxembourg</b>	siehe/see Belgium	
	Rohde & Schwarz Japan K.K. Shin-Yokohama Office KM Daiichi Bldg., 8F 2-13-13 Kouhoku-ku Yokohama-shi Kanagawa 222-0033	(Tel) +81 (4) 54 77 35 70	<b>Macedonia</b>	NETRA Sarski odred 7 1000 Skopje	(Tel) +389 (2) 329 82 30 (Fax) +389 (2) 317 74 88 netra@netra.com.sk
	Rohde & Schwarz Japan K.K. Osaka Office TEK Dai 2 Bldg., 8F 1-13-20 Esaka-shi Suita-shi Osaka-fu 564-0063	(Tel) +81 (6) 63 10 96 51	<b>Malaysia</b>	Rohde & Schwarz Malaysia Sdn Bhd Suite 10.04, Level 10, Wisma E&C No. 2 Lorong Dungun Kiri Damansara Heights 50490 Kuala-Lumpur	(Tel) +60 (3) 20 94 00 33 (Fax) +60 (3) 20 94 24 33 sales.malaysia@rohde-schwarz.com
<b>Jordan</b>	Jordan Crown Engineering & Trading Co. Jabal Amman, Second Circle Youssef Ezzideen Street P.O.Box 830414 Amman, 11183	(Tel) +962 (6) 462 17 29 (Fax) +962 (6) 465 96 72 jocrown@go.com.jo	<b>Malta</b>	Tektraco International Technology Ltd. 121, B'Kara Road San Gwann SGN 08	(Tel) +356 (21) 37 43 00 or 37 80 88 (Fax) +356 (21) 37 66 67 sales@tektraco.com
			<b>Mexico</b>	Rohde & Schwarz de Mexico S. de R.L. de C.V. German Centre Oficina 4-2-2 Av. Santa Fé 170 Col. Lomas de Santa Fé 01210 Mexico D.F.	(Tel) +52 (55) 85 03 99 13 (Fax) +52 (55) 85 03 99 16 latinoamerica@rsd-rohde-schwarz.com
			<b>Moldava</b>	siehe/see Austria	
			<b>Nepal</b>	ICTC Pvt. Ltd. Hattisar, Post Box No. 660 Kathmandu	(Tel) +977 (1) 443 48 95 (Fax) +977 (1) 443 49 37 ictc@mos.com.np

# Adressen/Addresses

<b>Netherlands</b>	Rohde & Schwarz Nederland B.V. Perkinsbaan 1 3439 ND Nieuwegein	(Tel) +31 (30) 600 17 00 (Fax) +31 (30) 600 17 99 info@rsn.rohde-schwarz.com	<b>Saudi Arabia</b>	Gentec Haji Abdullah Alireza & Co. Ltd. P.O.Box 43054 Riyadh	(Tel) +966 (1) 293 20 35 (Fax) +966 (1) 466 16 57 akanbar@gentec.com.sa
<b>New Zealand</b>	Nichecom 1 Lincoln Ave. Tawa, Wellington	(Tel) +64 (4) 232 32 33 (Fax) +64 (4) 232 32 30 rob@nichecom.co.nz	<b>Serbia-Montenegro</b>	Rohde & Schwarz Representative Office Belgrade Tose Jovanovica 7 11030 Beograd	(Tel) +381 (11) 305 50 25 (Fax) +381 (11) 305 50 24 rs-scg@rscs.rohde-schwarz.com
<b>Nicaragua</b>	siehe/see Mexico		<b>Singapore</b>	Rohde & Schwarz Regional Headquarters Singapore Pte. Ltd. 1 Kaki Bukit View #05-01/02 Techview Singapore 415 941	(Tel) +65 68 46 18 72 (Fax) +65 68 46 12 52
<b>Nigeria</b>	Ferrostaal Abuja Plot 3323, Barada Close P.O.Box 8513, Wuse Off Amazon Street Maitama, Abuja	(Tel) +234 (9) 413 52 51 (Fax) +234 (9) 413 52 50 fsabuja@rosecom.net			
<b>Norway</b>	Rohde & Schwarz Norge AS Enebakkeveien 302 B 1188 Oslo	(Tel) +47 (23) 38 66 00 (Fax) +47 (23) 38 66 01 firmapost@rsnor.rohde-schwarz.com		Rohde & Schwarz Systems & Communications Asia Pte Ltd Service 1 Kaki Bukit View #04-01/07 Techview Singapore 415 941	(Tel) +65 68 46 37 10 (Fax) +65 68 46 00 29 info@rssg.rohde-schwarz.com
<b>Oman</b>	Mustafa Sultan Science & Industry Co.LLC. Test & Measurement Products Way No. 3503 Building No. 241 Postal Code 112 Al Khuwair, Muscat	(Tel) +968 63 60 00 (Fax) +968 60 70 66 m-aziz@mustafasultan.com	<b>Slovak Republic</b>	Specialne systémy a software, a.s. Svrčia ul. 3 841 04 Bratislava 4	(Tel) +421 (2) 65 42 24 88 (Fax) +421 (2) 65 42 07 68 3s@special.sk
<b>Pakistan</b>	Siemens Pakistan 23, West Jinnah Avenue Islamabad	(Tel) +92 (51) 227 22 00 (Fax) +92 (51) 227 54 98 reza.bokhary@siemens.com.pk	<b>Slovenia</b>	Rohde & Schwarz Representative Office Ljubljana Tbilisjska 89 1000 Ljubljana	(Tel) +386 (1) 423 46 51 (Fax) +386 (1) 423 46 11 rs-slovenia@rssi.rohde-schwarz.com
<b>Panama</b>	siehe/see Mexico		<b>South Africa</b>	Protea Data Systems (Pty.) Ltd. Communications and Measurement Division Private Bag X19 Bramley 2018	(Tel) +27 (11) 719 57 00 (Fax) +27 (11) 786 58 91 unicm@protea.co.za
<b>Papua New Guinea</b>	siehe/see Australia				
<b>Paraguay</b>	siehe/see Argentina				
<b>Philippines</b>	Rohde & Schwarz (Philippines) Inc. Unit 2301, PBCOM Tower 6795, Ayala Ave. cor. Herrera St. Makati City	(Tel) +63 (2) 753 14 44 (Fax) +63 (2) 753 14 56		Protea Data Systems (Pty.) Ltd. Cape Town Branch Unit G9, Centurion Business Park Bosmandam Road Milnerton Cape Town, 7441	(Tel) +27 (21) 555 36 32 (Fax) +27 (21) 555 42 67 unicm@protea.co.za
<b>Poland</b>	Rohde & Schwarz SP.z o.o. Przedstawicielstwo w Polsce ul. Stawki 2, Pietro 28 00-193 Warszawa	(Tel) +48 (22) 860 64 94 (Fax) +48 (22) 860 64 99 rs-poland@rspl.rohde-schwarz.com	<b>Spain</b>	Rohde & Schwarz Espana S.A. Salcedo, 11 28034 Madrid	(Tel) +34 (91) 334 10 70 (Fax) +34 (91) 729 05 06 rses@rses.rohde-schwarz.com
<b>Portugal</b>	Rohde & Schwarz Portugal, Lda. Alameda Antonio Sergio 7-R/C - Sala A 2795-023 Linda-a-Velha	(Tel) +351 (21) 415 57 00 (Fax) +351 (21) 415 57 10 info@rspt.rohde-schwarz.com		Rohde & Schwarz Espana S.A. Av. Príncipe d'Astúries, 66 08012 Barcelona	(Tel) +34 (93) 415 15 68 (Fax) +34 (93) 237 49 95 bcn@rses.rohde-schwarz.com
<b>Republic Dominican</b>	siehe/see Mexico		<b>Sri Lanka</b>	Dynatel Communications (PTE) Ltd. 451/A Kandy Road Kelaniya	(Tel) +94 (112) 90 80 01 (Fax) +94 (112) 91 04 69 69 dynatel@dyanet.lk
<b>Romania</b>	Rohde & Schwarz Representation Office Bucharest 89 Eroii Sanitari Blvd., sector 5 050472 Bucuresti	(Tel) +40 (21) 411 20 13 (Fax) +40 (21) 410 68 46 rs-romania@rsro.rohde-schwarz.com	<b>Sudan</b>	SolarMan Co. Ltd. P.O.Box 11 545 North of Fraouq Cementry 6/7/9 Bldg. 16 Karthoum	(Tel) +249 (183) 47 31 08 (Fax) +249 (183) 47 31 38 solarman29@hotmail.com
<b>Russian Federation</b>	Rohde & Schwarz International GmbH 119180, Yakimanskaya nab., 2 Moscow	(Tel) +7 (095) 745 88 50 to 53 (Fax) +7 (095) 745 88 54 rs-russia@rsru.rohde-schwarz.com	<b>Sweden</b>	Rohde & Schwarz Sverige AB Flygfältsgatan 15 128 30 Skarpnäck	(Tel) +46 (8) 605 19 00 (Fax) +46 (8) 605 19 80 info@rss.rohde-schwarz.com
<b>Saudi Arabia</b>	Rohde & Schwarz International GmbH - Liaison Office Riyadh c/o Haji Abdullah Alireza Co. Ltd. P.O.Box 361 Riyadh 11411	(Tel) +966 (1) 293 2035 (Fax) +966 (1) 466 1657 chris.porzky@rsd.rohde-schwarz.com	<b>Switzerland</b>	Roschi Rohde & Schwarz AG Mühlestr. 7 3063 Ittigen	(Tel) +41 (31) 922 15 22 (Fax) +41 (31) 921 81 01 support@roschi.rohde-schwarz.com
			<b>Syria</b>	Electro Scientific Office Baghdad Street Dawara Clinical Lab. Bldg P.O.Box 8162 Damascus	(Tel) +963 (11) 231 59 74 (Fax) +963 (11) 231 88 75 memo@hamshointl.com

# Adressen/Addresses

<b>Taiwan</b>	Rohde & Schwarz Taiwan (Pvt.) Ltd. Floor 14, No. 13, Sec. 2, Pei-Tou Road Taipei 112	(Tel) +886 (2) 28 93 10 88 (Fax) +886 (2) 28 91 72 60 celine.tu@rstw.rohde-schwarz.com	<b>United Kingdom</b>	Rohde & Schwarz UK Ltd. 3000 Manchester Business Park Aviator Way Manchester M22 5TG	(Tel) +44 (870) 735 16 42 (Fax) +44 (1252) 81 14 77 sales@rsuk.rohde-schwarz.com
<b>Tanzania</b>	SSTL Group P.O. Box 7512 Dunga Street Plot 343/345 Dar Es Salaam	(Tel) +255 (22) 276 00 37 (Fax) +255 (22) 276 02 93 sstl@ud.co.tz	<b>Uruguay</b>	Aeromarine S.A. Cerro Largo 1497 11200 Montevideo	(Tel) +598 (2) 400 39 62 (Fax) +598 (2) 401 85 97 cs@aeromarine.com.uy
<b>Thailand</b>	Rohde & Schwarz International Thailand 2nd floor Gems Tower Bangrak, Suriyawong Bangkok 10600	(Tel) +66 (2) 200 07 29 (Fax) +66 (2) 267 00 79	<b>USA</b>	Rohde & Schwarz, Inc. Eastern Regional Office (US Headquarters) 8661A Robert Fulton Drive Columbia, MD 21046-2265	(Tel) +1 (410) 910 78 00 (Fax) +1 (410) 910 78 01 info@rsa.rohde-schwarz.com
	Schmidt Electronics (Thailand) Ltd. Messtechnik 202 Le Concorede Tower, 23rd Fl. Ratchadaphisek Rd. Huay kwang Bangkok 10320	(Tel) +66 (2) 69 41 47 05 (Fax) +66 (2) 69 41 47 06 salestm@schmidtelectronics.com		Rohde & Schwarz, Inc. Central Regional Office / Systems & EMI Products 8080 Tristar Drive Suite 120 Irving, TX 75063	(Tel) +1 (469) 713 53 00 (Fax) +1 (469) 713 53 01 info@rsa.rohde-schwarz.com
	TPP Operation Co. Ltd. Kommunikationstechnik 41/5 Mooban Tarinee Boromrajchonnee Road Talingchan Bangkok 10170	(Tel) +66 (2) 880 93 47 (Fax) +66 (2) 880 93 47		Rohde & Schwarz, Inc. R&D and Application Support 8905 SW Nimbus Ave Suite 240 Beaverton, OR 97008	(Tel) +1 (503) 403 47 00 (Fax) +1 (503) 403 47 01 info@rsa.rohde-schwarz.com
<b>Trinidad &amp; Tobago</b>	siehe/see Mexico	(Tel) (Fax)		Rohde & Schwarz, Inc. Western Regional Office 7700 Irvine Center Drive Suite 100 Irvine, CA 92618	(Tel) +1 (949) 885 70 00 (Fax) +1 (949) 885 70 01 info@rsa.rohde-schwarz.com
<b>Tunisia</b>	Teletek 71, Rue Alain Savary Residence Alain Savary (C64) Cit� el Khadra 1003 Tunis	(Tel) +216 (71) 77 33 88 (Fax) +216 (71) 77 05 53 teletek@gnet.tn		Rohde & Schwarz, Inc. Service & Calibration Center 8661A Robert Fulton Drive Columbia, MD 21046-2265	(Tel) +1 (410) 910 50 02 (Fax) +1 (410) 910 79 31 service.rsa@rsa.rohde-schwarz.com
<b>Turkey</b>	Rohde & Schwarz International GmbH Liaison Office Istanbul Bagdat Cad. 191/3, Arda Apt. B-Blok 81030 Selamicesme-Istanbul	(Tel) +90 (216) 385 19 17 (Fax) +90 (216) 385 19 18 nadir.guerelman@rsd.rohde-schwarz.com	<b>Vietnam</b>	Rohde & Schwarz Representative Office Vietnam Unit 807, 8/F, Schmidt Tower 239 Xuan Thuy Road Cau Giay District Hanoi	(Tel) +84 (4) 834 20 46
<b>Ukraine</b>	Rohde & Schwarz Representative Office Kiev 4, Patris Loumoumba ul. 01042 Kiev	(Tel) +38 (044) 268 60 55 (Fax) +38 (044) 268 83 64 rsbkiev@public.ua.net	<b>West Indies</b>	siehe/see Mexico	
<b>United Arab Emirates</b>	Rohde & Schwarz International GmbH Liaison Office Middle East Vertrieb P.O. Box 31156 Abu Dhabi	(Tel) +971 (2) 6335 670 (Fax) +971 (2) 6335 671 Dario Barisoni@rsd.rohde-schwarz.com			
	Rohde & Schwarz Bick Mobile Communication P.O.Box 17466 JAFZ, PPU ZG-07 Dubai	(Tel) +971 (4) 883 71 35 (Fax) +971 (4) 883 71 36			
	Rohde & Schwarz Emirates L.L.C. ESNAAD Premisses at Mussafah, P.O.Box 31156 Abu Dhabi	(Tel) +971 (2) 55 49 411 (Fax) +971 (2) 55 49 433 rsuaeam@emirates.net.ae			
<b>United Kingdom</b>	Rohde & Schwarz UK Ltd. Ancells Business Park Fleet Hampshire GU51 2UZ	(Tel) +44 (1252) 81 88 88 (sales)+44 (1252) 81 88 18 (service) (Fax) +44 (1252) 81 14 47 sales@rsuk.rohde-schwarz.com			







**ROHDE & SCHWARZ**  
EC Certificate of Conformity



Certificate No.: 99042

This is to certify that:

Equipment type	Order No.	Designation
SMR20	1104.0002.20	Signal Generator 1 to 20 GHz
SMR27	1104.0002.27	Signal Generator 1 to 27 GHz
SMR30	1104.0002.30	Signal Generator 1 to 30 GHz
SMR40	1104.0002.40	Signal Generator 1 to 40 GHz
SMR50	1134.9008.50	Signal Generator 1 to 50 GHz
SMR60	1134.9008.60	Signal Generator 1 to 60 GHz
SMR-B1	1104.5485.02	Option: Reference Oscillator OCXO
SMR-B5	1104.3501.02/.03	Option: AM/FM/SCAN Modulator
SMR-B11	1104.4250.02	Option: Frequency Extension
SMR-B15	1104.4989.02	Option: RF Attenuator 20 GHz
SMR-B17	1104.5233.02	Option: RF Attenuator 40 GHz
SMR-B19	1104.6281.02	Option: Rear Connector
SMR-B20	1104.6381.02	Option: Rear Connector
SMR-B23	1104.5804.02	Option: IF Input 20 GHz
SMR-B25	1135.1998.02	Option: IF Input 0,04 to 6 GHz

complies with the provisions of the Directive of the Council of the European Union on the approximation of the laws of the Member States

- relating to electrical equipment for use within defined voltage limits  
(73/23/EEC revised by 93/68/EEC)
- relating to electromagnetic compatibility  
(89/336/EEC revised by 91/263/EEC, 92/31/EEC, 93/68/EEC)

Conformity is proven by compliance with the following standards:

EN61010-1 : 1993 + A2 : 1995  
EN55011 : 1998 + A1 : 1999  
EN61326-1 : 1997 + A1 : 1998

For the assessment of electromagnetic compatibility, the limits of radio interference for Class B equipment as well as the immunity to interference for operation in industry have been used as a basis.

Affixing the EC conformity mark as from 1999

**ROHDE & SCHWARZ GmbH & Co. KG**  
Mühldorfstr. 15, D-81671 München

Munich, 2002-08-30

Central Quality Management FS-QZ / Becker







## General Overview of Manuals

### Operating Manual for Microwave Signal Generator SMR

This operating manual provides you with all the information necessary for putting into operation, manual and remote control as well as repair of Microwave Signal Generator SMR and also contains specifications of the instrument and available options.

**The following models are described in this manual:**

SMR20	1 GHz to 20 GHz (10 MHz to 20 GHz with Option SMR-B11)
SMR27	1 GHz to 27 GHz (10 MHz to 27 GHz with Option SMR-B11)
SMR30	1 GHz to 30 GHz (10 MHz to 30 GHz with Option SMR-B11)
SMR40	1 GHz to 40 GHz (10 MHz to 40 GHz with Option SMR-B11)

**The contents of the chapters are as follows:**

<b>Data sheet</b>	informs you about guaranteed specifications relating to functions and characteristics of the instrument and its options.
<b>Chapter 1</b>	contains all information about putting into operation (unpacking, connection to AC supply, switching on and off), functional testing and installation of the instrument, preset settings and views of the front and rear panel showing the controls and connectors needed for operation.
<b>Chapter 2</b>	presents a brief introduction and typical settings to users working with the SMR for the first time.
<b>Chapter 3</b>	describes manual control of the microwave signal generator, for example calling up of menus, selection and editing of parameters, use of the list editor and the SAVE/RECALL function. This chapter also contains an overview of menus showing the functions available for the instruments and its options.
<b>Chapter 4</b>	describes the functions of the instrument and its options which can be activated manually via menus or by remote control (frequency and level setting, analog and digital modulation, sweep, list mode, memory sequence and general functions not directly related to signal generation).
<b>Chapter 5</b>	provides basic information on remote control, for example on the IEC/IEEE bus, RS232C interface, interface and device messages, command processing, status reporting system, etc.
<b>Chapter 6</b>	contains for each command system an overview and description of all commands available for the instrument and its options as well as an alphabetical list of all commands.
<b>Chapter 7</b>	includes programming examples for remote control.
<b>Chapter 8</b>	gives information on preventive maintenance, for example for keeping the exterior clean, storage, etc.
<b>Chapter 9</b>	contains the SCPI-specific and device-specific error messages displayed on the instrument.
<b>Chapter 10</b>	includes the index.

### Service Manual Instrument for Microwave Signal Generator SMR

The service manual instrument for Microwave Signal Generator SMR provides information on the checking of rated characteristics, manual and electronic adjustment, repair (fault diagnosis, module replacement), and the fitting of options. Moreover, it includes documentation such as spare parts list, basic circuit diagram, block diagram, etc.



# 1 Putting into Operation

This chapter contains all information about putting into operation (unpacking, connection to AC supply, switching on and off), functional testing and installation of the instrument, preset settings and views of the front and rear panel showing the controls and connectors needed for operation.

## General Instructions

Before putting the SMR into operation, please make sure that

- the covers of the casing are put on and screwed,
- the ventilation openings are free,
- no signal voltage levels exceeding the permissible limits are applied at the inputs,
- the outputs of the instrument are not overloaded or connected incorrectly.

If these points are not observed, the instrument might be damaged.

## Unpacking the Instrument

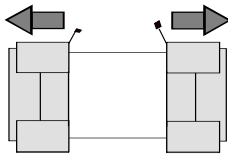

remove protective caps

- Take the instrument out of the shipping box and check whether the items listed in the packing list and in the lists of accessories are all included.
- Remove the two protective caps from the front and rear of the SMR and carefully check the instrument for damage.

Should the instrument be damaged, immediately notify the forwarder who shipped the instrument to you and keep the box and packing material.

For further transport or shipment of the SMR the original packing should also be used. It is recommended to keep at least the two protective caps for front and rear side in order to prevent damage to the controls and connectors.

## Supply Voltage

The SMR can be operated at a.c. systems from 100 to 120 V and 200 to 240 V at system frequencies from 50 to 60 Hz. The power supply socket is situated at the rear of the instrument. The instrument automatically sets itself to the voltage applied within the permissible voltage ranges. It is not necessary to set the instrument to a certain supply voltage.

## How to Ensure EMC

In order to avoid electromagnetic interference, the instrument may only be operated when it is closed and with all shielding covers fitted. Only appropriate shielded signal and control cables may be used.

## Power Fuses

The SMR is protected against short circuits by means of two fuses according to nameplate of the power supply. The fuses are situated in the draw-out fuse holder which is inserted close to the power supply socket (see below).

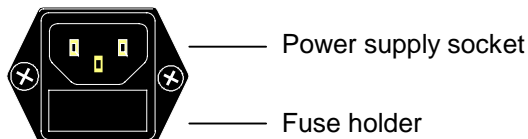

Power supply socket at the rear of the instrument

## Switching On/Off the Instrument

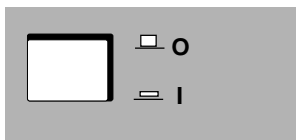

- Switch on: ➤ Press switch.  
The instrument is ready for operation.
- Switch off: ➤ Release switch.

On/Off switch at the front of the instrument

## Initial Status

Upon switching on, the instrument automatically assumes the status which was set when it was switched off.

If the instrument need not to be operated from the initial status any further, a defined default status should be established by pressing the [PRESET] key prior to further settings.

### Frequency accuracy after switching on when the oven-controlled reference oscillator is fitted (option SMR-B1)

The reference oscillator needs some minutes of warm-up time to reach its nominal frequency. During this period of time, the output frequency does not yet reach its final value either. In the status line in the header field of the display the message "OVEN COLD" is displayed for this time.

## RAM With Battery Back-Up

The SMR has a static read-write memory (CMOS-RAM) with battery back-up, in which 50 different complete settings of the instrument can be stored (cf. Chapter 3, section "Storing and Calling of Instrument Settings"). In addition, all data and/or lists the user enters himself, such as for list mode, memory sequence, and user correction of the level, are stored in the RAM. Further, all data of the calibrations running within the instrument in the SMR are stored in the RAM (cf. Chapter 4, section "Calibration" and Service Manual Instrument).

A lithium battery with a service life of approx. 5 years serves to supply the RAM with power. When the battery is discharged, the data stored will be lost. Exchanging the battery is described in the Service Manual Instrument.

## Preset Setting

A defined setting status is achieved by pressing the [PRESET] key.

### Preset Status:

RF frequency	10 GHz
RF level	-30 dBm (-20 dBm without option SMR-B15/SMR-B17, Attenuator)
Reference frequency	internal, adjustment off
Offsets	0
Modulations	switched off
Transient-free level setting	switched off, level attenuator mode: Auto
Internal level control	level Alc: On
User correction	level Ucor: Off
LF output	switched off
Sweep	switched off
List mode	switched off
Memory sequence	switched off
Suppression of indications	system security: unaltered
Protection of calibration data	protection lock: unaltered
Settings stored	unaltered
Data, lists etc. stored	unaltered
IEC-bus address	unaltered

All parameters and circuit states, even those of operating modes which are not activated, are preset by means of Preset.

The presettings going beyond the above list can be seen from the menu representations as of Chapter 4 which each indicate the Preset setting status.

## Functional Test

On switching on the instrument and permanently during operation, the SMR carries out a self test. The ROM contents as well as the battery of the non-volatile RAM are checked. The most important instrument functions are automatically monitored during operation.

If an error is detected, the message "ERROR" is displayed in the status line. For further identification of the error, press the [ERROR] key. Thereupon a description of the error is displayed (cf. Chapter 9, section "Error Messages"). Return to the menu exited by pressing the [BACK] key.

If required, internal test points can be polled by the user and the results be read out and displayed. Cf. Service Manual Instrument.

## Mounting into a 19" Rack

**Caution:** *Ensure free air inlet at the perforation of the side walls and air outlet at the rear of the instrument in rack mounting.*

The SMR can be mounted into a 19" rack by means of rack adapter ZZA-94 (stock no. 396.4905.00). The mounting instructions are attached to the adapter.

## Explanation of Front and Rear Panel

### Elements of the Front Panel

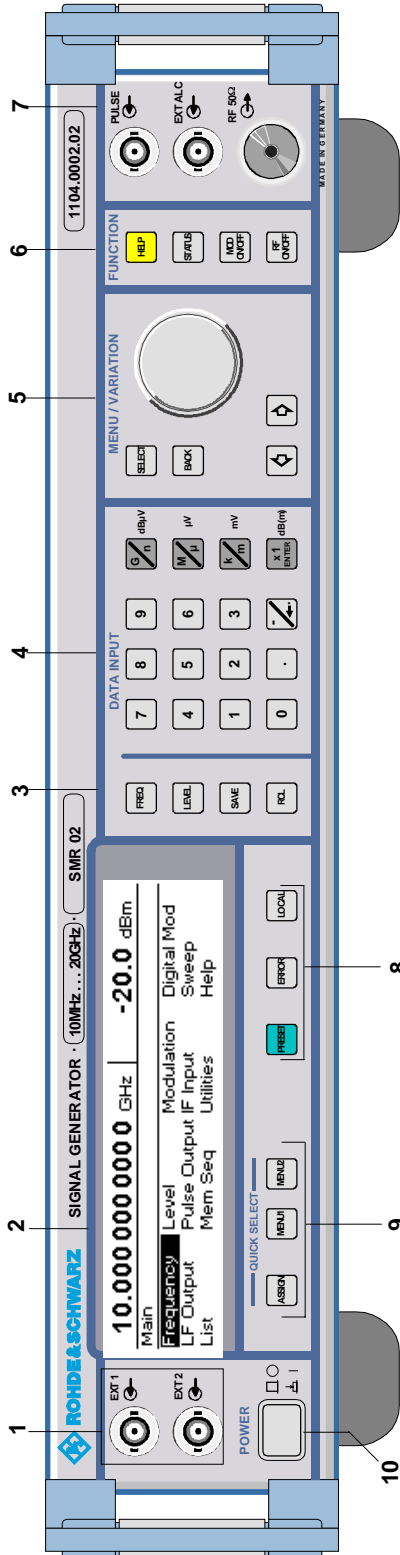

Fig. 1-1 Front panel view

#### 1



EXT1 Input external modulation signal alternatively for AM, FM, ASK and FSK.

EXT2 Input external modulation signal alternatively for AM and FM.

#### 2 DISPLAY

Cf. Chapter 3 for the design of the display.

#### 3

##### Parameter field



Parameters RF frequency and RF level can be entered directly by means of the parameter keys, alternatively to menu operation. Further, complete instrument settings can be stored and called.

**FREQ** Opens the setting of the RF frequency via value input or variation by means of a rotary knob. The current menu is maintained. Return to the menu by means of the [BACK] key. (Setting of the RF frequency also in the FREQUENCY menu).

**LEVEL** Opens the setting of the RF level via value input or variation by means of a rotary knob. The current menu is maintained. Return to the menu by means of the [BACK] key. (Setting of the RF level also in the LEVEL menu).

**SAVE** Opens the storing of the current instrument setting. Memory selection is effected by entering a number (1 to 50) and is finished by means of the [x1/ENTER] key.

**RCL** Opens the calling of an instrument setting stored. Memory selection is effected by entering a number (1 to 50) and is finished by means of the [x1/ENTER] key.

⇒ Cf. Chapter 3, Sections "Use of [FREQ] and [LEVEL] Keys", "RF Frequency", "RF Level" and "Storing and Calling of Instrument Settings".

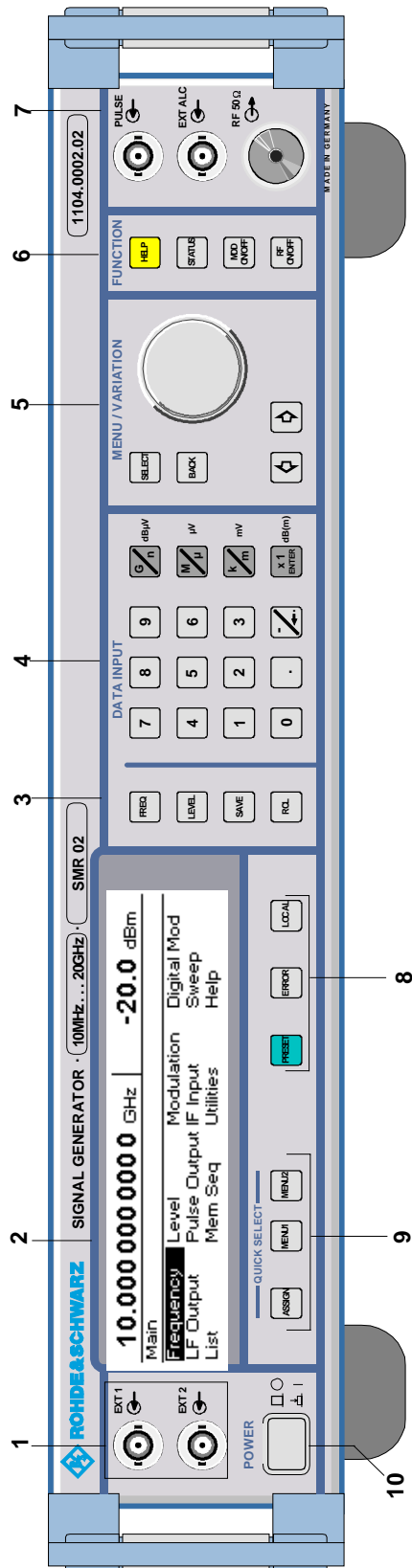
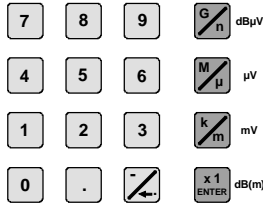

Fig. 1-1 Front panel view

**4 DATA INPUT**

**Numeric input field**



Numeric values, decimal point and minus sign can be entered by means of the digital keys.

- 0...9 Enters the digit.
- . Enters the decimal point
- /← Enters the minus sign.
- ← Deletes the last input (digit, sign or decimal point)
- key [BACKSPACE]

**Unit keys with enter function**



The unit keys terminate the input of values and specify the multiplication factor for the respective basic unit.

The basic units are displayed next to the input field while numbers are entered. In the case of level settings, the unit keys specify the unit.

- G/n dBμV Selects giga/nano, with RF level dBμV, with LF level dBu.
- M/μ μV Selects mega/micro, with level μV.
- k/m mV Selects kilo/milli, with level mV.
- 1x Enter dB(m) Terminates entries in the basic unit and value inputs without unit. Selects with level dBm.
- ← Selects with level offset and level step width dB.

In order to change to another level unit, simply press the unit key desired. Parameter LEVEL must be activated, e.g. by pressing the [LEVEL] key.

⇒ Cf. Chapter 3, Section "Change Unit of Level".



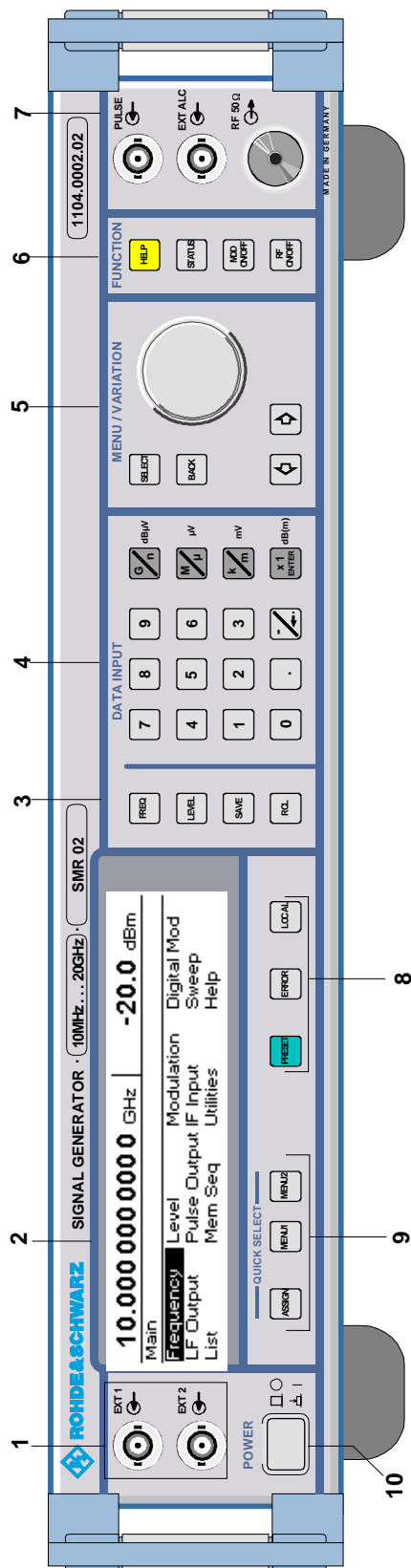

Fig. 1-1 Front panel view

**5 MENU/VARIATION**



**Menu keys**

The menu keys access the menus and settings within the menus.

**SELECT** Acknowledges the choice marked by the menu cursor.

**BACK** Returns the menu cursor to the next higher menu level.

← Moves the digit cursor to the left by one position in the marked value indication. Moves the menu cursor to the left by one position in a 1-out-of-n selection.

→ Moves the digit cursor to the right by one position in the marked value indication. Moves the menu cursor to the right by one position in a 1-out-of-n selection.



**Rotary knob**

The rotary knob moves the menu cursor over the positions of a menu level to choose from, or varies the value of a parameter. The variation is either effected in steps of one or in a step width that can be specified at will.

Furthermore, by pressing the rotary knob when the cursor marks a menu position, the lower menu level or the setting menu is displayed (cf. function of [SELECT] key).

⇒ Cf. Chapter 2, Section "Sample Setting for First Users" and Chapter 3, Section "Basic Operating Steps".

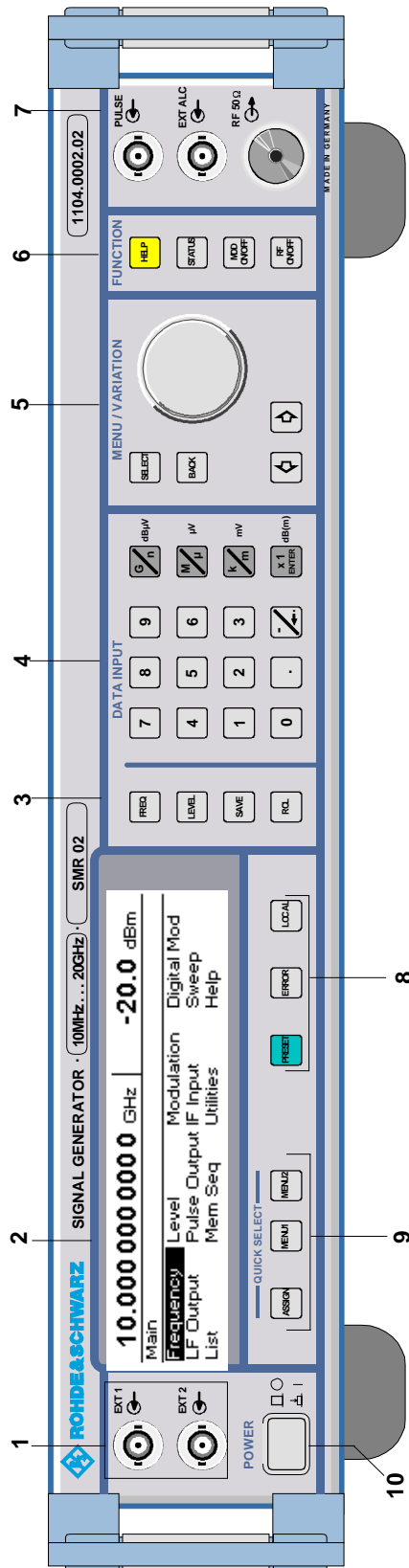
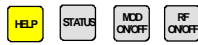

Fig. 1-1 Front panel view

**6 FUNCTION**



- HELP\* Indicates context-sensitive auxiliary text.
- STATUS\* Indicates the instrument status.
- MOD ON/OFF Switches on/off the modulation selected in Utilities - ModKey.
- RF ON/OFF Switches on/off the RF signal.

⇒ Cf. Chapter 4, Sections "The Help System", "Status", and Chapter 3, Section "Use of [MOD ON/OFF] and [RF ON/OFF] keys".

\* Exit the menus using the [BACK] key.

**7**



- PULSE Input for triggering the pulse generator or for direct control of the pulse modulation.
- EXT ALC Input detection voltage of an external level detector.
- RF 50 Ω Output RF signal.

⇒ Cf. Chapter 4, Section "Switch On/Off Internal Level Control", Section "Pulse Modulation" and Section "[RF ON/OFF] Key".

**8**



- PRESET Establishes a defined instrument status.
- ERROR\* Indicates error and caution messages.
- LOCAL Switches the instrument from the REMOTE mode (remote control) to the LOCAL mode (manual control).

⇒ Cf. Chapter 1, Section "Preset Settings", Chapter 9, "Error Messages" and Chapter 6, "Remote Control".

\* Exit the menus using the [BACK] key.

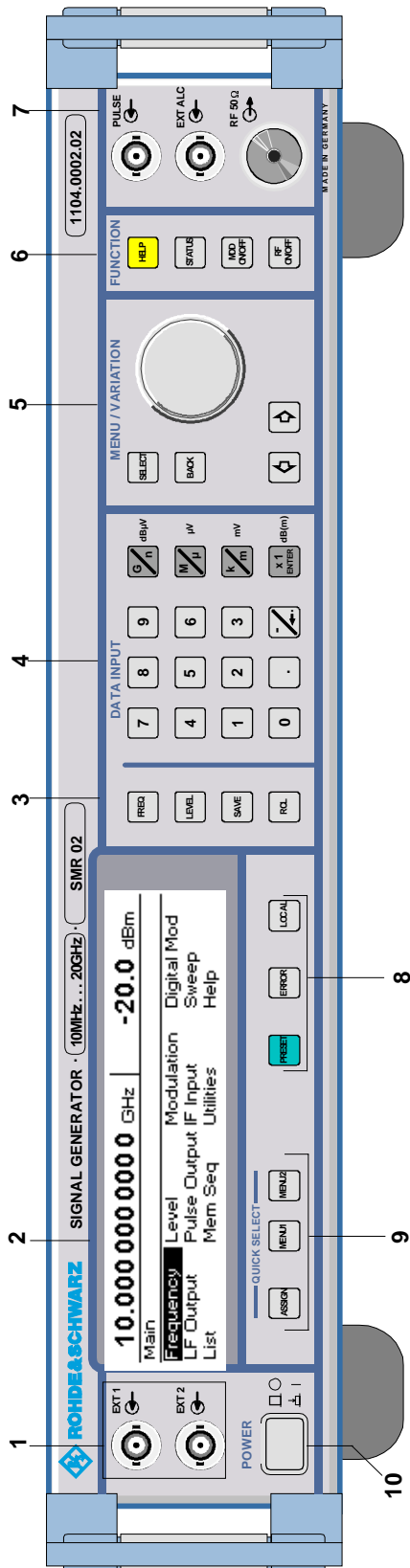

Fig. 1-1 Front panel view

### 9 QUICK SELECT



The menu-quick-selection keys permit fast access to two menus selected.

**ASSIGN** Stores the current menu as menu1 when the MENU1 key is pressed afterwards or as menu2 when the MENU2 key is pressed afterwards.

**MENU1** Activates menu1 stored.

**MENU2** Activates menu2 stored.

⇒ Cf. Chapter 3, Section "Quick Selection of Menu (QUICK SELECT)".

### 10 ON/OFF SWITCH

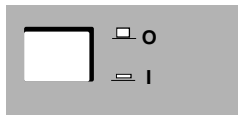

The On/Off switch switches the instrument on ("I") or off ("O").

For this it is necessary that the power supply switch on the rear of the instrument be set to On.

⇒ Cf. Chapter 1, Section "Switching On/Off the Instrument".



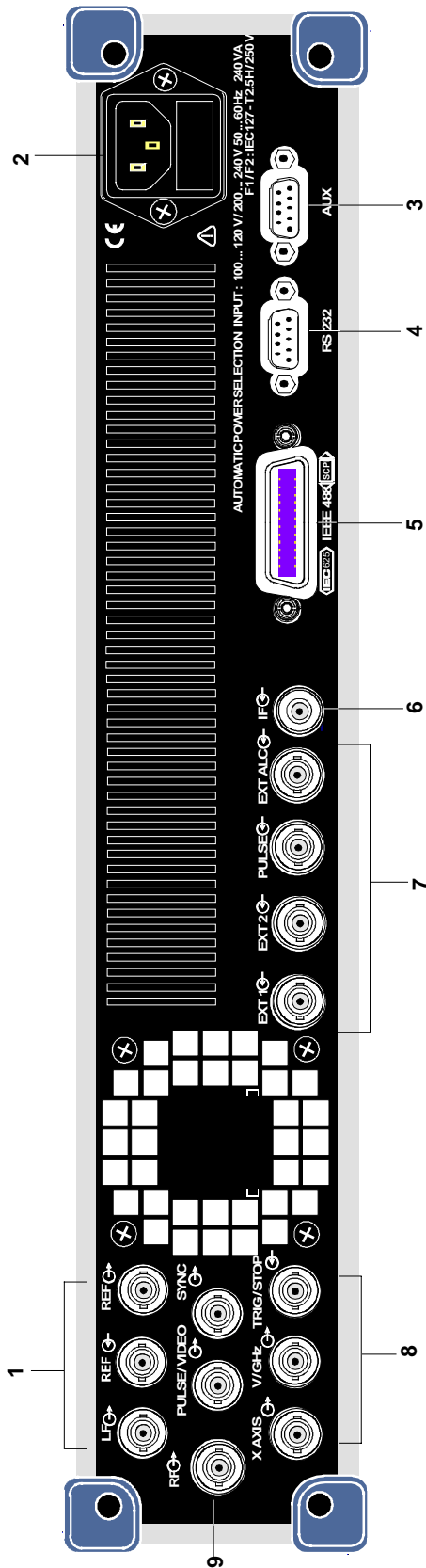
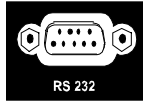

Fig. 1-2 Rear panel view

4



**RS-232** RS-232-C interface used for software update and remote control. The pin assignment corresponds to the pin assignment of a PC.

⇒ Cf. Chapter 5, Section "Interface RS-232-C".

5

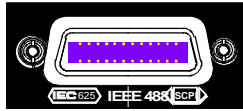

**IEC 625** IEC-bus (IEEE 488)  
**IEEE 488** Interface for Remote Control

⇒ Cf. Chapter 5 "Remote Control".

6



**IF** input for DC...700 MHz (only with Option SMR-B23/-SMR-B24).

7

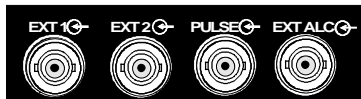

**EXT1** Relocation of EXT1 input from the front to the rear panel of the instrument. Only with option SMR-B19/SMR-B20.

**EXT2** Relocation of EXT2 input from the front to the rear panel of the instrument. Only with option SMR-B19/SMR-B20.

**PULSE** Relocation of PULSE input from the front to the rear panel of the instrument. Only with option SMR-B19/SMR-B20.

**EXT ALC** Relocation of EXT ALC input from the front to the rear panel of the instrument. Only with option SMR-B19/SMR-B20.





## 2 Short Tutorial



The present chapter contains a short tutorial with sample settings allowing the users to operate immediately the instrument.

### Sample Setting for First Users

#### Setting frequency and level of the RF output signal

First frequency and level of the RF output signal are set via keys [FREQ] and [LEVEL] in the DATA INPUT field:

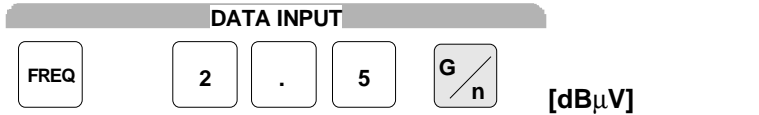
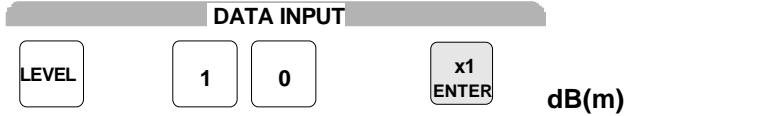
- frequency      2.5 GHz
- level            10 dBm









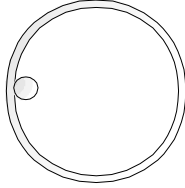

Operating steps	Explanations
	Reset the instrument to the defined state.
	Set the frequency to 2.5 GHz. The menu cursor marks the permanent frequency indication.
	Set the level to 10 dBm. The menu cursor marks the permanent level indication.
	Reset the menu cursor to the menu field.

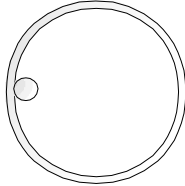

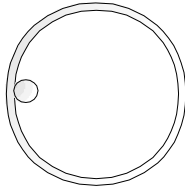
**AM modulation of the output signal**

The output signal is to be amplitude-modulated next.

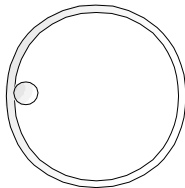
- AM modulation depth 15.5 %
- AM signal 3-kHz sine

Operating steps		Explanations
<p><b>MENU / VARIATION</b></p>  <p style="text-align: center;">. Modulation .</p> <p><b>MENU / VARIATION</b></p> 	<p>Select menu Modulation using rotary knob.</p> <p>Press [SELECT] key or rotary knob. The submenu is displayed.</p>	
<p><b>MENU / VARIATION</b></p>  <p style="text-align: center;">. AM .</p> <p><b>MENU / VARIATION</b></p> 	<p>Select submenu AM.</p> <p>Press [SELECT] key or rotary knob. The AM setting menu is displayed.</p>	
<p><b>MENU / VARIATION</b></p>  <p style="text-align: center;">. AM Depth .</p> <p><b>MENU / VARIATION</b></p> 	<p>Select parameter AM Depth using rotary knob.</p> <p>Press [SELECT] key or rotary knob. The menu cursor marks the setting value.</p>	
<p style="text-align: center;"><b>DATA INPUT</b></p> 	<p>Enter modulation depth 15.5 % and acknowledge using [x1/Enter] key.</p>	
	<p>Reset menu cursor to AM Depth using [BACK] key.</p>	
<p><b>MENU / VARIATION</b></p>  <p style="text-align: center;">. AM Source .</p> <p><b>MENU / VARIATION</b></p> 	<p>Select AM Source using rotary knob.</p> <p>Press [SELECT] key or rotary knob. A pop-up menu displays the current 1-out-of-n selection.</p>	

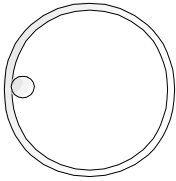
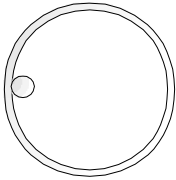
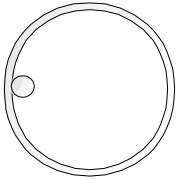



Operating steps	Explanations
<p>MENU / VARIATION</p>  <p style="text-align: center;">· LFGen ·</p> <p>MENU / VARIATION</p> <p style="text-align: center;">SELECT</p>	<p>Select LF generator as modulation source using rotary knob.</p> <p>The selection mark marks LFGen.</p> <p>Press [SELECT] key or rotary knob.</p> <p>The cursor is set back to AM Source.</p>
<p>MENU / VARIATION</p>  <p style="text-align: center;">· LFGen Freq ·</p> <p>MENU / VARIATION</p> <p style="text-align: center;">SELECT</p>	<p>Select parameter LFGen Freq using rotary knob.</p> <p>Press [SELECT] key or rotary knob.</p> <p>The menu cursor marks the current frequency selection.</p>
<p>MENU / VARIATION</p>  <p style="text-align: center;">· 3k ·</p> <p>MENU / VARIATION</p> <p style="text-align: center;">SELECT</p>	<p>Set the frequency of the LF generator to 3 kHz.</p> <p>The selection mark marks 3 kHz.</p> <p>Press [SELECT] key or rotary knob.</p> <p>The AM modulation setting is completed.</p> <p>The indications on the display are represented in Fig. 2-1.</p>

<b>10.0000000000</b> GHz	<b>-20.0</b> dBm
Modulation/AM	
AM Depth	30.0 %
AM Source	Off
Scan State	Off
Ext1 Coupling	AC
Ext2 Coupling	AC
Ext1 Impedance	100 KΩ
Ext2 Impedance	100 KΩ
Lfgen Freq	1.0000 kHz
Lfgen Shape	Sin
Back ↵	

Fig. 2-1 Display for AM setting

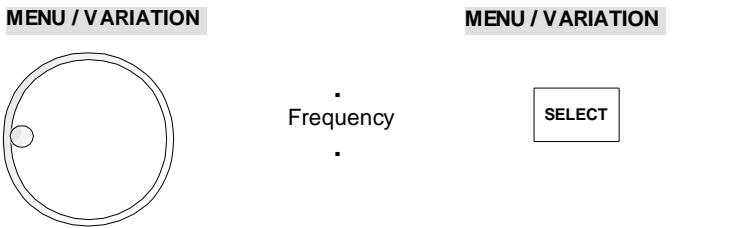
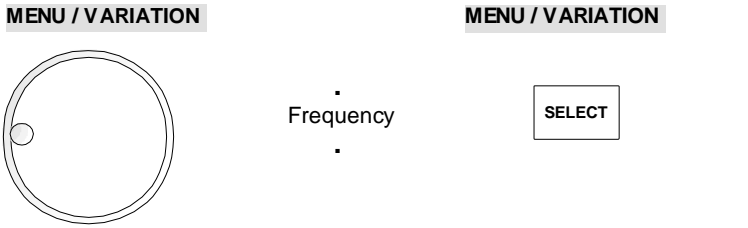
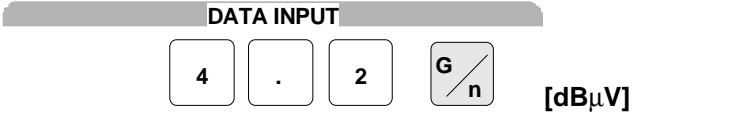
Setting the step width

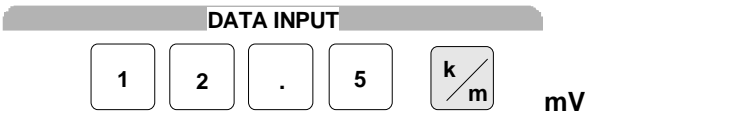
Subsequently to the above setting, 4.2 GHz as new RF frequency and 12 kHz as the step width for the RF frequency variation are set in the following.

Operating steps	Explanations
	Reset the menu cursor to the main menu in 3 steps.
	Select menu Frequency using rotary knob. Press [SELECT] key or rotary knob. The frequency setting menu is displayed.
	Select parameter Frequency. Press [SELECT] key or rotary knob. The menu cursor marks the setting value.
	Enter frequency 4.2 GHz. Press [SELECT] key or rotary knob. The menu cursor is set back to Frequency.
	Select parameter Knob Step User using rotary knob. Press [SELECT] key or rotary knob.
	Enter step width 12 kHz.
	Press [SELECT] key or rotary knob. The menu cursor is set back to Knob Step User.

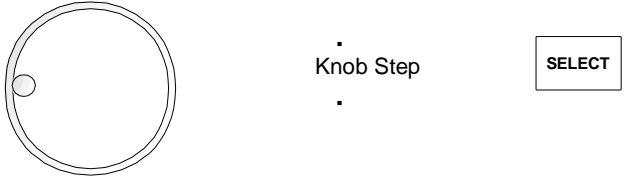
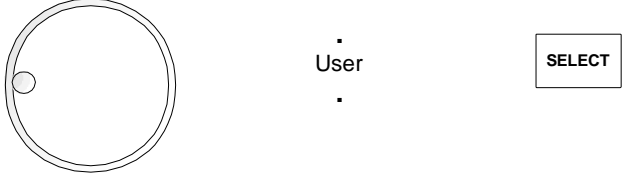
Operating steps	Explanations
<p>MENU / VARIATION</p>  <p>MENU / VARIATION</p> <p>Knob Step</p> <p>SELECT</p>	<p>Select parameter Knob Step using rotary knob. Press [SELECT] key or rotary knob.</p> <p>A pop-up menu displays the available settings.</p>
<p>MENU / VARIATION</p>  <p>MENU / VARIATION</p> <p>User</p> <p>SELECT</p>	<p>Select User (user-defined step width) using rotary knob.</p> <p>This results in step width 12 kHz being used in the case of variation using the rotary knob.</p> <p>Press [SELECT] key or rotary knob. The menu cursor is set back to Knob Step.</p>

10.0000000000 GHz	-20.0 dBm
Frequency	
Frequency	10.0000000000 GHz
Offset	0.0 Hz
Multiplier	1.0
Knob Step User	1.0000000 MHz
Knob Step	Decimal
Exclude from Recall	Off
Back ↵	

Fig. 2-2 Display for pattern setting



### 3 Manual Operation

This chapter shows the design of the display and describes the manual control of the microwave signal generator, for example calling up of menus, selection and editing of parameters, use of the list editor and the SAVE/RECALL function. This chapter also contains an overview of menus showing the functions available for the instruments and its options.

It is useful to read the sample settings for first users in Chapter 2, "Short Tutorial".

#### Design of the Display

(1)	10.000 000 0000 GHz		-20.0 dBm	
(2)	Main			
(3)	Frequency	Level	Modulation	Digital Mod
	LF Output	Pulse Output	IF Input	Sweep
	List	Mem Seq	Utilities	Help

Fig. 3-1 Design of the display

- (1) Header field** The header field of the display indicates frequency and level of the RF output signal. In the RF-sweep operating mode, the start and stop frequencies are displayed in two lines one above the other. The start and stop levels are indicated in the LEVEL-sweep operating mode correspondingly.
- (2) Status line** The status line indicates at the left the menu path of the current menu and at the right the operating mode and operating state of the instrument. Error messages and notes for caution are also displayed in the status line.
- (3) Menu fields** The indication fields below the status line are reserved for the menu representations. The image contents of these fields change as a function of the menu selected.
- The lowest menu level shows the setting menu with the current settings of the selected menu. Settings are made in select or input windows which open when the current setting is activated.
- Menu cursor The menu cursor shows the user at which position in the menu he is. The position of the menu cursor is evident from the inverse notation of the term (white characters on a black background).
- Digit cursor As a bright field, the digit cursor marks the position which can be varied by means of the rotary knob in a value indication.

## Basic Operating Steps

To operate the instrument, menus are called in the display. All setting possibilities and the current setting status are evident from the menus. All settings can be made by accessing the menus. RF frequency and RF level can also be set without menu operation using keys [FREQ] and [LEVEL]. RF signal and modulation can also be switched on/off without menu operation using keys [RF ON/OFF] and/or [MOD ON/OFF].

### Calling the menus

Accessing the menus is effected using rotary knob [VARIATION], [SELECT] key and [BACK] key.

**Rotary knob** Rotary knob [VARIATION] moves the menu cursor over the positions of a menu level to be selected.

If a scrollbar is visible at the right-hand margin of a menu, the menu is larger than the screen window. If the menu cursor is moved to the margin of the screen window, the covered lines become visible.

If the rotary knob is pressed after a position has been selected, the lower menu level or the respective settings are called. The rotary knob hence has the same function as the [SELECT] key.

If the rotary knob is pressed while [BACK] is selected, the menu cursor wraps back to the menu last called.

**[SELECT] key** The [SELECT] key acknowledges the selection marked by means of the menu cursor. Depending on the position, the next lower menu level or the the respective setting is called.

**[BACK] key** The [BACK] key

- returns the menu cursor to the next higher menu level; the menu cursor is shifted to the left into the preceding column of the menu structure,
- resets the menu cursor from frequency or level value indication in the header field into the menu field to the menu called last,
- closes the display pages called using keys [STATUS], [HELP] and [ERROR] again.

Settings are accessed in the setting menus ending with the right-hand display margin.

10.000000000 GHz		-20.0 dBm	
Modulation/AM			
AM Depth		30.0 %	
AM Source		Off	
Scan State		Off	
Ext1 Coupling		AC	
Ext2 Coupling		AC	
Ext1 Impedance		100 KΩ	
Ext2 Impedance		100 KΩ	
Lfgen Freq		1.0000 kHz	
Lfgen Shape		Sin	
Back ↵			

Fig. 3-2 Modulation - AM Menu

## Selection and Change of Parameters

**Select parameter** ➤ Set the menu cursor to the name of the parameter desired using the rotary knob, e.g. to AM Depth in the AM menu, cf. Fig. 3-2.

**Change setting value** ➤ Select parameter.  
➤ Press [SELECT] key or rotary knob.  
The menu cursor changes from the parameter selected in the left-hand column of the setting menu to the setting value on the right, e.g. from AM Depth to 30%, cf. Fig. 3-2.

Via value inputs ➤ Press the first digit of the new value or minus sign.  
The old value is deleted, the entry is indicated in the marked field.  
➤ Enter further digits.  
➤ Terminate the input using a unit key or, in the case of inputs in the base unit or in the case of inputs without unit, using the [1x/Enter] key.  
➤ Press [BACK] key or mark selection BACK using rotary knob and then press rotary knob.  
The menu cursor wraps back to the appropriate parameter.

Using rotary knob ➤ Set the digit cursor (bright field) to the position of the setting value to be varied using keys [⇒] [⇐].  
➤ Turn rotary knob.  
The value is varied in steps of 1.

**Note:** *RF frequency and RF level can also be varied in a step width which can be defined arbitrarily, using the rotary knob. In the respective setting menu (Frequency or Level), the step width is entered as Knob Step User and the Knob Step set from Decimal to User. To point to the fact that the step width has been converted to the value programmed, the bright field as a symbol of the digit cursor disappears in the respective value indication.*



- 1-out-of-n selection**
- Select parameter.
  - Press [SELECT] key or rotary knob.  
A pop-up menu displays a selection of settings.
  - Set the menu cursor to the position desired within the 1-out-of-n selection using the rotary knob or cursor keys [←] [→].
  - Press [SELECT] key or rotary knob.  
The setting is made.  
The pop-up menu is closed and the current setting is indicated at the right margin of the display.
  - Press [BACK] key or mark selection BACK using rotary knob and then press rotary knob.  
  
The menu cursor wraps back to the next higher menu level.

### **Quick Selection of Menu (QUICK SELECT)**

The keys of the QUICK SELECT control field are used to call selected menus quickly by one keystroke.

- Store menus**
- Establish the desired operating status of the current menu.
  - Press [ASSIGN] key.
  - Press [MENU1] or [MENU2] key.  
The current menu is stored as menu1 or menu2. That is to say, 2 menus can be stored in total.
- Call menus**
- Press [MENU1] or [MENU2] key.  
Menu1 or menu2 stored is displayed. Exactly the operating status which was current at the point of time of storing is reconstructed.

## Use of [FREQ] and [LEVEL] Keys

RF frequency and RF level can be set without menu operation as well using direct keys [FREQ] and [LEVEL].

- [FREQ] / [LEVEL] keys**
- Press [FREQ] or [LEVEL] key.  
The frequency or the level indication in the header field of the display is marked. The current menu at the display is maintained.
  - Alter the value via a value input or the rotary knob.
  - Press [BACK] key or rotary knob.  
The menu cursor wraps to the position marked last in the menu.

## Use of [RF ON/OFF] and [MOD ON/OFF]

RF signal and modulation can be switched on/off without menu operation as well using keys [RF ON/OFF] and/or [MOD ON/OFF] (cf. Sections "[RF ON/OFF] Key" and "[MOD ON/OFF] Key").

- [RF ON/OFF] key**
- Press [RF ON/OFF] key.  
The RF output signal is switched on/off.  
IEC/IEEE-bus short command:       :OUTP:STAT ON

- [MOD ON/OFF] key**
- Press [MOD ON/OFF] key.  
Modulation is switched on/off.  
  
A direct IEC-bus command is not available. The modulations have to be switched on and off in the respective modulation submenus.

## Changing Unit of Level

For the level, the unit of the value set can be changed without a new value input.

- Change level unit**
- Activate Level parameter.
    - Press [LEVEL] key or
    - set menu cursor in the level menu to the setting value of the Amplitude parameter.
  - Press the unit key with with the desired level unit.  
The level is indicated in the desired unit.

**Correction of Input**

Digits can be corrected by one of the following keys before the input is confirmed by the [Enter] key:

**Key [-/←]** The backspace key deletes the value entered digit by digit. When the last digit is deleted, the previous value is displayed.

**[BACK] key** Pressing the [BACK] key deletes the entire entry and results in the previous value being indicated again.

For a subsequent new input in the setting menu, the menu cursor is to be set to the setting value again using the [SELECT] key.

For a subsequent new input via the [FREQ] or [LEVEL] keys, the respective key has to be pressed again.

**[FREQ]/[LEVEL] keys** In the case of a frequency or level input by means of the [FREQ] or [LEVEL] keys, pressing the [FREQ] and/or [LEVEL] key again deletes the entire input.

## List Editor

The SMR offers the facility of generating lists for automatic sequences (list mode, memory sequence) or for user-defined level correction (Ucor). The lists consist of elements (pairs of values) which are defined by an index and at least one parameter per index. Each list is assigned a separate name and selected by means of this name. Access to the lists is made in the associated menus. For example, sequences of frequency and level value pairs can be accessed in the List menu. How to generate and edit lists is explained in detail in this section by the example of the List mode (List menu, see Fig. 3-3).

Menu selection: List

10.0000000000 GHz		-20.0 dBm	
MemSeq			
Mode		Off	
Reset List			
Current Index		1	
Select List		MSeq0	
Delete List			
Edit List		Insert	
Back ↵			

Fig. 3-3 List menu

The settings for Mode, Reset List, Current Index etc are not relevant for the general description of the list editor. They are described in greater detail in chapter 4 in section "List Mode".

The Select List, Delete List and Edit List lines are always displayed. They are intended for the selection and deletion of lists and for the calling of editing functions.

**Select List** Opens a window in which a list out of 10 lists can be selected. In this line, the currently active list is displayed (see section "Select List").

**Delete List** Opens a window from which a list can be selected whose contents are to be deleted (see section "Delete List").

**Edit List** Selection of editing functions for list editing. When this item is selected, a pop-up menu with the following editing functions opens (see section "Edit List"):

- Insert** Insertion of elements into a list
- Fill** Filling of a list with elements
- Edit/View** Editing of individual elements of a list
- Delete** Deletion of elements of a list

## Select List

- Mark the desired list using the rotary knob (see Fig. 3-4).
- Press the [SELECT] key or the rotary knob.

The selected list is included in the instrument setup. The selection window is closed. The selected list is displayed under Select List.

Selection: Select List

11.000 000 0000 GHz		-20.0 dBm	
List/Select List			
List0	0000	List1	0000
List4	0000	List5	0000
List8	0000	List9	0000

Fig. 3-4 Select List window

**LIST0** The currently selected list, in this case List0, is marked in the selection window.

**0100** The length of the list, in this case 100 elements, is indicated in the column right of the list designation.

## Delete List

- Mark the desired list using the rotary knob (see Fig. 3-5).
- Press the [SELECT] key or the rotary knob.  
The following query will appear:  
"Are you sure? Press SELECT to confirm BACK to cancel".
- Press the [SELECT] key or the rotary knob.  
The contents of the list will be deleted. If the query is answered by pressing the [BACK] key, the contents of the list will be retained. The selection window is automatically closed upon answering the query.

Selection: Delete List

11.000 000 0000 GHz		-20.0 dBm	
List/Delete List			
List0	0000	List1	0000
List4	0000	List5	0000
List8	0000	List9	0000
		Back	↵

Fig. 3-5 Delete List window

## Edit List

When Edit List is selected, a pop-up menu with the editing functions opens.

### Insert editing function (see Fig. 3-6)

The Insert function inserts a desired number of elements with constant or linearly increasing/decreasing values ahead of the element with the indicated start index. All elements already existing from the start index are shifted so that they come at the end of the range of elements to be inserted.

Elements are inserted in a list according to the following procedure:

When Insert has been selected, the menu cursor is on the Insert At menu item.

- Press the [SELECT] key or the rotary knob.  
The menu cursor is on the value for At.
- Vary the index value by means of the rotary knob or enter an index value using the numerical keys and the [ENTER] key.
- Press the [SELECT] key or the rotary knob.  
The menu cursor is on the value for Range.
- Vary the Range value by means of the rotary knob or enter a value using the numerical keys and the [ENTER] key.
- Press the [SELECT] key or the rotary knob.  
The menu cursor is on the value for Start Frequency.
- Vary the start value for the frequency by means of the rotary knob or enter a value using the numerical keys and the [ENTER] key.
- Press the [SELECT] key or the rotary knob.  
The menu cursor is on the value for Increment Frequency.
- Vary the value of the increment by means of the rotary knob or enter a value using the numerical keys and the [ENTER] key.
- Press the [SELECT] key or the rotary knob.  
The menu cursor is on the value for Power.
- Vary the start value for the power by means of the rotary knob or enter a value using the numerical keys and the [ENTER] key.
- Press the [SELECT] key or the rotary knob.  
The menu cursor is on the value for Increment Power.
- Vary the value of the increment by means of the rotary knob or enter a value using the numerical keys and the [ENTER] key.
- The cursor is on Execute. Press the [SELECT] key or the rotary knob to execute the insertion. The menu cursor goes back to Edit List.

Upon pressing the [BACK] key, the editing window is exited without any change being made. The menu cursor goes back to Edit List.

Selection: Insert

100.000 0000 MHz		-10.0 dBm	
List/Insert			
Insert At		0001	
Range		0004	
Start Frequency		100.000 0000 MHz	
Increment Frequency		0.0 Hz	
Power		0.0 dBm	
Increment Power		0.0 dB	
Execute			
Back	←		

Fig. 3-6 Edit function Insert

<b>Insert At</b>	Input of start index.
<b>Range</b>	Number of elements to be inserted.
<b>Start Frequency</b>	Input of start value for the frequency.
<b>Increment Frequency</b>	Input of increment between two successive frequency values. If 0 is entered as an increment, identical values will be inserted.
<b>Power</b>	Input of start value for the power.
<b>Increment Power</b>	Input of increment between two successive power values. If 0 is entered as an increment, identical values will be inserted.
<b>Execute</b>	Starts the insertion. After the execution of the function, the menu cursor goes back to Edit List.

**Fill editing function** (see Fig. 3-7)

The Fill function overwrites a parameter with constant or linearly increasing/decreasing values within a defined range. If the [BACK] key is pressed, the editing window will be exited without any change being made.

If the fill range extends beyond the end of the list, the list is automatically extended.

Filling of a list is done in the same way as the insertion of elements in a list, see "Insert editing function".

Selection: Fill

100.000 0000 MHz		-10.0 dBm	
List/Fill			
Fill At		0001	
Range		0004	
Parameter		Frequency	
Start Frequency	100.0000000 MHz		
Increment Frequency	0.0 Hz		
Execute			
Back ↵			

Fig. 3-7 Fill editing function

<b>Fill At</b>	Input of start index.
<b>Range</b>	Number of elements to be included.
<b>Parameter</b>	Selection of parameters (frequency, power) to be filled. This menu option is not offered if a list contains only elements with one parameter.
<b>Start Frequency</b>	Input of start value for the selected parameter. This option is offered only if Frequency is selected as a parameter.
<b>Increment Frequency</b>	Input of increment between two successive values. If 0 is entered as an increment, the list will be filled with identical values. This option is offered only if Frequency is selected as a parameter.
<b>Power</b>	Input of start value for the selected parameter. This option is offered only if Power is selected as a parameter.
<b>Increment Power</b>	Input of increment between two successive values. If 0 is entered as an increment, the list will be filled with identical values. This option is offered only if Power is selected as a parameter.
<b>Execute</b>	Starts the filling procedure. After the execution of the function, the menu cursor goes back to Edit List.



**Edit/View editing function** (see Fig. 3-8)

The Edit/View function allows viewing of a complete list or editing individual values of a list.

If the cursor is on a value in the leftmost column of the list, the Edit/View mode can be exited by pressing the [BACK] key. The menu cursor goes back to Edit List.

There is no storage function for the list. This means that any modification of the list will be transferred to the internal data set and will be effective on exiting the Edit/View function.

Selection: Edit

11.000 000 0000 GHz		-20.0 dBm	
List/Edit			
0001	10.000 000 0000 GHz	0.0 dBm	List0
0002	10.100 000 0000 GHz	0.1 dBm	Free1900
0003	10.200 000 0000 GHz	0.2 dBm	Len 0100

Fig. 3-8 Edit editing function

**List** Indication of list number

**Free** Available space. Free 1900, for example, means that there is free space for a total of 1900 pairs of values (elements) in the list memory.

**Len** Occupied space. Len 0100, for example, means that the current list occupies 100 elements in the list memory.

Selection of index ➤ Select an index by means of the rotary knob or enter an index value by means of the numerical keys.

Editing of parameters ➤ Select the parameter (frequency, power) to be edited by means of the [SELECT] key or the rotary knob.

➤ Vary the numerical value by means of the rotary knob or enter a numerical value using the numerical keys and the [ENTER] key.

➤ Upon pressing the [BACK] key, the menu cursor goes back to the column left of the current column or to the Edit List menu.

**Delete editing function** (see Fig. 3-9)

The Delete function deletes the elements of the indicated range. After a delete no gap is left in the list but the remaining elements move up. If the indicated range extends beyond the end of the list, the elements until the end of the list are deleted.

The inputs for deleting elements from a list are the same as for inserting elements into a list, see "Insert editing function".

Upon pressing the [BACK] key, the editing window will be exited without any change being made. The menu cursor goes back to Edit List.

Selection: Delete

11.000 000 0000 GHz		-20.0 dBm	
List/Delete			
Delete At		0001	
Range		0100	
Execute			
Back ↵			

Fig. 3-9 Delete editing function

**Delete At** Input of first element to be deleted in a list

**Range** Number of elements to be deleted

**Execute** Starts the deletion. After the execution of the function, the menu cursor goes back to Edit List.

## SAVE/RECALL – Storing/Calling of Instrument Settings

50 complete instrument settings can be stored in memory locations 1 to 50.

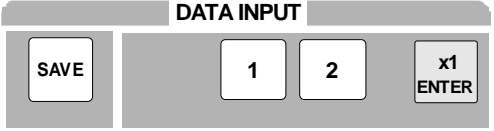
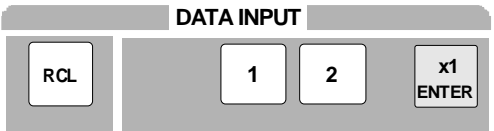
Operating Steps	Explanations
	<p>Store current instrument setting in memory location 12.</p>
	<p>Call instrument setting of memory location 12.</p>

The digital display during a save or recall entry is faded in a window.

Memory location 0 has a special function. Here the instrument setting which was current prior to the last memory recall and prior to a preset setting is automatically stored. This permits the resetting of instrument settings which have inadvertently been deleted using Recall 0.

If an instrument setting is stored in which a sweep was switched on, the sweep is started using the recall.

The parameter Exclude From Recall in the Frequency and Level-Level menus determines whether the saved RF frequency and RF level are loaded when an instrument setting is loaded, or whether the current settings are maintained.

Store IEC-bus command:        " \*SAV 12 "

Call IEC-bus command:        " \*RCL 12 "

**Note:**        *The contents of lists, as they are used for the List mode or for user correction (Ucor), is not saved in the SAVE memory. It is stored under the respective list name and can be called. If instrument settings are called which go back to list data such as level setting using Ucor, the current list contents is used. If this has been altered, it is not identical to the list contents at the point of storing any more.*

### Menu Summary

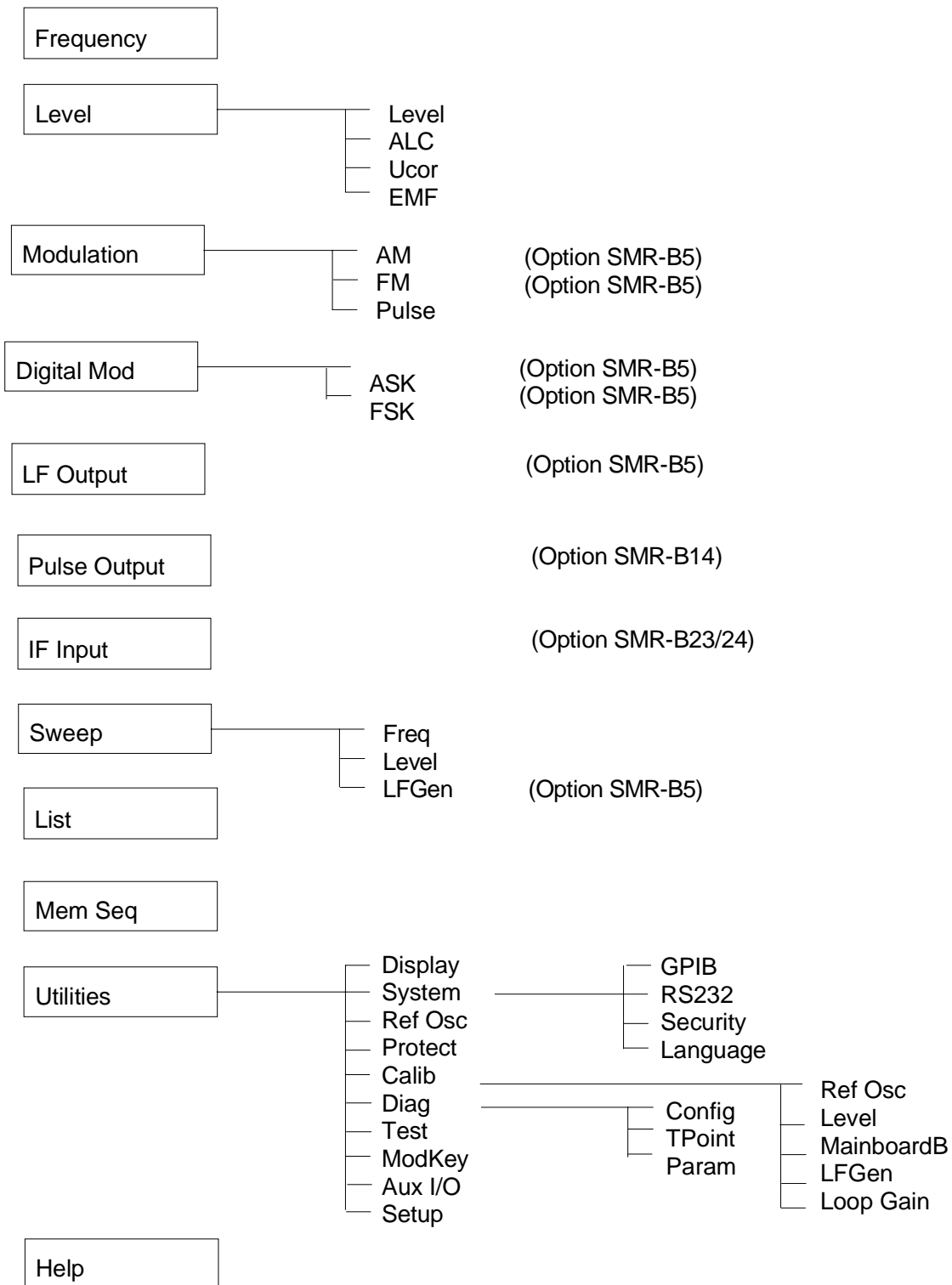



## 4 Instrument Functions

This chapter describes the functions of the instrument and its options which can be activated manually via menus or by remote control (frequency and level settings, analog and digital modulations, sweep, list mode, memory sequence and general functions not directly related to signal generation).

### RF Frequency

The RF frequency can be set directly using the [FREQ] key or via the Frequency menu.

In the Frequency menu, the frequency of the RF output signal is entered and indicated under Frequency.

In frequency settings made with the [FREQ] key, an arithmetic offset is taken into account. Such settings are indicated in the header line of the display. This makes it possible to enter the desired output frequency of subsequent units, if any (eg mixers). The offset and the multiplier can also be entered in the Frequency menu (see next section: "Frequency Offset and Multiplier").

**Note:** Further settings: Frequency sweep Sweep menu  
 LF frequency Modulation menu  
 Int./ext. reference frequency LF Output menu  
 Utilities - Ref Osc menu

Menu selection: Frequency

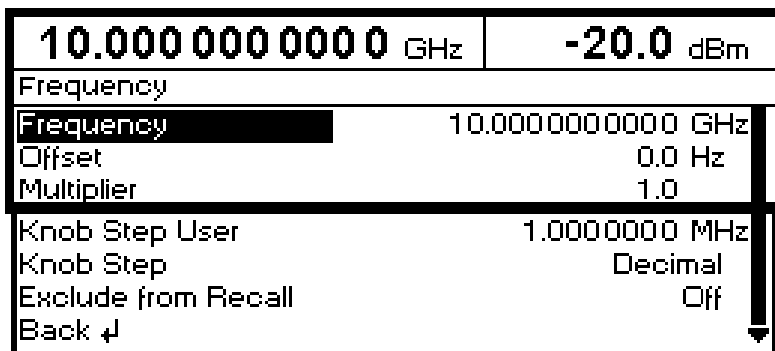

Fig. 4-1 Frequency menu (preset setting)

**Frequency** Input value of RF frequency at RF output connector.  
 IEC/IEEE-bus command :SOUR:FREQ 10E9

**Offset** Input value of frequency offset, for example of subsequent mixer.  
 IEC/IEEE-bus command :SOUR:FREQ:OFFS 0

**Multiplier** Input value of multiplier, eg subsequent frequency multiplier.  
 IEC/IEEE-bus command :SOUR:FREQ:MULT 1

<b>Knob Step User</b>	Input value of step size of frequency variation via rotary knob. The RF frequency is varied by the entered step size if Knob Step is set to User. IEC/IEEE-bus command :SOUR:FREQ:STEP 1MHz
<b>Knob Step</b>	Decimal: The variation step size corresponds to the position of the digit cursor. User: User-defined, the variation step size is as entered under Knob Step User.
<b>Exclude from Recall</b>	Off Normal setting. The stored frequency is loaded too when instrument settings are loaded with the [RCL] key or with a memory sequence. IEC/IEEE-bus command SOUR:FREQ:RCL INCL On The stored frequency is not loaded when instrument settings are loaded, ie the current frequency setting is maintained. IEC/IEEE-bus command SOUR:FREQ:RCL EXCL

### Frequency Offset and Multiplier

On the SMR it is possible to enter an offset and a multiplier for subsequent units, if any, in the Frequency menu. Such entries are taken into account in the frequency displayed in the header line, which indicates the frequency of the RF signal at the output of the units in question (see Fig. 4-2). If both a frequency offset and a multiplier have been entered, it is assumed for the calculation that the RF signal is first multiplied and then the offset is added.

The frequency of the RF output signal is calculated from the frequency, offset and multiplier values entered in the Frequency menu as follows:

$$\text{RF output frequency} = (\text{frequency} - \text{offset}) / \text{multiplier}$$

The entry of an offset and multiplier causes a change of the frequency value displayed in the header line (the value taking into account the offset is displayed). The value of the RF output frequency is displayed under Frequency in the Frequency menu.

The entered offset remains active also for frequency sweeps.

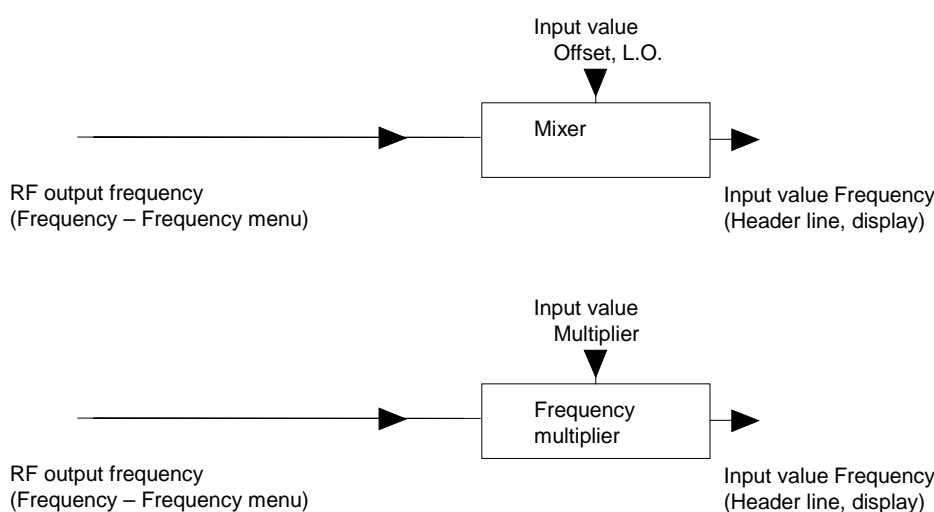

Fig. 4-2 Typical setups with frequency offset and frequency multiplier

## RF Level

The RF level can be set directly using the [LEVEL] key or via the Level - Level menu.

In the Level - Level menu, the set RF output level is entered and indicated under Amplitude.

In level settings made with the [LEVEL] key, the offset of a subsequent attenuator/amplifier is taken into account (see section "Level Offset"). This makes it possible to enter the desired level at the output of subsequent units. The offset can also be entered in the Level - Level menu under Offset.

dBm, dB $\mu$ V, mV and  $\mu$ V can be used as level units. The four unit keys are labelled with the respective units. To change to another level unit, simply press the corresponding unit key.

- Note:**
- The note "Unleveled" appears in the status line if the displayed level is not attained. The maximum possible RF output level varies depending on the model and the options fitted (see data sheet).
  - Further settings: Level Sweep Sweep menu

Menu selection: Level - Level

10.000 000 0000 GHz		-20.0 dBm	
Level/Level			
Amplitude			-20.0 dBm
Offset			0.0 dB
Limit			25.0 dBm
Attenuator Mode			Auto
Atten Fixed Range	0.0 dBm		to unleveled
Knob Step User			1.0 dB
Knob Step			Decimal
Power Resolution			0.1 dB
Power On State			Previous
Exclude from Recall			Off
Back ↵			

Fig. 4-3 Level menu, with option SMR-B15, attenuator 20 GHz

<b>Amplitude</b>	Input value of RF level at RF output connector IEC/IEEE-bus command SOUR:POW -30
<b>Offset</b>	Input value of level offset of a subsequent attenuator/amplifier. Input value in dB (see section "Level Offset"). IEC/IEEE-bus command SOUR:POW:OFFS 0
<b>Limit</b>	Input value of level limit. This value indicates the upper limit of the level at the RF output connector. A warning is output in the status line if an attempt is made to set a level above this limit. IEC/IEEE-bus command :SOUR:POW:LIM 16 dBm



<b>Attenuator Mode</b>	Auto	Normal setting. The mechanically switched attenuator switches in steps of 10 dB at fixed points. IEC/IEEE-bus command :OUTP:AMOD AUTO
	Fixed	Level settings are made without switching the attenuator (see section "Non-Interrupting Level Setting"). IEC/IEEE-bus command :OUTP:AMOD FIX
<b>Atten Fixed Range</b>	Indicates the level range of non-interrupting level setting in "Attenuator Mode Fixed".	
<b>Knob Step User</b>	Input value of step size of level variation via rotary knob. The RF level is varied by the entered step size if Knob Step is set to User. IEC/IEEE-bus command :SOUR:POW:STEP 1	
<b>Knob Step</b>	Decimal	The variation step size corresponds to the position of the digit cursor.
	User	User-defined, the variation step size is as entered under Knob Step User.
<b>Power Resolution</b>	Selection of resolution of level display	
	0.1 dB	The resolution of the level display is 0.1 dB.
	0.01 dB	The resolution of the level display is 0.01 dB.
<b>Power On State</b>	Selection of status to be assumed by RF output after power-up of the instrument.	
	RF Off	The RF output is switched off.
	Previous Setting	The RF output assumes the status active before switch-off.
	IEC/IEEE-bus command :OUTP:PON ON	
<b>Exclude from Recall</b>	Off	Normal setting. The stored RF level is loaded too when instrument settings are loaded with the [RCL] key or with a memory sequence. IEC/IEEE-bus command :SOUR:POW:RCL INCL
	On	The stored RF level is not loaded when instrument settings are loaded, ie the current level setting is maintained. IEC/IEEE-bus command :SOUR:POW:RCL EXCL

## Level Offset

On the SMR, it is possible to enter an offset for a subsequent attenuator/amplifier, if any, in the Level menu. The offset is taken into account in the display in the header line (see below), which represents the level value of the signal at the output of the subsequent unit (see Fig. 4-4).

The level of the RF output signal is therefore calculated from the amplitude and offset entered in the Level - Level menu as follows:

$$\text{RF output level} = \text{amplitude} - \text{offset}$$

The entered offset has no influence on the RF output signal of the SMR; the offset is only taken into account in the displayed level value. The value with the offset can be directly entered with the [LEVEL] key.

The RF output level of the SMR is indicated in the Level - Level menu.



Fig. 4-4 Typical setup with level offset

## Non-Interrupting Level Setting

(With option SMR-B15, 20 GHz attenuator (SMR20, SMR27), or SMR-B17, 40 GHz attenuator (SMR30, SMR40).

With Attenuator Mode Fixed, non-interrupting level setting is performed. Electronic attenuator switching is used instead of interrupting, mechanical attenuator switching.

If the level falls below the permissible variation range, the warning "Level underrange" is output in the status line of the display; if it attains or goes beyond the upper limit value, the warning "Unleveled" is output. With underrange or overrange, level accuracy and spectral purity are no longer guaranteed.

### Switching On/Off Automatic Level Control (Alc)

Settings for automatic level control (ALC) can be made in the Level – Alc menu.

When level control is switched off (ALC State Off), switchover is made to a sample-and-hold mode. In this mode, level control is switched on automatically for a short time after each level or frequency setting and the level control is held at the value attained. Level control OFF is used in multisource measurements to improve intermodulation suppression.

The basic functions of level control are shown in Fig. 4-5.

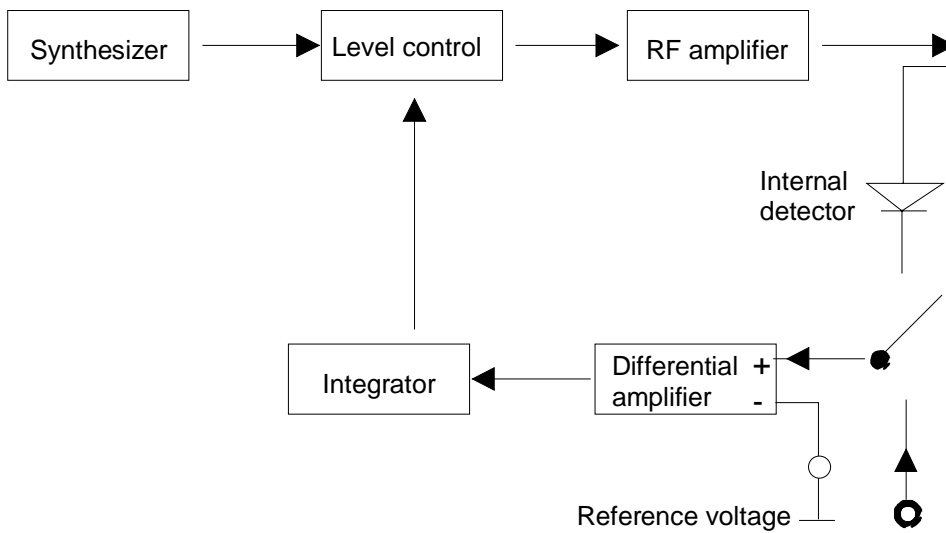

Fig. 4-5 Basic principle of level control of SMR

Fig. 4-6 illustrates an example of external level control.

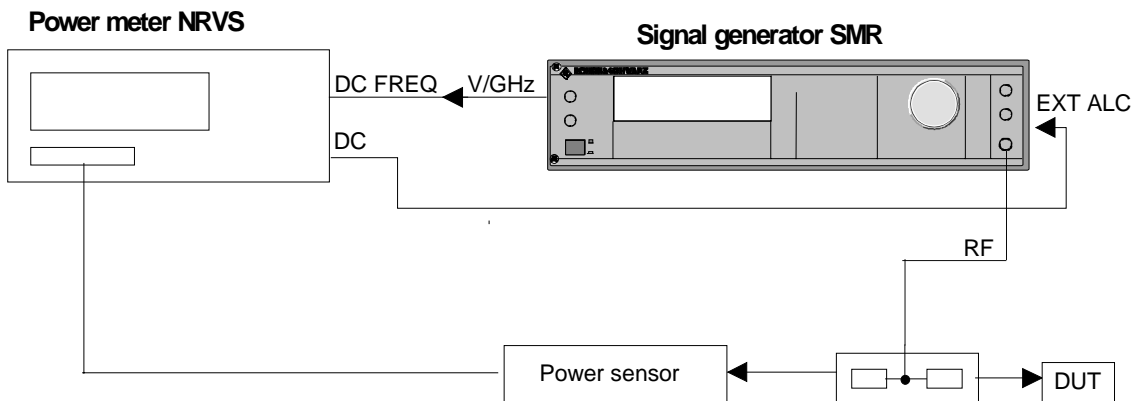

Fig. 4-6 Example of external level control with power meter

Menu selection: Level - Alc

10.000 000 0000 GHz	-20.0 dBm
Level/Alc	
State	On
Search Once	
Source	Int
Power Meter Type	R&SNRVS
Back ↵	

Fig. 4-7 Level - Alc menu (preset setting)

<b>State</b>	On	Normal status. Internal level control is switched on permanently.
	Off	Internal level control is switched off. No AM or ASK is possible in this status.
	IEC/IEEE-bus command : SOUR:POW:ALC OFF	
<b>Search Once</b>	Manual brief switch-on of level control for level calibration in the ALC State Off mode.	
	IEC/IEEE-bus command : SOUR:POW:ALC ON;ALC OFF	
<b>Source</b>	Selection of detector for level control	
	Int	The internal detector is switched on. IEC/IEEE-bus command : SOUR:POW:ALC:SOUR INT
	Diode	A diode detector can be connected to the EXT ALC input. IEC/IEEE-bus command : SOUR:POW:ALC:SOUR DIOD
	Pmeter	A power meter can be connected to the EXT ALC input. IEC/IEEE-bus command : SOUR:POW:ALC:SOUR PMET
<b>Power Meter Type</b>	Selection of power meter	
	R&S NRVS	Power Meter NRVS from Rohde & Schwarz
	HP436A/HP437/HP438A	Power Meter HP436A, HP437 or HP438A from Hewlett Packard
	IEC/IEEE-bus command : SOUR:POW:ALC:SOUR:PMET RS_NRVS	
<b>Reference</b>	Input value of reference voltage for operation with an external diode detector or a power meter from Hewlett Packard.	
	IEC/IEEE-bus command : SOUR:POW:ALC:REF 1	

## User Correction (Ucor)

The "User correction" function can be used to create and activate lists in which level correction values are assigned to arbitrary RF frequencies.

Up to 10 lists with a total of 160 correction values can be compiled. For frequencies not included in the list, level correction values are determined by interpolation based on the nearest correction values.

When user correction is switched on, Ucor (user correction) is displayed in the header field in addition to the level. The RF output level is the sum of both values.

$$\text{Level} + \text{Ucor} = \text{output level}$$

If an offset is selected at the same time, the displayed level value is the difference between the amplitude and the offset entered in the Level menu.

$$\text{Amplitude} - \text{offset} = \text{level}$$

With automatic level correction, the Ucor lists can be automatically filled with measured values.

User correction is active in all operating modes when switched on.

Menu selection: Level - Ucor

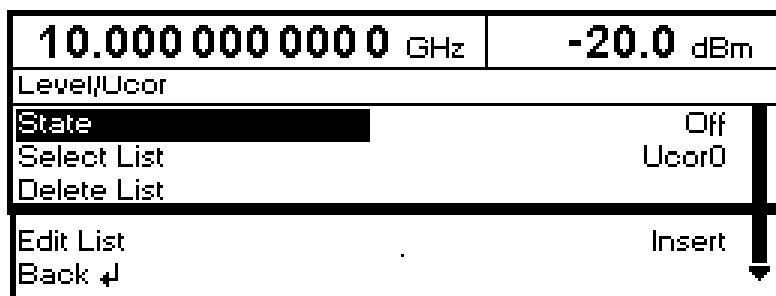

Fig. 4-8 Level - Ucor menu

<b>State</b>	Switching on/off user correction IEC/IEEE-bus command : SOUR:CORR ON
<b>Select List</b>	Selection of a list or generation of a new list (see chapter 3, section "List Editor") IEC/IEEE-bus command : SOUR:CORR:CSET "UCOR1"
<b>Delete List</b>	Deletion of a list (see chapter 3, section "List Editor") IEC/IEEE-bus command : SOUR:CORR:CSET:DEL "UCOR2"
<b>Edit List</b>	Selection of editing mode for modifying a selected list (see chapter 3, section "List Editor") IEC/IEEE-bus commands : SOUR:CORR:CSET:DATA:FREQ 10.5GHz, 10.7GHz,... : SOUR:CORR:CSET:DATA:POW 1dB, 1.9dB, 1.2dB,...

Menu selection: Level - Ucor

11.000 000 0000 GHz		-20.0 dBm	
Level/Ucor/Edit			
0007	10.600 000 0000 GHz	1.2 dB	Ucor0
<b>0008</b>	10.700 000 0000 GHz	1.4 dB	Free 150
0009	10.800 000 0000 GHz	1.6 dB	Len 010

Fig. 4-9 Ucor - Level menu

<b>Ucor</b>	Indication of list item number.
<b>Free</b>	Available space. Free 150, for example, means that there is free space for a total of 150 pairs of values (elements) in the list memory.
<b>Len</b>	Occupied space. Len 010, for example, means that the current list occupies 10 elements in the list memory.

## [RF ON/OFF] Key

The RF output signal can be switched on and off with the [RF ON/OFF] key. This does not influence the current menu. When the output signal is switched off, "RF Off" appears in the header field with the level display. With RF Off, the 50  $\Omega$  source impedance is maintained.

IEC/IEEE-bus command :OUTP OFF

## Modulation - General

In addition to pulse modulation (PULSE), the SMR offers the following modulation types if it is fitted with the **option SMR-B5**:

- linear and logarithmic amplitude modulation (AM),
- frequency modulation (FM),
- digital modulation types (ASK and FSK).

For the analog modulation types, internal or external modulation sources can be used. For the digital modulation types, only external modulation sources can be used.

### Modulation Sources

#### Internal modulation source

For AM and FM, an internal modulation generator (Lfgcn) is available. For more information see section "LF Generator".

For internal pulse modulation, the instrument can be equipped with a pulse generator (option SMR-B14). For more information see section "Pulse Generator".

#### External modulation source

The input connectors to be used for feeding the various types of external modulation are listed in Table 4-1. External AM and FM can be AC- or DC-coupled.

Table 4-1 Input connectors for external modulation

Modulation	Inputs		
	EXT1	EXT2	PULSE
AM	X		
FM1	X	X	
FM2	X	X	
PULSE			X
ASK	X		
FSK	X		

External modulation signals should have a voltage of  $V_p = 1 \text{ V}$  ( $V_{\text{rms}} = 0.707 \text{ V}$ ) to maintain the displayed modulation depth or deviation. Voltage deviations exceeding  $\pm 3\%$  are displayed in the status line as shown in Table 4-2.

Table 4-2 Status messages for deviation from nominal at external modulation inputs

Message	Deviation
EXT1-HIGH	Voltage at EXT1 too high
EXT1-LOW	Voltage at EXT1 too low
EXT2-HIGH	Voltage at EXT2 too high
EXT2-LOW	Voltage at EXT2 too low
EXT-HI/HI	Voltages at EXT1 and EXT2 too high
EXT-LO/LO	Voltages at EXT1 and EXT2 too low
EXT-HI/LO	Voltage at EXT1 too high and at EXT2 too low
EXT-LO/HI	Voltage at EXT1 too low and at EXT2 too high

## Simultaneous Modulation

Basically, any combination of AM, FM and pulse modulation is possible. There are restrictions only for modulations of equal type (see Table 4-3).

Two-tone AM is possible by switching on both the external and the internal source.

Two-tone FM is possible by switching on both FM1 and FM2. For FM1 and FM2, separate deviations can be set and separate sources switched on.

**Note:** *For two-tone modulation it should be noted that the selected deviation or modulation depth applies to only one signal in each case, and the sum deviation or sum modulation depth results from the addition of the two signals. If the maximum value of deviation or modulation depth is exceeded, overmodulation occurs.*

## Mutual Switch-Off of Modulation Types

Due to the multiple use of function modules in the instrument, some modulation types cannot be activated simultaneously (see Table 4-3). With manual control, incompatible modulation types deactivate one another, and a short-time warning message is output in the status line.

**Note:** *IEC/IEEE-bus control according to SCPI does not allow the selection of incompatible modulation types. With remote control, an error message is output when an attempt is made to activate incompatible types of modulation (see Chapter 9).*



Table 4-3 Modulation types which cannot be active simultaneously (AM, FM, ASK and FSK only with option SMR-B5)

	AM INT1	AM INT2	AM EXT1	AS K	FM1 INT1	FM1 EXT1	FM1 EXT2	FM1 FSK	FM2 INT2	FM2 EXT1	FM2 EXT2	FM2 FSK
AM INT1		<input type="checkbox"/>	<input type="checkbox"/>	<input type="checkbox"/>								
AM INT2	<input type="checkbox"/>			<input type="checkbox"/>								
AM EXT1	<input type="checkbox"/>	<input type="checkbox"/>		<input type="checkbox"/>				X				X
ASK	<input type="checkbox"/>	<input type="checkbox"/>	<input type="checkbox"/>			X				X		
FM1 INT1						<input type="checkbox"/>	<input type="checkbox"/>	<input type="checkbox"/>				
FM1 EXT1				X	<input type="checkbox"/>		<input type="checkbox"/>	<input type="checkbox"/>				X
FM1 EXT2					<input type="checkbox"/>	<input type="checkbox"/>		<input type="checkbox"/>				
FM1 FSK			X		<input type="checkbox"/>	<input type="checkbox"/>	<input type="checkbox"/>			X		
FM2 INT2										<input type="checkbox"/>	<input type="checkbox"/>	<input type="checkbox"/>
FM2 EXT1				X				X	<input type="checkbox"/>		<input type="checkbox"/>	<input type="checkbox"/>
FM2 EXT2									<input type="checkbox"/>			<input type="checkbox"/>
FM2 FSK			X				X		<input type="checkbox"/>	<input type="checkbox"/>	<input type="checkbox"/>	

X Mutual switch-off with manual control  
 Switch-off by 1-out-of-n selection

**[MOD ON/OFF] Key**

The various types of modulation can be switched on and off directly using the [MOD ON/OFF] key or via the Modulation menu. If switch-on is made using the [MOD ON/OFF] key, the modulation sources which are set in the modulation menus are used.

The [MOD ON/OFF] key can be effective either for all types of modulation or only for a selected modulation. The selection of modulation types for which the [MOD ON/OFF] key is to be effective is made in the Utilities – Mod Key menu.

If only one type of modulation is selected, it is switched on or off each time the [MOD ON/OFF] key is pressed.

If all modulation types are selected, the [MOD ON/OFF] key has the following effect:

- If at least one modulation type is active:  
 Pressing the [MOD ON/OFF] key switches off all active modulation types. The modulation types which were active are stored.
- If no modulation type is active:  
 Pressing the [MOD ON/OFF] key switches on the modulation types that were last switched off with this key.

## Analog Modulation

### Amplitude Modulation

Settings for linear and logarithmic amplitude modulation can be made in the Modulation - AM menu.

- Note:**
- The maximum guaranteed level of the SMR varies depending on the model and the options fitted (see data sheet). The specified AM data are valid only up to 6 dB below the maximum level in each case. For level values exceeding this threshold, AM data are guaranteed only if the modulation depth is decreases linearly.
  - If the set modulation depth is too large, "WARNING" is output in the status line and, after pressing the ERROR key, the message "WARN -221 Settings conflict; modulation forces peak level into overrange" is displayed.

Menu selection: Modulation - AM

10.0000000000 GHz		-20.0 dBm	
Modulation/AM			
AM Depth		30.0 %	
AM Source		Off	
Scan State		Off	
Ext1 Coupling		AC	
Ext2 Coupling		AC	
Ext1 Impedance		100 K $\Omega$	
Ext2 Impedance		100 K $\Omega$	
Lfgen Freq		1.0000 kHz	
Lfgen Shape		Sin	
Back ↵			

Fig. 4-10 Modulation - AM menu (preset setting)

<b>AM Depth</b>	Input value of modulation depth IEC/IEEE-bus command : SOUR:AM 30PCT
<b>AM Source</b>	Selection of modulation source IEC/IEEE-bus command : SOUR:AM:SOUR INT1; STAT ON
<b>Scan State</b>	Switching on/off logarithmic amplitude modulation IEC/IEEE-bus command : SOUR:AM:SCAN ON
<b>Ext1 Coupling</b>	Selection of AC or DC coupling with external modulation source IEC/IEEE-bus command : SOUR:AM:EXT1:COUP AC
<b>Ext2 Coupling</b>	Selection of AC or DC coupling with external modulation source IEC/IEEE-bus command : SOUR:AM:EXT2:COUP AC
<b>Ext1 Impedance</b>	Selection of input impedance for external input EXT1 IEC/IEEE-bus command : SOUR:AM:EXT1:IMP 100kOhm
<b>Ext2 Impedance</b>	Selection of input impedance for external input EXT2 IEC/IEEE-bus command : SOUR:AM:EXT2:IMP 100kOhm
<b>Lfgen Freq</b>	Selection of frequency of LF generator IEC/IEEE-bus command : SOUR:AM:INT:FREQ 1kHz
<b>Lfgen Shape</b>	Selection of waveform of LF generator IEC/IEEE-bus command : SOUR2:FUNC SIN

## Frequency Modulation

Settings for frequency modulation can be made in the Modulation - FM menu.

Menu selection: Modulation - FM

10.000 000 0000 GHz		-20.0 dBm	
Modulation/FM			
FM Deviation	10.0000 kHz		
FM Source	Off		
Ext1 Coupling	AC		
Ext2 Coupling	AC		
Ext1 Impedance	100 K $\Omega$		
Ext2 Impedance	100 K $\Omega$		
Lfgen Freq	1.0000 kHz		
Lfgen Shape	Sin		
Back ↵			

Fig. 4-11 Modulation - FM menu (preset setting)

<b>FM Deviation</b>	Input value for deviation IEC/IEEE-bus command : SOUR:FM 10kHz
<b>FM Source</b>	Switching on/off FM and selection of modulation source IEC/IEEE-bus commands : SOUR:FM:SOUR INT; STAT ON
<b>Ext1 Coupling</b>	Selection of AC or DC coupling for external input EXT1 IEC/IEEE-bus command : SOUR:FM:EXT1:COUP AC
<b>Ext2 Coupling</b>	Selection of AC or DC coupling for external input EXT2 IEC/IEEE-bus command : SOUR:FM:EXT2:COUP AC
<b>Ext1 Impedance</b>	Selection of input impedance for external input EXT1 IEC/IEEE-bus command : SOUR:FM:EXT1:IMP 100kOhm
<b>Ext2 Impedance</b>	Selection of input impedance for external input EXT2 IEC/IEEE-bus command : SOUR:FM:EXT2:IMP 100kOhm
<b>Lfgen Freq</b>	Selection of frequency of LF generator IEC/IEEE-bus command : SOUR:FM:INT:FREQ 1kHz
<b>Lfgen Shape</b>	Selection of waveform of LF generator IEC/IEEE-bus command : SOUR2:FUNC SIN

## Pulse Modulation

The pulse modulator can be controlled from an external source or by an internal pulse generator (option SMR-B14). With external control, the external source feeds the pulse modulator directly. The envelope of the RF is identical to the control signal. With control by the internal pulse generator, the pulse shape of the pulse generator determines the envelope of the RF. The pulse delay, pulse width and pulse period can be set.

The polarity of pulse modulation is selectable. With Pulse Polarity = Normal, the RF level is switched on if HIGH level is present at the PULSE modulation input. If option SMR-B14 is fitted, the input impedance can be switched between 50  $\Omega$  and 10 k $\Omega$ ; if the option is not fitted, the input impedance is permanently at 50  $\Omega$ .

Settings for the pulse modulation and the pulse generator can be made in the Modulation - Pulse menu.

Menu selection: Modulation - Pulse

10.000 000 0000 GHz		-20.0 dBm	
Modulation/Pulse			
Pulse Source		Off	
Pulse Polarity		Normal	
Pulse Period		10.00 $\mu$ s	
Pulse Width		1.00 $\mu$ s	
Pulse Delay		1.00 $\mu$ s	
Double Pulse State		Off	
Pulse Mode		Auto Trig	
Ext Trig Slope		Pos	
Gate Input Polarity		Normal	
Ext Impedance		10 k $\Omega$	
Back ↵			

Fig. 4-12 Modulation - Pulse menu (preset setting), option SMR-B14, pulse generator, fitted

<b>Pulse Source</b>	Selection of modulation source IEC/IEEE-bus commands : SOUR:PULM:SOUR INT; STAT ON
<b>Pulse Polarity</b>	Selection of polarity of modulation signal Normal The RF signal is on with HIGH level present. Inverse The RF signal is suppressed with HIGH level present. IEC/IEEE-bus command : SOUR:PULM:POL NORM
<b>Pulse Period</b>	Input value of pulse period IEC/IEEE-bus command : SOUR:PULS:PER 10 $\mu$ s
<b>Pulse Width</b>	Input value of pulse width IEC/IEEE-bus command : SOUR:PULS:WIDT 1 $\mu$ s
<b>Pulse Delay</b>	Input value of single pulse delay. This value is indicated only if Double Pulse State is set to Off. IEC/IEEE-bus command : SOUR:PULS:DEL 1 $\mu$ s

<b>Double Pulse State</b>	Switching on/off double pulse On            Double pulse is switched on Off            Single pulse IEC/IEEE-bus command    : SOUR:PULS:DOUB OFF
<b>Pulse Mode</b>	Selection of trigger mode Auto Trig    The pulse generator is triggered automatically. The pulse period is as entered under Pulse Period. Ext Trig      The pulse generator is externally triggered. The pulse period is determined by an external signal at the PULSE input. Ext Gated    The pulse generator is triggered if the gate signal is active. IEC/IEEE-bus command    : TRIG:PULS:SOUR AUTO
<b>Ext Trig Slope</b>	Selection of active edge of external trigger signal Pos            The pulse generator is triggered on the positive edge of the external signal. Neg            The pulse generator is triggered on the negative edge of the external signal. IEC/IEEE-bus command    : TRIG:PULS:SLOP POS
<b>Gate Input Polarity</b>	Definition of active level of gate signal (LOW or HIGH) IEC/IEEE-bus command    : TRIG:PULS:SOUR EXT_GATED
<b>Ext Impedance</b>	Selection of 50 $\Omega$ or 10 k $\Omega$ input impedance IEC/IEEE-bus command    : SOUR:PULM:EXT:IMP 50

## Pulse Generator

As an internal modulation source, the pulse generator (option SMR-B14) offers the possibility of setting single and double pulses with variable pulse delay, pulse width and pulse period. The pulse generator can be triggered internally or by an external signal at the PULSE input. The following Pulse modi can be selected: Auto Trig, Ext Trig, and Ext Gated (see Fig. 4-13 to Fig. 4.15). The internal trigger signal is derived from the reference frequency and hence very stable. In the trigger mode Ext Trig, the positive or the negative edge can be used for triggering the pulse generator. In the trigger mode Ext Gated, the pulse generator is triggered as long as an active Gate signal arrives at the PULSE input.

The pulse generator can also be used as an independent unit, ie without the pulse modulator being controlled if the pulse modulation source (Pulse Source) is switched to OFF or EXT. The pulse can be tapped at the VIDEO output.

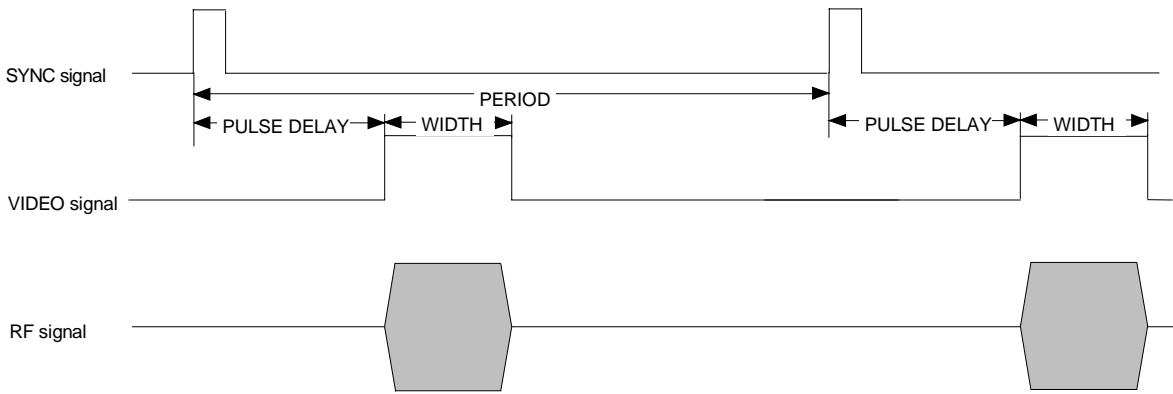

Fig. 4-13 Signal example 1: single pulse, Pulse mode = Auto Trig

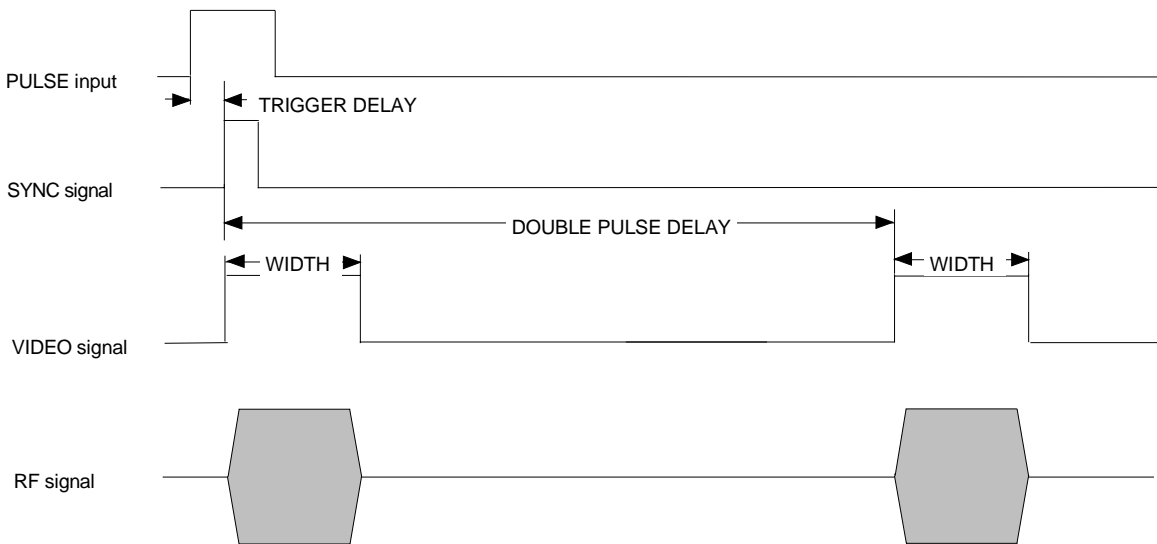

Fig. 4-14 Signal example 2: double pulse, Pulse mode = Ext Trig, Slope = Pos

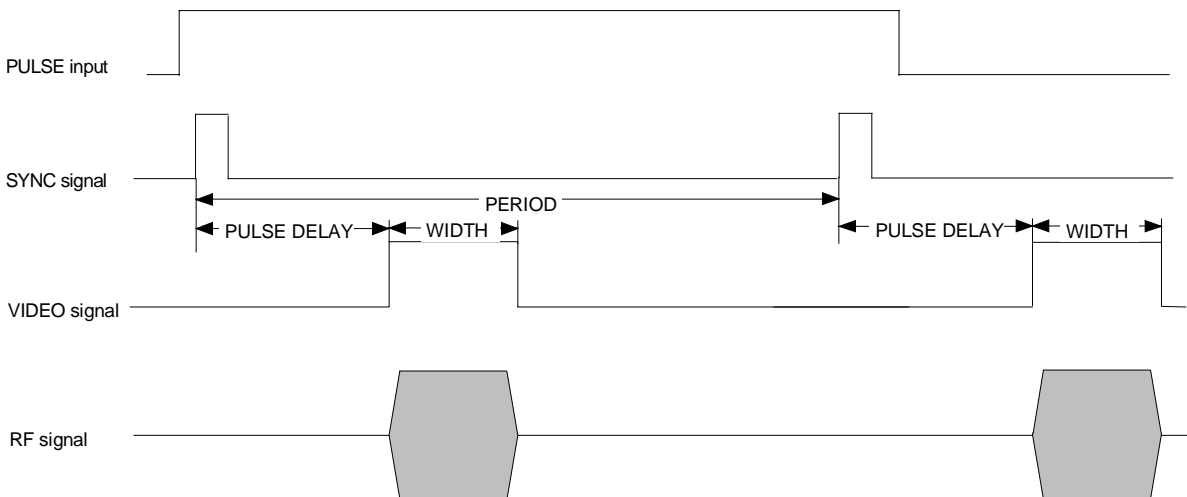

Fig. 4-15 Signal example 3: single pulse, Pulse Mode = Ext Gated

**LF Generator**

The LF generator is part of the option SMR-B5 and therefore available only if option SMR-B5 is fitted. The waveforms and frequencies of internal modulation signals can be selected in one of the modulation menus (AM, FM) or in the LF Output menu (cf. Chapter 4, Sections "Amplitude Modulation", "Frequency Modulation" and "LF Output").

## Digital Modulations ASK and FSK

The digital modulation types ASK and FSK are possible only with option SMR-B5.

Settings for **ASK modulation** can be made in the Digital Mod - Ask menu.

Menu selection: Digital Mod - Ask

10.000 000 0000 GHz		-20.0 dBm	
Digital Mod/Ask			
Source		Off	
Depth		30.0 %	
Ext Impedance		100 KΩ	
Polarity		Inverse	
Back ↵			

Fig. 4-16 Digital Mod - Ask menu (preset setting), option SMR-B5 fitted

<b>Source</b>	Selection of modulation source for ASK ( <u>a</u> mplitude <u>s</u> hift <u>k</u> e <u>y</u> ing). IEC/IEEE bus command : SOUR:DM:TYPE ASK; SOUR EXT; STAT ON
<b>Depth</b>	Input value of deviation for ASK. IEC/IEEE bus command : SOUR:DM:ASK:DEPT 30PCT
<b>Ext Impedance</b>	Selection of input impedance for EXT. IEC/IEEE bus command : SOUR:DM:EXT:IMP 100kOHM
<b>Polarity</b>	Selection of polarity of modulation. IEC/IEEE bus command : SOUR:DM:ASK:POL NORM



Settings for **FSK modulation** can be made in the Digital Mod - Fsk menu.

Menu selection: Digital Mod - Fsk

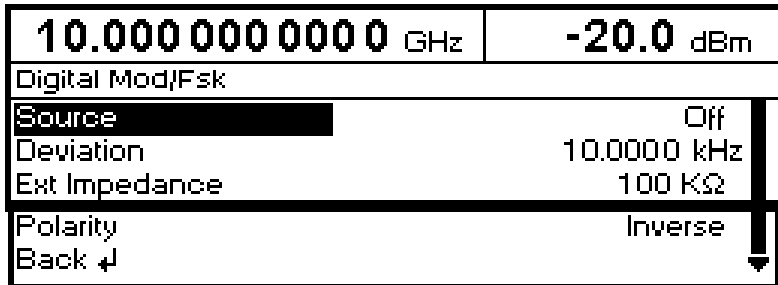

Fig. 4-17 Digital Mod - Fsk menu (preset setting), option SMR-B5 fitted

<b>Source</b>	Selection of modulation source for FSK ( <u>F</u> requency <u>S</u> hift <u>K</u> e <u>y</u> ing). IEC/IEEE bus command : SOUR:DM:TYPE FSK;SOUR EXT;STAT ON
<b>Deviation</b>	Input value of deviation for FSK. IEC/IEEE bus command : SOUR:DM:FSK:DEV 10kHz
<b>Ext Impedance</b>	Selection of input impedance for external input. IEC/IEEE bus command : SOUR:DM:EXT:IMP 100kOhm
<b>Polarity</b>	Selection of polarity of modulation. IEC/IEEE bus command : SOUR:DM:FSK:POL NORM

## LF Output

The internal LF generator is available as a signal source for the LF output, provided the SMR is fitted with the option SMR-B5.

Settings for the LF output can be made in the LfOutput menu.

- Note:**
- Any change to the waveform or frequency of the internal modulation generator in the LfOutput menu also affects the modulation for which the generator has been selected as a modulation source.
  - The sweep function of the LF generator can be activated in the Sweep - Lfgen menu.
  - The unit for the display/setting of the LF output voltage can be switched to dBu by means of the [G/n]dBu key.

Menu selection: LfOutput

10.000 000 0000 GHz		-20.0 dBm	
LfOutput			
State		Off	
Voltage		1.000 V	
Lfgen Freq		1.0000 kHz	
Lfgen Shape		Sin	
Back ↵			

Fig. 4-18 LfOutput menu (preset setting), option SMR-B5 fitted

<b>State</b>	Switching on/off LF output. This parameter has no effect on the modulation settings. IEC/IEEE bus command : OUTPUT2 ON
<b>Voltage</b>	Input value of output voltage of LF output. A peak voltage is to be entered here. If no LF generator option is fitted, the constant output voltage of the standard generator ( $V_p = 1\text{ V}$ ) is indicated. IEC/IEEE bus command : OUTPUT2:VOLT 1V
<b>Lfgen Freq</b>	Input value of frequency of internal modulation generator IEC/IEEE bus command : SOUR:AM:INT:FREQ 15kHz
<b>Lfgen Shape</b>	Input value of waveform of modulation generator IEC/IEEE bus command : SOUR2:FUNC SIN

## IF Input

The SMR offers upconversion of digitally modulated signals up to 40 GHz by means of the IF input (Option SMR-B23/SMR-B24).

Menu selection: IFInput

10.000 000 0000 GHz		-20.0 dBm	
IFInput			
Mode		Off	
RF-Attenuator		0.0 dB	
Back	↵		

Fig. 4-19 IFInput menu (preset setting), option SMR-B23/SMR-B24 fitted

<b>Mode</b>	Switching on/off IF input. IEC/IEEE bus command : INP:IF:STAT ON
<b>RF-Attenuator</b>	Attenuation setting in 10 dB steps, maximum value is 110 dB. Only with Option SMR-B15/SMR-B17. IEC/IEEE bus command : OUTP:ATT 20 dB

## PULSE/VIDEO Output

The pulse generator output or video output is only available with Option SMR-B14, pulse generator, cf. Section "Pulse Generator".

Menu selection: PulseOutput

10.0000000000 GHz		-20.0 dBm	
PulseOutput			
Source		Off	
Pulse Polarity		Normal	
Pulse Period		10.00 $\mu$ s	
Pulse Width		1.00 $\mu$ s	
Pulse Delay		1.00 $\mu$ s	
Double Pulse State		Off	
Pulse Mode		Auto Trig	
Ext Trig Slope		Pos	
Gate Input Polarity		Normal	
Ext Impedance		10 K $\Omega$	
Back ↵			

Fig. 4-20 PulseOutput menu

<b>Source</b>	Switching on/off pulse source. Off, Pulsegen or Video can be selected. IEC/IEEE bus command : OUP: SOUR OFF
<b>Pulse Polarity</b>	Selection of polarity of pulse signal. Normal or Inverse can be selected. IEC/IEEE bus command : OUP: POL: PULS NORM
<b>Pulse Period</b>	Input value of pulse period IEC/IEEE-bus command : SOUR: PULS: PER 10 $\mu$ s
<b>Pulse Width</b>	Input value of pulse width IEC/IEEE-bus command : SOUR: PULS: WIDT 1 $\mu$ s
<b>Pulse Delay</b>	Input value of single pulse delay. This value is indicated only if Double Pulse State is set to Off. IEC/IEEE-bus command : SOUR: PULS: DEL 1 $\mu$ s
<b>Double Pulse State</b>	Switching on/off double pulse On Double pulse is switched on Off Single pulse IEC/IEEE-bus command : SOUR: PULS: DOUB OFF

---

<b>Pulse Mode</b>	Selection of trigger mode: Auto Trig The pulse generator is triggered automatically. The pulse period is as entered under Pulse Period. Ext Trig The pulse generator is externally triggered. The pulse period is determined by an external signal at the PULSE input. Ext Gated The pulse generator is triggered if the gate signal is active. IEC/IEEE-bus command :TRIG:PULS:SOUR AUTO
<b>Ext Trig Slope</b>	Selection of active edge of external trigger signal Pos The pulse generator is triggered on the positive edge of the external signal. Neg The pulse generator is triggered on the negative edge of the external signal. IEC/IEEE-bus command :TRIG:PULS:SLOP POS
<b>Gate Input Polarity</b>	Definition of active level of gate signal (LOW or HIGH) IEC/IEEE-bus command :TRIG:PULS:SOUR EXT_GATED
<b>Ext Impedance</b>	Selection of 50 $\Omega$ or 10 k $\Omega$ input impedance IEC/IEEE-bus command :SOUR:PULM:EXT:IMP 50

## Sweep

The SMR features digital, step-by-step sweep for the following parameters:

- RF frequency
- LF frequency
- RF level

In addition to digital step-by-step sweep, analog sweep for the RF frequency and RF level is possible by switching on frequency or amplitude modulation with an internal sawtooth signal.

A sweep is set in five basic steps, which are demonstrated by the following example, ie the setting of a frequency sweep:

1. Set sweep range (Start Freq and Stop Freq or Center Freq and Span).
2. Select linear or logarithmic sweep (Spacing).
3. Select step size (Step Lin) and dwell time (Dwell).
4. Activate marker if desired (Marker).
5. Switch on sweep (Mode set to Auto, Single or Step).

### Setting the Sweep Range (Start Freq, Stop Freq, Center Freq, Span)

The sweep range for RF sweeps can be entered in two ways. Either the Start Freq and Stop Freq are entered or Center Freq and Span. Please note that the two parameter sets mutually affect each other as follows:

Start Freq altered:	Stop Freq	=	unaltered
	Center Freq	=	$(\text{Start Freq} + \text{Stop Freq})/2$
	Span	=	$(\text{Stop Freq} - \text{Start Freq})$
Stop Freq altered:	Start Freq	=	unaltered
	Center Freq	=	$(\text{Start Freq} + \text{Stop Freq})/2$
	Span	=	$(\text{Stop Freq} - \text{Start Freq})$
Center Freq altered:	Span	=	unaltered
	Start Freq	=	$(\text{Center Freq} - \text{Span}/2)$
	Stop Freq	=	$(\text{Center Freq} + \text{Span}/2)$
Span altered:	Center Freq	=	unaltered
	Start Freq	=	$(\text{Center Freq} - \text{Span}/2)$
	Stop Freq	=	$(\text{Center Freq} + \text{Span}/2)$

## Selecting Linear/Logarithmic Sweep (Lin, Log Spacing)

Linear or logarithmic sweep can be selected with Spacing. For RF and LF sweeps, both the linear and logarithmic modes are selectable. For level sweeps, only the logarithmic mode is possible.

With logarithmic sweeps, the step size (Step) is equal to a constant fraction of the current setting. The logarithmic step size for RF and LF sweeps is entered in % and for level sweeps in dB.

## Operating Modes (Mode)

The following sweep modes are available:

<b>Auto</b>	<p>Sweep from start point to stop point with automatic restart at start point. If another sweep mode was active prior to selection of the auto mode, the sweep is continued from the setting active at that time.</p> <p>IEC/IEEE bus commands</p> <table border="0"> <tr> <td><b>RF sweep:</b></td> <td><b>LF sweep:</b></td> <td><b>Level sweep:</b></td> </tr> <tr> <td>SOUR:FREQ:MODE SWE</td> <td>SOUR2:FREQ:MODE SWE</td> <td>SOUR:POW:MODE SWE</td> </tr> <tr> <td>SOUR:SWE:MODE AUTO</td> <td>SOUR2:SWE:MODE AUTO</td> <td>SOUR:SWE:POW:MODE AUTO</td> </tr> <tr> <td>TRIG:SOUR AUTO</td> <td>TRIG2:SOUR AUTO</td> <td>TRIG:SOUR AUTO</td> </tr> </table>	<b>RF sweep:</b>	<b>LF sweep:</b>	<b>Level sweep:</b>	SOUR:FREQ:MODE SWE	SOUR2:FREQ:MODE SWE	SOUR:POW:MODE SWE	SOUR:SWE:MODE AUTO	SOUR2:SWE:MODE AUTO	SOUR:SWE:POW:MODE AUTO	TRIG:SOUR AUTO	TRIG2:SOUR AUTO	TRIG:SOUR AUTO
<b>RF sweep:</b>	<b>LF sweep:</b>	<b>Level sweep:</b>											
SOUR:FREQ:MODE SWE	SOUR2:FREQ:MODE SWE	SOUR:POW:MODE SWE											
SOUR:SWE:MODE AUTO	SOUR2:SWE:MODE AUTO	SOUR:SWE:POW:MODE AUTO											
TRIG:SOUR AUTO	TRIG2:SOUR AUTO	TRIG:SOUR AUTO											
<b>Single</b>	<p>Single sweep from start point to stop point. The selection of Single does not start a sweep run. The sweep run is started by means of the Execute Single Sweep function, which is displayed below the Mode line.</p> <p>IEC/IEEE bus commands</p> <table border="0"> <tr> <td><b>RF sweep:</b></td> <td><b>LF sweep:</b></td> <td><b>Level sweep:</b></td> </tr> <tr> <td>SOUR:FREQ:MODE SWE</td> <td>SOUR2:FREQ:MODE SWE</td> <td>SOUR:POW:MODE SWE</td> </tr> <tr> <td>SOUR:SWE:MODE AUTO</td> <td>SOUR2:SWE:MODE AUTO</td> <td>SOUR:SWE:POW:MODE AUTO</td> </tr> <tr> <td>TRIG:SOUR SING</td> <td>TRIG2:SOUR SING</td> <td>TRIG:SOUR SING</td> </tr> </table>	<b>RF sweep:</b>	<b>LF sweep:</b>	<b>Level sweep:</b>	SOUR:FREQ:MODE SWE	SOUR2:FREQ:MODE SWE	SOUR:POW:MODE SWE	SOUR:SWE:MODE AUTO	SOUR2:SWE:MODE AUTO	SOUR:SWE:POW:MODE AUTO	TRIG:SOUR SING	TRIG2:SOUR SING	TRIG:SOUR SING
<b>RF sweep:</b>	<b>LF sweep:</b>	<b>Level sweep:</b>											
SOUR:FREQ:MODE SWE	SOUR2:FREQ:MODE SWE	SOUR:POW:MODE SWE											
SOUR:SWE:MODE AUTO	SOUR2:SWE:MODE AUTO	SOUR:SWE:POW:MODE AUTO											
TRIG:SOUR SING	TRIG2:SOUR SING	TRIG:SOUR SING											
<b>Step</b>	<p>Step-by-step, manual run within the sweep limits. Activating Step stops a running sweep and the cursor moves to the value indicated for Current. The sweep can now be controlled upwards or downwards in discrete steps using the rotary knob or the numeric keys.</p> <p>IEC/IEEE-bus commands:</p> <table border="0"> <tr> <td><b>RF sweep:</b></td> <td><b>LF sweep:</b></td> <td><b>Level sweep:</b></td> </tr> <tr> <td>SOUR:FREQ:MODE SWE</td> <td>SOUR2:FREQ:MODE SWE</td> <td>SOUR:POW:MODE SWE</td> </tr> <tr> <td>SOUR:SWE:MODE STEP</td> <td>SOUR2:SWE:MODE STEP</td> <td>SOUR:SWE:POW:MODE STEP</td> </tr> <tr> <td>TRIG:SOUR SING</td> <td>TRIG2:SOUR SING</td> <td>TRIG:SOUR SING</td> </tr> </table>	<b>RF sweep:</b>	<b>LF sweep:</b>	<b>Level sweep:</b>	SOUR:FREQ:MODE SWE	SOUR2:FREQ:MODE SWE	SOUR:POW:MODE SWE	SOUR:SWE:MODE STEP	SOUR2:SWE:MODE STEP	SOUR:SWE:POW:MODE STEP	TRIG:SOUR SING	TRIG2:SOUR SING	TRIG:SOUR SING
<b>RF sweep:</b>	<b>LF sweep:</b>	<b>Level sweep:</b>											
SOUR:FREQ:MODE SWE	SOUR2:FREQ:MODE SWE	SOUR:POW:MODE SWE											
SOUR:SWE:MODE STEP	SOUR2:SWE:MODE STEP	SOUR:SWE:POW:MODE STEP											
TRIG:SOUR SING	TRIG2:SOUR SING	TRIG:SOUR SING											
<b>Ext Single</b>	<p>Single sweep from start point to stop point as with Single, but triggered by an external signal</p> <p>IEC/IEEE-bus commands:</p> <table border="0"> <tr> <td><b>RF sweep:</b></td> <td><b>LF sweep:</b></td> <td><b>Level sweep:</b></td> </tr> <tr> <td>SOUR:FREQ:MODE SWE</td> <td>SOUR2:FREQ:MODE SWE</td> <td>SOUR:POW:MODE SWE</td> </tr> <tr> <td>SOUR:SWE:MODE AUTO</td> <td>SOUR2:SWE:MODE AUTO</td> <td>SOUR:SWE:POW:MODE AUTO</td> </tr> <tr> <td>TRIG:SOUR EXT</td> <td>TRIG2:SOUR EXT</td> <td>TRIG:SOUR EXT</td> </tr> </table>	<b>RF sweep:</b>	<b>LF sweep:</b>	<b>Level sweep:</b>	SOUR:FREQ:MODE SWE	SOUR2:FREQ:MODE SWE	SOUR:POW:MODE SWE	SOUR:SWE:MODE AUTO	SOUR2:SWE:MODE AUTO	SOUR:SWE:POW:MODE AUTO	TRIG:SOUR EXT	TRIG2:SOUR EXT	TRIG:SOUR EXT
<b>RF sweep:</b>	<b>LF sweep:</b>	<b>Level sweep:</b>											
SOUR:FREQ:MODE SWE	SOUR2:FREQ:MODE SWE	SOUR:POW:MODE SWE											
SOUR:SWE:MODE AUTO	SOUR2:SWE:MODE AUTO	SOUR:SWE:POW:MODE AUTO											
TRIG:SOUR EXT	TRIG2:SOUR EXT	TRIG:SOUR EXT											

<b>Ext Step</b>	Step-by-step run controlled by an external trigger signal. Each trigger event triggers a single step.		
	IEC/IEEE-bus commands:		
	RF sweep:	LF sweep:	Level sweep:
	SOUR:FREQ:MODE SWE	SOUR2:FREQ:MODE SWE	SOUR:POW:MODE SWE
	SOUR:SWE:MODE STEP	SOUR2:SWE:MODE STEP	SOUR:SWE:POW:MODE STEP
	TRIG:SOUR EXT	TRIG2:SOUR EXT	TRIG:SOUR EXT
<b>Off</b>	Switching-off sweep mode		
	IEC/IEEE-bus commands:		
	RF sweep:	LF sweep:	Level sweep:
	SOUR:FREQ:MODE CW	SOUR2:FREQ:MODE CW	SOUR:POW:MODE CW

## Sweep Inputs

<b>TRIG/STOP</b>	An external signal at the rear input triggers the sweep in the Ext Single and Ext Step modes or stops the sweep in all modes.
------------------	-------------------------------------------------------------------------------------------------------------------------------

## Sweep Outputs

The outputs X-AXIS, V/GHz, BLANK, MARKER and Z-AXIS at the rear of the instrument are available for controlling and triggering oscilloscopes or XY recorders.

<b>X-AXIS</b>	With the sweep switched on, this output supplies a voltage ramp of 0 to 10 V for the X deflection of an oscilloscope or an XY recorder.
<b>V/GHz</b>	This output supplies a voltage which is proportional to the frequency. The slope, either 0.5 V/GHz or 1 V/GHz, corresponds to a range of 5 mV to 10 V or 10 mV to 20 V for 10 MHz to 20 GHz. A slope of 5 V/GHz is available above 20 GHz (SMR27/SMR40). The slope can be set under Utilities - AuxIO - V/GHz. The voltage is always available, even with the sweep switched off.
<b>BLANK</b>	This output supplies a signal (0 V/5 V) for triggering and blanking an oscilloscope or for PEN LIFT control of an XY recorder. The signal duration can be set under Utilities - AuxIO - Blank Time.
<b>MARKER</b>	This output becomes active when the sweep run has reached the marker. The MARKER signal can be used for brightness control of an oscilloscope. Up to 10 markers can be set to mark positions in the sweep run. The duration of the active signal is equal to the dwell time (DWELL) of a step.
<b>Z-AXIS</b>	This output generates a pulse of -5 V if the MARKER output is active and +5 V if the BLANK output is active. The Z-AXIS signal can be used for the combined blanking and marker generation for network analyzers.



## Sweep timing, examples:

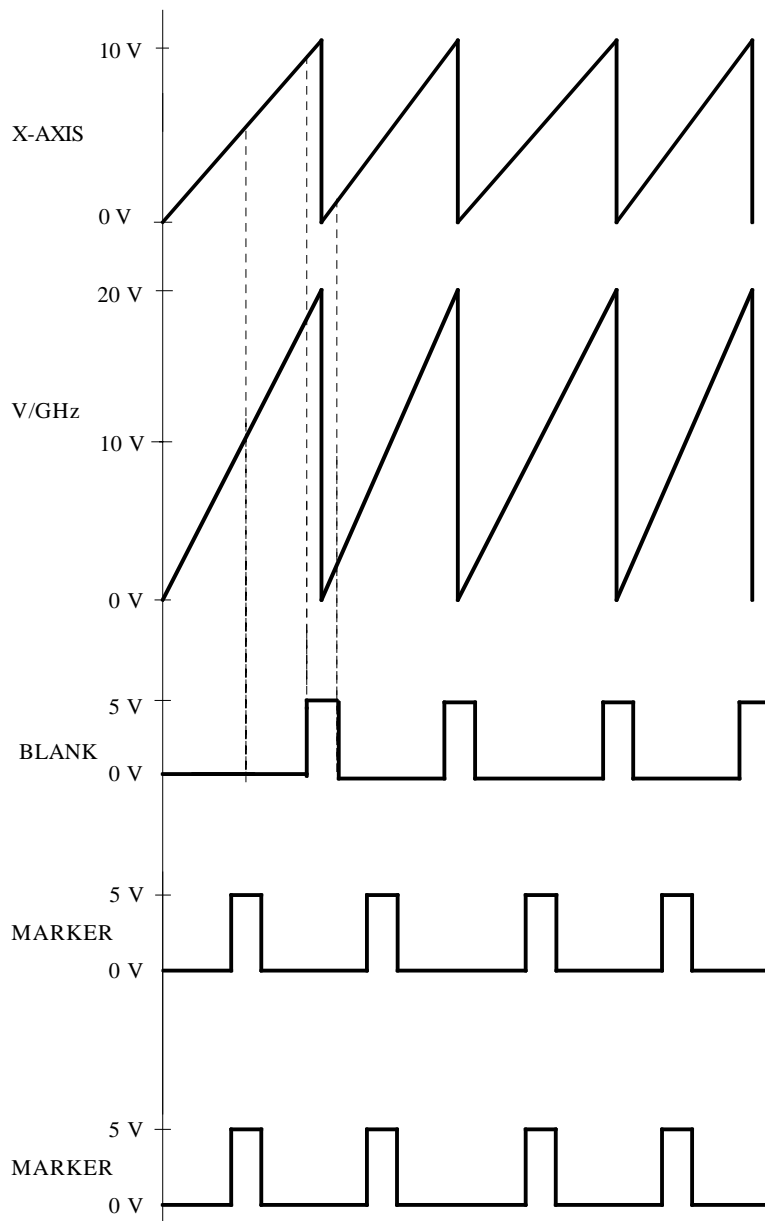

Fig. 4-21 Example of sweep signal 0 to 20 GHz: Mode = Auto, V/GHz = 1 V/GHz, Blank Time = Normal, Z-AXIS BLANK = +5 V, Z-AXIS MARKER = -5 V

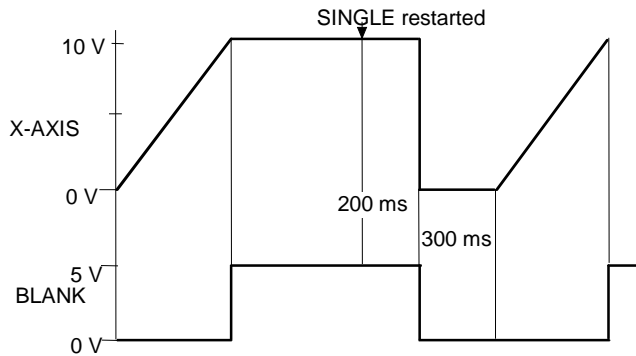

Fig. 4-22 Example of sweep signal: Mode = Single, Blank Time = Long

### RF Sweep

Settings for RF sweeps can be made in the Sweep - Freq menu.

Menu selection: Sweep - Freq

<b>11.000 000 0000 GHz</b>		<b>-20.0 dBm</b>
Sweep/Freq		
Start Freq	1.000 000 0000 GHz	
Stop Freq	5.000 000 0000 GHz	
Center Freq	3.000 000 0000 GHz	
Span	4.000 000 0000 GHz	
Current Freq	11.000 000 0000 GHz	
Spacing	Lin	
Step Lin	1.000 0000 MHz	
Dwell	15.0 ms	
Mode	Off	
Reset Sweep		
Marker 1		
Marker 2		
Marker 3		
Marker 4		
Marker 5		
Marker 6		
Marker 7		
Marker 8		
Marker 9		
Marker 10		
Back ↵		

Fig. 4-23 Sweep - Freq menu

<b>Start Freq</b>	Input value of start frequency IEC/IEEE-bus command : SOUR:FREQ:STAR 10GHz
<b>Stop Freq</b>	Input value of stop frequency IEC/IEEE-bus command : SOUR:FREQ:STOP 5GHz
<b>Center Freq</b>	Input value of center frequency IEC/IEEE-bus command : SOUR:FREQ:CENT 3GHz
<b>Span</b>	Input value of span IEC/IEEE-bus command : SOUR:FREQ:SPAN 4Hz
<b>Current Freq</b>	Display of current frequency value In Step mode: input value of frequency
<b>Spacing</b>	Selection of linear or logarithmic sweep IEC/IEEE-bus command : SOUR:SWE:SPAC LIN
<b>Spacing Lin</b>	Input value of step size. Depending on whether Spacing Lin or Log is selected, Step Lin or Step Log is displayed. IEC/IEEE-bus command : SOUR:SWE:STEP:LIN 1MHz
<b>Dwell</b>	Input value of dwell time per step IEC/IEEE-bus command : SOUR:SWE:DWEL 15ms
<b>Mode</b>	Selection of sweep mode IEC/IEEE-bus commands : SOUR:FREQ:MODE SWE; : SOUR:SWE:MODE AUTO; : TRIG:SOUR SING
<b>Reset Sweep</b>	Sets the start frequency IEC/IEEE-bus command : ABOR
<b>Exec Single Sweep</b>	Starts a single sweep. This function is displayed and is effective only if Single Mode is selected. IEC/IEEE-bus command : TRIG
<b>Marker 1-10 Freq</b>	Input value of frequency for the selected marker IEC/IEEE-bus command : SOUR:MARK1:FREQ 10GHz
<b>Marker 1-10 State</b>	Switching on/off selected marker IEC/IEEE-bus command : SOUR:MARK1 OFF
<b>Marker 1-10 Amplitude</b>	Switching on/off selected amplitude marker Off Amplitude marker is switched off. On Amplitude marker is switched on. The output level is reduced by 1 dB on attaining the marker. IEC/IEEE-bus command : SOUR:MARK1:AMPL OFF

## Level Sweep

Settings for level sweeps can be made in the Sweep - Level menu.

Menu selection: Sweep - Level

11.000 000 000 0 GHz		-20.0 dBm	
Sweep/Level			
Start Level		-30.0 dBm	
Stop Level		-10.0 dBm	
Current Level		-20.0 dBm	
Step		1.0 dB	
Dwell		15.0 ms	
Mode		Off	
Reset Sweep			
Marker 1			
Marker 2			
Marker 3			
Back ↵			

Fig. 4-24 Sweep - Level menu

<b>Start Level</b>	Input value of start level IEC/IEEE-bus command	: SOUR: POW: STAR -30dBm
<b>Stop Level</b>	Input value of stop level IEC/IEEE-bus command	: SOUR: POW: STOP -10dBm
<b>Current Level</b>	Display of current level In Step mode: Input value of level	
<b>Step</b>	Input value of step size IEC/IEEE-bus command	: SOUR: SWE: POW: STEP 1dB
<b>Dwell</b>	Input value of dwell time per step IEC/IEEE-bus command	: SOUR: SWE: POW: DWEL 15ms
<b>Mode</b>	Selection of sweep mode (see "Operating Modes") IEC/IEEE-bus command	: SOUR: POW: MODE SWE; : SOUR: SWE: POW: MODE AUTO; : TRIG: SOUR SING
<b>Reset Sweep</b>	Sets the start level IEC/IEEE-bus command	: ABOR
<b>Exec Single Sweep</b>	Starts a single sweep. This function is displayed and is effective only if Single Mode is selected. IEC/IEEE-bus command	: TRIG
<b>Marker 1-3 Level</b>	Input value of level for the selected marker IEC/IEEE-bus command	: SOUR: MARK1: PSW: POW 1dBm

**Marker 1-3 State**

Switching on/off selected marker

IEC/IEEE-bus command : SOUR:MARK1:PSW OFF

**LF Sweep**

Settings for LF sweeps can be made in the Sweep - Lfgen menu.

Menu selection: Sweep - Lfgen

11.000 000 0000 GHz		-20.0 dBm	
Sweep/Lfgen			
Start Freq		1.0000 kHz	
Stop Freq		100.0000 kHz	
Current Freq		1.0000 kHz	
Spacing		Lin	
Step Lin		1.0000 kHz	
Dwell		15.0 ms	
Mode		Off	
Reset Sweep			
Marker 1			
Marker 2			
Marker 3			
Back ↵			

Fig. 4-25 Sweep - Lfgen menu

<b>Start Freq</b>	Input value of start frequency IEC/IEEE-bus command : SOUR2:FREQ:STAR 0kHz
<b>Stop Freq</b>	Input value of stop frequency IEC/IEEE-bus command : SOUR2:FREQ:STOP 100kHz
<b>Current Freq</b>	Display of current frequency value In Step mode: input value of frequency
<b>Spacing</b>	Selection of linear or logarithmic sweep IEC/IEEE-bus command : SOUR2:SWE:SPAC LIN
<b>Step Lin</b>	Input value of step size IEC/IEEE-bus command : SOUR2:SWE:STEP:LIN 1kHz
<b>Dwell</b>	Input value of dwell time per step IEC/IEEE-bus command : SOUR2:SWE:DWEL 15ms
<b>Mode</b>	Selection of sweep mode (see "Operating Modes") IEC/IEEE-bus command : SOUR2:FREQ:MODE SWE : SOUR2:SWE:MODE AUTO : TRIG2:SOUR SING

<b>Reset Sweep</b>	Sets the start frequency IEC/IEEE-bus command : ABOR
<b>Exec Single Sweep</b>	Starts a single sweep. This function is displayed and is effective only if Single Mode is selected. IEC/IEEE-bus command : TRIG
<b>Marker 1-3 Freq</b>	Input value of frequency for the selected marker IEC/IEEE-bus command : SOUR2:MARK1:FREQ 100kHz
<b>Marker 1-3 State</b>	Switching on/off selected marker IEC/IEEE-bus command : SOUR2:MARK1 OFF

## List Mode

In the list mode, a sequence of predefined frequency and level points is executed, similar as in the sweep mode. Differently from the sweep mode, a list of freely selectable pairs of values (frequency and level) can be generated. The available frequency range corresponds to the settable frequency range of the instrument. The level range is 20 dB. If the permissible level range is exceeded, the level error increases.

Table 4-4 List mode, typical list

Index	Frequency	Level
0001	2 GHz	0 dBm
0002	10 GHz	13 dBm
0003	15 GHz	7 dBm
0003	3 GHz	5 dBm
:	:	:

Up to 10 lists can be created. The total number of possible pairs of values including all lists must not exceed 2000, ie a list may have 2000 entries at the most, or fewer entries if several lists have been created.

Each list is assigned a separate name and selected by means of this name. A detailed description of the editing function will be found in the section "List Editor".

## Operating Modes (Mode)

The following list modes are available:

**Auto** Run from the beginning to the end of a list with automatic restart at the beginning. If a different mode was active prior to selection of the Auto mode, the list run is continued from the current index.

```
IEC/IEEE-bus commands:  : SOUR:FREQ:MODE LIST
                        : SOUR:LIST:MODE AUTO
                        : TRIG:LIST:SOUR AUTO
```

**Single** Single run from the beginning to the end of the list. The selection of Single does not start a list run. The list run is started by means of the Execute Single List function, which is displayed below the Mode line.

```
IEC/IEEE-bus commands:  : SOUR:FREQ:MODE LIST
                        : SOUR:LIST:MODE AUTO
                        : TRIG:LIST:SOUR SING
```

**Step** Step-by-step manual processing of list. Activating Step stops a running list and the cursor moves to the value indicated for Current Index. The list can now be scrolled upwards or downwards in discrete steps using the rotary knob or the numeric keys.

```
IEC/IEEE-bus commands:  : SOUR:FREQ:MODE LIST
                        : SOUR:LIST:MODE STEP
                        : TRIG:LIST:SOUR SING
```

<b>Ext Single</b>	Single list run from the beginning to the end of the list as with Single, but triggered by an external signal IEC/IEEE-bus commands:       : SOUR:FREQ:MODE LIST : SOUR:LIST:MODE AUTO : TRIG:LIST:SOUR EXT
<b>Ext Step</b>	Step-by-step run controlled by an external trigger signal. Each trigger event triggers a single step. IEC/IEEE-bus commands:       : SOUR:FREQ:MODE LIST : SOUR:LIST:MODE STEP : TRIG:LIST:SOUR EXT
<b>Off</b>	Switching-off of list mode IEC/IEEE-bus command:       : SOUR:FREQ:MODE CW

## Inputs/Outputs

The TRIG/STOP input, BLANK output and the MARKER output at the rear of the instrument are available for synchronization with other instruments and units.

<b>TRIG/STOP</b>	An external signal at this input triggers the list mode in the Ext Single and Ext Step operating modes.
<b>BLANK</b>	This output supplies a signal (0 V / 5 V) for blanking the transient response by means of pulse modulation or AM. The signal can also be used to synchronize other instruments.
<b>MARKER</b>	This output supplies a trigger signal immediately after blanking at the first step of each operating mode of the list mode. This signal can be used for accurate synchronization with short dwell times to trigger other instruments, and indicates the first stable output frequency occurring.

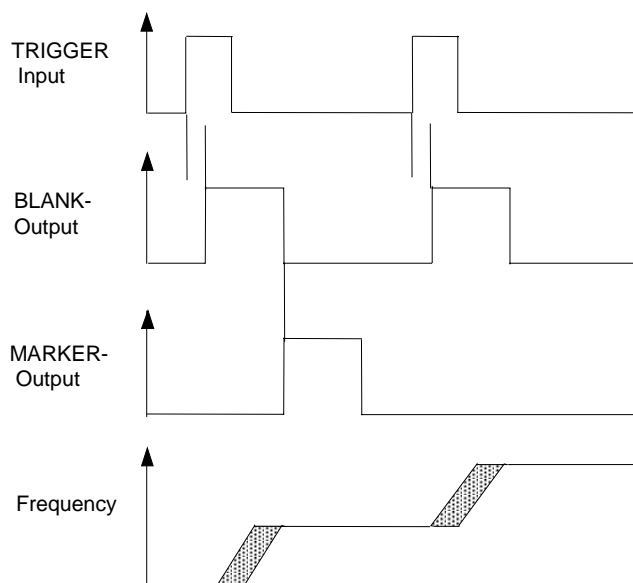

Fig. 4-26 Example of signal in list mode: Mode = Ext Step



Settings for the list mode can be made in the List menu.

Menu selection: List

10.000 000 0000 GHz		-20.0 dBm	
List			
Mode		Off	
Reset List			
Dwell		15.0 ms	
Current Index		1	
Select List		List0	
Delete List			
Edit List		Insert	
Back ↵			

Fig. 4-27 List menu

<b>Mode</b>	Selection of operating mode (see Section "Operating Modes"). IEC/IEEE-bus commands : :SOUR:FREQ:MODE LIST; :SOUR:LIST:MODE AUTO; :TRIG:LIST:SOUR SING
<b>Execute Single List</b>	Starts a single run of the list. This menu option is visible only if Mode = Single is selected. IEC/IEEE-bus command :TRIG:LIST
<b>Reset List</b>	Selects the starting point. IEC/IEEE-bus command :ABOR:LIST
<b>Dwell</b>	Input value of dwell time per step. IEC/IEEE-bus command :SOUR:LIST:DWEL 10ms
<b>Current Index</b>	Display of current level. In Step mode: input value of current list index.
<b>Select List</b>	Selection of a list or creation of a new list (cf. Chapter 3, Section "List Editor"). IEC/IEEE-bus command :SOUR:LIST:SEL "LIST2"
<b>Delete List</b>	Deletion of a list (cf. Chapter 3, Section "List Editor"). IEC/IEEE-bus command :SOUR:LIST:DEL "LIST1"
<b>Edit List</b>	Selection of editor function for editing a list (cf. Chapter 3, Section "List Editor"). IEC/IEEE-bus command :SOUR:LIST:FREQ 100MHz,1.2GHz; POW 0dBm,6dBm

The selection window of the List menu opens automatically if one of the editor functions of the Edit List line (Insert, Fill, Edit/View, Delete) is selected. The list indicated in the Select List line is displayed.

11.000 000 000 0 GHz		-20.0 dBm	
List/Edit			
0001	10.0000000000 GHz	0.0 dBm	List0
0002	11.0000000000 GHz	1.0 dBm	Free 1989
0003	12.0000000000 GHz	2.0 dBm	Len 0011

Fig. 4-28 List menu – selection window

<b>List</b>	Indication of item number of list.
<b>Free</b>	Available space. Free 1989, for example, means that there is free space for a total of 1989 pairs of values (elements) in the list memory.
<b>Len</b>	Occupied space. Len 0011, for example, means that the current list occupies 11 elements in the list memory.

## Memory Sequence

In the memory sequence mode the instrument automatically processes a list with stored instrument settings. Memory locations 1 to 50 are available to which settings are stored with Save. Stored settings are called either separately using Recall or automatically and one after the other in the memory sequence mode.

The list is continuously processed from the beginning to the end with consecutive indexes. The order of processed memory locations is arbitrary. Each setting can be assigned a selectable dwell. The dwell determines the duration of the setting, its minimum value is 50 ms, its maximum value 60 s.

The list is organized in three columns for the index, memory location number (Memory) and dwell. The list starts with the index 001.

Table 4-5 Memory sequence; example of list

Index	Memory	Dwell
001	09	50.0 ms
002	02	50.0 ms
003	01	75.0 ms
004	10	75.0 ms
...	...	...

Up to 10 sequence lists can be created. The total number of possible list elements must not exceed 256, ie a list may have 256 entries at the most, or fewer entries if several lists have been created.

Each list is assigned a separate name and selected by means of this name. A detailed description the editing function will be found in Chapter 3, Section "List Editor".

**Note:** *Frequent level changes in the memory sequence mode may stress the mechanically switched attenuator. The attenuator is actuated when AM is switched on or off, for example. For this reason we recommend that you use non-interrupting level setting as far as possible or use the setting AM 0% instead of switching AM off.*

## Operating Modes (Mode)

The following operating modes are available:

**Auto** Run from the beginning to the end of the list with automatic restart at the beginning. If a different mode was active prior to selection of the Auto mode, the list run is continued from the current index.

IEC/IEEE-bus commands: :SYST:MODE MSEQ  
:SYST:MSEQ:MODE AUTO  
:TRIG:MSEQ:SOUR AUTO

<b>Single</b>	<p>Single run from the beginning to the end of the list. The selection of Single does not start a list run. The list run is started by means of the Execute Single Sequence function, which is displayed below the Mode line.</p> <p>IEC/IEEE-bus commands:   :SYST:MODE MSEQ                                          :SYST:MSEQ:MODE AUTO                                          :TRIG:MSEQ:SOUR SING</p>
<b>Step</b>	<p>Step-by-step manual processing of list. Activating Step stops a running sequence and the cursor moves to the value indicated for Current Index. The list can now be scrolled upwards or downwards in discrete steps using the rotary knob.</p> <p>IEC/IEEE-bus commands:   :SYST:MODE MSEQ                                          :SYST:MSEQ:MODE STEP                                          :TRIG:MSEQ:SOUR SING</p>
<b>Ext Single</b>	<p>Single run from the beginning to the end of the list as with Single, but triggered by an external signal.</p> <p>IEC/IEEE-bus commands:   :SYST:MODE MSEQ                                          :SYST:MSEQ:MODE AUTO                                          :TRIG:MSEQ:SOUR EXT</p>
<b>Ext Step</b>	<p>Step-by-step run controlled by an external trigger signal. Each trigger event triggers a single step.</p> <p>IEC/IEEE-bus commands:   :SYST:MODE MSEQ                                          :SYST:MSEQ:MODE STEP                                          :TRIG:MSEQ:SOUR EXT</p>
<b>Off</b>	<p>Switching-off the memory sequence mode.</p> <p>IEC/IEEE-bus command     :SYST:MODE FIX</p>

## External Trigger

An external signal applied to the rear TRIG/STOP input can be used to trigger the memory sequence in the Ext Single and Ext Step operating modes. The polarity of the active trigger edge can be set in the Utilities - AuxIO - Ext Trig Slope menu.

Settings for the memory sequence mode can be made in the MemSeq menu.

Menu selection: MemSeq

10.0000000000 GHz		-20.0 dBm	
MemSeq			
Mode		Off	
Reset List			
Current Index		1	
Select List		MSeq0	
Delete List			
Edit List		Insert	
Back ↵			

Fig. 4-29 MemSeq menu (preset setting)

<b>Mode</b>	Selection of operating mode; setting the operating mode affects several command systems on the IEC/IEEE bus (see above).
<b>Exec Single Sequence</b>	Starts a single memory sequence run. This menu option is visible only if Mode = Single is selected. IEC/IEEE-bus command :TRIG:MSEQ
<b>Reset List</b>	Return to the beginning of the list. IEC/IEEE-bus command :ABOR:MSEQ
<b>Current Index</b>	Display of current list index. In Step mode: setting value of current list index.
<b>Select List</b>	Selection of a list or creation of a new list (cf. Chapter 3, Section "List Editor"). IEC/IEEE-bus command :SYST:MSEQ:SEL "MSEQ1"
<b>Delete List</b>	Deletion of a list (cf. Chapter 3, Section "List Editor"). IEC/IEEE-bus command :SYST:MSEQ:DEL "MSEQ2"
<b>Edit List</b>	Selection of editor function for editing a list (cf. Chapter 3, Section "List Editor"). IEC/IEEE-bus command :SYST:MSEQ 9,2,...;DWEL 50ms, 50ms,...
<b>Note:</b>	<i>When lists are edited in the Memory Sequence mode, parameters Memory and Dwell are displayed (instead of parameters Frequency and Power presented in the example of List mode, Chapter 3, Section "List Editor").</i>

The selection window of the MemSeq menu opens automatically if one of the editor functions of the Edit List line (Insert, Fill, Edit/View, Delete) is selected. The list indicated in the Select List line is displayed.

Menu selection: MemSeq

11.000 000 0000 GHz		-20.0 dBm	
MemSeq/Edit			
0001	001	100.0 ms	MSeq0
0002	002	100.0 ms	Free 0246
0003	003	100.0 ms	Len 0010

Fig. 4-30 MemSeq menu – selection window

<b>MSeq</b>	Index of list.
<b>Free</b>	Indication of empty locations of list.
<b>Len</b>	Length of current list.

## Utilities

The Utilities menu contains submenus for general functions not directly related to signal generation.

Menu selection: Utilities

11.000 000 000 0 GHz		-20.0 dBm	
Utilities			
Display	System	Ref Osc	Protect
Calib	Diag	Test	Mod Key
Aux I/O	Setup	Install	Back ↵

Fig. 4-31 Utilities menu

## Display

Menu Utilities – Display offers the contrast settings of the display. Setting range is 0 to 63.

Menu selection: Utilities - Display

10.000 000 000 0 GHz		-20.0 dBm	
Utilities/Display			
Contrast			32
Back ↵			

Fig. 4-32 Utilities - Display menu

## System

Menu selection: Utilities - System

10.000 000 000 0 GHz		-20.0 dBm	
Utilities/System			
GPIB	RS232	Security	Language
Back ↵			

Fig. 4-33 Utilities - System menu

### IEC/IEEE-Bus Address (System - GPIB)

Access to the remote-control address is offered by the System - GPIB – Address submenu. The setting range is 0 to 30. The address is factory-set to 28.

Menu selection: Utilities - System - GPIB - Address

11.000 000 000 0 GHz		-20.0 dBm	
Utilities/System/GPIB			
GPIB-Address		28	
Back ↵			

Fig. 4-34 Utilities - System - GPIB - Address menu

**GPIB-Address** Input value of IEC/IEEE-bus address.  
 IEC/IEEE-bus command : SYST:COMM:GPIB:ADDR 28



### Parameters of RS-232-C Interface (System - RS232)

Settings for the configuration of the RS-232-C interface can be made in the System - RS232 submenu. The pin assignment of the interface corresponds to that of a PC.

Menu selection: Utilities - System - RS232

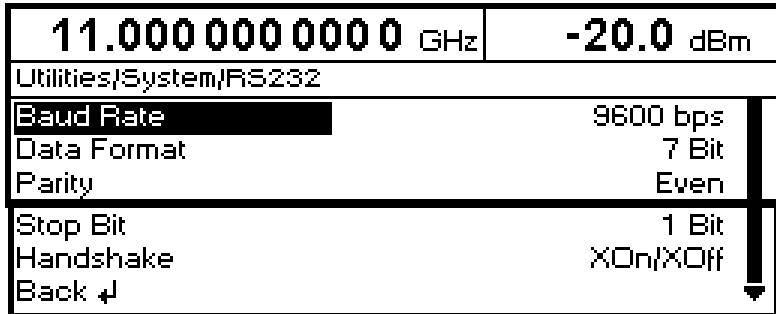

Fig. 4-35 Utilities - System - RS232 menu

- Baud Rate** Selection of transmission rate.  
IEC/IEEE-bus command : SYST:COMM:SER:BAUD 9600
- Data Format** Indication of number of data bits. This value is permanently set and cannot be changed.
- Parity** Setting of parity. This setting defines the transmission mode for the parity bit for error protection. The following modes are available:  
 Odd (odd parity)  
 Even (even parity)  
 None (no parity)  
 IEC/IEEE-bus command : SYST:COMM:SER:PAR ODD
- Stop Bit** Indication of number of stop bits. This value is permanently set and cannot be changed.
- Handshake** Selection of handshake

  - None No handshake  
IEC/IEEE-bus command : SYST:COMM:SER:PACE NONE  
: SYST:COMM:SER:CONT:RTS ON
  - RTS/CTS Hardware handshake via interface lines RTS and CTS. This setting is to be preferred to the XON/XOFF setting if the host computer permits it.  
IEC/IEEE-bus command : SYST:COMM:SER:CONT:RTS RFR
  - XON/XOFF Software handshake via ASCII codes 11h <XON> and 13h <XOFF>. This setting should not be used for binary data transmission and for baud rates higher than 9600 baud.  
IEC/IEEE-bus command : SYST:COMM:SER:PACE XON

## Suppression of Indications and Clearing of Memories (System - Security)

For reasons of security, indications can be suppressed and memories cleared in the System - Security submenu.

Menu selection: Utilities - System - Security



Fig. 4-36 Utilities - System - Security menu

<b>State</b>	Selection of Security status.	
	On	Locks the suppression of indications. Can be set only via the IEC/IEEE bus.
	Off	Deactivates the interlock of the indication suppression. On the ON→OFF transition, the preset state is set, and all data such as stored settings, user correction and list settings are saved. Can be set only via the IEC/IEEE bus.
	IEC/IEEE-bus command : SYST:SEC OFF	
<b>Annotation Freq</b>	Off	All frequency indications are suppressed.
	On	The frequency setting is displayed.
		IEC/IEEE-bus command : DISP:ANN:FREQ ON
<b>Annotation Amplitude</b>	Off	All level indications are suppressed.
	On	The level setting is displayed.
		IEC/IEEE-bus command : DISP:ANN:AMPL ON
<b>Clear Memory</b>	Clearing of all stored data, such as stored settings, user correction and list settings	
	Two IEC/IEEE-bus commands are required for this action:	
	IEC/IEEE-bus command : SYST:SEC ON; SEC OFF	

## Indication of IEC/IEEE-Bus Language (System - Language)

The Utilities - System - Language submenu indicates the IEC/IEEE-bus language and the current SCPI version.

### Internal/External Reference Frequency (RefOsc)

In the internal-reference mode, the internal reference signal with a frequency of 10 MHz is available at the REF socket on the rear of the instrument.

Signal level:  $V_{rms}$  (EMF, sine) = 1 V

In the external-reference mode, an external signal with a frequency of 1 MHz to 16 MHz (steps: 1 MHz) is to be fed to the REF socket . The external-reference mode can be selected in the Utilities - RefOsc menu.

Signal level:  $V_{rms}$  = 0.1 V to 2 V

If the external-reference mode is selected, the information "Ext Ref" is displayed in the status line.

Settings for the reference frequency can be made in the RefOsc menu.

Menu selection: Utilities - RefOsc

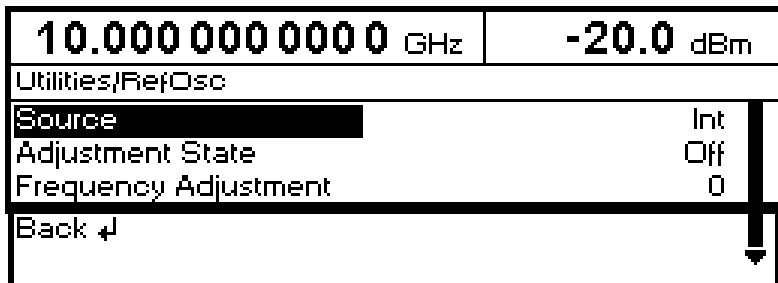

Fig. 4-37 Utilities - RefOsc menu (preset setting)

<b>Source</b>	Selection of operating mode	
	Int	Internal-reference mode
	Ext	External-reference mode
	IEC/IEEE bus command :ROSC:SOUR INT	
<b>Adjustment State</b>	Off	Tuning value of internal reference frequency as calibrated (see Utilities – Calib menu)
	On	Tuning value corresponding to value set under Frequency Adjustment. The OCXO Reference Oscillator (option SMR-B1) is switched off. Only the standard reference oscillator is on.
	IEC/IEEE-bus command :ROSC:ADJ:STAT ON	
<b>Frequency Adjustment</b>	Input value in the range -2048 to +2047 for setting the internal reference frequency. Pull-in range $\pm 4 \times 10^{-6}$	
	IEC/IEEE bus command :ROSC:ADJ:VAL 2047	

## Passwords for Accessing Protected Functions (Protect)

Calibration and service functions are password-protected. To access these functions, passwords (6-digit numbers) have to be entered and confirmed with the [ENTER] key. These functions are automatically locked out on power-up of the instrument.

- Password 1    deactivates the lock for the calibration of Level, Mainboard, Lfgen and Loopgain.
- Password 2    deactivates the lock for the calibration of RefOsc.
- Password 3    enables input of the serial number and the count for POWER ON, operating hours and attenuator operating cycles.

Access to protected functions is possible in the Utilities - Protect menu.

Menu selection:    Utilities - Protect

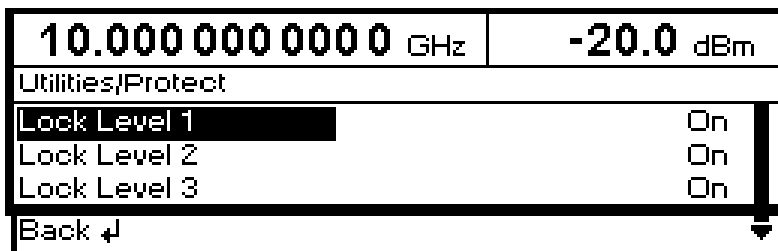

Fig. 4-38    Utilities - Protect menu (preset setting)

Lock Level x	Activation/deactivation of lock
On	The lock is active. IEC/IEEE-bus command    :SYST:PROT1 ON
Off	The entry of the password is enabled automatically. The entry of the password must be confirmed with [ENTER]. After the password has been entered, the lock is deactivated. IEC/IEEE-bus command: SYST:PROT1 OFF, 123456

## Calibration (Calib)

The Utilities - Calib menu offers access to calibration routines and correction values for the purpose of servicing.

Menu selection: Utilities - Calib

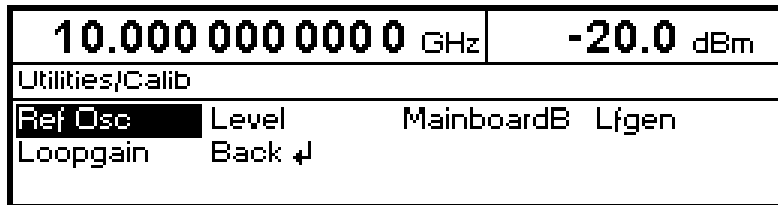

Fig. 4-39 Utilities - Calib menu (preset setting)

Utilities - Calib -	RefOsc	(see service manual instrument)
	Level	(see service manual instrument)
	MainboardB	(see service manual instrument)
	Lfgen	(see service manual instrument)
	Loopgain	(see service manual instrument)

**Note:** Run calibration routines only when the instrument has warmed up.

The calibration routines RefOsc, Level, MainboardB, Lfgen and Loopgain are described in the service manual for the instrument.

### Display of Module Versions (Diag - Config)

The versions and modification states of the modules installed can be displayed for servicing purposes. The modules can be displayed in the Utilities - Diag - Config menu.

Menu selection: Utilities - Diag - Config

10.000 000 000 0 GHz		-20.0 dBm	
Utilities/Diag/Config			
DBL	Var 2	Rev 0	
DMA	Var 2	Rev 0	
FILT	Var 2	Rev 0	

Fig. 4-40 Utilities - Diag - Config menu

IEC/IEEE-bus command :DIAG:INFO:MOD?

For further information see Service Manual Instrument.

## Display of Voltages of Test Points (Diag-TPoint)

Access to internal test points is offered by the Diag - TPoint submenu. If a test point is switched on, the voltage is displayed in a window in the header field. For more detailed information see service manual for the instrument.

Menu selection: Utilities – Diag - TPoint



Fig. 4-41 Utilities – Diag – TPoint menu

**State** Switching on/off the voltage display in the header field.

**Test Point** Input value of test point.  
IEC/IEEE-bus command :DIAG:POINxx?

### Display of Service Data (Diag-Param)

The Diag - Param submenu offers access to various parameters such as serial number, software version, operating-hours counter and attenuator operating cycles.

Menu selection: Utilities - Diag - Param

10.0000000000 GHz		-20.0 dBm	
Utilities/Diag/Param			
Serial No.	0123 4567.8		
Software Version	2.11		
Software Date	Jan 12 1999		
Power On Count	0		
Operation Time	0 h		
Atten Count 10dB Z1	0		
Atten Count 27dB Z2	0		
Atten Count 40dB Z3	0		
Atten Count 40dB Z4	0		
Back ↵			

Fig. 4-42 Utilities - Diag - Param menu

For information on IEC/IEEE-bus commands see section "DIAGnostic - System".



## Test

The SMR carries out a selftest on switching on the instrument and permanently during operation. On switching on, the RAM and ROM contents are checked and the batteries of the non-volatile RAMs are tested. If an error is detected, this is indicated through a corresponding error message. The most important instrument functions are automatically monitored during operation.

If a faulty function is detected in the selftest, ERROR is displayed in the status line. To identify the error, the ERROR menu, in which the error messages are entered, can be called by pressing the [ERROR] key (cf. Chapter 9, "Error Messages"). The tests can additionally be called via the menu.

Access to the tests is offered by the Utilities - Test menu.

Menu selection: Utilities - Test

10.000 000 000 0 GHz	-20.0 dBm
Utilities/Test	
EPROM	Not tested
RAM	Not tested
RAM-Battery	Not tested
Back ↵	

Fig. 4-43 Menu Utilities - Test

<b>EPROM</b>	Tests the EPROM. The test result is displayed in a window. IEC/IEEE-bus-command :TEST:ROM?
<b>RAM</b>	Tests the RAM. The test result is displayed in a window. IEC/IEEE-bus-command :TEST:RAM?
<b>RAM-Battery</b>	Tests the RAM battery. The test result is displayed in a window. IEC/IEEE-bus-command :TEST:BATT?

## Assigning Modulations to the [MOD ON/OFF] Key (ModKey)

Modulation types can be switched on/off in the modulation menus and with the [MOD ON/OFF] key.

It can be defined in the Utilities - ModKey menu for which modulation types the [MOD ON/OFF] key is to be effective. The key is effective either for all types of modulation or only for a selected modulation.

Function of [MOD ON/OFF] key if effective for only one type of modulation:

- The status (on/off) of the selected modulation type will change at each keypress.

Function of [MOD ON/OFF] key if effective for all types of modulation (All):

- If at least one type of modulation is switched on, pressing of the [MOD ON/OFF] key will switch off the modulation(s). The modulation types previously active are stored.

If no modulation type is switched on, pressing the [MOD ON/OFF] key will switch on the types of modulation last switched off with the [MOD ON/OFF] key.

If switch-on is made with the [MOD ON/OFF] key, the modulation sources set in the modulation menus are used.

The modulation types to be switched on or off with the [MOD ON/OFF] key can be selected in the Utilities - ModKey menu.

Menu selection: Utilities - ModKey

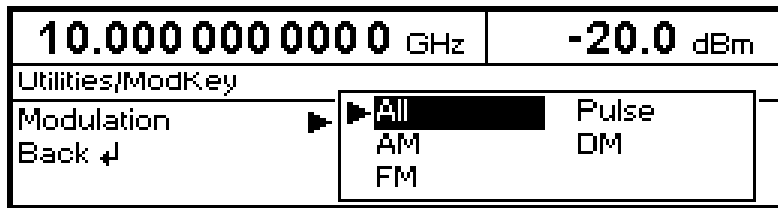

Fig. 4-44 Utilities - ModKey menu (preset setting)

### Modulation

Selection of modulation type(s) for which the [MOD ON/OFF] key is to be effective.

**Note:** *Preset switches off all modulations, sets this parameter to All and stores AM 30% as default setting.*

### Setting the Auxiliary Inputs/Outputs (AUX-I/O)

Settings for the BLANK output and the V/GHz output can be made in the Utilities - AuxIO menu. For more detailed information see sections Seep, List Mode and Memory Sequence.

Menu selection: Utilities - AuxIO



Fig. 4-45 Utilities - AuxIO menu

#### Sweep Blank Time

Selection of blank duration

Norm The blank duration is set to the shortest possible time.

Long The blank duration is set for the PEN LIFT control of an XY recorder (approx. 500 ms).

IEC/IEEE-bus command : SOUR2:SWE:BTIM NORM

#### V/GHz

Selection of the slope of the signal at the V/GHz output.

IEC/IEEE-bus command : OUTP3:SCAL 0.5

## Setup (Setup)

Settings for Rf Blanking and Alc Slope can be made in the Utilities - Setup menu. If one of these parameters is selected, a pop-up menu displays the available settings.

Menu selection: Utilities - Setup



Fig. 4-46 Utilities - Setup menu

### Rf Blanking

Selection of the RF blanking method for sweeps with step widths less than 10 MHz.

Auto RF blanking only when the step synthesizer switches to the next step (provides a clean RF spectrum).

Off No RF blanking.

On RF blanking after each step.

### Alc Slope

Selection of RF power slew rate.

Fast Fast (nominal setting)

Medium Medium slew rate

Slow Low slew rate

## Help System

The SMR offers two help systems. For one, there is context-sensitive help which is called with the [HELP] key and provides information on the current menu. For another, there is the HELP menu from which help texts can be selected from an alphabetical subject index.

### [HELP] Key

The [HELP] key can be pressed at any time. The current setting menu will then be blanked and the context-sensitive text inserted. The help panel can be exited by means of the [BACK] key.

### Help Menu

After calling the Help menu, access can be made to any desired help text via an index. Operation is analogous to menu operation.

- Use the rotary knob to set the menu cursor to the desired key word.
- Press the [SELECT] key.
- The information on the marked key word is displayed.
- Press the [BACK] key to exit the menu.

## Status

The SMR has a STATUS page which provides an overview of all instrument settings. The settings are displayed in abbreviated form. The STATUS page is called by pressing the [STATUS] key. Return to the previous menu is made with the [BACK] key.

10.000 000 0000 GHz		-20.0 dBm	
Status			
Am	Off		
Fm	Off		
Pulse	Off		
Dm	Off		
Lf	Off		
Sweep	Off		
List	Off		
Blank Time	Norm		
Afc	On		
Both	Unlocked		
Back ↵			

Fig. 4-47 STATUS menu

## 5 Remote Control – Basic Information

This chapter provides basic information on remote control, for example on the IEC/IEEE bus, RS-232-C interface, interface and device messages, command processing, status reporting system, etc.

The instrument is equipped with an IEC/IEEE-bus interface according to standard IEC 625.1/IEEE 488.1 and two RS-232-C interfaces. The connectors are located at the rear of the instrument and permit to connect a controller for remote control. The instrument supports the SCPI version 1994.0 (Standard Commands for Programmable Instruments). The SCPI standard is based on standard IEEE 488.2 and aims at the standardization of device-specific commands, error handling and the status registers.

For this section it is assumed that the user has basic knowledge of IEC/IEEE-bus programming and operation of the controller. A description of the interface commands will be found in the relevant manuals.

The requirements of the SCPI standard regarding command syntax, error handling and configuration of the status registers are explained in detail in the respective sections. Tables provide a fast overview of the bit assignment of the status registers. The tables are complemented by a comprehensive description of the status registers.

A description of commands is given in chapter 6. Programming examples for the main functions will be found in chapter 7.

### Brief Instructions

The short and simple operating sequence given below permits fast putting into operation of the instrument and setting of its basic functions.

#### IEC/IEEE Bus

It is assumed that the IEC/IEEE-bus address, which is factory-set to 28, has not been changed.

1. Connect the instrument and the controller using the IEC/IEEE-bus cable.
2. Write and start the following program on the controller:

CALL IBFIND("DEV1", generator%)	Open port to instrument
CALL IBPAD(generator%, 28)	Transfer instrument address to controller
CALL IBWRT(generator%, "*RST;*CLS")	Reset instrument
CALL IBWRT(generator%, "FREQ 5GHz")	Set frequency to 5 GHz
CALL IBWRT(generator%, "POW -7.3dBm")	Set output level to -7.3 dBm
CALL IBWRT(generator%, "OUTP:STAT ON")	Switch RF output on
CALL IBWRT(generator%, "AM:SOUR INT")	Set AM modulation source Lfgen
CALL IBWRT(generator%, "AM:INT:FREQ 15kHz")	Set AM modulation frequency to 15 kHz
CALL IBWRT(generator%, "AM 30PCT")	Set AM modulation depth to 30%
CALL IBWRT(generator%, "AM:STAT ON")	Switch on AM

An amplitude-modulated signal is now present at the output of the instrument.

3. To return to manual control, press the [LOCAL] key on the front panel.

**RS-232-C Interface**

It is assumed that the configuration of the RS-232-C interface of the unit has not yet been changed.

1. Connect the unit and the controller using the null modem cable.
2. Enter the following command on the controller to configure the controller interface:  
mode com1: 9600, n, 8, 1
3. Create the following ASCII file on the controller:

*RST; *CLS	Switch instrument to remote control (RETURN)
FREQ 5GHz	Reset instrument
POW -7.3dBm	Set frequency to 5 GHz
OUTP:STAT ON	Set output level to -7.3 dBm
AM 30PCT	Switch on RF output
AM:STAT ON	Set AM modulation depth to 30%
	Switch on AM
	(RETURN)

4. Transfer the ASCII file to the instrument via the RS-232-C interface. Enter the following command on the controller:  
copy <filename> com1:  
An amplitude-modulated signal is now present at the output of the instrument.
5. To return to manual control, press the [LOCAL] key on the front panel.

## Switchover to Remote Control

On power-up, the instrument is always in the manual control mode ("LOCAL" state) and can be operated via the front panel.

The instrument is switched to remote control ("REMOTE" state) as follows:

IEC/IEEE-bus: when it receives an addressed command from the controller.

RS-232-C interface: when it receives a carriage return <CR> (=0Dh) or a line feed <LF> (=0Ah) from the controller.

During remote control, operation via the front panel is disabled. The instrument remains in the remote state until it is reset to the manual state via the front panel or via the IEC/IEEE bus. Switching from manual to remote control and vice versa does not affect the instrument settings.

### Remote Control via IEC/IEEE Bus

#### Setting the Device Address

The IEC/IEEE-bus address of the instrument is factory-set to 28. It can be changed manually in the Utilities – System – GPIB-Address menu or via the IEC/IEEE bus. Addresses 0 to 30 are permissible.

##### Manually:

- Call Utilities – System – GPIB-Address menu.
- Enter desired address.
- Terminate input using the [1x/ENTER] key.

##### Via IEC/IEEE bus:

CALL IBFIND("DEV1", generator%)	Open port to instrument
CALL IBPAD(generator%, 28)	Transfer old address to controller
CALL IBWRT(generator%, "SYST:COMM:GPIB:ADDR 20")	Set instrument to new address
CALL IBPAD(generator%, 20)	Transfer new address to controller

### Indications during Remote Control

The remote control state is indicated by "IEC Remote" or "Local" being displayed on the STATUS page. In the REMOTE state, the STATUS page is always displayed.

"Locked" indicates that the [LOCAL] key is disabled, ie switchover to manual control can only be made via the IEC/IEEE bus. If "Unlocked" is displayed, switchover to manual control can be made with the [LOCAL] key.



## Return to Manual Operation

Return to manual operation can be made via the front panel or the IEC/IEEE bus.

**Manually** ➤ Press [LOCAL] key.

**Note:**

- Before switchover, command processing must be completed as otherwise switchover to remote control is effected immediately.
- The [LOCAL] key can be disabled by the universal command LLO in order to prevent unintentional switchover. In this case, switchover to manual control is only possible via the IEC/IEEE bus.
- The [LOCAL] key can be enabled again by deactivating the REN control line of the IEC/IEEE bus.

**Via IEC/IEEE bus**

```
...
CALL IBLOC(generator%)           Set instrument to manual control
...
```

## Remote Control via RS-232-C Interface

### Setting the Transmission Parameters

To enable error-free and correct data transmission, the parameters of the instrument and the controller should have the same setting. To prevent any problems during binary data transmission, the RS-232-C interface is permanently set for 8 data bits, no parity and 1 stop bit. This data format corresponds to the IEEE P1174 draft standard. The baud rate and handshake can be manually changed in the Utilities – System - RS232 menu.

- Call Utilities – System - RS232 menu.
- Select desired baud rate and handshake.
- Terminate input using the [1x/ENTER] key.

### Indications during Remote Control

The remote control state is indicated by "RS-232 Remote" or "Local" on the STATUS page. In the REMOTE state, the STATUS page is always displayed.

## Return to Manual Operation

Return to manual operation can be made via the front panel.

➤ Press [LOCAL] key.

**Note:** Before switchover, command processing must be completed as otherwise switchover to remote control is effected immediately.

## Messages

The messages transferred via the data lines of the IEC/IEEE bus can be divided into two groups:

- **interfaces messages** and
- **device messages**

No interface messages are defined for the RS-232-C interface.

### Interface Messages

Interface messages are transferred on the data lines of the IEC/IEEE bus, the ATN control line being active. They are used for communication between the controller and the instrument and can only be sent by a controller which has the IEC/IEEE-bus control. Interface commands can be subdivided into

- **universal commands** and
- **addressed commands**

Universal commands act on all devices connected to the IEC/IEEE bus without previous addressing, addressed commands only act on devices previously addressed as listeners. The interface messages relevant to the instrument are listed in the section "Interface Messages" below.

Some control characters are defined for the control of the RS-232-C interface, see section "Interface Functions".

### Device Messages (Commands and Device Responses)

Device messages are transferred on the data lines of the IEC/IEEE bus, the ATN control line not being active. ASCII code is used. The device messages are largely identical for the two interfaces (IEC/IEEE bus and RS-232-C).

A distinction is made according to the direction in which device messages are sent on the IEC/IEEE bus:

- **Commands** are messages the controller sends to the instrument. They operate the device functions and request information. Commands are subdivided according to two criteria:
  1. According to the effect they have on the instrument:
    - Setting commands** cause instrument settings such as reset of the instrument or setting the output level to 1 V.
    - Queries** cause data to be provided for output (queries) on the IEC/IEEE bus, eg for device identification or polling of the active input.
  2. According to their definition in standard IEEE 488.2:
    - Common Commands** are exactly defined as to their function and notation in standard IEEE 488.2. They refer to functions such as the management of the standardized status registers, reset and selftest.
    - Device-specific commands** refer to functions depending on the features of the instrument such as frequency setting. A majority of these commands has also been standardized by the SCPI committee.
- **Device responses** are messages the instruments sends to the controller in reply to a query. They may contain measurement results or information on the instrument status.

The structure and syntax of device messages are described in the following section.

## Structure and Syntax of Device Messages

### Introduction to SCPI

SCPI (Standard Commands for Programmable Instruments) describes a standard command set for programming instruments, irrespective of the type of instrument or manufacturer. The objective of the SCPI consortium is to standardize the device-specific commands to a large extent. For this purpose, a model was developed which defines identical functions of a device or of different devices. Command systems were generated which are assigned to these functions. Thus it is possible to address identical functions with identical commands. The command systems are of a hierarchical structure. Fig. 5-1 illustrates this tree structure using a section of command system SOURCE, which operates the signal sources of the devices. The other examples concerning syntax and structure of the commands are derived from this command system.

SCPI is based on standard IEEE 488.2, ie it uses the same basic syntax elements as well as the common commands defined in this standard. Part of the syntax of the device responses is defined in greater detail than in standard IEEE 488.2 (see section "Responses to Queries").

### Structure of Commands

Commands consist of a header and, in most cases, one or several parameters. The header and the parameters are separated by a "white space" (ASCII code 0 to 9, 11 to 32 decimal, eg a blank). Headers may consist of several key words. Queries are formed by appending a question mark directly to the header.

**Note:** *The commands used in the following examples are not in every case implemented in the instrument.*

#### Common commands

Common (device-independent) commands consist of a header preceded by an asterisk "\*" and of one or several parameters, if any.

Examples: \*RST           RESET, resets the instrument  
           \*ESE 253   EVENT STATUS ENABLE, sets the bits of  
                           the event status enable register  
           \*ESR?       EVENT STATUS QUERY, queries the  
                           contents of the event status register

#### Device-specific commands

**Hierarchy:** Device-specific commands are of a hierarchical structure (see Fig. 5-1). The different levels are represented by combined headers. Headers of the highest level (root level) have only one key word. This key word denotes a complete command system.

Example:   SOURCE  
           This key word denotes the SOURCE command system.

For commands of lower levels, the complete path has to be specified, starting on the left with the highest level, the individual key words being separated by a colon ":".

Example:   SOURCE:FM:EXTERNAL:COUPLING AC

This command is at the fourth level of the SOURCE system. It selects AC coupling of the external signal source.

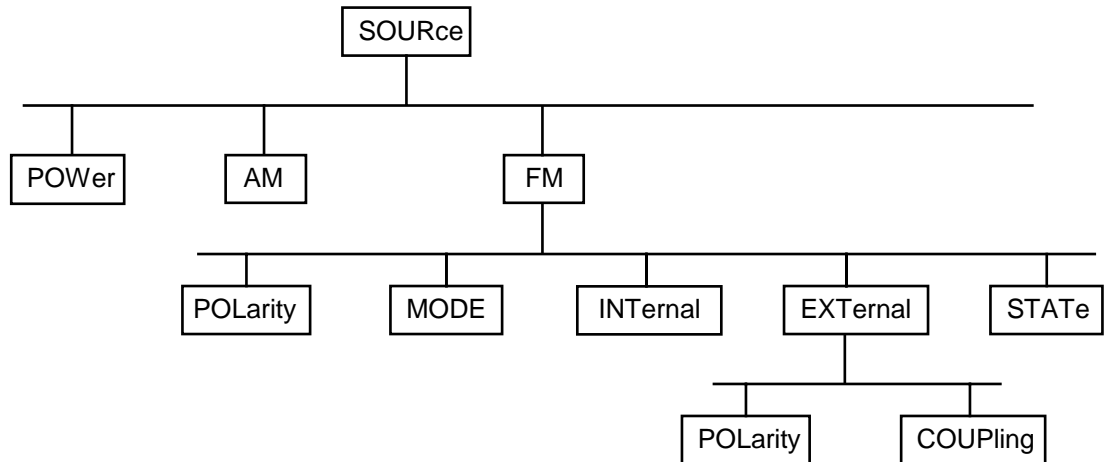

Fig. 5-1 Tree structure of SCPI command systems using the SOURce system as an example

Some key words occur at several levels within one command system. Their effect depends on the structure of the command, that is to say, at what position of the header of a command they are inserted.

Example: `:SOURce:FM:POLarity NORMal`

This command contains the key word POLarity at the third command level. It defines the polarity between the modulator and the modulation signal.

Example: `:SOURce:FM:EXTernal:POLarity NORMal`

This command contains the key word POLarity at the fourth command level. It defines the polarity between the modulation voltage and the resulting direction of the modulation only for the external signal source indicated.

#### Optional key words:

Some command systems permit certain key words to be optionally inserted into the header or omitted. These key words are marked in the description by square brackets. The instrument must recognize the full command length for reasons of compatibility with the SCPI standard. Some commands can be considerably shortened by omitting optional key words.

Example: `[SOURce]:POWER[:LEVEl][:IMMEDIATE]:OFFSet 1`

This command immediately sets the offset of the signal to 1 V. The following command has the same effect:

`POWER:OFFSet 1`

**Note:** An optional key word must not be omitted if its effect is specified in greater detail by means of a numerical suffix.

#### Long and short form:

Key words have a long form and a short form. Either the long form or the short form may be entered, other abbreviations are not permissible.

Example: `STATus:QUESTionable:ENABle 1= STAT:QUES:ENAB 1`

**Note:** The short form is characterized by upper-case letters, the long form corresponds to the complete word. Upper-case and lower-case notation only serve the above purpose, the device itself does not make any difference between upper-case and lower-case letters.

**Parameters:** A parameter must be separated from the header by a "white space". If a command includes several parameters, they are separated by a comma ",". Some queries permit the parameters MINimum, MAXimum and DEFault to be entered. For a description of these parameter types see section "Parameters".

**Example:** `SOURce:POWer:ATTenuation? MAXimum`    `Response: 60`  
This query requests the maximum value for the attenuation.

**Numerical suffix:** If a device has several functions or features of the same kind, eg inputs, the desired function can be selected by appending a suffix to the command. Entries without suffix are interpreted like entries with the suffix 1.

**Example:** `SOURce:FM:EXTernal2:COUPLing AC`  
This command sets the coupling of the second external signal source.

## Structure of Command Lines

A command line may contain one or several commands. It is terminated by <New Line>, <New Line> with EOI or EOI together with the last data byte. QuickBASIC automatically produces EOI together with the last data byte.

Several commands in a command line are separated by a semicolon ";". If the next command belongs to a different command system, the semicolon is followed by a colon.

Example:

```
CALL IBWRT(generator%, "SOURCE:POWER:CENTer MINimum;:OUTPut:ATTenuation 10")
```

This command line contains two commands. The first command belongs to the SOURCE system and defines the center frequency of the output signal. The second command belongs to the OUTPut system and sets the attenuation of the output signal.

If successive commands belong to the same system and thus have one or several levels in common, the command line can be abbreviated. To this end, the second command (after the semicolon) is started with the level that lies below the common levels (see also Fig. 5-1). The colon following the semicolon must be omitted in this case.

Example:

```
CALL IBWRT(generator%, "SOURCE:FM:MODE LOCKed;:SOURCE:FM:INTernal:FREQuency 1kHz")
```

This command line is represented in its full length and contains two commands separated from each other by the semicolon. The two commands belong to the SOURCE command system, subsystem FM, ie they have two common levels.

To abbreviate the command line, the second command is started with the level below SOURCE:FM. The colon after the semicolon is omitted.

The abbreviated form of the command line reads as follows:

```
CALL IBWRT(generator%, "SOURCE:FM:MODE LOCKed;INTernal:FREQuency 1kHz")
```

However, a new command line always has to be started with the complete path.

```
Example: CALL IBWRT(generator%, "SOURCE:FM:MODE LOCKed")
         CALL IBWRT(generator%, "SOURCE:FM:INTernal:FREQuency 1kHz")
```

## Responses to Queries

For each setting command, a query is defined unless explicitly specified otherwise. The query is formed by adding a question mark to the setting command in question. Responses to queries to the SCPI standard are partly subject to stricter rules than responses to the IEEE 488.2 standard.

1. The requested parameter is transmitted without header.  
Example: SOURCE:EXTernal:COUPling? Response: AC
2. Maximum values, minimum values and all further quantities requested via a special text parameter are returned as numerical values.  
Example: FREQuency? MAX Response: 10E3
3. Numerical values are output without a unit. Physical quantities are referred to the basic units or to the units set with the Unit command.  
Example: FREQuency? Response: 1E6 for 1 MHz
4. Truth values (Boolean parameters) are returned as 0 (for Off) and 1 (for On).  
Example: OUTPut:STATe? Response: 1
5. Text (character data) is returned in a short form.  
Example: SOURCE:FM:SOURCE? Response: INT1

## Parameters

Most commands require a parameter to be specified. Parameters must be separated from the header by a "white space". Permissible parameters are numerical values, Boolean parameters, text, character strings and block data. The parameter type required for a given command and the permissible range of values are specified in the command description.

**Numerical values** Numerical values can be entered in any form, ie with sign, decimal point and exponent. Values exceeding the resolution of the instrument are rounded up or down. The mantissa may comprise up to 255 characters, the exponent must be in the value range -32 000 to 32 000. The exponent is preceded by an "E" or "e". Specifying the exponent alone is not permissible. In the case of physical quantities, the unit can be entered. Permissible unit prefixes are G (giga), MA (mega, MOHM and MHz being also permissible), K (kilo), M (milli), U (micro) and N (nano). If no unit is entered, the basic unit is used.

Example: `SOURce:FREQuency 1.5 kHz = SOURce:FREQuency 1.5E3`

**Special numerical values** The texts MINimum, MAXimum, DEFault, UP and DOWN are interpreted as special numerical values.

In the case of a query, the numerical value is returned.

Example: Setting command: `SOURce:VOLTage MAXimum`  
 Query: `SOURce:VOLTage?` Response: 15

MIN/MAX MINimum and MAXimum denote the minimum and the maximum value.

DEF DEFault denotes a preset value stored in an EPROM. This value conforms to the default setting as called by the \*RST command.

UP/DOWN UP/DOWN increases or decreases the numerical value by one step. The step width can be defined via an allocated step command for each parameter which can be set via UP/DOWN (see List of Commands, chapter 6).

INF/NINF INFINITY, Negative INFINITY (NINF) represent the numerical values  $-9.9E37$  or  $9.9E37$ , respectively. INF and NINF are only sent as device responses.

NAN Not A Number (NAN) represents the value  $9.91E37$ . NAN is only sent as a device response. This value is not defined. Possible causes are the division of zero by zero, the subtraction of infinite from infinite and the representation of missing values.

**Boolean Parameters** Boolean parameters represent two states. The ON state (logically true) is represented by ON or a numerical value unequal to 0. The OFF state (logically untrue) is represented by OFF or the numerical value 0. In the case of a query, 0 or 1 is returned.

Example: Setting command: `SOURce:FM:STATe ON`  
 Query: `SOURce:FM:STATe?` Response: 1

**Text** Text parameters follow the syntactic rules for key words, ie they can be entered using a short or a long form. Like any other parameter, they must be separated from the header by a "white space". In the case of a query, the short form of the text is returned.

Example: Setting command: `:OUTPut:FILTer:TYPE EXTernal`  
 Query: `:OUTPut:FILTer:TYPE?` Response: EXT

**Strings**

Strings must always be entered in inverted commas (' or ").

Example: `SYSTem:LANGUage "SCPI"` or  
`:SYSTem:LANGUage 'SCPI'`

**Block data**

Block data are a transmission format which is suitable for the transmission of large amounts of data. A command with a block data parameter has the following structure:

Example: `HEADer:HEADer #45168xxxxxxxx`

The data block is preceded by the ASCII character #. The next number indicates how many of the following digits describe the length of the data block. In the example, the four following digits indicate the length to be 5168 bytes. This is followed by the data bytes. During the transmission of the data bytes, all End or other control signs are ignored until all bytes are transmitted. Data elements comprising more than one byte are transmitted with the byte being the first which was specified by the SCPI command "FORMat:BOReR".

The format of the binary data within a block depends on the IEC/IEEE-bus command. The commands

```
..:SOURce:LIST:DWELL
:SOURCE:LIST:FREQuency
:SOURCE:LIST:POWeR
:SOURCE:CORRection:CSET:DATA:FREQuency
:SOURCE:CORRection:CSET:DATA:POWeR
:SYSTem:MSEQuence:DWELL
:SYSTem:MSEQuence:RCL
```

use the IEEE 754 format for double precision floating point numbers. Each number is represented by 8 bytes.

**Example:**

`a# = 125.345678E6`

`b# = 127.876543E6`

```
CALL IBWRT(generator%, "SOURCE:CORRECTION:CSET:DATA:FREQ
#216" + MKD$(a#) + MKD$(b#))
```

- '#' in the command string introduces the binary block,
- '2' indicates that 2 digits specifying the length will follow next,
- '16' is the length of the binary block (in bytes), here: 2 double precision floating point numbers of 8 bytes each.
- The binary data follow. Since the function IBWRT requires a text string, MKD\$ is used for type conversion.

The following ASCII format has the same effect:

```
CALL IBWRT(generator%, "SOURCE:CORRECTION:CSET:DATA:FREQ
125.345678E6, 127.876543E6")
```



**Overview of Syntax Elements**

Following is an overview of syntax elements.



The colon separates the key words of a command.  
In a command line the separating semicolon marks the uppermost command level.



The semicolon separates two commands of a command line.  
It does not alter the path.



The comma separates several parameters of a command.



The question mark forms a query.



The asterisk marks a common command.



Quotation marks introduce a string and terminate it.



ASCII character # introduces block data.



A "white space" (ASCII-Code 0 to 9, 11 to 32 decimal, e.g. blank) separates header and parameter.

## Instrument Model and Command Processing

The instrument model shown in Fig. 5-2 was created with a view to the processing of IEC/IEEE-bus commands. The individual components work independently of each other and simultaneously. They communicate with each other by means of messages.

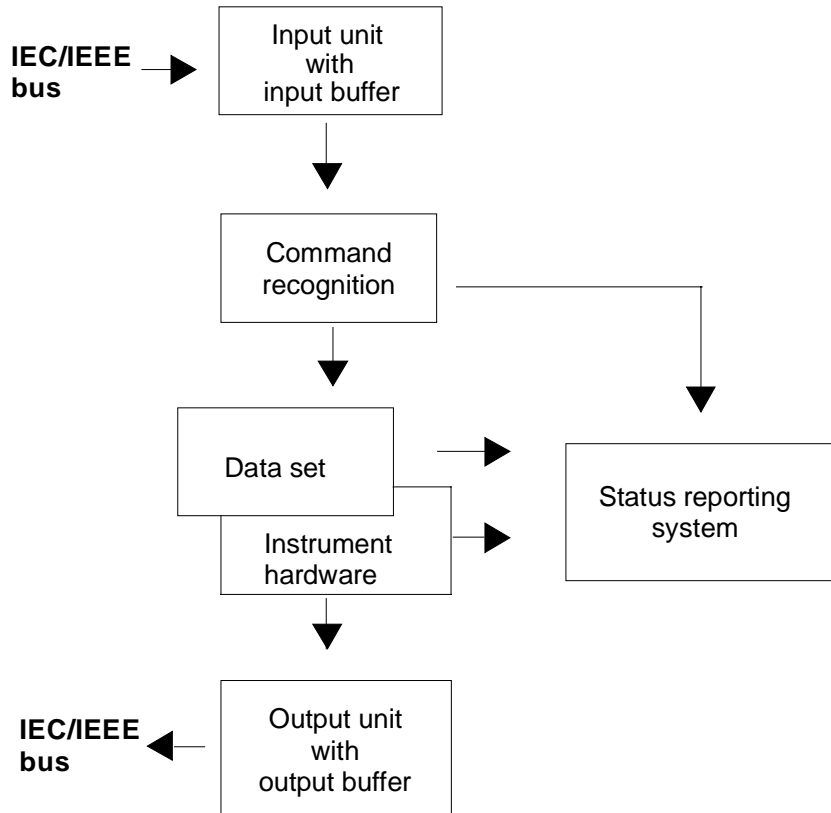

Fig. 5-2 Device model for remote control via the IEC/IEEE bus

### Input Unit

The input unit receives commands character by character from the IEC/IEEE bus and stores them in the input buffer. The input buffer has a size of 256 characters. The input unit sends a message to the command recognition when the input buffer is full or when it receives a terminator, <PROGRAM MESSAGE TERMINATOR>, as defined in IEEE 488.2, or the interface message DCL.

If the input buffer is full, the IEC/IEEE-bus traffic is stopped and the data received up to then are processed. After this, the IEC/IEEE-bus traffic is continued. If, on receipt of a terminator, the input buffer is not full, the input unit can receive the next command during command recognition and execution. Receipt of a DCL command clears the input buffer and immediately initiates a message to the command recognition.

## **Command Recognition**

The command recognition analyzes the data from the input unit in the order the data are received. Only DCL commands are serviced with priority, whereas GET commands (Group Execute Trigger), for example, are processed only after the previously received commands. Each recognized command is immediately transferred to the data set but without being executed there at once.

Syntactic errors in commands are detected here and transferred to the status reporting system. The rest of a command line following a syntax error is further analyzed and processed as far as possible.

If the command recognition recognizes a terminator or a DCL command, it requests the data set to set the commands now also in the instrument hardware. After this, it is immediately ready to continue processing commands. This means that new commands can be processed while the hardware is being set ("overlapping execution").

## **Data Set and Instrument Hardware**

The term "instrument hardware" is used here to designate the part of the instrument which actually performs the instrument functions: signal generation, measurement, etc. The controller is not included.

The data set is a detailed reproduction of the instrument hardware in the software.

IEC/IEEE-bus setting commands cause an alteration of the data set. The data set management enters the new values (eg frequency) into the data set but passes them on to the hardware only upon request by the command recognition. As this is only effected at the end of a command line, the sequence of setting commands in the command line is not relevant.

The data are only checked for compatibility among one another and with the instrument hardware immediately before they are transferred to the instrument hardware. If it is found that an execution is not possible, an "execution error" is signalled to the status reporting system. All alterations mad to the data set are cancelled, and the instrument hardware is not reset. Due to the delayed checking and hardware setting it is permissible however that impermissible instrument states are briefly set within a command line without an error message being produced. At the end of the command line, however, a permissible instrument state must be attained.

Before the data are passed on to the hardware, the settling bit in the STATus:OPERation register is set. The hardware makes the settings and resets the bit when the new state has settled. This procedure can be used for synchronization of command processing.

IEC/IEEE-bus queries cause the data set management to send the desired data to the output unit.

## **Status Reporting System**

The status reporting system collects information on the instrument state and makes it available to the output unit upon request. A detailed description of the structure and function is given in section "Status Reporting System".

## Output Unit

The output unit collects the information requested by the controller and output by the data set management. The output unit processes the information in accordance with the SCPI rules and makes it available in the output buffer. The output buffer has a size of 256 characters. If the requested information exceeds this size, it is made available in portions without this being recognized by the controller.

If the instrument is addressed as a talker without the output buffer containing data or awaiting data from the data set management, the output unit returns the error message "Query UNTERMINATED" to the status reporting system. No data are sent on the IEC/IEEE bus. The controller waits until it has reached its time limit. This procedure is specified by SCPI.

## Command Sequence and Command Synchronization

As mentioned above, overlapping execution is possible for all commands. Likewise, the setting commands of a command line are not necessarily processed in the order in which they are received.

To ensure that commands are carried out in a specific order, each command must be sent in a separate command line, ie with a separate IBWRT() call.

To prevent overlapping execution of commands, one of commands \*OPC, \*OPC? or \*WAI has to be used. Each of the three commands causes a certain action to be triggered only after the hardware has been set and has settled. The controller can be programmed to wait for the respective action to occur (see Table 5-1).

Table 5-1 Synchronization by means of \*OPC, \*OPC? and \*WAI

Command	Action after the hardware has settled	Programming of controller
*OPC	Sets the operation-complete bits in the ESR	- Setting of bit 0 in the ESE - Setting of bit 5 in the SRE - Waiting for a service request (SRQ)
*OPC?	Writes a "1" into the output buffer	Addressing of instrument as a talker
*WAI	Continues the IEC/IEEE-bus handshake. The handshake is not stopped.	Sending of next command

An example of command synchronization will be found in section 7, "Programming Examples".

## Status Reporting System

The status reporting system (see Fig. 5-4) stores all information on the current operating state of the instrument, for example on any errors that have occurred. This information is stored in status registers and in an error queue. The status registers and the error queue can be queried via the IEC/IEEE bus.

The information is of a hierarchical structure. The highest level is formed by the status byte (STB) register defined in IEEE 488.2 and the associated service request enable (SRE) mask register. The STB register receives information from the standard event status register (ESR) which is also defined in IEEE 488.2 with the associated standard event status enable (ESE) mask register, and from the registers STATUS:OPERation and STATUS:QUEStionable which are defined by SCPI and contain detailed information on the instrument.

The status reporting system further comprises the IST flag ("Individual STATUS") with the parallel poll enable (PPE) register allocated to it. The IST flag, like the SRQ, combines the entire instrument state in a single bit. The function fulfilled by the PPE register for the IST flag corresponds to that fulfilled by the SRE for the service request.

The output buffer contains the messages the instrument returns to the controller. The output buffer is not part of the status reporting system but determines the value of the MAV bit in the STB register and is therefore shown in Fig. 5-4.

### Structure of an SCPI Status Register

Each SCPI register consists of five parts each of 16 bits width which have different functions (see Fig. 5-3). The individual bits are independent of each other, ie each hardware status is assigned a bit number which is valid for all five parts. For example, bit 3 of the STATUS:OPERation register is assigned to the hardware status "Wait for trigger" for all five parts. Bit 15 (the most significant bit) is set to zero for all five parts. This allows the controller to process the contents of the register parts as positive integer.

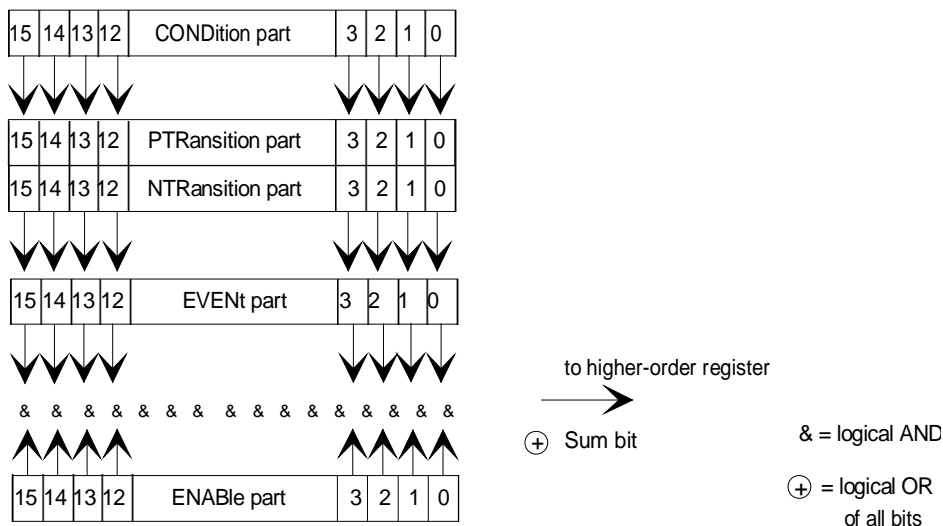

Fig. 5-3 Status register model

<b>CONDition part</b>	The CONDition part is directly written to by the hardware or the sum bit of the next lower register. Its contents reflects the current instrument status. This register part can be read only but not written to or cleared. Reading does not affect it contents.
<b>PTRansition part</b>	The <u>P</u> ositive <u>T</u> ransition part acts as an edge detector. If a bit of the CONDition part changes from 0 to 1, the status of the associated PTR bit determines whether the EVENT bit is set to 1. PTR bit = 1: the EVENT bit is set. PTR bit = 0: the EVENT bit is not set. This part can be written to and read. Reading does not affect its contents.
<b>NTRansition part</b>	The <u>N</u> egative <u>T</u> ransition part likewise acts as an edge detector. If a bit of the CONDition part changes from 1 to 0, the status of the associated NTR bit determines whether the EVENT bit is set to 1. NTR bit = 1: the EVENT bit is set. NTR bit = 0: the EVENT bit is not set. This part can be written to and read. Reading does not affect its contents.  With the above two edge register parts, the user can define what status transition of the CONDition part (none, 0 to 1, 1 to 0 or both) is to be stored in the EVENT part.
<b>EVENT part</b>	The EVENT part indicates whether an event has occurred since it was read the last time; it is the "memory" of the CONDition part. It indicates only those events that were passed on by the edge filters. The EVENT part is continuously updated by the instrument. This part can be read only. Upon reading, its contents is set to zero. In linguistic usage, the EVENT part is often treated as equivalent to the complete register.
<b>ENABLE part</b>	The ENABLE part determines whether the associated EVENT bit contributes to the sum bit (see below). Each bit of the EVENT part is ANDed with the associated ENABLE bit (symbol '&'). The results of all logical operations of this part are passed on to the sum bit via an OR function (symbol '+'). ENABLE-Bit = 0: the associated EVENT bit does not contribute to the sum bit. ENABLE-Bit = 1: if the associated EVENT bit is "1", the sum bit is set to "1" as well. This part can be written to and read. Reading does not affect its contents.
<b>Sum bit</b>	As mentioned above, the sum bit is obtained from the EVENT part and the ENABLE part for each register. The result is entered as a bit of the CONDition part into the next higher register. The instrument automatically generates a sum bit for each register. It is thus ensured that an event, for example a PLL that has not locked, can produce a service request throughout all hierarchical levels.
<b>Note:</b>	<i>The service request enable (SRE) register defined in IEEE 488.2 can be taken as the ENABLE part of the STB if the STB is structured in accordance with SCPI. Analogously, the ESE can be taken as the ENABLE part of the ESR.</i>

Overview of Status Registers

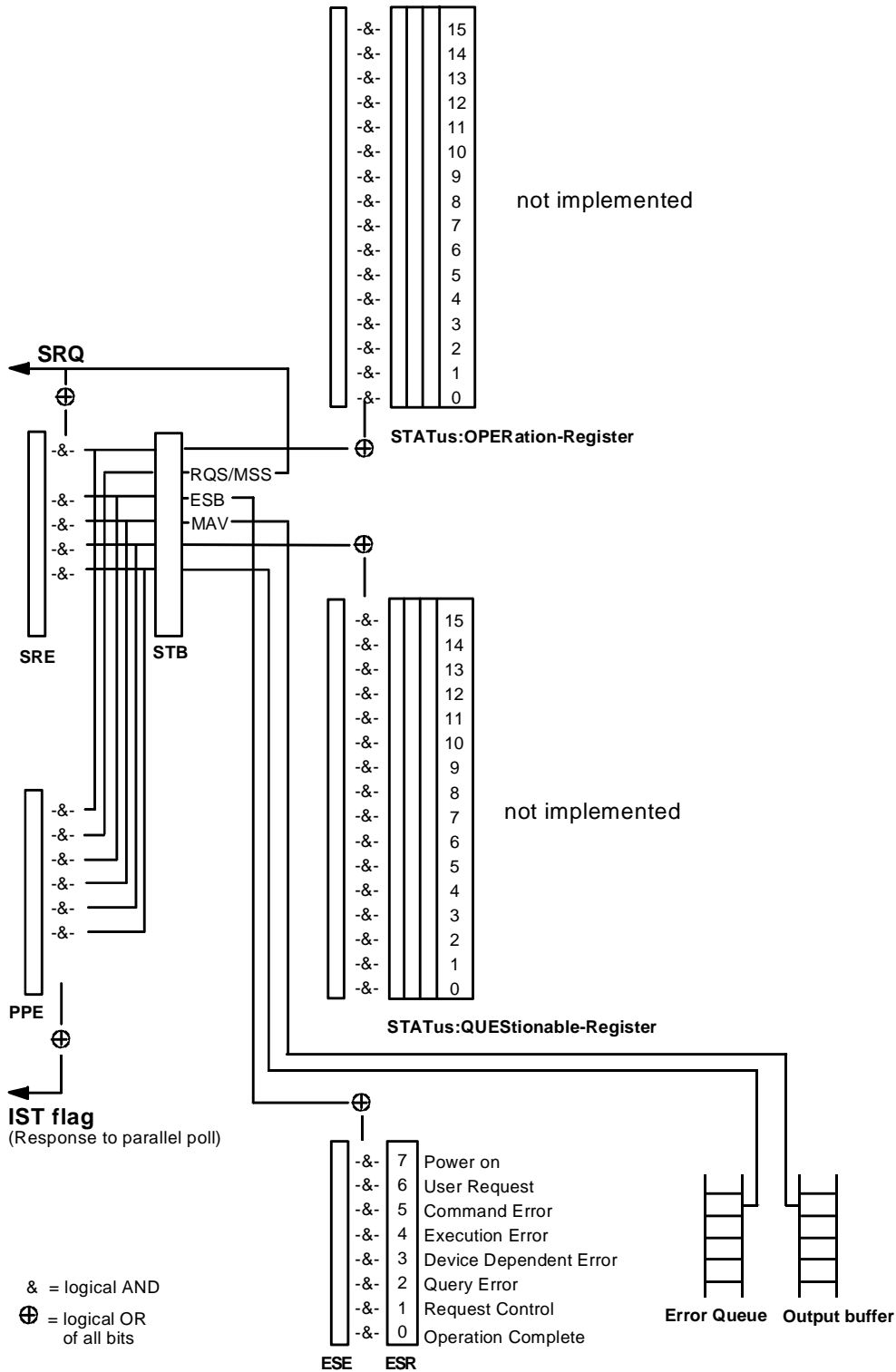

Fig. 5-4 Overview of status registers

## Description of Status Registers

### Status Byte (STB) and Service Request Enable Register (SRE)

The STB is already defined in IEEE 488.2. It provides a rough overview of the instrument status by collecting the pieces of information of the lower registers. It can thus be compared with the CONDition part of an SCPI register and assumes the highest level within the SCPI hierarchy. A special feature is that bit 6 acts as the sum bit of the remaining bits of the status byte.

The status byte is read using the command \*STB? or a serial poll.

The STB is assigned an SRE. The SRE functionally corresponds to the ENABLE part of the SCPI registers. Each bit of the STB is assigned a bit of the SRE. Bit 6 of the SRE is ignored. If a bit is set in the SRE and the associated bit in the STB changes from 0 to 1, a service request (SRQ) is generated on the IEC/IEEE bus which triggers an interrupt in the controller (if the controller is configured correspondingly) and can be further processed there.

The SRE can be set using the command \*SRE and read using the command \*SRE?.

Table 5-2 Meaning of the bits used in the status byte

Bit No.	Meaning
2	<p><b>Error Queue Not Empty</b></p> <p>This bit is set if an entry is made in the error queue. If the bit is enabled by the SRE, each entry in the error queue generates a service request. Thus an error can be recognized and determined in greater detail by polling the error queue. The poll provides an informative error message. This procedure is recommended since it considerably reduces the problems involved in IEC/IEEE-bus control.</p>
3	<p><b>QUESTIONable Status sum bit</b></p> <p>This bit is set if an EVENT bit is set in the QUESTIONable status register and the associated ENABLE bit is set to 1. If the bit is set, this indicates a questionable instrument status which can be determined in greater detail by polling the QUESTIONable status register.</p>
4	<p><b>MAV bit (Message Available)</b></p> <p>This bit is set if a message is available in the output buffer which can be read. The bit can be used for the automatic reading of data from the instrument to the controller (see chapter 7, "Programming Examples").</p>
5	<p><b>ESB bit</b></p> <p>Sum bit of event status register. It is set if one of the bits of the event status register is set and enabled in the event status enable register. If the bit is set, this indicates a serious error which can be determined in greater detail by polling the event status register.</p>
6	<p><b>MSS bit (Master Status Summary bit)</b></p> <p>This bit is set if the instrument triggers a service request. This is the case if one of the other bits of this register is set together with its mask bit in the service request enable (SRE) register.</p>
7	<p><b>OPERation Status Register sum bit</b></p> <p>This bit is set if an EVENT bit is set in the OPERation status register and the associated ENABLE bit is set to 1. If the bit is set, this indicates that the instrument is just carrying out an action. The type of action can be determined by polling the OPERation status register.</p>



### IST Flag and Parallel Poll Enable Register (PPE)

Analogously with the SRQ, the IST flag combines the entire status information in a single bit. It can be queried by means of a parallel poll (see section "Parallel Poll") or using the command \*IST?.

The parallel poll enable (PPE) register determines which bits of the STB contribute to the IST flag. The bits of the STB are ANDed with the corresponding bits of the PPE. Unlike the SRE, bit 6 is used in this case. The IST flag results from the ORing of all results. The PPE can be set using the command \*PRE and read using the command \*PRE?.

### Event Status Register (ESR) and Event Status Enable Register (ESE)

The ESR is already defined in IEEE 488.2. It can be compared with the EVENT part of an SCPI register. The event status register can be read using the command \*ESR?.

The ESE is the associated ENABLE part. It can be set using the command \*ESE and read using the command \*ESE?.

Table 5-3 Meaning of the bits used in the event status register

Bit No.	Meaning
0	<b>Operation Complete</b> This bit is set on receipt of the command *OPC when all previous commands have been executed.
2	<b>Query Error</b> This bit is set if either the controller wants to read data from the instrument without having sent a query, or if it does not fetch requested data and sends new instructions to the instrument instead. The cause is often a query which is errored and hence cannot be executed.
3	<b>Device-Dependent Error</b> This bit is set if a device-dependent error occurs. An error message with a number between -300 and -399 or a positive error number, which denotes the error in greater detail, is entered into the error queue (see section "Error Messages").
4	<b>Execution Error</b> This bit is set if a received command is syntactically correct but cannot be executed for other reasons. An error message with a number between -200 and -300, which denotes the error in greater detail, is entered into the error queue (see section "Error Messages").
5	<b>Command Error</b> This bit is set if a command is received which is undefined or syntactically not correct. An error message with a number between -100 and -200, which denotes the error in greater detail, is entered into the error queue (see section "Error Messages").
6	<b>User Request</b> This bit is set when the [LOCAL] key is pressed, ie when the instrument is switched over to manual control.
7	<b>Power On (AC supply voltage On)</b> This bit is set on switching on the instrument.

**STATus:OPERation-Register**

Not implemented

**STATus:QUEStionable Register**

Not implemented

## Use of Status Reporting System

To make effective use of the status reporting system, the information collected there must be transferred to the controller and further processed. There are several methods to this effect which are described in the following. For detailed examples see chapter 7, "Programming Examples").

## Service Request, Making Use of Hierarchy Structure

Under certain conditions, the instrument can send a service request (SRQ) to the controller. The service request normally triggers an interrupt at the controller to which the control program can respond with corresponding actions. Fig. 5-4 shows that an SRQ is triggered if one or several of the bits 2, 3, 4, 5 and 7 of the status byte are set and enabled in the SRE. Each of these bits combines the information of another register, the error queue or the output buffer. By setting the ENABLE parts of the status registers accordingly, it is achieved that arbitrary bits of an arbitrary status register trigger an SRQ. To make use of the possibilities of the service request, all bits of the SRE and ESE enable registers should be set to "1".

Examples (see also Fig. 5-4 and chapter 7, "Programming Examples"):

Use of command \*OPC to generate an SRQ

- Set bit 0 in the ESE (Operation Complete).
- Set bit 5 in the SRE (ESB).

The instrument generates an SRQ after completion of its settings.

Indication of end of sweep by means of an SRQ at the controller

- Set bit 7 (sum bit of STATus:OPERation register) in SRE.
- Set bit 3 (sweeping) in STATus:OPERation:ENABLE.
- Set bit 3 in STATus:OPERation:NTRansition so that the transition of sweeping bit 3 from 1 to 0 (end of sweep) is recorded in the EVENT part.

The instrument generates an SRQ after completion of a sweep.

The SRQ is the only way for the instrument to become active on its own. Each controller program should, therefore, set the instrument such that a service request is triggered in the event of a malfunction. The program should react appropriately to the service request. A detailed example of a service request routine is included in chapter 7, "Programming Examples".

## Serial Poll

In a serial poll, just as with command \*STB, the status byte of an instrument is queried. However, the query is implemented by means of interface messages and is therefore clearly faster. The serial-poll method has already been defined in IEEE 488.1 and used to be the only standard method for different instruments to query the status byte. The method also works with instruments which do not adhere to SCPI nor to IEEE 488.2.

The QuickBASIC command for executing a serial poll is `IBRSP( )`. Serial polling is mainly used to obtain a fast overview of the states of several instruments connected to the IEC/IEEE bus.

## Parallel Poll

In a parallel poll, up to eight instruments are simultaneously requested by the controller by means of a single command to transmit 1 bit of information each on the data lines, ie to set the data line allocated to each instrument to logically "0" or "1". Analogously to the SRE register, which determines under what conditions an SRQ is generated, there is a parallel poll enable (PPE) register, which is likewise ANDed with the STB bit by bit, with bit 6 being taken into account. The results are ORed, and the result of this is sent (possibly inverted) in response to a parallel poll by the controller. The result can also be queried without a parallel poll using the command `*IST`.

The instrument first has to be set for parallel polling by means of the QuickBASIC command `IBPPC( )`. This command allocates a data line to the instrument and determines whether the response is to be inverted. The parallel poll itself is executed using `IBRPP( )`.

The parallel-poll method is mainly used in order to find out quickly, after an SRQ, which instrument has sent the service request if there are many instruments connected to the IEC/IEEE bus. To this effect, the SRE and the PPE must be set to the same value. A detailed example on parallel polling will be found in chapter 7, "Programming Examples".

## Query by Means of Commands

Each part of every status register can be read by means of a query. The queries to be used are included with the detailed description of the registers. In response to a query, a number is always returned which represents the bit pattern of the register queried. The number is evaluated by the controller program.

Queries are normally used after an SRQ to obtain more detailed information on the cause of the SRQ.

## Error Queue Query

Each error state in the instrument leads to an entry in the error queue. The entries to the error queue are detailed plain-text error messages which can be displayed in the Error menu by manual control or queried via the IEC/IEEE bus with the command `SYSTem:ERRor?`. Each call of `SYSTem:ERRor?` provides one entry from the error queue. If no more error messages are stored there, the instrument responds with 0, ie "No error".

The error queue should be queried by the controller program after each SRQ as the entries provide a more precise description of the cause of an error than the status registers. Especially during the test phase of a controller program the error queue should be queried regularly since errored commands from the controller to the instrument are also recorded in the error queue.

**Reset Values of Status Reporting System**

Table 5-4 lists the commands and events that cause a reset of the status reporting system. Except for \*RST and SYSTem:PRESet, none of the commands has an effect on the functional settings of the instrument. It should be noted in particular that DCL also does not change instrument settings.

Table 5-4 Resetting of instrument functions

Event	Switching on of AC supply voltage		DCL, SDC (Device Clear, Selected Device Clear)	*RST or SYSTem:PRESet	STATus:PRESet	*CLS
	Power On Status Clear					
	0	1				
Clears STB, ESR	—	yes	—	—	—	yes
Clears SRE, ESE	—	yes	—	—	—	—
Clears PPE	—	yes	—	—	—	—
Clears EVENT parts of the registers	—	yes	—	—	—	yes
Clears ENABLE parts of all OPERATION and QUESTIONable registers, fills ENABLE parts of all other registers with "1"	—	yes	—	—	yes	—
Fills PTRansition parts with "1", clears NTRansition parts	—	yes	—	—	yes	—
Clears error queue	yes	yes	—	—	—	yes
Clears output buffer	yes	yes	yes	1)	1)	1)
Clears command processing and input buffer	yes	yes	yes	—	—	—

1) Each command which is the first in a command line, ie which directly follows the <PROGRAM MESSAGE TERMINATOR>, clears the output buffer.

## Interfaces

### IEC/IEEE-Bus Interface

The instrument is equipped with an IEC/IEEE-bus interface as standard. The connector to IEEE 488 is provided at the rear of the instrument. A controller for remote control can be connected via the interface. Connection is made using a shielded cable.

### Characteristics of Interface

- 8-bit parallel data transmission
- Bidirectional data transmission
- Three-wire handshake
- High data transmission rate, max. 350 kbyte/s
- Up to 15 devices can be connected
- Maximum length of connecting cables 15 m (single connection 2 m)
- Wired OR if several instruments are connected in parallel

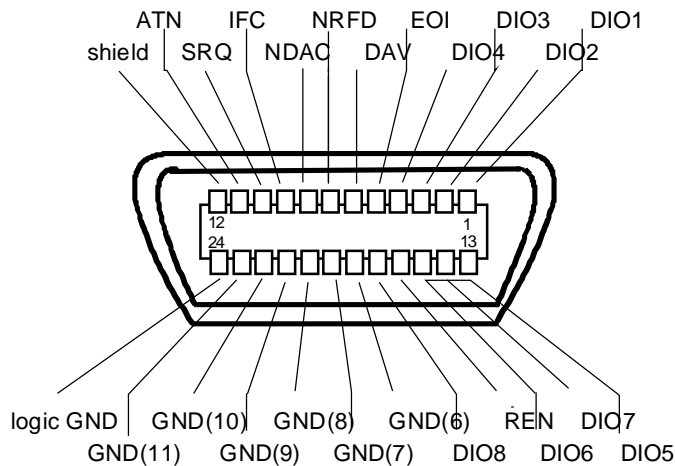

Fig. 5-5 Pin assignment of IEC/IEEE-bus interface

### Bus Lines

#### 1. Data bus with 8 lines DIO 1 to DIO 8

Transmission is bit-parallel and byte-serial in ASCII/ISO code. DIO1 is the least significant bit, DIO8 the most significant.

**2. Control bus with 5 lines**

- IFC** (Interface Clear):  
Active LOW resets the interfaces of the instruments connected to the default setting.
  
- ATN** (Attention):  
Active LOW signals the transmission of interface messages.  
Inactive HIGH signals the transmission of device messages.
  
- SRQ** (Service Request):  
Active LOW enables the instrument to send a service request to the controller.
  
- REN** (Remote Enable):  
Active LOW enables switchover to remote control.
  
- EOI** (End or Identify):  
This has two functions in conjunction with ATN:  
ATN = HIGH      Active LOW marks the end of a data transmission.  
ATN = LOW      Active LOW triggers a parallel poll.

**3. Handshake bus with 3 lines**

- DAV** (Data Valid):  
Active LOW signals a valid data byte on the data bus.
  
- NRFD** (Not Ready For Data):  
Active LOW signals that one of the devices connected is not ready to accept data.
  
- NDAC** (Not Data Accepted):  
Active LOW as long as the instrument is accepting the data present on the data bus.

**Interface Functions**

Instruments which can be remote-controlled via the IEC/IEEE bus can be equipped with different interface functions. Table 5-5 lists the interface functions relevant for the instrument.

Table 5-5      Interface functions

<b>Control character</b>	<b>Interface functions</b>
SH1	Handshake source function (Source Handshake)
AH1	Handshake drain function (Acceptor Handshake)
L4	Listener function
T6	Talker function, ability to respond to serial poll
SR1	Service request function (Service Request)
PP1	Parallel poll function
RL1	Remote/local switchover function
DC1	Reset function (Device Clear)
DT1	Trigger function (Device Trigger)

## Interface Messages

Interface messages are transmitted to the instrument on the data lines, with the ATN (Attention) line being active LOW. These messages serve for communication between the controller and the instrument.

### Universal Commands

Universal commands are in the code range 10 to 1F hex. They act on all instruments connected to the bus without addressing them before.

Table 5-6 Universal commands

Command	QuickBASIC command	Effect on the instrument
DCL (Device Clear)	IBCMD (controller%, CHR\$(20))	Aborts the processing of the commands just received and sets the command processing software to a defined initial state. Does not change the instrument setting.
IFC (Interface Clear)	IBSIC (controller%)	Resets the interfaces to the default state.
LLO (Local Lockout)	IBCMD (controller%, CHR\$(17))	Manual switchover to LOCAL is disabled.
SPE (Serial Poll Enable)	IBCMD (controller%, CHR\$(24))	Ready for serial poll.
SPD (Serial Poll Disable)	IBCMD (controller%, CHR\$(25))	End of serial poll.
PPU (Parallel Poll Unconfigure)	IBCMD (controller%, CHR\$(21))	End of parallel polling state.

### Addressed Commands

Addressed commands are in the code range 00 to 0F hex. They only act on instruments addressed as listeners.

Table 5-7 Addressed commands

Command	QuickBASIC command	Effect on the instrument
SDC (Selected Device Clear)	IBCLR (device%)	Aborts the processing of the commands just received and sets the command processing software to a defined initial state. Does not change the instrument setting.
GET (Group Execute Trigger)	IBTRG (device%)	Triggers a previously active instrument function (eg a sweep). The effect of this command is identical to that of a pulse at the external trigger signal input.
GTL (Go to Local)	IBLOC (device%)	Transition to LOCAL state (manual control).
PPC (Parallel Poll Configure)	IBPPC (device%, data%)	Configures the instrument for parallel polling. The QuickBASIC command additionally executes PPE / PPD.



## RS-232-C Interface

The instrument is fitted with an RS-232-C interface as standard. The 9-contact interface is provided at the rear of the unit. A controller for remote control can be connected via the interface.

### Characteristics of Interface

- Serial data transmission in asynchronous mode
- Bidirectional data transmission via two separate lines
- Selectable transmission rate from 120 to 15200 baud
- Logic 0 signal level from +3 V to +15 V
- Logic 1 signal level from –15 V to –3 V
- An external unit (controller) can be connected
- Software handshake (XON, XOFF)
- Hardware handshake

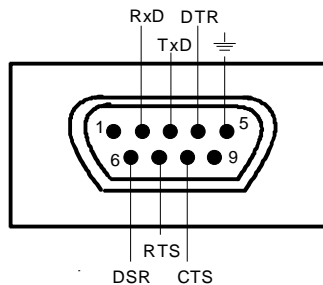

Fig. 5-6 Pin assignment of RS-232-C interface

### Signal Lines

- RxD** (Receive Data):  
Data line; transmission from external controller to instrument.
- TxD** (Transmit Data):  
Data line; transmission from instrument to external controller.
- DTR** (Data terminal ready):  
Output (logic zero = active). With DTR, the instrument indicates that it is ready to receive data. The DTR line controls the instrument's readiness for reception.
- GND:**  
Interface ground, connected to instrument ground.
- DSR** (Data Set Ready):  
(In the case of instruments with a VAR2 REV3 front module, the DSR line is used instead of the CTS line.)
- RTS** (Request To Send):  
Output (logic 0 = active). With RTS, the instrument indicates that it is ready to receive data. The RTS line controls the instrument's readiness for reception.
- CTS** (Clear To Send):  
Input (logic 0 = active). CTS informs the instrument that the opposite station is ready to receive data.

## Transmission Parameters

To ensure error-free and correct data transmission, the transmission parameters on the instrument and the controller must have the same settings. The settings are made in the Utilities - System-RS232 menu.

<b>Transmission rate (baud rate)</b>	Eight different baud rates can be set on the instrument: 1200, 2400, 4800, 9600, 19200, 38400, 57600, 115200
<b>Data bits</b>	Data transmission is in 8-bit ASCII code. The LSB (least significant bit) is transmitted as the first bit.
<b>Start bit</b>	The transmission of a data byte is initiated with a start bit. The falling edge of the start bit indicates the beginning of the data byte.
<b>Parity bit</b>	No parity bit is used.
<b>Stop bit</b>	The transmission of a data byte is terminated by a stop bit.

### Example:

Transmission of character A (41 hex) in 8-bit ASCII code:

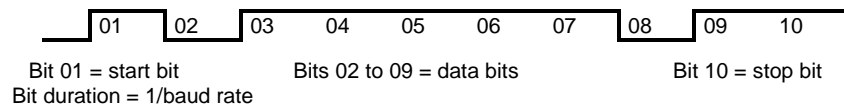

## Interface Functions

For interface control, a number of control characters defined from 0 to 20 hex of the ASCII code can be transmitted via the interface.

Table 5-8 Control characters for RS-232-C interface

Control character	Function
<Ctrl Q> 11 hex	Enable character output (XON)
<Ctrl S> 13 hex	Stop character output (XOFF)
Break (at least 1 character logic 0)	Reset instrument
0Dhex, 0Ahex	Terminator <CR><LF> Local/remote switchover

## Handshake

### Software handshake

The software handshake with the XON/XOFF protocol controls data transmission. If the receiver (instrument) wishes to inhibit the input of data, it sends XOFF to the transmitter. The transmitter then interrupts data output until it receives XON from the receiver. The same function is also provided at the transmitter end (controller).

**Note:** *The software handshake is not suitable for the transmission of binary data. Here the hardware handshake is to be preferred.*

### Hardware handshake

With a hardware handshake, the instrument signals its readiness for reception via the lines DTR and RTS. A logic 0 means "ready", a logic 1 means "not ready".

Whether or not the controller is ready for reception is signalled to the instrument via the CTS or the DSR line (see section "Signal Lines"). The transmitter of the instrument is switched on by a logic 0 and off by a logic 1. The RTS line remains active as long as the serial interface is active. The DTR line controls the instrument's readiness for reception.

### Wiring between instrument and controller

Wiring between the instrument and the controller is by means of a null modem, ie the data, control and signalling lines have to be cross-connected. The wiring plan below applies to controllers with a 9-pin or 25-pin connector.

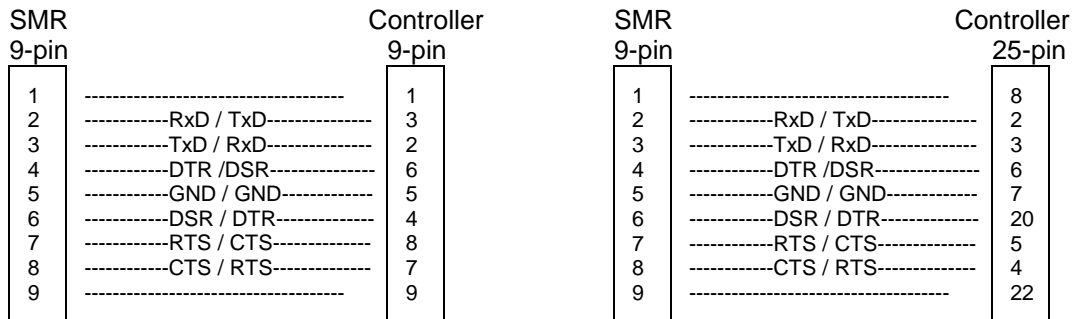

Fig. 5-7 Wiring of data, control and signalling lines for hardware handshake

## 6 Remote Control – Description of Commands

In the following sections, all commands implemented in the instrument are first listed in tables and then described in detail, separated according to the command system. The notation corresponds to the one of the SCPI standards to a large extent. The SCPI conformity information can be taken from the list of commands at the end of this chapter.

The description of manual operation, Chapter 4, indicates the corresponding IEC/IEEE-bus command for each manual setting.

A general introduction to remote control and a description of the status registers are to be found in Chapter 5. Detailed program examples of the main functions are to be found in Chapter 7.

**Note:** *In contrast to manual control, which is intended for maximum possible operating convenience, the priority of remote control is the predictability of the device status. This means that when incompatible settings are attempted, the command is ignored and the device status remains unchanged, i.e. is not adapted to other settings. Therefore, IEC/IEEE-bus control programs should always define an initial device status (e.g. with command \*RST) and then implement the required settings.*

### Notation

#### Table of Commands

Command:	In the command column, the table provides an overview of the commands and their hierarchical arrangement (see indentations).
Parameter:	In the parameter column the requested parameters are indicated together with their specified range.
Unit:	The unit column indicates the basic unit of the physical parameters.
Remark:	In the remark column an indication is made on <ul style="list-style-type: none"> <li>– whether the command does not have a query form,</li> <li>– whether the command has only one query form,</li> <li>– whether this command is implemented only with a certain option of the instrument.</li> </ul>

#### Indentations

The different levels of the SCPI command hierarchy are represented in the table by means of indentations to the right. The lower the level is, the farther the indentation to the right is. Please observe that the complete notation of the command always includes the higher levels as well.

Example: :SOURCE:FM:MODE is represented in the table as follows:

:SOURCE	first level
:FM	second level
:MODE	third level

In the individual description, the complete notation of the command is given. An example for each command and - if it exists - the default value (\*RST) is written out at the end of the individual description.

**Upper/lower case notation**

Upper/lower case letters serve to mark the long or short form of the key words of a command in the description. The instrument itself does not distinguish between upper and lower case letters.

**Special characters |**

A selection of key words with an identical effect exists for several commands. These key words are indicated in the same line, they are separated by a vertical stroke. Only one of these key words has to be indicated in the header of the command. The effect of the command is independent of which of the key words is indicated.

Example: :SOURce  
:FREQuency  
:CW|:FIXed

The two following commands of identical meaning can be formed. They set the frequency of the constantly frequent signal to 1 kHz:

:SOURce:FREQuency:CW 1E3 = SOURce:FREQuency:FIXed 1E3

A vertical stroke in indicating the parameters marks alternative possibilities in the sense of "or". The effect of the command is different, depending on which parameter is entered.

Example: Selection of the parameters for the command

SOURce:COUPling AC | DC

If parameter AC is selected, only the AC content is fed through, in the case of DC, the DC as well as the AC content.

- [ ] Key words in square brackets can be omitted when composing the header (cf. Chapter 5, Section "Optional Key"). The full command length must be accepted by the instrument for reasons of compatibility with the SCPI standards.  
Parameters in square brackets can optionally be incorporated in the command or omitted as well.
- { } Parameters in braces can optionally be incorporated in the command either not at all, once or several times.

## Common Commands

The common commands are taken from the IEEE 488.2 (IEC 625-2) standard. Some commands have the same effect on different devices. The headers of these commands consist of an asterisk "\*" followed by three letters. Many common commands refer to the status reporting system which is described in detail in Chapter 5.

Table 6-1 Common Commands

Command	Parameter	Unit	Remark
*CLS			No query
*ESE	0 to 255		
*ESR?			Query only
*IDN?			Query only
*IST?			Query only
*OPC			
*OPC?			Query only
*OPT?			Query only
*PRE	0 to 255		
*PSC	0   1		
*RCL	1 to 50		No query
*RST			No query
*SAV	1 to 50		No query
*SRE	0 to 255		
*STB?			Query only
*TRG			No query
*WAI			

### \*CLS

**CLEAR STATUS** sets the status byte (STB), the standard event register (ESR) and the EVENT-part of the QUESTIONABLE and the OPERATION register to zero. The command does not alter the mask and transition parts of the registers. It clears the output buffer.

### \*ESE 0 to 255

**EVENT STATUS ENABLE** sets the event status enable register to the value indicated. Query \*ESE? returns the contents of the event status enable register in decimal form.

### \*ESR?

**STANDARD EVENT STATUS QUERY** returns the contents of the event status register in decimal form (0 to 255) and subsequently sets the register to zero.

**\*IDN?**

**IDENTIFICATION QUERY** queries the instrument identification.

The device response is for example: "Rohde&Schwarz,SMR20,00000001,1.04"

02 = variant identification

00000001= serial number

1.04 = firmware version number

**\*IST?**

**INDIVIDUAL STATUS QUERY** returns the contents of the IST flag in decimal form (0 | 1). The IST flag is the status bit which is sent during a parallel poll.

**\*OPC**

**OPERATION COMPLETE** sets bit 0 in the event status register when all preceding commands have been executed. This bit can be used to initiate a service request.

**\*OPC?**

**OPERATION COMPLETE QUERY** returns 1, if all preceding commands have been executed. It is necessary to consider a sufficiently long time-out for the IEEE/IEC-bus.

**\*OPT?**

**OPTION IDENTIFICATION QUERY** queries the options included in the instrument and returns a list of the options installed. The options are separated from each other by means of commas. For every option, a fixed position is provided in the response.

Table 6-2 Device Response to \*OPT?

Position	Option
1	SMR-B1 Reference oscillator OXCO
2	reserved
3	SMR-B3 Frequency resolution 0.1 Hz
4	SMR-B4 Ramp sweep
5	SMR-B5 AM/FM scan modulator
6	reserved
7	SMR-B11 Frequency extension 0.01...1 GHz
8	SMR-B14 Pulse generator
9	SMR-B15 RF attenuator 20 GHz (SMR20/SMR27)
10	SMR-B17 RF attenuator 40 GHz (SMR30/SMR40)
11	SMR-B19 Rear panel connectors RF - LF (SMR20/SMR27)
12	SMR-B20 Rear panel connectors RF - LF (SMR30/SMR40)
13	SMR-B23 IF input, 20 GHz (SMR20)
14	SMR-B24 IF input, 40 GHz (SMR27/SMR30/SMR40)

Example for a device response: SMR-B1,SMR-B3,0, 0,0,0,0,0,0,SMR-B15,0,0,0

**\*PRE** 0 to 255

**PARALLEL POLL REGISTER ENABLE** sets the parallel poll enable register to the value indicated. Query \*PRE? returns the contents of the parallel poll enable register in decimal form.

**\*PSC** 0 | 1

**POWER ON STATUS CLEAR** determines whether the contents of the ENABLE registers is maintained or reset in switching on.

\*PSC = 0 causes the contents of the status registers to be maintained. Thus a service request can be triggered in switching on in the case of a corresponding configuration of status registers ESE and SRE.

\*PSC ≠ 0 resets the registers.

Query \*PSC? reads out the contents of the power-on-status-clear flag. The response can be 0 or 1.

**\*RCL** 1 to 50

**RECALL** calls the instrument state which was stored under the number supplied using command \*SAV. 50 instrument states can be stored.

**\*RST**

**RESET** sets the instrument to a defined default status. The command essentially corresponds to pressing the [PRESET] key. The state of the RF-output is an exception: The RF-output is deactivated after \*RST, however, it is activated after the [RESET] key has been pressed. The default setting is indicated in the description of the commands.

**\*SAV** 1 to 50

**SAVE** stores the current instrument state under the number indicated (cf. \*RCL as well).

**\*SRE** 0 to 255

**SERVICE REQUEST ENABLE** sets the service request enable register to the value indicated. Bit 6 (MSS mask bit) remains 0. This command determines under which conditions a service request is triggered. Query \*SRE? reads the contents of the service request enable register in decimal form. Bit 6 is always 0.

**\*STB?**

**READ STATUS BYTE QUERY** reads out the contents of the status byte in decimal form.

**\*TRG**

**TRIGGER** triggers all actions waiting for a trigger event. Special trigger events can be started by command system "TRIGger" (see section "TRIGger System").

**\*WAI**

**WAIT-to-CONTINUE** only permits the servicing of the subsequent commands after all preceding commands have been executed and all signals have settled (cf. "\*OPC" as well).



## ABORt-System

The ABORt system contains the commands to abort actions triggered. After an action has been aborted, it can be triggered again at once. All commands trigger an event, thus they have no \*RST value.

Further commands for the trigger system of the SMR can be found in the TRIGger system.

Command	Parameter	Default Unit	Remark
<b>:ABORt</b> <b>[:SWEep]</b> <b>:LIST</b> <b>:MSEquence</b>			No query No query No query

### **:ABORt[:SWEep]**

The command aborts a sweep.

Example: :ABOR:SWE

### **:ABORt:LIST**

The command aborts a list execution.

Example: :ABOR:LIST

### **:ABORt:MSEquence**

The command aborts a Memory Sequence.

Example: :ABOR:MSEQ

## DIAGnostic-System

The DIAGnostic system contains the commands for diagnostic test and service of the instrument. SCPI does not define DIAGnostic commands, the commands listed here are SMR-specific. All DIAGnostic commands are queries which are not influenced by \*RST. Hence no default setting values are stated.

Command	Parameter	Default Unit	Remark
<b>:DIAGnostic</b> <b>:INFO</b> <b>:CCOunt</b> <b>:ATTenuator1 2 3 4?</b> <b>:POWER?</b> <b>:MODules?</b> <b>:OTIME?</b> <b>:SDATe?</b> <b>[ :MEASure]</b> <b>:POINt?</b>			   Query only Query only Query only Query only Query only  Query only

### :DIAGnostic:INFO

The commands which can be used to query all information which does not require hardware measurement are under this node.

### :DIAGnostic:INFO:CCOunt

The commands which can be used to query all counters in the instrument are under this node (Cycle COunt).

### :DIAGnostic:INFO:CCOunt:ATTenuator1|2|3|4?

The command queries the number of switching processes of the different attenuator stages. The stages are designated with Z1 to Z4 within the instrument. In this command they are differentiated by a numeric suffix whose name corresponds to the number:

Suffix	Name	Function
1	Z1	10-dB-stage
2	Z2	20-dB- stage
3	Z3	40-dB- stage
4	Z4	40-dB- stage

Example:    :DIAG:INFO:CCO:ATT1?

Response: 1487

### :DIAGnostic:INFO:CCOunt:POWER?

The command queries the number of switch-on processes.

Example:    :DIAG:INFO:CCO:POW?

Response: 258

**:DIAGnostic:INFO:MODules?**

The command queries the modules existing in the instrument with their model and state-of-modification numbers. The response supplied is a list in which the different entries are separated by commas. The length of the list is variable and depends on the equipment of the instrument. Each entry consists of three parts which are separated by means of blanks:

1. Name of module
2. Variant of module in the form VarXX (XX = 2 digits)
3. Revision of module in the form RevXX (XX = 2 digits)

Example :DIAG:INFO:MOD?

Response: ROSC VAR01 REV00

**:DIAGnostic:INFO:OTIME?**

The command reads out the internal operating-time counter. The response supplies the number of hours the instrument has been in operation.

Example: :DIAG:INFO:OTIM?

Response: 19

**:DIAGnostic:INFO:SDATe?**

The command queries the date of software creation. The response is returned in the form year, month, day.

Example: :DIAG:INFO:SDAT?

Response: 1992, 12, 19

**:DIAGnostic[:MEASure]**

The commands which trigger a measurement in the instrument and return the measured value are under this node.

**:DIAGnostic[:MEASure]:POINT?**

The command triggers a measurement at a measuring point and returns the voltage measured. The measuring point is specified by a numeric suffix (cf. service manual).

Example: :DIAG:MEAS:POIN2?

Response: 3.52

## DISPLAY-System

This system contains the commands to configure the screen. If system security is activated using command `SYSTem:SECurity ON`, the display cannot be switched on and off arbitrarily (cf. below).

Command	Parameter	Default Unit	Remark
<b>:DISPlay</b> <b>:ANNotation</b> <b>[:ALL]</b> <b>:AMPLitude</b> <b>:FREQuency</b>	 ON   OFF ON   OFF ON   OFF		

### :DISPlay:ANNotation

The commands determining whether frequency and amplitude are indicated are under this node.

**Caution:** *With SYSTem:SECurity ON, the indications cannot be switched from OFF to ON. In this case \*RST does not influence the ANNotation settings either. With SYSTem:SECurity OFF, the \*RST value is ON for all ANNotation parameters.*

### :DISPlay:ANNotation[:ALL] ON | OFF

The command switches the frequency and amplitude indication on or off.

Command `:DISP:ANN:ALL ON` can only be executed if `SYST:SEC` is set to OFF.

Example: `:DISP:ANN:ALL ON` With `SYST:SEC OFF` - \*RST value is ON

### :DISPlay:ANNotation:AMPLitude ON | OFF

The command switches on or off the amplitude indication.

Command `:DISP:ANN:AMPL ON` can only be executed if `SYST:SEC` is set to OFF.

Example: `:DISP:ANN:AMPL ON` With `SYST:SEC OFF` - \*RST value is ON

### :DISPlay:ANNotation:FREQuency ON | OFF

The command switches on or off the frequency indication.

Command `:DISP:ANN:FREQ ON` can only be executed if `SYST:SEC` is set to OFF.

Example: `:DISP:ANN:FREQ ON` With `SYST:SEC OFF` - \*RST value is ON

## INPut-System

This system contains the commands for the IF input of the SMR.

Command	Parameter	Default Unit	Remark
:INPut :IF :STATe	OFF   ON		

**:INPut:IF:STATe OFF | ON**

The command switches on or off the IF input.

Example: :INP:IF:STAT ON

\*RST value is OFF

## MEMory-System

This system contains the commands for the memory management of the SMR.

Command	Parameter	Default Unit	Remark
:MEMory :NSTates?			Query only

**:MEMory:NStates?**

The command returns the number of \*SAV/\*RCL memories available. The SMR has 50 \*SAV/\*RCL memories in total.

Example: :MEM:NST?

Response: 50

## OUTPut-System

This system contains the commands specifying the characteristics of the RF and LF output sockets and the auxiliary sockets BLANK, Z-AXIS and V/GHz. The following numbers are assigned to these outputs:

OUTPut1: RF output, BLANK output and Z-AXIS output,

OUTPut2: LF output,

OUTPut3: V/GHz output.

Command	Parameter	Default Unit	Remark
<b>:OUTPut1 2 3</b>			
<b>:AMODe</b>	AUTO   FIXed		
<b>:ATTenuation</b>	0 to 110	dB	
<b>:IMPedance?</b>			Query only
<b>:POLarity</b>			
<b>:PULSe</b>	NORMal   INVerted		
<b>:SCALE</b>	0.5   1		
<b>:SOURce</b>	OFF   PULSegen   VIDeo		
<b>[:STATe]</b>			
<b>:PON</b>	OFF   UNCHanged		
<b>:VOLTage</b>	0 V to 4 V	V	

### :OUTPut1:AMODe AUTO | FIXed

The command switches over the operating mode of the attenuator (Attenuator MODe) at the RF output (output1).

AUTO The attenuator is switched whenever possible.

FIXed The attenuator is switched when certain fixed levels are exceeded/not reached.

Example: :OUTP:AMOD AUTO \*RST value is AUTO

### :OUTPut1:ATTenuation 0 to 110 dB

The command determines the attenuation value of the RF output signal in 10 dB steps. IF input has to be switched on (:INPut:IF:STATe to ON).

Example: :OUTP:ATT 20 dB \*RST value is 0

### :OUTPut1:IMPedance?

The command queries the impedance of the RF output (output1). This permits converting the output level between the units V and W. The impedance itself cannot be changed. For the RF output, it is fixed at the value of 50 Ohm.

Example: :OUTP:IMP? Response: 50



## SOURce System

This system contains the commands to configure the RF signal source. Keyword SOURce is optional, i.e., it can be omitted. The LF signal source (included in Option SMR-B5) is configured in the SOURce2 System.

The following subsystems are realized in the instrument:

Subsystem	Settings
<b>[:SOURce]</b>	
<b>:AM</b>	Amplitude modulation
<b>:CORRection</b>	Correction of the output level
<b>:DM</b>	Digital modulation
<b>:FM</b>	Frequency modulation
<b>:FREQuency</b>	Frequencies including sweep
<b>:LIST</b>	LIST operating mode
<b>:MARKer</b>	Marker generation with sweeps
<b>:POWER</b>	Output level, level control and level correction
<b>:PULM</b>	Pulse modulation
<b>:PULSe</b>	Pulse generator
<b>:ROSCillator</b>	Reference oscillator
<b>:SWEep</b>	Sweeps

## SOURce:AM Subsystem

This subsystem contains the commands to control the amplitude modulation. An LF generator which serves as internal modulation source can be fitted in the instrument (included in option SMR-B5). Part of the settings is effected under SOURce2.

Command	Parameters	Default Unit	Remark
<b>[:SOURce]</b>			
<b>:AM</b>			Option SMR-B5
<b>[:DEPTH]</b>	0 to 100 PCT	PCT	
<b>:EXTeRnal1 2</b>			
<b>:COUPling</b>	AC   DC		
<b>:IMPedance</b>	600 Ohm   100 kOhm	Ohm	
<b>:INTeRnal</b>			Option SMR-B5
<b>:FREQuency</b>	0. 1 Hz to 10 MHz	Hz	
<b>:SCAN</b>	ON   OFF		Option SMR-B5
<b>:SENSitivity</b>	0 to 10 dB/V		
<b>[:STATe]</b>	OFF   ON		
<b>:SOURce</b>	INTeRnal   EXTeR1  EXTeR2		
<b>:STATe</b>	ON   OFF		

**[:SOURce]:AM[:DEPTH]** 0 to 100 PCT

The command sets the modulation depth in percent.

\*RST value is 30PCT

Example:    : SOUR:AM:DEPT 15PCT



**[[:SOURce]:AM:EXTernal1|2**

The commands to set the external AM input are under this node.

**[[:SOURce]:AM:EXTernal1|2:COUPling AC | DC**

The command selects the type of coupling for the external AM input.

AC The d.c. voltage content is separated from the modulation signal.

DC The modulation signal is not altered.

\*RST value is AC

Example: :SOUR:AM:EXT2:COUP AC

**[[:SOURce]:AM:EXTernal1|2:IMPedance 600 Ohm | 100 kOhm**

The command defines the input impedance of the external AM-input. This command is coupled to the commands

:SOURce:FM:EXTernal:IMPedance,

:SOURce:DM:EXTernal:IMPedance

\*RST value is 100 kOhm

Example: :SOUR:AM:EXT:IMP 100kOhm

**[[:SOURce]:AM:INTernal**

The settings for the internal AM input are effected under this node.

Here the same hardware is set for AM, FM und SOURce2. This means that, for example, the following commands are coupled to each other and have the same effect:

SOUR:AM:INT:FREQ

SOUR:FM:INT:FREQ

SOUR2:FREQ: CW

**[[:SOURce]:AM:INTernal:FREQuency 0.1Hz to 10 MHz**

The command sets the modulation frequency.

Example: :SOUR:AM:INT:FREQ 15kHz

\*RST value is 1 kHz

**[[:SOURce]:AM:SOURce INT | EXT1 | EXT2**

The command selects the modulation source. An external and an internal modulation source can be specified at the same time (see example).

Example: :SOUR:AM:SOUR EXT, INT

\*RST value is INT

**[[:SOURce]:AM:SCAN:SENSitivity –0.1 to 10 dB/V**

The command sets the scan sensitivity. The resolution is 0.01 dB/V.

Example: :SOUR:AM:SCAN 0.1dB/V

**[[:SOURce]:AM:SCAN[:STATe] OFF | ON**

The command switches the logarithmic amplitude modulation on or off.

Example: :SOUR:AM:SCAN ON

\*RST value is OFF

**[[:SOURce]:AM:STATe OFF | ON**

The command switches amplitude modulation on or off.

Example: :SOUR:AM:STAT ON

\*RST value is OFF

## SOURce:CORRection Subsystem

The CORRection subsystem permits a correction of the output level. The correction is effected by adding user-defined table values to the output level as a function of the RF frequency. In the SMR, this subsystem serves to select, transmit and switch on User-Correction tables (see Section "User Correction (Ucor)" as well).

Command	Parameters	Default Unit	Remark
[:SOURce] :CORRection [:STATe] :CSET :CATalog? :FREE? [:SElect] :DATA :FREQuency :POWer :POINts? :DElete :ALL	ON   OFF  "name of table "  1 GHz to $F_{max}$ {,1 GHz to $F_{max}$ }  +20 to -20dB {,+20 to -20dB }  "name of table "	    Hz  dB	  query only query only  witht option SMR-B11 above 10 MHz  query only

### [:SOURce]:CORRection[:STATe] ON | OFF

The command switches the table selected using SOUR:CORR:CSET on or off.

Example: :SOUR:CORR:STAT ON

\*RST value is OFF

### [:SOURce]:CORRection:CSET

The commands to select and edit the Ucor tables are under this node.

### [:SOURce]:CORRection:CSET:CATalog?

The command requests a list of Ucor tables. The individual lists are separated by means of commas. This command is a query and has no \*RST value.

Example: :SOUR:CORR:CAT?

Answer: "UCOR1", "UCOR2", "UCOR3"

### [:SOURce]:CORRection:CSET:FREE?

This command queries the free space in the Ucor table.

The command is a query and thus has no \*RST value.

Example: :SOUR:CORR:FREE?

**[[:SOURce]:CORRection:CSET[:SELEct] "name of table"**

The command selects a Ucor table. This command alone does not yet effect a correction. First the table selected must be activated (cf. :SOUR:CORR:STAT). If there is no table of this name, a new table is created. The name may contain up to 7 letters. This command triggers an event and hence has no \*RST value.

Example: :SOUR:CORR:CSET:SEL "UCOR1 "

**[[:SOURce]:CORRection:CSET:DATA**

The commands to edit the Ucor tables are under this node.

**[[:SOURce]:CORRection:CSET:DATA:FREQuency 1 GHz to  $F_{max}$  {,1 GHz to  $F_{max}$ }  
(with option SMR-B11 above 10 MHz)**

The command transmits the frequency data for the table selected using :SOUR:CORR:CSET. The frequency values must be entered in ascending order. \*RST does not influence data lists.

Example: :SOUR:CORR:CSET:DATA:FREQ 100MHz,102MHz,103MHz,...

**[[:SOURce]:CORRection:CSET:DATA:POWer +20 to -20dB {,+20 to -20dB }**

The command transmits the level data for the table selected using :SOUR:CORR:CSET. \*RST does not influence data lists.

Example: :SOUR:CORR:CSET:DATA:POWer 1dB, 0.8dB, 0.75dB,...

**[[:SOURce]:CORRection:CSET:DATA:POWer:POINts?**

The command returns the number of list elements.

This command is a query and hence has no \*RST value.

Example: :SOUR:CORR:CSET:DATA:POW:POIN?

**[[:SOURce]:CORRection:CSET:DELEte "name of table"**

The command deletes the table indicated from the instrument memory. This command triggers an event and hence has no \*RST value.

Example: :SOUR:CORR:CSET:DEL "UCOR3 "

## SOURce:DM Subsystem

In this subsystem, the digital modulations ASK and FSK are controlled (see Chapter 4, Section "Digital Modulations ASK and FSK"). An external input (EXT1) is available as a data source. This source is set independently of the type of modulation selected. The settings hence affect both types of digital modulations.

Command	Parameters	Default Unit	Remark
[:SOURce] :DM :TYPE :STATe :EXTernal :IMPedance :ASK :DEPTH :POLarity :FSK :DEVIation :POLarity	ASK   FSK ON   OFF  600 Ohm   100 kOhm  0 to 100 PCT NORMal   INVerted  0 kHz to 20/40 MHz NORMal   INVerted	   Ohm  PCT  Hz	   Option SMR-B5  Option SMR-B5

### [:SOURce]:DM:TYPE ASK | FSK

The command selects the modulation type.

ASK        Amplitude Shift Keying

FSK        Frequency Shift Keying

Example:    :SOUR:DM:TYPE FSK

\*RST value is FSK

### [:SOURce]:DM:STATe ON | OFF

The command switches on or off the modulation selected under :SOUR:DM:TYPE.

Example:    :SOUR:DM:STAT OFF

\*RST value is OFF

### [:SOURce]:DM:EXTernal

The commands to configure the EXT1-input are under this node.

### [:SOURce]:DM:EXTernal:IMPedance 600 Ohm | 100 kOhm

The command defines the input impedance of the external DM-input (EXT1).

This command is coupled to the commands :SOUR:AM:EXT:IMP and SOUR:FM:EXT:IMP.

Example:    :SOUR:DM:EXT:IMP 100kOhm

\*RST value is 100 kOhm

**[[:SOURce]:DM:ASK**

The commands to set the external data source for the digital amplitude modulation are under this node.

**[[:SOURce]:DM:ASK:DEPTH 0 to 100%**

This command sets the modulation depth.

\*RST value is 10 kHz

Example: :SOUR:DM:ASK:DEPT 10E3

**[[:SOURce]:DM:ASK:POLarity NORMAL | INVerted**

The command defines the polarity of the modulation.

NORMAL A "0" from the data source reduces the amplitude, a "1" increases it.

INVerted A "1" from the data source reduces the amplitude, a "0" increases it.

Example: :SOUR:DM:ASK:POL INV

\*RST value is NORM

**[[:SOURce]:DM:FSK**

The commands to set the data source for the digital frequency modulation are under this node.

**[[:SOURce]:DM:FSK:DEVIation 0 kHz to 20/40 MHz**

This command sets the frequency deviation of the FSK-modulation. The maximum deviation possible depends on the selected frequency (see Data Sheet).

Example: :SOUR:DM:FSK:DEV 3kHz

\*RST value is 10 kHz

**[[:SOURce]:DM:FSK:POLarity NORMAL | INVerted**

The command specifies the polarity of the modulation.

NORMAL Logical "0" reduces the frequency, logical "1" increases it.

INVerted Logical "1" reduces the frequency, logical "0" increases it.

Example: :SOUR:DM:FSK:POL INV

\*RST value is NORM

## SOURce:FM Subsystem

This subsystem contains the commands to control the frequency modulation and to set the parameters of the modulation signal.

Command	Parameters	Default Unit	Remark
[:SOURce] :FM			Option SMR-B5
[:DEVIation]	0 kHz to 20/40 MHz	Hz	
:EXTernal1 2			
:COUpling	AC   DC		
:IMPedance	600 Ohm   100 kOhm	Ohm	
:INTernal			
:FREQuency	0.1 Hz to 10 MHz	Hz	
:SOURce	INT   EXT1   EXT2		
:STATe	ON   OFF		

### [:SOURce]:FM [:DEVIation] 0 kHz to 20/40 MHz

The command specifies the frequency variation caused by the FM. The maximum possible deviation depends on the selected frequency (see Data Sheet). Although the LF generator is used as modulation source, the frequency deviation is independent of the voltage at the LF output.

Example: :SOUR:FM1:DEV 5kHz

\*RST value is 10 kHz

### [:SOURce]:FM:EXTernal1|2

The commands to set the external FM input are under this node. The settings under EXTernal for modulations AM and FM are independent of each other. The settings are always related to the socket which is determined by the numeric suffix after EXTernal. A command without suffix is interpreted like a command with suffix 1.

### [:SOURce]:FM:EXTernal1|2:COUpling AC | DC

The command selects the type of coupling for the external FM input.

AC The d.c. voltage content is separated from the modulation signal.

DC The modulation signal is not altered.

Example: :SOUR:FM:EXT:COUP AC

\*RST value is AC

### [:SOURce]:FM:EXTernal1|2:IMPedance 600 Ohm | 100 kOhm

The command defines the input impedance of the external FM-input. This command is coupled to the commands :SOUR:AM:EXT:IMP and :SOUR:DM:EXT:IMP.

Example: :SOUR:FM:EXT:IMP 100kOhm

\*RST value is 100 kOhm







**[:SOURce]:FREQuency:RCL INCLude | EXCLude**

The command determines the effect of the recall function on the frequency. \*RST value has no effect to this setting.

**INCLude** The saved frequency is loaded when instrument settings are loaded with the [RCL] key or with a memory sequence.

**EXCLude** The RF frequency is not loaded when instrument settings are loaded, the current settings are maintained.

Example: `:SOUR:FREQ:RCL INCL`

**[:SOURce]:FREQuency:MANual 1 GHz to  $F_{max}$  (10 MHz to  $F_{max}$  with Option SMR-B11)**

The command sets the frequency if `SWE:MODE MAN` and `:FREQ:MODE SWE` are set. Only frequency values between the settings with `[ :SOUR ]:FREQ:STAR` and `. . . :STOP` are permitted. (As to the permitted range, cf. `FREQ:CENT`).

Example: `:SOUR:FREQ:MAN 5GHz` \*RST value is 10 GHz

**[:SOURce]:FREQuency:MODE CW | FIXed | SWEep | LIST**

The command specifies the operating mode and hence also specifies which commands control the FREQuency subsystem. The parameters are assigned as follows:

**CW | FIXed** CW and FIXed are synonyms. The output frequency is specified by means of `[ :SOUR ]:FREQ:CW | FIX`.

**SWEep** The instrument operates in the SWEep-mode. The frequency is specified by means of commands `[ :SOUR ]:FREQ:STAR; STOP; CENT; SPAN; MAN`.

**LIST** The instrument processes a list of frequency and level settings. The settings are effected in the `:SOUR:LIST` Subsystem. Setting `SOUR:FREQ:MODE LIST` automatically sets command `SOUR:POW:MODE` to LIST as well.

Example: `:SOUR:FREQ:MODE LIST` \*RST value is CW

**[:SOURce]:FREQuency:MULTiplier 1.0 to 10.0**

The command is used to enter the multiplier of a possible frequency multiplier connected in series (see Chapter 4, Section "Frequency Offset and Multiplier"). If a multiplier or a frequency offset value have been entered, the frequency entered using `SOUR:FREQ: . . .` is no longer identical with the RF-output frequency. The following relation holds:

$$SOUR:FREQ: . . . = \text{RF-output frequency} \times \text{MULTiplier} + \text{OFFset}.$$

The entry of a multiplier does not change the RF-output frequency but only the value queried by `[ :SOUR ]:FREQ: . . . . .`

Example: `:SOUR:FREQ:MULT 2` \*RST value is 1

**[:SOURce]:FREQuency:OFFSet -50 to +50 GHz**

The command sets the frequency offset of a mixer which might be series-connected (cf. above, `:FREQ:MULT` and Chapter 4, Section "Frequency Offset and Multiplier").

Example: `:SOUR:FREQ:OFFS 100MHz` \*RST value is 0

**[:SOURce]:FREQuency:SPAN  $F_{max}$  - 1 GHz (with Option SMR-B11:  $F_{max}$  - 10 MHz)**

This command specifies the frequency range for the sweep. This parameter is coupled to the start and stop frequency. Negative values for SPAN are permitted, then `STARt > STOP` is true. The following relations hold:

$$\text{STARt} = \text{CENTer} - \text{SPAN}/2$$

$$\text{STOP} = \text{CENTer} + \text{SPAN}/2$$

\*RST value is (STOP - STARt)

Example: `:SOUR:FREQ:SPAN 10GHz`

**[:SOURCE]:FREQUENCY:START** 1 GHz to  $F_{max}$  (10 MHz to  $F_{max}$  with Option SMR-B11)

This command defines the starting value of the frequency for the sweep operation. Parameters START, STOP, SPAN and CENT are coupled to each other. START may be larger than STOP. (As to specified range, cf. `FREQ:CENT`).

Example: `:SOUR:FREQ:STAR 2GHz`

\*RST value is 10 GHz

**[:SOURCE]:FREQUENCY:STOP** 1 GHz to  $F_{max}$  (10 MHz to  $F_{max}$  with Option SMR-B11)

This command indicates the final value of the frequency for the sweep operation (see START as well). (As to the specified range, cf. `FREQ:CENT`).

Example: `:SOUR:FREQ:STOP 15GHz`

\*RST value is 20 GHz

**[:SOURCE]:FREQUENCY:STEP**

The command to enter the step width for the frequency setting if frequency values UP or DOWN are used is under this node. This command is coupled to the Knob Step command in manual control. Only linear step widths can be set.

**[:SOURCE]:FREQUENCY:STEP[:INCREMENT]** 0 to 10 GHz

The command sets the step width for the frequency setting.

Example: `:SOUR:FREQ:STEP:INCR 1MHz`

\*RST value is 1 MHz



**[:SOURce]:LIST:DWELI** 1 ms to 1 s

The command specifies the time the instrument "dwells" at this item.

Example: `:SOUR:LIST:DWEL 0.15`

**[:SOURce]:LIST:DWELI:POINTs?**

The command queries the length (in items) of the DWELI-part of the list. The command is a query and thus has no \*RST value.

Example: `:SOUR:LIST:DWEL:POIN?`

Answer: 1

**[:SOURce]:LIST:FREE?**

The command queries two values. The first one indicates the space still vacant for lists (in items), the second one the space already occupied, also in items. The command is a query and thus has no \*RST value.

Example: `:SOUR:LIST:FREE?`

Answer: 2000, 3

**[:SOURce]:LIST:FREQuency** 1 GHz...F<sub>max</sub> {,1 GHz...F<sub>max</sub>} Block data  
(Option SMR-B11 above 10 MHz)

The command fills the FREQuency part of the list selected with data. The data can either be indicated as a list of numbers (separated by commas) of arbitrary length or as binary block data. In the case of block data transmission, always 8 (4) bytes are interpreted as a floating-point number of double accuracy.

Example: `:SOUR:LIST:FREQ 14GHz, 13GHz, 12GHz,...`

**[:SOURce]:LIST:FREQuency:POINTs?**

The command queries the length (in items) of the FREQuency part of the list presently selected. The command is a query and thus has no \*RST value.

Example: `:SOUR:LIST:FREQ:POIN?`

Answer: 327

**[[:SOURce]:LIST:MODE AUTO | STEP**

The command indicates the mode in which the list is to be processed (by analogy with SOUR:SWE:MODE).

AUTO Each trigger event triggers a complete list run.

STEP Each trigger event triggers only one step in processing the list.

Example: :SOUR:LIST:MODE STEP \*RST value is AUTO

**[[:SOURce]:LIST:POWer -130 to +25 dBm {, -130 to +25 dBm} | Block data  
(-20 to +25 dBm without Option SMR-B15)**

The command fills the POWer part of the RF list selected with data. The data can either be indicated as a list of numbers (separated by commas) of arbitrary length or as binary block data. As to the format of the data, cf. command [ :SOUR ] :LIST:FREQ. \*RST does not influence data lists.

Example: :SOUR:LIST:POW 0dBm,-2dBm,-2dBm,-3dBm

**[[:SOURce]:LIST:POWer:POINts?**

The command queries the length (in items) of the LEVel part of the list presently selected. The command is a query and thus has no \*RST value.

Example: :SOUR:LIST:POW:POIN? Answer: 327

**[[:SOURce]:LIST:SElect "name of list"**

The command selects the list indicated. If there is no list of this name, a new list is created. The name may contain up to 7 letters. If the list does not exist yet, it is created. The command triggers an event and thus has no \*RST value.

Example: :SOUR:LIST:SEL "LIST1"

## SOURce:MARKer Subsystem

This subsystem contains the commands to control the generation of markers during the sweep. The SMR has ten markers each for frequency and level sweeps which are distinguished by a numeric suffix after MARKer. The settings for frequency sweep and level sweep marker are independent of each other.

Command	Parameters	Default Unit	Remark
<b>[[:SOURce]</b> <b>:MARKer 1   2   3...  10</b> <b>[[:FSWweep]</b> <b>:AMPLitude</b> <b>:AOFF</b> <b>:FREQuency</b>  <b>[[:STATe]</b> <b>:PSWweep</b> <b>:AOFF</b> <b>:POWer</b>  <b>[[:STATe]</b>	  ON   OFF  1 GHz to $F_{max}$  ON   OFF  -130 dBm to +25 dBm  ON   OFF	          Hz          dBm	          no query with Option SMR-B11: above 10 MHz          no query -20 dBm to +25dBm without Option SMR- B15

### [[:SOURce]:MARKer1|2|3|4|5|6|7|8|9|10[:FSWweep]

The commands for the markers with frequency sweep are under this node. Keyword :FSWweep can be omitted, then the command conforms to SCPI regulations.

### [[:SOURce]:MARKer1|2|3|4|5|6|7|8|9|10[:FSWweep]:AMPLitude ON | OFF

The command specifies whether the marker influences the signal level.

ON The output level is reduced by a constant value when the marker frequency is executed.

OFF The output level remains unchanged.

\*RST value is OFF

Example: :SOUR:MARK1:FSW:AMP ON

### [[:SOURce]:MARKer1|2|3|4|5|6|7|8|9|10[:FSWweep]:AOFF

Command (All markers off) switches off all frequency markers. This command triggers an event, thus it has no \*RST value and no query form.

Example: :SOUR:MARK:FSW:AOFF

**[[:SOURce]MARKer1|2|3|4|5|6|7|8|9|10[:FSweep]:FREQuency** 1 GHz to  $F_{max}$  (10 MHz to  $F_{max}$  with Option SMR-B11)

The command sets the marker selected by the numeric suffix with MARKer to the frequency indicated.

Here (like for the input value MARKer in the Sweep - Frequency menu), the Offset and Multiplier values of the FREQuency subsystem are taken into account. Thus the specified range indicated is only valid for SOUR:FREQ:OFFS 0.

\*RST value for MARK1: 10 GHz  
 MARK2: 15 GHz  
 MARK3: 20 GHz

Example: :SOUR:MARK1:FSW:FREQ 3 GHz

**[[:SOURce]MARKer1|2|3|4|5|6|7|8|9|10[:FSweep][:STATe] ON | OFF**

The command switches the marker selected by the numeric suffix after MARKer on or off.

Example: :SOUR:MARK1:FSW:STAT ON \*RST value is OFF

**[[:SOURce]MARKer1|2|3|4|5|6|7|8|9|10:PSweep**

The commands for the markers with level sweep are under this node (Power sweep). The ten markers are distinguished by a numeric suffix after MARKer.

**[[:SOURce]MARKer1|2|3|4|5|6|7|8|9|10:PSweepAOFF**

The command switches all level markers off. This command is an event and thus has no \*RST value and no query form.

Example: :SOUR:MARK:PSW:AOFF

**[[:SOURce]MARKer1|2|3|4|5|6|7|8|9|10:PSweep:POWe** -130 dBm to +25 dBm  
 (w/o SMR-B15: -20 dBm to +25 dBm)

The command sets the marker selected by the numeric suffix with MARKer to the level indicated. In this command, the OFFSet value of subsystem POWER (menu Level) is considered in correspondence with input value Marker in the Sweep - Level menu. Thus the specified range indicated is only valid for SOUR:POW:OFFS = 0.

\*RST value for MARK1: 1 dBm  
 MARK2: 2 dBm  
 MARK3: 3 dBm

Example: :SOUR:MARK1:PSW:POW -2dBm

**[[:SOURce]MARKer1|2|3|4|5|6|7|8|9|10:PSweep[:STATe] ON | OFF**

The command switches the marker selected by the numeric suffix with MARKer on or off.

Example: :SOUR:MARK1:PSW:STAT ON \*RST value is OFF

## SOURCE:POWER Subsystem

This subsystem contains the commands to set the output level, the level control and the level correction of the RF signal. Other units can be used instead of dBm:

- by indication directly after the numeric value (example :POW 0.5V).

Command	Parameters	Default Unit	Remark
[[:SOURCE]]			
:POWER			
:ALC			
:REFERENCE	0...3 V	V	Query only
:SEARCH?			
:SOURCE	INTERNAL   DIODE   PMETER		
:PMETER	RS_NRVS   HP436A		
[:STATE]	ON   OFF		
[:LEVEL]			
[:IMMEDIATE]			
[AMPLITUDE]	-130 dBm to +25 dBm	dBm	
:OFFSET	-100 to +100 dB	dB	
:LIMIT			
[:AMPLITUDE]	-130 dBm to +25 dBm	dBm	Without Option SMR-B15: value range for level settings AMPLITUDE, LIMIT, MANUAL, START and STOP at -20 dBm to +25 dBm
:MANUAL	-130 dBm to +25 dBm	dBm	
:MODE	CW   FIXED   SWEPT   LIST		
:START	-130 dBm to +25 dBm	dBm	
:STOP	-130 dBm to +25 dBm	dBm	
:STEP			
[:INCREMENT]	0.1 to 10 dB	dB	

### [[:SOURCE]:POWER:ALC

The commands checking the automatic level control are under this node.

#### [[:SOURCE]:POWER:ALC:REFERENCE 0 to 3 V

This command defines the reference voltage for operation with an external diode detector or with power meters from Hewlett-Packard.

Example: :SOUR:POW:ALC:REF \*RST value is 3 V

#### [[:SOURCE]:POWER:ALC:SEARCH?

This command defines under which conditions the control loop is temporarily closed. The command is suitable only if SOUR:ALC:STAT is set to OFF. This command is a query and hence has no \*RST value.

Example: :SOUR:POW:ALC:SEAR?

#### [[:SOURCE]:POWER:ALC:SOURCE INTERNAL | DIODE | PMETER

The command selects the detector for power control.

INTERNAL The internal detector is used.

DIODE A diode detector can be connected at the external ALC-input.

PMETER A power meter can be connected at the external ALC-input.

Example: :SOUR:POW:ALC:SOUR INT \*RST value is INT



**[[:SOURce]:POWer:ALC:SOURce:PMETer RS\_NRVs | HP436A**

The command indicates the type of power meter connected.

RS\_NRVs Rohde & Schwarz NRVD or NRVS (Id.-Nr. 857.8008.02 or 1020.1809.02).

HP436A Hewlett-Packard HP436A | HP437 | HP438A.

Example: :SOUR:POW:ALC:SOUR:PMET RS\_NRVs \*RST value is RS\_NRVs

**[[:SOURce]:POWer:ALC[:STATe] ON | OFF**

The command switches the level control on or off.

ON Level control is permanently switched on.

OFF Level control is switched on for a short period of time if the level changes.

Example: :SOUR:POW :ALC:STAT ON \*RST value is ON

**[[:SOURce]:POWer[:LEVel][:IMMediate]**

The commands to set the output levels for the CW- and SWEEP modes are under this node.

**[[:SOURce]:POWer[:LEVel][:IMMediate][:AMPLitude] -130 dBm to +25 dBm  
(without SMR-B15: -20 dBm to +25 dBm**

The command sets the RF output level in operating mode CW. UP and DOWN can be indicated in addition to numeric values. Then the level is increased or reduced by the value indicated under [ :SOUR ] : POW : STEP.

In this command, the OFFSet value is considered. Thus the specified range indicated is only valid for :SOUR:POW:OFFS 0.

The keywords of this command are optional to a large extent, thus the long as well as the short form of the command is shown in the example.

Example: :SOUR:POW:LEV:IMM:AMPL -15 or  
:POW -15 \*RST value is -30 dBm or -20 dBm

**[[:SOURce]:POWer[:LEVel][:IMMediate][:AMPLitude]:OFFSet -100 to +100 dB**

The command enters the constant level offset of a series-connected attenuator/ amplifier (cf. Chapter 4, Section "Level Offset"). If a level offset is entered, the level entered using :POW does no longer conform to the RF output level. The following relation is true:

$$:POW = \text{RF output level} + :POW:OFFS$$

Entering a level offset does not change the RF output level but only the value queried by :POW. The level offset is also valid for level sweep!

Only dB is permissible as a unit here, linear units (V, W etc.) are not permitted.

Example: :SOUR:POW:LEV:IMM:AMPL:OFFS 0 or  
:POW:OFFS 0 \*RST value is 0 dB

**[[:SOURce]:POWer:LIMit[:AMPLitude] -130 dBm to +25 dBm  
(without Option SMR-B15: -20 dBm to +25 dBm**

The command limits the maximum RF output level in operating mode CW and SWEEP. It does not influence the display LEVEL and the answer to query POW?.

Example: :SOUR:POW:LIM:AMPL -15 \*RST value is +16 dBm

**[[:SOURce]:POWer:MANual** -130 dBm to +25 dBm (without Option SMR-B15: -20 to +25 dBm)

The command sets the level if `SOUR:POW:MODE` is set to `:SWE` and `SOUR:SWE:MODE` to `MAN`. Only level values between `START` and `STOP` are permitted (as to specified range, cf. `:POW:AMPL`).

Example: `:SOUR:POW:MAN 1dBm` \*RST value is -30 dBm or -20 dBm

**[[:SOURce]:POWer:MODE** CW | FIXEd | SWEep | LIST

The command specifies the operating mode and thus also by means of which commands the level setting is checked.

**CW | FIXEd** The output level is specified by means of commands under `[ :SOUR ] :POW:LEV`.

**SWEep** The instrument operates in the `SWEep` mode. The level is specified by means of `[ :SOUR ] :POW:STAR; STOP; CENT; SPAN` and `MAN`.

**LIST** The instrument processes a list of frequency and level settings. The settings are effected in the `:SOUR:LIST` Subsystem.

Setting `:SOUR:POW:MODE LIST` automatically sets command `:SOUR:FREQ:MODE` to `LIST` as well.

Example: `:SOUR:POW:MODE FIX` \*RST value is `FIX`

**[[:SOURce]:POWer:START** -130 dBm to +25 dBm  
(without Option SMR-B15: -20 dBm to +25 dBm;)

The command sets the starting value for a level sweep. `START` may be larger than `STOP`, then the sweep runs from the high to the low level (As to specified range, cf. `:POW`).

Example: `:SOUR:POW:STAR -20` \*RST value is -30 dBm or -20 dBm

**[[:SOURce]:POWer:STOP** -130 dBm to +25 dBm (without Option SMR-B15: -20 to +25 dBm)

The command sets the final value for a level sweep. `STOP` may be smaller than `START`. (As to specified range, cf. `:POW`).

Example: `:SOUR:POW:STOP 3` \*RST value is -10dBm

**[[:SOURce]:POWer:STEP[:INCRement]** 0.1 to 10 dB

The command sets the step width with the level setting if `UP` and `DOWN` are used as level values. The command is coupled to Knob Step in the manual control, i.e., it also specifies the step width of the shaft encoder.

Only dB is permissible as a unit here, the linear units (V, W etc.) are not permitted.

Example: `:SOUR:POW:STEP:INCR 2` \*RST value is 1dB

**SOURce:PULM Subsystem**

This subsystem contains the commands to control the pulse modulation and to set the parameters of the modulation signal. The internal pulse generator (Option SMR-B14) is set in the :SOURce:PULSe subsystem.

Command	Parameters	Default Unit	Remark
[[:SOURce] :PULM :EXTernal :IMPedance :POLarity :SOURce :STATe	50 Ohm to 10 kOhm NORMal   INVerted INTernal   EXTernal ON   OFF	Ohm	Option SMR-B14  Option SMR-B14

**[[:SOURce]:PULM:EXTernal**

The commands to control the input socket for the external pulse generator are under this node.

**[[:SOURce]:PULM:EXTernal:IMPedance 50 Ohm to 10 kOhm**

The command sets the impedance of the input socket for the external pulse generator. The pulse generator has an own input socket, hence this setting is independent of the corresponding settings under FM.

Example: :SOUR:PULM:EXT:IMP 10E3 \*RST value is 10 kOhm

**[[:SOURce]:PULM:POLarity NORMal | INVerted**

The command specifies the polarity between modulating and modulated signal.

NORMal The RF signal is suppressed during the interpulse period.

INVerted The RF signal is suppressed during the pulse.

Example: :SOUR:PULM:POL INV \*RST value is NORM

**[[:SOURce]:PULM:SOURce EXTernal | INTernal**

The command selects the source of the modulating signal.

INTernal Internal pulse generator (Option SMR-B14).

EXTernal Signal fed externally.

Example: :SOUR:PULM:SOUR INT \*RST value is INT

**[[:SOURce]:PULM:STATe ON | OFF**

The command switches on or off the pulse modulation.

Example: :SOUR:PULM:STAT ON \*RST value is OFF



**SOURce:ROSCillator Subsystem**

This subsystem contains the commands to set the external and internal reference oscillator.

Command	Parameters	Default Unit	Remark
<b>[[:SOURce]                      :ROSCillator                      [:INTernal]                      :ADJust                      [:STATe]                      :VALue                      :SOURce</b>	ON   OFF -2048 to +2047 INTernal   EXTernal		

**[[:SOURce]:ROSCillator[:INTernal]**

The commands to set the internal reference oscillator are under this node.

**[[:SOURce]:ROSCillator[:INTernal]:ADJust**

The commands for frequency adjustment (fine-tuning of the frequency) are under this node.

**[[:SOURce]:ROSCillator[:INTernal]:ADJust[:STATe] ON | OFF**

The command switches the frequency adjustment on or off.

Example: :SOUR:ROSC:INT:ADJ:STAT ON

\*RST value is OFF

**[[:SOURce]:ROSCillator[:INTernal]:ADJust:VALue -2048 to +2047**

The command indicates the frequency correction value (tuning value). For a detailed definition, cf. Section "Reference Frequency Internal/External".

Example: :SOUR:ROSC:INT:ADJ:VAL 0

\*RST value is 0

**[[:SOURce]:ROSCillator:SOURce INTernal | EXTernal**

The command selects the reference source.

INTernal The internal oscillator is used.

EXTernal The reference signal is fed externally.

Example: :SOUR:ROSC:SOUR EXT

\*RST value is INT

## SOURce:SWEep Subsystem

This subsystem contains the commands to control the RF sweep, i.e., sweeps of the RF generators. Sweeps are triggered on principle. The frequency sweep is activated by command `SOUR:FREQ:MODE SWE`, the level sweep by command `SOUR:POW:MODE SWE`.

Command	Parameters	Default Unit	Remark
<code>[[:SOURce]</code> <code>:SWEep</code> <code>:BTIMe</code> <code>[[:FREQuency]</code> <code>:DWELI</code> <code>:MODE</code> <code>:SPACing</code> <code>:STEP</code> <code>[[:LINear]</code> <code>:LOGarithmic</code> <code>:POWER</code> <code>:DWELI</code> <code>:MODE</code> <code>:SPACing</code> <code>:STEP</code> <code>[[:LOGarithmic]</code>	NORMal   LONG  10 ms to 5 s AUTO   MANual   STEP LINear   LOGarithmic   RAMP  0 to 1 GHz 0.01 to 100 PCT  10 ms to 5 s AUTO   MANual   STEP LOGarithmic 0 to 160 dB MAXimum   MINimum	s     Hz PCT  s    dB	

### `[[:SOURce]:SWEep:BTIMe` NORMal | LONG

The command sets the blank time of the sweep. The setting is valid for all sweeps, i.e., also for LF sweeps.

NORMal Blank time as short as possible.

LONG Blank time long enough to permit an XY recorder to return to 0.

Example: `:SOUR:SWE:BTIM LONG`

\*RST value is NORM

### `[[:SOURce]:SWEep[:FREQuency]`

The commands to set the frequency sweeps are under this node. Keyword `[[:FREQuency]` can be omitted (cf. examples). The commands are SCPI compatible then unless stated otherwise.

### `[[:SOURce]:SWEep[:FREQuency]:DWELI` 10 ms to 5 s

The command sets the dwell time per frequency step.

Example: `:SOUR:SWE:DWEL 12ms`

\*RST value is 15 ms

**[[:SOURce]:SWEep[:FREQUency]:MODE AUTO | MANual | STEP**

The command specifies the run of the sweep.

**AUTO** Each trigger triggers exactly one entire sweep cycle.

**MANual** Each frequency step of the sweep is triggered by means of manual control or a SOUR:FREQ:MAN command, the trigger system is not active. The frequency increases or decreases (depending on the direction of the shaft encoder) by the value indicated under [[:SOUR]:FREQ:STEP:INCR.

**STEP** Each trigger triggers only one sweep step (single-step mode). The frequency increases by the value indicated under [[:SOUR]:SWE:STEP:LOG.

Example: :SOUR:SWE:MODE AUTO \*RST value is AUTO

**[[:SOURce]:SWEep[:FREQUency]:SPACing LINear | LOGarithmic | RAMP**

The command selects whether the steps have linear or logarithmic spacings.

Example: :SOUR:SWE:SPAC LIN \*RST value is LIN

**[[:SOURce]:SWEep[:FREQUency]:STEP**

The commands to set the step width for linear and logarithmic sweeps are under this node. The settings of :STEP:LIN and :STEP:LOG are independent of each other.

**[[:SOURce]:SWEep[:FREQUency]:STEP[:LINear] 0 to 10 GHz**

The command sets the step width with the linear sweep. If :STEP[:LIN] is changed, the value of POINTs valid for :SPAC:LIN also changes according to the formula stated under POINTs. A change of SPAN does not result in a change of :STEP[:LIN]. Keyword [[:LIN] can be omitted, then the command conforms to SCPI regulations (see example).

Example: :SOUR:SWE:STEP 1MHz \*RST value is 1 MHz

**[[:SOURce]:SWEep[:FREQUency]:STEP:LOGarithmic 0.01 to 100 PCT**

The command indicates the step width factor for logarithmic sweeps. The next frequency value of a sweep is calculated according to

new frequency = previous frequency + STEP:LOG x previous frequency (if START < STOP)

:STEP:LOG indicates the fraction of the previous frequency by which this is increased for the next sweep step. Usually :STEP:LOG is indicated in percent, with the suffix PCT having to be used explicitly. If :STEP:LOG is changed, the value of POINTs valid for :SPAC:LOG also changes according to the formula stated under POINTs. A change of START or STOP does not result in a change of :STEP:LOG.

Example: :SOUR:SWE:STEP:LOG 10PCT \*RST value is 1 PCT

**[[:SOURce]:SWEep:POWER**

The commands to set the power sweeps are under this node.

**[[:SOURce]:SWEep:POWER:DWELI 10 ms to 5 s**

The command sets the dwell time per level step.

Example: :SOUR:SWE:POW:DWEL 12ms \*RST value is 15 ms

**[[:SOURce]:SWEep:POWer:MODE AUTO | MANual | STEP**

The command specifies the sweep mode.

**AUTO** Each trigger triggers exactly one entire sweep cycle.

**MANual** Each level step of the sweep is triggered by means of manual control or a `SOUR:POW:MAN` command, the trigger system is not active. The level increases or decreases (depending on the direction of the shaft encoder) by the value stated under `[ :SOUR ] : POW : STEP : INCR`.

**STEP** Each trigger triggers only one sweep step (single-step mode). The level increases by the value indicated under `[ :SOUR ] : POW : STEP : INCR`.

Example: `:SOUR:SWE:POW:MODE AUTO` \*RST value is AUTO

**[[:SOURce]:SWEep:POWer:SPACing LOGarithmic**

The command defines that the sweep steps have logarithmic spacings. It permits the query of `SPACing`.

Example: `:SOUR:SWE:POW:SPAC LOG` \*RST value is LOGarithmic

**[[:SOURce]:SWEep:POWer:STEP**

The commands to set the step width for the sweep are under this node.

**[[:SOURce]:SWEep:POWer:STEP[:LOGarithmic] 0 to 160 dB**

The command indicates the step width factor for logarithmic sweeps. The next level value of a sweep is calculated according to

$\text{new level} = \text{previous level} + \text{STEP:LOG} \times \text{previous level}$

`STEP:LOG` denotes the fraction of the previous level by which this is increased for the next sweep step. Usually `:STEP:LOG` is entered in units of dB, with suffix dB having to be specified explicitly. If `:STEP:LOG` is changed, the value of `POINTs` also changes according to the formula indicated under `POINTs`. A change of `START` or `STOP` does not result in a change of `:STEP:LOG`. Keyword `:LOG` can be omitted, then the command conforms to SCPI regulation (see example).

Example: `:SOUR:SWE:STEP 10dB` \*RST value is 1dB



## SOURce2 System

The SOURce2 system contains the commands to configure the LF signal source (which is part of Option SMR-B5). The LF signal source is designated as INT if it is used as a modulation source, if it is used as an LF generator, it is designated as SOURce2.

The commands to set the output voltage of the LF generator are in the OUTPut2 system.

Subsystems	Settings
<b>:SOURce2</b> :FREQuency :FUNctIon :MARKer :SWEep	Frequency with CW and sweep operation Waveform of the output signal Marker for LF sweeps LF sweep

## SOURce2:FREQuency Subsystem

This subsystem contains the commands for the frequency settings including the sweeps.

Command	Parameters	Default Unit	Remark
<b>:SOURce2</b> :FREQuency [:CW :FIXed] :MANual :MODE :STARt :STOP	0.1 Hz to 10 MHz 0.1 Hz to 10 MHz CW   FIXed   SWEep 0.1 Hz to 10 MHz 0.1 Hz to 10 MHz	Hz Hz Hz Hz Hz	With Option SMR-B5

**:SOURce2:FREQuency[:CW | :FIXed]** 0.1 Hz to 10 MHz

The command sets the frequency for the CW mode.

Example: :SOUR2:FREQ: CW 1kHz

RST value is 1 kHz

**:SOURce2:FREQuency:MANual** 0.1 Hz to 10 MHz

The command sets the frequency if SOUR2:SWE:MODE MAN and SOUR2:FREQ:MODE SWE are set. In this case, only frequency values between the settings :SOUR2:FREQ:STAR and ...:STOP are allowed.

Example: :SOUR2:FREQ:MAN 1kHz

\*RST value is 1 kHz

**:SOURce2:FREQuency:MODE** CW | FIXed | SWEep

The command specifies the operating mode and hence by means of which commands the FREQuency subsystem is controled. The following allocations are valid:

**CW | FIXed** CW and FIXed are synonyms. The output frequency is specified by means of SOUR2:FREQ: CW | FIX.

**SWEep** The generator operates in the SWEep mode. The frequency is specified by means of commands :SOUR2:FREQ:STAR; STOP; MAN.

Example: :SOUR2:FREQ:MODE CW

\*RST value is CW

**:SOURce2:FREQuency:STARt** 0.1 Hz to 10 MHz

This command defines the starting value of the frequency for the sweep.

Example: :SOUR2:FREQ:STAR 100kHz

\*RST value is 1kHz

**:SOURce2:FREQuency:STOP** 0.1 Hz to 10 MHz

This command defines the end value of the frequency for the sweep.

Example: :SOUR2:FREQ:STOP 200kHz

\*RST value is 100 kHz

**SOURce2:FUNCTION Subsystem**

This subsystem contains the commands specifying the waveform of the output signal.

Command	Parameters	Default Unit	Remark
:SOURce2 :FUNCTION [:SHAPE]	SINusoid   SQUare		With Option SMR-B5

**:SOURce2:FUNCTION[:SHAPE]** SINusoid | SQUare

The command specifies the shape of the output signal.

SINusoid Sine

SQUare Square

\*RST value is SIN

Example: :SOUR2:FUNC:SHAP SQU

## SOURce2:MARKer Subsystem

This subsystem contains the commands to control the marker generation in the case of LF sweeps. The three markers existing are distinguished by a numeric suffix after marker.

Command	Parameters	Default Unit	Remark
<b>:SOURce2</b> <b>:MARKer1 2 3</b> <b>[:FSWeep]</b> <b>:AOFF</b> <b>:FREQuency</b> <b>[:STATe]</b> <b>:POLarity</b>	    0.1 Hz to 10 MHz ON   OFF NORMal   INVerted	    Hz	  With Option SMR-B5  No query

### :SOURce2:MARKer1|2|3[:FSWeep]

The commands for the markers with the LF frequency sweep (Frequency Sweep) are under this node. Keyword [:FSWeep] can also be omitted, then the command conforms to SCPI regulation (see examples).

### :SOURce2:MARKer1|2|3[:FSWeep]:AOFF

The command switches off all LF frequency markers. This command triggers an event, thus is has no \*RST value and no query form.

Example: :SOUR2:MARK:AOFF

### :SOURce2:MARKer1|2|3[:FSWeep]:FREQuency 0.1 Hz to 10 MHz

The command sets the marker selected by the numeric suffix at MARKer to the frequency defined.

\*RST value for MARK1: 100 kHz  
 MARK2: 10 kHz  
 MARK3: 1 kHz

Example: :SOUR2:MARK1:FREQ 9000

### :SOURce2:MARKer1|2|3[:FSWeep][:STATe] ON | OFF

The command switches on or off the marker selected by the numeric suffix at MARKer.

Example: :SOUR2:MARK1:STAT ON

\*RST value is OFF

### :SOURce2:MARKer1|2|3:POLarity NORMal | INVerted

The command specifies the polarity of the marker signal as follows:

**NORMal** When running through the marker condition, TTL level is applied at the marker output, otherwise 0 V.

**INVers** When running through the marker condition, 0 V is applied at the marker output, otherwise TTL level.

Example: :SOUR2:MARK1:POL INV

\*RST value is NORM

**SOURce2:SWEep Subsystem**

This subsystem contains the commands to control the LF sweep of SOURce2. LF-Sweeps are activated by command `SOUR2:MODE SWE`. Sweeps are triggered on principle.

Command	Parameters	Default Unit	Remark
<b>:SOURce2</b> <b>:SWEep</b> <b>:BTIMe</b> <b>[:FREQuency]</b> <b>:DWELI</b> <b>:MODE</b> <b>:SPACing</b> <b>:STEP</b> <b>[:LINear]</b> <b>:LOGarithmic</b>	NORMal   LONG  10 ms to 5 s AUTO   MANual   STEP LINear   LOGarithmic  0 to 10MHz 0.01 PCT to 100 PCT	s    Hz PCT	

**:SOURce2:SWEep:BTIMe** NORMal | LONG

The command sets the blank time (Blank Time) of the sweep. The setting is valid for all sweeps, i.e., also for RF sweeps.

NORMal Blank time as short as possible.

LONG Blank time long enough to permit an X/Y recorder to return to 0.

Example: `:SOUR2:SWE:BTIM LONG` \*RST value is NORM

**:SOURce2:SWEep[:FREQuency]**

The commands to set the frequency sweeps are under this node. Keyword `[:FREQuency]` can be omitted. Then the commands are SCPI-compatible unless stated otherwise (see examples).

**:SOURce2:SWEep[:FREQuency]:DWELI** 10 ms to 5 s

The command sets the time per frequency step (dwell).

Example: `:SOUR2:SWE:DWEL 20ms` \*RST value is 15 ms

**:SOURce2:SWEep[:FREQuency]:MODE** AUTO | MANual | STEP

The command specifies the run of the sweep.

AUTO Each trigger triggers exactly one entire sweep cycle.

STEP Each trigger triggers only one sweep step (single-step mode). The frequency increases by the value defined under `:SOUR2:SWE:STEP`.

Example: `:SOUR2:SWE:MODE AUTO` \*RST value is AUTO

**:SOURce2:SWEep[:FREQUENCY]:SPACing** LINear | LOGarithmic

The command selects whether the steps have linear or logarithmic spacings.

Example: :SOUR2:SWE:SPAC LOG

\*RST value is LIN

**:SOURce2:SWEep[:FREQUENCY]:STEP**

The commands to set the step width with linear and logarithmic sweeps are under this node. The settings of STEP:LIN and STEP:LOG are independent of each other.

**:SOURce2:SWEep[:FREQUENCY]:STEP[:LINear]** 0 to 10 MHz

The command sets the step width with the linear sweep. If STEP:LIN is changed, the value of POINTs valid for SPAC:LIN also changes according to the formula defined under POINTs. A change of SPAN does not cause a change of STEP:LIN. Keyword [:LIN] can be omitted, then the command conforms to SCPI regulation (see example).

Example: :SOUR2:SWE:STEP 10kHz

\*RST value is 1 kHz

**:SOURce2:SWEep[:FREQUENCY]:STEP:LOGarithmic** 0.01 to 100PCT

This command defines the step width factor for logarithmic sweeps. The next frequency value of a sweep is calculated as follows (if START < STOP) :

New frequency = previous frequency + STEP:LOG x previous frequency

STEP:LOG , therefore, indicates the fraction of the previous frequency by which that frequency is increased for the next sweep step. STEP:LOG is usually indicated in percent, with the suffix PCT having to be used explicitly. If STEP:LOG is changed, the value of POINTs valid for SPACing:LOGarithmic also changes according to the formula stated under POINTs. A change of START or STOP does not result in a change of STEP:LOGarithmic.

Example: :SOUR2:SWE:STEP:LOG 5PCT

\*RST value is 1 PCT

## STATus-System

This system contains the commands for the status reporting system (c.f. Section "Status Reporting System"). \*RST has no influence on the status registers.

Command	Parameters	Default Unit	Remark
<b>:STATus</b>			
<b>:OPERation</b>			
[:EVENT]?			Query only
:CONDition?			Query only
:PTRansition	0 to 32767		
:NTRansition	0 to 32767		
:ENABle	0 to 32767		
:PRESet			No query
:QUEStionable			
[:EVENT]?			Query only
:CONDition?			Query only
:PTRansition	0 to 32767		
:NTRansition	0 to 32767		
:ENABle	0 to 32767		
:QUEue			
[:NEXT]?			Query only

### :STATus:OPERation

The commands for the :STATus:OPERation register are under this node.

### :STATus:OPERation[:EVENT]?

The command queries the content of the EVENT part of the :STATus:OPERation register. In reading out, the content of the EVENT part is deleted.

Example: :STAT:OPER:EVEN?

Answer: 17

### :STATus:OPERation:CONDition?

The command queries the content of the CONDition part of the :STATus:OPERation register. In reading out, the content of the CONDition part is not deleted. The value returned directly reflects the current hardware state.

Example: :STAT:OPER:COND?

Answer: 1

### :STATus:OPERation:PTRansition 0 to 32767

The command (Positive Transition) sets the edge detectors of all bits of the :STATus:OPERation register from 0 to 1 for the transitions of the CONDition bits.

Example: :STAT:OPER:PTR 32767

### :STATus:OPERation:NTRansition 0 to 32767

The command (Negative Transition) sets the edge detectors of all bits of the :STATus:OPERation register from 1 to 0 for the transitions of the CONDition bit.

Example: :STAT:OPER:NTR 0

**:STATus:OPERation:ENABLE** 0 to 32767

The command sets the bits of the ENABLE register. This register selectively enables the individual events of the appropriate status event register for the sum bit in the status byte.

Example: :STAT:OPER:ENAB 1

**:STATus:PRESet**

The command resets the edge detectors and ENABLE parts of all registers to a defined value. All PTRansition parts are set to FFFFh, i.e., all transitions from 0 to 1 are detected. All NTRansition parts are set to 0, i.e., a transition from 1 to 0 in a CONDition bit is not detected. The ENABLE parts of STATus:OPERation and STATus:QUEStionable are set to 0, i.e., all events in these registers are not passed on.

Example: :STAT:PRES

**:STATus:QUEStionable**

The commands for the :STATus:QUEStionable register are under this node.

**:STATus:QUEStionable[:EVENT]?**

The command queries the content of the EVENT part of the :STATus:QUEStionable register. In reading out, the content of the EVENT part is deleted.

Example: :STAT:QUES:EVENT?

Answer: 1

**:STATus:QUEStionable:CONDition?**

The command queries the content of the CONDition part of the :STATus:QUEStionable register. In reading out, the content of the CONDition part is not deleted.

Example: :STAT:QUES:COND?

Answer: 2

**:STATus:QUEStionable:PTRansition** 0 to 32767

The command (Positive Transition) sets the edge detectors of all bits of the :STATus:QUEStionable register from 0 to 1 for transitions of the CONDition bit.

Example: :STAT:QUES:PTR 32767

**:STATus:QUEStionable:NTRansition** 0 to 32767

The command (Negative Transition) sets the edge detectors of all bits of the :STATus:QUEStionable register from 1 to 0 for transitions of the CONDition bit.

Example: :STAT:QUES:NTR 0

**:STATus:QUEStionable:ENABLE** 0 to 32767

The command sets the bits of the ENABLE part of the :STATus:QUEStionable register. This part selectively enables the individual events of the appropriate EVENT part for the sum bit in the status byte.

Example: :STAT:QUES:ENAB 1

**:STATus:QUEue [:NEXT]?**

The command queries the entry that has been in the error queue for the longest time and thus deletes it. Positive error numbers denote errors specific of the instrument, negative error numbers error messages specified by SCPI (see Chapter 5). If the error queue is empty, 0, "No error", is returned. The command is identical to SYST:ERR?

Example: STAT:QUE:NEXT?

Answer: 221, "Settings conflict"





**:SYSTEM:COMMunicate:GPIB[:SELF]:ADDRESS** 1 to 30

The command sets the IEC bus instrument address.

\*RST value is 28

Example: :SYST:COMM:GPIB:ADDR 1

**:SYSTEM:COMMunicate:SERial**

The command to set the serial interface are under this node. The data format is fixedly set to 8 data bits, no parity and 1 stop bit. These values cannot be changed. The device represents a DTE (Data Terminal Equipment) in relation to the serial interface. Therefore the the controller must be connected via a 0-modem.

**:SYSTEM:COMMunicate:SERial:BAUD** 1200| 2400| 4800| 9600| 19200| 38400| 57600| 115200

The commands sets the baud rate for both the transmit and the receive direction. \*RST has no influence on this parameter.

Example: :SYST:COMM:SER:BAUD 1200

\*RST value is 9600

**:SYSTEM:COMMunicate:SERial:BITS** 7 | 8

The command sets the length of a data word.

Example: :SYST:COMM:SER:BITS

\*RSTvalue is 7

**:SYSTEM:COMMunicate:SERial:SBITs** 1 | 2

The command defines whether 1 or 2 stop bits are used.

Example: :SYST:COMM:SER:SBIT

\*RST value is 1

**:SYSTEM:COMMunicate:SERial:CONTRol:RTS** ON | IBFull | RFR

The commands sets the hardware handshake. \*RST has no influence on this parameter.

ON Interface line RTS is always active.

IBFull | RFR Input Buffer Full | Ready For Receiving.

Interface line RTS remains active as long as the instrument is ready to receive data.

Example: :SYST:COMM:SER:CONT:RTS ON

\*RST value is RFR

**:SYSTEM:COMMunicate:SERial:PACE** XON | NONE

The command sets the software handshake. \*RST has no influence on this parameter.

XON Software handshake using the ASCII codes 11h (XON) and 13h (XOFF).

**Note:** This mode is not recommended for binary data and for baud rates above 9600 bauds.

NONE No software handshake.

Example: :SYST:COMM:SER:PACE NONE

\*RST value is NONE



**:SYSTEM:MSEquence:DWELI** 50 ms to 60 s {,50 ms to 60 s}

For the memory sequence which has currently been selected, the command transmits a list indicating the time for which an instrument setting is "held" in each case before the instrument proceeds to the next setting. If DWELI indicates only one parameter, every item of the instrument state list is set for the same, indicated time. Lists are not influenced by \*RST.

Example: :SYST:MSEQ:DWEL 1s

**:SYSTEM:MSEquence:FREE?**

The command queries the space available for memory sequences. It returns two values. The first value indicates the space still vacant, the second the space already occupied.

Example: :SYST:MSEQ:FREE? Answer: 20, 236

**:SYSTEM:MSEquence:MODE** AUTO | STEP

The command defines in which way the memory sequence is to be processed (by analogy with :SOUR:SWE:MODE).

AUTO Each trigger event triggers a complete cycle of the memory sequence selected.

STEP Each trigger event only triggers one step in processing the memory sequence.

Example: :SYST:MSEQ:MODE AUTO \*RST value is AUTO

**:SYSTEM:MSEquence[:RCL]** 1 to 50 {,1 to 50}

The command transmits the list of the instrument states to be assumed successively. The list contains integers denoting the states stored by means of \*SAV. These instrument states are set successively using a simulated \*RCL (thus the name of the list). The length of the list is not limited. The values of the list are between 1 and 50 (number of memory locations to be called). Lists are not influenced by \*RST.

Example: :SYST:MSEQ:RCL 30, 31, 32 ,32 ,32 , 33

**:SYSTEM:MSEquence[:RCL]:POINTs?**

The command queries the length of the RCL list selected. The RCL list is user-defined and of variable length. The maximal length of the list can be queried by means of :SYST:MSEQ:FREE? (addition of the two values).

Example: :SYST:MSEQ:RCL:POIN? Answer: 17

**:SYSTEM:MSEquence:SElect** "Sequence name"

The command selects a memory sequence. The name of the sequence may be an arbitrary character string of up to 7 letters. If there is no memory sequence of the name indicated, the command creates it, i.e., this command can be used to generate new lists.

Example: :SYST:MSEQ:SEL "SEQA"

**:SYSTem:PRESet**

The command triggers an instrument reset. It has the same effect as the PRESET key of the manual control or as command \*RST. This command triggers an event and hence has no \*RST value.

Example:     :SYST:PRES

**:SYSTem:PROTect[1|2|3]**

The commands to disable certain instrument functions are under this node. A list of the functions concerned can be found in the manual control (Chapter 4, Section "Password Input With Protected Functions"). There are three protection levels which are distinguished by means of a suffix after PROT. \*RST has no effects on the disabling/enabling of the instrument functions.

**:SYSTem:PROTect[1|2|3][:STATe] ON | OFF, Password**

The command switches a protection level on or off. The passwords are 6-digit numbers. They are fixedly stored in the firmware. The password for the first level is 123456.

ON            disables the functions belonging to this protection level. A password doesn't have to be entered.

OFF           deactivates the disabling again if the correct password is entered. Otherwise an error -224, "Illegal parameter value" is generated and STATe remains ON.

Example:     :SYST:PROT1:STAT OFF, 123456

**:SYSTem:SECurity[:STATe] ON | OFF**

The command switches the security state on or off.

ON            The following commands cannot be executed:  
               :DISP:ANN:ALL ON  
               :DISP:ANN:FREQ ON  
               :DISP:ANN:AMPL ON

OFF           In the transition from ON to OFF all data existing in the instrument except for the calibrating data are deleted, especially all status registers, all instrument states and all lists.

The command is not influenced by \*RST and \*RCL.

Example:     :SYST:SEC:STAT ON

**:SYSTem:SERRor?**

This command returns a list of all errors existing at the point of time of the query. This list corresponds to the indication on the ERROR page with manual control (cf. Chapter 9, Section "Error Messages").

Example:     :SYST:SERR?

Answer:     -221, "Settings conflict", 153, "Input voltage out of range"

**:SYSTem:VERSion?**

The command returns the SCPI version number the instrument acts in accordance with. This command is a query and thus has no \*RST value.

Example:     :SYST:VERS?

Answer: 1994.0

## TEST System

This system contains the commands to execute the selftest routines (RAM?, ROM? and BATT?) as well as to directly manipulate the hardware modules (:TEST:DIR). The selftests return a "0" if the test has been executed successfully, otherwise a value unequal to "0". All commands of this system do not have an \*RST value.

**Caution:** *The commands under node :TEST:DIR directly act on the respective hardware module circumventing any security mechanisms. They are provided for service purposes and should not be used by the user. Improper use of the commands may damage the module.*

Command	Parameters	Default Unit	Remark
:TEST			
:DIRect	Address, subaddress, hex data string		
:ASSy	Module, subaddress, hex data string		
:RAM?			Query only
:ROM?			Query only
:BATTery?			Query only

**:TEST:DIRect** Address, subaddress, hex data string

This node contains the commands directly acting on the respective hardware module circumventing any security mechanisms. The commands under this node have no short form.

**:TEST:ASSy** Module, subaddress, hex data string

This command addresses the ASSy module. A subaddress (0 or 1) must be entered as a parameter. The data are entered as a <string> (ie an ASCII character string enclosed in inverted commas) representing hexadecimal numbers. The string, therefore, may contain the characters 0 to 9 A to F.

**:TEST:RAM?**

The command triggers a test of the RAM.

**:TEST:ROM?**

The command triggers a test of the main memory (EEPROM).

**:TEST:BATTery?**

The command triggers a test of the battery voltage.

## TRIGger System

The TRIGger system contains the commands to select the trigger source and to configure the external trigger socket. The trigger sources for the individual signal sources (RF, LFGGen) are distinguished by a numerical suffix appended to TRIG. The suffix conforms to the numbering of the SOURce system:

TRIGger1 = RF generator

TRIGger2 = LFGGen

The trigger system of the SMR consists of a simplified implementation of the SCPI trigger system. Compared to SCPI, the TRIG system shows the following differences:

- No INIT command, the instrument behaves as if :INIT:CONT ON was set.
- There are several subsystems denoting the different parts of the instrument under TRIGg (SWE, LIST, PULS, MSEQ).

Further commands as to the trigger system of the SMR can be found in the ABORt system.

Command	Parameters	Default Unit	Remark
<b>:TRIGger1 2</b>			
<b>[:SWEep]</b>			
<b>[:IMMEDIATE]</b>			No query
<b>:SOURce</b>	SINGle   EXTernal   AUTO		
<b>:LIST</b>			
<b>[:IMMEDIATE]</b>			No query
<b>:SOURce</b>	SINGle   EXTernal   AUTO		
<b>:MSEquence</b>			
<b>[:IMMEDIATE]</b>			No query
<b>:SOURce</b>	SINGle   EXTernal   AUTO		
<b>:PULSe</b>			
<b>:SOURce</b>	AUTO_trig   EXT_trig   EXT_GATED		
<b>:SLOPe</b>	POSitive   NEGative		
<b>:SLOPe</b>	POSitive   NEGative   EITHer		

### **:TRIGger1|2[:SWEep]**

All commands to trigger a sweep are under this node. The settings here act on level and frequency sweeps for RF generator (TRIG1) or LF generator (TRIG2).

### **:TRIGger1|2[:SWEep][:IMMEDIATE]**

The command immediately starts a sweep. Which sweep is executed depends on the respective Mode setting, e.g. :SOUR:FREQ:MODE SWE. The command corresponds to manual-control command Execute Single Sweep. This command triggers an event and thus has no \*RST value.

Example:   :TRIG:SWE:IMM

**:TRIGger1[2]:SWEep]:SOURce** AUTO | SINGle | EXTernal

The command specifies the trigger source. The naming of the parameters directly corresponds to the different settings with manual control. SCPI uses other designations for the parameters the instrument accepts as well. These designations are to be preferred if compatibility is important. The following table provides an overview.

SMR designation	SCPI designation	Command with manual control
AUTO	IMMediate	Mode Auto
SINGle	BUS	Mode Single or Step
EXTernal	EXTernal	Mode Ext Trig Single or Ext Trig Step

**AUTO** The trigger is free-running, i.e., the trigger requirement is permanently met. As soon as a sweep has been terminated, the next one is started.

**SINGle** Triggering is effected by means of IEC-bus commands :TRIG:SWE:IMM or \*TRG. If :SOUR:SWE:MODE is set to STEP, a step, in the case of the AUTO setting a complete sweep, is executed.

**EXTernal** Triggering is effected from outside via the EXT TRIG socket or by the GET command via IEC/IEEE-bus. The action triggered depends on the setting of the sweep mode as in the case of SINGle.

Example: :TRIG:SWE:SOUR AUTO \*RST value is SING

**:TRIGger:LIST**

This node contains all commands to trigger a list in the List mode.

The commands are only valid for TRIG1.

**:TRIGger:LIST[:IMMediate]**

The command immediately starts the processing of a list of the List mode. It corresponds to command Execute Single Mode of the List menu. This command is an event and thus has no \*RST value.

Example: :TRIG:LIST:IMM



**:TRIGger:LIST:SOURce** AUTO | SINGle | EXTernal

The command specifies the trigger source. The naming of the parameters corresponds to the one with sweep mode. SCPI uses other designations for the parameters the instrument accepts as well. These designations are to be preferred if compatibility is important. The following table provides an overview:

SMR designation	SCPI designation	Command with manual control
AUTO	IMMediate	Mode Auto
SINGle	BUS	Mode Single or Step
EXTernal	EXTernal	Mode Ext Trig Single or Ext Trig Step

**AUTO** The trigger is free-running, i.e., the trigger condition is permanently fulfilled. As soon as the list selected has been finished in the LIST mode, it is started anew.

**SINGle** Triggering is executed by means of IEC-bus command `:TRIG:LIST:IMM`. The list is executed once.

**EXTernal** Triggering is carried out from outside via the EXT TRIG socket or by the GET command via IEC/IEEE-bus. The list is executed once.

Example: `:TRIG:LIS:SOUR AUTO` \*RST value is SING

**:TRIGger:MSEQuence**

This node contains all commands to trigger a memory sequence. The commands are only valid for TRIG1.

**:TRIGger:MSEQuence[:IMMediate]**

The command immediately starts a memory sequence . It corresponds to the Execute Single Mode command of the Memory Sequence menu. This command is an event and thus has no \*RST value.

Example: `:TRIG:MSEQ:IMM`

**:TRIGger:MSEQuence:SOURce** SINGle | EXTernal | AUTO

The command specifies the trigger source (cf. `:TRIG:SWE:SOUR`)

Example: `:TRIG:MSEQ:SOUR AUTO` \*RST value is SING

**:TRIGger:PULSe**

This node contains all commands to trigger the pulse generator (Option SMR-B14). The commands are only valid for TRIG1.

**:TRIGger:PULSe:SOURce** AUTO\_trig | EXT\_trig | EXT\_Gated

The command specifies the trigger source.

AUTO\_trig           Trigger is free-running (see above).

EXT\_trig            Triggering is effected from outside via the PULSE socket.

EXT\_Gated           Triggering is effected when the gate signal is active.

Example:    :TRIG:PULS:SOUR AUTO

\*RST value is AUTO

**:TRIGger:PULSe:SLOPe** POSitive | NEGative

The command defines whether the action triggered is triggered at the positive or the negative edge of the trigger signal.

Example:    :TRIG:PULS:SLOP NEG

\*RST value is POS

**:TRIGger:SLOPe** POSitive | NEGative | EITHer

The command defines whether the external trigger input responds to the positive, the negative or to both edges of the trigger signal. The command acts on :TRIG1|2:SWE, :TRIG:LIST and TRIG:MSEQ. The pulse generator has an own trigger input and thus also an own SLOPe command.

Example:    :TRIG:SLOP NEG

\*RST value is POS

## List of Commands

Command	Parameter	SCPI info	Page
:ABORt[:SWEep]		not SCPI	6.6
:ABORt:LIST		not SCPI	6.6
:ABORt:MSEquence		not SCPI	6.6
:DIAGnostic:INFO:CCOunt:ATTenuator1 2 3 4?		not SCPI	6.7
:DIAGnostic:INFO:CCOunt:POWer?		not SCPI	6.7
:DIAGnostic:INFO:MODules?		not SCPI	6.8
:DIAGnostic:INFO: OTIme?		not SCPI	6.8
:DIAGnostic:INFO: SDATe?		not SCPI	6.8
:DIAGnostic[:MEASure]:POINt?		not SCPI	6.8
:DISPlay:ANNotation[:ALL]	ON   OFF		6.9
:DISPlay:ANNotation:AMPLitude	ON   OFF		6.9
:DISPlay:ANNotation:FREQuency	ON   OFF		6.9
:INPut:IF:STATe	ON   OFF		6.10
:MEMory:NSTates?			6.10
:OUTPut1 2 3:AMODe	AUTO   FIXed	not SCPI	6.11
:OUTPut1:ATTenuation	0 to 110 dB	not SCPI	6.11
:OUTPut1 2 3:IMPedance?			6.11
:OUTPut3:POLarity:PULSe	NORMal   INVerse		6.12
:OUTPut1 2 3:SCALe	0.5   1		6.12
:OUTPut3:SOURce	OFF   PULSegen   VIDeo		6.12
:OUTPut1 2 3[:STATe]	ON   OFF		6.12
:OUTPut1 2 3[:STATe]:PON	OFF   UNCHanged	not SCPI	6.12
:OUTPut1 2 3VOLTage	0 V to 4 V	not SCPI	6.12
[:SOURce]:AM[:DEPTH]	0 to 100 PCT		6.13
[:SOURce]:AM:EXTernal1 2:COUPling	AC   DC		6.14
[:SOURce]:AM:EXTernal1 2:IMPedance	600 Ohm   100 kOhm		6.14
[:SOURce]:AM:INTernal:FREQuency	0,1 Hz to 10 MHz		6.14
[:SOURce]:AM:SOURce	INTernal   EXT2		6.14
[:SOURce]:AM:SCAN:SENSitivity	-0,1 to 10 dB/V		6.14
[:SOURce]:AM:SCAN[:STATe]	OFF   ON		6.14
[:SOURce]:AM:STATe	OFF   ON		6.14
[:SOURce]:CORRection[:STATe]	ON   OFF		6.15
[:SOURce]:CORRection:CSET:CATalog?		not SCPI	6.15
[:SOURce]:CORRection:CSET:FREE?		not SCPI	6.15
[:SOURce]:CORRection:CSET[:SElect]	'Name of table'		6.16
[:SOURce]:CORRection:CSET:DATA:FREQuency	1 GHz to $F_{max}$ {,1 GHz to $F_{max}$ }(with Option SMR B11 above 10 MHz)	not SCPI	6.16
[:SOURce]:CORRection:CSET:DATA:POWer	+20 to -20dB {,+20 to -20dB }	not SCPI	6.16
[:SOURce]:CORRection:CSET:DATA:POWer:POINts?		not SCPI	6.16
[:SOURce]:CORRection:CSET:DELeTe	'Name of table'	not SCPI	6.16
[:SOURce]:DM:TYPE	ASK   FSK	not SCPI	6.17
[:SOURce]:DM:STATe	ON   OFF	not SCPI	6.17
[:SOURce]:DM:EXTernal:IMPedance	600 Ohm   100 kOhm	not SCPI	6.17

Command	Parameter	SCPI info	Page
[[:SOURce]:DM:ASK:DEPT]h	0 to 100 PCT	not SCPI	6.18
[[:SOURce]:DM:ASK:POLarity	NORMal   INVerted	not SCPI	6.18
[[:SOURce]:DM:FSK:DEViation	0 kHz to 20/40 MHz	not SCPI	6.18
[[:SOURce]:DM:FSK:POLarity	NORMal   INVerted	not SCPI	6.18
[[:SOURce]:DM:FM[:DEViation]	0 kHz to 20/40 MHz	not SCPI	6.19
[[:SOURce]:FM:EXTernal1 2:COUPling	AC   DC		6.19
[[:SOURce]:FM:EXTernal1 2:IMPedance	600 Ohm   100 kOhm		6.19
[[:SOURce]:FM:INTernal:FREQuency	0,1 Hz to 10 MHz		6.20
[[:SOURce]:FM:SOURce	INTernal   EXTernal1		6.20
[[:SOURce]:FM:STATe	ON   OFF		6.20
[[:SOURce]:FREQuency:CENTer	1 GHz to $F_{max}$ (with Option SMR-B11: 10 MHz to $F_{max}$ )		6.21
[[:SOURce]:FREQuency[:CW   :FIXed]	1 GHz to $F_{max}$ (with Option SMR-B11: 10 MHz to $F_{max}$ )		6.21
[[:SOURce]:FREQuency:RCL	INCLude   EXCLude		6.22
[[:SOURce]:FREQuency:MANual	1 GHz to $F_{max}$ (with Option SMR-B11: 10 MHz to $F_{max}$ )		6.22
[[:SOURce]:FREQuency:MODE	CW   FIXed   SWEep   LIST		6.22
[[:SOURce]:FREQuency:MULTiplier	-1.0 to 10.0		6.22
[[:SOURce]:FREQuency:OFFSet	-50 to +50 GHz		6.22
[[:SOURce]:FREQuency:SPAN	$F_{max} - 1$ GHz (with Option SMR-B11: $F_{max} - 10$ MHz)		6.22
[[:SOURce]:FREQuency:STARt	1 GHz to $F_{max}$ (with Option SMR-B11: 10 MHz to $F_{max}$ )		6.23
[[:SOURce]:FREQuency:STOP	1 GHz to $F_{max}$ (with Option SMR-B11: 10 MHz to $F_{max}$ )		6.23
[[:SOURce]:FREQuency:STEP[:INCRement]	0 to 10 GHz		6.23
[[:SOURce]:LIST:CATalog?		not SCPI	6.24
[[:SOURce]:LIST:DELete	'List name'	not SCPI	6.24
[[:SOURce]:LIST:DELete:ALL		not SCPI	6.24
[[:SOURce]:LIST:DWELI	1 ms to 1 s		6.25
[[:SOURce]:LIST:DWELI:POINts?			6.25
[[:SOURce]:LIST:FREe?		not SCPI	6.25
[[:SOURce]:LIST:FREQuency	1 GHz to $F_{max}$ {, 1 GHz to $F_{max}$ } Bloc data (Option SMR-B11: above 10 MHz)		6.25
[[:SOURce]:LIST:FREQuency:POINts?			6.25
[[:SOURce]:LIST:MODE	AUTO   STEP	not SCPI	6.26
[[:SOURce]:LIST:POWer	-130 to +25 dBm {, -130 to +25 dBm }   Bloc data (-20 to +25dBm w/o SMR-B15)		6.26
[[:SOURce]:LIST:POWer:POINts?			6.26
[[:SOURce]:LIST:SELect	'List name'	not SCPI	6.26
[[:SOURce]:MARKer1 2 3 4 5 6 7 8 9 10[:FSWeep]:AMPLitude	ON   OFF		6.27
[[:SOURce]:MARKer1 2 3 4 5 6 7 8 9 10[:FSWeep]:AOFF			6.27
[[:SOURce]:MARKer1 2 3 4 5 6 7 8 9 10[:FSWeep]:FREQuency	1 GHz to $F_{max}$ (with Option SMR-B11: 10 MHz to $F_{max}$ )		6.28
[[:SOURce]:MARKer1 2 3 4 5 6 7 8 9 10[:FSWeep][:STATe]	ON   OFF		6.28
[[:SOURce]:MARKer1 2 3 4 5 6 7 8 9 10:PSWeep:AOFF		not SCPI	6.28
[[:SOURce]:MARKer1 2 3 4 5 6 7 8 9 10:PSWeep:POWer	-130 dBm to +25 dBm (w/o Option SMR-B15: -20 dBm to +25 dBm)	not SCPI	6.27
[[:SOURce]:MARKer1 2 3 4 5 6 7 8 9 10:PSWeep[:STATe]	ON   OFF	not SCPI	6.28

Command	Parameter	SCPI info	Page
[[:SOURce]:POWer:ALC:REFerence]	0 to 3 V		6.29
[[:SOURce]:POWer:ALC:SEARch?]			6.29
[[:SOURce]:POWer:ALC:SOURce]	INTernal   DIODE   PMETer		6.29
[[:SOURce]:POWer:ALC:SOURce:PMETer]	RS_NRVs   HP436A   HP437   HP438A		6.30
[[:SOURce]:POWer:ALC[:STATe]]	ON   OFF		6.30
[[:SOURce]:POWer[:LEVel][:IMMediate][:AMPLitude]]	-130 dBm to +25 dBm (w/o Option SMR-B15: -20 dBm to +25 dBm)		6.30
[[:SOURce]:POWer[:LEVel][:IMMediate][:AMPL]:OFFSet]	-100 to +100 dB		6.30
[[:SOURce]:POWer:LIMit[:AMPLitude]]	-130 dBm to +25 dBm (w/o Option SMR-B15: -20 dBm to +25 dBm)		6.31
[[:SOURce]:POWer:MANual]	-130 dBm to +25 dBm (w/o Option SMR-B15: -20 dBm to +25 dBm)		6.31
[[:SOURce]:POWer:MODE]	CW   FIXed   SWEep   LIST		6.31
[[:SOURce]:POWer:STARt]	-130 dBm to +25 dBm (w/o Option SMR-B15: -20 dBm to +25 dBm)		6.31
[[:SOURce]:POWer:STOP]	-130 dBm to +25 dBm (w/o Option SMR-B15: -20 dBm...+25 dBm)		6.31
[[:SOURce]:POWer:STEP[:INCRement]]	0.1 to 10 dB		6.31
[[:SOURce]:PULM:EXTernal:IMPedance]	50 Ohm to 10 kOhm		6.32
[[:SOURce]:PULM:POLarity]	NORMal   INVERTed		6.32
[[:SOURce]:PULM:SOURce]	EXTernal   INTernal		6.32
[[:SOURce]:PULM:STATe]	ON   OFF		6.32
[[:SOURce]:PULSe:DELay]	20 ns to 1.3 s		6.33
[[:SOURce]:PULSe:DOUBle:DELay]	60 ns to 1.3 s		6.33
[[:SOURce]:PULSe:DOUBle[:STATe]]	ON   OFF		6.33
[[:SOURce]:PULSe:PERiod]	100 ns to 85 s		6.33
[[:SOURce]:PULSe:WIDTh]	20 ns to 1.3 s		6.33
[[:SOURce]:ROSCillator[:INTernal]:ADJusT[:STATe]]	ON   OFF	not SCPI	6.34
[[:SOURce]:ROSCillator[:INTernal]:ADJusT:VALue]	-2048 to +2047	not SCPI	6.34
[[:SOURce]:ROSCillator:SOURce]	INTernal   EXTernal		6.34
[[:SOURce]:SWEep:BTIME]	NORMal   LONG	not SCPI	6.35
[[:SOURce]:SWEep[:FREQuency]:DWELl]	10 ms to 5s	not SCPI	6.35
[[:SOURce]:SWEep[:FREQuency]:MODE]	AUTO   MANual   STEP	not SCPI	6.36
[[:SOURce]:SWEep[:FREQuency]:SPACing]	LINEar   LOGarithmic	not SCPI	6.36
[[:SOURce]:SWEep[:FREQuency]:STEP[:LINEar]]	0 to 10 GHz	not SCPI	6.36
[[:SOURce]:SWEep[:FREQuency]:STEP:LOGarithmic]	0.01 to 10PCT	not SCPI	6.36
[[:SOURce]:SWEep:POWer:DWELl]	10 ms to 5 s	not SCPI	6.36
[[:SOURce]:SWEep:POWer:MODE]	AUTO   MANual   STEP	not SCPI	6.37
[[:SOURce]:SWEep:POWer:SPACing]	LOGarithmic	not SCPI	6.37
[[:SOURce]:SWEep:POWer:STEP[:LOGarithmic]]	0 to 160 dB	not SCPI	6.37
:SOURce2:FREQuency[:CW   :FIXed]	0.1 Hz to 10 MHz		6.39
:SOURce2:FREQuency:MANual	0.1 Hz to 10 MHz		6.39
:SOURce2:FREQuency:MODE	CW   FIXed   SWEep		6.39
:SOURce2:FREQuency:STARt	0.1 Hz to 10 MHz		6.39
:SOURce2:FREQuency:STOP	0.1 Hz to 10 MHz		6.39
:SOURce2:FUNCTion[:SHAPE]	SINusoid   SQUARE		6.40
:SOURce2:MARKer1 2 3[:FSWEEP]:AOFF			6.41

Command	Parameter	SCPI info	Page
:SOURce2:MARKer1 2 3[:FSWeep]:FREQUency	0.1 Hz to 10 MHz		6.41
:SOURce2:MARKer 1 2 3[:FSWeep][:STATe]	ON   OFF		6.41
:SOURce2:MARKer 1 2 3:POLarity	NORMal   INVerted	not SCPI	6.41
:SOURce2:SWEEp:BTIME	NORMal   LONG	not SCPI	6.42
:SOURce2:SWEEp[:FREQUency]:DWELI	10 ms to 5 s	not SCPI	6.42
:SOURce2:SWEEp[:FREQUency]:MODE	AUTO   MANual   STEP	not SCPI	6.42
:SOURce2:SWEEp[:FREQUency]:SPACing	LINear   LOGarithmic	not SCPI	6.43
:SOURce2:SWEEp[:FREQUency]:STEP[:LINear]	0 to 10 MHz	not SCPI	6.43
:SOURce2:SWEEp[:FREQUency]:STEP:LOGarithmic	0.01 to 100PCT	not SCPI	6.43
:STATus:OPERation[:EVENT]?			6.44
:STATus:OPERation:CONDition?			6.44
:STATus:OPERation:PTRansition	0 to 32767		6.44
:STATus:OPERation:NTRansition	0 to 32767		6.44
:STATus:OPERation:ENABLE	0 to 32767		6.45
:STATus:PRESet			6.45
:STATus:QUEStionable[:EVENT]?			6.45
:STATus:QUEStionable:CONDition?			6.45
:STATus:QUEStionable:PTRansition	0 to 32767		6.45
:STATus:QUEStionable:NTRansition	0 to 32767		6.45
:STATus:QUEStionable:ENABLE	0 to 32767		6.45
:STATus:QUEue [:NEXT]?			6.45
:SYSTem:COMMunicate:GPIB[:SELf]:ADDRess	1 to 30		6.47
:SYSTem:COMMunicate:SERial:BAUD	1200   2400   4800   9600   19200   38400   57600   115200		6.47
:SYSTem:COMMunicate:SERial:BITS	7   8		6.47
:SYSTem:COMMunicate:SERial:SBITs	1   2		6.47
:SYSTem:COMMunicate:SERial:CONTRol:RTS	ON   IBFull   RFR		6.47
:SYSTem:COMMunicate:SERial:PACe	XON   NONE		6.47
:SYSTem:COMMunicate:SERial:PARity	ODD   EVEN   NONE		6.48
:SYSTem:ERRor?			6.48
:SYSTem:MODE	FIXed   MSEQence	not SCPI	6.48
:SYSTem:MSEQence:CATalog?		not SCPI	6.48
:SYSTem:MSEQence:DELete	'Sequence name'	not SCPI	6.48
:SYSTem:MSEQence:DELete:ALL		not SCPI	6.48
:SYSTem:MSEQence:DWELI	50 ms to 60 s{,50 ms to.60 s}	not SCPI	6.49
:SYSTem:MSEQence:FREE?		not SCPI	6.49
:SYSTem:MSEQence:MODE	AUTO   STEP	not SCPI	6.49
:SYSTem:MSEQence[:RCL]	1 to 50 {,1 to 50}	not SCPI	6.49
:SYSTem:MSEQence[:RCL]:POINTs?		not SCPI	6.49
:SYSTem:MSEQence:SELect	'Sequence name'	not SCPI	6.49
:SYSTem:PRESet			6.50
:SYSTem:PROTect{1 2 3[:STATe]	ON   OFF, Password	not SCPI	6.50
:SYSTem:SECurity[:STATe]	ON   OFF		6.50
:SYSTem:SERror?		not SCPI	6.50
:SYSTem:VERsion?			6.50
:TEST:DIRect	Address, Subaddress, Hex. string		6.51

Command	Parameter	SCPI info	Page
:TEST:ASSy	Module, Subaddress, Hex. string		6.51
:TEST:RAM?			6.51
:TEST:ROM?			6.51
:TEST:BATTery?			6.51
:TRIGger1 2[:SWEep][:IMMediate]		not SCPI	6.52
:TRIGger1 2[:SWEep]:SOURce	AUTO   SINGle   EXTernal	not SCPI	6.53
:TRIGger:LIST[:IMMediate]		not SCPI	6.53
:TRIGger:LIST:SOURce	AUTO   SINGle   EXTernal	not SCPI	6.54
:TRIGger:MSEquence[:IMMediate]		not SCPI	6.54
:TRIGger:MSEquence:SOURce	SINGle   EXTernal   AUTO	not SCPI	6.54
:TRIGger:PULSe:SOURce	AUTO_trig   EXT_trig   EXT_GATED	not SCPI	6.55
:TRIGger:PULSe:SLOPe	POSitive   NEGative	not SCPI	6.55
:TRIGger:SLOPe	POSitive   NEGative   EITHer	not SCPI	6.55

## 7 Remote Control - Programming Examples

The examples explain the programming of the instrument and can serve as a basis to solve more complex programming tasks.

QuickBASIC has been used as programming language. However, the programs can be translated into other languages.

### Including IEC-Bus Library for QuickBasic

```
REM ----- Include IEC-bus library for quickbasic -----
'$INCLUDE: 'c:\qbasic\qbdecl4.bas'
```

### Initialization and Default Status

The IEC bus as well as the settings of the instrument are brought into a defined default status at the beginning of every program. Subroutines "InitController" and "InitDevice" are used to this effect.

#### Initiate Controller

```
REM ----- Initiate Instrument -----
REM InitController
ieaddress% = 28                'IEC-bus address of the instrument
CALL IBFIND("DEV1", generator%) 'Open port to the instrument
CALL IBPAD(generator%, ieaddress%) 'Inform controller on instrument address
CALL IBTMO(generator%, 11)      'Response time to 1 sec
REM *****
```

#### Initiate Instrument

The IEC-bus status registers and instrument settings of the SMR are brought into the default status.

```
REM ----- Initiate Instrument -----
REM InitDevice
CALL IBWRT(generator%, "*CLS")    'Reset status register
CALL IBWRT(generator%, "*RST")   'Reset instrument
CALL IBWRT(generator%, "OUTPUT ON") 'Switch on RF output
REM*****
```



## Transmission of Instrument Setting Commands

Output frequency, output level and AM modulation are set in this example. The settings correspond to the sample setting for first users in manual control. By analogy to the step width setting of the rotary knob, the step width is additionally set for the alteration of the RF frequency in the case of UP and DOWN.

```
REM ----- Instrument setting commands -----
CALL IBWRT(generator%, "FREQUENCY 250E6") 'RF Frequency 250 MHz
CALL IBWRT(generator%, "POWER -10")      'Output power -10 dBm
CALL IBWRT(generator%, "AM 80")          'AM with modulation index of 80%
CALL IBWRT(generator%, "AM:INTERNAL:FREQUENCY 3KHZ")
                                          'Modulation frequency 3kHz
CALL IBWRT(generator%, "AM:SOURCE INT")  'Modulation source LF generator
CALL IBWRT(generator%, "FREQUENCY:STEP 12000")
                                          'Step width RF frequency 12 kHz
REM *****
```

## Switchover to Manual Control

```
REM ----- Switch instrument over to manual control -----
CALL IBLOC(generator%) 'Set instrument to Local state
REM *****
```

## Reading out Instrument Settings

The settings made in the example above are read out here. The abbreviated commands are used.

```
REM ----- Reading out instrument settings -----
Rffrequency$ = SPACE$(20) 'Provide text variables with 20 characters
CALL IBWRT(generator%, "FREQ?") 'Request frequency setting
CALL IBRD(generator%, Rffrequency$) 'Read value

Rflevel$ = SPACE$(20) 'Provide text variables with 20 characters
CALL IBWRT(generator%, "POW?") 'Request level setting
CALL IBRD(generator%, Rflevel$) 'Read value

AMmodulationdepth$ = SPACE$(20) 'Provide text variables with 20 characters
CALL IBWRT(generator%, "AM?") 'Request setting of modulation depth
CALL IBRD(generator%, AMmodulationdepth$) 'Read value

AMfrequency$ = SPACE$(20) 'Provide text variables with 20 characters
CALL IBWRT(generator%, "AM:INT:FREQ?") 'Request setting of modulation frequency
CALL IBRD(generator%, AMfrequency$) 'Read value

Stepwidth$ = SPACE$(20) 'Provide text variables with 20 characters
CALL IBWRT(generator%, "FREQ:STEP?") 'Request step width setting
CALL IBRD(generator%, Stepwidth $) 'Read value

REM ----- Display values on the screen -----
PRINT "RF frequency: "; Rffrequency$,
PRINT "RF level: "; Rflevel$,
PRINT "AM modulationdepth: "; AMmodulationdepth$,
PRINT "AM frequency: "; AMfrequenz$,
PRINT "Step width: "; stepwidth$
REM *****
```

## List Management

```

REM ----- Example of list management -----
CALL IBWRT(generator%, "LIST:SELECT "+CHR$(34)+"LIST1"+CHR$(34))
      'Select list "LIST1", is generated if necessary
CALL IBWRT(generator%, "LIST:POWER -30,-15,-10,-5,0,0.1")
      'Fill power list with values
CALL IBWRT(generator%, "LIST:FREQ 575MHz,235MHz,123MHz,456MHz,735MHz,333MHz")
      'Fill frequency list with values
CALL IBWRT(generator%, "LIST:DWELL 0.2")
      '200ms per item
CALL IBWRT(generator%, "TRIGGER:LIST:SOURCE AUTO")
      'Permanently repeat list automatically
CALL IBWRT(generator%, "POWER:MODE LIST")
      'Switch over instrument to list mode
REM *****

```

## Command synchronization

The possibilities for synchronization implemented in the following example are described in Chapter 5, Section "Command Order and Command Synchronization".

```

REM ----- Examples of command synchronization -----
REM Command ROSCILLATOR:SOURCE INT has a relatively long execution time
REM (over 300ms). It is to be ensured that the next command is only executed
REM when the reference oscillator has settled.

REM ----- First possibility: Use of *WAI -----
CALL IBWRT(generator%, "ROSCILLATOR:SOURCE INT; *WAI; :FREQUENCY 100MHZ")

REM ----- Second possibility: Use of *OPC? -----
OpcOk$ = SPACE$(2)           'Space for *OPC? - Provide response
CALL IBWRT(generator%, "ROSCILLATOR:SOURCE INT; *OPC?")
REM ----- here the controller can service other instruments -----
CALL IBRD(generator%, OpcOk$)      'Wait for "1" from *OPC?

REM ----- Third possibility: Use of *OPC
REM In order to be able to use the service request function in conjugation
REM with a National Instruments GPIB driver, the setting "Disable Auto
REM Serial Poll" must be changed to "yes" by means of IBCONF.

CALL IBWRT(generator%, "*SRE 32")   'Permit service request for ESR
CALL IBWRT(generator%, "*ESE 1")   'Set event-enable bit for
                                   'operation-complete bit
ON PEN GOSUB OpcReady              'Initialization of the service request routine
PEN ON
CALL IBWRT(generator%, "ROSCILLATOR:SOURCE INT; *OPC")
REM Continue main program here.
STOP                               'End of program

OpcReady:
REM As soon as the reference oscillator has settled, this subroutine is
REM activated
REM Program suitable reaction to the OPC service request.
ON PEN GOSUB OpcReady              'Enable SRQ routine again
RETURN
REM *****

```

## Service Request

The service request routine requires an extended initialization of the instrument in which the respective bits of the transition and enable registers are set.

In order to be able to use the service request function in conjugation with a National Instruments GPIB driver, the setting "Disable Auto Serial Poll" must be changed to "yes" by means of IBCONF.

```

REM ---- Example of initialization of the SRQ in the case of errors -----
CALL IBWRT(generator%, "*CLS")           'Reset status reporting system
CALL IBWRT(generator%, "*SRE 168")      'Permit service request for STAT:OPER-,
                                        'STAT:QUES- and ESR register
CALL IBWRT(generator%, "*ESE 60")       'Set event-enable bit for command, exe-
                                        'cution, device-dependent and query error
CALL IBWRT(generator%, "STAT:OPER:ENAB 32767") 'Set OPERation enable bit
                                        'for all events
CALL IBWRT(generator%, "STAT:OPER:PTR 32767") 'Set appropriate OPERation
                                        'Ptransition bits
CALL IBWRT(generator%, "STAT:OPER:ENAB 32767") 'Set questionable enable bits
                                        'for all events
CALL IBWRT(generator%, "STAT:OPER:PTR 32767") ' Set appropriate questionable
                                        'Ptransition bits
ON PEN GOSUB Srq                        'Initialization of the service
                                        'request routine

PEN ON
REM Continue main program here
STOP                                    'End of program

```

A service request is then processed in the service request routine.

**Note:** The variables userN% and userM% must be pre-assigned usefully.

```

Srq:
REM ----- Service request routine -----
DO
  SRQFOUND% = 0
  FOR I% = userN% TO userM%           'Poll all bus users
    ON ERROR GOTO nouser              'No user existing
    CALL IBRSP(I%, STB%)             'Serial poll, read status byte
    IF STB% > 0 THEN                  'This instrument has bits set
                                        'in the STB

      SRQFOUND% = 1
      IF (STB% AND 16) > 0 THEN GOSUB Outputqueue
      IF (STB% AND 4) > 0 THEN GOSUB Failure
      IF (STB% AND 8) > 0 THEN GOSUB Questionablestatus
      IF (STB% AND 128) > 0 THEN GOSUB Operationstatus
      IF (STB% AND 32) > 0 THEN GOSUB Esrread
    END IF
  NEXT I%
nouser:
  NEXT I%
LOOP UNTIL SRQFOUND% = 0
ON ERROR GOTO error handling
ON PEN GOSUB Srq: RETURN              'Enable SRQ routine again;
                                        'End of SRQ routine

```

Reading out the status event registers, the output buffer and the error/event queue is effected in subroutines.

```

REM ----- Subroutines for the individual STB bits -----
Outputqueue:
Message$ = SPACE$(100)           'Reading the output buffer
                                'Make space for response
CALL IBRD(generator%, Message$)
PRINT " Message in output buffer :"; Message$
RETURN

Failure:
ERROR$ = SPACE$(100)           'Read error queue
                                'Make space for error variable
CALL IBWRT(generator%, "SYSTEM:ERROR?")
CALL IBRD(generator%, ERROR$)
PRINT "Error text :"; ERROR$
RETURN

Questionablestatus:
Ques$ = SPACE$(20)             'Read questionable status register
                                'Preallocate blanks to text variable
CALL IBWRT(generator%, "STATUS:QUESTIONABLE:EVENT?")
CALL IBRD(generator%, Ques$)
IF (VAL(Ques$) AND 128) > 0 THEN PRINT "Calibration ?" 'Calibration is
                                'questionable
IF (VAL(Ques$) AND 1) > 0 THEN PRINT "Voltage ?"      'Output level
                                'questionable
RETURN

Operationstatus:
Oper$ = SPACE$(20)             'Read operation status register
                                'Preallocate blanks to text variable
CALL IBWRT(generator%, "STATUS:OPERATION:EVENT?")
CALL IBRD(generator%, Oper$)
IF (VAL(Oper$) AND 1) > 0 THEN PRINT "Calibration"
IF (VAL(Oper$) AND 2) > 0 THEN PRINT "Settling"
IF (VAL(Oper$) AND 8) > 0 THEN PRINT "Sweeping"
IF (VAL(Oper$) AND 32) > 0 THEN PRINT "Wait for trigger"
RETURN

Esrread:
Esr$ = SPACE$(20)             'Read Event status register
                                'Preallocate blanks to text variable
CALL IBWRT(generator%, "*ESR?") 'Read ESR
CALL IBRD(generator%, Esr$)
IF (VAL(Esr$) AND 1) > 0 THEN PRINT "Operation complete"
IF (VAL(Esr$) AND 4) > 0 THEN GOTO Failure
IF (VAL(Esr$) AND 8) > 0 THEN PRINT "Device dependent error"
IF (VAL(Esr$) AND 16) > 0 THEN GOTO Failure
IF (VAL(Esr$) AND 32) > 0 THEN GOTO Failure
IF (VAL(Esr$) AND 64) > 0 THEN PRINT "User request"
IF (VAL(Esr$) AND 128) > 0 THEN PRINT "Power on"
RETURN
REM *****

REM ----- Error routine -----
Error handling:
PRINT "ERROR"                 'Output error message
STOP                          ' Stop software

```

## Operating the Generator in the IEC-Bus Controller Mode

```

----- Initializations -----
      'ATTENTION: Specify your own addresses here!!

pcadr% = 0           'enter IEC-bus-address of the PC !
gen_adr% = 28       'enter IEC-bus-address of the SMR

CALL IBFIND("gpib0", pc)      'set IEC-Bus-address of the PC
CALL IBPAD(pc, pcadr%)

CALL IBFIND("dev1", generator) 'SMR can be controlled under Device1
CALL IBPAD(generator, gen_adr%)

----- Main program -----

Command$ = "sour:corr:coll"    'SCPI-command for automatic UCOR

a$ = "*pcb " + STR$(pcadr%)    'tells the SMR to return control
CALL IBWRT(generator, a$)      'to the address pcadr% afterwards

CALL IBWRT(generator, Command$) 'Readout of the command itself

CALL IBPCT(generator)         'Control is given to the SMR

      ' --- Waiting for return of control

MASK% = &H4020                ' CIC or Timeout
CALL IBWAIT(brd%, MASK%)

IF IBSTA% AND &H4000 THEN
    PRINT "Timeout; control not received"
    END
ELSE
    PRINT " Control taken back "
END IF

```

## 8 Maintenance

The present chapter describes the measures that are necessary for maintaining, storing and packing the instrument.

The instrument does not need a periodic maintenance. What is necessary is essentially the cleaning of the outside of the instrument.

However, it is recommended to check the rated data from time to time.

### Cleaning the Outside

The outside of the instrument is suitably cleaned using a soft, line-free dustcloth.

**Caution!** *Do not use solvents such as thinners, acetone and similar things in any case, because otherwise the front panel labeling or plastic parts will be damaged.*

### Storing and Packing

The instrument can be stored at a temperature of  $-40^{\circ}\text{C}$  to  $+70^{\circ}\text{C}$ . When stored for an extended period of time, the instrument should be protected against dust.

The original packing should be used, particularly the protective covers at the front and rear, when the instrument is to be transported or dispatched. If the original packing is no longer available, use a sturdy cardboard box of suitable size and carefully wrap the instrument to protect it against mechanical damage.



## 9 Error Messages

The present chapter contains the error messages (short-term and long-term messages) of the SMR.

**Short-term message** The short-term message is displayed in the status line. Part of it overwrites the status indications and disappears after approx. 2 seconds or in the case of a new entry.

The instrument shows, e.g., short-term messages if the attempt is made to enter an overrange or if incompatible operating modes deactivate one another.

**Long-term message** The long-term message is displayed in the status line by means of the message "WARNING" or "ERROR". Pressing the [ERROR] key calls the ERROR page in which the messages are entered. Several messages can be entered at the same time. The long-term message remains existing until there is no cause any more. The ERROR page is exited using the [BACK] key.

The instrument displays, e.g., the long-term message "ERROR" if there is a hardware error or "WARNING" if overrange settings have been made.

The ERROR page offers access to long-term messages if the [ERROR] key is pressed.

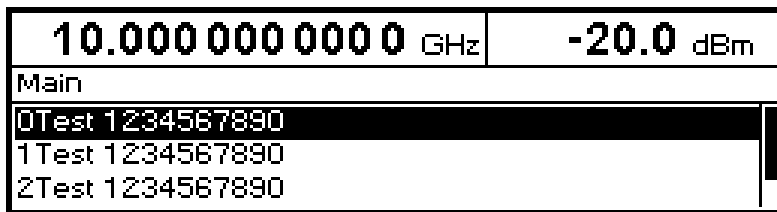

Fig. 9-1 ERROR page

- Notes:**
- An error message "ERROR" does not necessarily point to a defect instrument. There are various operating states which can cause an ERROR message, e.g. if the instrument is set to external reference but no external reference is connected.
  - Error 313 indicates the loss of calibration data and is also applicable in case of a cold start (key [PRESET] is pressed during switch-on). The calibration values can be restored with internal calibration routines. These routines are accessible via menu Utilities - Calib (see section on calibration).



## List of Error Messages

The following list contains all SCPI- and device-specific error messages for errors occurring in the instrument. The meaning of negative error codes is defined in SCPI, positive error codes mark device-dependent errors.

The lefthand column of the table below contains the error code. In the righthand column, the error text entered into the error/event queue and shown on the display is in bold type. Below the error text there is an explanation of the error.

### SCPI-Specific Error Messages

No error

Error code	Error text with queue poll Explanation of error
0	<b>No error</b> This message is output if the error queue contains no entries.

Command Error – errored command; sets bit 5 in the ESR register

Error code	Error text with queue poll Explanation of error
-100	<b>Command error</b> The command is errored or invalid.
-101	<b>Invalid character</b> The command contains an invalid character. Example: A header contains an ampersand, "SOURCE&".
-102	<b>Syntax error</b> The command is invalid. Example: A command contains block data which the instrument does not accept.
-103	<b>Invalid separator</b> The command contains an illegal character instead of a terminator. Example: A semicolon after the command is missing.
-104	<b>Data type error</b> The command contains an invalid value information. Example: ON is entered instead of a numerical value for frequency setting.
-105	<b>GET not allowed</b> A Group Execute Trigger (GET) is entered within a command line.
-108	<b>Parameter not allowed</b> The command contains too many parameters. Example: The command SOURCE:FM:INTERNAL:FREQUENCY allows for a frequency entry only.
-109	<b>Missing parameter</b> The command contains too few parameters. Example: The command SOURCE:FM:INTERNAL:FREQUENCY requires a frequency entry.

## Command Error, continued

Error code	Error text with queue poll Explanation of error
-112	<b>Program mnemonic too long</b> The header contains more than 12 characters.
-113	<b>Undefined header</b> The header is not defined for the instrument. Example: *XYZ is undefined for every instrument.
-114	<b>Header suffix out of range</b> The header contains an illegal numerical suffix. Example: SOURCE3 does not exist in the instrument.
-123	<b>Exponent too large</b> The absolute value of the exponent is larger than 32000.
-124	<b>Too many digits</b> The number contains too many digits.
-128	<b>Numeric data not allowed</b> The command contains a number which is not allowed at this position. Example: The command SOURCE:FREQUENCY:MODE requires the entry of a text parameter.
-131	<b>Invalid suffix</b> The suffix is invalid for this instrument. Example: nHz is not defined.
-134	<b>Suffix too long</b> The suffix contains more than 12 characters.
-138	<b>Suffix not allowed</b> A suffix is not allowed for this command or at this position of the command. Example: The command *RCL does not allow for a suffix to be entered.
-141	<b>Invalid character data</b> The text parameter either contains an invalid character or it is invalid for this command. Example: spelling mistake in parameter entry; SOURCE:FREQUENCY:MODE FIXSed.
-144	<b>Character data too long</b> The text parameter contains more than 12 characters.
-148	<b>Character data not allowed</b> The text parameter is not allowed for this command or at this position of the command. Example: The command *RCL requires the entry of a number.
-158	<b>String data not allowed</b> The command contains a valid character string at a position which is not allowed. Example: A text parameter is entered in inverted commas, eg SOURCE:FREQUENCY:MODE "FIXed"
-161	<b>Invalid block data</b> The command contains errored block data. Example: An END message was received before the expected number of data was received.
-168	<b>Block data not allowed</b> The command contains valid block data at a position which is not allowed. Example: The command *RCL requires the entry of a number.
-178	<b>Expression data not allowed</b> The command contains a mathematical expression at a position which is not allowed.

Execution Error – error in the execution of a command; sets bit 4 in the ESR register

Error code	Error text with queue poll Explanation of error
-203	<p><b>Command protected</b> The desired command could not be executed as it is protected by a password. Use the command <code>SYSTEM:PROTECT OFF, &lt;password&gt;</code> to enable the desired command. Example: The command <code>CALibrate:PULSe:MEASure?</code> is password-protected.</p>
-211	<p><b>Trigger ignored</b> The trigger (GET, *TRG or trigger signal) was ignored because of the instrument timing control. Example: The instrument was not ready to answer.</p>
-221	<p><b>Settings conflict</b> The settings of two parameters are conflicting. Example: FM1 and PM1 cannot be switched on at the same time.</p>
-222	<p><b>Data out of range</b> The parameter value is out of the permissible range of the instrument. Example: The command *RCL only permits entries between 0 and 50.</p>
-223	<p><b>Too much data</b> The command contains too many data. Example: The instrument does not have sufficient memory space.</p>
-224	<p><b>Illegal parameter value</b> The parameter value is invalid. Example: An invalid text parameter is entered, eg <code>TRIGger:SWEp:SOURce TASTE</code></p>
-225	<p><b>Out of memory</b> The available instrument memory space is exhausted. Example: An attempt was made to create more than 10 lists.</p>
-226	<p><b>Lists not of same length</b> The parts of a list have different lengths. This error message is also displayed if only part of a list has been transmitted via the IEC/IEEE bus. All parts of a list have to be transmitted before the list is executed. Example: The POWER part of a list is longer than the FREQUENCY part, or only the POWER part has been transmitted.</p>
-230	<p><b>Data corrupt or stale</b> The data are incomplete or invalid. Example: The instrument has aborted a measurement.</p>
-240	<p><b>Hardware error</b> The command cannot be executed because of a hardware fault of the instrument.</p>
-241	<p><b>Hardware missing</b> The command cannot be executed because of hardware missing. Example: An option is not fitted.</p>
-255	<p><b>Directory full</b> The list management cannot accept any more lists since the maximum number of lists has already been attained. Example: An attempt was made to create more than the allowed number of MEM SEQ lists.</p>

Device Specific Error - sets bit 3 in the ESR register

Error code	Error text with queue poll Explanation of error
-310	<b>System error</b> This error message suggests an error within the instrument. Please inform your R&S service center.
-311	<b>Memory error</b> Error in instrument memory.
-313	<b>Calibration memory lost</b> Loss of stored calibration data. The YFOM and ALC AMP calibration data can be restored by means of internal routines (see chapter 2, section "Calibration").
-314	<b>Save/recall memory lost</b> Loss of the nonvolatile data stored with the command *SAV?.
-315	<b>Configuration memory lost</b> Loss of the nonvolatile configuration data stored by the instrument.
-330	<b>Self-test failed</b> The self-test could not be executed.
-350	<b>Queue overflow</b> This error code is entered into the error queue instead of the actual error code when the error queue is full. The code indicates that an error has occurred but has not been accepted. The error queue can accept 5 entries.
-360	<b>Communication error</b> An error has occurred during the transmission or reception of data on the IEC/IEEE bus or via the RS-232-C interface.

Query Error – error in data request; sets bit 2 in the ESR register

Error code	Error text with queue poll Explanation of error
-410	<b>Query INTERRUPTED</b> The query was interrupted. Example: After a query, the instrument receives new data before the response has been sent completely.
-420	<b>Query UNTERMINATED</b> The query is incomplete. Example: The instrument is addressed as a talker and receives incomplete data.
-430	<b>Query DEADLOCKED</b> <b>The query cannot be processed.</b> Example: The input and output buffers are full; the instrument cannot continue operating.

**SMR-Specific Error Messages**

The lefthand column of the table below contains the error code. In the righthand column, the error text entered into the error/event queue and shown on the display is in bold type. Below the error text there is an explanation of the error.

Device-dependent Error – device-specific error; sets bit 3 in the ESR register.

Error code	Error text in the case of queue poll Error explanation
105	<b>Frequency underrange</b> The frequency is below the limit value guaranteed.
106	<b>Frequency overrange</b> The frequency is beyond the limit value guaranteed.
110	<b>Output unlevelled</b> The level control loop is deactivated.
115	<b>Level overrange</b> The level is above the limit value guaranteed.
116	<b>Level underrange</b> The level is below the limit value guaranteed.
117	<b>Dynamic level range exceeded</b> The difference between the maximal and minimal value of a level list is above 20 dBm. An exact level setting is no longer guaranteed.
131	<b>AM modulation frequency out of range</b> The AM modulation frequency is out of the permissible range.
132	<b>FM modulation frequency out of range</b> The FM modulation frequency is out of the permissible range.
133	<b>AM modulation overdriven</b> The amplitude modulation cannot generate the set modulation index.
134	<b>FM modulator overdriven</b> The frequency modulator cannot generate the set frequency deviation.
135	<b>Pulse input signal missing</b> No pulse input signal available.
140	<b>This modulation forces other modulations OFF</b> A modulation has been switched on which cannot be used at the same time as an already active modulation. The previous modulation has been switched off.
152	<b>Input voltage out of range; EXT1 too high</b> The input voltage at the EXT1 socket is too high.
153	<b>Input voltage out of range; EXT1 too low</b> The input voltage at the EXT1 socket is too low.
154	<b>Input voltage out of range; EXT2 too high</b> The input voltage at the EXT2 socket is too high.
155	<b>Input voltage out of range; EXT2 too low</b> The input voltage at the EXT2 socket is too low.
171	<b>Oven cold</b> The reference oscillator has not yet reached its operating temperature.

Continuation: Device-dependent Error

Error code	Error text in the case of queue poll Error explanation
180	<b>Calibration failed</b> Calibration could not be executed.
181	<b>REF OSC calibration data not used because ADJUSTMENT STATE is ON</b> The reference-oscillator calibration data are not used as long as ADJUSTMENT STATE is activated.
184	<b>Calibration data missing</b> Calibration data are missing in the device memory. The calibration data have to be generated first by an internal or external calibration or to be loaded into the device.
200	<b>Cannot access hardware</b> The data transmission to a module was unsuccessful.
201	<b>Function not supported by this hardware revision</b> A later version of certain parts of the instrument is necessary to execute the function selected.
202	<b>Diagnostic A/D converter failure</b> Diagnostic A/D converter has failed.
223	<b>YPLL unlocked</b> The PLL of the YIG loop has not been synchronized.
241	<b>No list defined</b> There is no list defined..
243	<b>Dwell time adjusted</b> A dwell time given on a list cannot be processed by the unit. The setting was automatically adjusted.
251	<b>No User Correction Table; zero assumed</b> An attempt has been made to switch on user correction, but no UCOR table has been stored in the instrument yet. The instrument behaves as if a table was called which only contains 0-values.
260	<b>Invalid keyboard input ignored</b> An invalid input via the keyboard is not considered.
265	<b>This parameter is read only</b> An attempt has been made to change a fixedly specified value.

Continuation: Device-dependent Error

<b>Error code</b>	<b>Error text in the case of queue poll</b> Error explanation
270	<b>Data output aborted</b> Data output was aborted on the IEC/IEEE-bus. Example: The key [LOCAL] was pressed.
304	<b>String too long</b> A character string which is too long was received via the IEC bus. The names of lists may have a length of maximally seven letters.
305	<b>Fill pattern too long; truncated</b> More data have been entered with block function FILL in the list editor than the filling range (RANGE) set permits. The exceeding data are ignored.
306	<b>No fill pattern specified</b> An attempt was made to execute a filler function without having to indicate a filler pattern.

## 10 Index

This chapter contains the index for the present operating manual.

### A

Abort actions triggered.....	6.6
Active edge	
external trigger	
PULSE input .....	4.16, 4.24, 6.55
TRIGGER input .....	6.55
Address	
IEC/IEEE bus .....	5.3, 6.47
Addressed commands .....	5.27
AM	
coupling .....	4.13, 6.14
frequency .....	4.13, 6.14
Amplitude marker (RF sweep) .....	4.30, 6.27
Amplitude modulation (AM).....	4.13, 6.13
ASK modulation.....	6.18
Asterisk .....	5.12
Attenuation	
RF output signal .....	4.22, 6.11
Attenuator.....	4.4, 6.11
Attenuator operating cycles .....	4.51
AUX interface .....	1.9
AUX-I/O.....	4.54
Auxiliary inputs/outputs.....	4.54

### B

Battery, test RAM .....	4.52
Baud rate (RS-232-C).....	4.44, 5.29, 6.47
BLANK output.....	4.27, 4.35, 4.54
Blank signal	
duration .....	4.54
Blank time.....	6.35
Block data.....	5.11
Boolean parameters .....	5.9, 5.10
Brief instructions	
IEC/IEEE bus .....	5.1
RS-232-C interface.....	5.2
Brightness	
Control (oscilloscope).....	4.27

### C

Calibration .....	4.48
disable.....	6.50
password.....	4.47, 6.50
Call	
instrument settings .....	3.14
menu .....	3.4
Center frequency	
RF sweep.....	4.30, 6.21
Character data.....	5.9
Cleaning	
outside.....	8.1

### Clear

all stored data .....	4.45
memories .....	4.45
Colon.....	5.12
Comma .....	5.12
Command	
addressed commands.....	5.27
common commands.....	5.5, 5.6, 6.3
device-specific commands .....	5.5, 5.6
hierarchical arrangement.....	6.1
long form.....	5.7
parameters.....	5.10
path.....	5.6
Processing .....	5.13
queries .....	5.5
recognition .....	5.14
sequence .....	5.15
setting commands.....	5.5
short form.....	5.7
structure.....	5.6
structure of command lines .....	5.9
synchronization .....	5.15, 7.3
syntax elements .....	5.12
universal commands .....	5.27
Command Error bit .....	5.20
Command lines	
structure.....	5.9
Common commands .....	6.3
CONdition part.....	5.17
Control signal (pulse modulation) .....	4.15
Controller mode.....	7.6
Coupling	
EXT1/2 (AM) .....	4.13, 6.14
EXT1/2 (FM) .....	4.14, 6.19
Crosshatch symbol (#) .....	5.11, 5.12
Cursor	
digit cursor .....	3.1
menu cursor.....	3.1

### D

Data	
format (RS-232-C).....	4.44
set (IEC/IEEE bus).....	5.14
Data bit (RS-232-C).....	5.29
DCL.....	5.13
Decimal point .....	1.5, 5.10
Delay	
double pulse.....	6.33
pulse modulation.....	4.15, 4.23, 6.33
Delete	
List.....	3.8
List entry .....	3.13
Detector (power control).....	6.29
Deviation	
FM .....	4.14, 6.19
FSK.....	6.18
Device model (IEC/IEEE bus) .....	5.13



Device responses ..... 5.5  
 Device-Dependent Error bit ..... 5.20  
 Digit cursor ..... 3.1  
 Digital modulation (DM) ..... 6.17  
 Disable  
   indications ..... 4.45  
 Display  
   attenuator operating cycles ..... 4.51  
   contrast ..... 4.42  
   design ..... 3.1  
   modules ..... 4.49  
   operating-hours counter ..... 4.51  
   serial number ..... 4.51  
   software version ..... 4.51  
   voltage of test points ..... 4.50  
 Double pulse ..... 4.16, 4.23, 6.33  
 Dwell list  
   List ..... 6.25  
   Mseq ..... 6.49  
 Dwell time  
   frequency sweep ..... 6.35  
   level sweep ..... 6.36

**E**

Edge  
   external trigger  
     PULSE input ..... 4.16, 4.24, 6.55  
     TRIGGER input ..... 6.55  
 Edit  
   List ..... 3.9  
 EMC ..... 1.1  
 ENABLE part ..... 5.17  
 Envelope ..... 4.15  
 EOI (command line) ..... 5.9  
 EPROM, test ..... 4.52  
 Error messages ..... 6.50, 9.2  
   device-specific ..... 9.1  
   SCPI-specific ..... 9.2  
 Error queue ..... 6.45, 6.48  
   Query ..... 5.23  
 Error Queue Not Empty bit ..... 5.19  
 ESB bit ..... 5.19  
 ESE (event status enable register) ..... 5.20  
 ESR (event status register) ..... 5.20  
 EVENT part ..... 5.17  
 Event status register (ESR) ..... 5.20  
 Execution Error bit ..... 5.20  
 Exponent ..... 5.10  
 EXT ALC input ..... 1.7  
 EXT1/2  
   coupling ..... 4.13, 4.14, 6.14, 6.19  
   input impedance ..... 4.13, 4.14, 6.14, 6.19  
 External reference ..... 4.46  
 External trigger  
   active edge  
     PULSE input ..... 4.16, 4.24, 6.55  
     TRIGGER input ..... 6.55  
   list ..... 4.35, 6.53  
   Memory Sequence ..... 4.39, 6.54  
   pulse modulation ..... 4.16, 4.24, 6.54  
   sweep ..... 6.52

**F**

FM  
   coupling ..... 6.19  
   coupling type ..... 4.14  
   deviation ..... 4.14, 6.19  
   frequency ..... 4.14, 6.20  
 Frequency  
   accuracy ..... 1.2  
   adjustment ..... 4.46, 6.34  
   AM ..... 4.13, 6.14  
   correction value ..... 6.34  
   FM ..... 4.14, 6.20  
   indication ..... 3.1  
   LF generator ..... 6.39  
   LF sweep ..... 6.39  
   list ..... 6.25  
   multiplier ..... 4.1, 6.22  
   offset ..... 4.1, 4.2, 6.22  
   RF output signal ..... 6.21  
   RF sweep ..... 6.23  
   suppression of indication ..... 4.45  
 Frequency marker  
   LF sweep ..... 6.41  
   RF sweep ..... 4.30, 6.28  
 Frequency modulation (FM) ..... 6.19  
 Frequency sweep  
   LF ..... 4.32, 6.42  
   RF ..... 6.22  
 Front panel ..... 1.4  
 FSK modulation ..... 6.18  
 Fuse holder ..... 1.9

**G**

Gate signal  
   trigger ..... 4.16, 4.24  
 GET (Group Execute Trigger) ..... 5.14

**H**

Handshake (RS-232-C) ..... 4.44, 5.30, 6.47  
 Header (commands) ..... 5.6  
 Header field (display) ..... 3.1  
 Help texts ..... 4.56

**I**

IEC/IEEE bus  
   address ..... 4.43, 6.47  
   brief instructions ..... 5.1  
   bus lines ..... 5.25  
   interface ..... 5.25  
   language ..... 4.45  
   library ..... 7.1  
   setting of address ..... 5.3  
 IF input ..... 1.10, 4.22, 6.10  
 Impedance (RF output) ..... 6.11

- Indication
- error messages ..... 6.45
  - modules ..... 6.8
  - operating-time counter ..... 6.8
  - remote control ..... 5.3, 5.4
  - RF OFF ..... 4.9
  - software version ..... 6.8
  - suppression of ..... 4.45
- INF ..... 5.10
- Initial Status ..... 1.2
- Initialization
- controller ..... 7.1
  - instrument ..... 7.1
- Input
- correction ..... 3.6
  - EXT ALC ..... 1.7
  - EXT1/2 ..... 1.4
  - frequency ..... 3.5
  - IF ..... 1.10, 4.22, 6.10
  - level ..... 3.5
  - modulations (overview) ..... 4.10
  - PULSE ..... 1.7, 6.55
  - REF ..... 1.9, 4.46
  - RF ..... 1.11
  - serial number ..... 4.47
  - TRIG/STOP ..... 1.11, 4.35, 4.39
  - TRIGGER ..... 6.55
- Input buffer ..... 5.13
- Input impedance
- EXT1/2 ..... 4.13, 4.14, 6.14, 6.19
  - pulse generator ..... 4.16, 4.24
- Input unit ..... 5.13
- Insert
- List entry ..... 3.9
- Instrument states
- reset ..... 6.50
- Instrument setting commands
- transmission ..... 7.2
- Instrument settings
- call ..... 3.14
  - reading out ..... 7.2
  - store ..... 3.14
- Interface
- functions (IEC/IEEE bus) ..... 5.26
  - functions (RS-232-C) ..... 5.29
  - IEC/IEEE bus ..... 5.25
  - messages (IEC/IEEE bus) ..... 5.27
  - RS-232-C ..... 1.10, 5.28
- Internal reference ..... 4.46
- Interrupt ..... 5.19
- Inverted commas ..... 5.12
- IST flag ..... 5.20
- K**
- Key
- [-/←] ..... 1.5, 3.6
  - [ASSIGN] ..... 1.8, 3.4
  - [BACK] ..... 3.2, 3.6
  - [BACK] ..... 1.6
  - [ERROR] ..... 9.1
  - [FREQ] ..... 1.4, 3.5, 3.6, 4.1
  - [G/h] ..... 1.5
  - [HELP] ..... 4.56
  - [LEVEL] ..... 1.4, 3.5, 3.6, 4.3
  - [LOCAL] ..... 5.4
  - [M/μ] ..... 1.5
  - [MENU 1/2] ..... 1.8, 3.4
  - [MOD ON/OFF] ..... 1.7, 3.5, 4.12, 4.53
  - [PRESET] ..... 1.3
  - [RCL] ..... 1.4, 3.14
  - [RF ON/OFF] ..... 1.7, 3.5, 4.9
  - [SAVE] ..... 1.4, 3.14
  - [SELECT] ..... 3.2
  - [SELECT] ..... 1.6
  - [STATUS] ..... 4.56
  - Backspace ..... 3.6
  - ERROR ..... 1.7
  - HELP ..... 1.7
  - k/m ..... 1.5
  - LOCAL ..... 1.7
  - PRESET ..... 1.7
  - STATUS ..... 1.7
  - unit key ..... 1.5
  - X1/Enter ..... 1.5
- Knob Step
- frequency ..... 4.2
  - level ..... 4.4
- L**
- Level
- automatic control ..... 4.6
  - control ..... 4.6, 6.29
  - correction (Ucor list) ..... 4.8, 6.15
  - indication ..... 3.1
  - limit ..... 4.3, 6.30
  - list ..... 6.26
  - marker ..... 4.31, 6.28
  - offset ..... 4.3, 4.5, 6.30
  - RF output ..... 4.3, 6.30
  - setting (non-interrupting) ..... 4.4, 4.5
  - suppression of indication ..... 4.45
  - sweep ..... 4.31
  - unit ..... 4.3
  - unit change ..... 3.5
- Level sweep
- dwelt time ..... 4.31
  - marker ..... 4.32
  - start level ..... 4.31
  - step size ..... 4.31
  - stop level ..... 4.31
  - sweep mode ..... 4.31
- LF generator ..... 4.18, 6.38
- frequency ..... 6.39
  - waveform ..... 4.13, 4.14, 4.21, 6.40
- LF output
- voltage ..... 4.21
- LF sweep
- dwelt time ..... 4.32, 6.42
  - frequency ..... 4.32
  - frequency marker ..... 4.33, 6.41
  - marker ..... 4.33, 6.41
  - start frequency ..... 4.32, 6.39
  - step size ..... 4.32, 6.43
  - stop frequency ..... 4.32, 6.39
  - sweep mode ..... 4.32
  - sweep modes ..... 6.43
- List
- Delete ..... 3.8
  - dwelt (List) ..... 6.25
  - dwelt (Mseq) ..... 6.49
  - Edit ..... 3.9
  - error messages ..... 9.2
  - external trigger ..... 4.35

- frequency (List)..... 6.25  
 instrument states (Mseq)..... 6.49  
 level..... 6.26  
 level correction (Ucor) ..... 4.8, 6.15  
 management ..... 7.3  
 Memory sequence..... 4.38  
 mode ..... 6.26, 6.31, 6.53, 6.54  
 Select..... 3.8  
 List entry  
   Delete..... 3.13  
   Insert..... 3.9  
 List mode..... 4.34  
 dwell..... 4.36  
 example..... 4.35  
 frequency ..... 4.34  
 inputs/outputs..... 4.35  
 level..... 4.34  
 manual processing of list..... 4.34  
 operating modes..... 4.34  
 Lock level ..... 4.47  
 Long form (commands)..... 5.7  
 Lower-case notation (commands)..... 5.7
- M**
- Maintenance..... 8.1  
 Mantissa..... 5.10  
 Manual control  
   switchover ..... 7.2  
 Manual operation  
   return to..... 5.4  
 Marker  
   LF sweep..... 6.41  
   RF sweep..... 6.27  
 MARKER output ..... 4.27, 4.35, 6.41  
 MAV bit..... 5.19  
 Maximum value (commands)..... 5.9, 5.10  
 Memory  
   locations ..... 3.14, 6.10  
 Memory CMOS-RAM..... 1.2  
 Memory list (Mseq)..... 6.49  
 Memory sequence ..... 4.38, 6.48  
   dwell..... 4.38  
   instrument settings ..... 4.38  
   manual processing of list..... 4.39  
   operating modes..... 4.38  
 Menu  
   access..... 3.2  
   call..... 3.4  
   Digital Mod/Ask ..... 4.19  
   Digital Mod/Fsk..... 4.20  
   ERROR ..... 9.1  
   fields..... 3.1  
   Frequency ..... 4.1  
   HELP..... 4.56  
   IfInput ..... 4.22  
   Level - Alc ..... 4.7  
   Level - Level..... 4.3  
   Level - Ucor..... 4.8, 4.9  
   LfOutput ..... 4.21  
   List ..... 4.36  
   MemSeq..... 4.40, 4.41  
   Modulation - AM..... 3.2, 4.13  
   Modulation - Pulse..... 4.15  
   Modulation FM..... 4.14  
   PulseOutput ..... 4.23  
   Status..... 4.56  
   store..... 3.4  
   summary..... 3.15  
   Sweep - Freq ..... 4.29  
   Sweep - Level..... 4.31  
   Sweep - Lfgen..... 4.32  
   Utilities ..... 4.42  
   Utilities - AuxIO..... 4.54  
   Utilities - Calib..... 4.48  
   Utilities - Diag - Config ..... 4.49  
   Utilities - Diag - Param ..... 4.51  
   Utilities - Diag - TPoint..... 4.50  
   Utilities - Display ..... 4.42  
   Utilities - ModKey..... 4.53  
   Utilities - Protect..... 4.47  
   Utilities - RefOsc ..... 4.46  
   Utilities - Setup..... 4.55  
   Utilities - System..... 4.42  
   Utilities - System - GPIB - Address..... 4.43  
   Utilities - System - Language ..... 4.45  
   Utilities - System - RS232 ..... 4.44  
   Utilities - System - Security ..... 4.45  
   Utilities - Test..... 4.52  
 Menu cursor ..... 3.1  
 Message OVEN COLD..... 1.2  
 Messages  
   device messages ..... 5.5  
   interface messages..... 5.5  
 Minimum value (commands)..... 5.9, 5.10  
 Modulation  
   AM ..... 4.13, 6.13  
   ASK ..... 4.19, 6.18  
   external signal..... 4.11  
   FM ..... 4.14, 6.19  
   FSK..... 4.20, 6.18  
   incompatible modulation types ..... 4.11  
   inputs ..... 4.10  
   modulation generator ..... 4.10  
   mutual switch-off..... 4.11  
   overview of modulation types ..... 4.10  
   pulse..... 6.32  
   Pulse..... 4.15  
   two-tone modulation..... 4.11  
 Modulation depth  
   AM ..... 4.13, 6.13  
 Modulation source  
   external..... 4.10  
   internal..... 4.10  
 Modulation types  
   switching-on/off..... 4.53  
 Modules indication ..... 6.8  
 MSS bit ..... 5.19  
 Multiplier..... 4.2  
   frequency..... 4.1
- N**
- NAN ..... 5.10  
 New Line (command line)..... 5.9  
 NINF ..... 5.10  
 Non-interrupting level setting..... 4.4  
 Note  
   Unleveled..... 4.3  
 NTRansition part ..... 5.17  
 Numeric input field..... 1.5  
 Numeric values ..... 1.5  
 Numerical suffix..... 5.8  
 Numerical values..... 5.10

**O**

Offset	
frequency .....	4.1
level .....	4.3
On/Off switch .....	1.8
Operating-hours counter .....	4.51
Operating-time counter .....	6.8
Operation	
general instructions .....	1.1
putting into operation .....	1.1
remote control .....	6.1
Operation Complete bit .....	5.20
OPERation Status Register sum bit .....	5.19
Oscilloscope .....	4.27
Output	
BLANK .....	4.27, 4.35, 4.54
LF .....	1.9, 4.21, 6.12
MARKER .....	4.27, 4.35, 6.41
PULSE/VIDEO .....	1.11, 4.23, 6.12
REF .....	1.9, 4.46
RF .....	1.7, 6.11, 6.21
SYNC .....	1.11
V/GHz .....	1.11, 4.54, 6.12
X-AXIS .....	1.11, 4.27
Z-AXIS .....	4.27
Output buffer (IEC/IEEE bus) .....	5.15
Output level .....	4.3, 6.29
Output unit (IEC/IEEE bus) .....	5.15
Overlapping execution .....	5.14
Overmodulation .....	4.11
Overview	
incompatible modulation types .....	4.11
modulation sources .....	4.10
Status registers .....	5.18
syntax elements .....	5.12

**P**

Packing .....	8.1
Parallel poll .....	5.23
Parallel poll enable register (PPE) .....	5.20
Parameter	
select .....	3.3
text parameter .....	5.10
Parameters (commands) .....	5.10
Parity (RS-232-C) .....	4.44, 6.47
Parity bit (RS-232-C) .....	5.29
Password .....	4.47, 6.50
Path (commands) .....	5.6
Period (pulse) .....	4.15, 4.23
Physical quantities .....	5.9
Polarity	
ASK .....	4.19, 6.18
FSK .....	4.20, 6.18
pulse .....	4.15, 4.23
pulse modulation .....	6.32
Power	
slew rate .....	4.55
Power control	
detector .....	6.29
Power fuses .....	1.2
Power On bit .....	5.20
Power supply .....	1.1
Power supply connector .....	1.9
Power sweep .....	6.36
PPE (parallel poll enable register) .....	5.20

Preset (instrument states) .....	6.50
Presettings .....	1.3
Programming Examples .....	7.1
Protection level .....	6.50
PTRansition part .....	5.17
Pulse	
delay .....	4.15, 4.23, 6.33
period .....	4.15, 4.23, 6.33
width .....	4.15, 4.23, 6.33
Pulse generator .....	4.16, 6.33
input impedance .....	4.16, 4.24
PULSE input .....	1.7, 4.16, 6.55
Pulse modulation .....	4.15, 6.32
polarity .....	6.32
Pulse polarity .....	4.15, 4.23
Pulse source	
selection .....	4.15, 4.23, 6.12
PULSE/VIDEO output .....	1.11, 4.23, 6.12
Putting into Operation	
EMC .....	1.1
unpacking .....	1.1

**Q**

Queries .....	5.5
Query	
error queue .....	5.23
responses to .....	5.9
Query Error bit .....	5.20
Question mark .....	5.12
QUESTionable Status sum bit .....	5.19
Quick selection .....	3.4

**R**

RAM, test .....	4.52
RCL list (Mseq) .....	6.49
Rear panel .....	1.9
Recall	
instrument settings .....	3.14
REF	
input/output .....	1.9, 4.46
Reference	
external .....	4.46
input/output .....	6.34
internal .....	4.46
Reference oscillator OCXO .....	6.34
Remote control .....	6.1
basic information .....	5.1
indications .....	5.3
switchover to remote control .....	5.3
REMOTE state .....	5.3
Reset	
status reporting system .....	5.24
Response	
to queries .....	5.9
RF	
frequency .....	4.1
level .....	4.3
output level .....	6.30
RF input .....	1.11
RF output .....	1.7, 6.11
RF sweep .....	4.29, 6.35
dwell time .....	4.30

marker ..... 4.30  
 operating mode ..... 4.30  
 step size ..... 4.30  
 Rotary knob ..... 1.6, 3.2, 3.3  
 RS-232-C  
   signal lines ..... 5.28  
 RS-232-C interface ..... 1.10, 5.28  
   brief instructions ..... 5.2  
   transmission parameters ..... 4.44

## S

Sample setting ..... 2.1  
 Sample-and-Hold mode ..... 4.6  
 Save  
   instrument settings ..... 3.14  
 SCPI  
   introduction ..... 5.6  
 Scrollbar ..... 3.2  
 Select  
   List ..... 3.8  
 Selection  
   1-out-of-n ..... 3.4  
   quick selection of menu ..... 3.4  
 Self test ..... 4.52, 6.51  
 Semicolon ..... 5.12  
 Sequence name (Mseq) ..... 6.49  
 Serial number (display) ..... 4.51  
 Serial poll ..... 5.22  
 Service data  
   display ..... 4.51  
 Service request (SRQ) ..... 5.22, 7.4  
 Service request enable register (SRE) ..... 5.19  
 Short form (commands) ..... 5.7  
 Sign ..... 5.10  
 Signal scale ..... 6.12  
 Signal slope ..... 4.54  
 Single pulse delay ..... 4.15, 4.23  
 Software version ..... 6.8  
   display ..... 4.51  
 Source impedance (RF output) ..... 4.9  
 Span  
   RF sweep ..... 4.30  
 Special characters ..... 6.2  
 Square brackets ..... 5.7  
 SRE (service request enable register) ..... 5.19  
 SRQ (Service request) ..... 5.22  
 Start frequency  
   LF sweep ..... 6.39  
   RF sweep ..... 4.30, 6.23  
 Start level (level sweep) ..... 6.31  
 Status  
   REMOTE ..... 5.3  
 Status line (display) ..... 3.1  
 STATUS page ..... 4.56  
 Status registers  
   description ..... 5.19  
   overview ..... 5.18  
 Status reporting system ..... 5.16  
   reset values ..... 5.24  
   structure of an SCPI status register ..... 5.16  
   use ..... 5.22  
 STATus\OPERation register ..... 6.44  
 STATus\QUEStionable register ..... 6.45  
 STB (status byte) ..... 5.19  
 Step size  
   rotary knob ..... 4.2, 4.4  
 Step width

  level ..... 6.31  
   LF sweep ..... 6.43  
   power sweep ..... 6.37  
   RF sweep ..... 6.23, 6.36  
 Stop bit (RS-232-C) ..... 4.44, 5.29, 6.47  
 Stop frequency  
   LF sweep ..... 6.39  
   RF sweep ..... 4.30, 6.23  
 Stop level (level sweep) ..... 6.31  
 Store  
   instrument settings ..... 3.14  
   menu ..... 3.4  
 Storing ..... 8.1  
 String ..... 5.11  
 Structure  
   command ..... 5.6  
   command lines ..... 5.9  
 Subroutines ..... 7.5  
 Sum bit ..... 5.17  
 Sum deviation ..... 4.11  
 Sum modulation depth  
   two-tone modulation ..... 4.11  
 Suppression  
   indication ..... 4.45  
 Sweep  
   inputs ..... 4.27  
   level sweep ..... 4.31, 6.31, 6.37  
   LF sweep ..... 4.32  
   operating modes ..... 4.26  
   outputs ..... 4.27  
   power sweep ..... 6.36  
   RF blanking method ..... 4.55  
   RF sweep ..... 4.29, 6.22, 6.35  
   run  
     LF sweep ..... 6.42  
     RF sweep ..... 6.36  
   trigger ..... 6.52  
 SYNC output ..... 1.11  
 Synchronization (IEC/IEEE bus) ..... 5.15  
 Syntax elements (IEC/IEEE bus) ..... 5.12

## T

Terminator ..... 5.13  
 Test points ..... 4.50, 6.8  
 Text parameter ..... 5.10  
 Transmission parameters (RS-232-C) ..... 5.4, 5.29  
 Transmission rate (RS-232-C) ..... 4.44  
 TRIG/STOP input ..... 1.11, 4.35, 4.39  
 Trigger  
   active edge  
     PULSE input ..... 4.16, 4.24, 6.55  
     TRIGGER input ..... 6.55  
   Gate signal ..... 4.16, 4.24  
   list ..... 4.35, 6.53  
   Memory Sequence ..... 4.39, 6.54  
   oscilloscope ..... 4.27  
   pulse modulation ..... 4.16, 4.24, 6.54  
   Sweep ..... 6.52  
   XY recorder ..... 4.27  
 Truth values ..... 5.9

**U**

*Ucor* (level correction)..... 4.8, 6.15  
*Universal commands* ..... 5.27  
*Unlock*  
     *calibration*..... 4.47  
*Unpacking* ..... 1.1  
*User correction (Ucor)* ..... 4.8, 6.15  
*User Request*..... 5.22  
*User Request bit*..... 5.20

**V**

*V/GHz output*..... 1.11, 4.54  
*Value*  
     *change* ..... 3.3  
     *inputs* ..... 3.3  
*VIDEO output* ..... 4.16  
*Voltage*  
     *external modulation signal* ..... 4.11  
     *LF output* ..... 4.21

**W**

*Waveform (LF generator)* ..... 4.13, 4.14, 4.21, 6.40  
*White space* ..... 5.12

**X**

*X-AXIS output* ..... 1.11, 4.27  
*XY recorder*..... 4.27, 6.35

**Z**

*Z-AXIS output* ..... 4.27