



Machine Alignment and Installation

Laser shaft alignment systems for all important steps of machine installation.



E710 / E720

A PRECISION CHOICE

is also a safe choice!

LONG TERM AND RELIABLE



Easy-Laser® measurement systems have been developed from more than twenty five years experience of solving measurement problems for the industry. Our philosophy is that the products we develop must not only have long operating times but also a long lifecycle. We design our products to be robust, with as few small parts as possible. The Easy-Laser® measuring systems can therefore withstand rough handling and work with the greatest precision in the most demanding environments, year after year. Easy-Laser® is a dependable and safe choice from every point of view.

FAST SERVICE AND SUPPORT



Easy-Laser® measurement systems are available from local dealers in more than 70 countries, but there are users to be found in many more countries. For them, professional tools and the best possible support are of great importance, and the same is no doubt true for you as well. Service and repair centres can be found all over the world for your convenience. You can be assured that we will provide you with the fastest and best possible support. Our service department usually takes care of servicing or calibration within five working days. As an extra service, we provide a 48-hour express service for when accidents occur and time is of the essence. Contact us for further information about terms and conditions.

LARGE SAVINGS



Easy-Laser® measurement systems are already extremely flexible in their standard form. By using clever accessories, you can adapt the systems for your own needs, now and in the future as your measurement requirements change. It is cost-effective. Your production capacity increases by being able to measure faster and with greater reliability. Easy-Laser® helps you remedy production errors quickly and easily. This can save you large amounts of money, and your investment can even be repaid within a few months.

EASY-LASER® E720 WITH LASER TRANSMITTER D22

Machine set-up most often starts with the foundation. If the foundation is level and flat you will have less problems with the rest of the installation and alignment of the machine. With Easy-Laser® E720 you not only get all the functions and features for the alignment of the machine, but also possibilities to perform the following:

- Measure the flatness of the foundation
- Check plane parallelism for several surfaces on large machines
- Measure flatness for a single machine foot support surface
- Align the foundation level and plumb
- Align pipes straight and square

The measuring units included with system E720 uses point laser technology. This is one of the reasons it can be used in so many more places in your operations than just to align the shafts of rotating machinery.

Also a standard E710 will provide more measurement and alignment possibilities than a line laser system can, but the key to true versatility is the D22.



Laser transmitter D22 included with system E720 will provide maximum possibilities to set up machines for problem free operation.

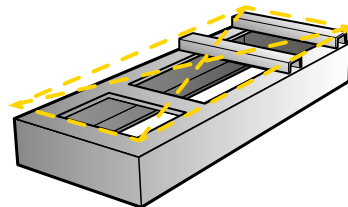

A foundation has to be flat within 0.1 mm/1000 mm to be able to do its job as intended. 0.1 mm is the same as the thickness of a human hair!

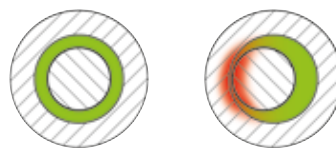

The lubricating film in a bearing is very thin. A machine poorly aligned, or a foundation not supporting the machine in a proper way, will cause increased pressure and overheating of the lubricating film. This will in the end destroy the lubricant, and cause the machine to fail.

SIMPLE AND EFFECTIVE

Easy to use = Fast and efficient!



Easy-Laser® is used to align generators and gearboxes in wind turbines of a number of sizes and makes. Special brackets are available (accessories) for alignment with locked rotors, which increases the safety for the operator.



Engines, gearboxes and propeller shafts on ships are aligned using Easy-Laser® system. Thanks to versatile brackets you can install the equipment in the most appropriate place; shaft, coupling or flywheel.



Easy-Laser® is used to align pumps and motors for all types of industries and installations. Correctly set-up and aligned machines are a requirement for achieving optimum service life and minimal energy consumption.



MAJOR BENEFITS OF ALIGNMENT

You have much to gain in both time and money through having your machines aligned to the correct tolerances. An investment in a laser based alignment system such as Easy-Laser® rapidly pays for itself through lower costs for replacement parts, less downtime and smaller electricity bills. Correctly aligned machines reduce the risk of expensive breakdowns and downtime. The benefits of alignment are many:

- Increased availability and productivity of the machine = *assured production*
- Increased life of bearings and seals = *less use of replacement parts*
- Complete seals = *less leakage and better working environment*
- Optimally utilised lubricant = *less risk of overheating and secondary damage*
- Less lubricant leakage = *less lubricant consumption*
- Reduced friction = *lower energy consumption*
- Less vibration = *reduced noise level*
- Less risk of serious breakdowns = *safer working environment*

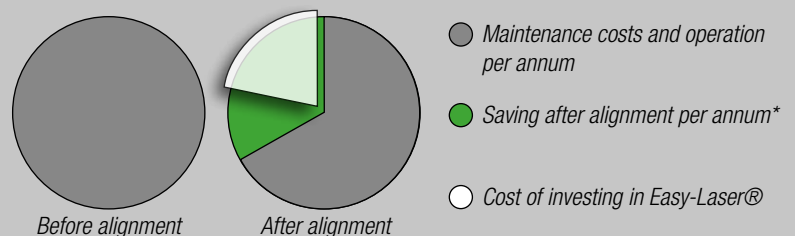

*The diagram is an estimate of the savings/costs relationship and is naturally dependent on the industry.

SHAFT ALIGNMENT

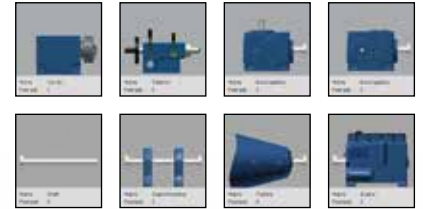

HORIZONTAL MACHINES

Horizontally coupled machines often consist of a pump and motor, but there can also be other types of machine such as gearboxes and compressors. Regardless of what the machine is it is easy to measure and align with Easy-Laser®. The measuring units (M and S) are mounted on each side of the coupling with cable or wireless communication to the display unit. Then follow the step-by-step instructions on screen (see below).



In the Horizontal and Machine train programs, you can choose which machines are to be shown, which side they are on, and specify the number of pairs of feet to correspond with your reality. You can even name the machines individually.

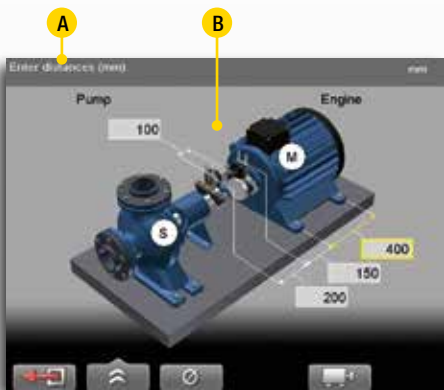
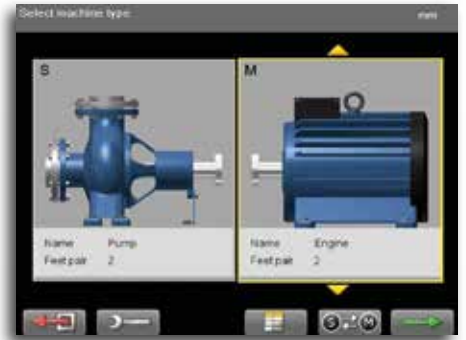

1. Enter the distances between measuring units and the machine feet. If you enter the coupling diameter you can also get the result as gap/sag.

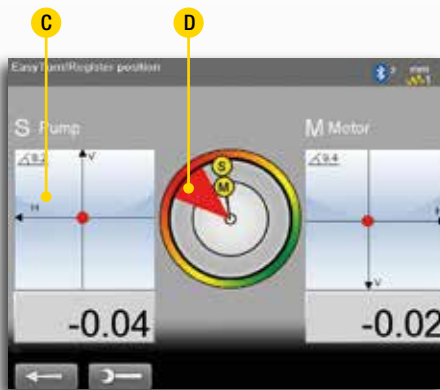

2. Take the measurement values in three positions with as little as 20° between. It is clearly visible on the display when the laser beam hits the detector.

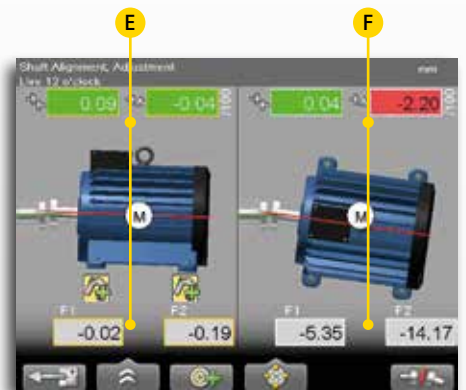

3. The live values are used to adjust the machine. For clarity the adjustment is displayed both graphically and numerically. Horizontal and Vertical directions are shown at the same time.

A. Information field. States what you must do at each stage of the measurement. Also displays Bluetooth® connection, warning symbols etc.

B. You can start from a previous measurement and so avoid re-entering the dimensions, the barcode reader is the fastest method.

C. The detector surface is shown on the screen and functions as an electronic target for the laser beams.

D. 20° marking. The S unit position on the shaft is shown. You can also choose to show the M unit when you align uncoupled machines.

E. Shims values for front and rear pairs of feet. Offset and angular values are colour coded in order to determine the result more quickly: red=outside tolerance, green=inside tolerance.

F. Horizontal adjustment values. Offset and angular values are colour coded.

SOFT FOOT CHECK

Start the alignment work by performing a soft foot check to ensure the machine is resting evenly on all its feet. This is necessary for a reliable alignment. The program shows which foot (feet) should be corrected. After the soft foot check you can go directly to the alignment program with all of the machine's distances saved.

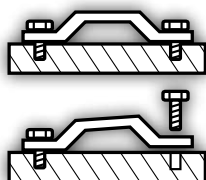

EASYTURN™ AND MULTIPOINT

With the EasyTurn™ function you can start measurement anywhere on the turn. Turn the shafts with the measuring units to three positions in any direction with as little as 20° between to register the measurement value. Measurement is complete! For advanced applications, such as turbines, there is a Multipoint function where any number of measuring points around the whole or part of the rotation can be registered.

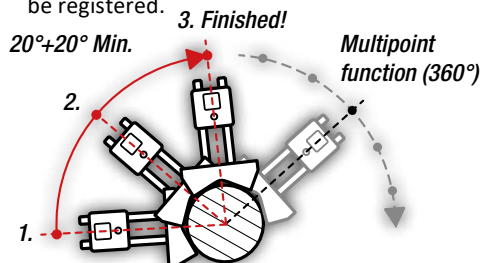

THERMAL GROWTH COMPENSATION

In many cases, the machines (for example a pump and motor) expand considerably from a cold to a hot state (operating temperature). The Thermal Growth Compensation function allows the measurement system to calculate the correct shims and adjustment values even in such cases. The compensation values for the machines are normally supplied by the manufacturers.

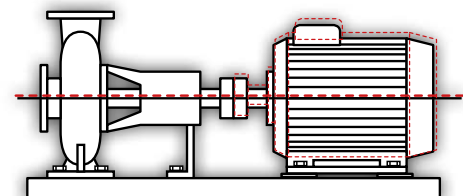



VERTICAL/FLANGE-MOUNTED MACHINES



Alignment of vertical and flange-mounted machines. Shows centre offset, angular error and shim value at each bolt.



CARDAN/OFFSET-MOUNTED MACHINES



Alignment of cardan/offset mounted machines. (Accessory Cardan fixture, Part No. 12-0615 is required.)



MACHINE TRAINS



Regardless of what machines you have and in which order they were assembled, you can build your own machine train with theoretically as many machines as you like. You can pick the reference machine manually, or let the program choose one that will minimize the need for adjustments.



OFFSET AND ANGLE



This program shows centre offset and angular error between two shafts, for example. The values are displayed for both horizontal and vertical direction simultaneously. Can also be used for dynamic measurements.

TOLERANCE CHECK



Measurement results can be checked against pre-defined tolerance tables or values you determine yourself. In this way, you can see immediately whether the alignment is within the approved tolerances. This means the times for alignment are shortened considerably.

LIVE-ANY-ANGLE 360°



This function allows adjustment of the machines live with the measuring units positioned anywhere around the shaft. Good for when machine parts prevent normal adjuster positioning.

REFERENCE FOOT LOCKING



This function allows you to lock any pair of feet on the machine. This gives great freedom when aligning base-bound or bolt-bound machines.

MACHINE FEET CONFIGURATIONS



The software can handle machine design of all types: two pairs of feet, three pairs of feet, pair of feet before the coupling etc.

QUALITY ASSESSMENT



Function in Multipoint measurement that helps you achieve the best possible result during alignment.

MEASUREMENT VALUE FILTER



Advanced electronic filter function that can be used for a reliable measurement result even in a very poor measurement environment, for example where there is air turbulence from open entrances or vibrations from adjacent machines.

SWAP VIEW FUNCTION



Choose from which side you want to display the machine, so it corresponds to your reality. Simplifies the understanding of the adjustment directions.

MANY OPTIONS

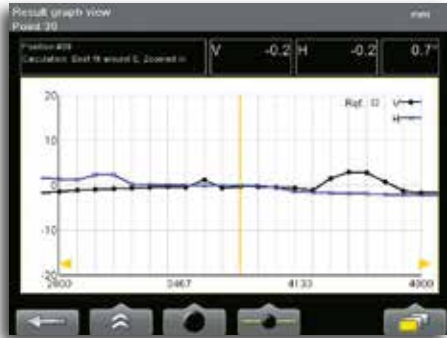

STRAIGHTNESS MEASUREMENT

 With our program for measuring straightness, you can easily measure long shafts, rolls, bearings, bases, machine structures etc. All you have to do is define a number of measuring points, in advance or while measuring. You will be able to get the result for both the horizontal and vertical alignment, graphically as well as digitally. The D22 Laser transmitter included with system E720 will provide even more alignment possibilities for you.

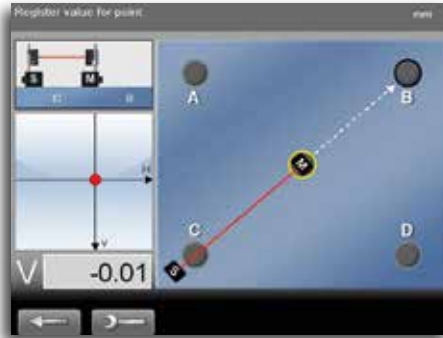
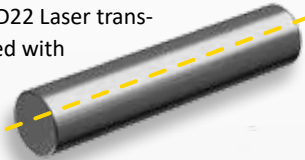

TWIST AND FLATNESS MEASUREMENT

 The twist measurement program allows you to check the flatness or twist of the machine foundation using only the measuring units in the system.

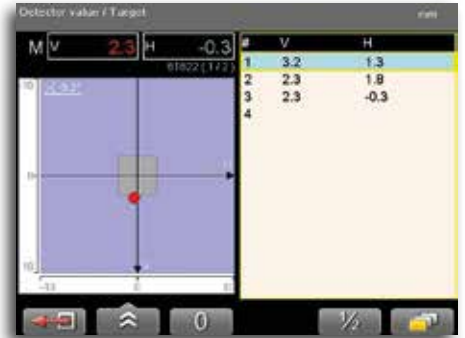
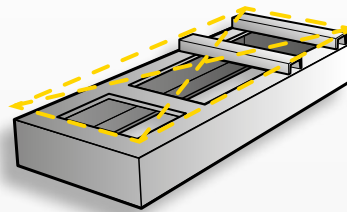

CHECKING BEARING PLAY

 All our measurement systems come with the extremely useful Values program. The program can be used e.g. when one wants to measure as with dial gauges and to check bearing play. With the standard equipment and completely normal set up on the machine!

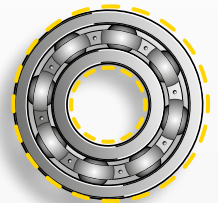

MORE GEO WITH E720

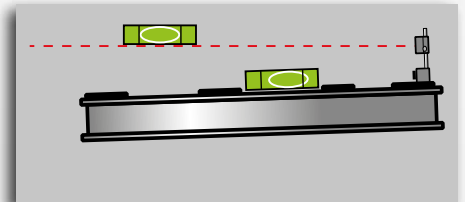

LEVEL

 All machines has to be placed level or plumb for optimum operation, generally speaking.

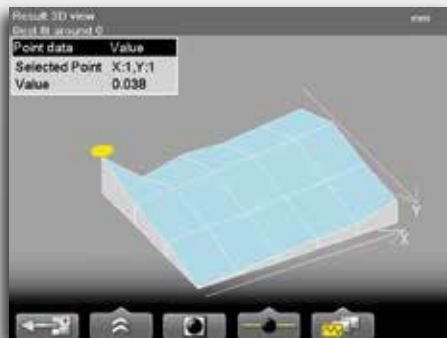

FLATNESS

 The contact surface for a machine has to be flat within 0.1 mm/1000mm.

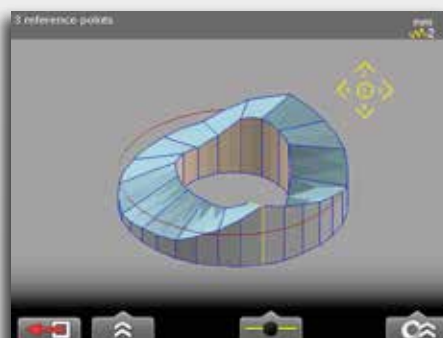

FLANGE FLATNESS

 With this program you can measure sealing surfaces on tanks, heat exchangers and slewing bearings, to mention just a few examples.

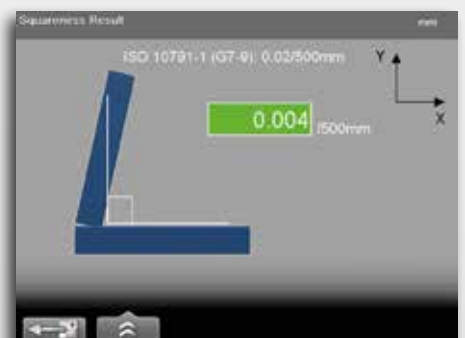

SQUARENESS

 Laser transmitter D22 acts as a digital try square.

DOCUMENTATION

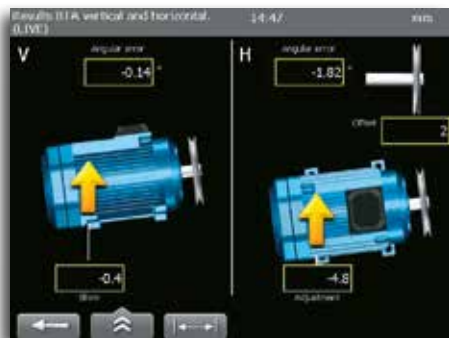

SHEAVE/PULLEY ALIGNMENT

 Using the system you can align sheaves and pulleys with digital precision. Adjustment of the machines is displayed in real time on the screen, with readings for angle and axial displacement in both the vertical and horizontal axes, as well as an adjustment value for the front or rear foot pair. The result can be documented as normal. (Requires the XT190 BTA accessory.)



VIBRATION MEASUREMENT AND BEARING CONDITION

 You can measure vibration levels (mm/s, inch/s) and bearing condition (g-value). The program guides the user through the points to measure on the machine: vertical, horizontal and axial. The result can be documented. (Requires the E285 Vibrometer probe accessory.)



CREATE A PDF REPORT DIRECTLY

When measurement is complete it is possible to generate a PDF report containing graphs and measurement data directly in the measurement system's display unit. All the information about the measurement object is documented, and you can add your company's logo and address details if you so wish.



SAVING IN THE BUILT-IN MEMORY

You can, of course, save all measurements in the display unit's internal memory.

SAVE TO USB MEMORY

You can easily save desired measurements on your USB memory. This enables you to take it to your computer to print reports whilst leaving the measurement system in place.



CONNECT TO YOUR COMPUTER

The display unit is connected to the computer via the USB port. It then appears on the desktop as a USB Mass Storage Device which you can easily transfer files to and from.

EASYLINK™ PC SOFTWARE

With the EasyLink™ database program you can save and organise all your measurements in one place, produce reports with both data and images and export to your maintenance systems. You can customise what your Excel reports should look like and what data should be visible and where it should be positioned. The program has a clear folder structure, where you drag and drop files from the display unit to the database. Create your own structure with folders for manufacturer, department or machine type for example. The database can also be located on a common server and shared with other users. For extra safety you can use EasyLink™ to make backups of what you have saved in the display unit.



BARCODE READER

The barcode reader is used to enter the machine data before measurement is taken. After the first measurement is recorded, the adhesive barcode label is applied to the machine. Next time the machine is checked, the measurements, compensation values and tolerances can be read directly from the barcode. Simple and accurate! (Accessory.)



SYSTEM PARTS

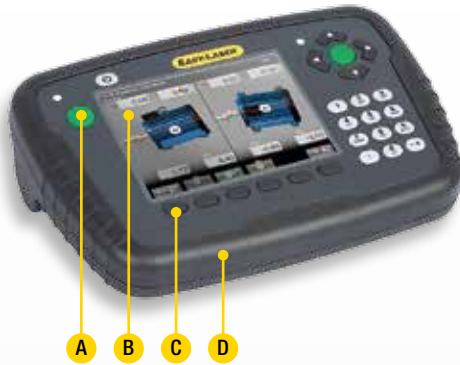

- A. Two Enter buttons, for left and right-handed users
- B. Large, easy to read colour display
- C. Proper buttons for clear feedback
- D. Thin profile gives a perfect grip for your hands

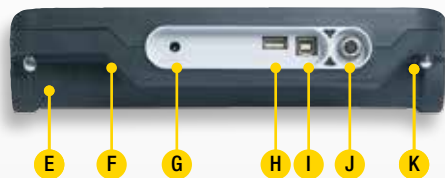

- E. Battery compartment
 - F. Robust, rubber coated design
 - G. Connection for charger
 - H. USB A
 - I. USB B
 - J. Easy-Laser® measurement equipment
 - K. Mounting for shoulder strap
- Note: Dust and splash guards for connectors removed on picture.

DISPLAY UNIT

The display unit enables you to work more efficiently and for longer than ever before. It has wireless technology and integrated rechargeable battery.

NEVER LOSE POWER!

The display unit is equipped with our Endurio™ Power management system. This ensures that you never have to stop in the middle of a measurement because the battery has run out.



PERSONAL SETTINGS

You can create a user profile where you can save your personal settings. You can also have different settings for different types of measurements.

LANGUAGE SELECTION

You can choose the language you want to appear on the screen: English, Spanish, German, French, Portuguese, Chinese, Japanese, Korean, Italian, Dutch, Russian, Polish, Finnish and Swedish are available.

ERGONOMIC

The display unit has a thin, easy-to-grip and rubber coated profile that ensures a secure grip. It has large well-spaced buttons that give clear feedback when pushed. In addition, the two Enter buttons make the system suitable for both right and left-handed users. The display screen has clear graphics that guide you through the measurement process.

UPGRADING

If you wish to expand functionality in the future, the software in the display unit can be upgraded via the internet or by connecting a USB memory containing the new software.

LASER TRANSMITTER D22

Laser transmitter D22 can be used to measure flatness, straightness, squareness, level and parallelism. The laser beam can sweep 360° with a measurement distance of up to 40 metres [130'] in radius. The laser beam can be angled 90° to the sweep, within 0.01 mm/m [0.01 mils/INCH].

The transmitter has many mounting options. Attach it with the three magnetic feet, horizontally or vertically. Attach it with a pin (optional) in the spindle. Or put it beside the machine on for example a tripod (optional).

Laser transmitter D22 is included as standard with system E720, not with E710.

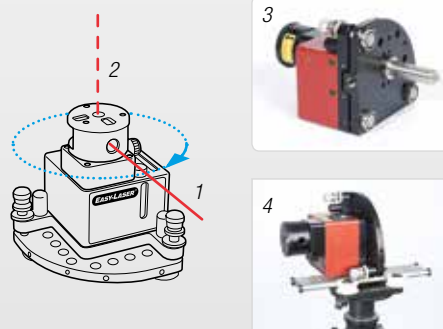

- 1: The laser beam is used for a 360° sweep.
- 2: The laser beam is angled at 90° to the sweep.
- 3. Machine spindle pin; Center attachment.
- 4. Tripod mounting, with horizontal or vertical sweep (accessory)



- A. Laser aperture
- B. Swivelling head
- C. Laser aperture
- D. Leveling screws (x2)
- E. Magnetic feet (x3)

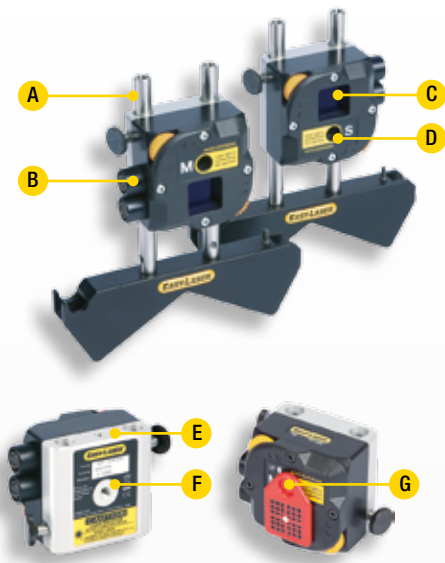

- A. The rods have a height of 60–180 mm. If necessary they can be extended "infinitely" with additional rods. Made of stainless steel.
- B. Well protected connectors
- C. PSD (2 axis)
- D. Laser aperture
- E. Stable aluminium design
- F. Threaded holes for multiple mounting options
- G. Rough alignment target

MEASURING UNITS

The measuring units have large 20 mm [0.78" sq] detector surfaces (PSD for the greatest accuracy) which allows the possibility of measuring at a distance of up to 20 metres [66 feet]. The substantial and rigid design of aluminium and stainless steel guarantees stable measurement values and reliable alignment with the greatest precision in even the toughest of environments. The measuring units are also water and dust proof to classes IP66 and IP67. Connect to the display unit via cable or wirelessly. Both cable and wireless units are connected quickly using Push/Pull connections, no screwing required.

INCLINOMETERS IN BOTH UNITS

With electronic inclinometers in both measuring units the system knows exactly how they are positioned. This also makes it very easy to align uncoupled shafts.

ELECTRONIC TARGETS

Thanks to the two axis detectors you have access to electronic targets, that is you can see on the screen where the laser beams hit.

FLEXIBLE MOUNTING OPTIONS

The thinking behind the rigid and compact design, is that it will simplify positioning and provide varying installation methods. You can measure all types of rotating machine, large and small, equally well, regardless of shaft diameter. The units also have two extra screw holes for additional mounting options.

TWO LASERS, TWO PSD

The so called reversed measurement method with two laser beams and two PSD makes it possible to also measure very incorrectly set machines. This is particularly good for new installations, where the machines are not yet in the correct position.



WIRELESS COMMUNICATION

The unit for wireless communication is easily inserted into one of the connectors on the measuring unit. Wireless connection to the display unit enables you to work more freely. Dust and water proof to IP66 and IP67.



STANDARD BRACKETS INCLUDED IN SYSTEM E710 AND E720



SHAFT BRACKET WITH CHAIN

For attachment around shaft or coupling. Suitable for diameters of 20–450 mm [0.8"–17.7"] with standard chains.



MAGNET BASE

For direct attachment to shaft or coupling. Very strong and stable. Three magnetic sides give flexible positioning possibilities.



OFFSET BRACKET

Allow axial displacement between measuring units in order to be able to rotate past projecting machine parts and connectors.

ACCESSORIES AND EXPANDABILITY



A FUTURE PROOF CHOICE

Easy-Laser® measurement systems are already extremely flexible in their standard form. By using clever accessories, you can adapt the systems for your own needs, now and in the future as your measurement requirements change. It is cost-effective. We have standardised measurements between the mounting holes in the different parts, and often there are mounting holes

on several sides to facilitate mounting on the machine. Experience tells us that this is very much appreciated. A further advantage is that you can use one of the measuring units separately as a detector with, for example, our geometric laser D22. This expands the areas of application of the measurement system. Easy-Laser® is a system that is complete in its full meaning!

MAGNETIC BRACKET



Bracket for axial mounting on flange or shaft end. With four super magnets.
Part No. 12-1011
(Magnetic bracket is standard with E720.)

THIN SHAFT BRACKET



This is used, for example, when there is limited space between the coupling and machine. Thin chain and lock tools included. Width: 12 mm [0.47"]. Part No. 12-0412

SLIDING BRACKET



Used when the shafts cannot be rotated. The spherical feet give a stable position against the shaft. Mounted with standard chains. Part No. 12-0039

MAGNET BASE WITH TURNABLE HEAD



Versatile magnet base with on/off function and 360° turnable head. Perfect for geometric applications. Part No. 12-0045
(Magnet base with turnable head is standard with E720.)

CARDAN BRACKET



For alignment of Cardan/offset mounted machines. Part No. 12-0615

EXTENSION RODS



Screwed together. Extendable theoretically "unlimited".
Length 60 mm [2.36"], (4 x) Part No. 12-0059
Length 120 mm [4.72"], (8 x) Part No. 12-0324
Length 240 mm [9.44"], (4 x) Part No. 12-0060

ADDITIONAL POWER SUPPLY



Chargeable battery pack which gives extra operating time. With or without built-in wireless technology. Part No. 12-0618 or 12-0617

CHARGER 12–36 V



To charge the display unit via 12–36 V socket, for example in a car. Part No. 12-0585

EXTENSION CABLES



Length 5 m [16.4'], Part No. 12-0108
Length 10 m [32.8'], Part No. 12-0180

PROTECTIVE COVER



Protective case for display unit. With shoulder strap. Part No. 01-1379

BARCODE READER



Barcode reader for registration of machine data. Connected in the USB port. Part No. 12-0619

VGA KIT



Makes it possible to show display unit screen image with a projector, for example in a training context. Must be factory installed on order. Part No. 12-0573

EXTENSION CHAINS



Makes it possible to align very large shafts. Length: 900 mm [35.4"], (2 x) Part No. 12-0128

TRIPOD



Tripod for use with laser transmitter D22 or angular prism. Min./Max. height 500–2730 mm [19.7–107.5"]
Part No. 12-0269

MACHINE SPINDLE PIN



For mounting the D22 transmitter in a spindle (or on a magnet base), for example. Clamping pin diameter 20 mm [0.79"], clamping length 60 mm [2.36"]. Part No. 01-1333

DIGITAL LEVEL



Digital precision level. Built-in OLED display and rechargeable battery. Complete kit with charger. Free app available on AppStore for using your smart phone as display unit. Part No. 12-0857

BELT ALIGNMENT



XT190 BTA. Laser transmitter and wireless detector for belt transmission alignment. With built-in display. Use it as a separate tool or connect it to the E720/E710 for extended functionality. Part No. 12-1053

VIBRATION MEASUREMENT



E285 Vibrometer probe. For measuring vibration and bearing condition. For connection to display unit, one of the red cables of system E720/E710 is used. Part No. 12-0656

System	
Relative humidity	10–95%
Weight (complete system)	E710: 10 kg [22 lbs], E720: 14.8 kg [32.6 lbs]
Carrying case, WxHxD	E710: 500x400x200 mm [19.7"x15.7"x7.9"] E720: 550x450x210 mm [21.6"x17.7"x8.3"] Drop tested (3 m/10 feet). Dust and water proof.

Measuring units EM / ES	
Type of detector	2-axis PSD 20x20 mm [0.78" sq]
Resolution	0.001 mm [0.05 mils]
Measuring errors	±1% +1 digit
Measurement range	Up to 20 m [66 feet]
Type of laser	Diode laser
Laser wavelength	635–670 nm
Laser class	Safety class II
Laser output	<1 mW
Electronic inclinometer	0,1° resolution
Thermal sensors	± 1° C accuracy
Environmental protection	IP class 66 and 67
Temperature range	-10–50 °C
Internal battery	Li Po
Housing material	Anodized aluminium
Dimensions	WxHxD: 60x60x42 mm [2.36"x2.36"x1.65"]
Weight	202 g [7.1 oz]

Display unit E51	
Type of display/size	VGA 5.7" colour screen, backlit LED
Displayed resolution	0.001 mm / 0.05 thou
Power management	Endurio™ system for unbroken power supply
Internal battery (fixed)	Heavy duty Li Ion chargeable
Battery compartment	For 4 x R14 (C)
Operating time	Approx. 30 hours (at typical user cycle)
Temperature range	-10–50 °C
Connections	USB A, USB B, Easy-Laser® units, Charger
Communication methods	BT Wireless technology and cable
Internal memory	>100 000 measurements can be saved
Help functions	Calculator, Unit converter
Environmental protection	IP class 65
Housing material	PC/ABS + TPE
Dimensions	WxHxD: 250x175x63 mm [9.8"x6.9"x2.5"]
Weight (without batteries)	1080 g [2.4 lbs]

Wireless units	
Communication method	BT Wireless technology
Temperature range	-10–50 °C
Environmental protection	IP class 66 and 67
Housing material	ABS
Dimensions	53x32x24 mm [2.1"x1.2"x0.9"]
Weight	25 g [0.9 oz]

Cables	
System cables	Length 2 m [78.7"], with Push/pull connectors.
USB cable	Length 1.8 m [70.8"]

Brackets etc. (*only with E720)	
Shaft brackets	Type: V-fixture for chain, width 18 mm [0.7"]. Shaft diameters: 20–450 mm [0.8"–17.7"] Material: anodised aluminium
Magnet bases	Holding strength: 800 N
Offset brackets	Displacement: 32 or 16 mm [1.2" or 0.6"]
Rods	Length: 120 mm, 60 mm [4.72", 2.36"] (extendable) Material: Stainless steel
Magnetic bracket*	With 4 super magnets Material: anodised aluminium
Magnet base with turnable head*	Holding strength: 800 N

EasyLink™ Data base software	
System requirements	Windows® XP, Vista, 7, 8, 10. For the export functions, Excel 2003 or newer must be installed on the PC.

Laser transmitter D22	
Type of laser	Diode laser
Laser wavelength	635–670 nm, visible red light
Laser Safety Class	Class 2
Output	< 1 mW
Beam diameter	6 mm [1/4"] at aperture
Working area, range	40-metre radius [130']
Type of battery	1 x R14 (C)
Operating time/battery	approx. 24 hours
Operating temperature	0–50 °C
Levelling range	± 30 mm/m [± 1.7°]
3 x spirit vials' scaling	0.02 mm/m
Squareness between laser beams	0.01 mm/m [1 arc sec.]
Flatness of sweep	0.02 mm
Fine turning	0.1 mm/m [20 arc sec.]
2 x spirit vials for rotation	5 mm/m
Housing material	Aluminium
Dimensions	WxHxD: 139x169x139 mm [5.47x6.64x5.47"]
Weight	2650 g [5.8 lbs]

System Easy-Laser® E710 Shaft, Part No. 12-0440 includes:	
1	Measuring unit EM
1	Measuring unit ES
1	Display unit E51
2	Wireless units
2	Cables 2 m
2	Shaft brackets with chains
2	Extension chains
2	Magnet bases
2	Offset brackets
4	Rods 120 mm
4	Rods 60 mm
1	Manual
1	Quick reference manual
1	Measuring tape 3 m
1	USB memory with EasyLink™ PC software
1	USB cable
1	Charger (100–240 V AC)
1	Tool box
1	Shoulder strap for display unit
1	Optical cleaning cloth
1	Carrying case

System Easy-Laser® E720 Shaft, Part No. 12-0955 also includes:	
1	Laser transmitter D22
2	Magnetic brackets
4	Rods 120 mm
1	Magnet base with turnable head*

*Note: instead of one of the regular magnet bases listed above.



System E720 pictured.

Easy-Laser® is manufactured by Easy-Laser AB, Alfagatan 6, SE-431 49 Mölndal, Sweden
 Tel +46 31 708 63 00, Fax +46 31 708 63 50, e-mail: info@easylaser.com, www.easylaser.com
 © 2017 Easy-Laser AB. We reserve the right to make changes without prior notification.
 Easy-Laser® is a registered trademark of Easy-Laser AB. Other trademarks belong to the relevant copyright holder.
 This product complies with: EN60825-1, 21 CFR 1040.10 and 1040.11. Contains FCC ID: PVH0946 / IC:5325A-0946.
 Extend the warranty from 2 to 3 years by registering your system on www.easylaser.com
 05-0476 Rev8

<p>CAUTION LASER RADIATION DO NOT STARE INTO BEAM CLASS 2 LASER PRODUCT</p>				
--	--	--	--	--