

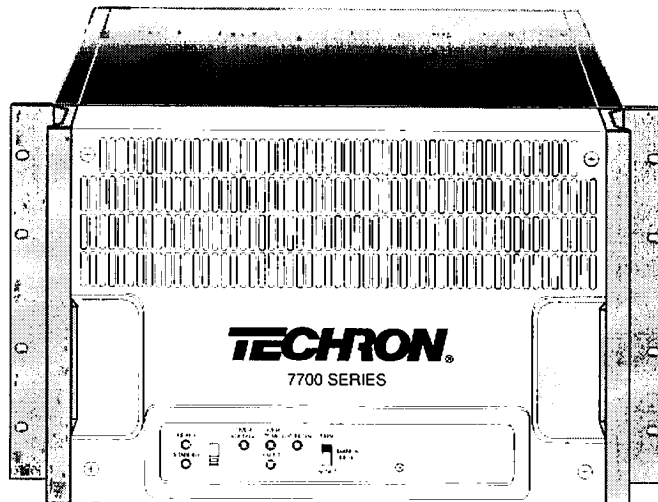


**Advanced Test Equipment Rentals**  
**www.atecorp.com 800-404-ATEC (2832)**



A Division of Crown International, Inc.

## ***User and Service Information***



# ***7700 Series***

## ***Power Supply Amplifiers***



A Division of Crown International, Inc.

**7700 Series**  
**Power Supply Amplifiers**

***Technical Manual***

© 1997 by Techron®, a division of Crown International, Inc.  
1718 W. Mishawaka Road, Elkhart, Indiana, 46515-1000 U.S.A.  
(219) 294-8300

101569-1

Rev.9, 1/97

# **AE TECHRON®**

## **Limited One-Year Warranty**

### **SUMMARY OF WARRANTY**

**AE TECHRON**, of Elkhart, Indiana (Warrantor) warrants to you, the ORIGINAL COMMERCIAL PURCHASER ONLY of each NEW **AE TECHRON** product, for a period of one (1) year from the date of purchase, by the original purchaser (warranty period) that the product is free of defects in materials or workmanship and will meet or exceed all advertised specifications for such a product. This warranty does not extend to any subsequent purchaser or user, and automatically terminates upon your sale or other disposition of our product.

### **ITEMS EXCLUDED FROM WARRANTY**

We are not responsible for product failure caused by misuse, accident or neglect. This warranty does not extend to any product on which the serial number has been defaced, altered, or removed. It does not cover damage to loads or any other products or accessories resulting from **AE TECHRON** product failure. It does not cover defects or damage caused by the use of unauthorized modifications, accessories, parts, or service.

### **WHAT WE WILL DO**

We will remedy, at our sole discretion, any defect in materials or workmanship by repair, replacement, or refund. If a refund is elected, you must make the defective or malfunctioning component available to us free and clear of all liens or other encumbrances. The refund will be equal to the actual purchase price, not including interest, insurance, closing costs, and other finance charges less a reasonable depreciation on the product from the date of original purchase. Warranty work can only be performed at our authorized service centers or at our factory. Expenses in remedying the defect will be borne by **AE TECHRON**, including one-way surface freight shipping costs within the United States. (Purchaser must bear the expense of shipping the product between any foreign country and the port of entry in the United States and all taxes, duties, and other customs fees for such foreign shipments.)

### **HOW TO OBTAIN WARRANTY SERVICE**

When you notify us of your need for warranty service, we will give you an authorization to return the product for service. All components must be shipped in a factory pack or equivalent which, if needed, may be obtained from us for a nominal charge. Corrective actions will be taken within a reasonable time of the date of receipt of the defective product by us. If the repairs made by us are not satisfactory, notify us immediately.

### **DISCLAIMER OF CONSEQUENTIAL AND INCIDENTAL DAMAGES**

You are not entitled to recover from us any consequential or incidental damages resulting from any defect in our product. This includes any damage to another product or products resulting from such a defect.

### **WARRANTY ALTERATIONS**

No person has the authority to enlarge, amend, or modify this warranty. The warranty is not extended by the length of time for which you are deprived of the use of this product. Repairs and replacement parts provided under the terms of this warranty shall carry only the unexpired portion of this warranty.

### **DESIGN CHANGES**

We reserve the right to change the design of any product from time to time without notice and with no obligation to make corresponding changes in products previously manufactured.

### **LEGAL REMEDIES OF PURCHASER**

There is no warranty which extends beyond the terms hereof. This written warranty is given in lieu of any oral or implied warranties not contained herein. We disclaim all implied warranties, including, without limitation, any warranties of merchantability or fitness for a particular purpose. No action to enforce this Warranty shall be commenced later than ninety (90) days after expiration of the warranty period.

**AE TECHRON** Customer Service Department  
2507 Warren St. Elkhart IN 46516-0000 U.S.A.  
(574) 295-9495

---

## ***Introducing the 7700 Series***

The Techron 7700 Series of amplifiers all share the same basic package and circuitry. The uniqueness of each model begins with the model number tag on the back panel designating the particular model. The basic models in the series are the 7780 and 7790. The only difference between these two models is one of operating voltage—the 7780s operate from 208 or 240 volt AC mains, and the 7790s operate from 380 or 415 volt AC mains. Any customization of these basic models results in a model with a new number—e.g. TEC7780RLY. Any model other than the basic models will have a supplemental manual included with this manual.

Some of the features that make this series of amps outstanding are:

- They have the capability to operate either in the Controlled Voltage or Controlled Current mode.
- The very high output (2862 W into 2 $\Omega$ ) over a wide bandwidth (DC to 40 kHz) exceeds most power applications.
- Protection circuitry and strong physical construction of thick aluminum stock dissipates heat and withstands unusual abuse!
- Multiamp systems using electronic interlock cabling allows any amplifier to function as a master or slave which provides power solutions to many previously unsolved power problems.

© 1997 by Techron®  
a division of Crown International, Inc.  
1718 W. Mishawaka Rd., Elkhart, Indiana 46515-1000  
Telephone: (219) 294-8300

---

## **Revision Control**

**Revision**

**Date**

9

January, 1997

**Page Number**

**Revision Number**

Title Page	9
Warranty Page	9
a to b	9
i to vi	8
1-1 to 1-9	8
2-1 to 2-8	8
3-1 to 3-43	8
3-44 to 3-48	9
4-1 to 4-17	8
5-1 to 5-15	8
6-1 to 6-20	8
7-1 to 7-23	8
8-1 to 8-37	8

---

# Contents

**Page**

## **Section 1—Preinstallation**

1.1	Safety Conventions .....	1-2
1.2	Product Description .....	1-3
1.2.1	General Description .....	1-3
1.2.2	General Specifications .....	1-4
1.2.3	Performance Specifications .....	1-5
1.2.4	Front Panel Functions .....	1-6
1.2.5	Back Panel Functions .....	1-7
1.2.6	Main Board Functions .....	1-8

## **Section 2—Installation**

2.1	Unpacking .....	2-2
2.2	Mounting .....	2-2
2.3	Making Connections .....	2-4
2.3.1	Controlled Voltage Hookup .....	2-6
2.3.2	Controlled Current Hookup .....	2-7
2.3.3	Connecting Power .....	2-8

## **Section 3—Applications**

3.1	Introduction .....	3-2
3.1.1	Types of Applications .....	3-2
3.1.2	Special Applications .....	3-2
3.1.3	Applications Connector Table (J3) .....	3-3
3.2	Multiple Amplifier Systems .....	3-4
3.2.1	Principles and Overview .....	3-4
3.2.2	Master/Slave Settings .....	3-5
3.2.3	Output Wiring Principles .....	3-6
3.2.4	Series Systems for Increased Voltage .....	3-7
3.2.4.1	Two-Series Differential-Output .....	3-8
3.2.4.2	Three-Series Differential-Output .....	3-9
3.2.4.3	Four-Series Differential-Output .....	3-10
3.2.4.4	Two-Series Single-Ended-Output .....	3-11
3.2.4.5	Three-Series Single-Ended-Output .....	3-12
3.2.4.6	Four-Series Single-Ended-Output .....	3-13
3.2.5	Parallel Systems For Increased Current .....	3-14
3.2.5.1	Introduction .....	3-14
3.2.5.2	Two-Parallel One-Series .....	3-16
3.2.5.3	Three-Parallel One-Series .....	3-17
3.2.5.4	Four-Parallel One-Series .....	3-18
3.2.5.5	Two-Parallel Two-Series Single-Ended-Output .....	3-19
3.2.5.6	Two-Parallel Two-Series Differential-Output .....	3-20

---

	<i>Page</i>
3.2.5.7 Procedure .....	3-21
3.2.5.6 Troubleshooting a Paralleled System .....	3-29
3.3 Internal Modifications.....	3-30
3.3.1 Status Indicators and Signals .....	3-30
3.3.1.1 External Status Reporting .....	3-31
3.3.1.2 Master Error Reporting .....	3-32
3.3.1.3 Optical Isolator Types .....	3-32
3.3.2 Remote Start.....	3-33
3.3.2.1 Relay Control .....	3-33
3.3.2.2 AC Control with Optical Isolation .....	3-33
3.3.3 Turn-On Delay .....	3-34
3.3.4 Input Sensitivity.....	3-34
3.3.4.1 Maximum Gain .....	3-35
3.3.4.2 Minimum Gain.....	3-35
3.3.4.3 Fixed Gain .....	3-35
3.3.5 Overload Indication .....	3-36
3.3.5.1 Standard Overload Indicator .....	3-36
3.3.5.2 Installing an Overload Latch.....	3-36
3.3.5.3 Reducing Latching Sensitivity .....	3-37
3.3.5.4 Why Install Z505? .....	3-37
3.3.5.5 Why Install C507? .....	3-37
3.3.6 Controlled Current Operation and Compensation .....	3-38
3.3.6.1 CV Versus CC Operation .....	3-38
3.3.6.2 The Importance of Loads in CC Mode .....	3-39
3.3.6.3 Selecting Controlled Current (CC) Mode.....	3-39
3.3.6.4 Compensating the Load for CC Operation .....	3-39
3.3.7 Alternative Supply Voltage .....	3-44
3.3.7.1 208/240 Volts Conversion (Model 7780 only) ...	3-44
3.3.7.2 380/415 Volts Conversion (Model 7790 only) ...	3-46
3.4 Amplifier Accessories List.....	3-48

### ***Section 4—Principles of Operation***

4.1 Principles of Bridge Amplifiers .....	4-2
4.1.1 Output Stage Topology .....	4-2
4.1.2 Output Stage Synchrony.....	4-2
4.1.3 Output Stage Topology .....	4-3
4.1.4 Transistor Topologies .....	4-3
4.1.5 Output Stages .....	4-4
4.1.6 Protection Circuitry .....	4-4
4.2 Input Signal Processing and Current Control .....	4-5
4.2.1 Current Sensing .....	4-5
4.2.2 Controlled Current Compensation .....	4-6

	<i>Page</i>
4.2.3	Current Control Amplifier ..... 4-6
4.2.4	Input Clipper ..... 4-6
4.3	Gain Stages ..... 4-6
4.3.1	Error Amplifier ..... 4-6
4.3.2	Last Voltage Amplifier ..... 4-7
4.3.3	Current Limiting ..... 4-7
4.3.4	Bridge Balance Amp ..... 4-8
4.4	Output Stages ..... 4-9
4.4.1	Output Stage Predrivers ..... 4-9
4.4.2	Output Stage Drivers ..... 4-9
4.4.3	Output Stage Transistors ..... 4-10
4.4.4	Output Stage Bias ..... 4-10
4.4.5	Temperature Sensors ..... 4-11
4.4.6	Output Termination ..... 4-11
4.4.7	Flyback Diodes ..... 4-11
4.4.8	Output Current Sample ..... 4-11
4.5	Protection Circuitry ..... 4-12
4.5.1	Output Transistor Temperature ..... 4-12
4.5.2	Amplifier Disable ..... 4-13
4.5.3	Output Stage Fault ..... 4-13
4.6	Status and Interlock ..... 4-14
4.6.1	Systems Interlock ..... 4-14
4.6.2	Turn-On Delay ..... 4-14
4.6.3	High AC Mains Curoff ..... 4-15
4.6.4	Fault Detection ..... 4-15
4.6.5	Overtemperature Shut Down ..... 4-15
4.6.6	Ready and Standby ..... 4-16
4.6.7	Overload Indicator ..... 4-16
4.6.8	Status Output ..... 4-16
4.7	Power Supplies ..... 4-17
4.7.1	Control Power Supply ..... 4-17
4.7.2	Vcc Power Supply ..... 4-17
<b>Section 5—Troubleshooting</b>	
5.1	Introduction to Troubleshooting ..... 5-2
5.2	Repair Precautions ..... 5-2
5.3	Preparation ..... 5-2
5.3.1	Equipment Requirements ..... 5-3
5.3.2	Make a Thorough Visual Inspection ..... 5-3
5.3.3	Output Continuity Test ..... 5-4
5.3.4	Preparation for Testing Under Power ..... 5-4
5.4	Troubleshooting Guide ..... 5-5



	<i>Page</i>
5.5 Identify Problem with LED Indicators .....	5-6
5.6 No LEDs are Illuminated .....	5-6
5.7 Overvoltage LED Illuminated .....	5-7
5.8 Standby Remains Illuminated.....	5-7
5.9 Missing or Distorted Signals .....	5-8
5.9.1 Missing Signal.....	5-8
5.9.2 Distorted Signal .....	5-9
5.10 Amplifier Overheats .....	5-9
5.10.1 Check for Excessive Power Requirements .....	5-9
5.10.2 Check for Inadequate Air Flow.....	5-10
5.10.3 Check for Defective Thermal Switch or Wiring .....	5-10
5.10.4 Check for Overheating of an Output Well .....	5-10
5.11 Fault LED Illuminated .....	5-11
5.11.1 Identify Defective Output Section .....	5-11
5.11.2 Output Stage Transistor Test .....	5-12
5.12 Final Troubleshooting Procedures .....	5-13
5.12.1 Comprehensive Test and Adjustment .....	5-13
5.12.2 Continuity Check .....	5-14
5.13 Packing and Shipping Instructions.....	5-14

## ***Section 6—Component Removals/Replacements***

6.1 Introduction .....	6-2
6.2 Important Safety Information .....	6-2
6.2.1 Disconnecting Power Supply/Discharging Capacitors ..	6-3
6.2.2 Floating Ground.....	6-3
6.3 Front Panel Removal .....	6-4
6.4 Removal of Rear, Top, Bottom, and Side Panels .....	6-4
6.5 Service of the Output Shelf .....	6-5
6.5.1 Flyback Diode Block, D607 .....	6-7
6.5.2 Current Sampling Resistor Assembly .....	6-7
6.5.3 Servicing Bus Bar Assembly .....	6-8
6.5.4 Heat Sink Shelf Insulation .....	6-8
6.6 Servicing Fans .....	6-8
6.7 Power Supply Rectifier Blocks .....	6-9
6.8 Solid State Relays.....	6-10
6.9 Ribbon Cables Serving J3 .....	6-10
6.10 Servicing Main Circuit Board .....	6-11
6.11 Servicing the Power Supply .....	6-12
6.11.1 Removing Control Transformer & Caps .....	6-12
6.11.2 Servicing the Capacitors .....	6-13
6.11.3 Servicing the Control Transformer .....	6-13
6.11.4 Servicing the Power Transformer .....	6-14

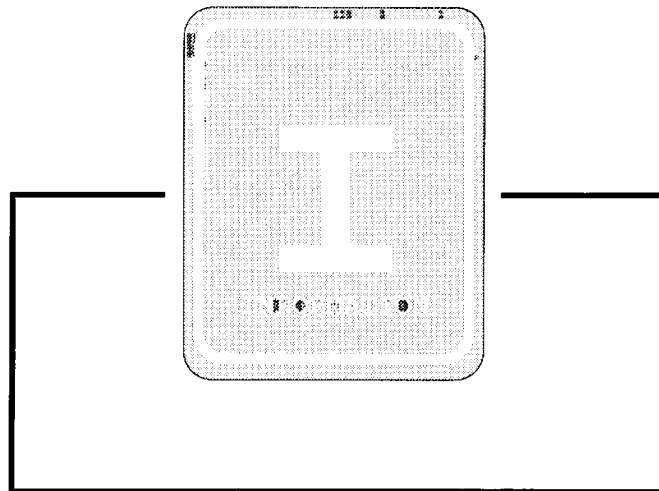
6.12 Servicing the Output Wells .....	6-14
6.12.1 Removing and Installing Output Wells .....	6-15
6.12.2 Replacing Output Transistors .....	6-16
6.12.3 Replacing Driver Transistors .....	6-17
6.12.4 Replacing Emitter Resistors .....	6-18
6.12.5 Electronic Thermal Sensors, Wells 3 & 4 .....	6-18
6.12.6 Thermal Switch, Wells 1 & 2 .....	6-19
6.12.7 Bias Servo Transistor, Wells 1 & 4 .....	6-20

### ***Section 7—Testing and Adjustment***

7.1 Preparation for Testing .....	7-2
7.1.1 When To Perform Tests .....	7-2
7.1.2 Equipment Requirements .....	7-3
7.1.3 Pretest Procedure .....	7-4
7.1.4 Power Supply Pretest .....	7-5
7.2 General Amplifier Test .....	7-7
7.3 Adjust Current Monitor Zero .....	7-8
7.4 Adjust Output Offset Voltage .....	7-8
7.5 Adjust Multiplier Zero .....	7-9
7.6 Adjust High Voltage Cutoff .....	7-10
7.7 Adjust Static Balance .....	7-10
7.8 Adjust Output Stage Bias .....	7-11
7.9 Adjust CMRR on Input Amplifier .....	7-12
7.10 Adjust CMRR on Current Amp .....	7-12
7.11 Adjust Current Monitor .....	7-13
7.12 Adjust Voltage Gain .....	7-14
7.13 Adjust Dynamic Balance .....	7-15
7.14 Verify Overload Latch .....	7-16
7.15 Adjust Current Limit .....	7-16
7.16 Spurious Response .....	7-17
7.17 Verify Controlled Current Mode .....	7-18
7.18 Measure IMD .....	7-19
7.19 Measure Output Voltage Noise .....	7-19
7.20 Measure Current Monitor Noise .....	7-20
7.21 Verify Fault Circuit Operation .....	7-20
7.22 Verify Thermal Switch Operation .....	7-21
7.23 Verify Die Thermal Protection .....	7-21
7.24 Verify Interlock .....	7-22
7.25 Check Master/Slave Mode .....	7-22
7.26 Verify Remote Ready Status .....	7-23
7.27 Final Procedure .....	7-23

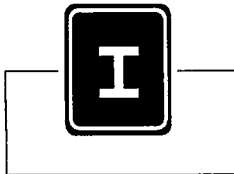
---

	<b>Page</b>
<b>Section 8—Parts and Schematics</b>	
8.1 General Parts Information .....	8-2
8.2 Standard and Special Parts .....	8-2
8.3 Ordering Parts .....	8-2
8.4 Shipment .....	8-3
8.5 Terms .....	8-3
8.6 Chassis Exploded View .....	8-4
8.7 Output Heat Sink Mounting .....	8-8
8.8 Heat Sink Shelf .....	8-9
8.9 Power Supply .....	8-12
8.10 Schematic Parts List .....	8-14
8.11 Printed Circuit Boards .....	8-27
7700 Series Amplifier Block Diagram .....	8-30
Schematics .....	8-30
Front End .....	8-31
Gain Stages .....	8-32
Protection Circuit .....	8-33
Power Supply .....	8-34
Status and Interlock .....	8-35
Output Stages .....	8-36
Interconnect Board .....	8-37



## ***Section 1—Preinstallation***

This section describes safety conventions used within this document and provides essential information about the 7700 series amplifier. Review this material before installing or operating the amplifier.





---


## 1.1 Safety Conventions

The 7521/7541 amplifier is a highly sophisticated instrument. Accordingly, this document provides full information on the amplifier including service procedures. Safety should be your primary concern as you use this product and follow these procedures.

Special hazard alert instructions appear throughout this manual. Note the following examples:

	<b>DANGER</b>
<p>DANGER represents the most severe hazard alert. Extreme bodily harm or death <b>will</b> occur if these guidelines are not followed. Note the explanation of the hazard and instructions for avoiding it.</p>	

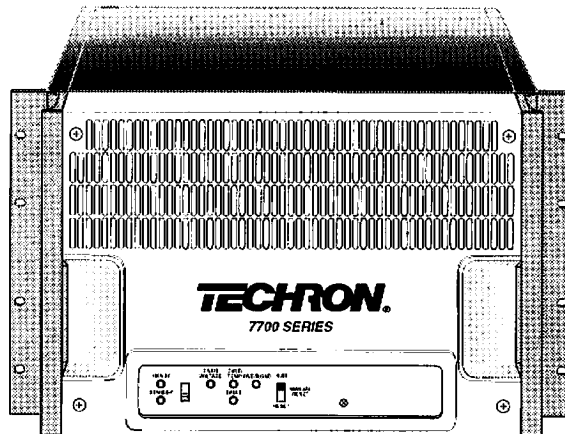
	<b>WARNING</b>
<p>WARNING alerts you to hazards which <b>could</b> result in severe injury or death. Note the explanation of the hazard and the instructions for avoiding it.</p>	

	<b>CAUTION</b>
<p>CAUTION indicates hazards which could result in potential personal injury or equipment or property damage. Once again, note the explanation of the hazard and the instructions for avoiding it.</p>	

**Note:** A Note represents information which needs special emphasis but does not represent a hazard.

---

## 1.2 Product Description



### 1.2.1 General Description

The *TECHRON*® amplifiers in the 7700 series are single channel industrial amplifiers designed for use in the most demanding high power systems. They provide precision amplification of frequencies from DC to 40 KHz, with low harmonic and intermodulation distortion and low noise. The basic models in the series are the 7780 and 7790. The 7780s operate from 208 or 240 volt AC mains, and the 7790s operate from 380 or 415 volt AC mains.

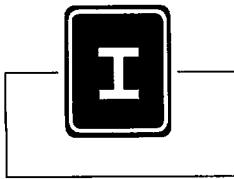
The CROWN® developed full bridge circuit enables the high output levels of the 7700. The output transistors operate in the AB+B mode, where all quiescent current is carried by the driver transistors. The output section uses 80 rugged 150 watt transistors, plus eight 150 watt driver transistors. All these transistors are tested and graded to insure consistent operation.

Protection circuitry monitors output signal, temperature of output transistor junctions, and history of output signal, allowing full-powered output at any time and for as long as output transistors are not in danger of destruction. Both electronic and bimetal heat sensors are included in the output heat sinks, for immediate protection and fast recovery in the event of overheating.

A self-contained, forced air cooling system includes four fans with air filters, and enables the 7700 to be rack-mounted without extra space above and below each unit. Air is taken in through side panels and exhausted via a front panel grill.

The output section and main circuit board are constructed as modules. This enables rapid and accurate servicing. Front panel indicators give you information on Overload, Overvoltage, Overtemp, Standby, Ready, and Fault conditions. Multiamp systems are easily constructed with an electronic interlock system which allows any amplifier to function as a master or slave. Simply set a switch and properly connect output and interlock cables.

All Techron amplifiers are tested at the factory to assure operation at full efficiency upon delivery. Custom configurations are available, as well as full system implementations.



---

## 1.2.2 General Specifications

**Power Requirements:** (See back panel voltage tag for what voltage it is wired) The 7780s have internal wiring options of 208 or 240 volts drawing as much as 20A. The 7790s can operate from 380 or 415 volt, 10A ac mains. Both models require a 3-phase, 47 to 69 Hz source.

A toggle switch circuit breaker opens all legs of the ac mains on excess current demand. The rating is 20A for 208 and 240 volt units, and 10A for 380 and 415 volt units.

**Power Supply:** Each unit has high voltage ( $\pm 146$  VDC), and low voltage ( $\pm 15$ ,  $\pm 24$ , and  $+5$  VDC) supplies.

**Protection Mechanisms:** High line voltage or over-heating results in the shutdown of the high voltage transformer. Main transformer and output heat sinks include thermal switches for protection against high temperature. The amplifier automatically returns to normal operation after heat-related shutdown. Controlled slewing rate protects against RF burnouts. High input resistance protects against overloads at the input. Patented Self Analyzing (SA) temperature sensing in the output stage limits current to prevent transistor damage.

**Cooling:** Forced air cooling via four 100 ft<sup>3</sup>/min. fans. Air intake is at both sides of the amplifier with discharge through the front grill. No space is required between rack-mounted amplifiers. Air filters are removable from the rear via one fastener per side and may be eliminated if cabinet filtration is provided.

**Heat Sinking:** Four high efficiency H-section heat sinks enable even and efficient cooling of the output section.

**Displays:** Six front panel LEDs indicate the amplifier's status.

- READY (green)
- OVERVOLTAGE (amber)
- FAULT (red)
- STANDBY (yellow)
- OVERTEMP (amber)
- OVERLOAD (amber)

**Connectors:**

- AC line: NEMA style twist-lock, three phase connector.
- Input: 3-terminal barrier block (Twin BNC optional).
- Output: 4-terminal barrier block, accepts up to #4 AWG wire.
- System Interconnect (Interlock) and custom interface: 37-pin D-sub.

**Construction:** Aluminum chassis has steel reinforcements to retain power transformer. Internal modules are easily accessible with covers removed. Finish is black except for 2-tone brown front panel (custom colors available).

**Mounting:** Standard 19-inch rack mounting is provided by the front panel. Some means of supporting the weight at the back is strongly recommended. Fully extendable, pivoting rack slides are available as an option.

**Dimensions:** Unit occupies six EIA 19 in. wide rack units, is 10.45 in. (26.6cm) high, 20.3 in. (51.5 cm) deep, and extends 2.5 in. (6.4cm) from the front mounting surface.

**Weight:** 128 lb (58 Kg)

---

### 1.2.3 Performance Specifications

(These specifications apply to Controlled Voltage mode only.)

A 7700 series amplifier may function as an individual amplifier or as a module in a multiamp system. These specifications describe a stand-alone amplifier. See Section-3 *Applications* regarding multiamp systems.

The amplifier is capable of operating in one of two modes: Controlled Voltage or Controlled Current. Since the performance in Controlled Current mode is dependent on application—and these applications are seldom identical—the following specifications apply to Controlled Voltage mode only except where noted otherwise.

**Power at Clip Point:** (with <0.1% THD)

- 1550 watts rms into 4 ohms
- 2862 watts rms into 2 ohms
- 5000 watts rms into 1 ohms.

**Power Response:**

- 214 volts **P-P** into 2 ohms
- 75.6 volts **rms** into 2 ohms
- 107 amperes **P-P** into 2 ohms
- 37.8 amperes **rms** into 2 ohms.

**Bandwidth:** DC to over 40 kHz; in some applications, to over 200 kHz.

**Amplifier Gain:** 20 V/V in CV mode, 20 A/V in CC mode.

**Input Impedance:** 20 k $\Omega$ , differential.

**Input Sensitivity:** 3.0 V input for 3800 W output into 1 $\Omega$  (adjustable).

**Intermodulation Distortion:** <0.05% from 1.55 to 1550 watts into 4 ohms.

**Hum and Noise:** (DC -100 kHz): <1 mV.

**Slew Rate:** 46 V/ $\mu$ s.

**Common Mode Rejection Range:**  $\pm$ 11 Vdc maximum.

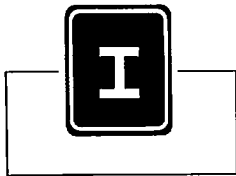
**Common Mode Rejection Ratio:** 70 dB.

**Output Load for Max Performance:** 0.75 $\Omega$  to 2.2 $\Omega$ .

**Voltage Monitor:** 1 V/V from an unbalanced output terminal on the main board isolated through 10 k $\Omega$ .

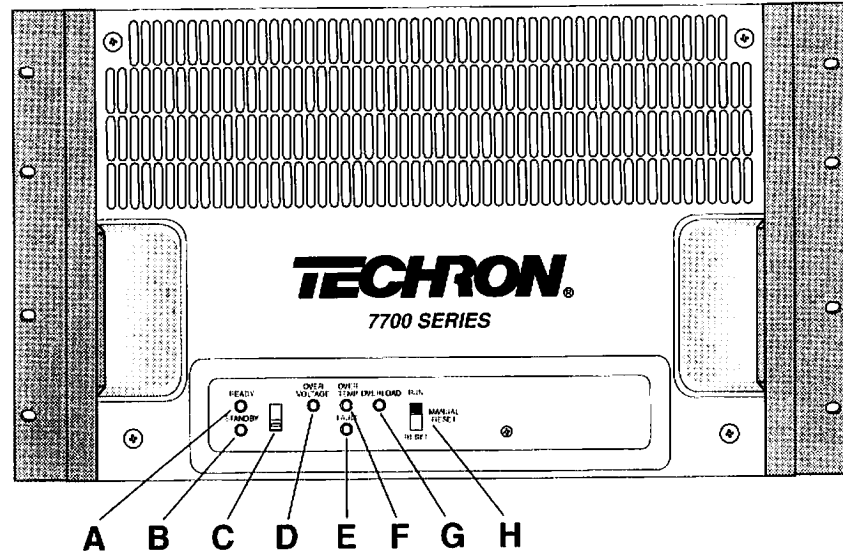
**Current Monitor:** 20 A/V from a 1 k $\Omega$  unbalanced output terminal on the main board.





## 1.2.4 Front Panel Functions

The following illustration has captioned call-outs providing a visual location of the 7700 front panel functions.



### A. Ready Indicator; B. Standby Indicator

Only one of these two LEDs should be on at one time. The Ready green LED shows that the 7700 is available and will amplify the input signal. The Standby yellow LED shows that the amplifier is in Standby mode.

### C. Ready/Standby Switch

This switch controls power to the output stage of the amplifier and any slave amplifier connected to it in a multiamp, Master/Slave system.

### D. Over Voltage Indicator

This amber LED indicates high voltage (>10% above normal) in the 3-phase, AC mains. This condition always puts the 7700 into Standby.

### E. Fault Indicator

If this red LED is on, an abnormal current condition exists in the output stage. To clear the Fault condition, cycle the AC power. If the fault condition remains, the 7700 has suffered some serious internal damage.

### F. Over Temperature Indicator

This amber LED alerts you to an over-temperature condition in the main power transformer or on the output stage heat sinks. The 7700 automatically switches to Standby until the temperature returns to normal.

### G. Overload Indicator

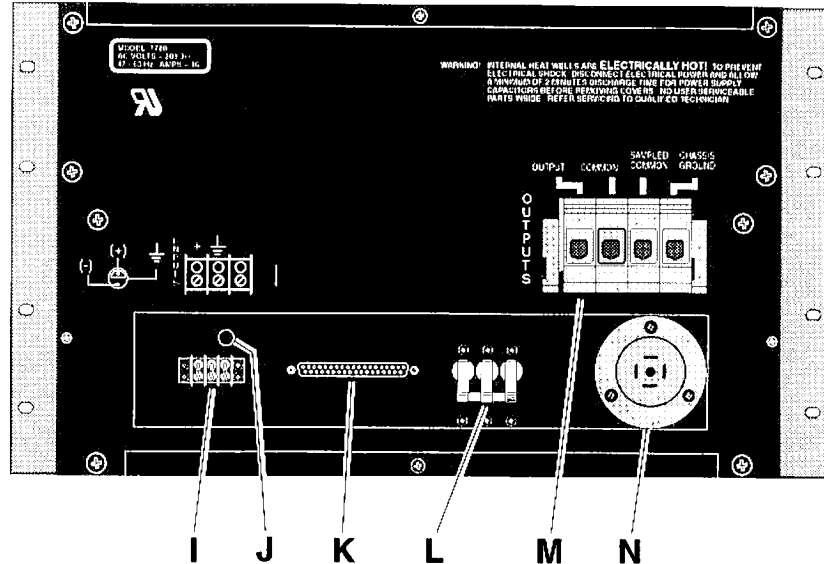
This amber LED is on when distortion exists. The overload circuitry shows if the output of the amplifier does not follow the input signal.

### H. Run/Reset Switch

This spring-loaded switch, normally in the RUN position, provides momentary RESET. It clears the OVERLOAD indicator.

## 1.2.5 Back Panel Functions

The following illustration has captioned call-outs providing a visual location of the 7700 back panel functions.



### I. Barrier Block Input (J2)

This standard input allows differential or single ended connection and saves you a connector and is more perminate.

### J. Optional Twin BNC (J1)

This input option is quicker to connect and disconnect and provides differential input. Single ended BNC is also available.

### K. Interlock Connector (J3)

Use this 37 pin D-sub connector for interlocking and combining functions in a system of multiple amplifiers. The spare pins can be used in custom interface applications. See Section-3 *Applications* for a complete pin-out description and use of this connector.

### L. AC Mains Switch/Circuit Breaker

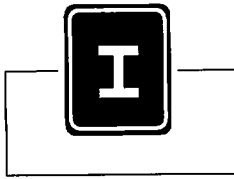
The dual function power switch and circuit breaker opens all legs of the ac mains. The rating is 20A for 208 and 240 volt units, and 10A for 380 and 415 volt units.

### M. Output Terminal Block

Connect output lines from the load to this 4-terminal barrier block. It accepts up to #4 AWG wire.. When operating in the Controlled Current mode, use only the **Output** terminal and the **Sampled Common** terminal for driving the load.

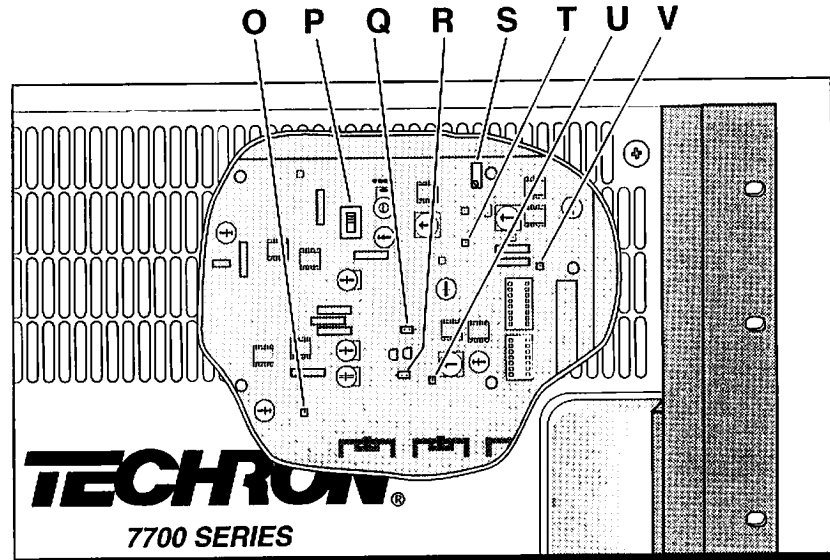
### N. AC Power Connector

This is a NEMA style twist-lock, three phase connector. See the Power Supply schematic in the back of the manual for terminal connections.



## 1.2.6 Main Board Functions

The following illustration, showing the main board behind the front panel, has captioned call-outs providing a visual location of main board functions.



### O. Voltage Monitor (T104)

The output voltage of the amplifier may be observed by connecting an oscilloscope and/or voltmeter from T104, amplifier output, to T105 (T), ground. This test point reads voltage directly and is isolated by 10 k $\Omega$ .

### P. Master/Slave Switch (S100)

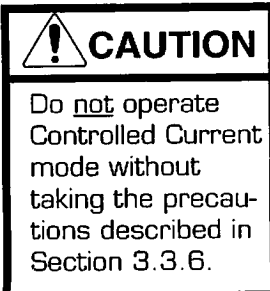
When the 7700 is used as a single amplifier or as a master in a multiamp system, input is through the 3-terminal barrier block J2, then, the Master/Slave switch S100 is in the Master (up) position. When the amplifier is used as a slave in a multiamp system, input is through the interface connector J3, then, the Master/Slave switch S100 is in the Slave (down) position. More information on master/slave operation is contained in Section-3 *Applications*.

### Q. CC/CV Jumper (B5)

This jumper goes left for CV (Controlled Voltage) mode and right for CC (Controlled Current) mode. By placing the jumper on the left pair of pins, the amplifier's output voltage will be controlled by its input voltage signal. By placing B5 on the right pair of pins, the output current will be controlled by the input voltage signal. See section 3.3.6.

### R. Compensation Jumper (B6)

When the 7700 is used in the CC mode as a controlled current amplifier, the current control loop is optimized with an RC network. The main board has provision for two of these networks. When B6 is on the left pair of pins, the network R109, C104 and C105 is selected. When B6 is on the right pair of pins, the alternate network R108 and C103 is selected. See Section-3 *Applications* for compensation details.



---

### **S. Sensitivity Control (R105)**

The input sensitivity of the 7700 may be trimmed by the adjustment of R105. That adjustment will trim the input sensitivity a few percent of voltage gain. Replace fixed resistors to affect a greater change. See section 3.3.4 for details.

### **T. Circuit Ground (T105)**

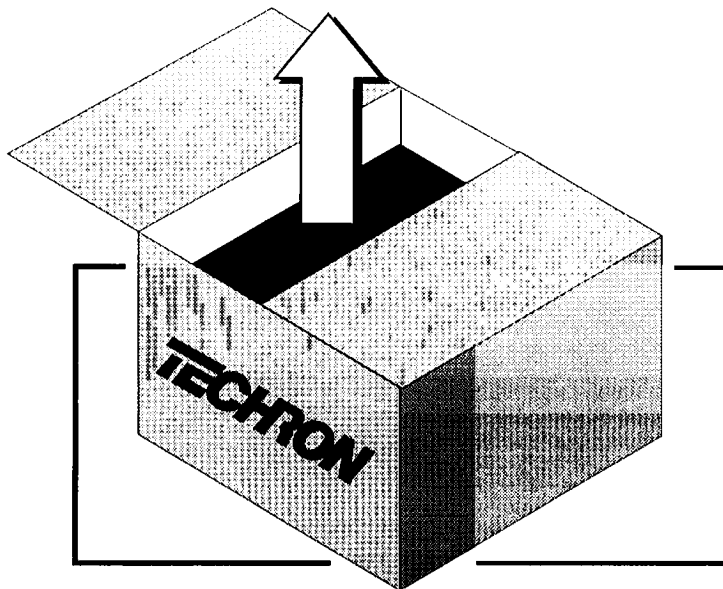
This is the main circuit board ground which originates from the low voltage power supply.

### **U. System Current Monitor (T101)**

T101 is a monitoring point for system current when two or more amplifiers are in parallel.

### **V. Current Monitor (T103)**

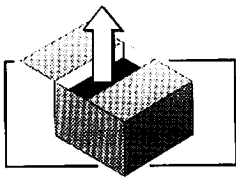
The current monitor is an active buffered output that may be observed with monitoring equipment. The scale factor is 20 amps per volt. Use T105 (T), ground, with T103 to monitor amplifier output current.



---

## ***Section 2—Installation***

This section provides general guidelines for installing the 7700 series amplifier with special emphasis on system installations.



## 2.1 Unpacking

Every TECHRON amplifier is carefully inspected and tested prior to leaving the factory. Besides the amplifier, you should find this manual, a "Getting Started" pamphlet, a NEMA style AC mains connector, and a 37 pin D-sub connector in the package.



### WARNING

Never attempt to lift the amplifier without assistance. Crushing bodily injury can result if care is not taken during installation. Cabinets may overturn if not secure.

Carefully unpack and inspect the unit for damage in shipment. If damage is found notify the transportation company immediately. Save the shipping carton and packing materials as evidence of damage for the shipper's inspection. TECHRON will cooperate fully in the case of any shipping damage investigation. In any event, save the packing materials for later use in transporting or shipping the unit. Replacement packing materials are available from TECHRON. Never ship this unit without proper packaging.

## 2.2 Mounting

The 7700 series mounts in a standard 19-inch rack. The illustration below shows the mounting dimensions. Allow an additional two inches behind the output connector box on the back panel for connecting cables.

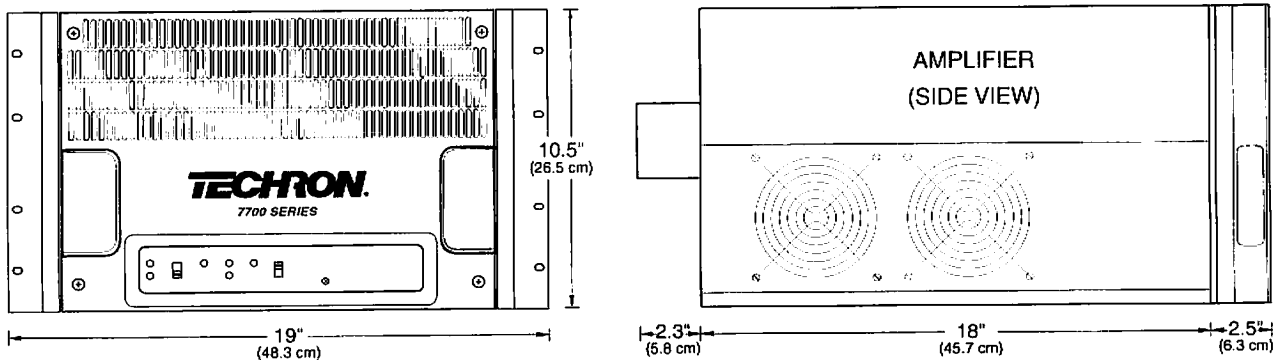


Illustration 2-1 Mounting Dimensions



## CAUTION

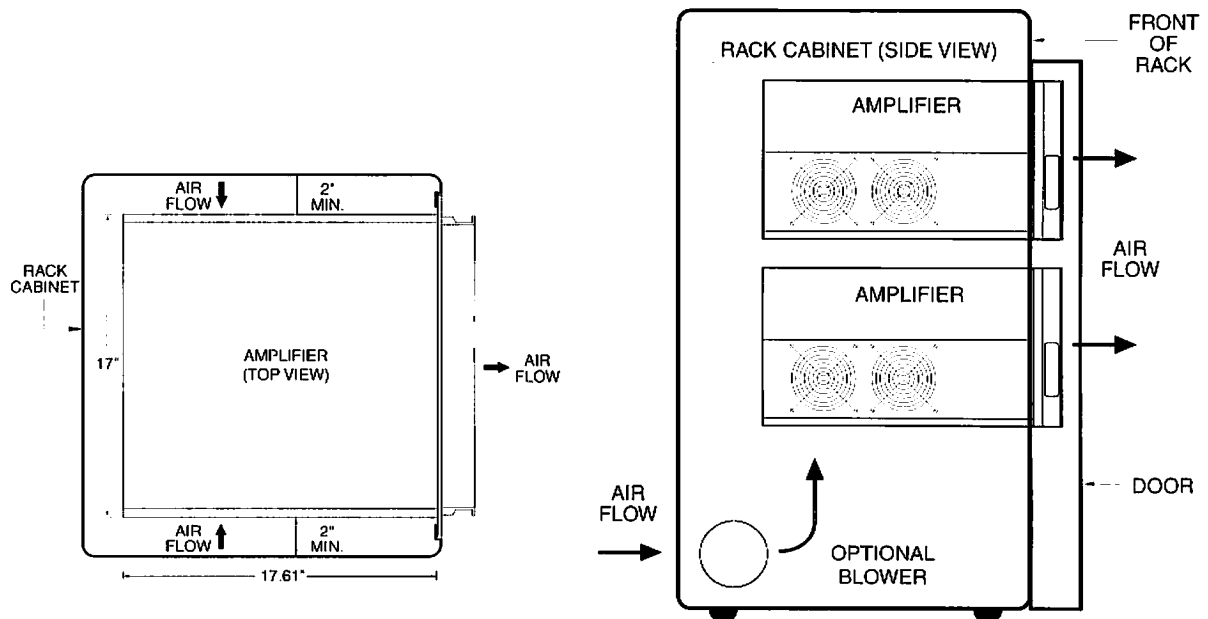
Do not operate the amplifier in a small sealed chamber of any kind. Improper operation and overheating will result.

Take these additional precautions during installation:

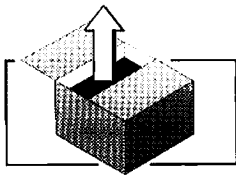
1. Add additional internal support at the back of the amplifier attached to the rack such as angle iron to support the amplifier from beneath.

**Note:** The Model 7700 weighs over 130 pounds. Be sure weight is properly supported.

2. When mounting the amplifier in a rack cabinet, the side walls of the rack must be at least 2 inches away from the chassis as shown in the illustration below.
3. Allow for hot air discharge through the amplifier's front grill (see illustration below). If your cabinet has a front door, you must provide adequate air flow through the door. Provide a source of cooling air for fan intakes. If the rack is crowded or rack ventilation is poor, use a vent tube to the outside of the rack. Cooling capacity required is 300 ft<sup>3</sup>/min. total per amp.
4. When operating the 7700 in a dusty environment, use commercial furnace filters or equivalent to prevent rapid clogging of the filters on the amplifier.



**Illustration 2-2 Rack Cabinet Air Flow**



## 2.3 Making Connections

Before connecting the amplifier, please note the following:

- Remove all power from the unit. Do not have the AC cord plugged in.
- Change the default settings on the main board behind the front panel if your hookup is for Controlled Current and/or Slave operation (see Section-1.2.6 *Main Board Functions* for location of these controls).

Use care in making connections, selecting signal sources, and controlling output level. The Model 7700 protects itself thoroughly, but is capable of causing serious damage through improper connections and inadequate loads.

During hookup take the following precautions:

1. Use only shielded cable on inputs. Do not short the input signal ground to the ground lead of an output cable—oscillations may result. Keep unbalanced input cables as short as possible—avoid lengths greater than 10 feet. Input connection can be either differential or single ended. See the illustrations below for recommended connections.

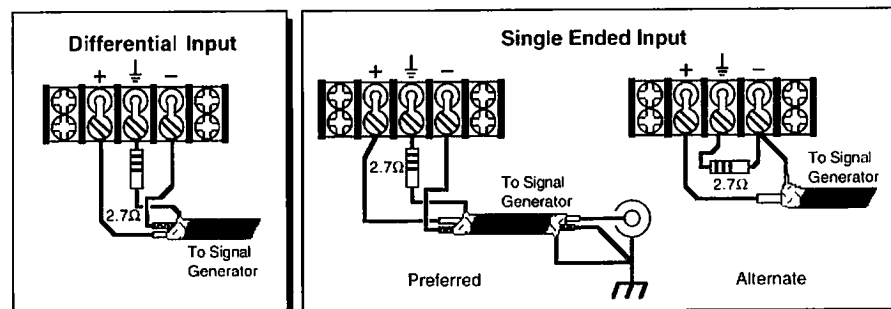


Illustration 2-3 Input Connections

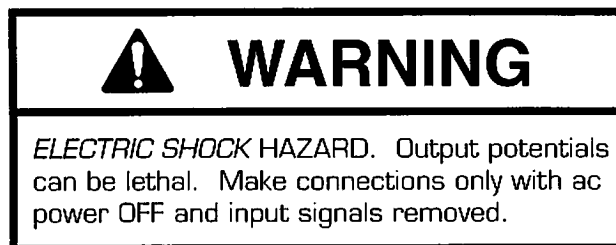
2. The output wire and connectors should be heavy enough to carry the intended current to the load.
3. Do not run signal (input) cables together with high level wiring such as load (output) wires or AC cords—this helps avoid most hum and noise.
4. Never *directly* parallel the output of the 7700 with the output of any other amplifier. This connection may cause serious damage to the amplifier and/or load and will not result in increased power output. If output current boosting is needed, see Section-3 *Applications*.
5. Do not short the COMMON output terminal to the SAMPLED COMMON output terminal. Unreliable operation will result.
6. Never *directly* connect the output to a power supply output, battery, or AC main. These connections will cause serious damage to the amplifier.
7. Always operate Model 7700 from proper ac mains. Depending upon the wiring configuration of your particular unit (see the back panel), the 3-phase, 47 - 63 Hz voltage must be either 208/240 Vac for 7780s, or 380/415 Vac for 7790s, with no more than 10% tolerance above or below the line voltage. The amplifier will not operate properly outside these limits.



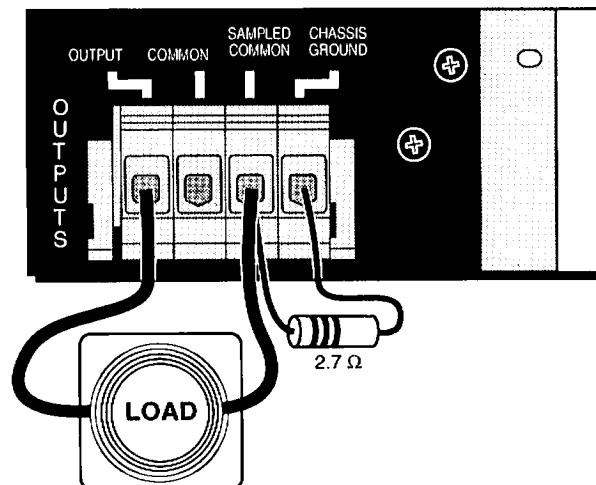
A persistent problem in the application of power amplifiers is unintended feedback of output signal into the input signal resulting in oscillations. Oscillations will distort the intended signals and subject the output transistors to additional stress. The cause begins with the power transformer.

To provide isolation between the dc supply and ac primary circuits, a Faraday shield is placed in the power transformer between the primary and secondary windings. This shield is attached to the chassis. The current which charges the capacitance between the secondary and the Faraday shield must complete a circuit somewhere. Ideally this circuit will be completed at the amplifier and not through connection cables. The preferred location is at the back panel between the Sampled Common or Common terminals and the chassis.

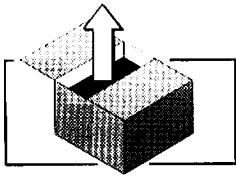
If intentional means are not provided for this returned current, it may return to the amplifier through some path such as an input or control cable. In applications where a direct connection of the Sampled Common or the Common terminal to chassis is not possible because of ground loop problems, a low inductance type resistor valued between 1 to 5 ohms may be connected from Common or Sampled Common to the chassis (see illustration below).



To make connections to the output terminal block (shown below), remove the protective cover. The purpose of this cover is not only to protect you and others from accidentally touching the terminals during operation, but also, to protect the fragile module to which it is connected. It is particularly important when transporting or shipping the amplifier that this cover be in place.



**Illustration 2-4 Output Connections**



### 2.3.1 Controlled Voltage Hookup

The amplifier comes from the factory in the Controlled Voltage (CV) mode. See "Q" in Section 1.2.6 for position of mode change jumper (B5). The illustration below shows the hookup to J2 as a differential input. See the previous section for single ended input options. In the CV mode the negative terminal of the load can be connected to the COMMON or SAMPLED COMMON terminal, but not both. The load's positive terminal is connected to the amplifier's OUTPUT terminal.

**Note:** The current monitor depends on the feedback from the Sampled Common terminal, so it will not work if the Common terminal is used.

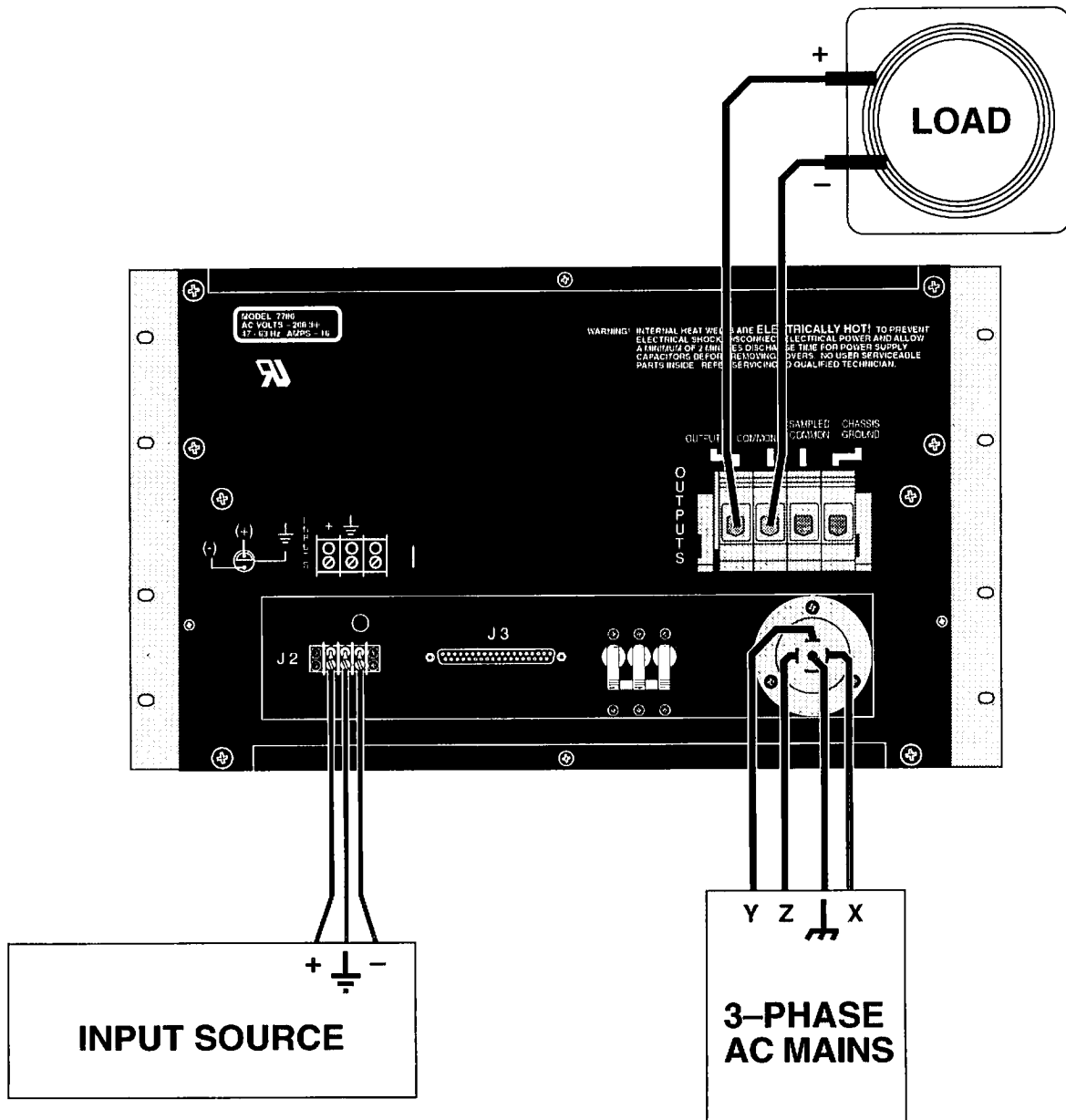


Illustration 2-5 Controlled Voltage Hookup

## 2.3.2 Controlled Current Hookup

In Controlled Current mode use the OUTPUT and SAMPLED COMMON output block terminals only. Do not use the COMMON terminal in Controlled Current (CC) mode. Place the main board mode jumper (B5) in the Controlled Current mode position (see "Q" in Section 1.2.6 for position of mode jumper (B5)).

**Note:** Please read Section 3.3.6 *Controlled Current Operation and Compensation* before operating in CC mode!

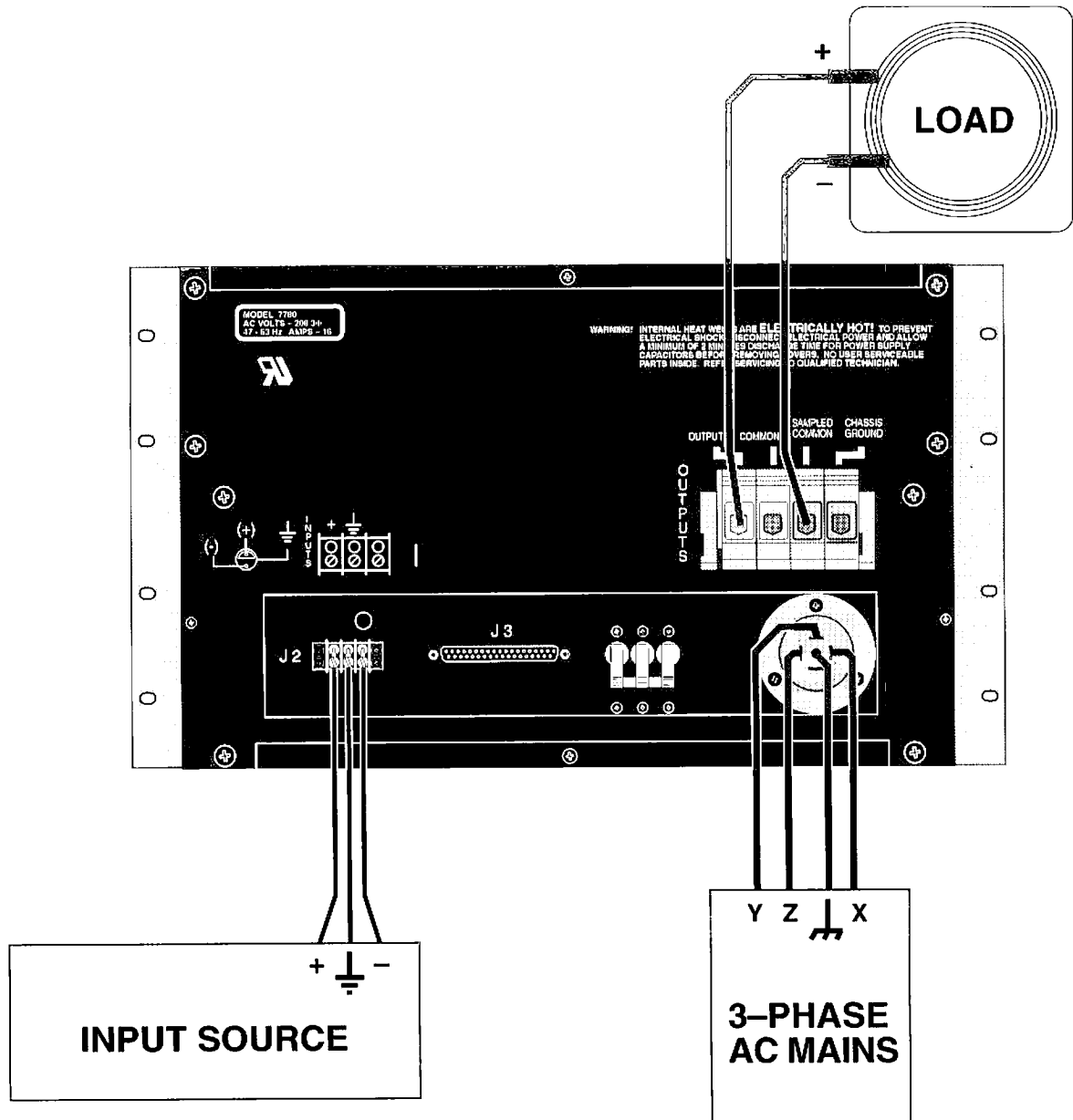
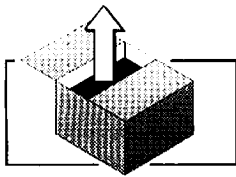


Illustration 2-6 Controlled Current Hookup



---

### 2.3.3 Connecting Power



## DANGER

The risk of lethal *ELECTRIC SHOCK* exists when connecting ac mains! Disconnect the source before connecting ac power wires to the connector.

Model 7700 includes a NEMA style locking ac connector (shown below) as standard equipment. Connect the 7700 to the proper 3-phase ac mains with this connector. Wiring to the ac connector requires only that the three line wires go to connections X, Y, and Z plus the safety ground to the center connection G. The illustration below shows the connector disassembled exposing the screw-type terminals. The connector then plugs into the 7700.

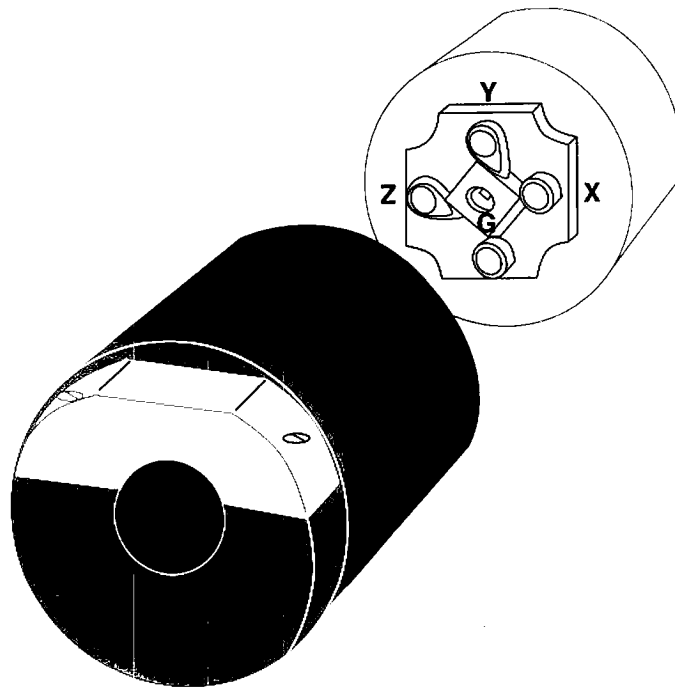
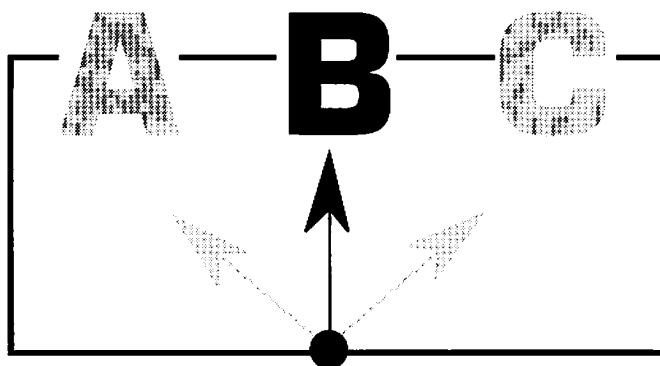
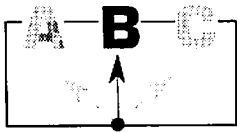


Illustration 2-7 AC Mains Connector



## ***Section 3—Applications***

This section describes uses, capabilities, and sample system configurations of the Techron 7700 series amplifier. Review this material before attempting to change the amplifier.



---

## 3.1 Introduction

Typically, 7700 series amplifiers are manufactured and shipped in specific configurations for a particular user requirement. This section is included for customers who may subsequently need to reconfigure 7700 series amplifiers for a new application. For these users, this section provides general theory and guidance.

This section assumes significant competence on the part of the reader in terms of amplifier systems, electronic components, and sound electronic working practices. Readers are urged to contact Techron Application Engineering for assistance with any of this information.



### WARNING

Except as recommended in this manual, attempts to reconfigure or otherwise change the circuitry of the amplifier could invalidate the Techron product warranty. In addition to possible damage to equipment, users face a safety hazard in the event such procedures are improperly performed. Users should be extremely cautious in making any component or circuitry changes from factory settings.

#### 3.1.1 Types of Applications

This section covers two major types of modifications:

- Combinations of multiple amplifiers for increased current and/or increased voltage. See Section 3.2
- Internal circuitry or component modifications to any units. See Section 3.3.

#### 3.1.2 Special Applications

This section must necessarily deal with the more common or typical modifications and applications. For users who require special reconfiguration not listed, Table 3-1 lists spare pins that allow direct connection with main board connectors.

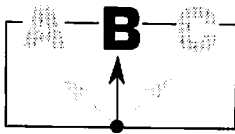
Users are also encouraged to contact Techron Application Engineering for assistance in modifying 7700 series amplifiers for new or special purposes.

### 3.1.3 Applications Connector Table (J3)

Table 3-1 shows the pin numbering sequence of J3, the 37-pin D-Sub connector located on the back panel of the amplifier. This connector is referred to throughout this section for interlocks, Master/Slave inputs/outputs, and custom applications. Corresponding connections on main circuit board connectors J100, J200, J250, and J300 are also shown.

FUNCTION	J3	J100	J200	J250	J300
Amplifier Output	1				
Sampled Common	2				
Unsampled Common	3				5
Reset + In	4				7
Master Error + Out	5				9
Overload + Out	6				11
Overtemp + Out	7				13
Overvoltage + Out	8				15
Ready + Out	9				17
Supply, + 15 VDC	10	10			19
Interlock Common	11				21
Interlock Common	12				23
Enable + In	13				25
Current Sum 1 (-)	14		8		27
Current Sum 2 (+)	15		12		29
Current Sum 3 (-)	16		10		31
(Spare)	17	4, 8			33
(Spare)	18	6			35
(Spare)	19	4, 8			33
Common (circuit ground)	20	3, 16		4	38
Input, +1	21				4
Input, -1	22				6
Reset - In	23				8
Master Error - Out	24				10
Overload - Out	25				12
Overtemp - Out	26				14
Overvoltage - Out	27				16
Ready - Out	28				18
Interlock	29				20
Amp Ready	30				22
Supply, - 15 VDC	31	9			24
Enable - In	32				26
Current Sum 1 (+)	33		11		28
Current Sum 2 (-)	34		9		30
Current Sum 3 (+)	35		13		32
(Spare)	36	7			34
(N/C)	37				
Input, +20				3	37, 39
Input, -20				2	36, 40
(N/C)					1, 2, 3

Table 3-1 J3, J100, J200, J250, and J300 Connections



## 3.2 Multiple Amplifier Systems

### 3.2.1 Principles and Overview

The Techron 7700 Amplifier may be used with other Model 7700 amplifiers to increase available current or voltage. This section explains the objectives of such amplifier systems and provides general guidelines for their construction.

Construct systems of multiple 7700s according to the following principles:

- **Use *only* the same model Techron 7700 series amplifiers to construct multiple amplifier systems.** Do *not* connect, for example, a Techron 7780 with a 7782 or an amplifier made by another manufacturer. Such improper connections could damage the amplifiers.
- **Never *directly* connect one amplifier's *Output* terminal (on the output terminal block) to another amplifier's *Output* terminal.** The resulting circulating currents will waste power and may damage the amplifiers. Depending on the configuration, the *Output* terminal of one amplifier may only be directly connected to the next amplifier's *Sampled Common* (or sometimes *Common*) terminal, to the load, or to a ballast resistor.
- **Potentially lethal voltages and currents are present within the amplifiers.** While the 7700 chassis is earth grounded, all internal grounds are floating. Particularly in systems assembled for increased voltage, all internal grounds of Slave amplifiers could carry lethal voltage levels.
- **Connect input signal to Master amplifier only.** Review Section 2.6 for detailed input signal instructions.
- **Wire specifications are important.** Section 3.2.3 details the minimum output wiring specifications of multi-amplifier systems. Make sure the guidelines outlined in this section are followed carefully.

Because the internal circuitry of a 7700 amplifier is not connected to chassis ground, the amplifier is well suited for use in series or parallel with other 7700s. See Table 3-2 for examples of *proven* configurations. Configurations with more amplifiers may be possible, depending on application (amplifiers have an internal 2,000 V standoff potential limitation). In assembling such systems, proper wiring connections are extremely important.

	1 Series	2 Series	3 Series	4 Series
1 Parallel	X	X	X	X
2 Parallel	X	X	X	
3 Parallel	X	X		
4 Parallel	X	X		
5 Parallel	X			
6 Parallel	X			

**Table 3-2 Proven 7700 Amplifier System Configurations**



---

In Illustrations 3-2 through 3-13 of series systems, parallel systems, and parallel-series systems the following interpretive rules apply:

- Connection points on the left side of the amplifier block diagram (15 V, INT COM, INT, etc.) refer to pins on J3, the 37-pin D-Sub connector, except for +20, -20, and GND that refer to the input terminals of J1/J2.
- Connection points on the right side of the amplifier block diagram (OUT, COM, S COM) refer to the barrier block connectors on the output terminal block. OUT refers to Output, COM refers to Common, and S COM refers to Sampled Common.
- Chassis grounds—where shown—have a 2.7  $\Omega$  resistor attached between the ground and Sampled Common. Every amplifier chassis is (or should be) grounded through the input power (ac mains) connector. Where the 2.7  $\Omega$  resistor is not required, the ground symbol has been left off for simplicity's sake.

**Note:** Although typically not required, some success has been found connecting the amplifiers' chassis to a rack main member using a wire-braid ground strap to reduce amplifier noise. Such a connection properly made, while making multiple connections to ground, lowers the overall impedance path to earth ground from the amplifier chassis.

Illustrations 3-2 through 3-13 are valid for both controlled voltage mode and controlled current mode operation.

To choose between differential or single-ended output use the following guidelines:

- Differential output is less expensive (because it needs fewer optical couplers) and is easier to build than single-ended output.
- Single-ended output *must* be used if the load will ever be ground referenced.

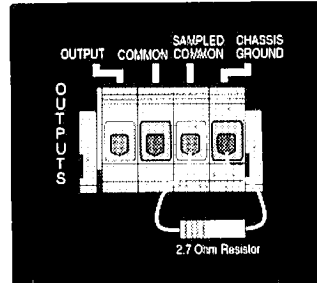
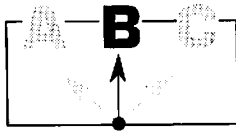


## CAUTION

To protect amplifiers in a series system from damage, the interlock system for any unit above ground must be protected with an optical isolator, Techron's OPTOC-1 (part number OPTOC1).

### 3.2.2 Master/Slave Settings

In multiple Techron 7700 amplifier configurations, one amplifier is designated as a "Master" amplifier and the one or more amplifiers connected to it are designated as "Slaves." In Slave amplifiers, the input signal, selection of CV or CC operation, and (if applicable) CC compensation are controlled by the Master amplifier. Amplifiers are factory-set as Masters. The Master setting is also correct for single-amplifier operation.



**Illustration 3-1 Output Terminal Block**

Note: Before using a *Master* amplifier (either by itself or in a system), install the 2.7  $\Omega$  "circulating ground current bleed resistor" included in the amplifier package. (See Illustration 3-1.) Attach this resistor between the Sampled Common output connector and chassis ground. The purpose of the 2.7  $\Omega$  resistor is to reduce noise caused by small circulation ground currents. Use of the resistor in *Slave* amplifiers depends on the circuit configuration. Whenever an OPTOC-1 is used (the *Slave* amplifier is not ground referenced), the resistor is *not* used on that *Slave* amplifier. (If installed where it shouldn't be, the resistor may burn out.)

To operate the amplifier as a *Slave*, complete these steps:

1. With power to the amplifier turned off, loosen the four screws on the front cover of the amplifier and remove the front cover.
2. Locate switch S100 on the main circuit board. See Illustration 2-8.
3. Slide the switch down to the SLAVE position.

### **3.2.3 Output Wiring Principles**

This section outlines the minimum output wiring requirements in terms of size, length, and rating for connecting multi-amplifier systems.

Wire size or gauge should be selected to exceed the expected current it will carry. Table 3-3 shows the minimum matching requirements of wire gauge and continuous duty amperage limits.

Control the length of wire connecting each amplifier with care. Particularly in parallel applications, the length of branches to each amplifier should match within a tolerance of  $\pm 1/4$  inch. Similarly, in any Y-branching application, both legs should be of the same length with a tolerance of  $\pm 1/4$  inch. See Illustration 3-15.

Wires connecting the amplifier (output) commons or sampled commons together should be as short as practically possible. (Leaving a few feet of extra length in order to extend amplifiers mounted on chassis slides is permissible.)

Wire rating refers to the allowable voltage handled by the wire. In configuring multi-amplifier systems for increased voltage, make sure that the wire insulation is appropriate for the intended voltage.

To construct interconnect wiring, see Section 3.2.5.7, Step 5.

Continuous Duty Current* (Amperes)	American Wire Gauge (Awg)	Diameter (mm)	Diameter Mils (.001 in)
46	8	3.264	128.5
33	10	2.588	101.9
23	12	2.053	80.8
17	14	1.628	64.1
13	16	1.291	50.8
10	18	1.024	40.3

\* Minimum value for insulated wire in free air (i.e. not bundled)

**Table 3-3 Wire Current Carrying Capacity**

### **3.2.4 Series Systems for Increased Voltage**

Two 7700 amplifiers can be assembled in a series configuration to approximately double available voltage to a load. The following examples could be used for either controlled current or controlled voltage mode.

To assemble a series system:

1. Identify one amplifier as the "Master" unit. Set S100 up to the MASTER position.
2. Following instructions in Section 2.6, connect system input to the Master amplifier.
3. On the "Slave" unit(s), set S100 down to the SLAVE position.
4. Build and connect interconnect cable between both amplifiers as shown in the specific illustration and according to the instructions in Section 3.2.5.7, Step 5.
5. Connect the load to the amplifiers according to the illustration.

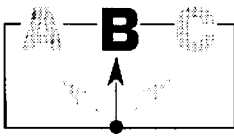
## DANGER

High voltage is present in series-connected amplifier systems. Do not touch internal parts of amplifier or the output terminals while the system has power.

## CAUTION

To protect amplifiers in a series system from damage, the interlock system for any unit above ground must be protected with an optical isolator, Techron's OPTOC-1 (Part Number OPTOC1).

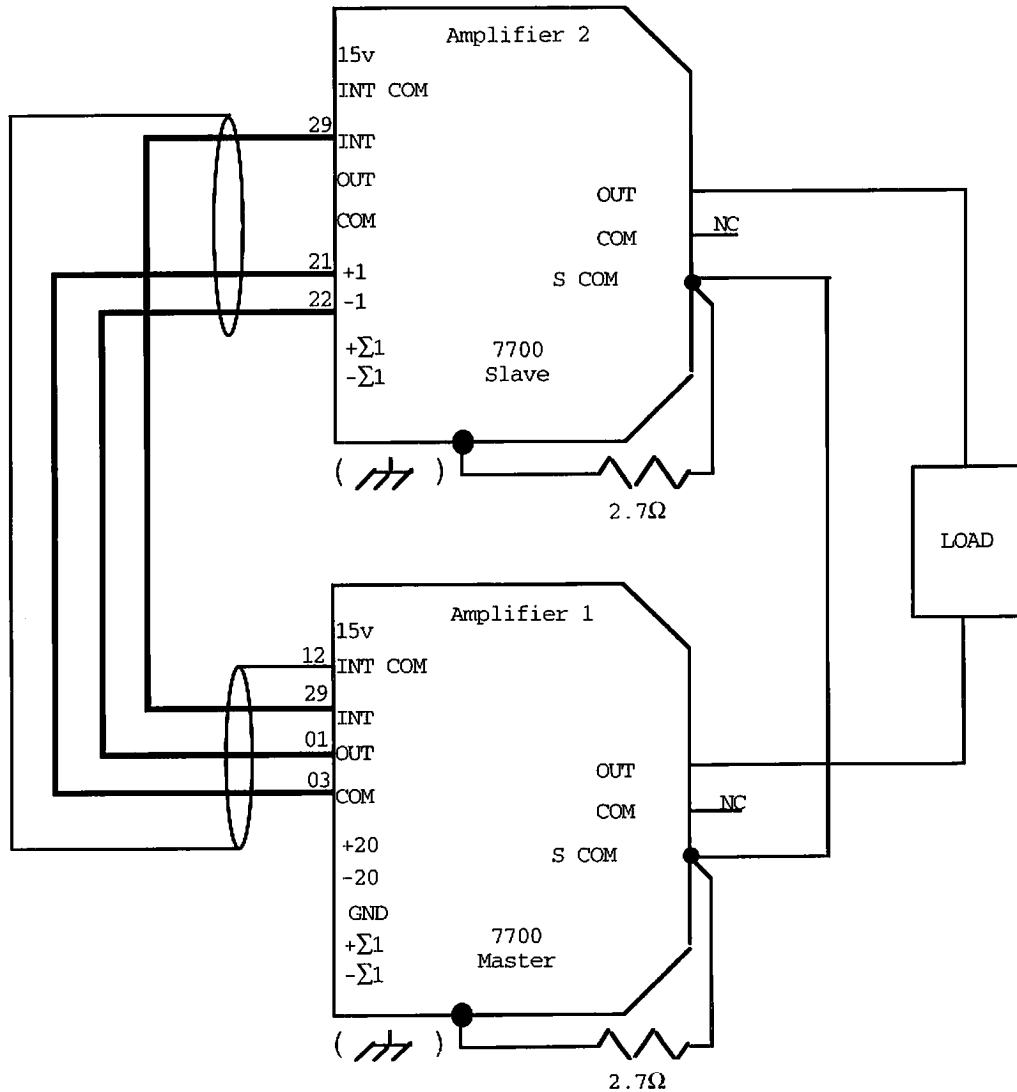
In any differential-output (push-pull) configuration, both sides of the load are at high potential. Never attempt to ground the load—either directly or through test equipment.



### 3.2.4.1 Two-Series Differential-Output

Illustration 3-2 shows the basic connections for a 7700 two-series differential-output (push-pull) system.

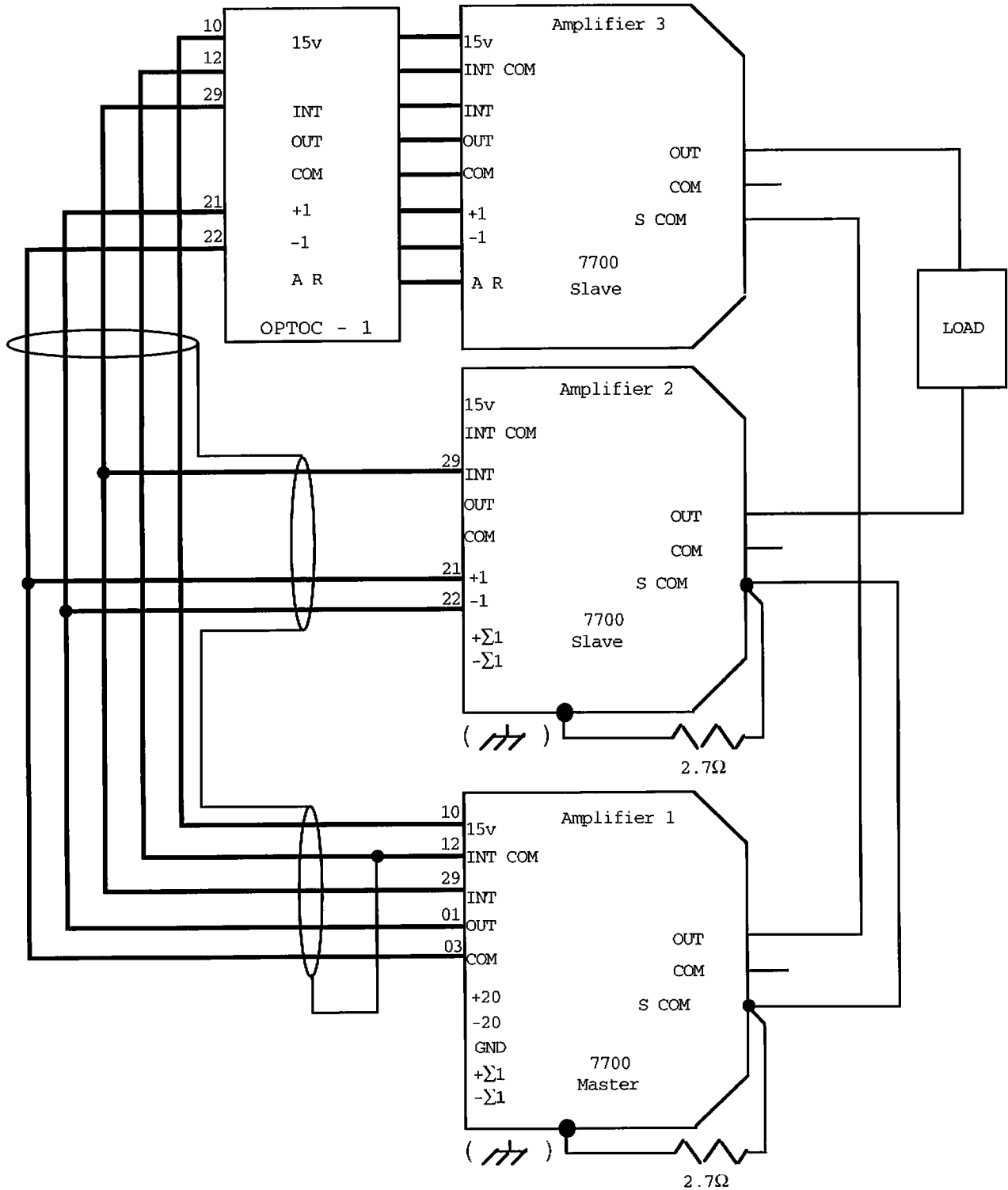
**Note:** In each of the Illustrations 3-2 through 3-13, the resistor connected from "Sampled Common" to chassis ground of an amplifier is 2.7 ohms, 2 watts. Use of this resistor is covered in Section 3.2.2.



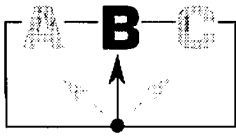
**Illustration 3-2 Two-Series Differential-Output System**

### 3.2.4.2 Three-Series Differential-Output

Note the use of the optical isolator (OPTOC-1) to protect the slave amplifiers above ground.



3-3 Three-Series Differential-Output System



### 3.2.4.3 Four-Series Differential-Output

Note the use of the optical isolators to protect the slave amplifiers above ground. Details of wiring in D-sub connector (DB-37) are also shown.

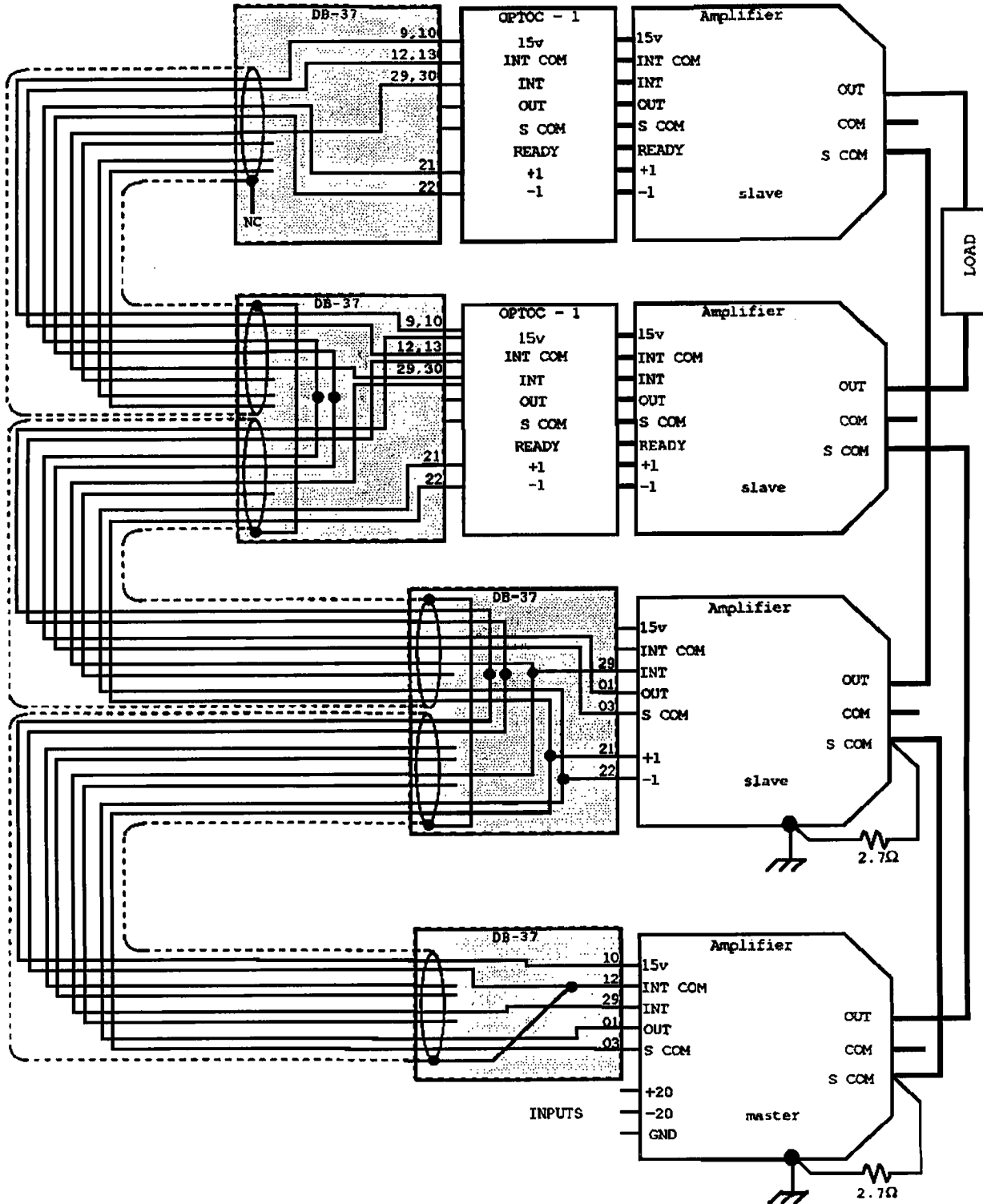


Illustration 3-4 Four-Series Differential-Output System

### 3.2.4.4 Two-Series Single-Ended-Output

Illustration 3-5 shows the assembly of two 7700s in a two-series single-ended (unbalanced) output configuration.

To protect each amplifier from damage, the interlock system for the unit above ground must be protected with an optical isolator, Techron's OPTOC-1 (part number OPTOC1).

**Note:** The resistor connected from "Sampled Common" to chassis ground is 2.7 ohms, 2 watts. Use of this resistor is covered in Section 3.2.2.

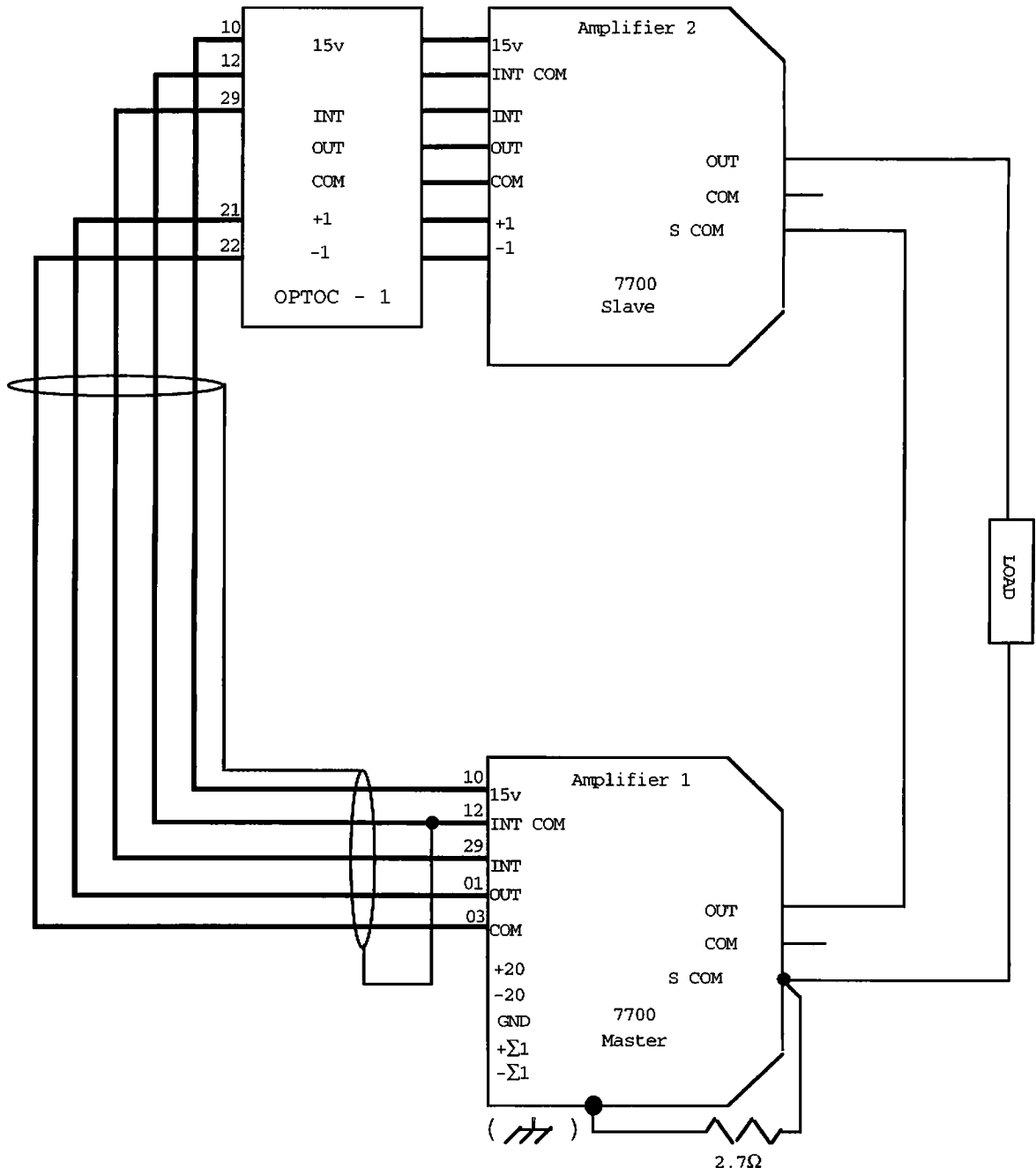
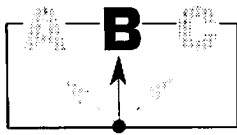


Illustration 3-5 Two-Series Single-Ended-Output System



### 3.2.4.5 Three-Series Single-Ended-Output

Note the use of the optical isolators to protect the slave amplifiers above ground.

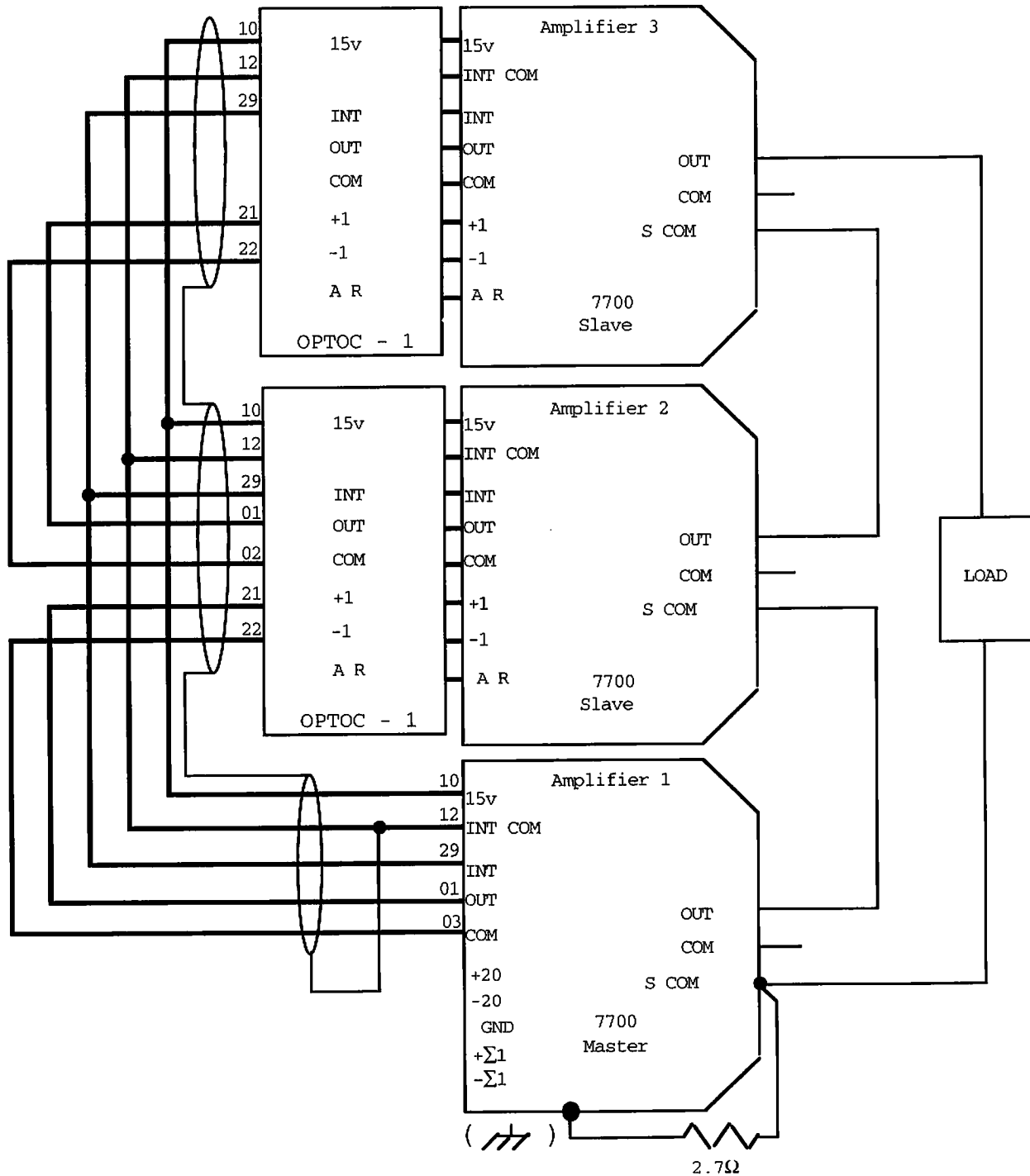


Illustration 3-6 Three-Series Single-Ended-Output



### 3.2.4.6 Four-Series Single-Ended-Output

Note the use of the optical isolators to protect the slave amplifiers above ground.

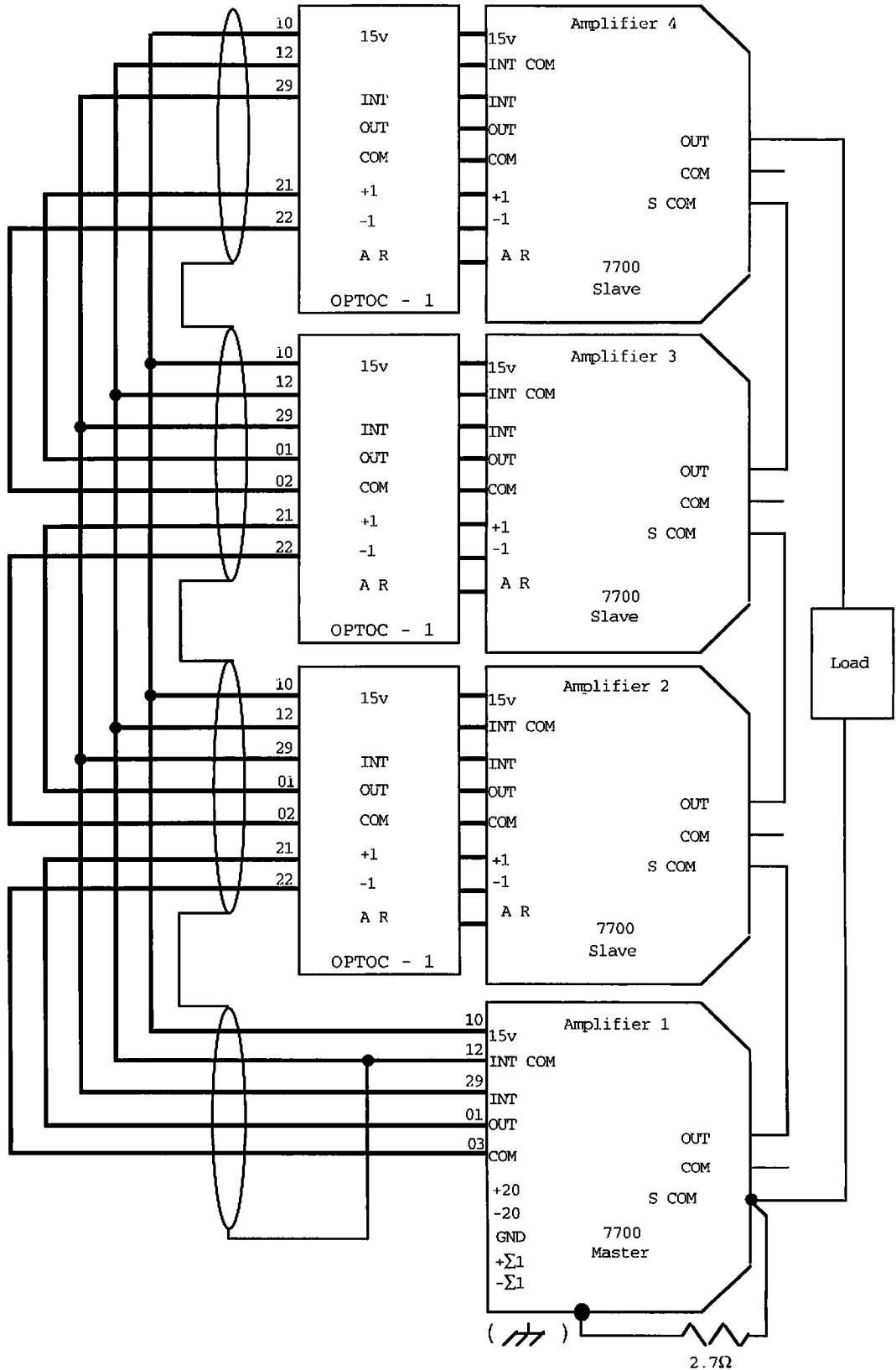
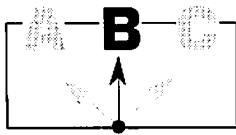


Illustration 3-7 Four-Series Single-Ended-Output System



## 3.2.5 Parallel Systems For Increased Current

### 3.2.5.1 Introduction

Use this procedure to construct a parallel system of amplifiers.

Multiple 7700 Techron amplifiers, assembled in a parallel configuration, increase the available output current to the load. Illustration 3-8 shows the basic wiring configuration for two 7700s operated in parallel. The upward arrows represent further connections for additional units in the parallel system. This is the simplest controlled voltage form of the parallel system.

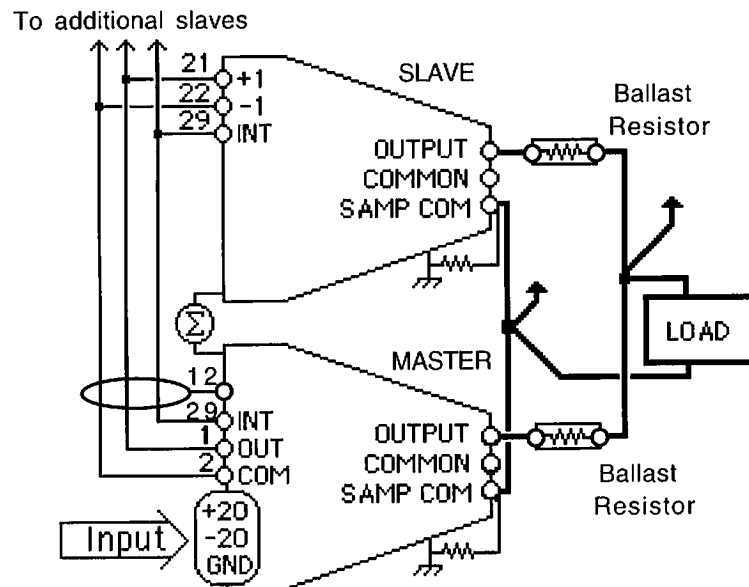


Illustration 3-8 Basic Parallel System

In terms of the amplifier's individual response, when an amplifier is configured in parallel with another amplifier, it "sees" twice the total impedance of the load. Similarly, if three amplifiers are configured in parallel, each will "see" (or respond as if they were driving) three times the impedance of the total load. Therefore, the correct compensation components (see Section 3.3.6) for a single amplifier driving a load will not be correct for the Master amplifier of a parallel configuration of amplifiers driving the same load.

When multiple amplifiers are used in parallel as a current source (controlled current mode), current summing (" $\Sigma$ ") circuitry is needed. (See Section 3.3.6 for information on controlled current mode.) Summing of the current feedback information is through a precision, balanced input mixer in the Master amplifier of a parallel system. Jumper block J200 (located on the right-hand side of the main board) internally identifies the Master, Slave 1, Slave 2, and Slave 3 amplifiers. All amplifiers in a system of paralleled amplifiers will require a J200 jumper plug.

Illustration 3-14 shows the current summing feedback circuit and the correct configurations of J200 for the Master, Slave 1, Slave 2, and Slave 3. If you use fewer than four amplifiers in parallel, install only the jumper wires on J200 jumper plug (Master) corresponding to the amps used.

---

The “ $\Sigma$ ” connection shown in Illustration 3–8 is detailed in Illustration 3–14. Add these connections to the cable between amplifiers.

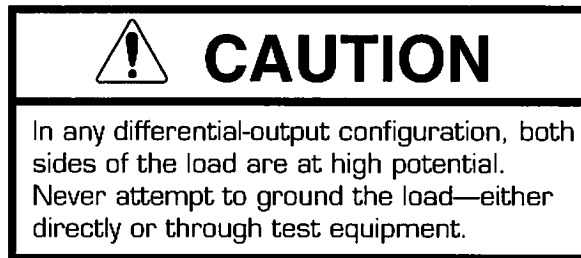
Current summing circuitry is not used in voltage mode operation. If J200 jumper plugs and interconnect wiring are not installed, however, the system current monitor (T101, Master) will not function properly.

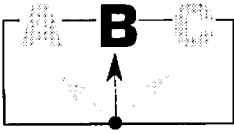
All amplifiers connected in parallel require “ballast” resistors. Since no two amplifiers in parallel will put out *exactly* the same voltage, the amplifier with the highest voltage would drive some voltage into the other amplifiers. The ballast resistor (or “current sharing/isolating” resistor) absorbs this small voltage difference and serves to isolate the amplifiers in a parallel circuit. Typical value for the ballast resistors would be 0.050 ohms, 250 watts. Dale RH250 (Crown Part Number C6892–1) is an appropriate resistor for this application. Mounting holes on the back panel have been provided.

7700 series amplifiers have internal provisions for up to four paralleled amplifiers (one Master and three Slaves). It is possible to parallel additional amplifiers with external custom circuitry. Contact Techron Applications Engineering for further assistance.

Illustrations 3–9 through 3–13 show sample configurations. Section 3.2.5.7 gives detailed information on how to construct a parallel system.

In systems with amplifiers that are *only* in parallel, such as in Illustrations 3–9 through 3–11, a “differential” output configuration does not apply. Only in parallel-series systems, such as in Illustrations 3–12 and 3–13, are differential-output configurations distinguishable from single-ended-output configurations.





### 3.2.5.2 Two-Parallel One-Series

Note: Review Section 3.2.5.7 before constructing!

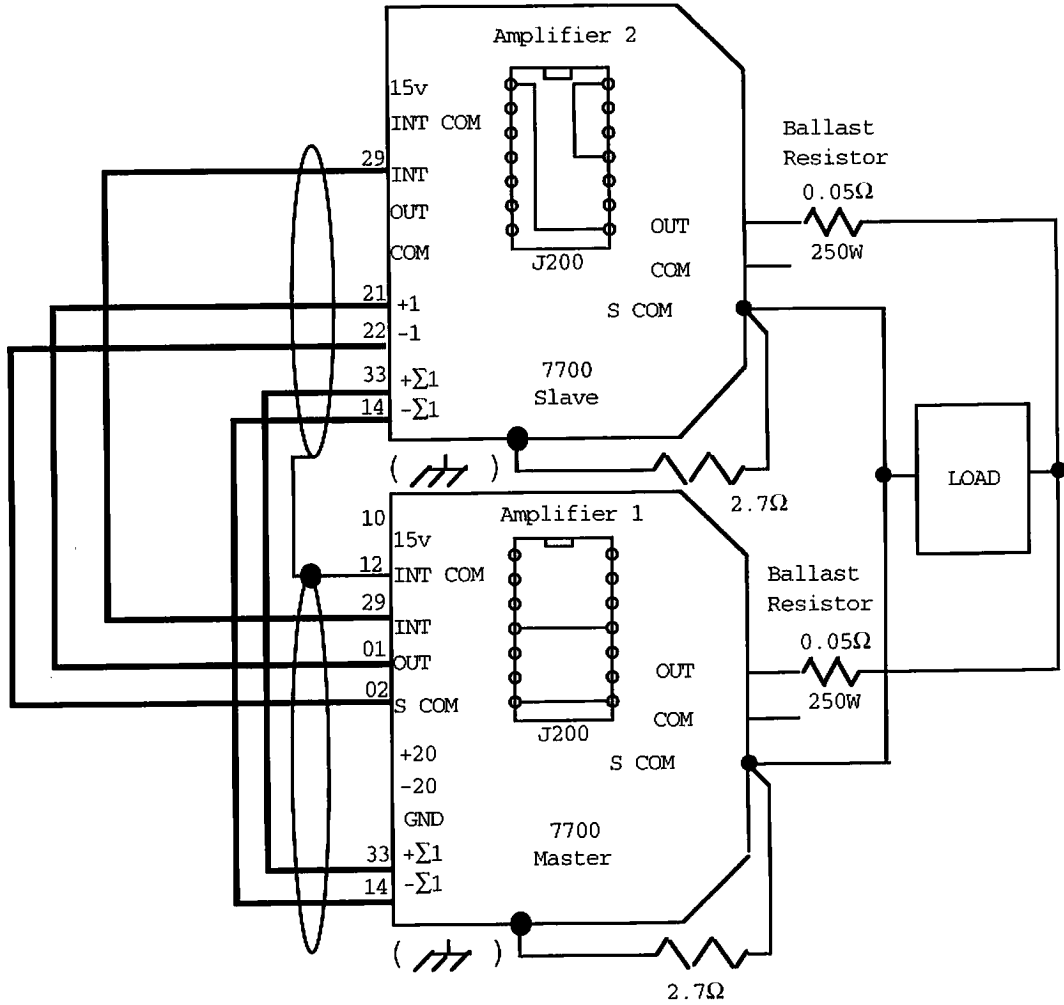


Illustration 3-9 Two-Parallel One-Series System

### 3.2.5.3 Three-Parallel One-Series

Note: Review Section 3.2.5.7 before constructing!

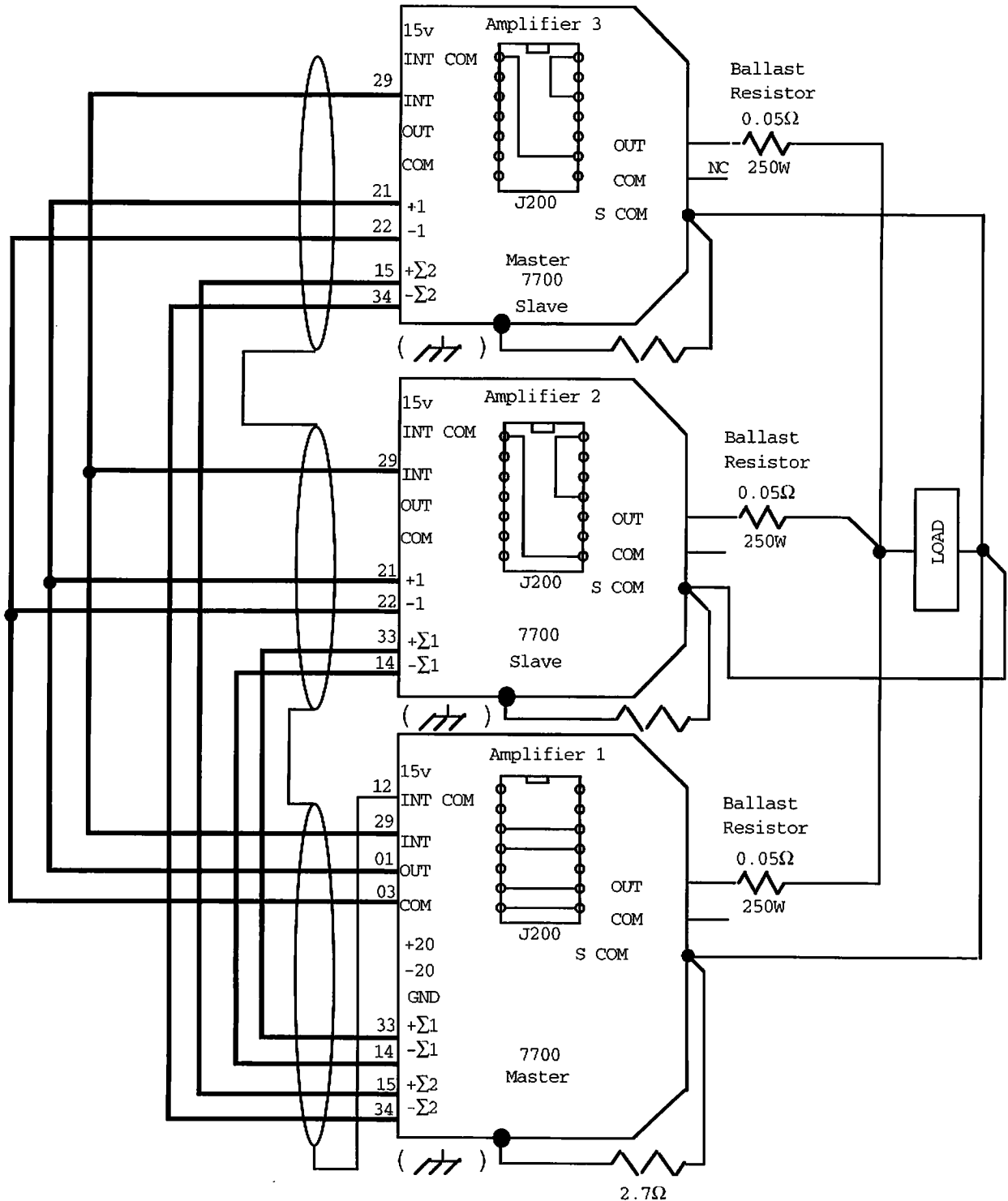
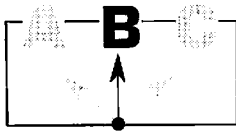


Illustration 3-10 Three-Parallel One-Series System



### 3.2.5.4 Four-Parallel One-Series

Note: Review Section 3.2.5.7 before constructing!

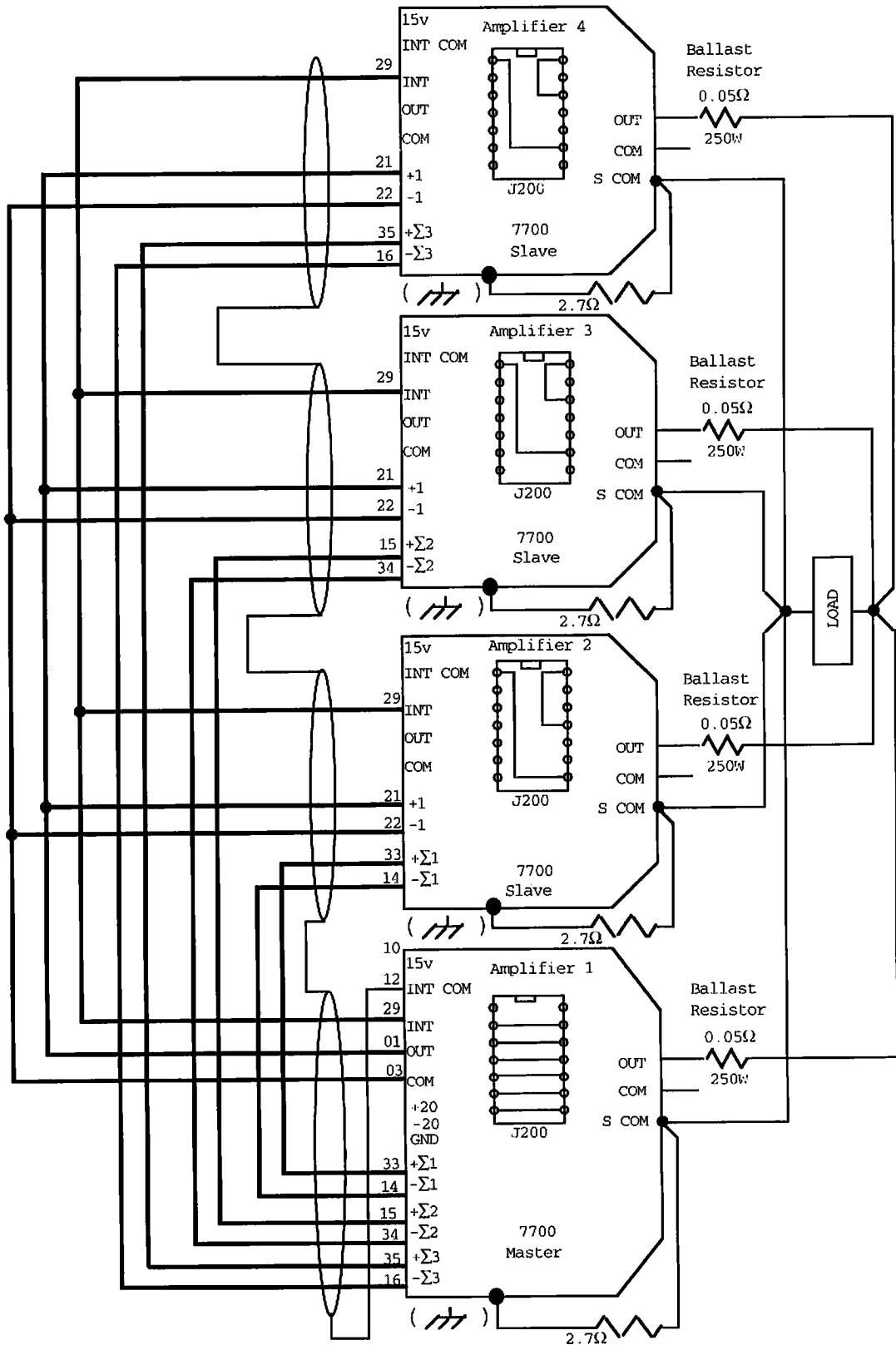


Illustration 3-11 Four-Parallel One-Series System

### 3.2.5.5 Two-Parallel Two-Series Single-Ended-Output

Note the optical isolators protecting the slave amplifiers above ground. Also, review Section 3.2.5.7 before constructing!

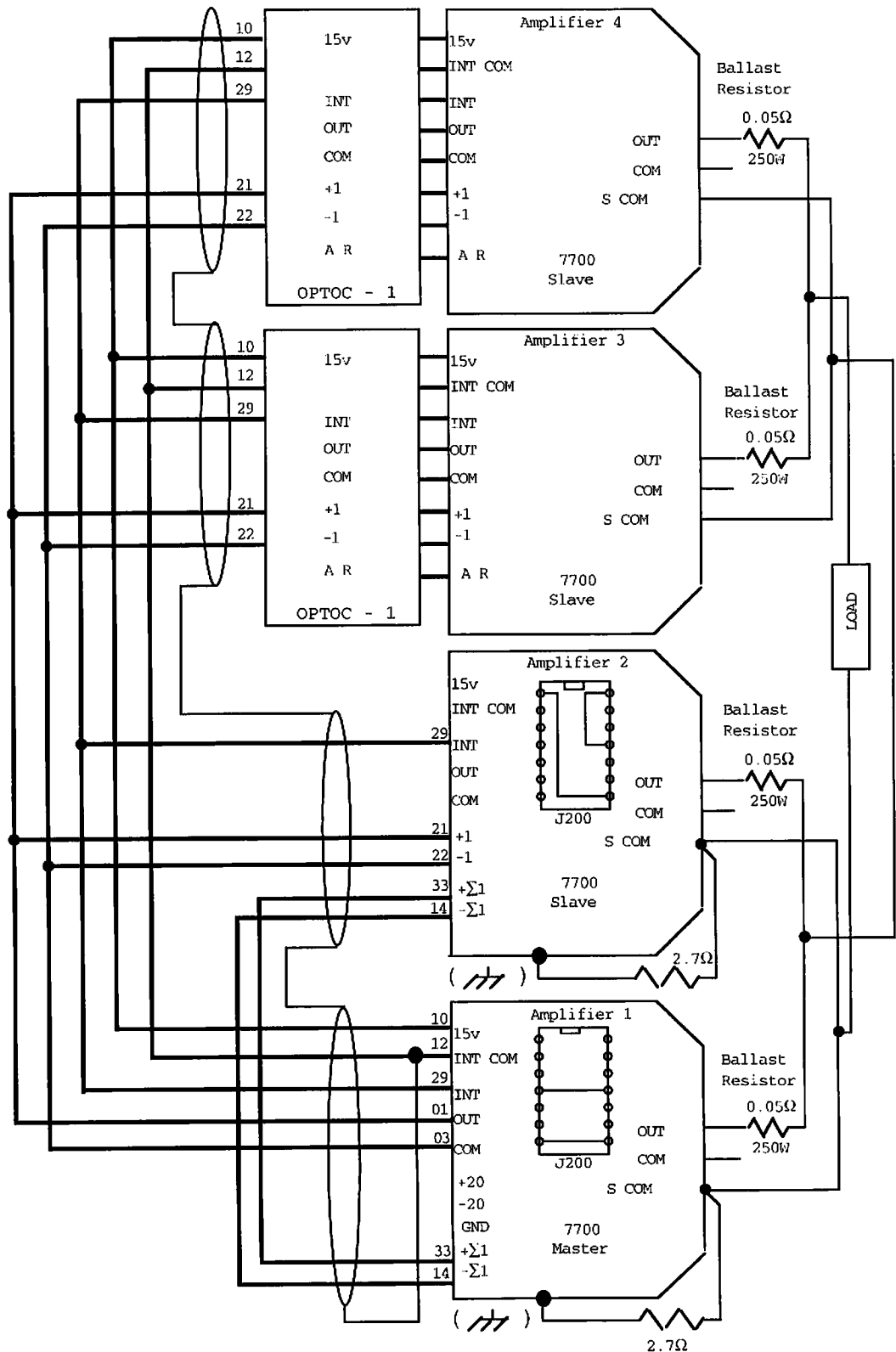
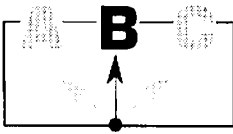
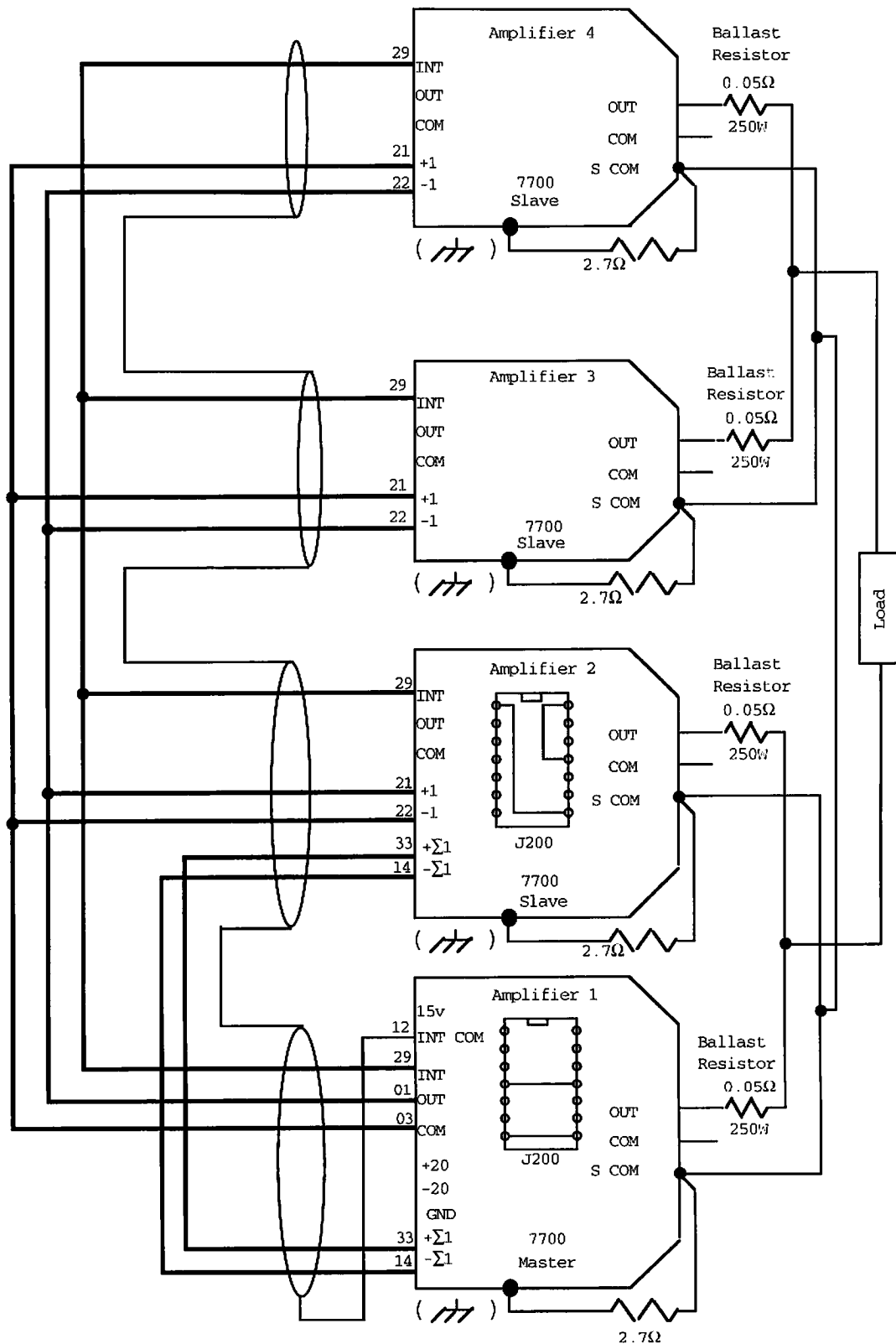


Illustration 3-12 Two-Parallel Two-Series Single-Ended-Output System



### 3.2.5.6 Two-Parallel Two-Series Differential-Output

Note: Review Section 3.2.5.7 before constructing!



**Illustration 3-13 Two-Parallel Two-Series Differential-Output System**



---

### 3.2.5.7 Procedure

In assembling paralleled amplifier systems, follow these guidelines:

1. Construct and install the proper J200 jumper blocks in all amplifiers. Use DIP headers and caps (part numbers C6957-2 and C6958-0).
2. To help balance all amplifier output currents driving one load, use a ballast resistor on each of the amplifier outputs. The typical value for this resistor is 0.05 ohms, 250 watts (Dale RH250, Crown Part Number C6892-1). Secure the resistors using the provided mounting holes on the amplifier back panels.
3. Select output wire size (gauge) to exceed the expected current it will carry. When constructing an amplifier system that will function as a current source, remember the smaller the output wire, the greater its resistance. This resistance will add to the resistance of the load.

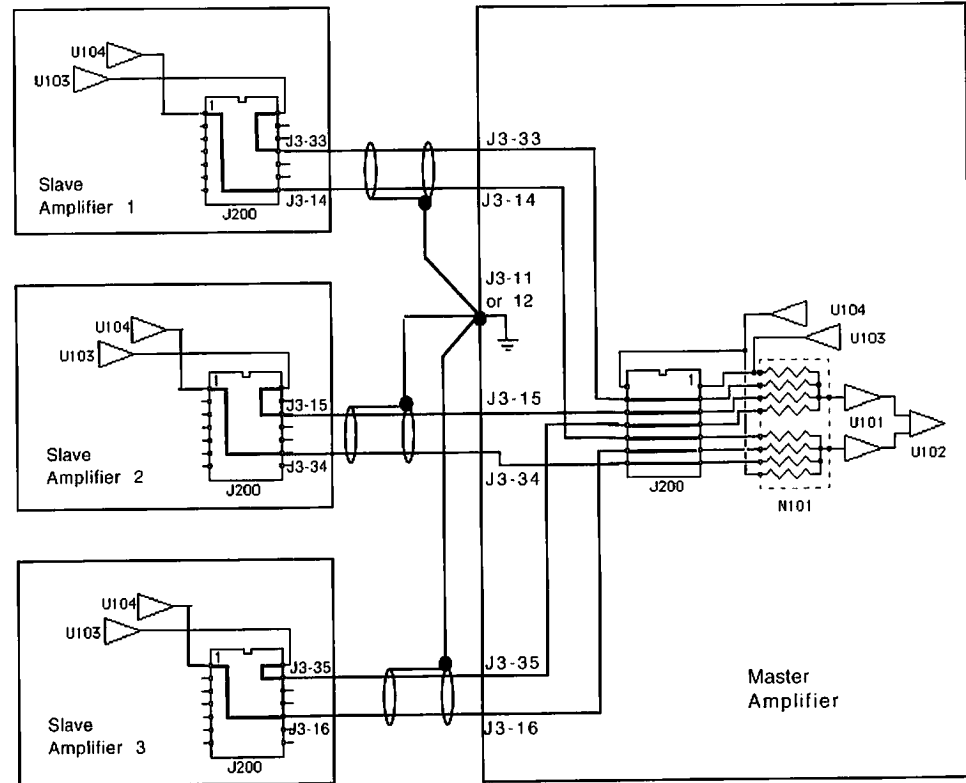
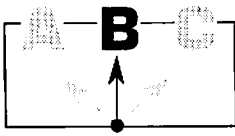
*Note:* In a system configuration of multiple amplifiers designed for increased output voltage, ensure the wire insulation is appropriate for the intended maximum voltage.

4. When wiring the amplifier outputs to the load in configurations that include paralleled amplifiers, cable length is critical. The length of the wire branches should match within a tolerance of 0.25 inches; and all wire in any branch should be of like type. See Illustration 3-15.
5. Construct the proper interconnect cabling for your amplifier system. (For detailed interconnect wiring diagrams of most amplifier system designs, contact Techron Applications Engineering.) When constructing an interconnect/interlocking cable, follow the suggestions below:
  - a. An ideal interconnect cable would be constructed from the following materials:
    - a twisted pair used for “output” and “sampled common”
    - a twisted pair used for “+1” and “-1”
    - a twisted pair used for “+15 V” and “ground”
    - a twisted, shielded pair for each pair of current summing signals
    - a single wire for “interlock”

If this is not practical, use a group of twisted, shielded pairs with an overall shield wire. This cable usually is available in two or three twisted pairs (four or six wires) per cable. Using 22 AWG wire is typical. Pay attention, however, to the voltage rating on the wire's insulation. Some wire insulation is only rated for 600 V. You may, depending on the system configuration, be exceeding that potential.

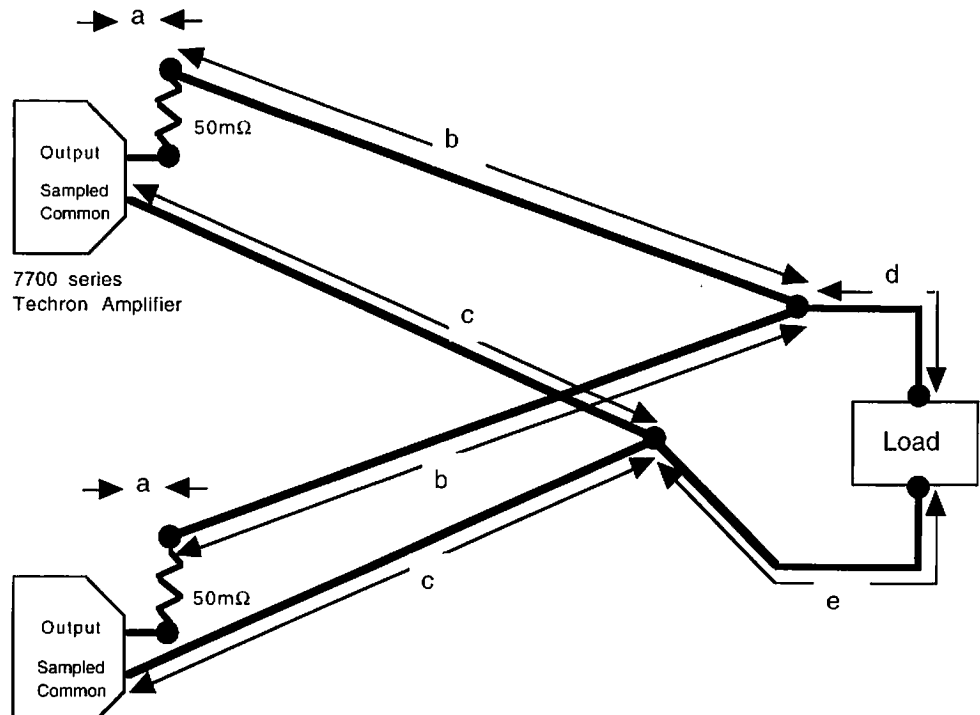
- b. Shielding is recommended for the current summing signals. Connect all cable shields to one point—the Master amplifier J3 connector pin 11 or 12. Do not terminate the shield to the DB-37 back shell. Shields should not carry signals.

**Note:** An overall shield does occasionally cause oscillation and/or noise problems. If, after constructing your interconnect wiring, excessive noise or unexplained oscillations occur, disconnect the shield from the Master amp (J3 pin 12) and from the interconnect wiring chain (such that at every DB-37 connector the shield path is broken). This may reduce noise or eliminate oscillations.



**Illustration 3-14 Current Summing Feedback Circuit**

- c. It is typical to group the signals as listed in step 5-a. Please refer to Illustration 3-16.
    - In applications where noise or oscillations are problematic, try routing the “output” and “sampled common” signals as well as the “+1” and “-1” signals on their own twisted pairs separately from the bundled pairs.
    - It may also be helpful to route the current summing signals ( $+\Sigma$  and  $-\Sigma$  signals) through shielded cables that are separate from all other signals.
  - d. When connecting wires to the DB-37 connector, solder only one wire per pin. Splice any additional wires for a given pin some distance (approximately 0.25 inches) away from the pin. All splices should be protected with heat shrink tubing. All pins used on the DB-37 connector should be protected with heat shrink tubing when possible.
  - e. Use OPTOCs (optical couplers) where needed in the interconnect wiring of the amplifier system. A document entitled “Using OPTOC-1” (Crown Part Number K80429-2) is available from Techron.
  - f. Use a “circulating ground current bleed” resistor of approximately 2.7 ohms (1 watt) between the output connections “sampled common” to “chassis ground” on all amplifiers that do not use an OPTOC. (See Section 3.2.2.)
6. Zero the voltage offset (per amplifier) using the following procedure:
    - a. Remove power from all amplifier circuitry using the rear-mounted circuit breaker.



7700 series  
Techron Amplifier

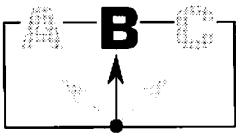
All wires of length "a" should be of the same length +/- 1/4 inch  
 All wires of length "b" should be of the same length +/- 1/4 inch  
 All wires of length "c" should be of the same length +/- 1/4 inch  
 The length of wire "d" is not critical  
 The length of wire "e" is not critical  
 Wire lengths "a" and "b" may or may not be of the same length

**Illustration 3-15 Output Wire Lengths**

- b. Disconnect load wires from each amplifier (sampled common and output).
- c. Disconnect all J3 interconnect cables.
- d. Remove amplifier front covers. Make sure all amplifiers are in Slave mode (S100).
- e. Connect both an oscilloscope and a digital voltmeter (with a millivolt range) to "Amp Out" (T104) and "Gnd" (T105) test points (on the main board) of the amplifier under test.
- f. Turn on power to the amplifier under test and place in "ready" mode.
- g. Adjust R204 for a reading of 0 V.
- h. Put amplifier in "standby" mode, or remove power.
- i. Repeat steps 6-e through 6-h for each amplifier.

**Note: If your amplifier system only has amplifiers which are directly in parallel with the Master amplifier go to step-8 and ignore step-7.**

7. With more than one group of amplifiers in parallel, that is, if you are building a multiple parallel **and** multiple series system (such as Illustration 3-18), install a trimming resistor network in location R203. Install this network in all amplifiers that are used in the system (so any amp can be used in any location). To modify the amplifier main boards, the follow these steps:



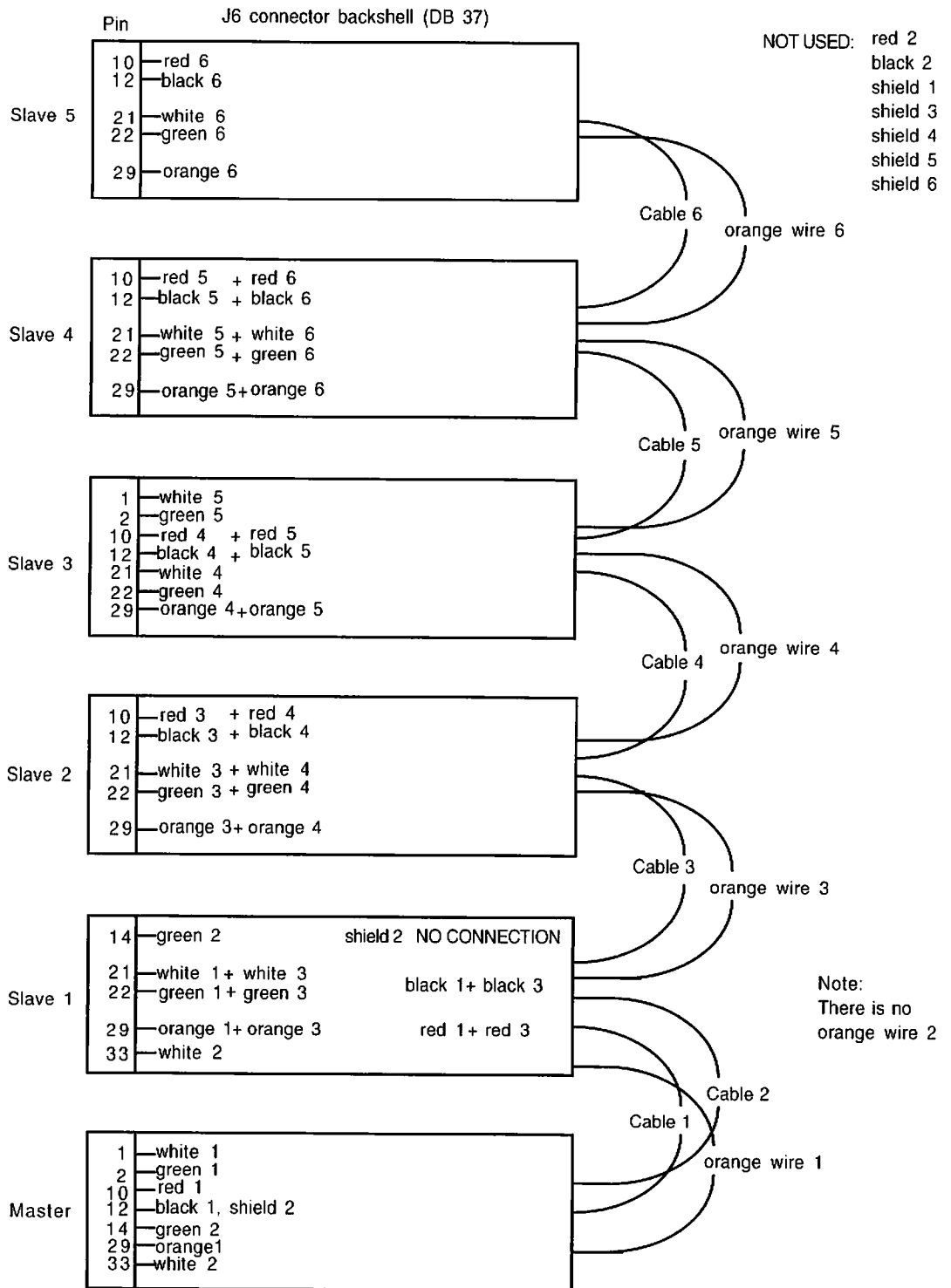
- a. Mark the main board to ensure each amplifier retains its original main board. Remove the main board from the amplifier.
- b. Remove R203.
- c. Construct the “R203 network” as shown in Illustration 3–17, and install it in the R203 location. Crown part numbers are shown in the illustration.
- d. Reinstall the main board on the amplifier.
- e. Connect power to an oscilloscope (of at least two channels) through an **isolated ground power source**. Ideally use a **two channel (probe) isolator** (such as a Tektronix model A6902B). Using an isolator allows safe floating voltage measurements.

**Note:** If you use a **probe isolator**, both ground wires of both probes may be used (because each channel is isolated).

If the oscilloscope is operated through an **isolated power source but without a probe isolator**, do **not** connect more than one ground lead. If CH 1 probe and CH 1 ground are connected to the circuit, do **not** connect CH 2 ground. This is a good practice for two reasons:

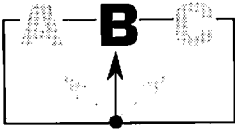
- If the amplifier system has series configured amplifiers, their individual grounds are at different potentials.
- Even when both amplifiers are in parallel, ground loops created by scope probes can **cause** oscillations.

- f. Adjust R203 to midrange on the Master amplifier and on all Slaves in parallel with the Master. (This isn’t an exact adjustment; the full range of the modified R203 on the Master amplifier is less than  $\pm 0.1\%$  overall gain.)
- g. Connect a low-level input signal to the Master amplifier. A 1.0 V P-P, 1 kHz, trapezoidal signal works well. Adjust scope traces to overlay with each other when the oscilloscope’s input is grounded.
- h. Choose one of the amplifiers **not** in parallel with the Master amplifier. (For example, in Illustration 3–18, any Slave amplifier except 1 could be chosen. In the following example, Slave 3 has been picked.) Connect scope probe CH 1 to the main board current monitor (T103) and ground of Slave 3.
- i. Adjust R203 to about the middle of its range. (This isn’t an exact adjustment.)
- j. Enable the amplifier system.
- k. Connect CH 2 probe to T103 of the first Slave amplifier in parallel with the Slave amplifier of step 7–h (Slave 2 in this example). Adjust R203 on the main board of that amplifier to overlay the signals.
- l. Continue the procedure of step 7–k for all Slave amplifiers which are in parallel with the first amplifier of step 7–h. (In the example system drawing there are no more amps in parallel.)
- m. Repeat steps 7–j and 7–k to verify that all amplifiers are “balanced.” Make slight adjustments to any R203s if needed.
- n. Repeat steps 7–h through 7–m for all other paralleled amplifier groups in the system. (In the example, Slave 4 and Slave 5.)
- o. Lock R203 potentiometers using a breakable/removable cement or sealant (such as finger nail polish).



Cable used is: One twisted pair of 22 AWG red and black  
 One twisted pair of 22 AWG white and green  
 One overall shield, shields are not connected to each other at DB 37 connectors  
 Each cable (and orange wire) length is about 6 feet, so the cable can be tied down to the cabinet but all amplifiers can still be extended on rack slides for service

**Illustration 3-16 Interconnect Wiring in an Example Two-Parallel, Three-Series, Single-Ended-Output Amplifier System (to be used with System Wiring Diagram of Illustration 3-18)**

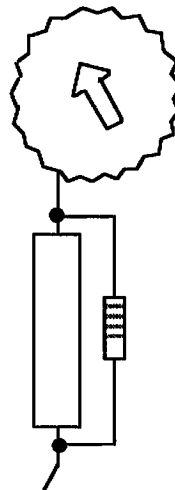
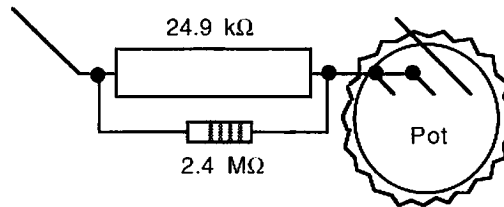
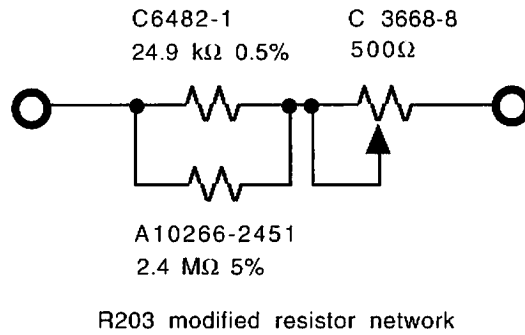
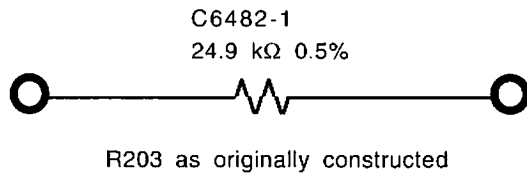


- 
8. Balance the amplifier outputs following the procedure outlined below. You may need to first install R254 on the main boards of all amplifiers used in the system, so any amp can be used in any location. (Mark the main boards and/or amplifiers so each amplifier will get the same main board re-installed.)
    - To install R254 (100 ohm trimpot, Crown Part Number C 6173-6) complete step 8-a.
    - If R254 location already has a potentiometer installed go to step 8-b.
    - a. Remove the main board from the amplifier. Remove the jumper across R254. Remove the 1.31 k $\Omega$  1% resistor from R201 location. Install the trimpot in R254 location and a 1.27 k $\Omega$  1% resistor (Crown Part Number A10265-12711) in R201 location. Install the main board on the amplifier. Use R254 to balance the Slave amplifier output.
    - b. After assembling the multiple amplifier system, connect power to an oscilloscope (of at least two channels) through an **isolated ground power source**. Ideally, use a **two channel (probe) isolator** (such as a Tektronix model A6902B). Using an isolator allows safe floating voltage measurements.

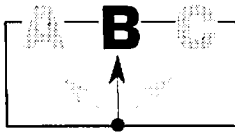
**Note:** If you use an probe isolator, both ground wires of both probes may be used (because each channel is isolated).

If the oscilloscope is operated through an **isolated power source but without a probe isolator**, do **not** connect more than one ground lead. If CH 1 probe and CH 1 ground are connected to the circuit, do **not** connect CH 2 ground. This is a good practice for two reasons:

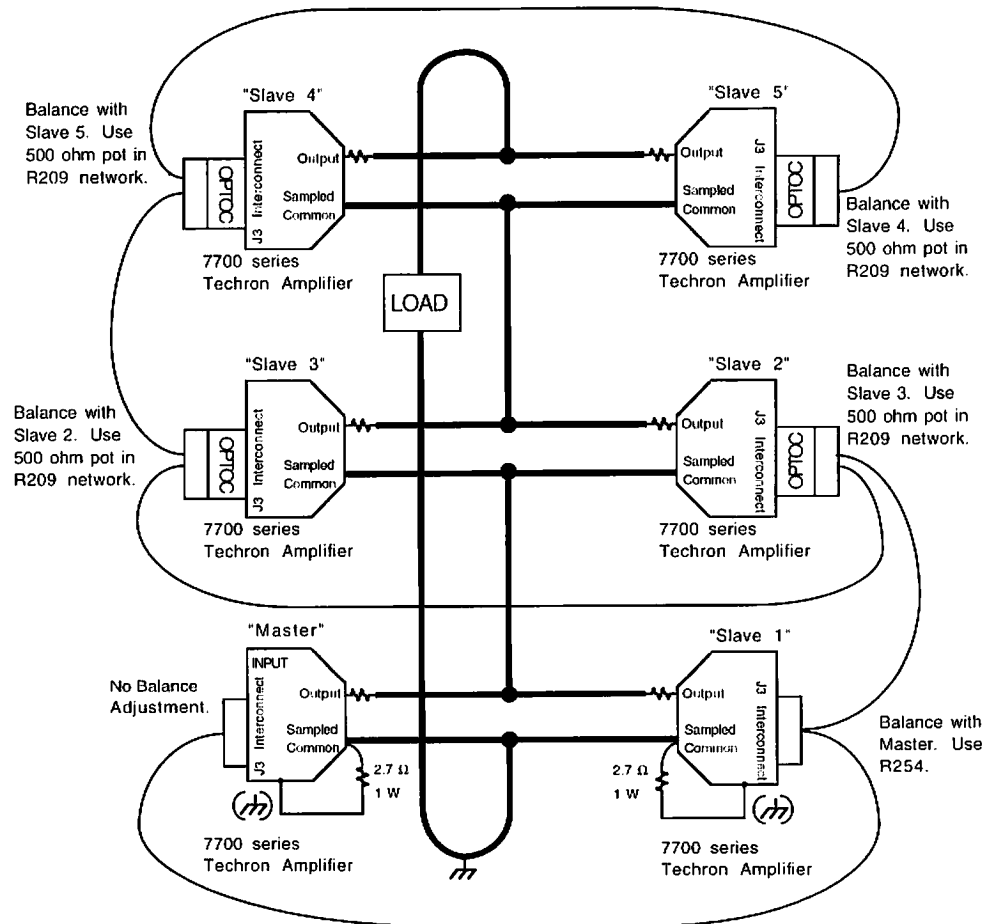
- If the amplifier system has series configured amplifiers, their individual grounds are at different potentials.
  - Even when both amplifiers are in parallel, ground loops created by scope probes can **cause** oscillations.
- c. Connect a low level input signal to the Master amplifier. A 1.0 V P-P, 1 kHz, trapezoid signal works well.
  - d. Adjust scope traces to overlay with each other when the oscilloscope's input is grounded. Connect CH 1 to MASTER amplifier main board current monitor test point (T103) and ground test point (T105).
  - e. Adjust R254 on the Master amplifier to the middle of its range. (This isn't an exact adjustment.)
  - f. Enable the amplifier system.
  - g. Connect CH 2 probe to the current monitor (T103) of the first Slave amplifier (in parallel with the Master). Adjust R254 on the Slave amplifier main board to overlay the signals.
  - h. Repeat step 8-g until all Slave amplifiers (which are in parallel with the Master amplifier) have been adjusted.
  - i. Repeat step 8-g and step 8-h to verify that all amplifiers are "balanced." Make slight adjustments to R254 if needed.
  - j. Lock R254 potentiometers using a breakable/removable cement or sealant (such as finger nail polish).
9. Zero the offset of the amplifier system using the following procedure:
    - a. With amplifiers in Standby mode, short the signal input terminals of the Master amplifier by connecting +, -, and Gnd to each other.



**Illustration 3-17 R203 Network**



- b. Using CH 1 of an isolated oscilloscope, observe AMP OUT to GND test points of the Master amplifier. For a more sensitive measurement, connect CH 1 probe and ground as well as a digital voltmeter to the load (this connection can be made at the system output fuse block if your system is so equipped).
  - c. Turn on power to amplifiers and place all amplifiers in Ready mode.
  - d. Adjust R117 on the Master amplifier main board for 0 V.
  - e. Remove power from all amplifiers. Disconnect test equipment. Reassemble amplifiers.
10. If the amplifier system is to be used as a current source (controlled current output), select and install the proper compensation components on the Master amplifier main board. For instruction on compensation component selection, see Section 3.3.6.
  11. Check overall system gain to verify it is still correct. When setting the compensation values there may be a slight effect on system gain. When testing the system gain conduct the test in the mode in which the system will be used. Current mode system gain may vary slightly from voltage mode system gain. Adjust system gain on the Master amplifier using R105 and selectable components, R100 and R101.



**Illustration 3-18 System Wiring of an Example  
Two-Parallel, Three-Series, Single-Ended-Output Amplifier System  
(to be used with Wiring Harness Diagram of Illustration 3-16)**



---

### **3.2.5.8 Troubleshooting a Paralleled System**

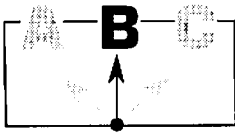
#### **General Tips**

If you have specific problems with your amplifier system, some of the following tips may be helpful:

- Verify that the interconnect interlock (pin 29) wiring is correct and that the connectors are in place on J6 connector.
- Verify that either “common” (voltage mode operation only) or “sampled common” is used consistently (not mixed) on all interconnect cable construction.
- Verify all Slave amplifiers are switched (S100) into Slave mode, and that the Master amplifier (S100) is in Master mode.
- Verify that the load is connected to the amplifier for current mode operation. If the load is not connected, system output will oscillate.
- If a problem exists in current mode, try changing the Master amplifier to voltage mode to help isolate the problem.

#### **Specific Problems**

- For excessive noise with no or little input signal, which clears up when the system is given a significant input signal, check the bias on the rear output wells of the amplifier. This procedure can be found in Section 7–8, “Adjust Output Stage Bias.” That section specifies R853 be adjusted for 0.400 VDC. In some system situations it is helpful to raise this bias only to no more than 0.550 VDC on all amplifiers in the system.
- For gain fluctuation problems, where the gain seems to change or drift over time, try soldering selectable resistors, R100 and R101. Although these component locations were designed for easy replacement, a few systems have shown noise and/or drift susceptibility to the electrical connections (when not soldered in place).



## 3.3 Internal Modifications

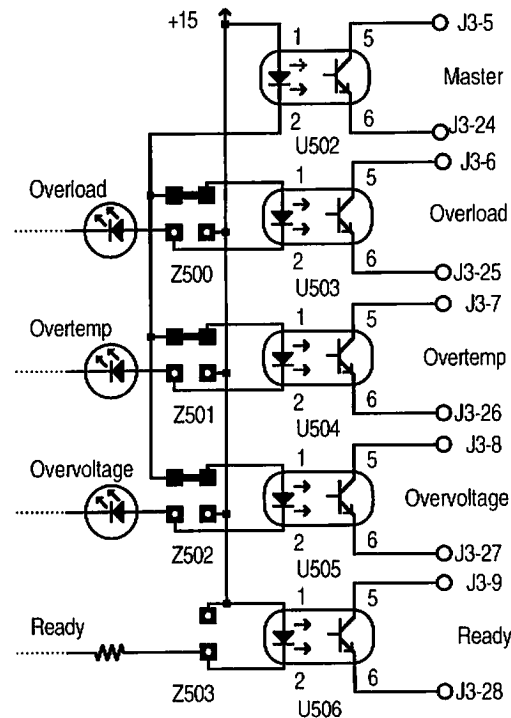
Previous sections have described applications that combine 7700 amplifiers. For such systems, the user must often modify circuitry or components to achieve specific application objectives. This section deals with some of the more common modifications.

### 3.3.1 Status Indicators and Signals

The front panel of the amplifier contains six LED status indicators. In addition to the LEDs providing visual indication on the front panel, U502 through U506 provide external status signals for remote operations.


Illustration 3-19 shows the "standard" configuration of the applicable sections of the main circuit board. This matches the printed circuit layout (unlike Schematic 9-6 that is electrically correct but the jumper blocks are not oriented as the user would see them).

Note the jumper positions Z500, Z501, and Z502. If U506 is not populated, you must jumper Z503.



**Illustration 3-19 Status Indicators (Standard Configuration)**

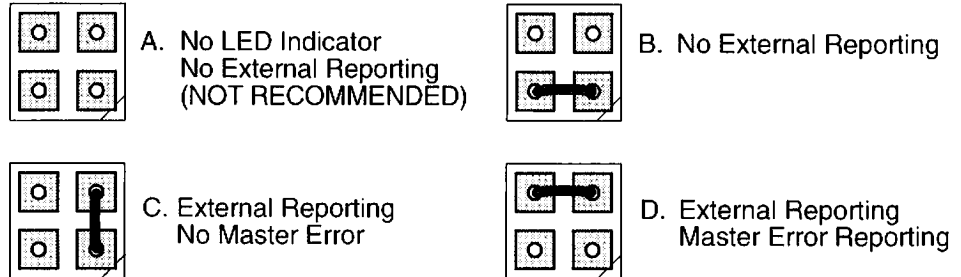
Jumpers Z500, Z501, and Z502 may be changed to achieve various results.



## CAUTION

If Jumper Z500 is changed, the reporting function of J3 pins 5 and 24 may change, resulting in incorrect information passing to the amplifier control monitor.

Illustration 3-20 shows how to modify Z500, Z501, or Z502 as the jumpers would be seen on the main board. They may be changed independently of one another. For example, in Illustration 3-22 Z502 is set in position "C" and the other two are set in position "D."

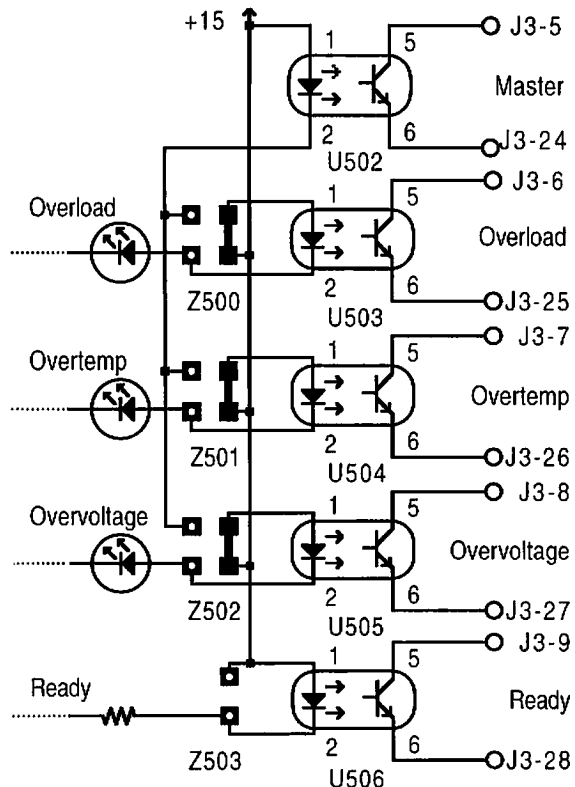


**Illustration 3-20 Z500, Z501, & Z502 Jumper Options**

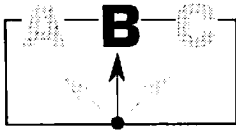
### 3.3.1.1 External Status Reporting

In the application example shown in Illustration 3-21, the jumper positions are changed at Z500, Z501 and Z502 so that there is no Master error reporting to J3.

This configuration will report the various amplifier status conditions at the rear panel connector J3 pins as shown in the diagram. For applications in which the amplifier status is used in any automatic function, the direct connection at J3 should be used.



**Illustration 3-21 Opto-Isolator Example #1**



### 3.3.1.2 Master Error Reporting

Illustration 3-22 shows a second custom application using optical-isolated status indicators. In this example, Jumpers at Z500 and Z501 connect the top two pins.

This configuration would continue to provide direct J3 reporting of OVERLOAD, OVERTEMP, and OVERVOLTAGE. But because of the Z500 and Z501 jumper positions, an OVERLOAD or OVERTEMP condition will also produce a Master error condition that could be read at J3 pins 5 and 24.

### 3.3.1.3 Optical Isolator Types

In addition to the wide range of custom applications that can be achieved through modifications to Z500-Z503 and U502-U506, selection of different models of optical isolators offers additional versatility.

Motorola Model MOC 8021 is the standard model optical isolator supplied by Techron. MOC 8021 is appropriate for DC signals. General Electric GE H1102 is an example of a pin-compatible model that can be substituted for ac signal applications.

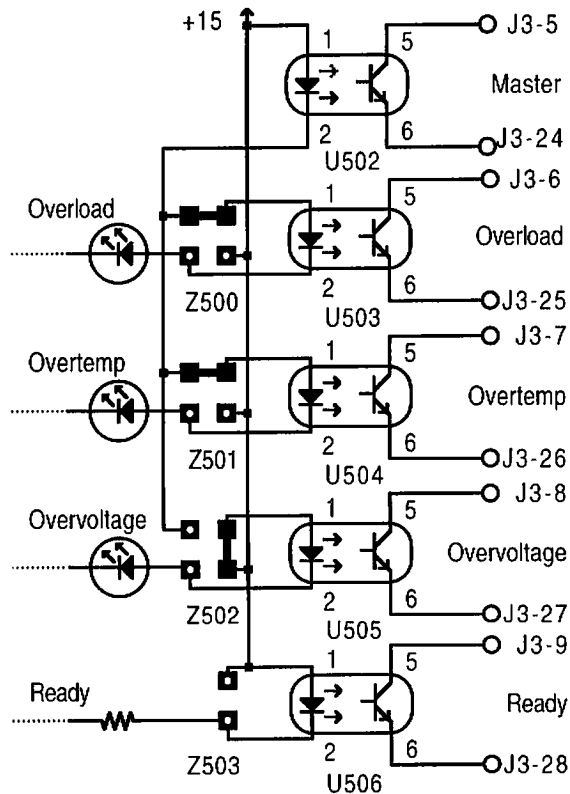


Illustration 3-22 Opto-Isolator Example #2

### 3.3.2 Remote Start

The 7700 amplifier can be enabled and disabled from a remote point by a computer or other type of industrial controller. The following sections describe several methods of grounding pin 29 for remote STANDBY.

#### 3.3.2.1 Relay Control

A relay is the simplest form of remote start. Use the appropriate set of contacts to cause the amplifier to go into STANDBY when the relay is energized. See Illustration 3-23 for appropriate connections to J3.

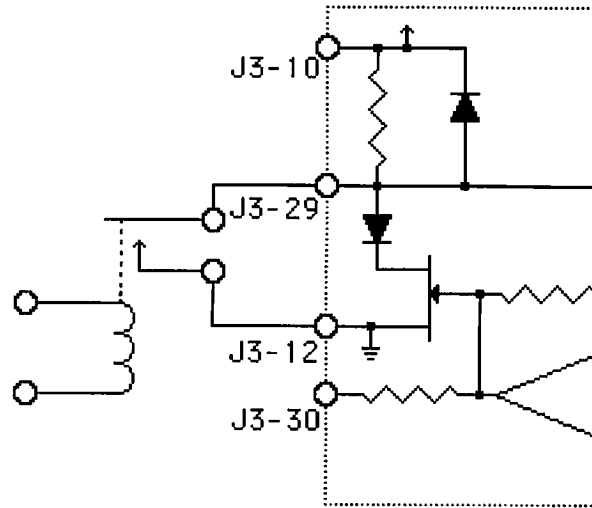


Illustration 3-23 Relay Control

#### 3.3.2.2 AC Control with Optical Isolation

To ENABLE the 7700 with a 120 Vac source, a suitable form of isolation should be used instead of the relay described above. An optical isolator may be employed. Illustration 3-24 shows a suitable system.

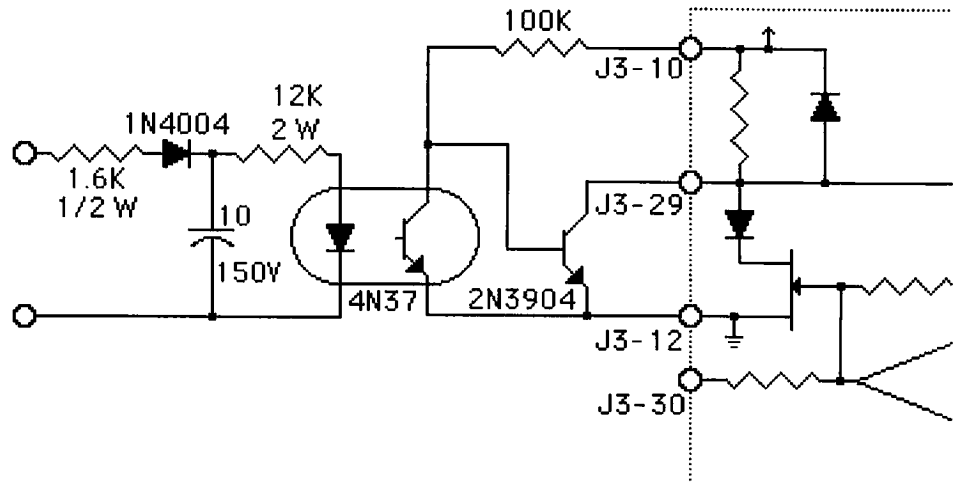
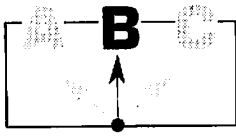


Illustration 3-24 AC Control with Optical Isolation



### 3.3.3 Turn-On Delay

Depending upon the specific 7700 application, the user may wish to change the delay period between STANDBY and READY. For example, in applications subjected to frequent OVERTEMP shutoffs, an extended turn on delay would prevent excessive switching of amplifier on and off. Model 7700 contains a provision for extending the turn on delay by changing two components on main board. The delay will cause the Model 7700 to stay in STANDBY condition for about seven seconds after a problem condition has disabled the amplifier (i.e., the amplifier will remain in STANDBY for about seven seconds before attempting to reset itself).

As configured in factory production, there is essentially no delay as the unit attempts to reset within microseconds after shutoff.

To convert Model 7700 to a delayed turn-on, make the following main board component changes:

Component	Factory Value	New Value
C504	3.3 $\mu$ f	10 $\mu$ f
R526	240 k $\Omega$	601 k $\Omega$

Table 3-4 Time-Delay Components

### 3.3.4 Input Sensitivity

Voltage gain and input sensitivity parameters of Model 7700 are controlled by the gain of three op-amp stages and the power amplifier. Illustration 3-25 is a schematic of this amplification chain.

The first stage of U100, U102, and the power amp section have fixed gains. The power amplifier section has a fixed gain of 20. U102 and the first stage of U100 have fixed gains of 1. The second stage of U100 normally has a fixed gain of 1 but can be adjusted. Three main board components that influence second stage gain of U100 are R100, R101, and R104.

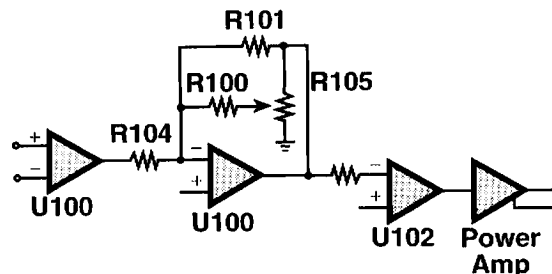


Illustration 3-25 Gain Control

---

### 3.3.4.1 Maximum Gain

The three resistors can be altered to change the gain. Gain is represented by the fraction:

$$\frac{R101}{R104}$$

The factory value for R101 is 10.2 kΩ and that of R104 is 10.0 kΩ. One or both components may be changed to produce the desired value of the R101/R104 fraction.

In addition to component replacement, R105 can be adjusted to change the gain by ±2%. For maximum gain, turn R105 fully *clockwise*.

### 3.3.4.2 Minimum Gain

For minimum gain, turn R105 fully *counterclockwise*.

Minimum gain is represented by the following fraction:

$$\frac{(R100) \times (R101)}{(R100) + (R101)} \\ R104$$

### 3.3.4.3 Fixed Gain

Fix the input sensitivity of Model 7700 by removing R100 and R105. The resistor locations are shown in Illustration 3-26. The sensitivity is then set by the value of R101/R104.

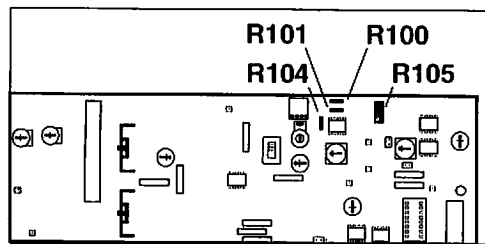
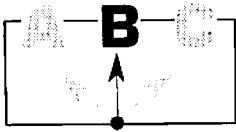


Illustration 3-26 Gain Control Resistors



### 3.3.5 Overload Indication

#### 3.3.5.1 Standard Overload Indicator

Techron 7700 amplifiers have a standard feature of overload indication that is generated from a window comparator circuit. The overload indication is directed to a front panel LED (see Illustration 3-27) and optically coupled to the J3 connector (pins 6 and 25) on the back of the amplifier.

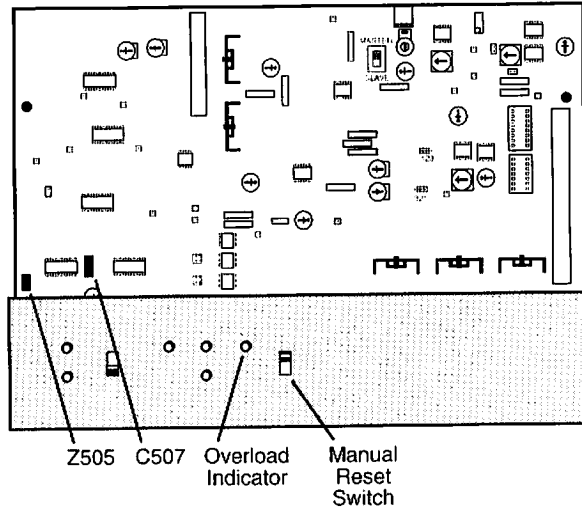


Illustration 3-27 Overload Indicator Component Locations

#### 3.3.5.2 Installing an Overload Latch

The amplifier's main board jumper Z505 (see Illustrations 3-27 and 3-28), when installed, enables an overload latch. The latch, once enabled, holds the amplifier in "standby" mode. To return the amplifier to "ready" mode, the Manual Reset Switch must be momentarily pressed down to the reset position. If the overload condition still exists the amplifier will revert to "standby."

The Z505 shunt (jumper plug), Part Number C6419-3, is available from Techron Service Parts.

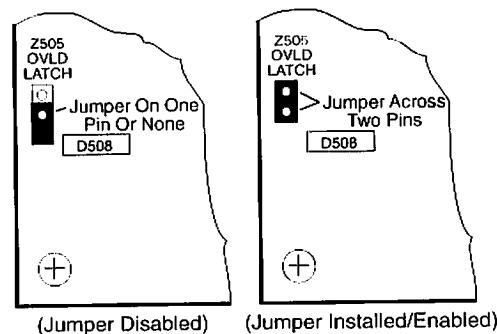


Illustration 3-28 Z505 Location and Configuration



---

### 3.3.5.3 Reducing Latching Sensitivity

The recognition speed of the overload detection circuit can be reduced by installing a capacitor in main board location C507. See Illustration 3-27.

Table 3-5 lists a few capacitor values and the resulting overload circuit sensitivity. The recorded “minimum pulse width” is the minimum duration of an overload that would typically trigger the detection circuit. The values recorded here are not guaranteed; they are only the test results from a sample of one amplifier.

Standard 7700 amplifiers are manufactured *without* installation of the Z505 jumper or C507.

C507 installed value	Minimum pulse width to indicate overload	Installation of Z505 jumper recommended?
None (default)	0.74 $\mu$ s	No (default)
0.015 $\mu$ F	0.10 ms	Yes
0.15 $\mu$ F	0.75 ms	Yes

**Table 3-5 C507 Values**

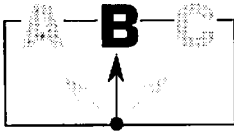
### 3.3.5.4 Why Install Z505?

Some Techron customers protect their load by using a fuse in the output wiring of the amplifier. If the 7700 amplifier is operating in current mode when an open load condition is experienced, the amplifier will oscillate. Oscillations that are detrimental to the amplifier may cause an overload indication. However, if the Z505 jumper is installed in such a situation, the overload latch will protect the amplifier from damage by placing the amplifier in “standby” mode.

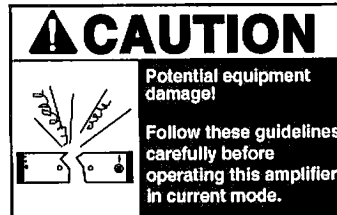
If you have two amplifiers connected in series with a load, depending on your configuration, you *may* need to install Z505. If you have three or more amplifiers connected in series you *must* install Z505. (Z505 may not be in 7780s earlier than revision C—the rev. number is on the serial number plate located on the lower right rear of the amplifier.)

### 3.3.5.5 Why Install C507?

The input signal to the window comparator experiences a short “glitch” when the amplifier is switched from “standby” to “ready.” If the overload circuit detection time is not modified, the amplifier must have the reset switch depressed while changing from “standby” to “ready” modes. For “normal operation” with Z505 installed, the minimum recommended value for C507 is 0.015  $\mu$ F.



### 3.3.6 Controlled Current Operation and Compensation



#### 3.3.6.1 CV Versus CC Operation

Techron 7700 series amplifiers are capable of operating as Controlled Voltage (CV) or Controlled Current (CC) sources. The amplifiers are factory set to the CV mode.

In *controlled voltage* (formerly called “constant voltage”) mode, the output signal is an amplified *voltage* representation of the input voltage signal. If the load’s impedance changes, the amplifier seeks to maintain the desired output voltage by changing the output current. Use this mode if you want the output voltage waveform to be like the input waveform.

In *controlled current* (formerly called “constant current”) mode, the output signal is an amplified *current* representation of the input voltage signal. If the load’s impedance changes, the amplifier seeks to maintain the desired output current by changing the output voltage. Use this mode if you want the output current waveform to be like the input waveform.



## CAUTION

Because the load in CC mode is part of the amplifier circuit, the relationship of the load to the amplifier is critical. *For proper and safe current-mode operation, you must observe the following guidelines:*

- You must properly attach a load before operating the amplifier. Use only the Output and Sampled Common terminals. Do not use the Common terminal. (The Common terminal is only for CV operation when use of the current monitor is not desired.)*
- The load must have a DC path. Do not use a blocking capacitor.*
- Never leave the load open. If you feel the load must be fused, which could lead to a potential open circuit, consult with Techron Application Engineering.*
- Ideally, the load should have some inductive component.*
- You must appropriately compensate for the load.*
- If oscillation occurs, turn off the amplifier immediately.*

*If you do not carefully follow these guidelines, you may damage the amplifier or the load!*

---

### 3.3.6.2 The Importance of Loads in CC Mode

Techron discourages the use of purely resistive loads in controlled current mode. Each load should have some inductive component. Amplifiers are most easily compensated to a resistive load that has an inductive component. If an amplifier is not compensated properly, it will not deliver an accurate output current.

Remember, in CC operation **the load is a critical circuit component and must always be connected to the amplifier!** If no load is attached, no current can flow. The amplifier, however, seeks to maintain a current specified by a combination of the input signal (if any) and control circuitry. The amplifier will vainly seek the impossible current requirement by raising the voltage as high as possible. The amplifier may then operate in an unstable manner with possibly damaging oscillations.

### 3.3.6.3 Selecting Controlled Current (CC) Mode

The amplifier is factory-set to CV mode. To set the amplifier to CC mode, complete these steps:

1. Place the Master amplifier of the system in standby or turn off power to the unit.
2. Loosen the four screws on the front cover of the amplifier and remove the cover.
3. Locate the jumper at B5 on the main circuit board. See Illustration 2-8.
4. Place the jumper over pins 2 and 3 (right-most pins).

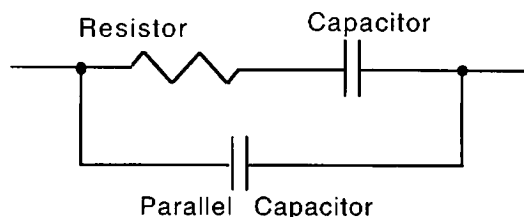
### 3.3.6.4 Compensating the Load for CC Operation

#### Preset Compensation

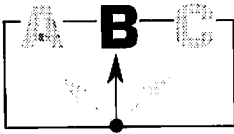
Controlled Voltage (CV) mode does not require compensation. However, Controlled Current (CC) mode requires compensation because the load is a critical part of the CC circuit.

A typical compensation circuit is shown in Illustration 3-29.

The amplifier has two preset compensations for CC operation, selected by Jumper B6 on the main board. See Table 3-6.



**Illustration 3-29 Typical Compensation Circuit**



Pins Jumped	Load Induct.	Load Resist.	Compens. Resistor	Compens. Capacitor	Parallel Capacitor
1 & 2*	1 mH	200 mΩ	R108 (270 kΩ)	C103 (0.0587 μF)	C105** (47 pF)
2 & 3*	0.250 mH	50 mΩ	R109 (68.1 kΩ)	C104 (0.234 μF)	C105** (47 pF)

\* **Note:** For Jumper B6, the pin position 1 and 2 is labeled "parallel" on the circuit board and position 2 and 3 is labeled "series." This silkscreen labeling on the board pertains to the original application for which the 7700 series was designed. This "parallel/series" labeling has nothing to do with present customer applications and should be ignored.

\*\* **Note:** The parallel capacitor C105, if installed, is part of the circuit regardless of the position of Jumper B6.

**Table 3-6 Default Compensation Values**

Many application loads, however, will have inductive and resistive values different than those for which the preset values were designed. Table 3-7 gives two examples of other loads and their corresponding user-installed components.

Load Induct.	Load Resist.	Compens. Resistor	Compens. Capacitor	Parallel Capacitor
0.4 mH	1.5 Ω	200 kΩ	0.001 μF	Not Installed
0.5 mH	0.5Ω	137 kΩ	0.0073 μF	Not Installed

**Table 3-7 Sample User-Installed Compensation Values**

The remainder of Section 3.3.6 forms a guideline for changing the compensation of the amplifier in controlled current mode. For this procedure, use C104 and R109. Jumper B6 is in the left position. (Alternately, with Jumper B6 in the right position, C103 and R108 could be substituted.)



## WARNING

Never enable an amplifier in controlled current mode without a load attached. Doing so may damage the amplifier.

When servicing an amplifier or connecting a load to it, always disconnect power. Potentially lethal voltages are present inside an amplifier and at its output.

### ***Approximating the Compensation Values***

Approximate values of C104 and R109 may be calculated mathematically. Calculate the approximate value of R109 using the following formula:

$$R_c = 20,000 \times 3.14 \times L \times BW$$

- R<sub>c</sub> is compensation resistance in ohms.
- L is load inductance in henries.
- BW is bandwidth in hertz.

Calculate the approximate value of C104 using the following formula:

$$C_c = \frac{L}{R \times R_c}$$

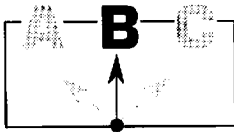
C<sub>c</sub> is compensation capacitance farads.

- L is load inductance in henries.
- R is resistance of load in ohms.
- R<sub>c</sub> is compensation resistance in ohms.

### ***Optimizing the Compensation Values***

Find the optimum values of R109 and C104 by using an RC decade box and an oscilloscope using the following procedure.

1. Ensure power to the amplifier is off.
2. Connect the load between the “output” and “sampled common” terminals.
3. Connect an oscilloscope to the current monitor (or use a current probe).



**Note:** The correct way to monitor output current is at the current monitor using an oscilloscope. When measuring and comparing input voltage, output voltage, and output current, remember to use only one ground connection to your oscilloscope. Operate your oscilloscope through an isolated ground, such as is accomplished with an isolation transformer, or by using only differential inputs. Floating the third wire ground of the oscilloscope may accomplish the same result, but it is not recommended.

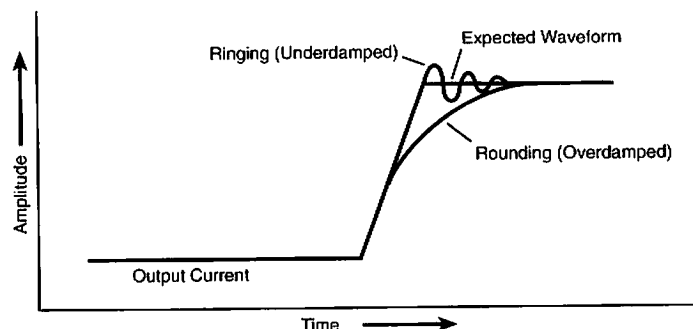
4. Short all the terminals, (+) (Gnd) (-), together on the amplifier's input.
5. Select current mode operation with B5 (pins 2 and 3) and the compensation values of C104 and R109 with B6 (pins 2 and 3).
6. Apply power to the amplifier and place it in "ready" mode.
7. Verify the amplifier is stable with the input shorted. (If compensation for an attached load is far from what is needed, the amplifier may start oscillating even without a signal. If oscillation occurs, reduce resistance in the compensation circuit until the oscillation stops.)



## CAUTION

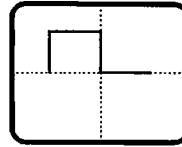
If the amplifier starts oscillating, immediately switch the amplifier to "standby" mode.

8. Connect a signal source or generator to the input. If your amplifier has balanced signal input capabilities, consult your manual to verify proper input connections.
9. Input a square wave or squared pulse at a low level (typically 0.25–1.0 V). A limited rise time, repetitive pulse of low duty cycle is preferred. Observe the output current through use of the current monitor (or current probe). Look for clean transition edges. Ringing or rounding on the transition edges indicate compensation problems (see Illustration 3–30). Some adjustment of factory-set compensation will probably be necessary for optimum amplifier performance (unless special ordered).
10. Connect a resistance-capacitance decade box (via soldered wires) as close to the actual component location (R109 and C104) as possible.



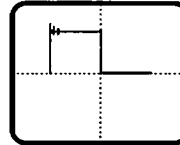
**Illustration 3-30 Compensation Effects on Waveform**

11. If a change in compensation is necessary, the resistor component of the compensation circuit is the most likely candidate to change first.



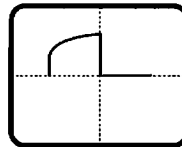
*Optimum Compensation*

- 11a. If the output current waveform is ringing, the circuit is underdamped. You have too much gain and should lower the resistance.



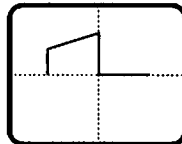
*Decrease R*

- 11b. If the output current waveform is rounded, the circuit is overdamped. You have too little gain, and you should increase the resistance.



*Increase R*

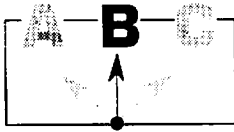
- 11c. If the top of the square wave is not level, increase the capacitor value.



*Increase C*

- 11d. Use about 10% increments in resistance changes, but capacitor value changes are usually best made by a factor of 2 or 3.
- 11e. Due to slight differences between the inductance and capacitance of the decade box and discrete components, the values of the discrete components may have to be adjusted slightly. If possible, use 1% metal film resistors. Techron discourages installation of potentiometers in the resistor location of the compensation circuit (because of lower stability and possible added inductance).
12. The optional parallel capacitor (see Illustration 3-29) serves to increase stability. The parallel capacitor, if used, will usually decrease the value of resistance needed. The value of a parallel capacitor is usually between 47 and 150 pF or it usually isn't used at all.
13. Contact Techron Application Engineering department for additional assistance in modifying amplifier compensation.

**Note:** In multiple amplifier systems, expect to decrease the value of R109 in series systems (by 1/2 for 2 units), and increase the value (double for 2 units) in parallel systems.



### 3.3.7 Alternative Supply Voltage

Model 7780s and 7790s are factory wired for a specific supply voltage. For new applications, users can make limited modifications to allow operation under different voltages.

The following subsections describe two types of conversions.

1. For U.S. domestic users to convert 208 Vac to 240 Vac and vice versa (see Section 3.3.7.1).
2. For international users to make conversions between 380 Vac and 415 Vac (see Section 3.3.7.2).

To access the transformer perform the following steps **AFTER** removing power to the amplifier.

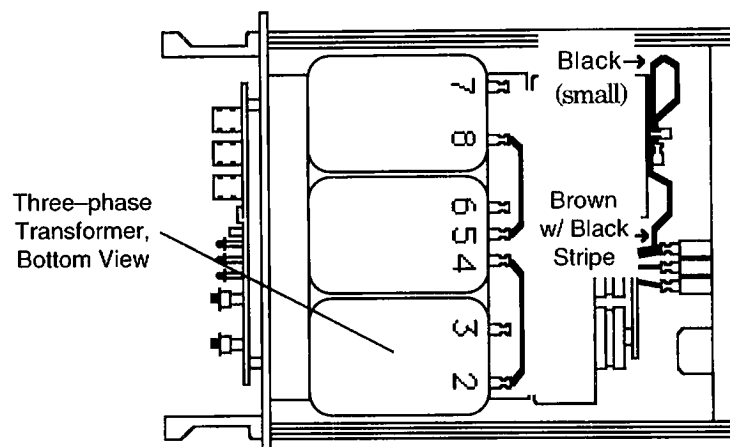
**⚠ DANGER**

Disconnect the amplifier from the ac mains to avoid potentially lethal electric shock before making the wiring changes described below. Review Section 6.2.1.

1. Place the amplifier on its side.
2. Remove the rear screw holding the bottom panel and slide the bottom panel out toward the rear.

#### 3.3.7.1 208/240 Volts Conversion (Model 7780 Only)

Illustrations 3-31 and 3-32 show transformer wiring for the 208 Vac and 240 Vac configurations. The views are from the bottom of the amplifier. Conversion between the two voltages requires changing the wiring connections to match the wiring diagrams in the illustrations. The following steps will be helpful in interpreting the diagrams:



**Illustration 3-31 208 Vac Transformer Wiring**



**Main Transformer:**

1. Lugs 2–8 are marked on the X, Y, and Z coils of the main transformer.
2. Both voltage levels require the coil connections listed in Table 3–8.

AC Voltage	Leg 1 (black)	Leg 2 (black & white)
208	5 and 8	2 and 4
240	6 and 7	3 and 4

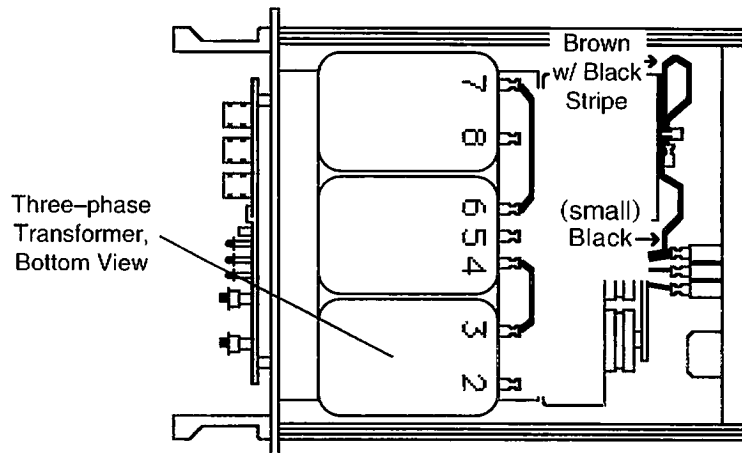
**Table 3–8 Transformer Coil Connections (Domestic)**

**Control Transformer:**

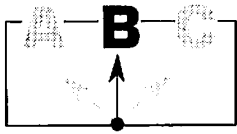
3. The terminals on the right side of Illustrations 3–31 and 3–32 show the main circuit breaker at the back of the amplifier. Do not remove the big black wire from the circuit breaker terminal. The Control Transformer Wire attaches with it to the circuit breaker terminal. From the control transformer wire bundle, select the Control Transformer Wire for the desired voltage according to Table 3–9.

AC Voltage	Control Wire
208	Brown/Black Stripe
240	Black (small)

**Table 3–9 Control Transformer Wire Connections (Domestic)**



**Illustration 3–32 240 Vac Transformer Wiring**



**⚠ DANGER**

Disconnect the amplifier from the ac mains to avoid potentially lethal electric shock before making the wiring changes described below. Review Section 6.2.1.

**3.3.7.2 380/415 Volts Conversion (Model 7790 only)**

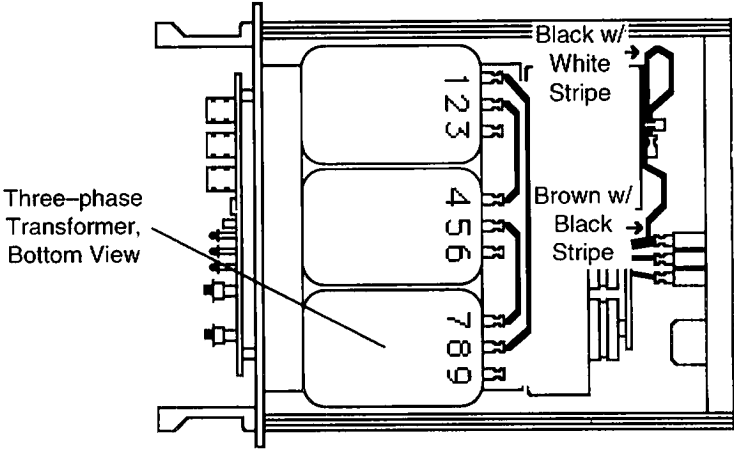
Illustrations 3-33 and 3-34 show transformer wiring for the 380 Vac and 415 Vac configurations. Conversion between the two voltages requires changing the wiring connections to match the wiring diagrams in the illustrations. The following steps will be helpful in interpreting the diagrams:

Main Transformer:

1. Lugs 1-8 are marked on the X, Y, and Z coils of the main transformer.
2. Both voltage levels require the coil connections listed in Table 3-10.

AC Voltage	LEG 1 (Black/ Yellow)	LEG (Black)	LEG 3 (Black/ White)
380	1 and 8	2 and 4	5 and 7
415	1 and 9	3 and 4	6 and 7

**Table 3-10 Transformer Coil Connections (International)**



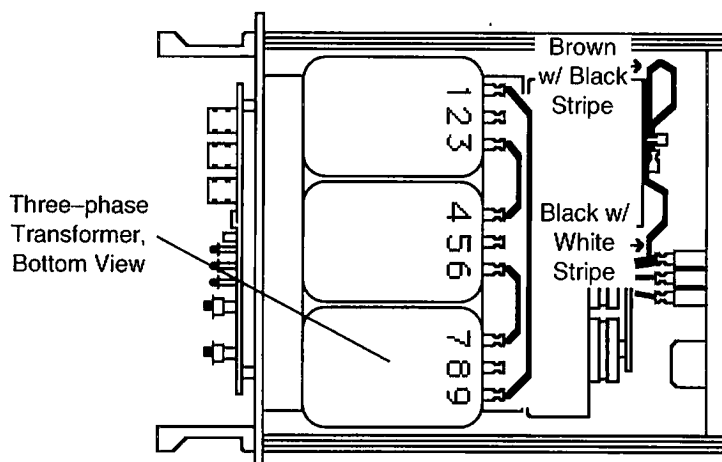
**Illustration 3-33 380 Vac Transformer Wiring**

**Control Transformer:**

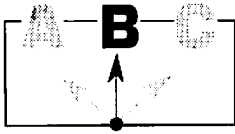
3. The terminals on the right side of Illustrations 3-33 and 3-34 show the main circuit breaker at the back of the amplifier. Do not remove the big black wire from the circuit breaker terminal. The Control Transformer Wire attaches with it to the circuit breaker terminal. From the control transformer wire bundle, select the Control Transformer Wire for the desired voltage according to Table 3-11.

AC Voltage	Control Wire
380	Brown/Black Stripe
415	Black/White Stripe

**Table 3-11 Control Transformer Wire Connections (International)**



**Illustration 3-34 415 Vac Transformer Wiring**



---

## 3.4 Amplifier Accessories List

Descriptions and part numbers of items used in customizing amplifiers and constructing amplifier systems are listed below.

**50 m $\Omega$  250 W Resistor**, Part Number C6892-1, A10089-10808 (screws), A10094-6 (washers). Used as a ballast resistor in parallel configurations of amplifiers. Mounts to the rear of each amplifier in the system.

**OPTOC-1 Optical Coupler/Isolator**, Part Number OPTOC1. Optically couples the interlock signals between 7700 amplifiers configured in series with a shared load. Isolates the interlock systems of all amplifiers above ground potential.

**J200 DIP Header/Cap**, Part Number C6957-2 (Header), C6958-0 (Cap). Used in parallel configurations of amplifiers. Mounts to J200 on the Main Circuit Board.

**Shunt/Jumper Plug**, Part Number C6419-3. Connects two pins on circuit board. Used for Z505 overload latch and other applications.

**2.4 M $\Omega$  Resistor**, Part Number A10266-2451. Used in trimming resistor network to modify R203 (in multiple series *and* parallel systems).

**24.9 k $\Omega$  Resistor**, Part Number C6482-1. Used in trimming resistor network to modify R203 (in multiple series *and* parallel systems).

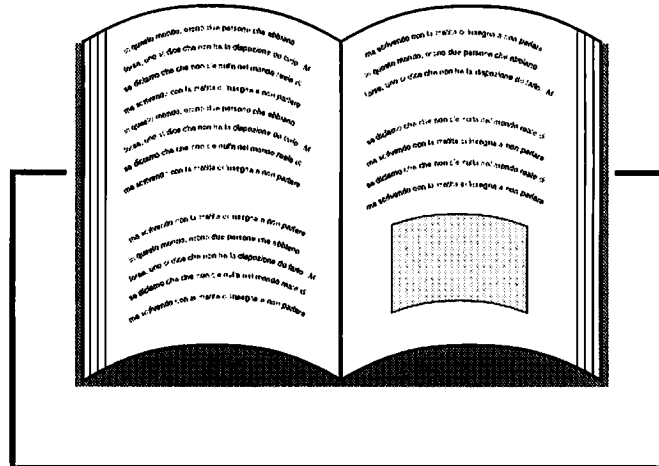
**500  $\Omega$  Potentiometer**, Part Number C3668-8. Used in trimming resistor network to modify R203 (in multiple series *and* parallel systems).

**100  $\Omega$  Potentiometer**, Part Number C6173-6. R254 used for balancing amplifier outputs in a parallel system.

**1.27 k $\Omega$  Resistor**, Part Number A10265-12711. Used with R254 for balancing amplifier outputs in a parallel system.

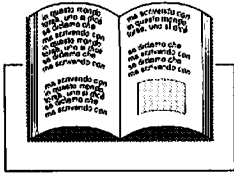
**3-Phase AC Plug, female, 20A**, Part Number C 7060-4. Used to connect power to the system.

**37-Pin D-sub connector, male**, Part Number C 6968-9, C 6969-7 (cover), C 7051-3 (screw kit). Used with custom input system.



## ***Section 4—Principles of Operation***

This section descusses the principles upon which a Techron 7700 Series amplifier functions.



## 4.1 Principles of Bridge Amplifiers

The fundamental objective of a power amplifier is to transfer energy from an available supply to a load in a prescribed, controlled manner. Voltages in excess of  $\pm 120$  peak volts or  $\pm 160$  amperes are available (load and duty cycle dependent). The load current may be the programmed output variable and not the voltage. This controlled current mode is useful in areas where the field produced by a coil needs to be proportional to coil current and not voltage.

### 4.1.1 Output Stage Topology

Illustrations 4-1 and 4-2 are block diagrams of the topologies commonly used for direct-coupled amplifiers. The totem-pole is the most common and makes available a peak voltage to the load of  $1/2$  of the total supply voltage ( $V_{cc}$ ) while exposing the output stage devices to stress from the total supply voltage ( $2 V_{cc}$ ). Only one half of the supply is used at a time, reducing the supply operating efficiency as well. The full bridge output stage as shown makes full use of the available supply voltage as the peak output to the load is  $2 V_{cc}$ .

The peak-to-peak output voltage of the full bridge is actually twice the available supply voltage ( $4 V_{cc}$ ). The maximum voltage stress to the output stage devices is the same as in the totem-pole topology ( $2 V_{cc}$ ). The supply use is now total.

### 4.1.2. Output Stage Synchrony

Operation of the full bridge to produce a positive output current requires that the output stages one and three be increased in conductance in synchrony and output stages two and four be decreased in synchrony, decreasing as one and three are increasing.

In class AB operation, the conductance of two and four would diminish to zero and stages one and three would increase to the level required to carry the desired positive peak output current. For a negative output current the roles of the pairs one and three and two and four are interchanged with two and four ultimately carrying the negative peak output current.

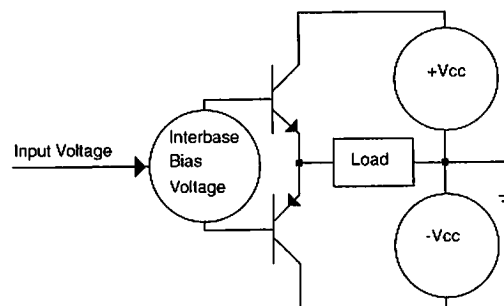


Illustration 4-1 Totem-Pole Topology

### 4.1.3. Output Stage Terminology

The names one, two, three and four are not the names that are preferred for describing the output stages. Since the output stages are constructed with bipolar transistor devices, the preferred and more descriptive terminology is to name an output stage in terms of whether the stage acts as a giant NPN or PNP stage and whether it is on the high (output) side of the load or low (ground) side of the load. Thus stage one is generally referred to as the high side NPN stage and stage three is referred to as the low side PNP stage.

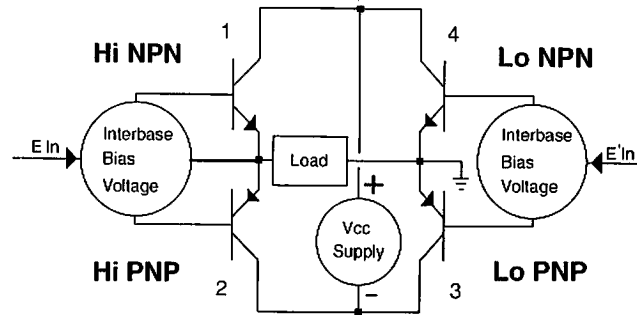


Illustration 4-2 Full Bridge Topology

### 4.1.4. Transistor Topologies

There are four basic composite transistor topologies (Illustration 4-3) which may be used in any configuration which can be derived by recursive application of the forms. Other three terminal devices such as FETs could be substituted for the bipolar transistors without loss of generality. In the application of the Model 7700 all of the devices of the output stages are bipolar. The principal output devices are NPNs paralleled 20 times. They are driven in two groups of ten from a pair of NPN driver transistors (Darlington form). NPN stages use an NPN predriver (Darlington form) driving the drivers. PNP stages use a PNP predriver (Complementary form) driving the drivers.

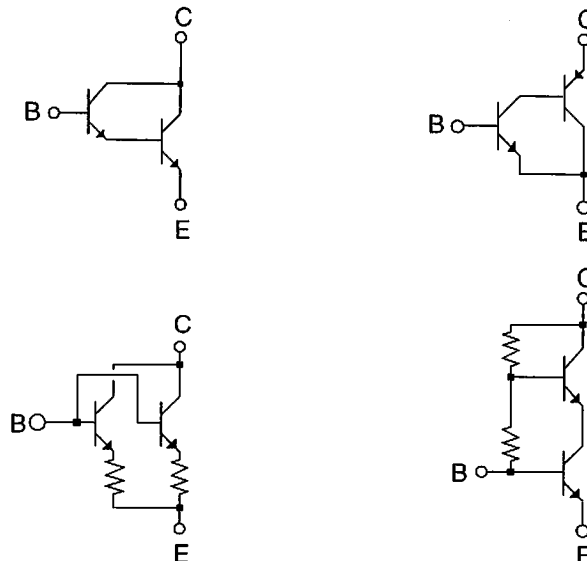
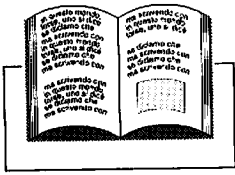


Illustration 4-3 Composite Transistor Topologies



---

### **4.1.5. Output Stages**

The Model 7700 is built around a voltage amplifier which first drives the high side of the bridge. The low side of the bridge is in turn driven from the high side such that one half of the voltage of the output signal is imposed on the supply rails. This condition constitutes the proper synchrony of the stages of the bridge. Note that the amplifier dissipation is distributed evenly over 40 output devices for a single polarity of output current. Negative feedback is used liberally to acquire the control of the bridge balance and insure the required overall linearity. Therefore, high-gain, wide bandwidth IC op-amps are used.

### **4.1.6. Protection Circuitry**

As with all things, there is a breaking point in amplifiers. Protection circuitry is used to prevent electrical stimulus from reaching the breaking point. When continuing a high level of output current would cause the output semiconductors to overheat, the current must be reduced to limit the junction temperature. A fundamental problem of protecting output semiconductors is that they do not have an output terminal which indicates the junction temperature. The critical parameter is sealed inside opaque metal cases.

This has led to the use of simulation methods to predict the junction temperature. An electronic analog of the heating process is created which can be monitored for excessive equivalent temperature. An electronic multiplier is used to compute instantaneous power by computing the product of the semiconductor voltage and current. Its output is applied to an electrical impedance which is designed to have the same time characteristics as the junction. The ambient temperature is added to the output. The result is an electrical analog signal proportional to the absolute temperature in degrees Kelvin of the output semiconductor junctions. This temperature information is then compared to the maximum allowed junction temperature of 200 °C and the current drive to the output devices is reduced to prevent the temperature from becoming excessive.

Electronic power supply interlocking is used to allow multiple amplifiers to power a common load. Should any one unit of a system not be able to operate, it is imperative that none of the units be active. The amplifiers must enter the ready state in unison. A disabled amplifier could be damaged by large output signals from its companion units.

The heat sink materials are protected from excessive temperatures (over 150°C) by thermal limit switches. Exceeding the instantaneous current limits of the output transistors is prevented by electronic current limiters.

The power transformer is protected against overtemperature conditions by internal limit switches which are coupled to the interlock and power control circuitry. Fault conditions in the power supply are protected with circuit breakers. A fault in the output stages is electronically detected and the main supplies are disabled until the control circuitry is down-powered and re-powered.



---

## **4.2. Input Signal Processing and Current Control**

See *ISA Front End* schematic for the discussion of the Input and Current Control stages.

The analog input to the amplifier is connected through the rear panel barrier block labeled INPUTS. One half of U100 forms an active differential input. The common mode rejection of the analog input is tuned for optimum rejection at low frequencies by adjusting the trimmer of resistance network N100. The high frequency common mode of U100 is adjusted by tuning C101 which is tuned to set  $C100 + C101$  equal to C110.

R104, R100, R101, R105 and the other half of U100 form an adjustable gain stage that can be set up in a number of ways. C102 and R106 provide proper source impedance for minimum offset drift.

### **4.2.1. Current Sensing**

The load current of the amplifier is sensed by six parallel resistors (R758-763) in the output current control loop. U104 forms a differential amplifier with an adjustable gain control in the resistor network N103. Resistors R118 and R119 along with C107 and C108 compensate the sense resistors for their series inductance. The output of U104 is calibrated for 20 amperes per volt of monitor output. The offset voltage of U104 is eliminated by adjustment of R121 via R120. Z100 and Z101 are used to change the scale of the current monitor from 20 amps/volt to 10 amps/volt. U103, R123 and R124 invert the output of U104 so that the output of U103 and U104 provide a differential output. This differential output is used if the amplifier is used in a paralleled system. R125 and R127 isolate the op-amps from any capacitive load.

N101, U101, N102 and one half of U102 form a high impedance differential input mixer-averager.

The mixer stage sums current information from all paralleled amplifiers in a system. By summing the current of all amplifiers in a parallel system, current flowing between chassis due to gain mismatch of amplifiers does not affect the current of the load. The voltage at T101 is proportional to the true current in the load.



---

## **4.2.2. Controlled Current Compensation**

C105 and the B6 selectable network of R108 and C103 or R109 and C104 comprise the principal compensation networks which serve to control the open loop gain of the closed-loop controlled current system. The network selected by B6 is taken from the output of the main amplifier to reduce the amount of charge stored in the compensation capacitor should an overload of the control amplifier be allowed. In the controlled voltage mode of operation these compensation parts are not used.

## **4.2.3. Current Control Amplifier**

The controlled current mode works by U102 comparing the current output of the amplifier with the desired current at the output of U100, pin 7. The current control amplifier, U102 whose output is pin 6, is offset zeroed by R117 via R116. R103 and C106 provide the proper impedance to U102 for minimum offset drift.

## **4.2.4. Input Clipper**

The input clipper allows the amplifier to be operated with controlled output voltage limits that are not subject to minor line voltage fluctuations if so desired.

D100, D101, Q100 and Q101 form a bridge with Q100 and Q101 performing as high quality diodes. This bridge clamps the output of U102 at pin 7 if it exceeds 10.3 volts. The output level of the controlled current stage is adjusted by the value of R113, R115 and the setting of R114.

# **4.3. Gain Stages**

See *ISA Gain Stage* schematic for the discussion of the gain stages.

The full bridge output stage is controlled by first driving the high side of the bridge. The low side of the bridge is driven such that half of the output voltage is impressed on the Vcc supplies. The gain stages control the drive and balance of the bridge.

## **4.3.1. Error Amplifier**

Amplifier U202 is a high performance monolithic FET input op-amp. Local degeneracy is provided by C202. The main feedback loop around the power amplifier forms a non-inverting gain of 20 using R208, R251, C204 and R207. The -1 input used with slave operation is provided by R203, R250 and C216. U202's offset voltage is compensated by R204 through R205.

---

R202 and C200 function as a filter for RF input suppression. R200, R201, R253 and C215 form a non-inverting input of +1 gain for use with the slave mode of operation. R254 provides precision gain adjustment when the +1 and -1 inputs are used for amplifiers in parallel. R253 and C215 are used to provide phase compensation for the input to output transfer function. Likewise R250 and C216 compensate the -1 input phase response. S100 is used to switch between the master and slave modes of operation. In the master mode, the signal input to the power amplifier is derived from R110 via the upper half of S100. The -1 input is then grounded by the lower half of S100.

### **4.3.2. Last Voltage Amplifier**

Drive to the high side of the output stage comes from the last voltage amplifier. Q212 and Q215 form this amplifier. The last voltage amplifier is current limited by D202-D204 and D205-D207. This provides a slew limit in that the load to the stage is dominated by capacitance in the output stage. Q212 and Q215 are emitter degenerated by R243-R244 and R262-R263. A partial pole removal is performed by bypassing R243 and R244 with C209. C219 likewise bypasses R262 and R263. Q209 and Q216 form emitter follower stages that drive the relatively high input capacitance of Q212 and Q215.

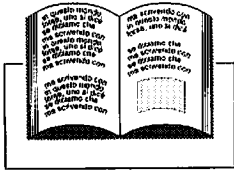
### **4.3.3. Current Limiting**

Current limiting of the output stages is provided by D200 and D201 and transistors Q213 and Q214, which limit the output drive of the last voltage amplifiers. R256, R271 and R257 adjust the positive current limit and R258, R272 and R259 adjust the negative. R267 and C223, along with R268 and C224, by joining the output signals and supplies respectively, reduce the inductance of these lines by paralleling.

C211 and C212 provide high frequency feedback from the output to the input of the last voltage amplifiers. Input signals to the amplifiers are currents input to the bases of Q209 & Q216 and R206 & R241.

Currents to the input of the last voltage amplifiers are provided by the grounded base stages of Q203 and Q204. Voltage dividers R246, R247, R248 and R249 provide operating states for Q204 and Q203 which prevent the forward biasing of the base collector junctions even when the output flyback diodes are forward biased and the Vcc supplies swing slightly beyond ground.

Complementary differential amplifiers drive Q204 and Q203. Q205 and Q202 amplify the difference between the feedback signal from the output and the input signal from U202. The feedback signal is attenuated by R265, C221, R216, R213, R215, R223, and R218. The input signal is coupled through R242, R214, C205, R219, R217 and C220. The operating state of Q202 and Q205 is such that collector operating voltage is insured no matter what signal conditions prevail. Emitter degeneracy with partial pole removal is provided by R211-212 and R220-221 and C217 and C208.



---

Current sources which bias Q202 and Q205 make it possible to interrupt the drive to the amplifier. The protection circuitry controls these bias currents. Q205 is biased by U200, a monolithic current mirror. Biasing Q202 is Q200 and Q201 which form a mirror and function well due to emitter degeneracy using R209 and R210 in the absence of being monolithic. Controlled currents are provided by signals +LH and -LH from the protection circuits. R222 causes the input characteristic of U200 to be identical to the input characteristic of the mirror of Q200 and Q201.

#### **4.3.4. Bridge Balance Amp**

The bridge is balanced by U203 which drives the two low sides of the bridge output stages through R226 & C206 and Q206 & Q207. If sufficient current is developed in the output of U203, the voltage across R225 or R227 will cause Q206 or Q207 to conduct and aid the output drive demand. C206 provides some phase lead to improve the stability margin of the bridge balance loop. Current to drive the NPN low side output stage is provided by a current mirror composed of Q210, Q211, R229 and R230. This current source may be disabled by the protection circuitry removing current from line +LL. In a similar manner, the current drive to the PNP low side output stage is provided by U201, a monolithic current mirror. U201 is driven from the protection circuit control line -LL. R231 is used to degenerate the input characteristics to mimic the NPN side mirror.

U203 drives the low side output stages such that the feedback signal through R232, C214 and R233 produces the same current that is produced by the input signal through R240 from the high side output. A dc current is flowing in R232 and R233 which is incidental to the process of monitoring the Vcc supplies. Offset errors caused by mismatch of R232 and R233 are compensated with the static balance control, R234 through R235. Signal balancing of the bridge is accomplished by using the dynamic balance control of R236 and R237 which shunt the feedback divider resistors, R238 and R239.

The static balance is adjusted by setting +Vcc equal in magnitude to -Vcc. Adjustment of the dynamic balance is accomplished by loading the amplifier for full current when driven by clip level low frequency signals. U203 should saturate just before U202.

Local degeneracy of U203 is provided by R264. R252 is used to reduce the interaction of the dynamic balance control and the amount of output current being drawn from the amplifier. The voltage on the output of U203 is determined by the degeneracy of the output stage and the current sampling resistors in the output assembly, R758-R763.

Capacitors C201, C203, C207 and C218 bypass the 15 volt supplies to the op-amps. High frequency types such as used for U202 and U203 require local bypassing for stability.

---

## **4.4. Output Stages**

Each output stage or quadrant is built on a separate, electrically isolated, forced-air heat sink. Twenty NPN bipolar output transistors are directly mounted to each sink. By allowing each heat sink to be electrically isolated from the chassis and the other output stages, the devices are able to be connected without insulating mounting hardware directly to the heat sink. Lower junction temperature for the output transistors is provided by this mode of operation.

The twenty output devices are driven by two NPN bipolar devices, each driving ten of the outputs. The output devices are divided with ten to one side of the heat sink and ten to the other side. The driving transistors are located on the opposing sides of the heat sink. This cross-coupled orientation is used to provide thermal degeneracy on a side-to-side basis.

Wiring of the emitter and base circuits of the output devices and drivers is provided by two printed circuit boards which are placed at the bottom of the upper channel of the "H". The output device emitter wiring circuit board is below the output device base wiring circuit board. The circuit board material is a high-temperature material to allow operation to a temperature limit of 150°C.

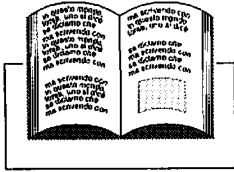
The entire output sink may be disconnected and removed from the amplifier by removing six fasteners and the connecting small signal wiring which passes over the top of the heat sinks. Two of the fasteners at the middle of the heat sink are used to connect the high-current signals to the sink. The remaining four fasteners at the ends of the sinks are provided for mechanical support.

### **4.4.1. Output Stage Predrivers**

Both drivers are driven by Q650 through a compensation network composed of L650, C650, and R650, all of which are located on the predriver circuit board mounted above the heat sink. Driver base current removal can be expedited by Q651 in the case of rapidly switching currents. This device will not see much action in normal use. A system would need to become unstable for this device to come into use. This topology is shared by the low side NPN stage but is different than the PNP stages.

### **4.4.2 Output Stage Drivers**

The drivers are Q610 and Q611 respectively. Half of the output transistors on each end of the heat sink are driven by one of these two devices. Base emitter resistors, R612 and R613, are used to set the quiescent current point of the predriver devices and remove current from the bases of the drivers. This structure is common to all four of the output stages.



---

### **4.4.3. Output Transistors**

Referring to the schematic of the output stages, it may be seen that the high side NPN output devices are labeled Q600-609 and Q612-621. Emitter current is used to provide the needed degeneracy for paralleling by using the resistors R601-610 and R615-R624. Base current is removed from the output devices by the resistors R611 and R625 and R614 and R626. A high-frequency load is provided for this stage by using a series RC formed by R600 and C600. This structure is common to all four of the output stages.

### **4.4.4. Output Stage Bias**

The quiescent bias current of the high side of the bridge is controlled by Q652 which is connected as a Vbe multiplier. Q652 is thermally joined to the heat sink and compensates for the base-emitter voltage temperature coefficient of the drivers and output devices. The base-emitter coefficient of the predriver is compensated by D650. R651 in series with R652 is used to adjust the bias. With no load current and 25 degrees Celsius heat sinks, the bias may be adjusted by setting the voltage across either R611 or R614 to 0.400 VDC. R654 is used to reduce any sensitivity of the quiescent bias point to the current flowing through the bias circuitry from the last voltage amplifiers of the gain stages. C652 prevents instability in the bias servo.

The NPN low side output stage has the same construction and biasing procedures.

C654 and R655 join to the input of the high side PNP output stage. The result is reduced inductance in the input lead of each stage which improves stability in the predriver stages. C653 and C651 compensate the entire output stage and provide a capacitive load to the current limited last voltage amplifiers to form a slew rate limit mechanism.

D600 and D601 sample the stage and drive the fault detector of the high side of the bridge. Should an output device fail with a collector to emitter short, the base of the output devices will be powered by the breakdown of the base emitter junction of the failed device.

The PNP output stages are similar to each other in structure. The high side PNP stage has an identical output configuration to the NPN stage. Collector current is sampled by resistors R701-710 and R724-733. The predrivers are the major difference between NPN and PNP stages. Q750 is the predriver to the drivers, Q710 and Q711 of the high side PNP stage.

Compensation is provided by the emitter network composed of R750, L750, and C750. C701, C751 and C752 are also used for stage compensation. D750 is used to temperature compensate the base-emitter junction voltage coefficient of Q750.

Additional high frequency compensation is incorporated in the low side of bridge output stages by using RL networks in the emitter leads of the drivers. The inductors are constructed with ferrite beads. Using the low side NPN stages as an example, R857 and R858 are in parallel with the beads.

---

### **4.4.5. Temperature Sensors**

IC temperature sensors U800 and U900 are used on the low side of the bridge stages to provide information to the protection circuitry. The output of each of these sensors is a current proportional to the absolute temperature. The signals +TEMP and -TEMP are scaled as 10 millivolts per degree Kelvin. Since the bridge is balanced in actual operation, the temperature of the NPN high side of the bridge should be essentially the same as the low side PNP output stage.

Overtemperature in the output heat sinks is prevented by bimetal switches (TS1 and TS2) mounted on the high side of output stage heat sinks.

### **4.4.6. Output Termination**

The output stages drive the load through an output terminator network composed of L90, C90, R91, C91, R92 and C92. This network is used to provide isolation from the load and a consistent high frequency load for the amplifier in R90 and R92.

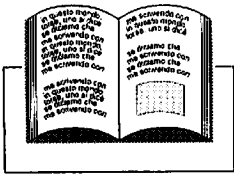
R90 is a resistor with a positive temperature coefficient. Rapidly rising output current will cause R90 to increase in resistance. This forces more current through L90, protecting R90 from burn out.

### **4.4.7. Flyback Diodes**

Flyback pulses from inductive loads are prevented from reverse biasing the output stages by D607, a high current bridge rectifier mounted beneath the output shelf and next to the bus bar assembly. The bus bar assembly is used to provide a very low inductance/high current interconnect system to the output stages.

### **4.4.8 Output Current Sample**

Output current may be sampled by attaching the load to the terminal labeled SAMPLED COMMON. R758-R763 are used to produce a voltage for the current control circuitry of the input stages. Use of the output terminal labeled COMMON bypasses the current sampling. The amplifier uses SAMPLED COMMON as its reference.



---

## 4.5. Protection Circuitry

See 7700 Series Protection schematic for the discussion of the protection circuitry. The protection circuitry furnishes the following two forms of protection to the amplifier:

- Protection from overheating of the output semiconductors.
- Protection from subsequent destruction as a consequence of output device failure.

Output peak current limiting was provided and discussed in the section on the gain stages. The heat sinks are protected against materials damage due to overtemperature by switches discussed in the section on the output stages. The main power transformer is protected against excessive coil heat by switches discussed in the section on power supplies.

### 4.5.1. Output Transistor Temperature

The output semiconductors are protected by simulation methods. An analog of a worst case junction temperature is computed by taking the product of the output semiconductor current and voltage and applying this stimulus to a thermal impedance analog of a worst case output device.

The heat sink actual temperature is added to result in an absolute temperature model of the junction temperature.

The low side of the bridge is observed to compute the device temperatures. This is based on simplicity and convenience since the low side of the bridge is common to ground. The high side of the bridge is constrained by the bridge balance amplifier to have the same dissipation as the low side. The low side PNP output stage conducts simultaneously with the high side NPN stage to produce a positive output current.

Q301 functions as a two quadrant multiplier to compute the product of current and voltage in the low side PNP output stage. Voltage is converted to a current by R322 which is connected to -Vcc. The current is sensed between the lines of -ICL and -ICOM. R321, N301(7-8), R323 and R332 provide a differential input to Q301. The differential output of Q301 is converted to single-ended by an op-amp current mirror built with U300-C, N301(1-2) and N301(2-3). The output current at N301(3), a virtual ground, is combined with currents from the heat sink temperature sensor, U900, and a fixed temperature offset current through N301(3-5).

The network composed of N302 (8,9,10), C306, and C307 is used to simulate the thermal impedance of a worst case transistor. At 25° C, the output of U300-D (T301) should be +12 Vdc. At 200° C, the T301 will be -9 Vdc. With a 25° C heat sink and no excitation, the offset balance of Q301, R334 is adjusted for +12 Vdc at T301. The voltage at T303 (-TEMP) should be +2.98 Vdc ±0.06 volts. The conversion factor of temperature to voltage is 10 millivolts per degrees Celsius. T302 of the low side NPN sensing protection circuitry should read the same voltage at 25° C.



---

The output T301 is input to two amplifiers which are saturated in normal operation. U301-C and U301-D are saturated at their positive output limits in normal operation. A current from R325 + R326 through R324 defines the temperature threshold at which U301-D will begin a controlled gain (R329 and R330) transition from the saturated state. As the output of U301-D goes negative, the available drive current to Q205 which drives the high side NPN output stage is being removed and eventually extinguished.

If T301 becomes  $-9.5$  VDC, then U301-C will follow suit becoming negative and removing the drive current to U201 which drives the low side PNP output stage. This threshold is defined by a current from R325 through R326 + R324. Since this must always coincide with a higher temperature than the temperature which disabled the high side of the bridge, it is never possible for the bridge to become unbalanced due to operation of the protection circuit.

If the low side of the bridge were to be protected before the high side of the bridge, the resulting imbalance of the bridge would cause the power dissipation to not be equal in the high and low sides of the bridge. The gain of U301-C is controlled by R329 and R328. The operating current of the mirrors, U200 and U201 is determined by R331 and R327.

### **4.5.2. Amplifier Disable**

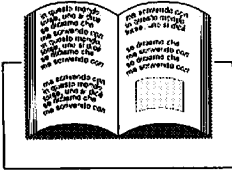
The protection circuitry is used to disable the amplifier on command. Line DA (from the interlock circuit) when driven negative drives all of the sections of U301 to disable the current mirrors that they power and thus disables all of the four output stages. The signal through D303 disables positive output currents and the signal through D302 disables negative output currents. D305 is used to reduce the common mode input voltage to U301-A and U301-B which would create an inverted output if allowed to exceed the amplifiers common mode input range. In the case of U301-C and U301-D the output invoked by exceeding the common mode input range is identical to the desired output, and thus no problem. The outputs of the simulation signals are available for external analysis at T300 and T301.

### **4.5.3. Output Stage Fault**

Should a failure occur that causes the output stages to conduct a large common mode current for more than a few microseconds, the amplifier will be disabled by the fault detection circuitry. The high side of the bridge is sampled by Q302 and Q303 to sense common mode currents. If the high side NPN stage is on, Q303 will be on. If the high side PNP stage is also on, Q302 will be on. When both Q303 and Q302 are on, a current will charge C300 across R302 and drive the opto-emitter of U302. This will trigger the SCR of U302 and latch the FAULT bar line low.

The low side of the bridge is sampled for common mode current by Q305 and Q306. The charging of C309 across R336 turns on Q304 which triggers U302 via the electrical gate input of the SCR. Whichever input triggers U302, the result is the same in that the control power supply which powers the SCR of U302 must be unpowered to unlatch U302 before operation of the main amplifier can be reattempted.

FAULT bar low places the amplifier in the standby state which removes power from the Vcc supply and thus eliminates all potentially destructive current from the apparently failed amplifier.



---

## 4.6. Status and Interlock

See *ISA Status and Interlock* schematic for the discussion of status and interlock circuits.

### 4.6.1. Systems Interlock

When multiple amplifiers are combined to form a larger amplifier, it is necessary to interlock the power controls of the units so that all of the units are powered simultaneously. Should one unit of a group not be enabled, it may be damaged by currents output from the other units. The basic interlock system of the Model 7700 requires that the INTERLOCK line be released from ground. The natural unpowered state of this line is conducting to ground through a depletion mode N-channel FET Q500. The gate of Q500 must be biased negative to open the drain to source channel.

The drains of all interlocked units will be pulled high by all of the R533s when all of the Q500s are off. The threshold for the enabling of the amplifiers is set to 10 volts and each input is low-pass filtered by R527 and C503. D503 and D502 protect the inputs against transients and dissimilar AC potentials on the grounds of the interlocked units.

When INTERLOCK goes high, the output of U501C goes low producing a current which lights the READY indicator E503 and enables the solid-state relays K1 and K2 (signals +SS1 and -SS2) which switch the three phase power to produce the Vcc supplies. R524 provides hysteresis of U501's switch point to insure a good trigger of the relays. Current limiting resistors R520 and R521 are in both legs of the circuit going to the relays for safety should an internal fault occur in the relays.

The gate voltage for Q500 is provided by U501D. When the output of U501D indicates that a chassis is ready, a current may be taken through R530 at INTERLOCK from INT COM. This would allow units that are not electrically common to ground to be interlocked with other units that are, by using an optically isolated interlock.

### 4.6.2. Turn-On Delay

U501 (input pins 10 and 11) are driven from a timing network. When the unit is first powered, C504 is discharged and must be charged by current through R526. When the potential on C504 exceeds the ground potential on the hysteresis feedback divider of R528 and R529, the output of U501D will go low.

C504 may be discharged by four other detectors in the system.

- High AC Mains
- Fault in the output stage
- Overtemperature
- Overload

---

### **4.6.3. High AC Mains Cutoff**

U501B detects high line voltage as evidenced on the unregulated negative supply of the control supply. If this supply is too negative, as determined by the setting of R516 used with R514 and R517, output pin 2 of U501 will be held low and discharge C504 through D501. R515 and R518 provide hysteresis for the overvoltage detection process. The high voltage detector is set to disable the supplies at ten percent high line voltage. C501 prevents ripple on the unregulated supply from toggling U501B's output state.

### **4.6.4 Fault Detection**

The FAULT line may also discharge C504 through D504. E505 and current supply resistor R523 indicate on the front panel if this state has been entered.

### **4.6.5. Overtemperature Shut Down**

C504 may be discharged by the overtemperature protection signal which comes from U500D or U509C through D500.

If any one of the three coils of the three-phase main transformer or one of the two high side heat sinks exceeds its allowed temperature limits, a thermal switch will open and J400-19 will be disconnected from ground. R511 will pull this line to -15 volts and the signal through low pass filter R510 and C501 will overcome the current from the +15 supply through R508 and the output of U500D will go low. E501, the high temperature front panel indicator will also light. Since removing the power to the main supply does not defeat the cooling fans, the unit will cool down and the overheated switch will cool enough to close and power will be restored.

U509D monitors thermal protection activity signals -LH (U301, pin 1) and +LH (U301, pin 14). Under normal conditions, when thermal protection has not been invoked, the output of U509D is positive. If -LH goes positive or +LH goes negative then pin 13 of U509D will go low.

Until -LH or +LH change state, U509D holds input pin 9 of U509B high with R540 holding the input at +15 volts. The inverting input, pin 8 of U509B, is connected to ground through R512. When the output of U509D goes low, the current from R539 overcomes the current from R540 pulling pin 7 negative. When this happens, the hysteresis provided by D506 is so large as to latch the output of U509C low. In order to release U509 pin 14 from this state it is necessary to enable S500 used to reduce the recognition speed of the latch.

U509B prevents U509D from latching when the amplifier is disabled. When the amplifier is enabled, pin 5, the non-inverting input, is held negative and the output, pin 2, is held negative. When the amplifier is disabled the current from the output of U509B overcomes any current from R536 and holds the input of U509D low.

The output of U509C is wired "OR" with the output of U500D so that either comparator will disable the amplifier and illuminate E501. If Z504 is removed this circuit has no affect on amplifier operation.



---

### **4.6.6. Ready and Standby**

Any time that the unit is not in the ready state (but powered), the standby state will be occupied and indicated by E504. U501A's output drives E504 and is controlled by the ready signal on the output of U501 pin 14. The junction between E504 and its current limiting source resistor R522 is the DA line which is used to signal the protection circuitry to disable the amplifier. Therefore any time that the amplifier is in STANDBY, it is also disabled in all power stages and the main supply although some charge might momentarily remain on the Vcc supplies.

### **4.6.7. Overload Indicator**

Should the amplifier be overdriven at any time, a large error signal will be produced at the output of U202 (signal A1). If this signal is greater than 10 volts in magnitude, it may be assumed that some form of overload is in process. U500A and U500B form a window detector to detect such a condition.

The reference potentials for detection are supplied by R500, R501 and R502. If signal A1 is outside of this voltage window, the output of U500 at pins 1 and 2 will be low. U509 is used to disable signals from reaching the overload latch while the amplifier is in standby.

Normally the input at pin 9 of U500C from the window detector (via U509A) is high with R504 holding the input at +15 volts. The inverting input, pin 8 of U500, is connected to ground through R512. When the window detector drives the voltage at the junction of R503 and R504 negative with respect to the collector of Q501, the hysteresis of D507 is so large as to latch the output of U500 low. E500 will then be lit with the current flowing through R506. In order to release U500 pin 14 from this state it is necessary to enable S500 (Reset/Run switch) overcoming the hysteresis on U500. If latching is not desired Z505 should be open. C507 is used to reduce the recognition speed of the detector. Standard 7700s will have latching defeated.

### **4.6.8. Status Output**

U502 through U506 provide optical isolation to report the status of the amplifier. Z500, Z501, Z502 and Z503 provide a means to combine and report status on one line or as individual status lines. U508 provides optical isolation to reset the overload indicator. The 7700 is placed in an ENABLED condition by an input to U507 which overcomes the enabling of Q501 from the current in R531. If Q501 is on, C504 will not charge and the unit will remain in STANDBY. Z504 can be used to permanently enable the unit in systems where the control of U507 is not needed.

---

## **4.7. Power Supplies**

The Model 7700 gradient amplifier has two classes of power supplies, Control and Vcc. The Control Power Supply provides low voltage to small signal, standby and interlock circuits of the amplifier. The Vcc power supply drives only the output stages. See *7700 Series Power Supply* schematic for the discussion of the Power Supplies.

### **4.7.1. Control Power Supply**

AC mains for control power originates at CB1. Control transformer T2 is a single phase transformer, whose primary is protected by F1. The primary of T2 is used as an auto-former to power the four, 120 volt fans. The secondaries of T2 are Faraday shielded and connect to full-wave rectifiers.

Unregulated supplies are produced by a full-wave center tapped winding using D400, D401, D405, D406, C402 and C404. From these supplies, U400 and U401 produce regulated +15 and -15 volt dc supplies. The grounds of these supplies is considered to be an analog ground. Both of the regulated supplies have reverse polarity protection diodes D401 and D403. C403 and C405 are bypass capacitors for low impedance at high frequencies. The unregulated negative supply is used by the overvoltage detector of the status and interlock circuitry.

A second low voltage winding is used to drive a full wave bridge to produce the unregulated supply for a +5 volt IC regulator U402. Rectifiers D407-410 and C406 provide the necessary unregulated voltage. D404 provides reverse polarity protection. The ground of the +5 volt supply is kept separate from the analog ground and is considered to be a digital ground for auxiliary functions.

### **4.7.2. Vcc Power Supply**

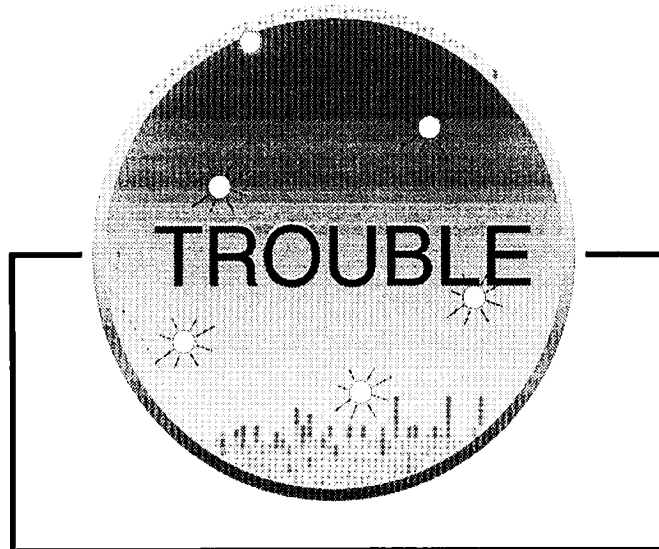
Upon entering the chassis, the three-phase power passes through a three-pole, high in-rush current circuit breaker CB1. This breaker is mounted on the rear of the unit and can break all three legs of the ac mains.

Solid state relays K1 and K2, controlled from signals +SS1 to -SS2, provide primary power to T1's delta primary windings. Control signals +SS1 to -SS2 are internally optically isolated from the ac mains.

T1 has a "Y" secondary which drives full-wave rectifiers D411, D412, and D413. C400 and C407 are the major filter capacitors with C409- C414 providing high frequency bypass on the AC side of D411, D412, and D413.

R400 is a bleeder to discharge C400 and C407 after power is removed. C408 provides local high frequency bypass for the output stage.

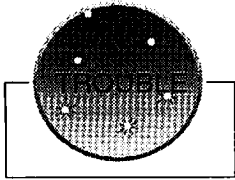
A normally closed thermal sensor is embedded in each of the three coils in T1. These switches are wired in series and returned to the thermal protection section of the status and interlock circuitry. Like T2, T1 has a Faraday shield to prevent signals from V1 and V2 capacitively coupling to the ac mains.



---

## ***Section 5—Troubleshooting***

“Troubleshooting” refers to procedures you can follow to track down potential amplifier problems. Use this section in conjunction with other service information contained in this manual.



---

## **5.1 Introduction to Troubleshooting**

This section is not intended to provide complete troubleshooting specifications for all possible Techron 7700 series amplifier malfunctions. Rather, it is an informal set of shortcuts that are designed to aid in getting an inoperative amplifier back in service as quickly as possible.

The procedures outlined in this section are limited to the identification and isolation of the more typical problems. Further, this section will only be of value in the handling of gross component failures as distinct from intermittent malfunctions.

The procedures outlined in this section are directed to an experienced electronic technician. There is no attempt made to cover all of the many details involved in setting up and conducting typical electronic repair and test procedures. If components need replacing, refer to Section 5.12.1 for instructions on replacements and required adjustments.

## **5.2 Repair Precautions**

Techron 7700 series amplifiers undergo frequent engineering updates. As a result, modules and electronic assemblies may not be fully interchangeable between units. Particularly, the main circuit board undergoes periodic engineering modifications which may make an interchange of two main circuit boards between 7700s from different production lots impossible.

The safest field repair procedure is replacement of an individual component, and this section is designed to aid the repair technician in isolating common problems down to the component level.

## **5.3 Preparation**



### **DANGER**

These procedures are performed with unit under power and with protective panels removed. Test steps must be followed precisely, and the technician must exercise extreme caution to avoid accidental touching of improper terminals or components. Powerful and potentially lethal electric shocks can occur as a result of accidental contact with capacitors, terminals, heat sinks and other interior components.

---

### 5.3.1 Equipment Requirements

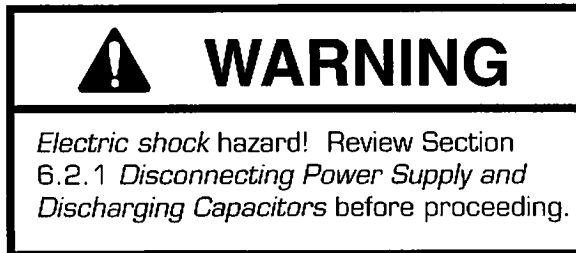
In addition to standard hand tools and electronic test equipment, the following specialized equipment is recommended to perform the tests in this Section. Using the equipment listed in Table 5-1 will help insure that the amplifier is tested and adjusted to factory specifications. Any compromises in equipment could result in a compromise in performance or calibration.

Hewlett Packard HP 400F Voltmeter
Tektronix 2215 Oscilloscope to observe waveforms
Fluke 8060A DVM to measure voltage
Wavetek Signal Generator 193 as signal source
Intermodulation Analyzer to measure distortion
Nonmetallic screwdriver for adjustments, GC 8276 or 8277
Current Shunt (Typical .005 ohms)

**Table 5-1 Recommended Equipment**

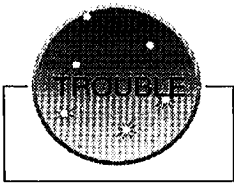
### 5.3.2 Make a Thorough Visual Inspection

Here is a check list of areas requiring a thorough physical inspection after powering down the unit for testing:



1. Remove the top, front, side and bottom panels from unit.
2. Thoroughly inspect all modules for charring, breaks, deformation or other signs of physical damage.
3. Look for foreign objects that may be lodged inside the unit.
4. Inspect entire length of wires and ribbon cables to look for breaks or other indications of physical damage.
5. Inspect power supply capacitors, particularly for tightness of terminal screws.
6. If the above visual inspection shows any physical damage, replace the defective parts before proceeding to the following troubleshooting procedures.





### 5.3.3 Output Continuity Test

1. Place the black (-) lead of an ohmmeter on the heat sink (collector) and the red (+) lead on the foil (base) of the first output well. See Illustration 5-1.
2. The reading should not indicate a short.
3. Test all four output wells in similar locations obtaining very similar readings.
4. If meter reading on one well is lower than the others, that well contains a defective output transistor. Repair before continuing.

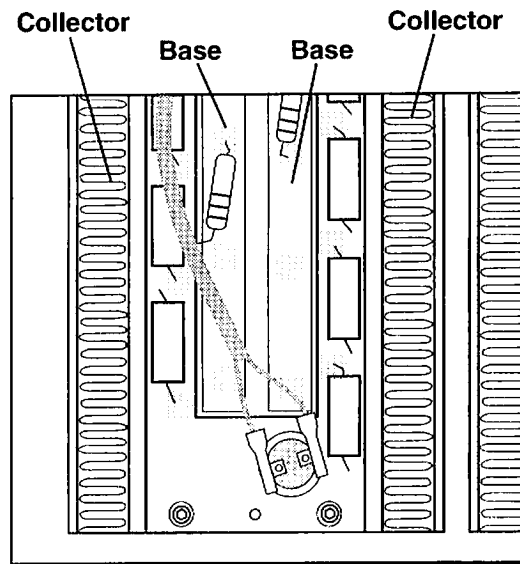
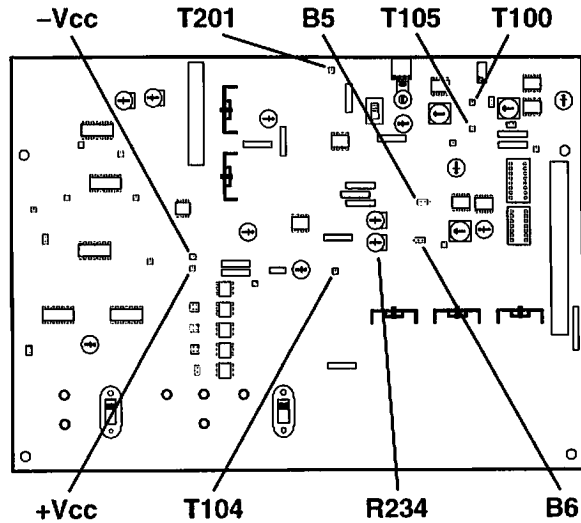


Illustration 5-1 Output Well Test Points

### 5.3.4 Preparation for Testing Under Power

Several of the troubleshooting tests are made with unit powered and with a load attached.

1. Connect proper ac mains to amplifier.
2. Testing is done with the amplifier in constant voltage mode, with jumpers B5 and B6 in the full left position. See Illustration 5-2.
3. Check power supplies under No-Load:
  - $\pm 15$  Vdc on R234 with chassis ground.
  - +Vcc test point with circuit ground (T105).
  - -Vcc test point with circuit ground (T105).
4. When required, use a  $0.5 \Omega$  resistor in series with a 0.5 mH coil as a 2 kW load connected to the output terminal block at "Output" and "Sampled Common" points.



**Illustration 5-2 Main Board Test Points**

## 5.4 Troubleshooting Guide

The Troubleshooting Guide found in Table 5-2 assumes a single amplifier configuration.

Symptoms and Conditions	See Section
Circuit Breaker CB1 trips	5.3.2, 5.3.3, 5.3.4
Fuse F1 blows	5.3.2
Fault LED illuminated	5.3.2, 5.3.3, 5.3.4, 5.11
No Front Panel LEDs illuminated	5.6, 5.3.2
Fan(s) inoperative	5.6, 5.3.2
Will not disengage from Standby	5.8
OverTemperature	5.10
OverVoltage	5.7
No Output	5.9
OverLoad	5.3.4, 5.9
Distorted Output	5.3.4, 5.9
Reduced Output	5.3.4, 5.9

**Table 5-2 Troubleshooting Guide**



## 5.5 Identify Problem with LED Indicators

The six front panel LEDs (Ready, Standby, OverTemp, Fault, OverVoltage, OverLoad) can help identify problem areas. Refer to Table 5-3 for LED patterns and possible malfunctions.

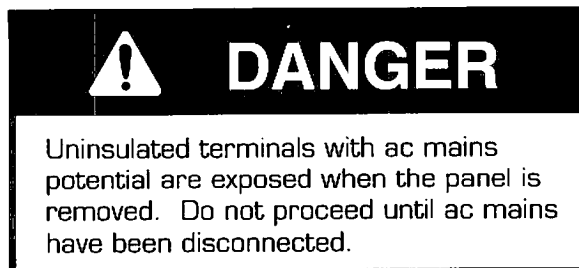
Illuminated LEDs						Symptoms and Conditions	See Section
R	S	OT	F	OV	OL		
•						No LEDs illuminated	5.6
	•					No output signal	5.9.1
	•					Remains in standby	5.8
	•			•		AC mains too high	5.7
	•	•				Amplifier is too hot	5.10
	•		•			Shorted transistor in output stage	5.11
•					•	Amp couldn't reproduce input signal	5.9

Table 5-3 LED Troubleshooting Guide

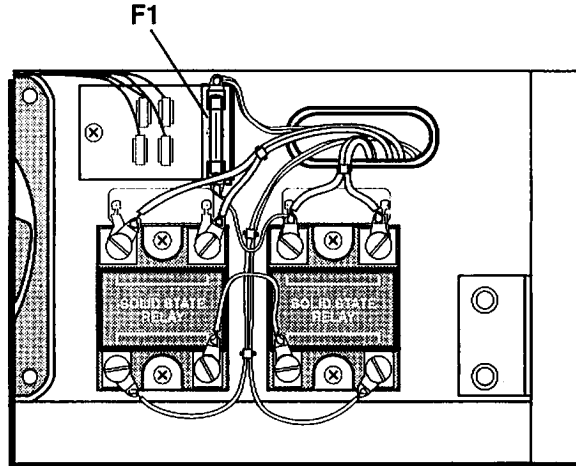
## 5.6 No LEDs are Illuminated

If none of the LEDs on the display panel are illuminated and/or the fans are inoperative, check the following:

- The ac mains are not connected or not on.
- Rear circuit breaker CB1 is not in the up position or disconnected.
- Fuse F1 is open. To inspect fuse:
  1. Turn off and disconnect ac mains. See Section 6.2.1 for shut down procedures.



2. Remove left fan cover.
3. Inspect fuse F1. See Illustration 5-3. If needed, replace the fuse. To find the correct fuse type for your power input voltage, see Section 8-10.



**Illustration 5-3 Fuse F1**

## **5.7 OverVoltage LED Illuminated**

The amplifier will protect itself from ac mains voltage that is 10% above the voltage stamped on the back panel, near the serial number label (assuming the transformer has not been rewired for a different voltage as described in Section 3.3.7). If the ac mains voltage is more than 10% above the operating voltage, reduce the ac mains voltage to the proper level.

## **5.8 Standby Remains Illuminated**

This test verifies that unit goes into and out of Standby through operation of switch S501.

1. Disable the amplifier. Move the Ready/Standby switch (S501) on the front panel down to Standby position.
2. The yellow Standby LED will illuminate (no others should illuminate).
3. If Standby does not illuminate, there is a problem in the Standby circuit. Check U501 or Q500.
4. Switch S501 up to enable the amplifier.
5. Verify that the green Ready LED is illuminated and that the Standby LED is not. If this is not the case, check U501 or Q500.

**Note:** 7700 series amplifiers are normally shipped from the factory *without* the overload latch enabled. After the overload latch is enabled by the jumper Z505 on the main board, an overload condition will latch the amplifier in Standby condition. The Manual Reset Switch (S500) on the front panel must then be momentarily pressed down to the reset position. If the overload condition still exists, the amplifier will revert to Standby. For more information about the overload latch, see Section 3.3.5, "Overload Indication."



## 5.9 Missing or Distorted Signals

The following tests will aid in narrowing down missing or distorted signals.

1. Set up for main board tests as follows:
  - Power: Appropriate 3-phase.
  - Load: 0.5  $\Omega$ , 0.5 mH (see 5.3.4).
2. Switch S100 up to Master.
3. Apply a 300 Hz toneburst, 5% duty cycle signal to input (J2). Connect an oscilloscope to T104 with ground at T105. See Illustration 5-2.
4. Switch S501 up to Ready.
5. There are several possible signal results from this test. Proceed to subsequent tests based upon Table 5-4.

Scope Results	Indication
Straight Line	Do test in Section 5.9.1
Positive or negative clipping	Indicates problem is probably in output section. Do test in Section 5.9.2
Oscillations or other erratic wave forms	Could result from a various causes. Do test in Section 5.9.2

Table 5-4 T104 Test Results

### 5.9.1 Missing Signal

Missing output signal may be caused by one of the following:

- Master/Slave switch is down in Slave position, unless the amplifier is a Slave amplifier in a system, then, set the switch up in Master position.
- Signal not connected to J1 or J2 on back panel.

Continue with this test if signal is connected properly and the procedure in Section 5.9 produced a straight line at T104.

1. The test setup is:
  - Power: Appropriate 3-phase (same as previous).
  - Load: 0.5  $\Omega$ , 0.5 mH (same as previous).
  - Switch S100 down to Slave.
2. Apply a 300 Hz toneburst, 5% duty cycle to input (J3 when in Slave). Connect scope to ground and T100. See Illustration 5-2.
3. If no signal is produced at T100, the problem is likely within the Main Board input section. Try replacing U100. Check out associated resistors and capacitors in the input section. Also, double check ribbon cable leading to the input section for a physical defect that may have been overlooked previously.

- 
4. If testing at T100 shows an appropriate sine wave, then the Main Board problem can probably be isolated to the gain stage. To verify a gain stage malfunction:
    - a. Switch S100 up to Master. Defective waveform should reappear.
    - b. Replace U202 and recheck. Then replace U203 and recheck. If neither U202 nor U203 are the cause of the problem, check all transistors in the gain stage (see the Gain Stage Schematic in Section-8).
    - c. Check for missing Z102 jumper if a Filter Board option is installed.

### **5.9.2 Distorted Signal**

This test is indicated if test from Section 5.9 resulted in either positive or negative clipping of the sine wave. The most likely cause of clipping from a T104 test point is a problem in the Main Board gain stage (components that are numbered between 200 and 299 on the schematics). Check for a shorted semiconductor within section 200 of the Main Board.

1. Attach a scope probe to T201.
2. Inject a 300 Hz tone burst, 20% duty cycle, at J1 and slowly raise the input voltage until an error signal is seen on T201.
3. Look for spurious responses up to clipping.
4. Capacitors and resistors marked as selectable on the output stage schematic may be selected within limits to keep T201 clean up to the clip point.

If there is no obvious defect within section 200 of Main Board, a clipped wave could also result from a defective output section component. Continue testing at Section 5.11.1.

## **5.10 Amplifier Overheats**

### **5.10.1 Check for Excessive Power Requirements**

An amplifier will naturally overheat if the required power exceeds the amplifier's capacity. High duty cycles and low-impedance loads are especially prone to cause overheating.

- Check that your application's power requirements fall within the specifications of the amplifier.
- Check for faulty (especially shorted) output connections and load.

If the amplifier chronically overheats with suitable power/load conditions, then the amplifier may be malfunctioning. Proceed to the following steps.



---

### 5.10.2 Check for Inadequate Air Flow

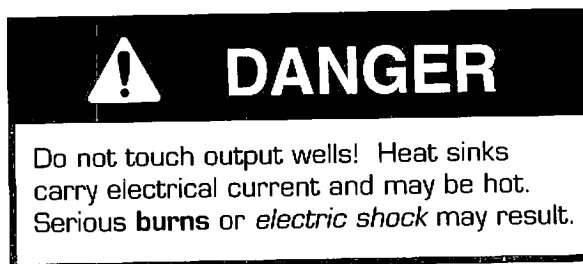
1. Check air filters.
2. Clean any filter clogged with dirt. Clean periodically to ensure cooling efficiency.
3. With power on, visually inspect fans for correct operation.
4. Replace any fan not operating, operating at reduced speed, or running backwards. (Air flow must go inward at fans, and outward from front panel grille. If a replacement fan is defective, it might run backwards.)

### 5.10.3 Check for Defective Thermal Switch or Thermal Switch Wiring

To check for a defective thermal switch or associated wiring flaws, consult wiring diagram and perform a continuity test through the normally-closed thermal switch wiring path and/or perform the test in Section 7.25.

**Note:** An Overtemp condition places the amplifier in Standby. If the Overtemp pulse is extremely short, as it would be in the case of defective wiring or switches, the Overtemp pulse may be too brief to see. And since the return to Ready is automatic after any Overtemp condition is over, the Ready light will return. Thus, Standby alternating with Ready, for no apparent reason, could indicate a possible defect in thermal switches or their wiring.

### 5.10.4 Check for Overheating of an Output Well



1. Turn power on.
2. Allow output well to heat up.
3. Disconnect power.
4. Place hand **near** (**do not touch**) output wells one at a time.
5. Test any output well which is substantially hotter than others. See Section 5.11 for instructions on identifying faulty output components.

---

## 5.11 Fault LED Illuminated

A 7700 series amplifier contains protection circuitry to disable the amplifier if the output stages are behaving abnormally. Usually this indicates an output transistor has shorted.

To clear the Fault condition, turn off the signal source, turn off the ac mains power, and then turn the ac mains power on again. If the Fault LED does not illuminate again, turn the signal source back on. If the Fault condition does not clear, proceed with tests in Section 5.11.1 and Section 5.11.2.



### CAUTION

Shut off the signal source before resetting the amplifier. Try resetting the Fault condition only once. If the Fault condition does not clear after one reset, repair the defective component before continuing. Repeated resetting can damage the amplifier.

### 5.11.1 Identify Defective Output Section



### WARNING

*Electric shock hazard! Review Section 6.2.1 Disconnecting Power Supply and Discharging Capacitors before proceeding.*

This test will help identify the output section that has a defective output transistor.

1. Turn off and disconnect ac mains. See Section 6.2.1 for shut down procedures.
2. Remove the top cover.
3. Place the black (-) lead of an ohmmeter on the heat sink. See Illustration 5-1.
4. The reading should not indicate a short.
5. Test all four output wells in similar locations. You should obtain very similar readings in comparable locations.
6. If meter reading on one well is lower than the others, that well contains a defective output transistor. Repair before continuing.

If meter readings on all four wells are similar, proceed to the following series of tests which presume that the problem is in the circuit board.

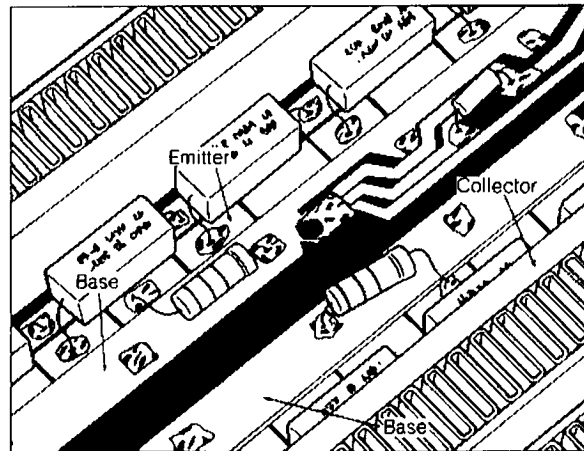




## 5.11.2 Output Stage Transistor Test

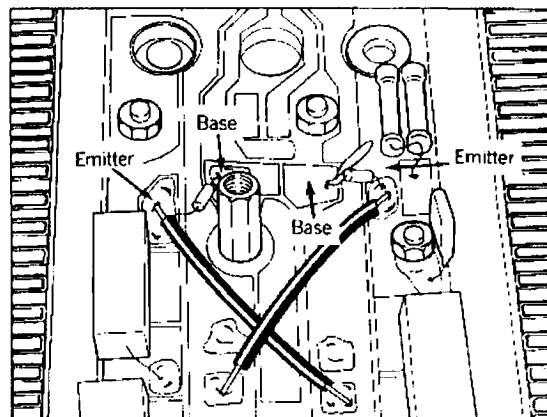
Section 5.11.1 covered procedures for identifying heat sinks with defective components. This section describes more detailed checks on other output section components.

1. Test output transistors at collector and emitter terminals. See Illustration 5-4 for locations of the terminals.



**Illustration 5-4 Transistor Test Points**

2. Replace any transistor measuring  $<0.66 \Omega$  less resistance than others.
3. When testing an output transistor, test its emitter resistor also.
4. Test driver transistors. See Illustration 5-5 for test points.



**Illustration 5-5 Driver Transistor Test Points**

5. Test predriver transistors, TO-220 devices, located on predriver boards. See Illustration 5-6 for pin identification.
6. When testing predrivers, apply leads of ohm meter as follows:
  - a. On wells 1 and 4 (NPN): Red (+) on collector; black (-) on emitter.
  - b. On wells 2 and 3 (PNP): Black (-) on collector; red (+) on emitter.
7. Resistance readings should show high resistance, otherwise, replace.

8. If Bias Servo transistors (TO-92 devices) on wells 1 & 4 (see Illustration 6-15) are disturbed, test them as in steps 6a & 7. See Illustration 5-6.

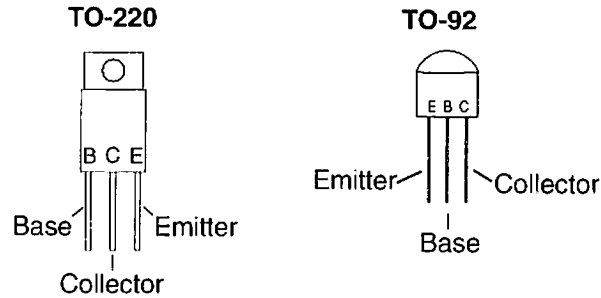


Illustration 5-6 Transistor Lead Identification

## 5.12 Final Troubleshooting Procedures

### 5.12.1 Comprehensive Test and Adjustment

If any of the preceding tests resulted in component replacement, a proper servicing effort would be to complete all tests and adjustments in Section-7. If it is not practical to do that, do the tests and adjustments related to the specific repair as listed in Table 7-1.

Sometimes, only a single adjustment is needed when its associated part has been replaced. As a shortcut temporary measure, use Table 5-5 to determine the corresponding adjustment.

Part	Adjustment	Part	Adjustment	Part	Adjustment
C100	C101	R109	Selected to Load	R517	R516
C110	C101	R120	R121	R651	Adjust Same
C101	Adjust Same	R121	Adjust Same	R652	R651
C103	Selected to Load	R204	Adjust Same	R654	R651
C104	Selected to Load	R205	R204	R761-763	N102
C105	Selected to Load	R232-233	R236	R812	Selected with
D650	R651	R234	Adjust Same	U800	
N100	Adjust Same	R235	R234	R853	Adjust Same
N300	R305	R236	Adjust Same	R854-856	R853
N301	R334	R237-240	R236	R923	Selected with
Q300	R305	R304	R305	U900	
Q301	R334	R305	Adjust Same	T2	R516
Q610-611	R651	R306	R305	U120	R121
Q650	R651	R323	R334	U202	R204
Q652	R651	R334	Adjust Same	U203	R234
Q810-811	R853	R335-348	NA	U300	R305, R334
Q850	R853	R500-510	NA	U400	R148, R516
Q852	R853	R514	R516	U800	R812
R108	Selected to Load	R516	Adjust Same	U900	R923

Table 5-5 Component Interaction



---


### **5.12.2 Continuity Check**

If the amplifier is not functioning properly and all of the previous tests have failed to isolate the problem, you must now make a complete continuity test based upon the schematics and wiring diagram.

As an alternative to a complete continuity test, or if the problem cannot be determined, the unit may be returned to Techron for factory repair and testing. See the following section 5.13 for packing and shipping instructions.

## **5.13 Packing & Shipping Instructions**

In order to return a 7700 amplifier for factory repair without damage during shipment, care must be taken in packing the amplifier.

	<b>CAUTION</b>
<p>The output connector cover must be in place to protect the output terminal during shipment. Techron will <u>not</u> be responsible for damage due to missing covers.</p>	

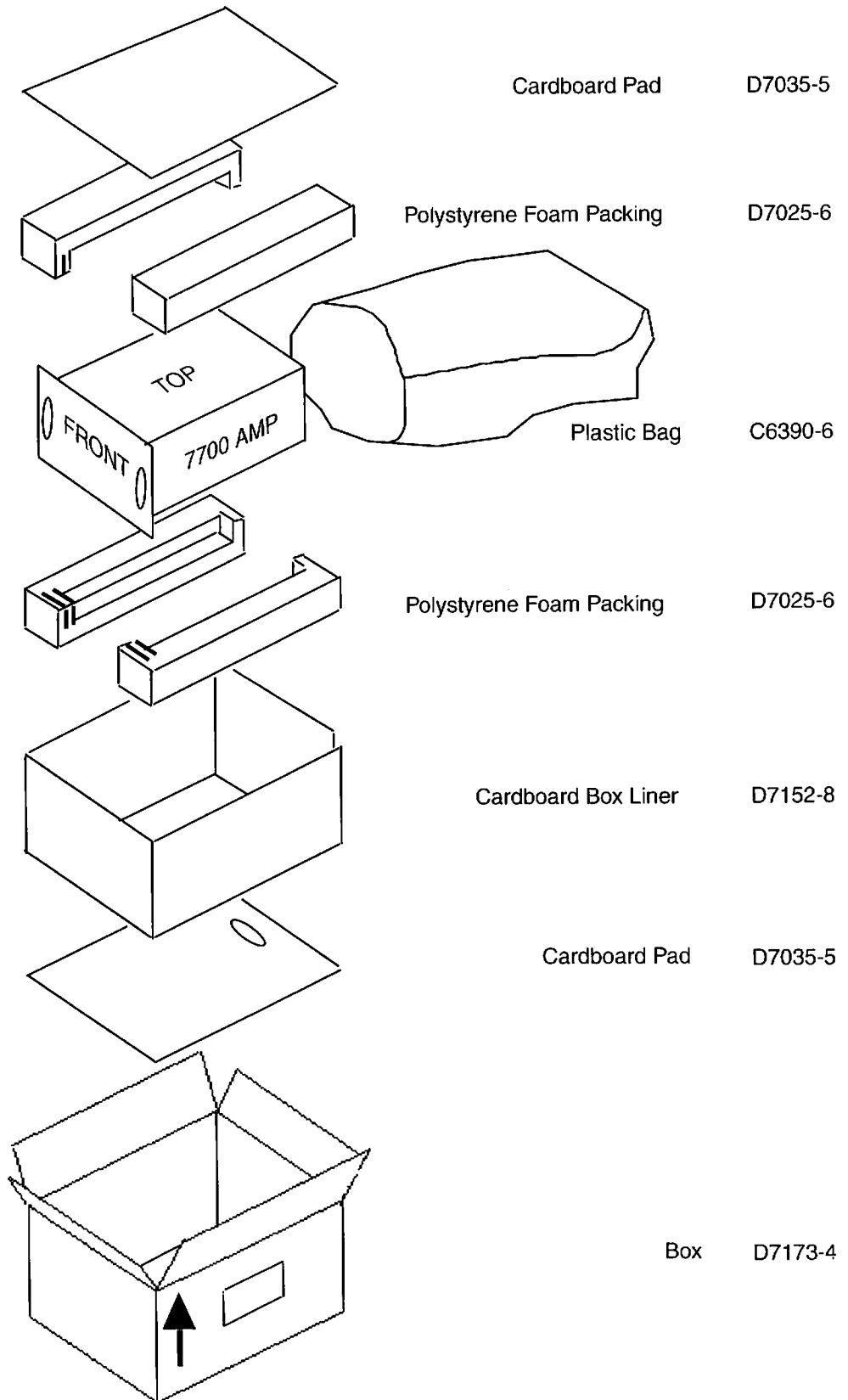
The most secure way to ship an amplifier is to use the materials the amplifier was originally shipped in. If these materials were discarded, order replacements using the part numbers in Illustration 5-7.

To pack the amplifier using those materials, begin by placing the amplifier in the plastic bag. It may be necessary to remove chassis slides from the amplifier. Assemble materials in the order shown, starting from the bottom.

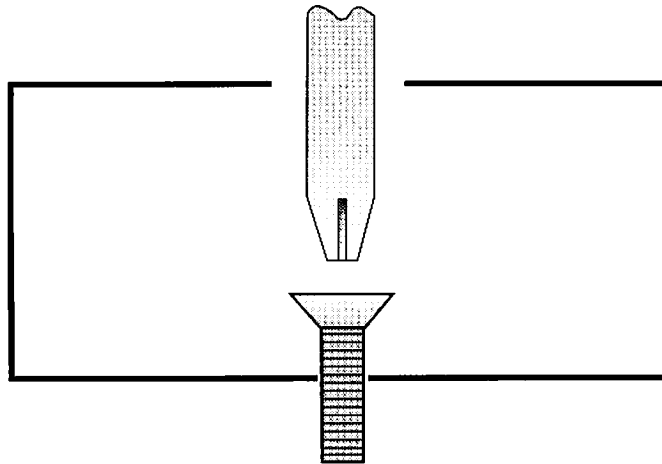
Shipment will be made by UPS or best method unless a preferred method is specified. Shipments are made F.O.B. Elkhart, Indiana, only.

Shipments to Techron should be made as described below:

<p><b>Techron</b> <b>Customer Service Department</b> <b>57620 C.R. 105</b> <b>Elkhart, Indiana 46517</b></p>
--

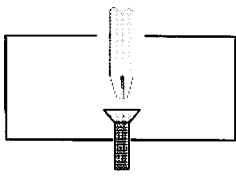


**Illustration 5-7 Packing Materials for Shipping 7700 Amplifiers**



## ***Section 6—Component Removals/Replacements***

Failed components may need to be removed, serviced, and reinstalled or replaced. Use this information for removing and reinstalling such components.



---

## 6.1 Introduction

From a mechanical stand point, servicing of Model 7700 is straight forward. Illustration 8-1, is the master exploded-view assembly drawing that shows the relationship of modules and assemblies.

This section has two purposes:

- To review important safety information for the protection of both equipment and servicing personnel.
- To identify several assembly and disassembly procedures that might not be apparent from a study of Illustration 8-1.



### CAUTION

7700 amplifiers include many stock electrical and electronic parts, which are available from electronic supply houses. However, some electronic parts that appear to be standard are actually special. Order parts from Techron to assure acceptable replacement and reliable operation. Structural items, covers, and panels are available from Techron only.

## 6.2 Important Safety Information

Model 7700 operates from three-phase AC mains. In addition to physical hazards to servicing personnel, certain electrical conditions could cause damage to component parts.



### DANGER

A 7700 amplifier carries potentially lethal voltages even after the main power supply has been disconnected. After power shutoff, and before any service procedure, wait at least two minutes for automatic capacitor discharge. Verify the discharge by testing the capacitor terminals or rectifier blocks.

---

## 6.2.1 Disconnecting Power Supply and Discharging Capacitors

Before attempting any servicing of the amplifier, shut down the outside power supply by:

1. Turning off the power at CB1 (circuit breaker on the back panel).
2. Disconnecting the AC mains plug from the rear of the unit.

**Note:** CB1 may be used to temporarily shut down the power unit. However, disconnecting the AC supply provides an extra measure of safety to the service technician.

3. Wait two minutes for capacitors to discharge before touching any part of the amplifier.
4. Remove the bottom cover (Item 24 on Illustration 8-1) to expose the power supply capacitors.
5. Verify the capacitor discharge by connecting a voltmeter across the “+” and “-” terminals of the power supply capacitors. See Illustration 6-1.
6. The voltmeter should give a reading of less than 50 volts.
7. If voltage is above 50 V, discharge capacitor by placing a 10  $\Omega$ , 10 W resistor across the positive and negative terminals of the capacitor for at least five seconds.

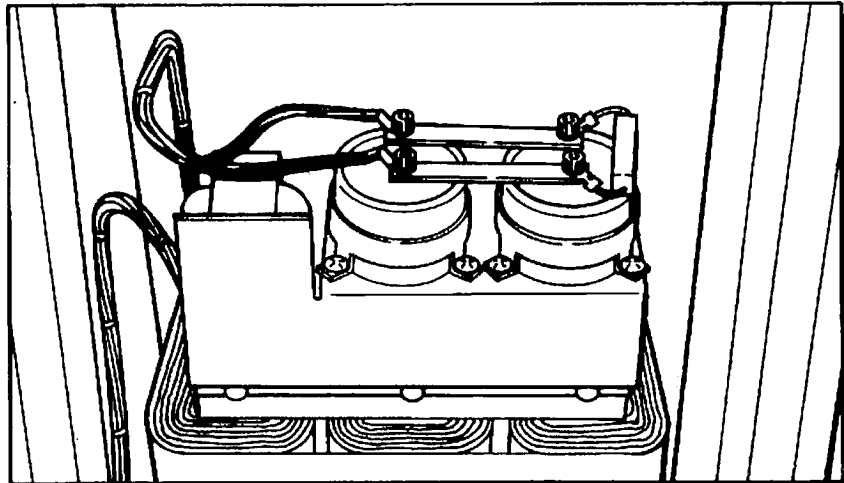
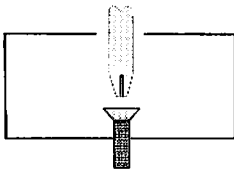


Illustration 6-1 Power Supply Capacitors

## 6.2.2 Floating Ground

The internal electrical components of the amplifier are not grounded to the chassis. Because of this floating ground feature, test equipment used in servicing Model 7700 should not be earth-grounded. There is a possibility of erroneous readings occurring from the use of grounded test equipment. Use an isolation transformer to float the test equipment from an earth ground.



---

## 6.3 Front Panel Removal

Loosen four screws until cover can be removed. Be sure retaining washers do not fall off.



### CAUTION

Ribbon cables and other connections will be damaged if they are pinched when replacing the front panel. Position all cables away from the edges of the front panel before securing the front panel.

## 6.4 Removal of Rear, Top, Bottom, and Side Panels

The *top* panel (Item 66 in Illustration 8-1), *bottom* panel (Item 24), and two *side* fan covers (Item 46) can be removed individually. To remove any one or all of these panels, do the following:

1. Remove the small phillips screw holding the panel to the rear cover.
2. Slide the panel out to the rear.

**To remove the *rear* panel, do the following:**

1. Remove (or at least slide partially out) the top panel, bottom panel, and two side fan covers.
2. Remove the eight large phillips screws along the two side edges of the rear panel.
3. Pull off the rear panel.



### DANGER

After panels are removed, make sure capacitors are allowed to discharge before proceeding with any further service.



## 6.5 Service of the Output Shelf

The output shelf (Item 67 in Illustration 8-1) is a frame that holds the four output wells. Removal of the output shelf is not needed to service the output wells. Remove the output shelf to service components mounted underneath the shelf.

### To remove the output shelf:

1. Disable the amplifier by performing the shutdown procedures covered in Section 6.2.1.
2. Remove front, top, and bottom panels. See Section 6.4.
3. Unscrew the socket cap screw (Item 3, Illustration 8-4) from the positive capacitor terminal and remove the *single red* wire that leads to the output shelf. Reattach the *double red* wires coming from the bridge rectifiers to the capacitor terminal and finger-tighten the screw. See Illustration 6-5. Follow the same procedure with the *blue* single and double wires on the negative terminal.
4. Disconnect the in-line connections in the two gray wires. These wires are interchangeable and can be reconnected to either connector.
5. Disconnect the three-conductor connection.
6. Disconnect the output interconnect board from the Main Circuit Board at J400. See Illustration 6-2.
7. Remove the back panel. See Section 6.4.

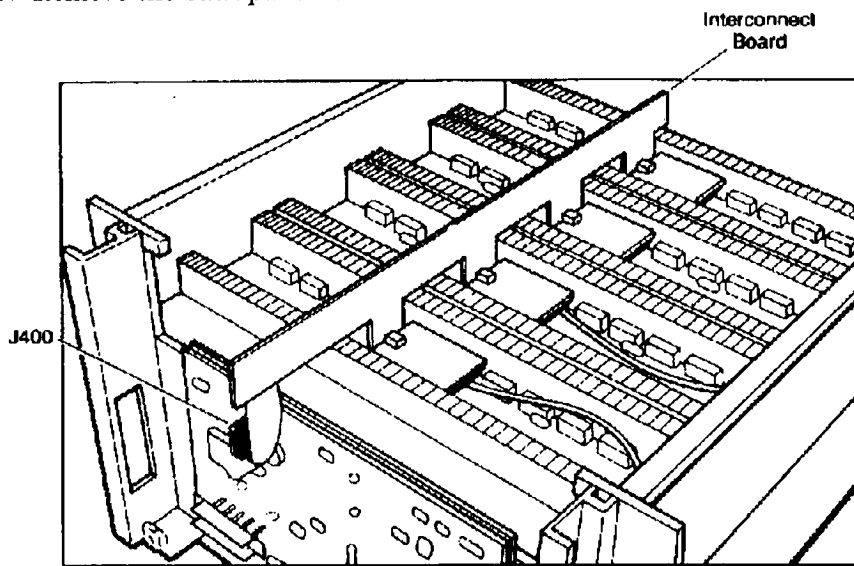
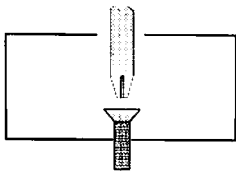


Illustration 6-2 Interconnect Board

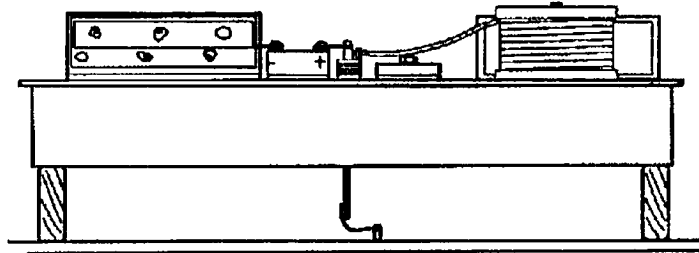


### CAUTION

Be prepared to place the output shelf on blocks before removing it from the amplifier. See Illustration 6-3.



8. Remove the output shelf assembly from the rear of the unit. Carefully feed loose wires past back panel as shelf assembly is removed. Place the shelf on blocks (see Illustration 6-3) to prevent damage to the components. Go to the appropriate section for individual component service.

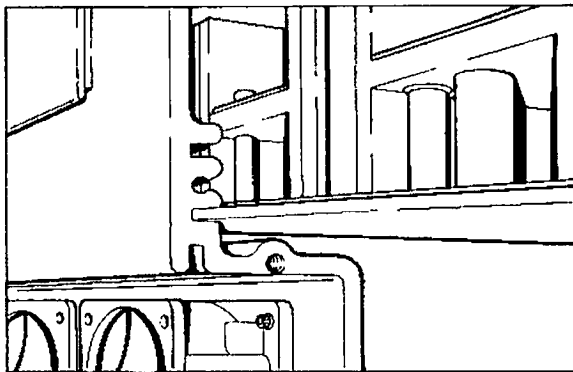


**Illustration 6-3 Output Shelf on Blocks**

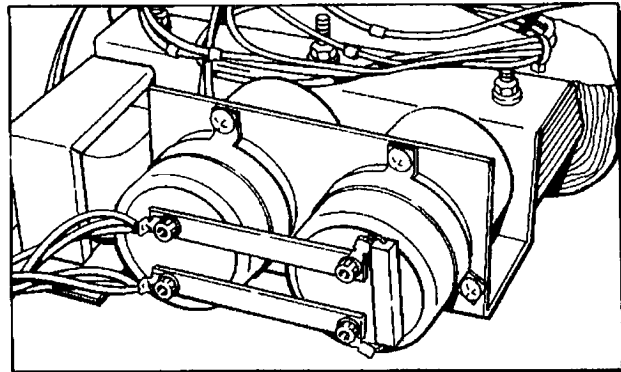
**To install the output shelf assembly:**

1. Slide the output shelf assembly into the lower of two slots in the chassis (see Illustration 6-4). Make sure that the interconnect board is not damaged as the shelf and front panel come together.
2. Replace the back panel.
3. Reconnect the interconnect board to J400 on the Main Circuit Board.
4. Reconnect the two gray wires. They are interchangeable.
5. Reconnect the three-conductor connection.
6. Reconnect the red and blue wires to the terminals on the capacitors. Connect red on red, and blue on blue. See Illustration 6-5.
7. Tighten the capacitor screws with the appropriate tool.

**Caution:** Loose capacitor screws is a common cause of an overheated power supply.



**Illustration 6-4 Shelf Mounting Slots**



**Illustration 6-5 Capacitor Assembly**

---

## 6.5.1 Flyback Diode Block, D607

(See Item 19 on Illustration 8-2; also see Illustration 6-6.)

### To Remove Flyback Diode:

1. Note and mark the wiring connections on the Flyback Diode Block. (See Illustration 6-6.)
2. Unplug the brown and black wires.
3. Unsolder the red and blue wires.
4. Remove the mounting nut and washer from the captive mounting stud.
5. Remove Flyback Diode Block.

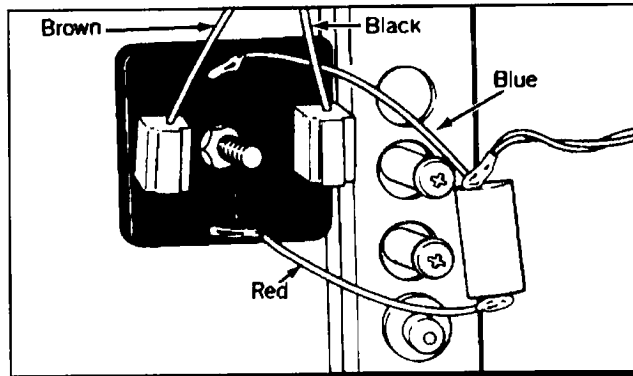


Illustration 6-6 Flyback Diode Detail

### To Install Flyback Diode:

1. Apply heat sink compound (see the end of Section 8.6) completely and lightly to the Flyback Diode Block mounting surface.
2. Install and tighten the washer and mounting nut.
3. Connect the brown and black wires.
4. Solder the red and blue wires.

## 6.5.2 Current Sampling Resistor Assembly

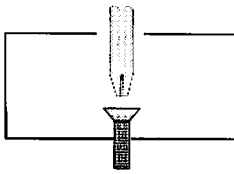
The Current Sampling Resistor Assembly consists of upper and lower plates that hold three parallel resistors. See Items 22 and 23 on Illustration 8-2. The individual resistors are not replaceable. If one resistor is found to be defective, you must replace the complete group.

### To remove the current sampling resistor assembly as a unit:

1. Remove the two large phillips screws on the base plate.
2. Unsolder the orange and black wires from the bus bars.

### To install:

1. Install a new current sampling resistor assembly.
2. Orange and black wires pass through holes in the bus bar and are secured with heavy solder. Duplicate this soldering method when replacing these wires.



### **6.5.3 Servicing Bus Bar Assembly**

The bus bar assembly includes four copper bus bars with insulation material between them. The individual bus bar assembly components are replaceable when removed from the output shelf. See Illustration 8-3 for details on the bus bar assembly. Should the insulation between individual bus bars require replacement, use only the original equipment insulating material.



#### **WARNING**

Substituting insulating material other than the original specification may result in unsafe or unstable operation of the amplifier. Order replacement insulation from Techron. See Section 8.

### **6.5.4 Heat Sink Shelf Insulation**

The insulation (Item 6 on Illustration 8-2) between the heat sinks and output shelf serves as a gasket for cooling air as well as electrical isolation. A gasket which is damaged or removed during a service procedure must be replaced. Order replacement gasket material from TECHRON only.

## **6.6 Servicing Fans**

Model 7700 includes four fans (Illustration 8-1, Item 43) that provide a flow of outside air through the heat sinks. Internal heat protection will shut down the amplifier if the cooling from the fans is insufficient to dissipate heat. The fans are interchangeable with each other, but not repairable. Defective or inoperative fans must be replaced. The following instructions describe replacing a fan on one side only. The procedure is identical for all four fans.



#### **DANGER**

Verify capacitor discharge (see Section 6.2.1) before servicing fans. Terminals near fans could carry lethal voltages.

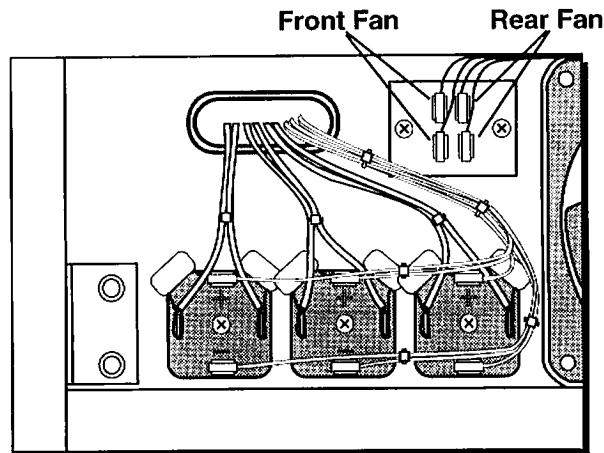
#### **To remove the fans:**

1. Disable the amplifier by performing shut down procedures as covered in Section 6.2.1.
2. Remove the single screw (Item 52) on the rear panel to loosen the fan side panel (Item 46).
3. Slide the fan side panel out.
4. Remove the four socket cap screws (Item 42) that secure each fan.

5. Remove the wire connectors for the appropriate fan. Illustration 6-7 shows the relationship between the fans and the connectors. The front pair of connectors power the front fan. The rear pair of connectors power the rear fan.

**To install a new fan:**

1. Connect the wire terminals as shown in Illustration 6-7.
2. Make sure that the air flow directional arrow on the fan case points into the center of the unit.
3. With the fan in position, insert and tighten the screws.
4. Slide in the fan side panel. Fasten the cover with a single screw through the rear panel.



**Illustration 6-7 Fan Connectors and Rectifiers**

## ***6.7 Power Supply Rectifier Blocks***

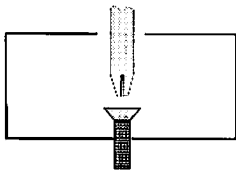
See Item 39, Illustration 8-1; also see Illustration 6-7.

**To remove:**

1. Disable the amplifier by performing procedures of Section 6.2.1
2. Remove right side panel by removing one screw from rear cover.
3. Remove the wires.
4. Remove the phillips mounting screw. The nut is captive.

**To install:**

1. Solder two 0.1  $\mu$ F capacitors in place on the new rectifier (refer to C409 through C414 on the Power Supply Schematic).
2. Apply heat sink compound (see the end of Section 8.6) to the block mounting surface.
3. Install the mounting screw.
4. Reattach the wires as shown in Illustration 6-7. Each block has two interchangeable wires of the same color along with a red (+) and blue (-).
5. Slide right side fan panel in place and secure with one screw in rear cover.



---

## 6.8 Solid State Relays

See Illustration 6-8; also see Item 3 Illustration 8-1.

### To remove:

1. Disable the amplifier by performing procedures of Section 6.2.1.
2. Remove left side fan panel (Item 46) by removing one screw (Item 52) from rear cover.
3. Disconnect the wiring and capacitors at the screw terminals.
4. Remove the two mounting bolts from the solid state relay. The nuts inside are captive.

### To install:

1. Apply heat sink compound (see end of Section 8-6) lightly and completely to the mounting surface of the solid state relay.
2. Mount the relays in place on the side panel.
3. Reattach the wires and capacitors.
4. Slide left side fan panel in place and secure with one screw in rear cover.

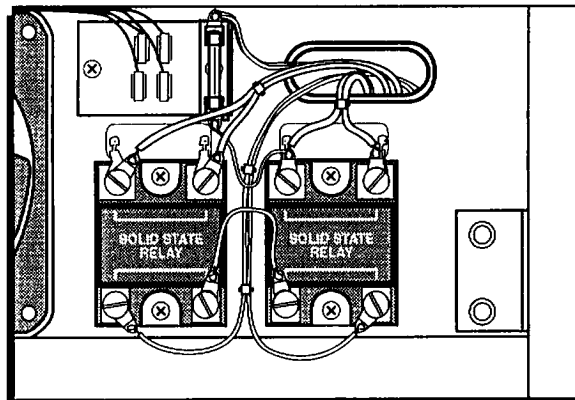


Illustration 6-8 Solid State Relays

## 6.9 Ribbon Cables Serving J3

Before removing the ribbon cables, note their routing. Reinstall the ribbon cables according to the original routing.

### To remove:

1. For proper access to ribbon cables, you must remove front, top, bottom, and rear panels. See Sections 6.3 and 6.4.
2. Slide output shelf back about 4 inches to allow cables to route over transformer.
3. Detach cables from main circuit board.

### To install:

1. Route cables in same manner as original placement.
2. Reassemble output shelf and exterior panels.

## 6.10 Servicing Main Circuit Board

Removal of the Main Circuit Board (Item 13 on Illustration 8-1) requires disconnection of the ribbon cables and output board connector, disconnection of the main power supply, and removal of the four circuit board mounting screws.

Service the Main Board components in accord with standard PC board procedures. Use an IC extractor to avoid damaging these components.



### CAUTION

Once the ribbon cables, output board connector, and power supplies are disconnected, the Main Circuit Board is no longer protected against static electricity. Service the Main Circuit Board in a static-free environment. Wear wrist static straps.

#### To remove:

1. Disable the amplifier by performing procedures of Section 6.2.1.
2. Remove the front panel. (See Section 6.4 for precautions on front panel removal and replacement.)
3. Using ejector latches, disconnect the ribbon cable from J300, and disconnect the output connector from J400. See Illustration 6-9.
4. Disconnect the power supply connector from terminal J500 on the right side of circuit board.
5. After power supply is removed, inspect the pins of J500 and straighten any that may have become bent.
6. Remove the four mounting screws from the Main Board.
7. The Main Circuit Board and gray insulating panel (Item 14 in Illustration 8-1) can now be lifted off.

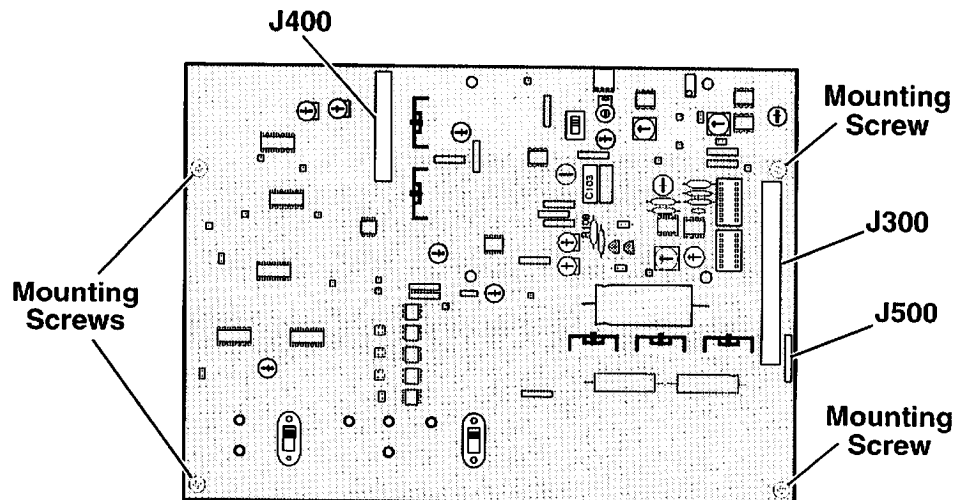
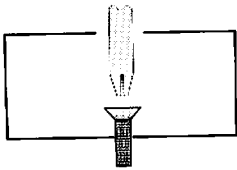


Illustration 6-9 Main Circuit Board Connections



## CAUTION

Use good solder removal methods to avoid damage to the plate-through holes in the circuit board.

### To install the main circuit board:

1. Place the gray insulator panel (Item 14) over the mounting holes.
2. Place the Main Circuit Board (Item 13) in position and attach it with four mounting screws.
3. Connect the power supply cables at J500 taking care to protect the connecting pins.
4. Connect the ribbon cable to J300 and the output connector to J400. Note that the ribbon cable makes a "U-turn" over the connector. Further, note that the connections will only fit in the correct location and only in the correct orientation. Only slight force should be needed to connect each of these connections. See Illustration 6-9.
5. If used, reattach the nylon washers on one or more mounting screws.
6. Refer to Section 7, Testing and Adjustment, for the procedures to follow after the replacement of the Main Circuit Board.

## 6.11 Servicing the Power Supply

**Note:** All "Item" references are from Illustration 8-4.

The power supply components include: two capacitors (Item 17), a low voltage control transformer (Item 5), and a power transformer (Item 13).



## DANGER

*Shock Hazard!* Disconnect the power by removing the incoming power line. It is essential that the capacitors be allowed to discharge before service. See Section 6.2.1.

### To service the power supply components:

1. Shut down the amplifier by performing the procedures in Section 6.2.1.
2. Remove the top and the bottom panels. See Section 6.4.
3. Remove the output shelf assembly to provide access to the power supply components. See Section 6.5.

### 6.11.1 Removing Control Transformer & Caps

1. Remove the mounting bracket (Item 8), which is held in position by three 1/4-20 x 2-1/2 cap screws (Item 10).

**Note:** In removing the cap screws, take care to retain the shoulder washers that insulate the mounting bolts from the bracket. There are six shoulder washers (Item 9), three on each side of the mounting bracket.

2. With the cap screws removed, the entire bracket with capacitors and transformer attached can be removed through the bottom of the unit.



---

## 6.11.2 Servicing the Capacitors

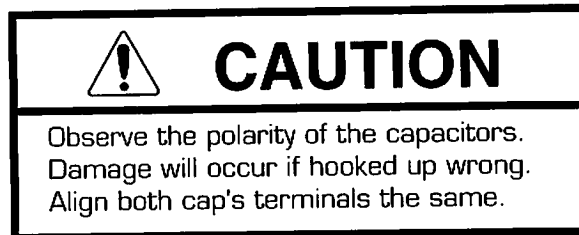
Each capacitor (Item 17) is attached to the mounting bracket (Item 8) with a capacitor mounting bracket (Item 4). A bleeder resistor (Item 1) bridges the positive and negative terminals of the left capacitor.

### To remove the capacitors:

1. Verify the discharge by connecting the capacitor terminals to a voltmeter. The voltmeter should show a zero reading.
2. Remove the screws (Item 3).
3. Remove the wires, noting the mounting location for proper connection of the replacement capacitors.
4. Remove the bleeder resistor and bus bars.
5. Loosen the bolts on the capacitor mounting brackets (Item 4).
6. Carefully slide the capacitor out of the capacitor bracket.

### To install the capacitors:

1. Carefully slide the capacitor (Item 17) into the capacitor mounting bracket (Item 4), taking care not to scratch the surface of the capacitor.
2. Tighten the capacitor mounting bracket.



3. Attach the bus bars (Item 2) across the terminals.
4. Attach bleeder resistor (Item 1) on terminals farthest from the control transformer (Item 5).
5. Attach the blue wire set to the negative (-) terminal and the red wire set to the positive (+) terminal.
6. Finger-tighten the terminal screws. (Single red and blue wires from the output shelf will need to be reattached before the final tightening of the terminal screws.)

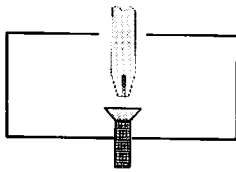
## 6.11.3 Servicing the Control Transformer

### To remove the control transformer:

1. Loosen the two nuts (Item 6) holding the control transformer to the studs on the large mounting bracket (Item 8).
2. Trace the wires from the transformer to their terminations. Note and mark the connections to ensure proper installation of the replacement transformer. Disconnect the wires at the termination points, unbundle, and remove the low voltage control transformer.

### To install the control transformer:

1. Fasten the transformer (Item 5) to the main mounting bracket (Item 8).
2. To reassemble inside unit, insert the mounting bracket (Item 8), with the capacitors and transformer attached, through the bottom of the unit.
3. Insert cap screws (Item 10) from the bottom with shoulder washers (Item 9) on both ends. Fasten the washers and screws with 1/4-20 nuts and lockwashers. Tighten securely.
4. Connect the wires at the termination points.

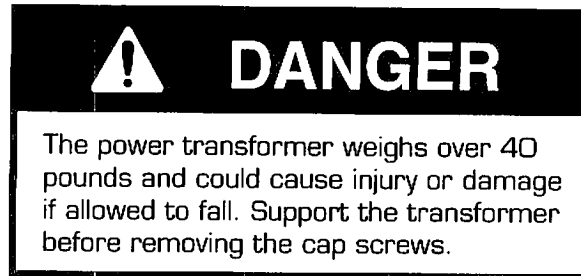


---

## 6.11.4 Servicing the Power Transformer

### To remove the power transformer:

1. Note the wire locations and mark them as necessary. Particularly note the three Faraday shield wires from the transformer coils that are chassis-grounded behind the front panel. Except for those Faraday shield wires, disconnect all wires at the termination points.
2. Separate the mounting bracket (Item 8) from the power transformer (Item 13).
3. Remove the Main Circuit Board as described in Section 6.10.
4. Loosen, but do not remove, the six cap screws (Item 15) from the power transformer brackets.



5. Remove the transformer shim (Item 14).
6. After ensuring that the transformer is securely supported, complete the removal of the six cap screws (Item 15). The detached transformer can be removed from the bottom of the main unit.

### To install the power transformer:

1. After ensuring that the transformer is securely supported and in place, finger-tighten the six cap screws a few turns into the transformer mounting brackets.
2. Slip the transformer shim in place.
3. Attach the mounting bracket (Item 8) that holds the capacitors and control transformer. Be sure to use shoulder washers at both the top and bottom.
4. Insert the stripped ends of the Faraday shield wires in between the chassis front panel and the aluminum shim. Tighten all six cap screws (Item 15) securely.
5. Connect the wires at the termination points.
6. Replace the output shelf as instructed in Section 6.5.

## 6.12 Servicing the Output Wells

Model 7700 contains four different output wells that are located on the output shelf assembly (Illustration 8-1, Item 67). While the four wells appear similar, each is different and must be placed in a specific position. Illustration 6-10 shows the four output wells and their positions. Any well can be individually removed and installed without removing the output shelf.

**Note:** Insulation between the heat sinks and output shelf serves as a gasket for cooling air as well as electrical isolation. A damaged gasket must be replaced. See Section 6.5.4.



## DANGER

The output wells hold live current and are not earth-grounded. A *shock* hazard exists even with the AC mains disconnected. See safety procedures in Section 6.2.1.

### 6.12.1 Removing and Installing Output Wells

Refer to Illustration 8-2 for aid in changing the output wells.

#### To remove any individual output well:

1. Shut down the amplifier by performing procedures in Section 6.2.1.
2. Remove the top panel by removing one screw from the back cover.
3. Disconnect the output interconnect board from the Main Circuit Board at J400.
4. Remove RTV Silicone Adhesive from the output interconnect board connectors to each predriver board.
5. Remove the four corner screws on the output well.
6. Remove two center mounting screws. One of the two center screws is recessed on wells 2 and 3.
7. Remove well by pulling it straight up.

#### To install the output wells:

1. Insert the center conducting screws. Note that one of the center screws in each of the middle output wells is recessed below the surface. Torque to 25 inch-pounds ( $\pm 2$  in-lb).
2. Insert four corner mounting screws. Torque to 6 inch-pounds ( $\pm 1$  in-lb).
3. Reconnect the output interconnect board to the predriver boards and Main Circuit Board.
4. Glue connections to predriver boards with RTV Silicone Adhesive.

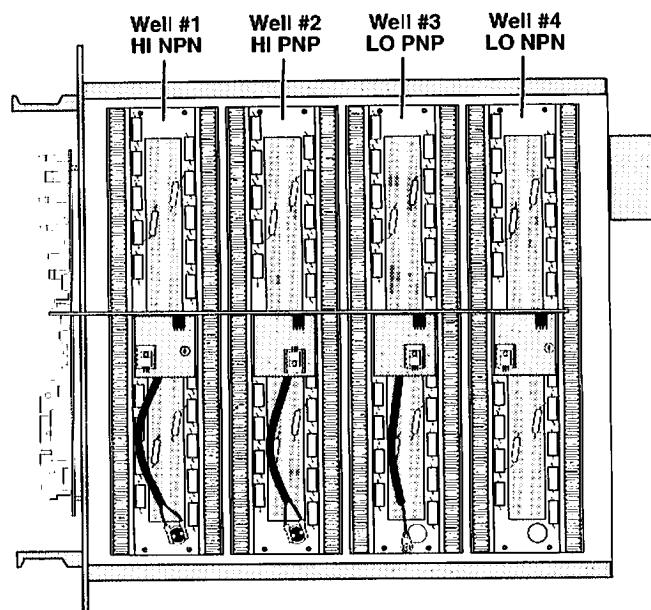
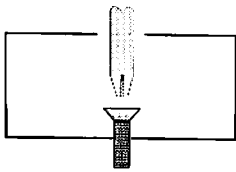


Illustration 6-10 Output Wells Top View



## 6.12.2 Replacing Output Transistors

### To replace a transistor:

1. Disable the amplifier as explained in Section 6.2.1
2. Remove the well with the defective component.
3. Work from the bottom of the well.
4. For PNP wells (wells 2 and 3) only: each output transistor is connected to a central bus bar via a collector resistor. See Illustration 6–11. Unsolder the collector resistor of the faulty transistor from the bus bar.
5. Remove the transistor mounting screws. On PNP wells: the resistor solder lug on one screw serves as the star lockwasher.
6. Turn the output well over to work.
7. Unsolder the leads of the faulty transistor from the center portion of the gold-colored base PC board and from the emitter resistor lead.
8. Loosen the leads. Then remove the faulty transistor.
9. Replace the transistor with one having the same *part* and *grade* number.

**Note:** The transistors in each output well are matched to each other. Stable amplifier operation cannot be assured unless the *part* number and *grade* number are matched on all transistors in the same output well.

10. Apply heat sink compound (see end of Section 8.6) to the surface of the replacement transistor. Apply the compound completely and lightly so that only a small amount will be squeezed out when the transistor screws are tightened.
11. Install the mounting screws and star lockwashers (solder lug for PNP wells). Tighten the mounting screws before resoldering the leads. Torque to 11 inch-pounds ( $\pm 2$  in-lb).



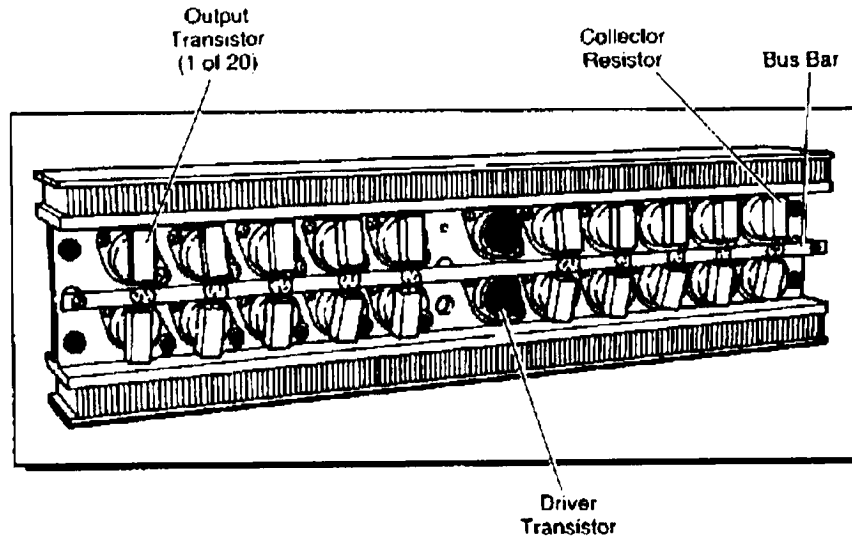
### CAUTION

Tightening the transistor mounting screws *after* the leads are soldered will break the internal transistor connections. Solder the transistor leads only after the screws are tight.

12. Clinch the emitter resistor lead securely around the emitter lead of the transistor.

**Note:** To maintain the highest degree of dependability, the lead from the emitter resistor must be clinched around the lead of the transistor emitter.

13. Solder the leads in place.
14. For PNP wells only: resolder the collector resistor lead back onto the bus bar (using 175–200 watt soldering iron) before replacement. For examples, see the other collector resistors on the same bus bar assembly.
15. See Section—7 *Adjustments and Tests* for the necessary adjustment procedures.



**Illustration 6-11 Transistor Location**

### **6.12.3 Replacing Driver Transistors**

See Illustration 6-11 for the location of the driver transistors.

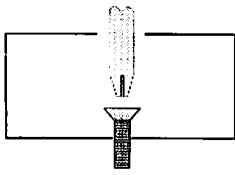
1. Disable the amplifier as explained in Section 6.2.1.
2. Remove the well with the defective component.
3. Position the output well on its side to allow access to both the top and bottom.
4. Remove center screws from predriver board. On wells 1 and 4, the RTV Silicone Adhesive must be cut between the bias servo and heat sink. Lift the predriver board carefully, allowing the wiring to act as a hinge.
5. Remove the mounting bolts from the driver transistors.



## **CAUTION**

To protect the solder connections of the predriver board, do not move the board more than necessary.

6. Unsolder the leads of the faulty driver transistor.
7. Apply heat sink compound (see the end of Section 8.6) to the mounting surface of the replacement transistor. Apply the compound completely and lightly so that only a small amount will be squeezed out when the transistor mounting screws are tightened.
8. Bolt the new driver transistor in place. The torque range is 11 inch-pounds ( $\pm 2$  in-lb).
9. Solder the leads of the new transistor in place.
10. Screw the predriver board onto the well. If this is well 1 or 4, glue bias servo to heat sink using RTV Silicone Adhesive.
11. See Section—7 *Adjustments and Tests* for the necessary adjustment and calibration procedures.



## 6.12.4 Replacing Emitter Resistors

**Note:** All 0.33-ohm, 5-watt emitter resistors used in the output wells are identical. Their characteristics are designed into the amplifier. Stable operation cannot be assured unless replacements are ordered from Techron.

1. Disable the amplifier as outlined in Section 6.2.1.
2. Unsolder the resistor leads.
3. Remove the emitter resistor from the emitter lead of the transistor.
4. Install the replacement emitter resistor observing the "S" shape bends in the leads. See Illustration 6-12.

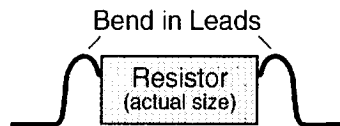


Illustration 6-12 Emitter Resistor Leads



### CAUTION

The emitter resistor leads are extra long and are bent in an "S" shape to improve heat dissipation. Failure to make this bend may cause the solder to melt.

5. Clinch the emitter resistor lead tightly around the transistor emitter lead.

**Note:** To insure the highest level of dependability in operation, the emitter lead from the transistor must be clinched around the emitter resistor lead.

6. Solder the emitter resistor lead to the emitter lead of the transistor.
7. See Section—7 *Adjustments and Tests* for tests required after repair.

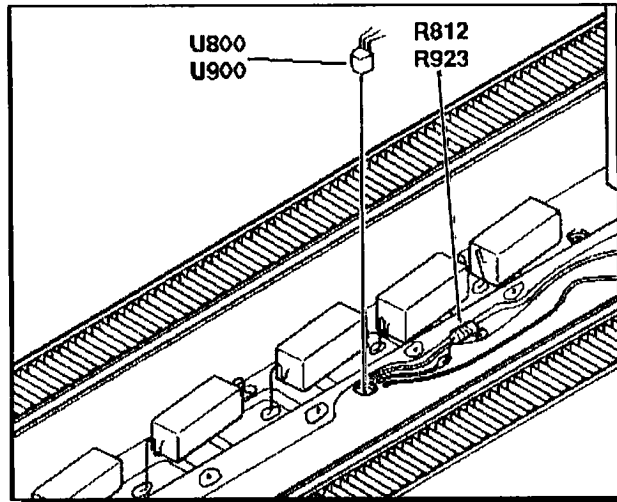
## 6.12.5 Electronic Thermal Sensors, Wells 3 & 4

### To remove:

1. Disable the amplifier as outlined in Section 6.2.1.
2. Unsolder the leads and pull the sensor up and out of the recess. See Illustration 6-13.

### To install:

1. Prepare the replacement sensor as follows:
  - a. Install 3/8-inch Teflon® insulating tube over each of the sensor leads.
  - b. Bend the leads 90 degrees at the bottom of the tubing.
  - c. Trim the excess lead to 0.150 inches.
  - d. Fold the leads down against the flat side of the transistor body.
2. Insert the sensor in the heat sink.
3. Solder the leads.
4. Apply heat sink compound to the top of the sensor.
5. See Section—7 *Adjustments and Tests* for tests required after repair.



**Illustration 6-13 Electronic Thermal Sensor**

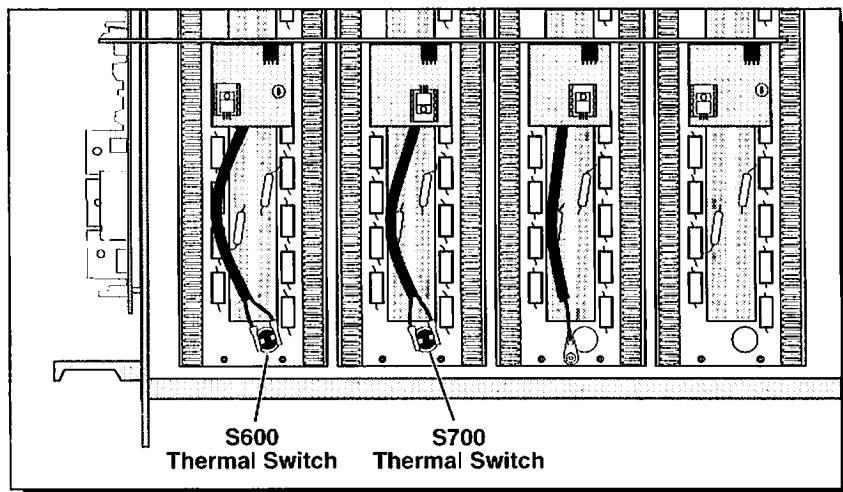
### **6.12.6 Thermal Switch, Wells 1 & 2**

**To remove:**

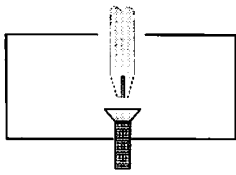
1. Disable the amplifier as outlined in Section 6.2.1.
2. Remove the well with the defective component.
3. Disconnect the leads from the thermal switch by pulling up on the plastic covered terminals. See Illustration 6-14.
4. Turn the thermal switch counterclockwise to remove it from the mounting position. The nut below is not captive.

**To install:**

1. Apply heat sink compound (see end of section 8.6) to the thermal switch.
2. Install the new thermal switch. Fasten the nut on the threaded shaft of the thermal switch.
3. Reconnect the black wires. The black wires are interchangeable.



**Illustration 6-14 Thermal Switch Location**



---

### **6.12.7 Bias Servo Transistor, Wells 1 & 4**

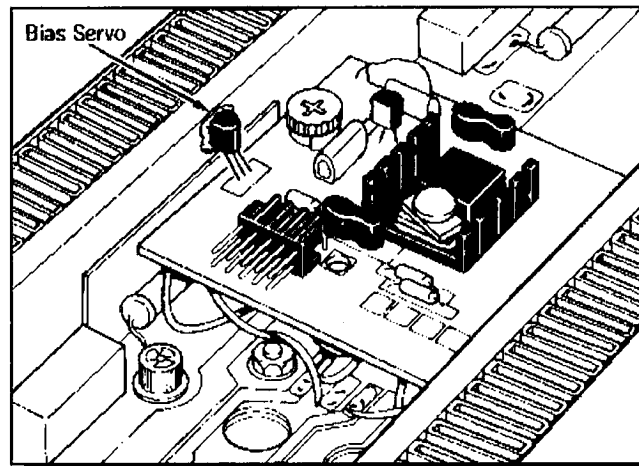
Bias servo transistors can be replaced without removing the well from the amplifier. See Illustration 6-15 for the location.

**To remove:**

1. Disable the amplifier by performing Section 6.2.1 procedures.
2. Disconnect the output interconnect board from the Main Circuit Board and the four predriver boards.
3. Remove the bias servo transistor from its position on the side of the heat sink.
4. Remove the center screw from the predriver board. Lift the predriver board carefully, allowing the wiring to act as a "hinge."
5. Remove the old silicon glue from the heat sink.
6. Unsolder the bias servo transistor leads.

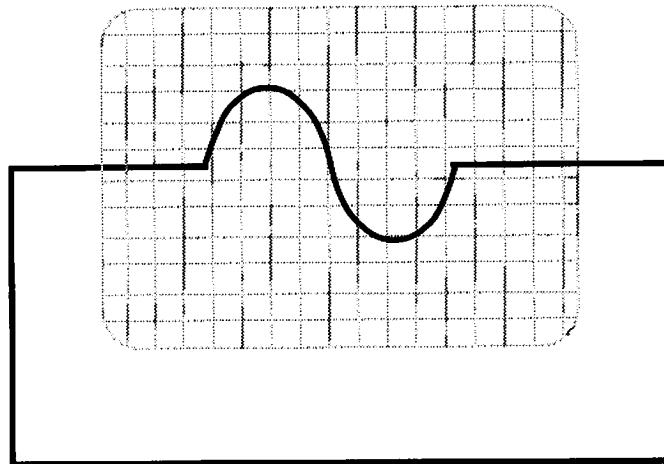
**To install:**

1. Solder the leads of the new transistor in place.
2. Screw predriver board back into well.
3. Glue the new bias servo transistor in place with silicon glue. Use the other bias servo as a model of the proper gluing procedure. Ensure that the flat of the bias servo is contacting the heat sink.
4. Connect the output interconnect board and use RTV Silicone Adhesive to glue connections to the predriver boards.



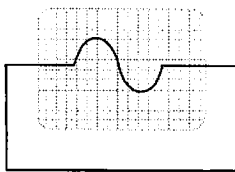
**Illustration 6-15 Bias Servo**





## ***Section 7—Adjustments and Tests***

This section describes the tests and adjustments you may need to perform following other service activities such as parts replacements.



## 7.1 Preparation for Testing



### WARNING

An *ELECTRIC SHOCK* hazard exists within the enclosure. Observe safety policies as outlined in Sections 5.3 and 6.2.1. Allow only qualified Technicians to perform repairs, tests, and adjustments.

### 7.1.1 When to Perform Tests

The procedures outlined in this section must be performed following service to the Model 7700 amplifier. The procedures in this section are NOT required following the replacement of fans. Table 7-1 lists the tests required after replacement of specified parts or modules.

Parts Replaced	Tests Performed
L1, N100, U100, or associated parts	7.9, 7.12
R758-R763, N101, U101, U102, U103, U104 or associated parts	7.2, 7.10, 7.11, 7.12, 7.17
U102 or associated parts	7.3, 7.17
Schematic parts numbered 200-299	7.3, 7.7, 7.13, 7.15
Schematic parts numbered 300-399	7.5, 7.23
Schematic parts numbered 400-499, T1, and T2	7.1.4
Schematic parts 500-599	7.6, 7.14, 7.16, 7.21, 7.22, 7.23, 7.24, 7.26
Schematic parts 600-699, 700-799, (except R758-R763)	7.8, 7.15, 7.16, 7.22, 7.23
Schematic parts 800-899, 900-999	7.5, 7.8, 7.15, 7.16, 7.17, 7.22, 7.23

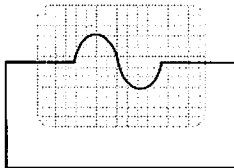
Table 7-1 Tests Performed After Repair

## 7.1.2 Equipment Requirements

In addition to standard hand tools and electronic test equipment, the following specialized equipment is required to perform the tests in this section. Using the equipment listed will help you test and adjust the amplifier to factory specifications. Any compromises in equipment could result in unsatisfactory performance or calibration.

Equipment Needed	Recommendation
1. Oscilloscope Dual Channel Vert. Sensitivity - 2mV/div Vert. Frequency DC-15 MHz	Tektronix 2245A Hewlett-Packard 1740A Phillips PM3207
2. Audio Signal Generator Sine/Square Output-3 Volts RMS into 600 ohm load, 1%THD	Wavetek 193 Khrohn-Hite 1000, 1200
3. AC Voltmeter 20Hz-4Mhz Sensitivity-100 $\mu$ V FS $\pm$ 1% Accuracy 20-20kHz	Hewlett-Packard 400F Amber 3501 Sound Technology 170B/1710A
4. Digital Voltmeter AC/DC Volts-1mV-100v AC/DC Amps-10mAmps-10 Amps Ohms-.1 ohm-10Mohms	Data Precision 248/1350,1351 Fluke 8020B Fluke 8060 series
5. Intermodulation Distortion Analyzer IM capable of .003% 60Hz/7kHz THD capable of .01% 20Hz-20kHz	Amber 3501 Sound Technology 17701A Hewlett-Packard 339A
6. Bandpass Filter 20-20kHz, 18dB/Octave rolloff	Sound Technology 170 or equivalent.
7. Resistive Loads 8 ohms-1kW 4 ohms-2kW 2 ohms-500 W	Construct from Dale NH-250 series, 1% resistors.
8. Non metallic screwdriver	GC 8276 or 8277
9. Precision Current Shunt	1% resistor
10. Current limited DC Power Supply 60 volts at 1.0 amperes.	Lambda LQD 423 series

**Table 7-2 Recommended Test Equipment**



### 7.1.3 Pretest Procedure



## WARNING

These tests and adjustments are performed with AC power **ON** and with protective panels removed. Test steps must be followed and caution taken to avoid accidental touching of "live" terminals, heat sinks, or components. Potentially **lethal ELECTRIC SHOCK** can occur if you make accidental contact with these components.

This section warns and cautions you about the testing environment and where to begin testing. Begin tests by following these procedures:

1. Remove front, top and side panels (see section 6.4).
2. Inspect wires, cables, connections, terminals and other visible components to check for breaks or broken parts. Generally check to see if unit appears to be in proper mechanical condition.
3. Begin test procedures with jumpers and switches (see illustration below) in the following positions:

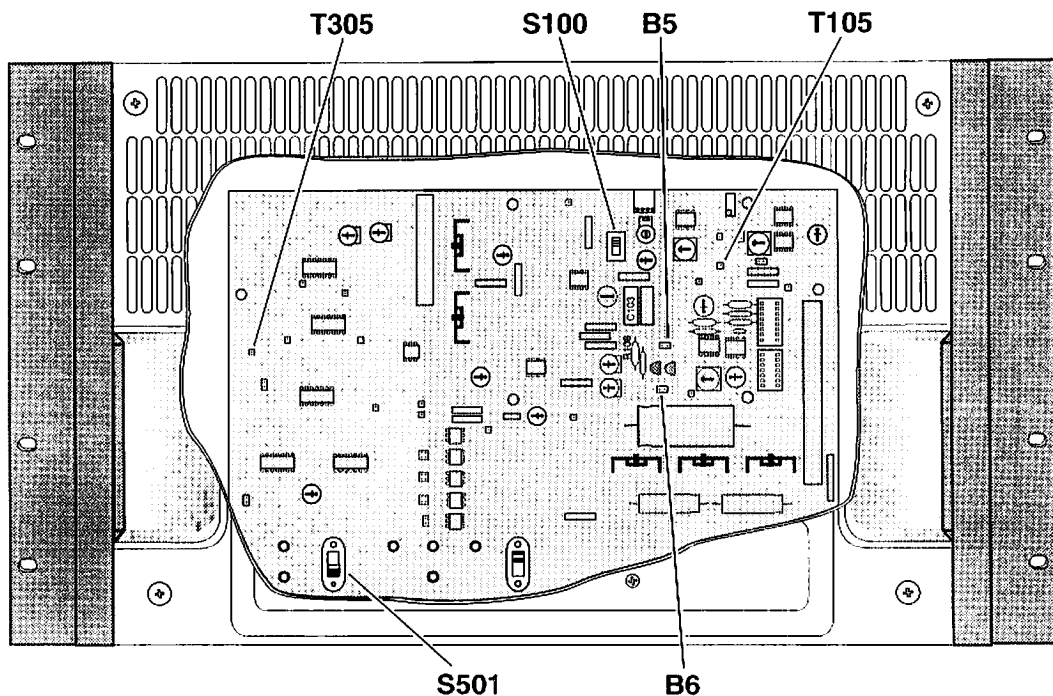
**S501** Enable/Disable switch-----Down (Disabled)

**S100** Master/Slave switch-----Up (Master)

**B5** CV/CC Mode jumper-----Left (CV)

**B6** Compensation jumper-----Right (R108, C103)

4. Use **T105** or **T305** ground terminals, unless specified otherwise, for the connection of the common probe of test equipment for all amplifier tests.



**Illustration 7-1 Main Board Settings and Test Points**

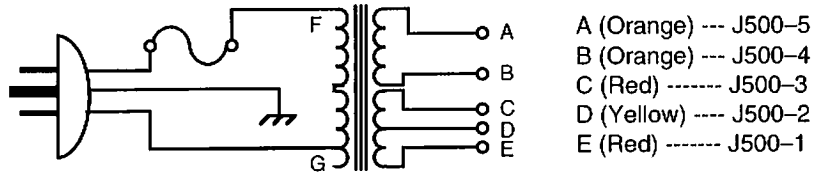
## 7.1.4 Power Supply Pretest



### DANGER

Do not proceed until the Model 7700 has been disconnected from the AC mains. Dangerous voltage points are exposed in the next steps. Failure to disconnect AC could result in injury or death.

1. Remove input signal, loads, and AC power connection.
2. Connect a signal generator to the amplifier input. Set for 1kHz continuous sine wave.
3. Connect a temporary control transformer, Crown Part # M20643-9, to J500 on the main board. Use the following diagram and list to connect the transformer leads to the connector J500 pins.



F (Blk/Red) --- 208 Vac

G (Blk/Brn) --- 208 Vac Neutral

4. Remove the internal Vcc connections and connect current limited power supplies by following these sub-steps:
  - (1.) Remove the right side fan panel
  - (2.) Disconnect the Vcc supply wires from the (+) and (-) terminals on the rectifier block nearest the front.
  - (3.) Connect the Vcc wires to voltage and current limited DC supplies observing the same polarity. Set the supplies to limit at 60 volts and 0.3 amperes.

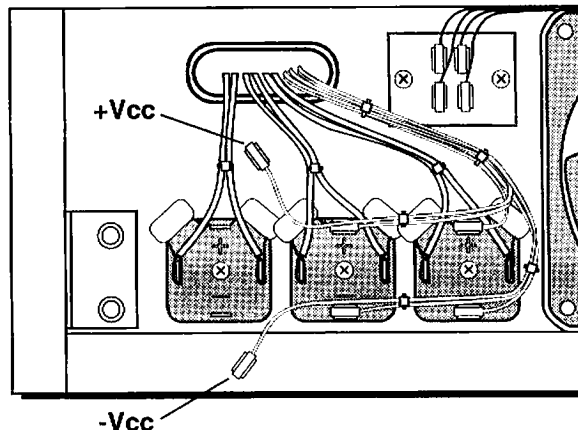
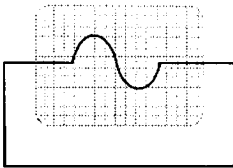
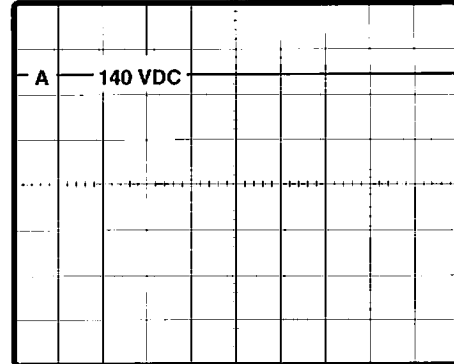
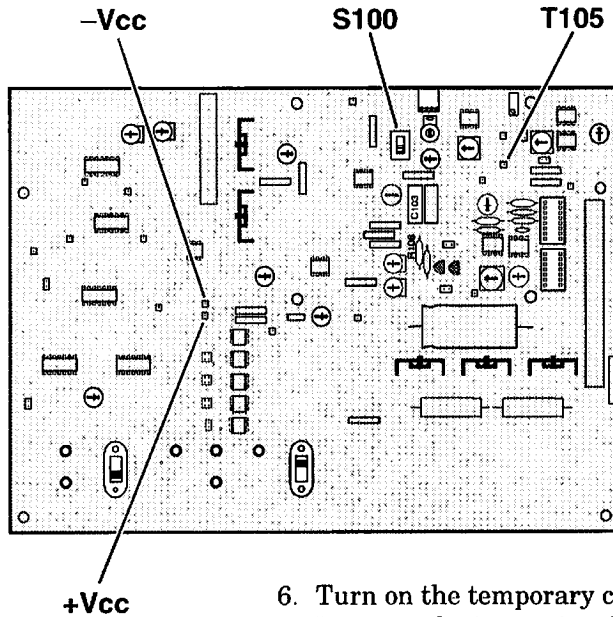



Illustration 7-2 Vcc Connection Points



5. Connect a two channel oscilloscope, one chl. to  $-V_{cc}$  and the other to  $+V_{cc}$ . Do not use scope ground leads. Set Channel 2 for Invert and Add.



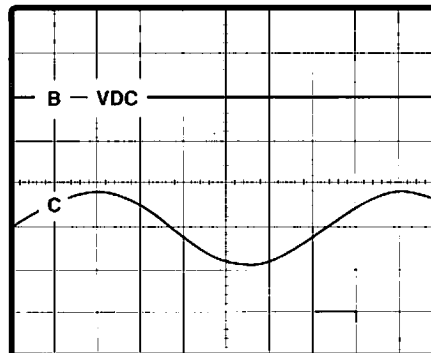
6. Turn on the temporary control transformer and the DC supplies.
7. Increase the input signal and observe the oscilloscope for wave form A.
8. Set S100 down to SLAVE.
9. Connect Channel 1 scope probe to  $+V_{cc}$  and Channel 2 probe to T201. Connect the ground lead to T105.
10. Disable the INVERT and ADD setting on the scope.



## CAUTION

Be prepared to switch S100 back down if the amplifier behaves abnormally in step 11.

11. Set S100 up to MASTER.
12. Observe the scope. Wave form should be similar to (B) and (C).

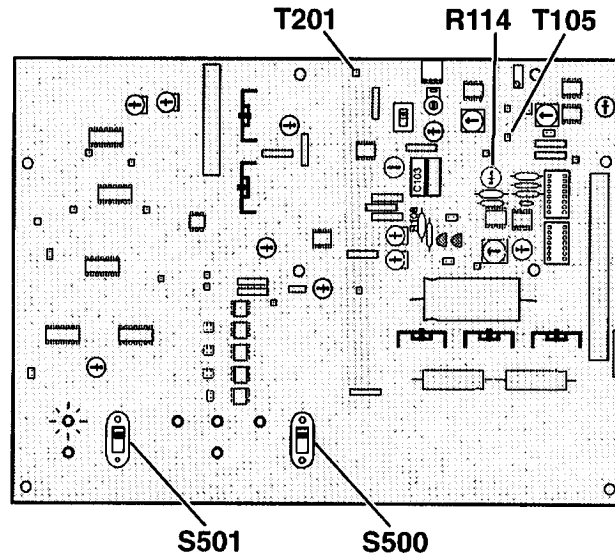


13. Turn off AC power to the DC supplies and the temporary transformer. Restore the original wiring to J500 and the  $V_{cc}$  supplies.
14. Replace the fan cover.

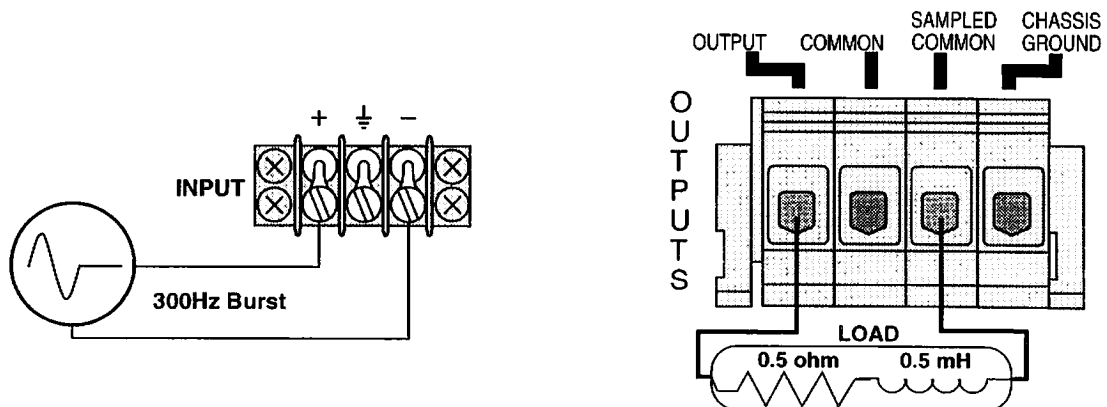
## 7.2 General Amplifier Test

This is a general check-out of the 7700 before proceeding to specific circuitry and component tests.

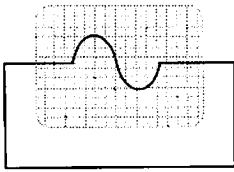
1. Connect AC power to the appropriate AC mains (see back panel tag).
2. Disable the amplifier by placing switch S501 down to STANDBY.
3. Indicator LEDs STANDBY and OVERLOAD could both be illuminated.
4. Verify that input clipper adjustment R114 is turned fully clockwise.
5. Enable amplifier by switching S501 up to READY.



6. Push momentary RESET switch S500 down to clear any OVERLOAD indication that may have occurred.
7. The READY indicator LED should be the only one illuminated. If not, there is a failure in the circuitry.
8. Disable amplifier by switching S501 down to STANDBY.
9. Connect a 0.5 ohm, 0.5mH load to the amplifier output terminal block.
10. Connect a 300Hz sinewave, 20% duty cycle tone burst, 10 volt signal to the input terminal block.

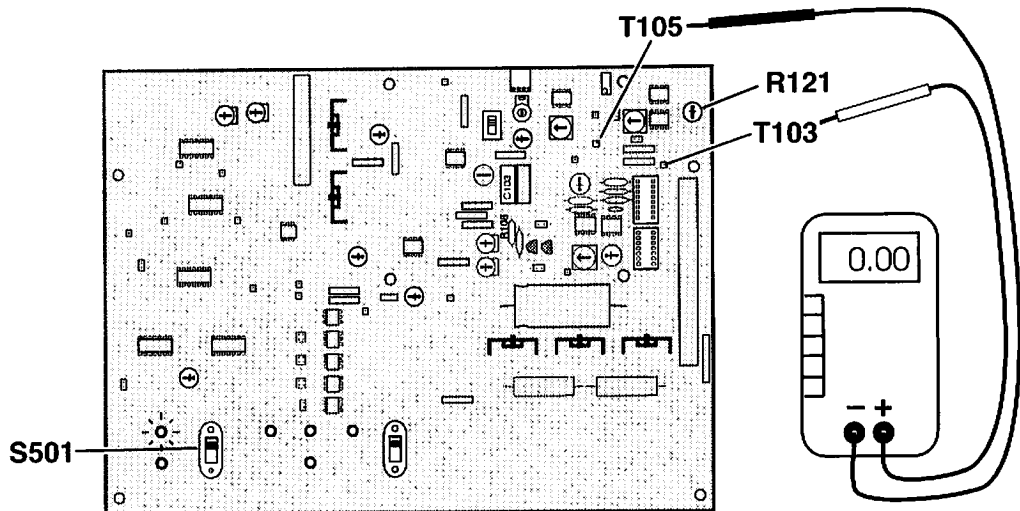


11. Connect oscilloscope (+) probe to T201 and ground to T105.
12. Enable amplifier by switching S501 up to READY.
13. Waveform on oscilloscope should show a clean sinewave burst with no spurious oscillations.



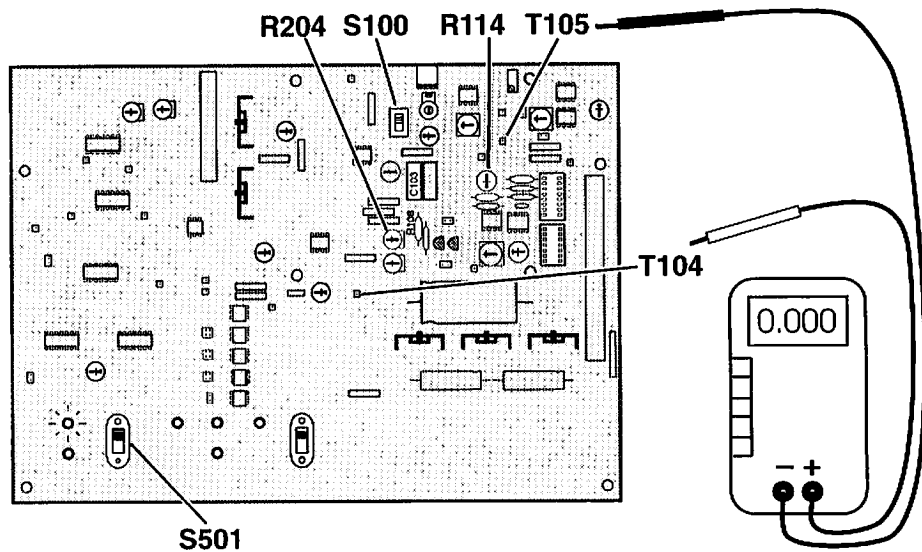
## 7.3 Adjust Current Monitor Zero

1. Set S501 down to STANDBY.
2. Remove loads and input signal.
3. Connect positive voltmeter lead to T103; negative lead to T105.
4. Adjust R121 to obtain 0.00 VDC ( $\pm 0.02$  VDC) reading.



## 7.4 Adjust Output Offset Voltage

1. Connect positive voltmeter to T104; negative lead to T105.
2. Set S100 down to SLAVE.
3. Set S501 up to READY.
4. Adjust R204 for 0.000 Vdc ( $\pm 0.001$  Vdc).
5. Set S100 up to MASTER.



6. Short the input by connecting all three input screw terminals together.
7. Adjust R117 for 0.000 VDC ( $\pm 0.001$  Vdc).
8. Set S501 down to STANDBY.
9. Adjust R114 fully clockwise to set Clip Level.

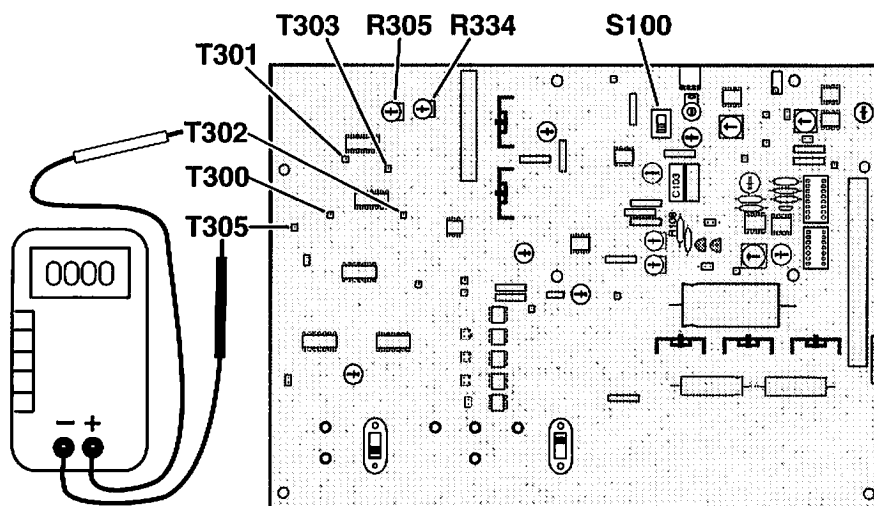


## 7.5 Adjust Multiplier Zero

This adjustment is influenced by the internal temperature of the unit at the time of the test. If the unit has recently been operating under load, allow ten minutes of cool-down time (with fans operating) to obtain readings consistent with the ambient temperature.

1. Disconnect loads and input signal.
2. Set switch S100 down to SLAVE.
3. Connect voltmeter positive lead to T302; negative lead to T305.
4. Find the value you get at T302 in the third column of Table 7-3 and mark the corresponding value in the fourth column.

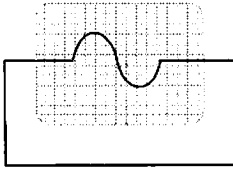
**Note:** This reading reflects the internal temperature of the amplifier according to the formula  $^{\circ}\text{K}/100$ .



5. Move positive voltmeter lead to T300.
6. Adjust R305 to the value marked in step 4 in the fourth column of table.
7. Move positive voltmeter lead to T303. The value should be as in step 4.
8. Move positive lead to T301.
9. Adjust R334 to the value marked in the fourth column of Table 7-3.

$^{\circ}\text{C}$	$^{\circ}\text{K}$	T302	T300	$^{\circ}\text{C}$	$^{\circ}\text{K}$	T302	T300	$^{\circ}\text{C}$	$^{\circ}\text{K}$	T302	T300
		T303	T301			T303	T301			T303	T301
17	290	2.90	12.96	29	302	3.02	11.52	40	313	3.13	10.20
18	291	2.91	12.84	30	303	3.03	11.40	41	314	3.14	10.08
19	292	2.92	12.72	31	304	3.04	11.28	42	315	3.15	9.96
20	293	2.93	12.60	32	305	3.05	11.16	43	316	3.16	9.84
21	294	2.94	12.48	33	306	3.06	11.04	44	317	3.17	9.72
22	295	2.95	12.36	34	307	3.07	10.92	45	318	3.18	9.60
23	296	2.96	12.24	35	308	3.08	10.80	46	319	3.19	9.48
24	297	2.97	12.12	36	309	3.09	10.68	47	320	3.20	9.36
25	298	2.98	12.00	37	310	3.10	10.56	48	321	3.21	9.24
26	299	2.99	11.88	38	311	3.11	10.44	49	322	3.22	9.12
27	300	3.00	11.74	39	312	3.12	10.32	50	323	3.23	9.00
28	301	3.01	11.64								

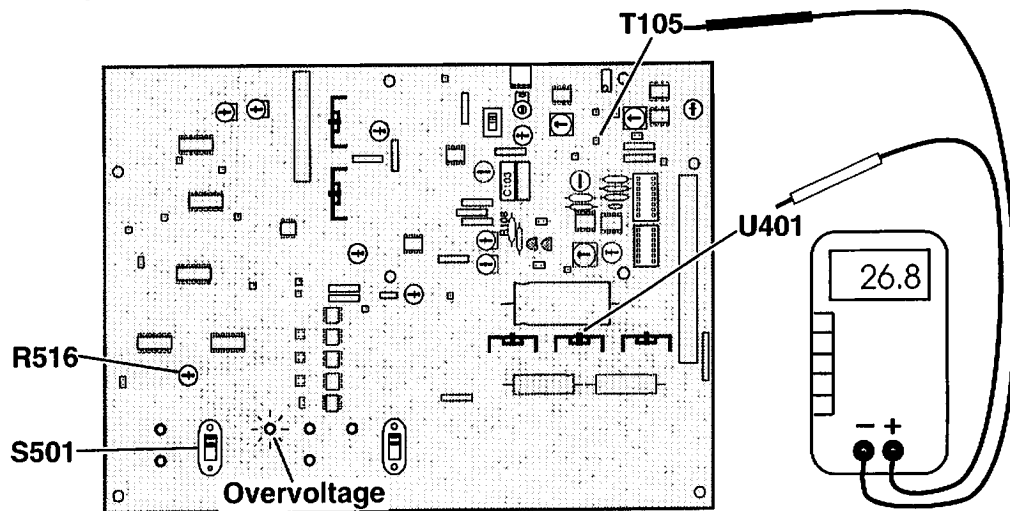
Table 7-3 Temperature Table



## 7.6 Adjust High Voltage Cutoff

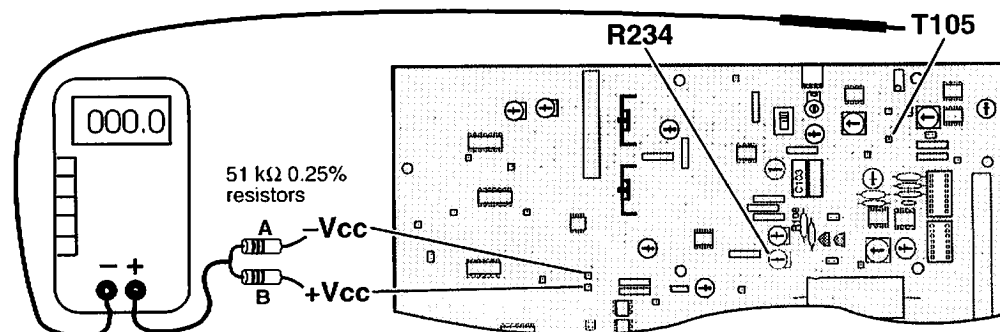
This test requires control of AC mains voltage and usually cannot be performed in the field. Perform this test only if AC mains control is available.

1. Disconnect loads and input signal.
2. Set S501 up to READY.
3. Connect positive voltmeter lead to middle lead or mounting screw of U401; negative lead to T105.
4. Adjust AC mains for DVM reading of 26.8 volts.
5. Observe OVERVOLTAGE light on front of unit.
6. Adjust R516 to the point at which OVERVOLTAGE light comes on.
7. Return AC mains back to normal level (meter reads 24.4 volts DC).  
STANDBY should go out, READY light should come on.
8. Set S501 down to STANDBY.



## 7.7 Adjust Static Balance

1. Disconnect loads.
2. Short the input by connecting all three terminals of the input connector.
3. Connect voltmeter to matched (0.25%) 51 k $\Omega$  resistors (see illustration).
4. Connect resistor (A) to -Vcc, (B) to +Vcc and voltmeter GND to T105.
5. Set switch S501 up to READY.
6. Adjust R234 to 0.0 VDC  $\pm$  0.2 VDC).
7. Set switch S501 down to STANDBY.



## 7.8 Adjust Output Stage Bias

This procedure tests each output well with voltmeter and adjusts for correct reading. Wells are to be tested in pairs (front two, then rear two); adjustments are for each pair in tandem.

**Note:** Allow output well heat sinks to cool to ambient temperature before performing this test.

1. Set switch S100 down to slave.
2. Set switch S501 up to READY.

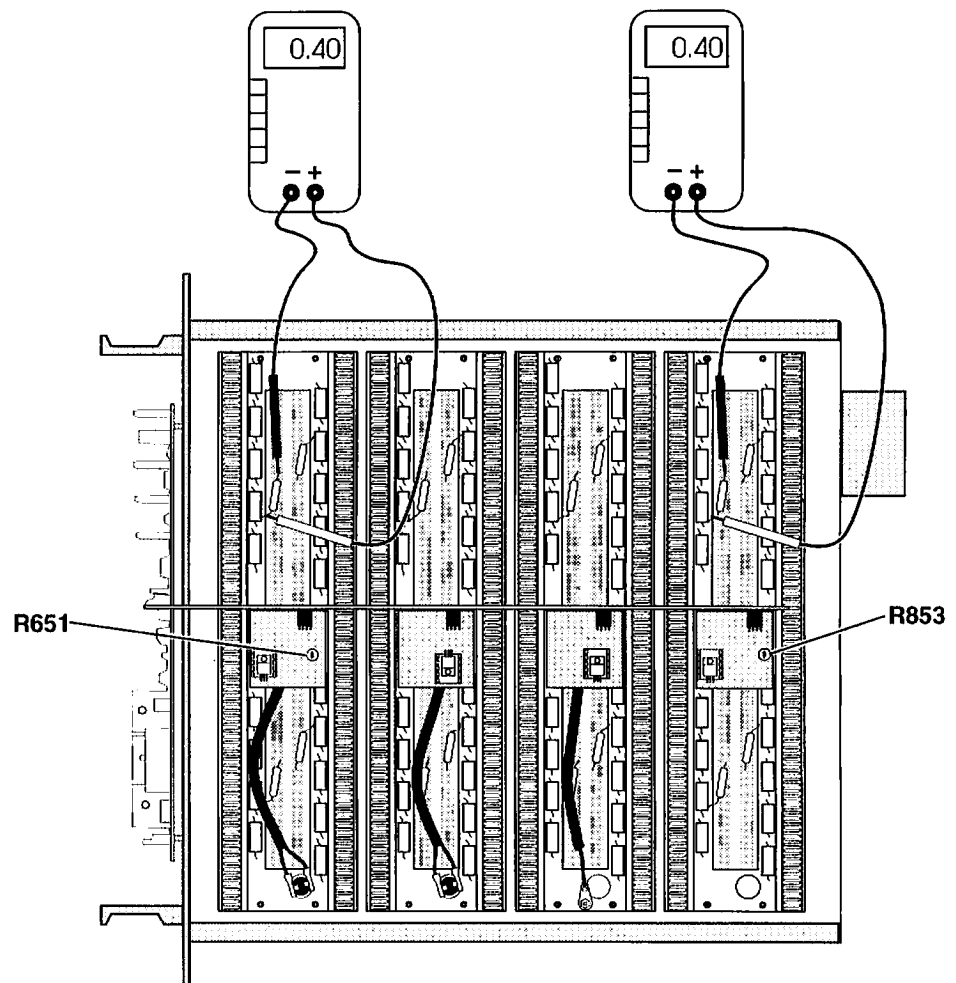
**For front pair of output wells:**

3. Connect voltmeter across 12 ohm resistor as shown in Illustration 7-3.
4. Adjust R651 on predriver board #1 for reading of .40 VDC ( $\pm .01$  VDC).

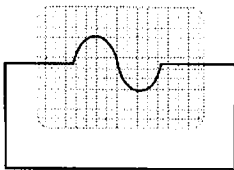
**For rear pair of output wells:**

5. Connect voltmeter across 12 ohm resistor as shown in Illustration 7-3.
6. Adjust R853 on predriver board #4 for a reading of .40 VDC ( $\pm .01$  VDC).

**Note:** Repeat tests on both pairs to make sure readings are .40 VDC ( $\pm .01$  VDC).

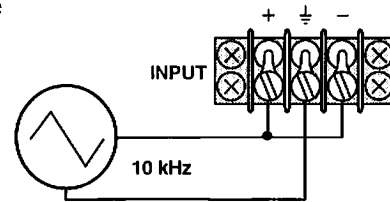


**Illustration 7-3 Output Wells/Amplifier Top View**



## 7.9 Adjust CMRR on Input Amplifier

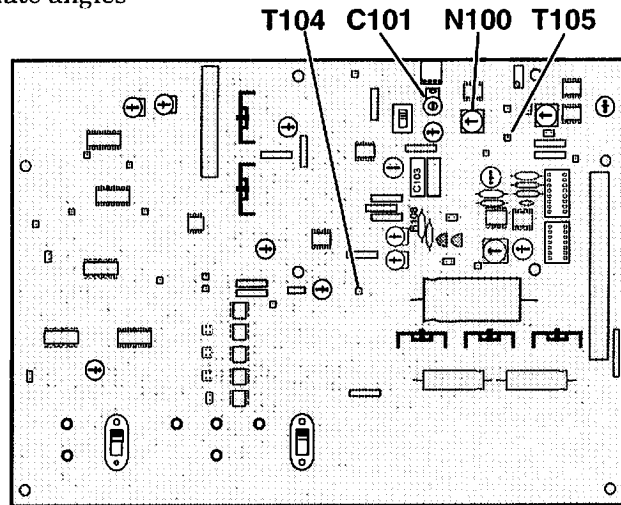
1. Disconnect loads.
2. Connect a 10 kHz continuous triangle wave signal to the input as shown on the right and adjust it for 10 volt peak to peak, but below clip level.



3. Connect a scope (+) probe to T104 and the ground lead to T105.
4. Adjust N100 to eliminate angles on the wave form.

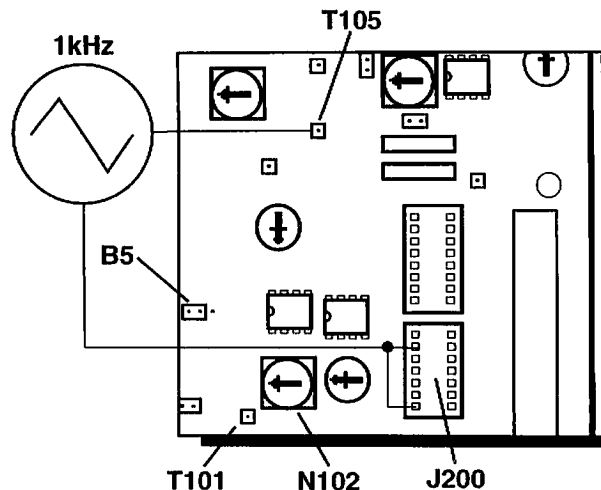
**Note:** Use a non-metallic screwdriver for the following adjustment.

5. Adjust C101 to make the wave form into a straight line.
6. Repeat 4 and 5 until there is minimum interaction.



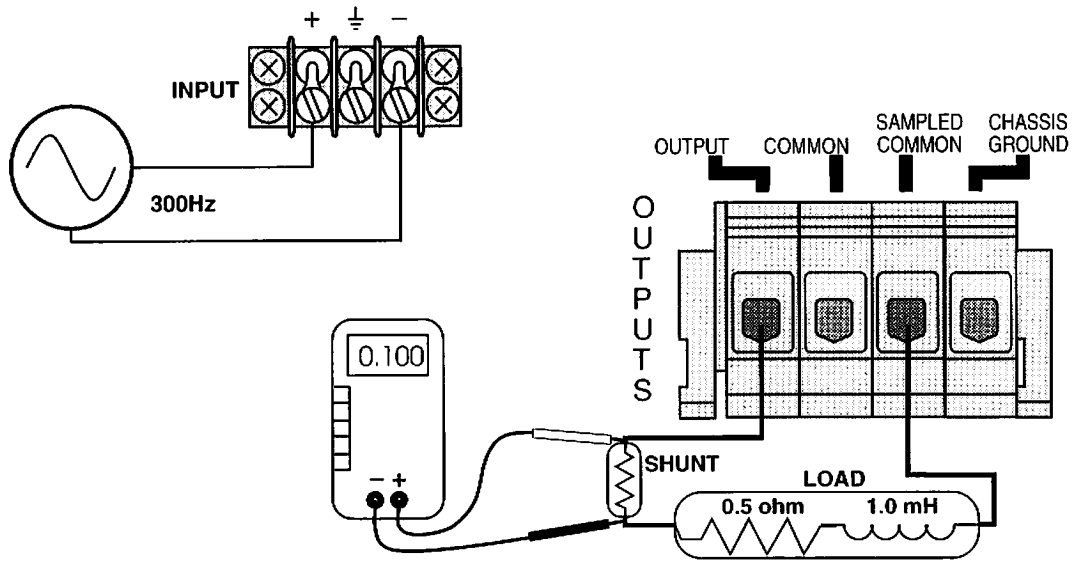
## 7.10 Adjust CMRR on Current Amp

1. Remove loads and input signal.
2. Connect signal generator to pins 2 and 7 of J200 with the ground to T105. Adjust for 1kHz continuous triangle 10 volt output.
3. Connect scope probe to T101 and ground lead to T105.
4. Adjust N102 to make wave into a straight line.
5. Set S501 down to STANDBY.

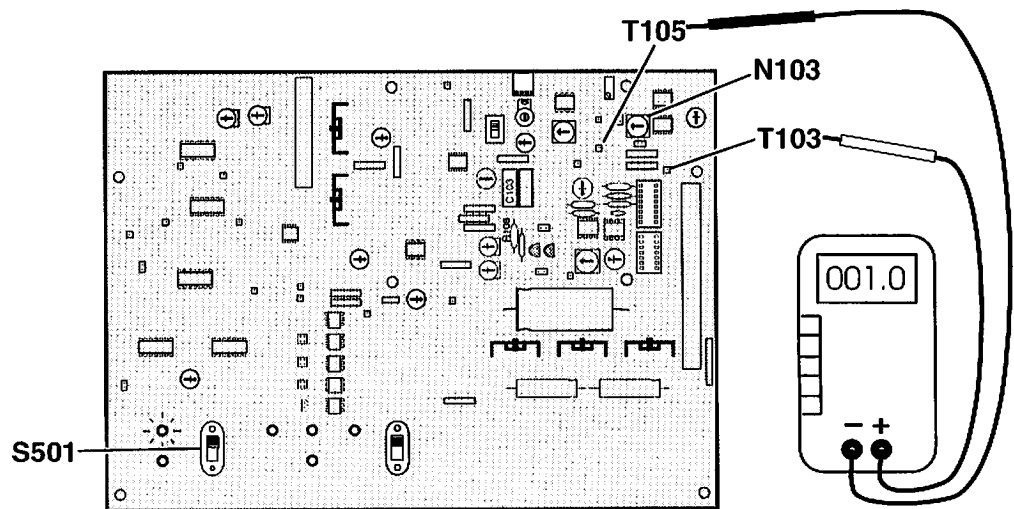


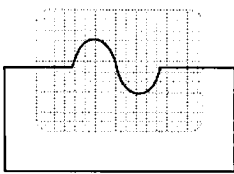
## 7.11 Adjust Current Monitor

1. Connect a 300 Hz continuous sinewave from a generator to the input.
2. Connect a 0.5 ohm, 1.0 mH load and shunt (typical value .005 ohm) to the amplifier output.
3. Connect voltmeter leads across shunt.
4. Set switch S501 to READY, with power on.
5. Adjust input signal for 100 mV.



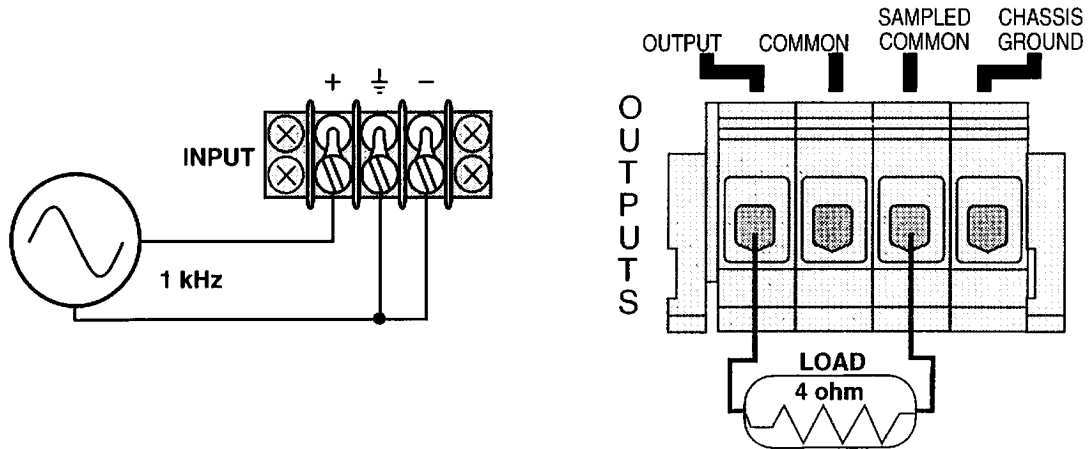
6. Connect voltmeter positive lead to T103, and negative lead to T105.
7. Adjust N103 for 1V.
8. Set switch S501 down to STANDBY.



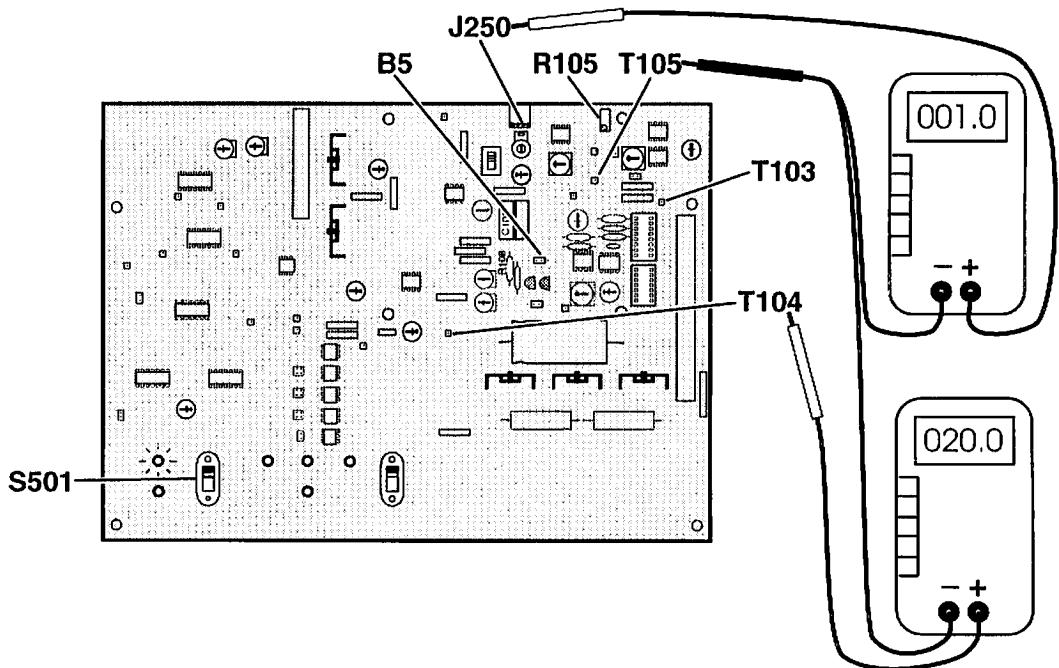


## 7.12 Adjust Voltage Gain

1. Connect a 1 kHz continuous sinewave from a generator to an unbalanced input (see illustration below).
2. Connect a 4 ohm, 2kW load to amplifier output terminal block.

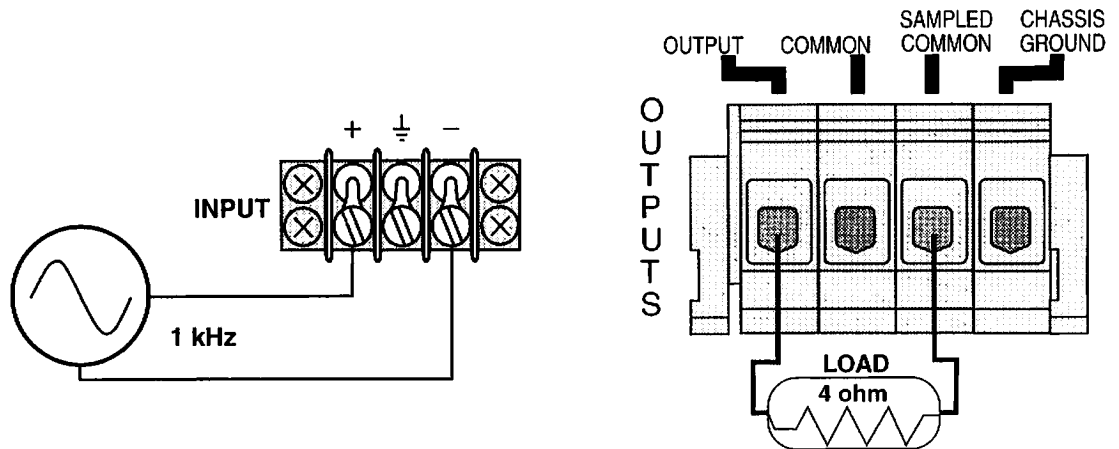


3. Jumper B5 still on left two pins.
4. Connect voltmeter positive lead to J250, pin 3; negative lead to T105.
5. Set switch S501 up to READY.
6. Adjust input signal for 1.0 volt at J250 pin 3.
7. Move positive probe to T104.
8. Adjust R105 until the meter displays 20 volts.



## 7.13 Adjust Dynamic Balance

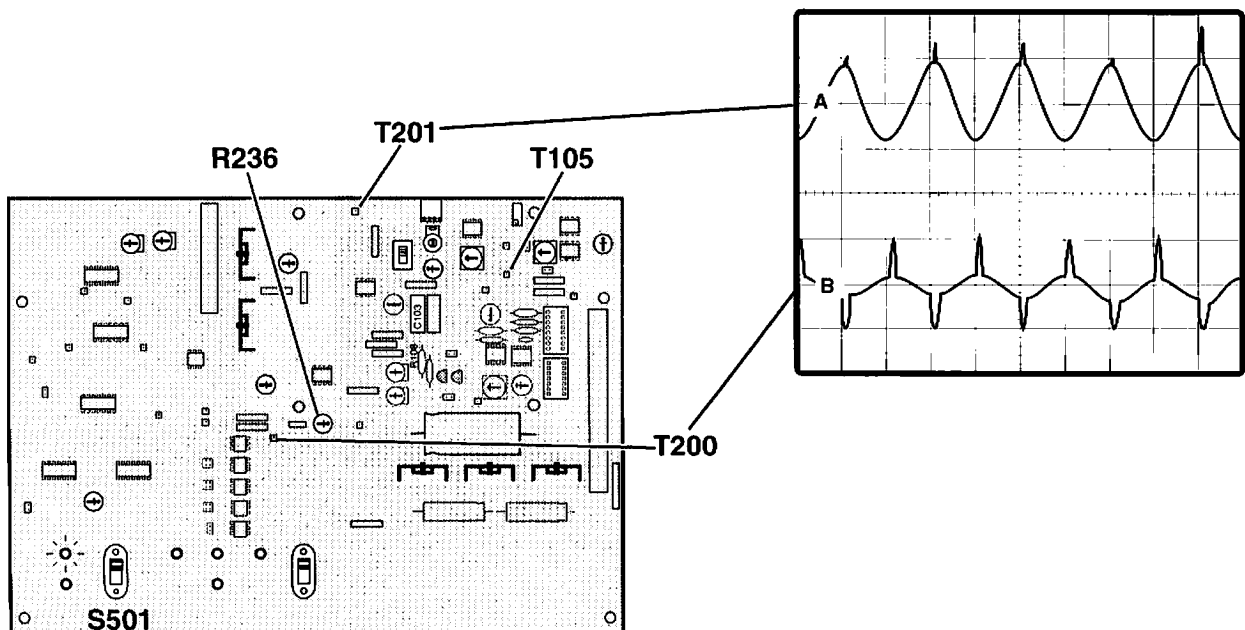
1. Connect a 1 kHz continuous sinewave from a generator to the input.
2. Connect a 4 ohm, 2kW load to amplifier output terminal block.

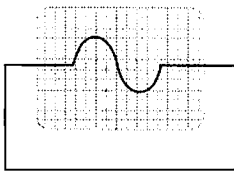


3. Connect channel 1 of a dual trace scope to T201. Set scope to 5 volts/division.
4. Connect channel 2 to T200. Set scope at 5 volts/division.
5. Connect scope ground to T105
6. Set switch S501 up to READY.
7. Increase input signal until channel 1 resembles wave form "A".
8. Adjust R236 until channel 2 resembles wave form "B".

**Note:** Proper adjustment is so that the low side of the amplifier (T200) clips just slightly before the high side (T201).

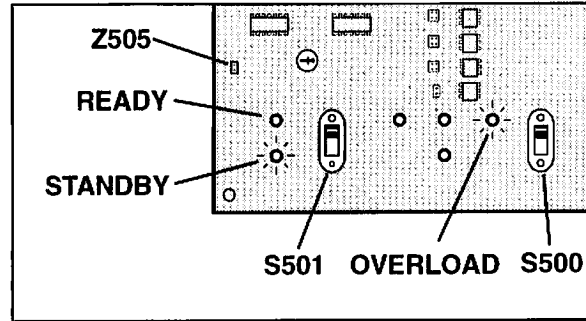
9. Set S501 down to STANDBY.





## 7.14 Verify Overload Latch

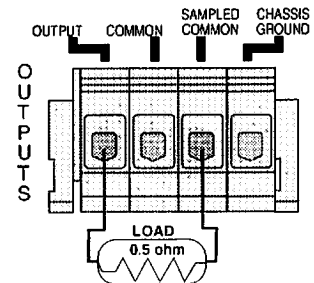
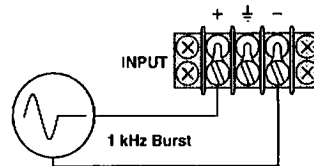
1. Connect a 1 kHz continuous sinewave from a generator to the input.
2. Short pins of Z505 together.
3. Set switch S501 up to READY.
4. Increase the input until the OVERLOAD LED comes on. The amplifier should go into STANDBY.



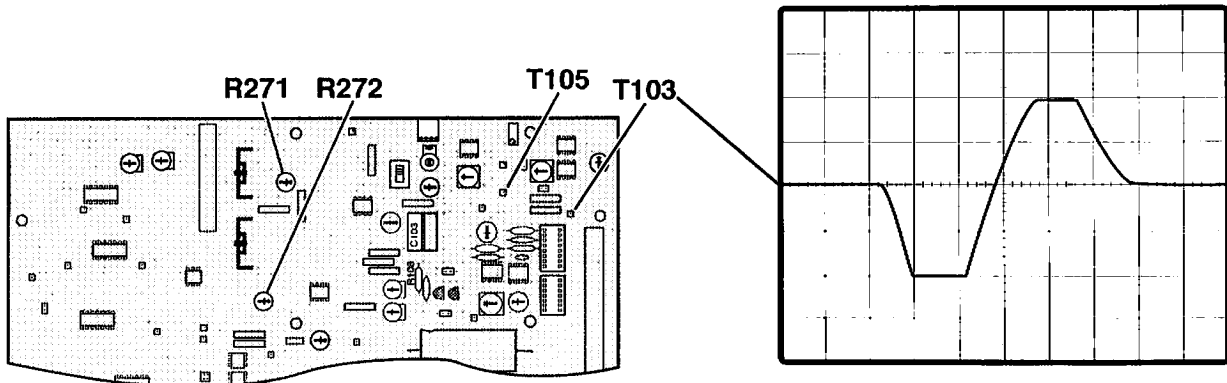
5. Push S500 down to RESET. Observe that the amplifier returns to READY.
6. Set S501 down to STANDBY.
7. Remove the short at Z505.

## 7.15 Adjust Current Limit

1. Connect a 1 kHz sine wave burst, less than 5% duty cycle, to the input.
2. Connect a 0.5  $\Omega$  (or less) load to the output terminals.



3. Connect scope probe to T103 with ground lead to T105.
4. Increase the input signal until the amplifier is in current limit and the wave form on the scope resembles the one below.
5. Adjust R271 to bring the positive peak to be between +9V & +10V Peak.
6. Adjust R272 to bring the negative peak to be between -9V & -10V Peak.

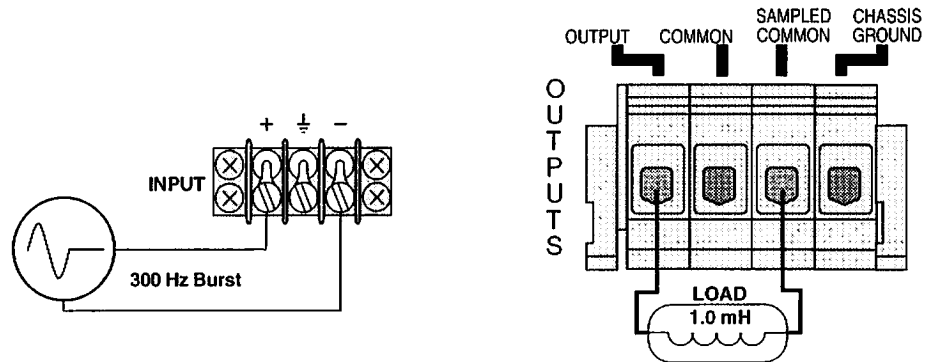




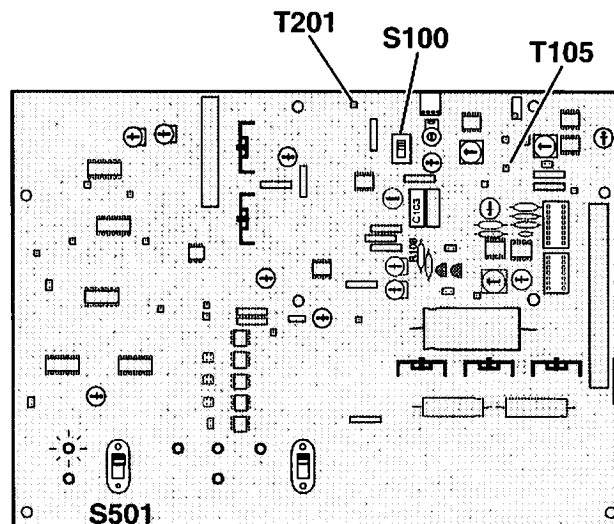
## 7.16 Spurious Response

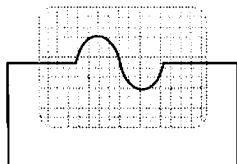
This procedure verifies the stability of the amplifier. If oscillations are observed while performing these tests, capacitors and resistors marked “selectable” on the Output Stages Schematic may need to be changed.

1. Connect signal generator to amplifier input. Adjust for 300Hz, 20% duty cycle tone burst.
2. Connect a 1.0 mH load to the amplifier output terminals.



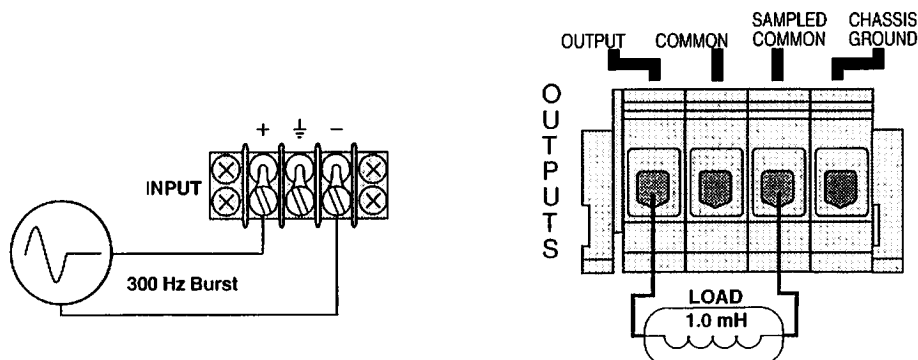
3. Connect scope probe to T201; ground lead to T105.
4. Set switch S100 up (MASTER).
5. Set switch S501 up to READY.
6. Gradually increase input signal until distortion is seen at T201.
7. Look for oscillations.
8. Adjust the input level and frequency to 50Hz and watch for oscillations.
9. Set switch S501 down to STANDBY.





## 7.17 Verify Controlled Current Mode

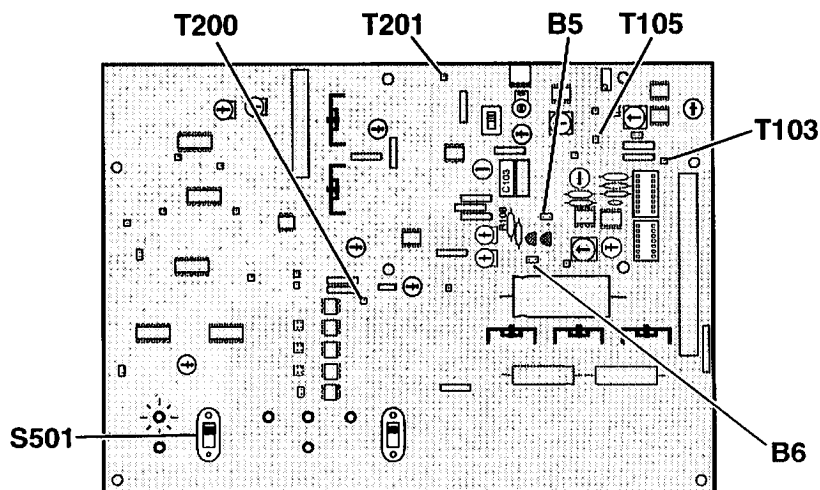
1. Connect signal generator to amplifier input. Adjust for 300Hz, 20% duty cycle tone burst.
2. Connect a 1.0 mH load to the amplifier output terminals.



3. Jumper B5 to the right two pins.
4. Connect scope probes to T200 and T201, ground leads at T105.
5. Set S501 up to READY.
6. Increase input signal level until wave forms distort. Observe for oscillations and spikes.
7. Adjust generator for 100Hz square wave with level at 0.5 V or below.
8. Connect scope probe to T103. The wave form should be clean and square without overshoot.
9. Set S501 down to STANDBY.
10. Connect a .25mH load to the output of the amplifier.
11. Jumper B6 to the left two pins.

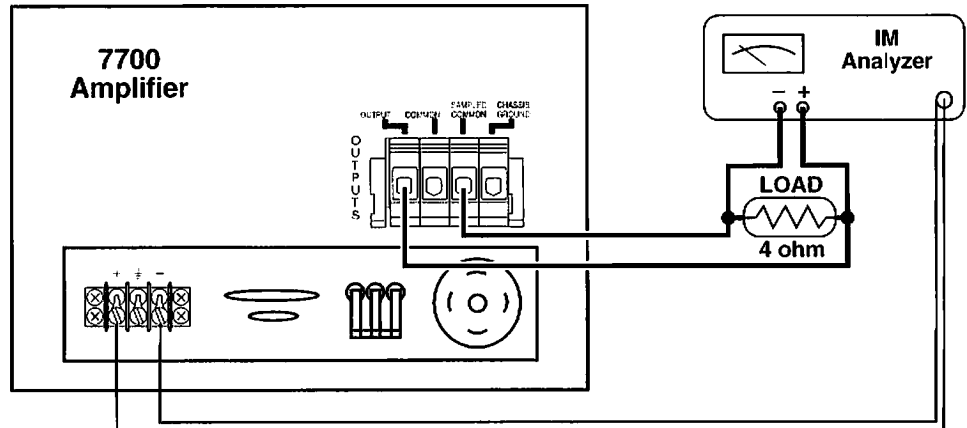
**Note:** The load and compensation network values are for a standard factory unit, otherwise, use your custom values.

12. Set S501 up to READY.
13. The wave form at T103 should be clean and square without overshoot.
14. Set S501 down to standby.
15. Jumper B5 to the left two pins.
16. Jumper B6 to the right two pins.



## 7.18 Measure IMD

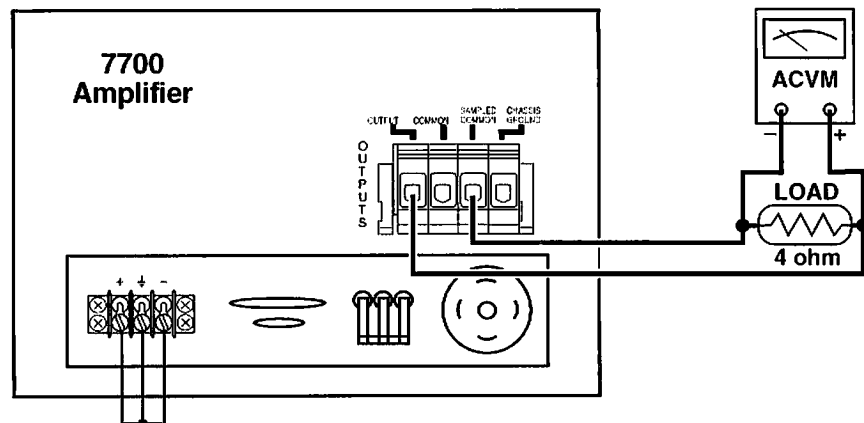
1. Use the distortion test setup shown in your IM analyzer manual.
2. Calibrate the distortion analyzer and set the IM analyzer output signal for 60 Hz and 7 kHz, 4/1 ratio.
3. Connect a 4 ohm load to the output of the amplifier.



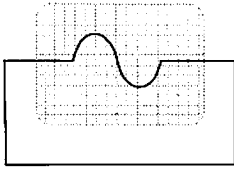
4. Set S501 up to READY.
5. Measure the IM distortion at 5 dB intervals from 1550 watts output down to 35 dB below 1550 watts.
6. Maximum distortion allowed is .03% IMD.
7. Set S501 down to STANDBY.

## 7.19 Measure Output Voltage Noise

1. Short the input.
2. Connect a 4 ohm load to output.
3. Connect AC voltmeter to rear output terminals: positive to positive output; negative lead of voltmeter to sampled common terminal.



4. Set S501 up to READY.
5. Typical value is 0.4 mV. Acceptable range is 0.2 mV to 0.8 mV. (Bandwidth of 20 Hz to 20 kHz).
6. Set S501 down to STANDBY.



## 7.20 Measure Current Monitor Noise

1. Short all the terminals of the input connector block.
2. Connect a 4 ohm load to the output.
3. Connect voltmeter positive lead to T103, and negative lead to T105.
4. Typical value is .02 mV. Acceptable range is .01 mV to .04 mV (Bandwidth of 20 Hz to 20 kHz).

## 7.21 Verify Fault Circuit Operation

1. Short all the terminals of the input connector block.
2. Remove all loads.
3. Set switch S501 up to READY.



### WARNING

A *Burn Hazard* exists if a resistor smaller than 5 watts is used in the next step. Do not leave the resistor in place longer than necessary.

4. Connect a 560  $\Omega$ , 5 W resistor, with leads bent as needed, to heat sink of PNP well #2 (A), and to collector mounting screw of PNP predriver (B).
5. The amplifier should instantly enter **STANDBY** with **FAULT LED** on.
6. Remove the resistor and turn the amplifier power **OFF** and back **ON**.
7. Repeat steps 4, 5, and 6, but instead, test PNP well #3, points C and D.
8. Again, the amplifier should enter **STANDBY** with **FAULT LED** on.
9. After fault has been cleared, set switch S501 down to **STANDBY**.

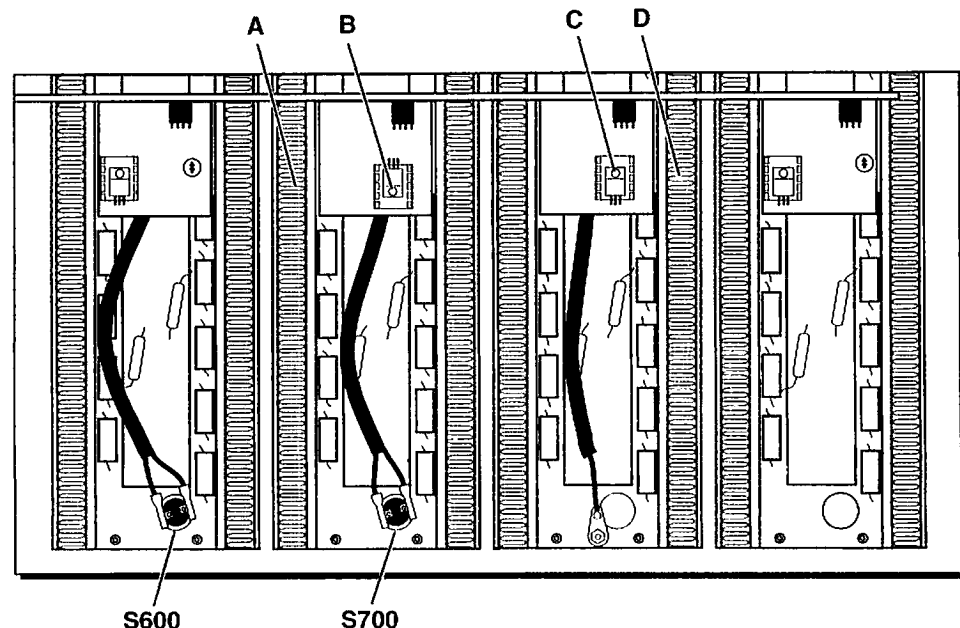


Illustration 7-4 Output Heat Sink Wells Top View

## 7.22 Verify Thermal Switch Operation

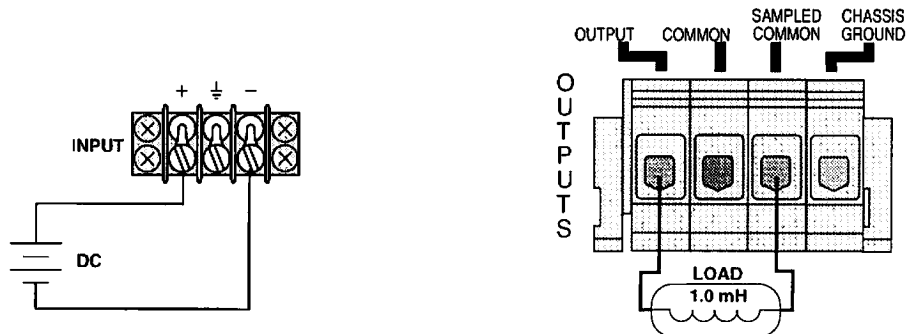
**!** **DANGER**

Potentially **lethal** *ELECTRIC SHOCK* can occur if you make accidental contact with Heat sinks under full power. Do not touch more than one heat sink at a time.

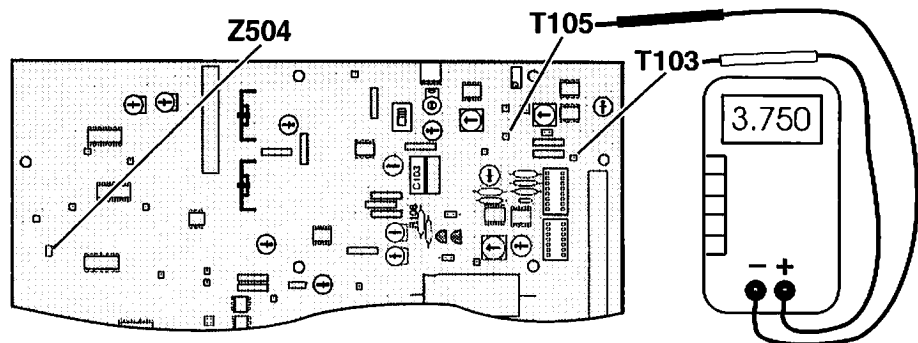
1. Remove all loads and input signals.
2. Set switch S501 up to READY.
3. Disconnect front thermal switch S600 (see Illustration 7-4).
4. Observe the LEDs—STANDBY, and OVERTEMP LEDs should light.
5. Reconnect S600. LEDs should go out after pressing RESET (S500).
6. Repeat steps 1-5 to test S700.
7. Set switch S501 down to STANDBY.

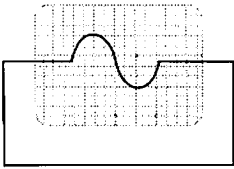
## 7.23 Verify Die Thermal Protection

1. Connect a 2.5 volts DC input to J2, and a 1.0 mH load to the output.



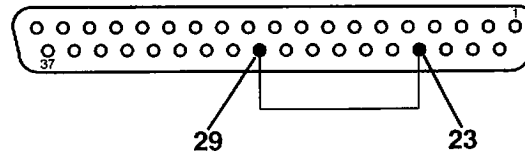
2. Connect a DC voltmeter, or scope, (+) to T103, and (-) to T105.
3. Set switch S501 up to READY.
4. The voltage should cycle from 3.75 to 0 volts over a period of 1 minute.
5. Set switch S501 down to STANDBY.
6. Reverse the polarity of the DC input and repeat steps 3-5.
7. Short the pins of Z504.
8. Enable amplifier and see it go into standby when it reaches OVERTEMP.
9. Set switch S501 down to STANDBY.
10. Reverse the polarity of the DC input and repeat steps 8 and 9.





## 7.24 Verify Interlock

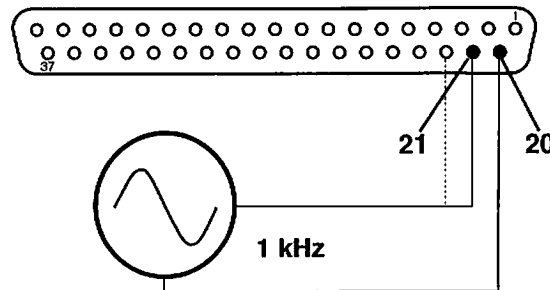
1. Set switch S501 to READY.
2. Connect a shorting wire to J3 pin 23 and J3 pin 29. (Locate this connector on the back panel.)



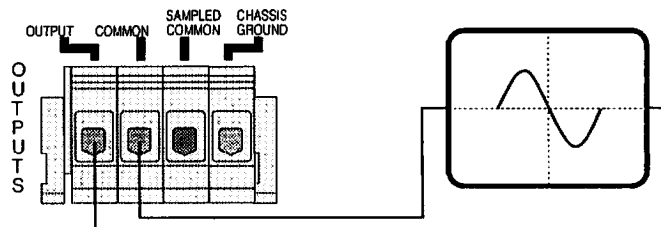
3. Amplifier should go into STANDBY.
4. Remove shorting wire.
5. STANDBY lights should go out.
6. Set switch S501 down to STANDBY.

## 7.25 Check MASTER/SLAVE Mode

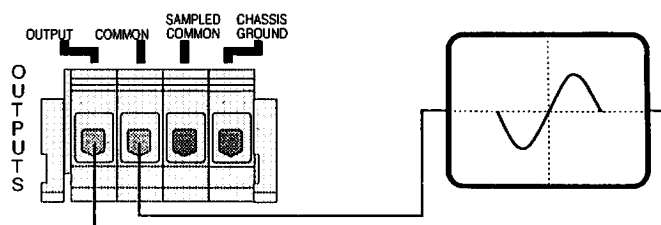
1. Set MASTER/SLAVE switch S100 to SLAVE mode.
2. Connect a 1kHz signal to J3 pin 21 with ground to pin 20.



3. Set switch S501 up to READY.
4. The output wave form should be equal in amplitude to the input signal.

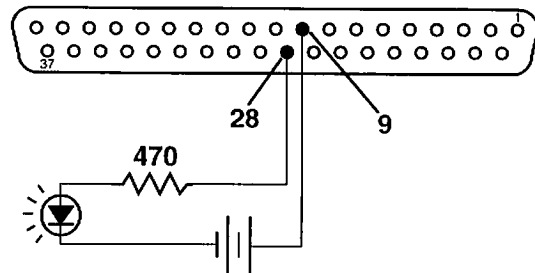


5. Move input to J3 pin 22.
6. Observe an inverted output wave form, otherwise, unchanged.
7. Set switch S501 down to STANDBY.



## 7.26 Verify Remote Ready Status

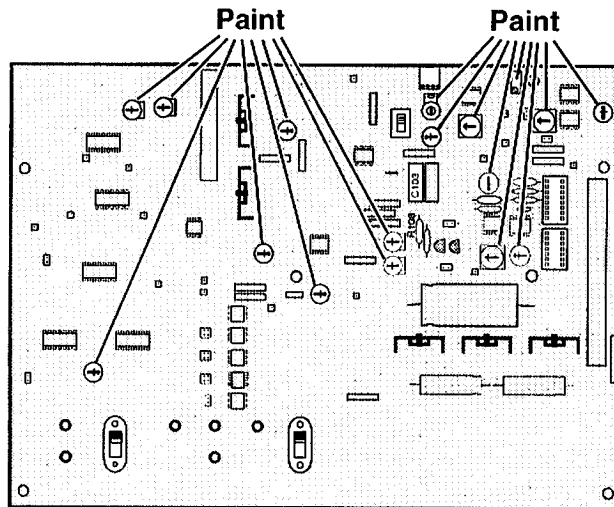
1. Connect a resistor, an LED and a battery in series to J3-9 and J3-28.
2. Set switch S501 up to READY.
3. The LED in the test circuit should come on.



4. Set switch S501 down to STANDBY.
5. The LED in the test circuit should go off.

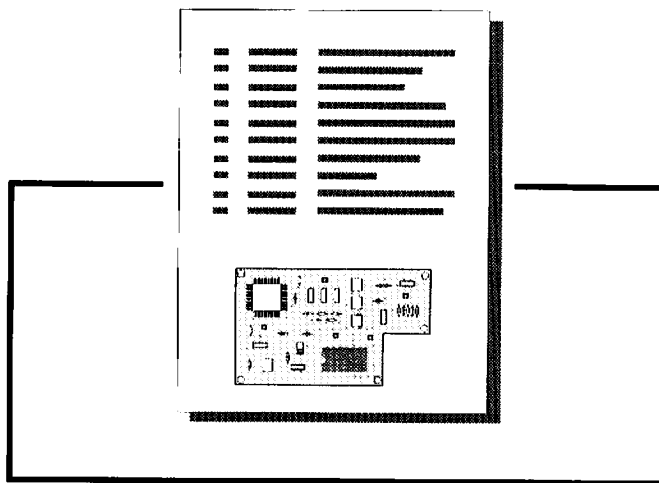
## 7.27 Final Procedure

1. Use standard enamel paint to seal all adjustment points to guard against vibration or accidental movement.
2. Set appropriate switches for master or slave operation.
3. Install jumpers where desired.
4. Replace all covers and front panel.



### CAUTION

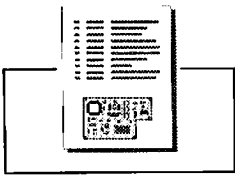
Do not leave the amplifier in Current Mode unintentionally (B5 right). Damage to amplifier loads could occur during turn-on.



## ***Section 8—Parts and Schematics***

This section provides a complete graphic summary of parts used in a 7700 Series amplifier including board layouts and exploded views to aid in service procedures.





---

## **8.1 General Parts Information**

This section includes illustrations, schematics, and parts lists for the 7700 Power Supply Amplifiers. This information should be used with the service, repair and adjustment procedures in Sections 5, 6 and 7.

Mechanical and structural parts are illustrated and indexed on exploded view drawings. Electrical and electronic parts are listed and indexed in both the exploded view drawings and the schematic parts lists.

## **8.2 Standard and Special Parts**

Many electrical and electronic parts used in a 7700 amplifier are standard items stocked by and available from electronic supply houses. However, some electronic parts that appear to be standard are actually special. Order parts from TECHRON to be sure of a workable replacement. Structural items, covers and panels are available only from TECHRON.

## **8.3 Ordering Parts**

TECHRON, a division of Crown International, supplies parts through the Crown International Parts Department. Replacement parts are obtained from the following address:

**Crown International  
Parts Department  
P.O. Box 1000  
Elkhart, Indiana 46515**

**Phone: (219) 294-8210**

**FAX: (219) 294-8301**

When ordering parts, be sure to give the model and serial number and include the part description and Crown Part Number (CPN) from the parts list. Price quotes are available upon request.

---

## **8.4 Shipment**

See Section 5.13 *Packing and Shipping Instructions* to prepare the amplifier for shipment. Shipment will be made by UPS or best method unless a preferred method is specified. Shipments are made F.O.B. Elkhart, Indiana, only.

Shipments to Techron should be made as described below:

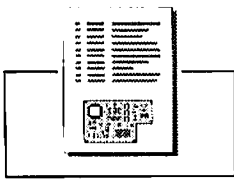
<p style="text-align: center;"><b>Techron Customer Service Department 57620 C.R. 105 Elkhart, Indiana 46517</b></p>
---

## **8.5 Terms**

Normal terms are C.O.D., Master Card, or Visa, unless the order is prepaid. If prepaying, please add an amount for the freight charge. Established accounts will have large orders shipped freight prepaid and billed net 30 days. All others, shipped freight collect.

Parts prices are subject to change without notice. New parts returned for credit are subject to a 10% restocking charge.

You must receive authorization from the Crown Parts Department before returning parts for credit. Please state reason for returning.

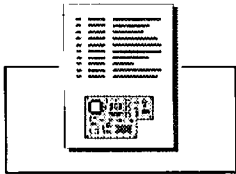


---

## 8.6 Chassis Exploded View

<u>ITEM #</u>	<u>PART #</u>	<u>DESCRIPTION</u>
1	C 7377-2	.68UF 250V RFI CAP
2	D 7227J7	Panel, Left side
3	D 8063-6	Relay, Solid State (low noise)
4	C 2226-6	8-32 X .375 Slotted Round Head Screw
5	A10290-3	Handle, Left
6	A10161-3	5/16-18 X 7/8 Hex Cap Screw
7	A10296-4	Handwell, tan
8	A11139-G4	Panel, 7700 Front
9	A10234-2	Bezel, Plastic tan
10	A10089-70806	8-32X.375 Pan Head Phillips Machine Screw
11	A10173-2	8/32 U Clip
12	A10101-5	.5 X .136 X .02 Nylon Washer
13	-----	Main board
14	D 6146-1	Insulator, 11 X7.5X.031
15	A10954-G5	Skin, subfront
16	F10869K6	Panel, Subfront
17	B 5564-8	.1875 X .1875 Continuous Grommet
18	A10192-1	.500 Snap Bushing
19	D 4137-2	Nylon Thumbscrew Washer
20	A10096-3	.312 Split Ring Lockwasher
21	M20677J6	Bracket, Top Right
22	A10094-4	#6 Internal Star Washer
23	A10290-4	Handle, Right
24	F10762J6	Cover, Bottom
25	A10089-70806	8-32X.375 Pan Head Phillips Machine Screw
26	M20676J8	Bracket, Top Left
27	A10086-10608	6-32 X .50 Rd Hd Phillips Machine Screw
28	A10102-16	5/16-18 Hex Nut
29	A10095-2	#8 External Star Lockwasher
30	A10091-11008	10-32 X .5 Flat Head Phillips Machine Screw
31	D 7228J5	Panel, Right Side
32	A10087-11008	10-32 X .50 Truss Head Machine Screw
33	A10094-8	#10 Internal Star Lockwasher
34	M20339-4	Bracket, Bottom Side
35	C 3776-9	Fuse block (208/240 Vac)
	C 7956-3	Fuse block (380/416 Vac)
36	A10285-11	Fuse, 3AG, 1 Amp Slow blow (208/240 Vac)
	A10285-9	Fuse, 0.5 Amp (380/415 Vac)

<b><u>ITEM #</u></b>	<b><u>PART #</u></b>	<b><u>DESCRIPTION</u></b>
37	C 7060-4 C 7028-1 C 7143-8	3-Phase Twist-Lock Conn., Female (208 Vac) 3-Phase Twist-Lock Conn., Female (240 Vac) 3-Phase Twt-Lk Conn., Female (380/415 Vac)
38	A10086-10604	6-32 X .25 Rd Hd Phillips Machine Screw
39	C 9368-9	Bridge Rectifier, 35 Amp
40	A10086-10814	8-32 X .87 Rd Hd Phillips Machine Screw
41	A10224-7	Grommet 2.0 OD x 1.5 ID
42	A10092-10610	6-32 X .625 Socket cap Machine Screw
43	C 7858-1	Fan, 4.7" Ball Bearing
44	C 5297-4	8-32 X .37 #7 Truss Head Phillips Screw
45	C 7898-7	#8 Ring Terminal
46	F10761J8	Panel, Side Fan
47	F12262-6	Slide, Fan Panel
48	D 6309-5	6-32 X .235 Hex Head Trilobe Screw
49	C 6596-8	Fan Cover
50	D 5459A7	Filter, Fan
51	F10639J6	Mesh, Fan Filter
52	A10086-70606	6-32 X .375 Round Head Phillips
53	A10095-2	#8 External Star Lockwasher
54	M20794J9	Panel, Back connector
55	D 2934-4	Solder Lug, .218 Hole
56	C 7408-5 C 7641-1	Breaker, 3 Pole, 20 amp (208/240 Vac) Breaker, 3 pole, 10 amp (380/415 Vac)
57	C 6011-8	Panel Mount BNC Connector (optional)
57	C 6877-2	Panel Mount Twinax Connector (optional)
58	A10086-70604	6-32 X .25 Round Head Machine Screw
59	C 7074-5	Mounting Kit, .312 THD
60	C 6549-7 C 7030-7 C 7142-0	3-Phase twist-lock connector, Male (208 Vac) 3-Phase twist-lock connector, Male (240 Vac) 3-Phase twist-lock conn., Male (380/415 Vac)
61	C 3842-9	3 terminal barrier block
62	F11729J4	Cover, Output
63	M21321J0	Panel, Back
64	C 8497-7	10-24X.625 Truss Head Phillips
65	A10102-5	6 X 32 Hex Nut



---

<b><u>ITEM #</u></b>	<b><u>PART #</u></b>	<b><u>DESCRIPTION</u></b>
66	F11735J1	Cover, Top
67	-----	Output Shelf Assembly
68	-----	Power Supply Assembly
69	A10102-6	8 X 32 Hex Nut
70	-----	Fan Terminator Assembly
71	S 5723-2	Tape, Foam 1/8 X 1/2 X 19

## 8.8 Heat Sink Shelf

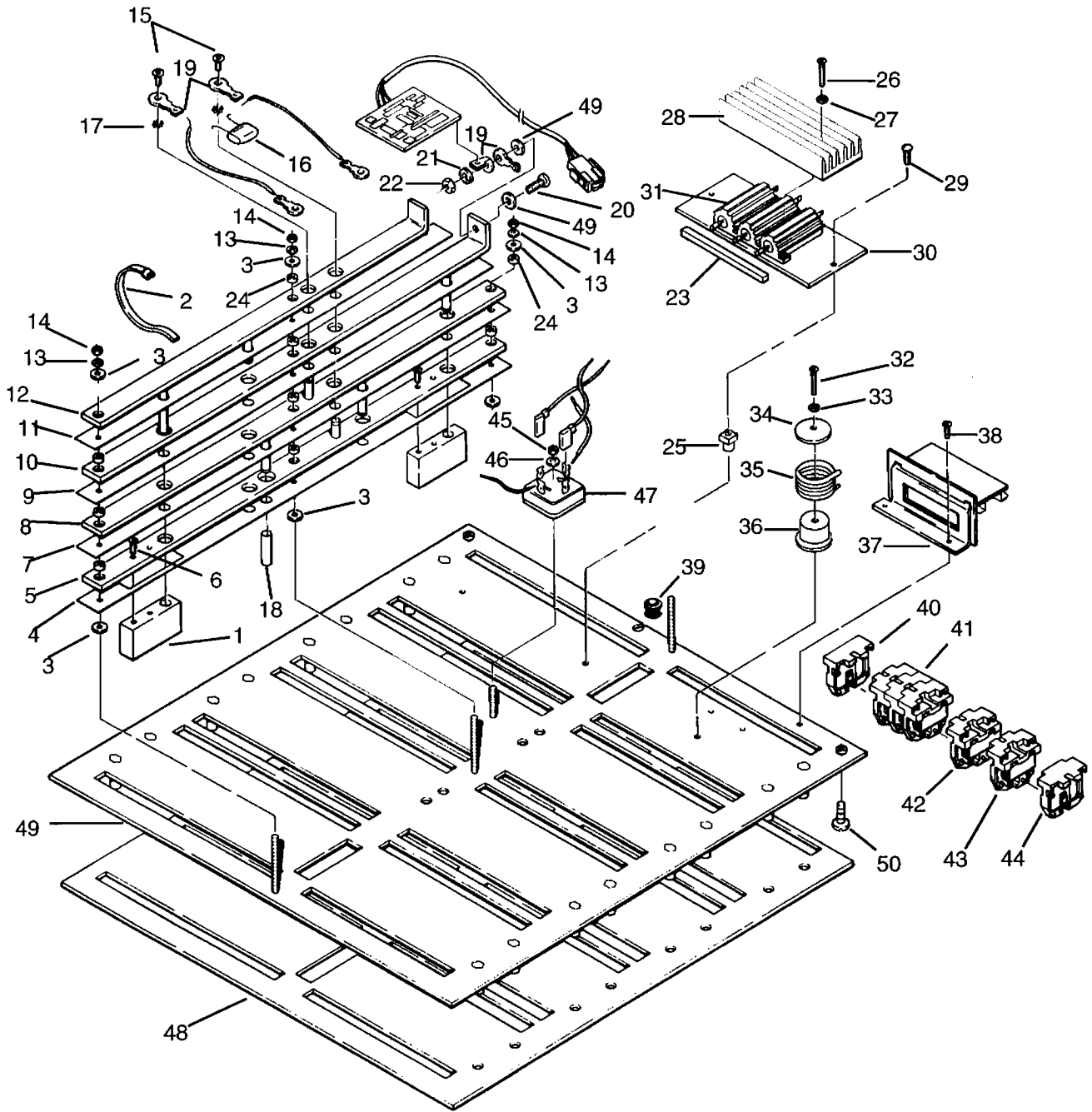
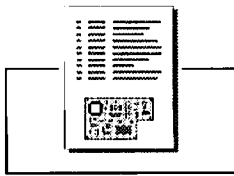


Illustration 8-3 Heat Sink Shelf Exploded View



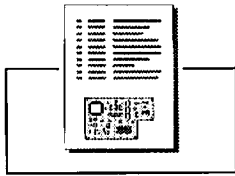
---

<b><u>ITEM #</u></b>	<b><u>PART #</u></b>	<b><u>DESCRIPTION</u></b>
1	F10526-6	Block, +VCC
2	C 1811-6	4" Cable Tie
	C 1812-4	2" Cable Tie
3	A10101-19	500OD X 195ID Fiber Washer
4	D 6159-4	Insulator, +VCC
5	M20401-2	Bus Bar, +VCC
6	C 7965-4	8-32X.37 Undercut Flat Head Screw
7	D 6162-8	Insulator, -VCC Bus Bar
8	M20402-0	Bus Bar, ISA -VCC WELD
9	D 6161-0	Insulator, Output Common
10	M20531-6	Bus Bar, Output Common
11	D 6160-2	Insulator, Output
12	M20532-4	Bus Bar, Output
13	A10094-4	#6 Internal Star Washer ZINC
14	A10102-5	6 X 32 Hex Nut
15	A10087-10806	8-32 X .37 Truss Head Phillips Screw
16	D 4289-1	0.47UF 200V 2.5 Polycarb Cap
17	A10095-2	#8 External Star Lockwasher
18	B 4782-7	.250 Shrink Tube
19	D 2934-4	Solder Lug .218 Hole
20	A10086-10810	8-32 X .62 Round Head Phillips Screw
21	A10094-6	#8 Internal Star Lockwasher
22	A10102-6	8 X 32 Hex Nut
23	F10527-4	Bus Bar, current sense
24	A10101-8	141 X 250 X 125 Nylon Spacer
25	C 2544-2	8 X.25 expansion nut
26	A10086-10414	4-40 X .87 Rd Head PHillips Machine Screw
27	A10094-2	#4 Internal Star Lockwasher
28	F10532J3	Heatsink, Current Sense
29	A10111-10810	8 X .62 Pan Head Phillips Self-Tapping Screw
30	M21395-5	Heat Sink Assembly, with Resistors
31	C 6299-9	0.1 Ohm 50 Watt Wire Wound Resistor
32	C 6977-0	6-32 X 1.5 Round Head Phillips Brass Screw
33	A10094-5	#6 Internal Star Washer
34	D 6418-4	Washer, Plastic .125
35	F10912-8	Coil, Output

---

<b><u>ITEM #</u></b>	<b><u>PART #</u></b>	<b><u>DESCRIPTION</u></b>
36	F10899-7	Coil Mount
37	M20751J9	Bracket, Output Connector
38	A10111-10810	8 X .62 Pan Head Phillips Self Tapping Screw
32	A10094-3	#6 Internal Star Washer
39	A10224-3	Grommet
40	C 7867-2	Terminal Block, End Section
41	C 7866-4	Terminal Block, 2-6 AWG
42	C 9432-3	Terminal Block, 22-10 AWG Grey
43	C 9433-1	Terminal Block, 22-10 AWG Green
44	C 7865-6	Terminal Block, End Stop
45	A10102-8	10/32 Hex nut
46	A10094-8	#10 Internal Star Lockwasher
47	C 9368-9	Bridge Rectifier
49	M20918-5	Shelf
48	D 7541-2	Insulator, Nomex
49	A10099-9	Shoulder Washer .25ID X.5 HD .375L
50	A10086-11008	10-32 X .50 Rd Head Phillips Machine Screw

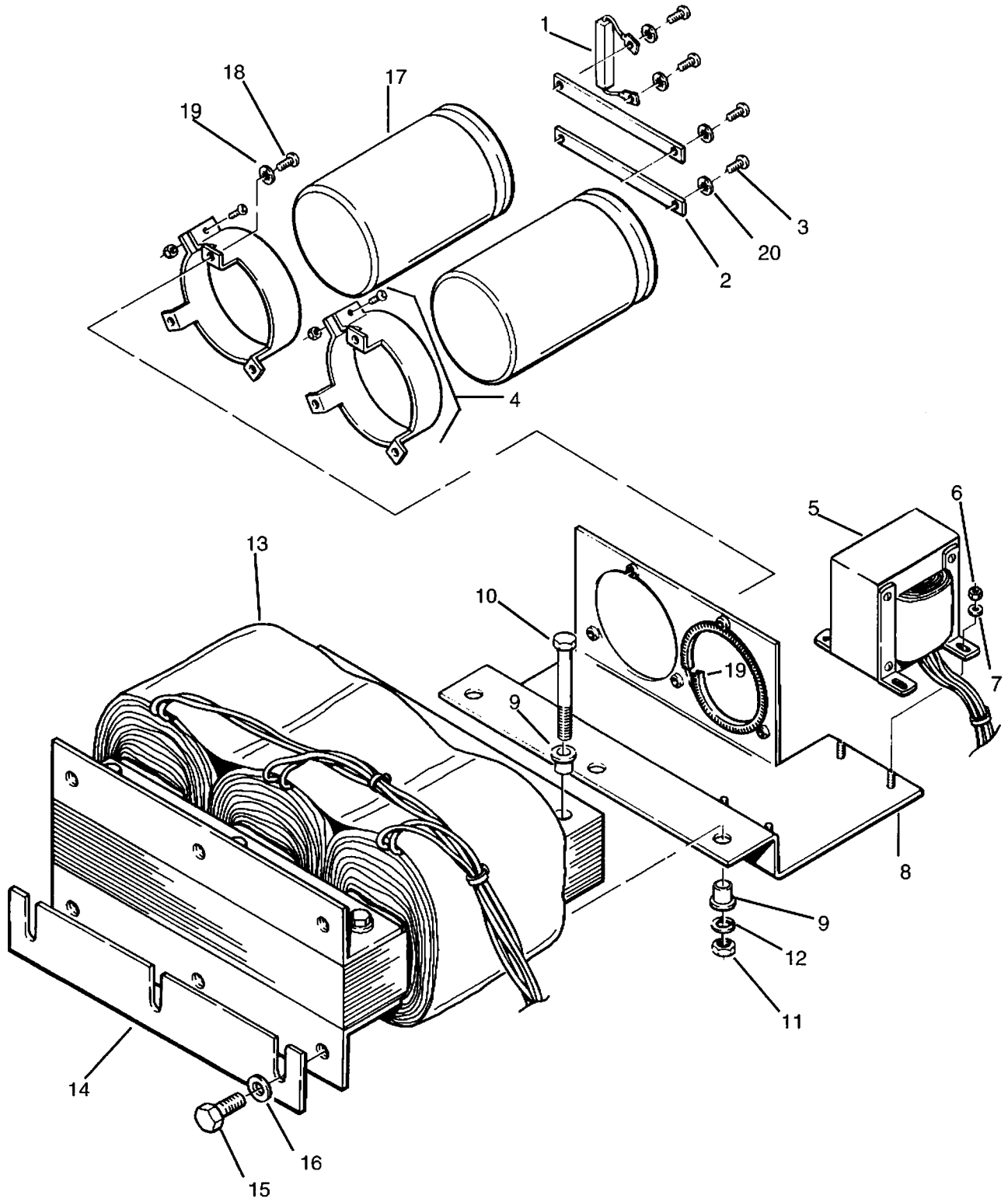




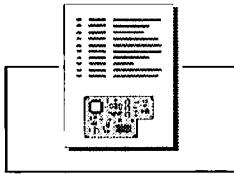
---

## 8.9 Power Supply

<b><u>ITEM #</u></b>	<b><u>PART #</u></b>	<b><u>DESCRIPTION</u></b>
1	C 6598-4	5.0 KOHM 10W Wire Wound
2	F10795-7	Bus Bar, Filter Cap
3	A10087-11008	10-32 X .50 Truss Head Machine Screw
4	C 6477-1	Bracket, Cap Mounting
5	D 6951-4	Transformer, 208/240 Control
	A 11448-G1	Transformer, 380/415 Control
6	A10102-5	6 X 32 Hex Nut
7	A10094-4	#6 Internal Star Washer
8	M20441A6	Bracket, Transformer and Capacitor
9	A10099-9	Shoulder Washer .25IDX.5HD .375L
10	A10161-1	1/4-20X3.25 Hex Head Cap Screw
11	A10096-2	.25 Split Ring Lockwasher
12	A10102-10	1/4-20 Hex Nut
13	D 6807-8	Transformer, 7700 208/240 Transformer, 7790CE 380/415
14	F11019-1	Shim, Transformer
15	A10161-2	5/16-18 X 7/8 Hex Cap Screw
16	A10102-16	5/16-18 Hex Nut
17	D 6091-9	5000UF 200VDC Electrolytic Capacitor
18	A10087-10804	8-32 X .25 Truss Head Machine Screw
19	A10094-6	#8 Internal Star Washer
20	A10094-8	#10 Internal Star Washer



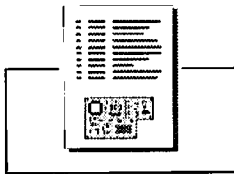
**Illustration 8-5 Power Supply Exploded View**



## 8.10 Schematic Parts List

<u>LOCATION #</u>	<u>PART #</u>	<u>DESCRIPTION</u>
B1	C 7858-1	FAN, 4.7" BALL BEARING 4715-FS
B2	C 7858-1	FAN, 4.7" BALL BEARING 4715-FS
B3	C 7858-1	FAN, 4.7" BALL BEARING 4715-FS
B4	C 7858-1	FAN, 4.7" BALL BEARING 4715-FS
B800	C 6513-3	LOSSY BEAD
B801	C 6513-3	LOSSY BEAD
B900	C 6513-3	LOSSY BEAD
B901	C 6513-3	LOSSY BEAD
C90	A10434-223KD	.022UF 250VDC 10% MET POLY T/R
C91	A10434-473JD	.047UF 250VDC 5% MET POLY T/R
C92	A10434-473JD	.047UF 250VDC 5% MET POLY T/R
C100	C 3410-5	100PF 500V 5% MICA
C101	C 5058-0	30PF PC MNT TRIMMER CAP
C102	C 8897-8	.1UF 100V 20% Z5U RAD CER T/R
C103	D 4292-5	.0587UF 200V 2.5% CARB
C104	D 4290-9	0.234UF 200V 2.5% CARB
C105	C 3409-7	47PF 500V 5% MICA
C106	C 8897-8	.1UF 100V 20% Z5U RAD CER T/R
C107	C 9030-5	0.068UF 400V 10% FILM
C108	C 9030-5	0.068UF 400V 10% FILM
C109	C 8897-8	.1UF 100V 20% Z5U RAD CER T/R
C110	C 3290-1	120PF 500V 5% MICA
C200	C 3410-5	100PF 500V 5% MICA
C201	C 8897-8	.1UF 100V 20% Z5U RAD CER T/R
C202	C 6227-0	20PF 500V 5% MICA
C203	C 8897-8	.1UF 100V 20% Z5U RAD CER T/R
C204	C 3409-7	47PF 500V 5% MICA
C205	OPEN	OPEN
C206	C 8548-7	.0039UF 200V 10% POLYESTER
C207	C 8897-8	.1UF 100V 20% Z5U RAD CER T/R
C208	OPEN	OPEN
C209	OPEN	OPEN
C210	C 8897-8	.1UF 100V 20% Z5U RAD CER T/R
C211	C 2342-1	27PF 500V 5% MICA
C212	C 2342-1	27PF 500V 5% MICA
C213	C 8897-8	.1UF 100V 20% Z5U RAD CER T/R
C214	C 2820-6	5.0PF 500V +/-5PF MICA
C215	D 4448-3	56PF 160V 2.5% STYR
C216	C 3409-7	47PF 500V 5% MICA
C217	OPEN	OPEN
C218	C 8897-8	.1UF 100V 20% Z5U RAD CER T/R

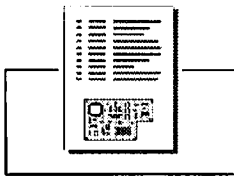
<b><u>LOCATION #</u></b>	<b><u>PART #</u></b>	<b><u>DESCRIPTION</u></b>
C219	OPEN	OPEN
C220	OPEN	OPEN
C221	C 2342-1	27PF 500V 5% MICA
C222	C 3411-3	200PF 500V 5% MICA
C223	C 1751-4	0.01UF 500V .3" LEADS DISC
C224	C 1751-4	0.01UF 500V .3" LEADS DISC
C225	C 2820-6	5.0PF 500V +/-5PF MICA
C226	C 3411-3	200PF 500V 5% MICA
C227	C 3411-3	200PF 500V 5% MICA
C300	C 8576-8	100UF 35V 10% ALUM ELECT T/A
C301	C 8897-8	.1UF 100V 20% Z5U RAD CER T/R
C302	C 5053-1	18UF, 50V, NP, VERTICAL
C303	C 8511-5	0.047UF, 250, 5%,FILM
C304	C 5084-6	1.5UF, 63V, 5%, FILM
C305	C 8897-8	.1UF 100V 20% Z5U RAD CER T/R
C306	C 5053-1	18UF, 50V, NP, VERTICAL
C307	C 8511-5	0.047UF, 250, 5%,FILM
C308	C 5084-6	1.5UF, 63V, 5%, FILM
C309	C 8576-8	100UF 35V 10% ALUM ELECT T/A
C400	D 6091-9	5000UF 200VDC ELECTROLYTIC
C401	C 9465-3	10UF 50V 20% VERT ELECT T/A
C402	C 6888-9	470UF 35V .4 X 1.2 CAPACITOR
C403	C 9465-3	10UF 50V 20% VERT ELECT T/A
C404	C 6888-9	470UF 35V .4 X 1.2 CAPACITOR
C405	C 8576-8	100UF 35V 10% ALUM ELECT T/A
C406	C 6674-3	3300UF 16V AXIAL CAP
C407	D 6091-9	5000UF 200VDC ELECTROLYTIC
C408	D 4289-1	0.47UF 200V 2.5 POLYCARB
C409	C 8426-6	.1UF 250V 10% MET POLY RADIAL
C410	C 8426-6	.1UF 250V 10% MET POLY RADIAL
C411	C 8426-6	.1UF 250V 10% MET POLY RADIAL
C412	C 8426-6	.1UF 250V 10% MET POLY RADIAL
C413	C 8426-6	.1UF 250V 10% MET POLY RADIAL
C414	C 8426-6	.1UF 250V 10% MET POLY RADIAL
C500	OPEN	OPEN
C501	C 1751-4	0.01UF 500V .3" LEADS DISC
C502	C 8897-8	.1UF 100V 20% Z5U RAD CER T/R
C503	C 7432-5	.01UF 250V 5% MET POLY CAP
C504	C 6096-9	3.3UF 50V LOW LEAK T/A



---

<b><u>LOCATION #</u></b>	<b><u>PART #</u></b>	<b><u>DESCRIPTION</u></b>
C505	C 8897-8	.1UF 100V 20% Z5U RAD CER T/R
C506	C 1751-4	0.01UF 500V .3" LEADS DISC
C507	OPEN	OPEN
C600	C 8511-5	0.047UF 250V 5% FILM
C650	C 8550-3	.0082UF 100V 10% POLYESTER
C651	C 5825-2	470PF 500V 5% MICA
C652	C 8545-3	.001UF 200V 10% POLYESTER
C653	C 3410-5	100PF 500V 5% MICA
C654	C 8545-3	.001UF 200V 10% POLYESTER
C655	Open	Open
C700	C 8511-5	0.047UF 250V 5% FILM
C750	C 8546-1	.0022UF 100V 10% POLYESTER
C751	C 5825-2	470PF 500V 5% MICA
C752	C 3410-5	100PF 500V 5% MICA
C753	C 8547-9	.0027UF 200V 10% POLYESTER
C754	C 1751-4	0.01UF 500V .3" LEADS DISC
C800	C 8512-3	0.022UF 250V 5% FILM
C850	C 8545-3	.001UF 200V 10% POLYESTER
C851	C 3411-3	200PF 500V 5% MICA
C852	C 8545-3	.001UF 200V 10% POLYESTER
C853	C 5825-2	470PF 500V 5% MICA
C900	C 8512-3	0.022UF 250V 5% FILM
C950	C 8545-3	.001UF 200V 10% POLYESTER
C952	C 1751-4	0.01UF 500V .3" LEADS DISC
C953	C 5825-2	470PF 500V 5% MICA
C954	C 3411-3	200PF 500V 5% MICA \
CB1	C 7408-5 C 7641-1	BREAKER, 3 POLE, 20 AMP (208/240 V) BREAKER, 3 POLE, 10 AMP (380/415 V)
D100	C 3181-2	DIODE, 1N4148 T/R
D101	C 3181-2	DIODE, 1N4148 T/R
D102	C 5900-3	DIODE, 1N960B ZENER 9.1V T/R
D103	C 2851-2	RECTIFIER, 1N4004 SILICON T/R
D104	C 2851-1	RECTIFIER, 1N4004 SILICON T/R
D200	C 3181-2	DIODE, 1N4148 T/R
D201	C 3181-2	DIODE, 1N4148 T/R
D202	C 3181-2	DIODE, 1N4148 T/R
D203	C 3181-2	DIODE, 1N4148 T/R
D204	C 3181-2	DIODE, 1N4148 T/R

<b><u>LOCATION #</u></b>	<b><u>PART #</u></b>	<b><u>DESCRIPTION</u></b>
D205	C 3181-2	DIODE, 1N4148 T/R
D206	C 3181-2	DIODE, 1N4148 T/R
D207	C 3181-2	DIODE, 1N4148 T/R
D300	C 3181-2	DIODE, 1N4148 T/R
D302	C 3181-2	DIODE, 1N4148 T/R
D303	C 3181-2	DIODE, 1N4148 T/R
D304	C 3181-2	DIODE, 1N4148 T/R
D305	C 3181-2	DIODE, 1N4148 T/R
D400	C 2851-1	RECTIFIER, 1N4004 SILICON T/R
D401	C 2851-1	RECTIFIER, 1N4004 SILICON T/R
D402	C 2851-1	RECTIFIER, 1N4004 SILICON T/R
D403	C 2851-1	RECTIFIER, 1N4004 SILICON T/R
D404	C 2851-1	RECTIFIER, 1N4004 SILICON T/R
D405	C 2851-1	RECTIFIER, 1N4004 SILICON T/R
D406	C 2851-1	RECTIFIER, 1N4004 SILICON T/R
D407	C 2851-1	RECTIFIER, 1N4004 SILICON T/R
D408	C 2851-1	RECTIFIER, 1N4004 SILICON T/R
D409	C 2851-1	RECTIFIER, 1N4004 SILICON T/R
D410	C 2851-1	RECTIFIER, 1N4004 SILICON T/R
D411	C 9368-9	BRIDGE RECT, 35A 200V EDI ONLY
D412	C 9368-9	BRIDGE RECT, 35A 200V EDI ONLY
D413	C 9368-9	BRIDGE RECT, 35A 200V EDI ONLY
D500	C 3181-2	DIODE, 1N4148 T/R
D501	C 3181-2	DIODE, 1N4148 T/R
D502	C 3181-2	DIODE, 1N4148 T/R
D503	C 3181-2	DIODE, 1N4148 T/R
D504	C 3181-2	DIODE, 1N4148 T/R
D505	C 3181-2	DIODE, 1N4148 T/R
D506	C 3181-2	DIODE, 1N4148 T/R
D507	C 3181-2	DIODE, 1N4148 T/R
D508	C 3181-2	DIODE, 1N4148 T/R
D600	C 3181-2	DIODE, 1N4148 T/R      0000
D601	C 3181-2	DIODE, 1N4148 T/R      0000
D607	C 9368-9	BRIDGE RECT, 35A 200V EDI ONLY
D650	C 2851-1	RECTIFIER, 1N4004 SILICON T/R
D750	C 2851-1	RECTIFIER, 1N4004 SILICON T/R
D751	C 2851-1	RECTIFIER, 1N4004 SILICON T/R
D800	C 3181-2	DIODE, 1N4148 T/R
D801	C 3181-2	DIODE, 1N4148 T/R
D850	C 2851-1	RECTIFIER, 1N4004 SILICON T/R
D950	C 2851-1	RECTIFIER, 1N4004 SILICON T/R

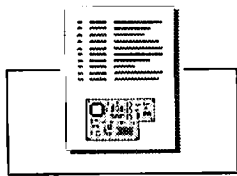


---

<b><u>LOCATION #</u></b>	<b><u>PART #</u></b>	<b><u>DESCRIPTION</u></b>
E500	C 4342-9	LED, AMBER, GI #MV5153
E501	C 4342-9	LED, AMBER, GI #MV5153
E502	C 4342-9	LED, AMBER, GI #MV5153
E503	C 7863-1	LED, T 1.75 GREEN TLHG6405
E504	C 4431-0	LED, T 1.75 YELLOW
E505	C 4341-1	LED, T 1.75, RED
F1	A10285-11 A10285-9	FUSE, 3AG, 1 AMP (208/240 VAC) FUSE, 0.5 AMP (380/415 VAC)
J2	C 3842-9	3 POS BARRIER BLOCK
J3	C 7124-8	37PIN D-SUB PC MT RECEP
J100	C 4508-5	IC SKT, 16PIN DIP 2-640358-3
J150	C 6851-7	5POS .1" CTR R ANGLE MTA HDR
J200	C 3450-1	IC SOCKET, 14PIN DIP
J250	OPEN	OPEN
J300	C 6884-8	40 POS VERT EJECT HEADER
J400	C 6463-1	STRAIT EJECT 26P HDR
J500	C 6481-3	8 PIN SGL ROW VERT TIN HDR
J600	C 6564-6	10P DBLROW UNSHRD HDR 87230-5
J700	C 6564-6	10P DBLROW UNSHRD HDR 87230-5
J800	C 6564-6	10P DBLROW UNSHRD HDR 87230-5
J900	C 6564-6	10P DBLROW UNSHRD HDR 87230-5
K1	D 8063-6	RELAY, SOLID STATE (LOW NOISE)
K2	D 8063-6	RELAY, SOLID STATE (LOW NOISE)
L1	D 6844-1	CHOKER, B-L COMMON MODE, FC1
L650	C 3510-2	CHOKER, 10% AXIAL 470 UH TR
L750	C 3510-2	CHOKER, 10% AXIAL 470 UH TR
L850	C 3510-2	CHOKER, 10% AXIAL 470 UH TR
L900	C 3510-2	CHOKER, 10% AXIAL 470 UH TR
N100	D 4669-4	D-75 BAL INPUT RES TRIM
N101	D 6234-5	RESISTOR NETWORK #20
N102	D 6213-9	RESISTOR/TRIMER NETWORK #4
N103	D 6214-7	RES TRMR NET #3 SERIES 380
N300	D 4922-7	RESISTOR NETWORK #16 SIP
N301	D 4922-7	RESISTOR NETWORK #16 SIP
N302	D 4920-1	RESISTOR NETWORK #14 SIP

<b><u>LOCATION #</u></b>	<b><u>PART #</u></b>	<b><u>DESCRIPTION</u></b>
Q100	C 5135-6	2N5770 NPN
Q101	C 5135-6	2N5770 NPN
Q200	C 3625-8	2N4125 30V PNP T/R
Q201	C 3625-8	2N4125 30V PNP T/R
Q202	C 6911-9	UPA75HA/UPA77HA DUAL XSISTOR
Q203	C 3578-9	MPSA93 200V PNP T/R
Q204	C 3810-6	MPSA42 300V NPN T/R
Q205	C 6910-1	UPA74HA/UPA76HA NPN XSISTOR
Q206	C 3954-2	MPSA56 80V PNP T/R
Q207	C 3528-4	MPSA06 80V NPN T/R
Q209	C 3528-4	MPSA06 80V NPN T/R
Q210	C 3625-8	2N4125 30V PNP T/R
Q211	C 3625-8	2N4125 30V PNP T/R
Q212	C 5453A1	2SA1006BR TO-220 PNP
Q213	D 2962-5	MPSA18 45V NPN T/R
Q214	C 3786-8	MPS4250A 40V PNP T/R
Q215	C 6436-7	2SC2336BR TO-220 NPN
Q216	C 3954-2	MPSA56 80V PNP T/R
Q300	C 6911-9	UPA75HA/UPA77HA DUAL XSISTOR
Q301	C 6910-1	UPA74HA/UPA76HA NPN XSISTOR
Q302	D 2961-7	SPS8010 60V NPN T/R
Q303	C 3625-8	2N4125 30V PNP T/R
Q304	C 3625-8	2N4125 30V PNP T/R
Q305	D 2961-7	SPS8010 60V NPN T/R
Q306	C 3625-8	2N4125 30V PNP T/R
Q500	C 6049-8	J310 25V N-CHANNEL T/R
Q501	D 2961-7	SPS8010 60V NPN T/R
Q600-609	C 7614-8	MOTOROLA DUAL DIE 200V NPN
Q610	D 8274-10	XSISTOR, NPN DRIVER #2
Q611	D 8274-9	XSISTOR, NPN DRIVER #2
Q612-622	C 7614-9	MOTOROLA DUAL DIE 200V NPN
Q650	C 6436-7	2SC2336BR TO-220 NPN
Q651	C 3625-8	2N4125 30V PNP T/R
Q652	D 2961-7	SPS8010 60V NPN T/R
Q700-Q709	C 7614-8	MOTOROLA DUAL DIE 200V NPN
Q712-Q721	C 7614-8	MOTOROLA DUAL DIE 200V NPN
Q750	C 5453A1	2SA1006BR TO-220 PNP
Q800-Q809	C 7614-8	MOTOROLA DUAL DIE 200V NPN
Q812-Q821	C 7614-9	MOTOROLA DUAL DIE 200V NPN
Q850	C 6436-7	2SC2336BR TO-220 NPN
Q851	C 3625-8	2N4125 30V PNP T/R
Q852	D 2961-7	SPS8010 60V NPN T/R

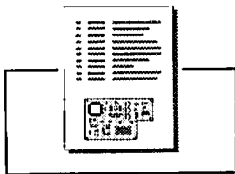




---

<u>LOCATION #</u>	<u>PART #</u>	<u>DESCRIPTION</u>
Q900-Q910	C 7614-8	MOTOROLA DUAL DIE 200V NPN
Q912-Q921	C 7614-9	MOTOROLA DUAL DIE 200V NPN
Q950	C 5453A1	2SA1006BR TO-220 PNP
R90	C 7102-4	4.7 OHM 140VPTH POSISTOR MURA
R91	C 6625-5	5.6 OHM 5W 5% METAL OXIDE
R92	C 6625-5	5.6 OHM 5W 5% METAL OXIDE
R100	A10265-18231	182.KOHM .25W 1% MF T/R
R101	A10265-10221	10.2KOHM .25W 1 MF T/R
R102	A10265-1	10. KOHM .25W 1 MF T/R
R103	A10266-5	5.1 KOHM .25W 5 CF T/R
R104	A10265-1	10. KOHM .25W 1 MF T/R
R105	C 6886-3	10KOHM 20-TURN CERMET TRIMPOT
R106	A10266-2	2.4 KOHM .25W 5 CF T/R
R107	A10265-1	10. KOHM .25W 1 MF T/R
R108	A10266-2	270. KOHM .25W 5% CF25 T/R
R109	A10265-6	68.1KOHM .25W 1% MF T/R
R110	A10265-1	10. KOHM .25W 1 MF T/R
R111	A10266-2	20. KOHM .25W 5 CF T/R
R112	A10266-2	20. KOHM .25W 5 CF T/R
R113	A10266-9	910. OHM .25W 5 CF T/R
R114	C 3672-0	2KOHM HELIPOT TRIM
R115	A10266-1	1.5 KOHM .25W 5% CF T/R
R116	A10266-7	7.5 MOHM .25W 5 CF T/R
R117	C 4843-6	100KOHM CERMET TRIMPOT
R118	A10266-1	10.0 OHM .25W 5% CF T/R
R119	A10266-1	10.0 OHM .25W 5% CF T/R
R120	C 6878-0	47.MOHM .25 5% THICKFILM T/R
R121	C 4843-6	100KOHM CERMET TRIMPOT
R122	A10266-5	5.1 KOHM .25W 5 CF T/R
R123	A10265-1	10. KOHM .25W 1 MF T/R
R124	A10265-1	10. KOHM .25W 1 MF T/R
R125	A10265-4	49.9 OHM .25W 1 MF T/R
R126	A10266-1	1.0 KOHM .25W 5% CF T/R
R127	A10265-4	49.9 OHM .25W 1 MF T/R
R144	A10265-1	10. KOHM .25W 1 MF T/R
R145	A10266-5R62	5.6 OHM .5W 5 CF T/R
R146	A10266-5R61	5.6 OHM .25W 5% CF T/R
R200	C 6482-1	24.9 KOHM 1W .5% MF T/R
R201	A10265-1	1.27 KOHM .25W 1% MF T/R
R202	A10266-1	1.0 KOHM .25W 5% CF T/R
R203	C 6482-1	24.9 KOHM 1W .5% MF T/R
R204	C 5062-2	100KOHM LINEAR TRIMPOT

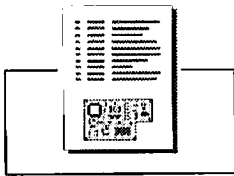
<b><u>LOCATION #</u></b>	<b><u>PART #</u></b>	<b><u>DESCRIPTION</u></b>
R205	A10266-2	2.2 MOHM .25W 5 CF T/R
R206	A10266-5	560. OHM .25W 5% T/R
R207	C 6399-7	1.38KOHM .25W .5% MF T/R
R208	C 6482-1	24.9 KOHM 1W .5% MF T/R
R209	A10266-2	200. OHM .25W 5 CF T/R
R210	A10266-2	200. OHM .25W 5 CF T/R
R211	A10265-2	232OHM .25W 1% MF T/R
R212	A10265-2	232OHM .25W 1% MF T/R
R213	A10265-2	2.49KOHM .25W 1 MF T/R
R214	A10265-4	4.99KOHM .25W 1 MF T/R
R215	A10265-4	4.99KOHM .25W 1 MF T/R
R216	A10266-1	1.0 KOHM .25W 5% CF T/R
R217	A10265-4	4.99KOHM .25W 1 MF T/R
R218	A10265-4	4.99KOHM .25W 1 MF T/R
R219	A10265-2	2.49KOHM .25W 1 MF T/R
R220	A10265-2	232OHM .25W 1% MF T/R
R221	A10265-2	232OHM .25W 1% MF T/R
R222	A10266-1	100. OHM .25W 5% CF T/R
R223	A10265-2	2.49KOHM .25W 1 MF T/R
R224	A10266-2	22.0 OHM .25W 5 CF T/R
R225	A10266-1	100. OHM .25W 5% CF T/R
R226	A10266-3	330. OHM .25W 5 CF T/R
R227	A10266-1	100. OHM .25W 5% CF T/R
R228	A10266-2	22.0 OHM .25W 5 CF T/R
R229	A10266-1	100. OHM .25W 5% CF T/R
R230	A10266-1	100. OHM .25W 5% CF T/R
R231	A10266-5	51.0 OHM .25W 5% CF T/R
R232	A10266-5	51.KOHM 2W 5% CF T/R
R233	A10266-5	51.KOHM 2W 5% CF T/R
R234	C 5062-2	100KOHM LINEAR TRIMPOT
R235	A10266-9	91. KOHM .25W 5 CF T/R
R236	C 3093-9	10KOHM HELITRIM CERMET TRIM
R237	A10266-1	1.0 KOHM .25W 5% CF T/R
R238	A10265-1	100. OHM .25W 1 MF T/R
R239	A10266-9	91.0 OHM .25W 5% CF T/R
R240	A10266-5	51.KOHM 2W 5% CF T/R
R241	A10266-5	560. OHM .25W 5% T/R
R242	A10265-2	2.49KOHM .25W 1 MF T/R
R243	A10266-1	18.0 OHM .25W 5% CF T/R
R244	A10266-1	18.0 OHM .25W 5% CF T/R
R245	A10266-1	100. OHM .25W 5% CF T/R
R246	A10266-1	1.5 KOHM .25W 5% CF T/R
R247	A10266-1	1.5 KOHM .25W 5% CF T/R
R248	A10266-6	6.2 KOHM .25W 5 CF T/R
R249	A10266-6	6.2 KOHM .25W 5 CF T/R



---

<u>LOCATION #</u>	<u>PART #</u>	<u>DESCRIPTION</u>
R250	A10266-3	3.9 KOHM .25W 5% CF T/R
R251	A10266-3	3.9 KOHM .25W 5% CF T/R
R252	A10266-3	33. KOHM .25W 5% CF T/R
R253	A10266-2	2.0 KOHM .25W 5 CF T/R
R254	C 6173-6	100 OHM CERMET TRIM
R255	A10266-3	33. KOHM 2W 5% CF T/R
R256	A10266-9	910. OHM .25W 5 CF T/R
R257	A10266-1	150. OHM .25W 5 CF T/R
R258	A10266-2	270. OHM .25W 5% CF T/R
R259	A10266-7	750. OHM .25W 5 CF T/R
R261	A10266-1	100. OHM .25W 5% CF T/R
R262	A10266-1	18.0 OHM .25W 5% CF T/R
R263	A10266-1	18.0 OHM .25W 5% CF T/R
R264	A10266-4	47. KOHM .25W 5% CF25 T/R
R265	C 6482-1	24.9 KOHM 1W .5% MF T/R
R266	A10266-2	2.4 KOHM .25W 5 CF T/R
R267	A10266-5	5.6 OHM .25W 5% CF T/R
R268	A10266-5	5.6 OHM .25W 5% CF T/R
R271	C 3683-7	200 OHM HELIPOT TRIM
R272	C 3683-7	200 OHM HELIPOT TRIM
R273	A10266-1	10.0 OHM .25W 5% CF T/R
R274	A10266-2	24 KOHM 2W 5% CF T/R
R275	A10266-2	24 KOHM 2W 5% CF T/R
R300	A10266-4	470. OHM .25W 5% CF T/R
R301	A10266-4	470. OHM .25W 5% CF T/R
R302	A10266-4	470. OHM .25W 5% CF T/R
R303	A10265-6	68.1KOHM .5W 1 MF T/R
R304	A10266-2	270. KOHM .25W 5% CF25 T/R
R305	C 5062-2	100KOHM LINEAR TRIMPOT
R306	A10265-1	100. OHM .25W 1 MF T/R
R307	A10265-1	10. KOHM .25W 1 MF T/R
R308	A10266-1	110. OHM .25W 5 CF T/R
R309	A10266-4	4.7 KOHM .25W 5% CF T/R
R310	A10266-4	470. KOHM .25W 5% CF T/R
R311	A10266-4	470. KOHM .25W 5% CF T/R
R312	A10266-5	5.6 KOHM .25W 5% CF T/R
R313	A10265-1	16.2 KOHM .25W 1 MF T/R
R321	A10265-1	100. OHM .25W 1 MF T/R
R322	A10265-6	68.1KOHM .5W 1 MF T/R
R323	A10265-1	100. OHM .25W 1 MF T/R
R324	A10265-1	10. KOHM .25W 1 MF T/R
R325	A10265-1	16.2 KOHM .25W 1 MF T/R

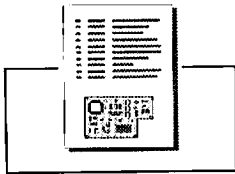
<b><u>LOCATION #</u></b>	<b><u>PART #</u></b>	<b><u>DESCRIPTION</u></b>
R326	A10266-1	110. OHM .25W 5 CF T/R
R327	A10266-5	5.6 KOHM .25W 5% CF T/R
R328	A10266-4	470. KOHM .25W 5% CF T/R
R329	A10266-1	10. KOHM .25W 5% CF T/R
R330	A10266-4	470. KOHM .25W 5% CF T/R
R331	A10266-4	4.7 KOHM .25W 5% CF T/R
R332	C 6406-0	8.15KOHM .25W 1% MF T/R
R333	A10266-2	270. KOHM .25W 5% CF25 T/R
R334	C 5062-2	100KOHM LINEAR TRIMPOT
R335	A10266-2	27. KOHM .25W 5 CF T/R
R336	A10266-4	470. OHM .25W 5% CF T/R
R337	A10266-4	470. OHM .25W 5% CF T/R
R338	A10266-4	470. OHM .25W 5% CF T/R
R346	A10266-2	27. KOHM .25W 5 CF T/R
R347	A10265-1	100. OHM .25W 1 MF T/R
R348	A10266-1	10. KOHM .25W 5% CF T/R
R400	C 6598-4	5.0 KOHM 10W WIREWOUND T/R
R500	A10266-1	10. KOHM .25W 5% CF T/R
R501	A10266-3	39. KOHM .25W 5% CF T/R
R502	A10266-1	10. KOHM .25W 5% CF T/R
R503	A10266-1	10. KOHM .25W 5% CF T/R
R504	A10266-2	220. KOHM .25W 5% CF T/R
R506	A10266-2	2.7 KOHM .25W 5 CF T/R
R507	A10266-4	470. OHM .25W 5% CF T/R
R508	A10266-2	2.2 MOHM .25W 5 CF T/R
R509	A10266-4	470. KOHM .25W 5% CF T/R
R510	A10266-1	100. KOHM .25W 5% CF25 T/R
R511	A10266-1	15. KOHM .25W 5% CF T/R
R512	A10266-1	100. KOHM .25W 5% CF25 T/R
R513	A10266-2	2.7 KOHM .25W 5 CF T/R
R514	A10266-2	20. KOHM .25W 5 CF T/R
R515	A10266-2	27. KOHM .25W 5 CF T/R
R516	C 3093-9	10KOHM HELITRIM CERMET TRIM
R517	A10266-5	51. KOHM .25W 5 CF25 T/R
R518	C 4661-2	15.0 MOHM.25W 5%THICK FILM T/R
R519	A10266-2	2.7 KOHM .25W 5 CF T/R
R520	A10266-1	1.0 KOHM .25W 5% CF T/R
R521	A10266-1	1.0 KOHM .25W 5% CF T/R
R522	A10266-2	2.7 KOHM .25W 5 CF T/R
R523	A10266-2	2.7 KOHM .25W 5 CF T/R
R524	A10266-1	1.8 MOHM .25W 5% CF T/R
R525	A10266-1	100. KOHM .25W 5% CF25 T/R



---

<u>LOCATION #</u>	<u>PART #</u>	<u>DESCRIPTION</u>
R526	A10266-2	240. KOHM .25W 5% CF T/R
R527	A10266-2	220. KOHM .25W 5% CF T/R
R528	A10266-1	100. OHM .25W 5% CF T/R
R529	A10266-1	15. KOHM .25W 5% CF T/R
R530	A10266-2	2.7 KOHM .25W 5 CF T/R
R531	A10266-1	150. KOHM .25W 5% CF T/R
R532	A10266-4	470. OHM .25W 5% CF T/R
R533	A10266-1	100. KOHM .25W 5% CF25 T/R
R534	A10266-2	200. KOHM .25W 5 CF T/R
R535	A10266-6	62. KOHM .25W 5% CF T/R
R536	A10266-3	39. KOHM .25W 5% CF T/R
R537	A10266-3	39. KOHM .25W 5% CF T/R
R538	A10266-6	62. KOHM .25W 5% CF T/R
R539	A10266-4	4.7 KOHM .25W 5% CF T/R
R540	A10266-1	15. KOHM .25W 5% CF T/R
R541	A10266-1	100. KOHM .25W 5% CF25 T/R
R542	A10266-1	100. KOHM .25W 5% CF25 T/R
R543	A10266-1	10. KOHM .25W 5% CF T/R
R600	C 6625-5	5.6 OHM 5W 5% METAL OXIDE
R601-R610	C 3583-9	0.33 OHM 5W 5% WIRE
R611	A10266-1204	12.0 OHM 2W 5% CF T/R
R612	A10266-1011	100. OHM .25W 5% CF T/R
R613	A10266-1012	100. OHM .25W 5% CF T/R
R614	A10266-1205	12.0 OHM 2W 5% CF T/R
R615-R624	C 3583-9	0.33 OHM 5W 5% WIRE
R625	A10266-1206	12.0 OHM 2W 5% CF T/R
R626	A10266-1207	12.0 OHM 2W 5% CF T/R
R650	A10266-4701	47.0 OHM .25W 5 CF T/R
R651	C 3672-0	2KOHM HELIPOT TRIM
R652	A10266-7511	750. OHM .25W 5 CF T/R
R653	A10266-1021	1.0 KOHM .25W 5% CF T/R
R654	A10266-2401	24.0 OHM .25W 5% CF T/R
R655	A10266-1001	10.0 OHM .25W 5% CF T/R
R656	Open	Open
R700	C 6625-5	5.6 OHM 5W 5% METAL OXIDE
R701-R710	C 3583-9	0.33 OHM 5W 5% WIRE
R711-R720	C 3583-9	0.33 OHM 5W 5% WIRE
R721	A10266-1206	12.0 OHM 2W 5% CF T/R
R722	A10266-1011	100. OHM .25W 5% CF T/R
R723	A10266-1012	100. OHM .25W 5% CF T/R
R724-R733	C 3583-9	0.33 OHM 5W 5% WIRE
R734	A10266-1204	12.0 OHM 2W 5% CF T/R
R735-R744	C 3583-9	0.33 OHM 5W 5% WIRE
R745	A10266-1207	12.0 OHM 2W 5% CF T/R

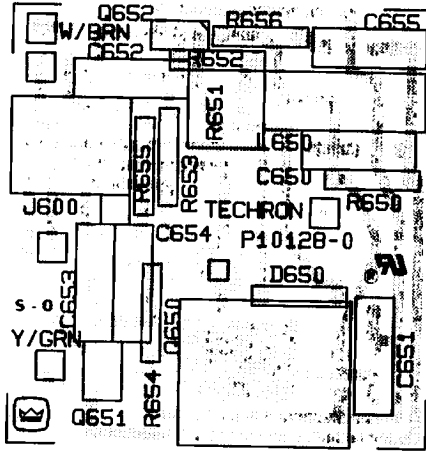
<u>LOCATION #</u>	<u>PART #</u>	<u>DESCRIPTION</u>
R746	A10266-1205	12.0 OHM 2W 5% CF T/R
R750	A10266-4701	47.0 OHM .25W 5 CF T/R
R751	A10266-5R61	5.6 OHM .25W 5% CF T/R
R752	A10266-3901	39.0 OHM .25W 5 CF T/R
R761	C 6299-9	0.1 OHM 50W 1% WIRE
R762	C 6299-9	0.1 OHM 50W 1% WIRE
R763	C 6299-9	0.1 OHM 50W 1% WIRE
R800	A10266-1208	12.0 OHM 2W 5% CF T/R
R801-R810	C 3583-9	0.33 OHM 5W 5% WIRE
R811	A10266-1205	12.0 OHM 2W 5% CF T/R
R812	C 5342-8	236. OHM .5W 1% MF (Blue dot U800)
	C 5343-6	227. OHM .5W 1% MF (Green dot U800)
	C 5344-4	218. OHM .5 W 1% MF (Yellow dot U800)
R813	A10266-1011	100. OHM .25W 5% CF T/R
R814	A10266-1011	100. OHM .25W 5% CF T/R
R815	A10266-1204	12.0 OHM 2W 5% CF T/R
R816	A10265-16221	16.2 KOHM .25W 1 MF T/R
R817-R827	C 3583-9	0.33 OHM 5W 5% WIRE
R828	A10266-1207	12.0 OHM 2W 5% CF T/R
R829	A10266-1206	12.0 OHM 2W 5% CF T/R
R833	A10265-16221	16.2 KOHM .25W 1 MF T/R
R850	A10266-2721	2.7 KOHM .25W 5 CF T/R
R851	A10266-4701	47.0 OHM .25W 5 CF T/R
R852	A10266-2721	2.7 KOHM .25W 5 CF T/R
R853	C 3672-0	2KOHM HELIPOT TRIM
R854	A10266-7511	750. OHM .25W 5 CF T/R
R855	A10266-1021	1.0 KOHM .25W 5% CF T/R
R856	A10266-2401	24.0 OHM .25W 5% CF T/R
R900	A10266-1204	12.0 OHM 2W 5% CF T/R
R901-R910	C 3583-9	0.33 OHM 5W 5% WIRE
R911-R920	C 3583-10	0.33 OHM 5W 5% WIRE
R922	A10266-1011	100. OHM .25W 5% CF T/R
R922	A10266-1204	12.0 OHM 2W 5% CF T/R
R923	C 5342-8	236. OHM .5W 1% MF T/R
R923	C 5343-6	227. OHM .5W 1% MF T/R
R923	C 5344-4	218. OHM .5W 1% MF T/R
R924	A10266-1011	100. OHM .25W 5% CF T/R
R924	A10266-1204	12.0 OHM 2W 5% CF T/R
R925-R934	C 3583-9	0.33 OHM 5W 5% WIRE
R9336-R945	C 3583-9	0.33 OHM 5W 5% WIRE
R950	A10266-2721	2.7 KOHM .25W 5 CF T/R
R951	A10266-1011	100. OHM .25W 5% CF T/R
R952	A10266-2721	2.7 KOHM .25W 5 CF T/R



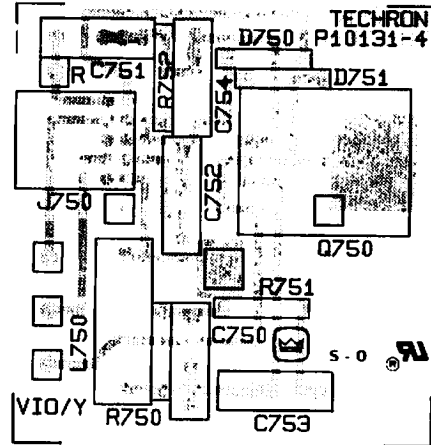
---

<u>LOCATION #</u>	<u>PART #</u>	<u>DESCRIPTION</u>
R953	A10266-3901	39.0 OHM .25W 5 CF T/R
R954	A10266-1204	12.0 OHM 2W 5% CF T/R
R955	A10266-1204	12.0 OHM 2W 5% CF T/R
S100	C 7363-2	DPDT GOLD CONTACT PC SLIDE SW
S500	D 6470-5	DPDT MOMENTARY SWITCH
S501	D 5016-7	DPDT 11/16 PC MOUNT SWITCH
S600	C 6737-8	SPSTNC THERMSW 150C 6/32 .5 ST
S700	C 6737-8	SPSTNC THERMSW 150C 6/32 .5 ST
T1	D 6807-8	TRANSFORMER, 7700 208/240
	D 6996-9	TRANSFORMER, 7790CE 380/415
T2	D 6951-4	TRANSFORMER, 208/240 CONTROL
	A 11448-G1	TRANSFORMER, 380/415 CONTROL
U100	C 5881-5	NE5532N DUAL OP AMP
U101	C 5881-5	NE5532N DUAL OP AMP
U102	C 5881-5	NE5532N DUAL OP AMP
U103	C 7075-2	0P27GP LOW NOISE PREC OP AMP
U104	C 7075-2	0P27GP LOW NOISE PREC OP AMP
U200	C 6421-9	TI TL011CLP CURRENT SOURCE
U201	C 6421-9	TI TL011CLP CURRENT SOURCE
U202	C 7621-3	LF357 OP AMP MOTOROLA
U203	C 7621-3	LF357 OP AMP MOTOROLA
U300	C 4696-8	TL074CN QUAD OP AMP
U301	C 4160-5	4741 QUAD OP AMP
U302	C 6411-0	H11C2 OPTO SCR
U400	C 5095-2	MC7815CT +15V. REG
U401	C 5096-0	MC7915CT -15V. REG
U402	C 5094-5	MC7805CT +5V. REG
U500	C 4345-2	LM339N VOLT COMPARATOR
U501	C 4345-2	LM339N VOLT COMPARATOR
U502	C 6901-0	MOC8021 OPTO-ISOLATOR
U503	C 6901-0	MOC8021 OPTO-ISOLATOR
U504	C 6901-0	MOC8021 OPTO-ISOLATOR
U505	C 6901-0	MOC8021 OPTO-ISOLATOR
U506	C 6901-0	MOC8021 OPTO-ISOLATOR
U507	C 6901-0	MOC8021 OPTO-ISOLATOR
U508	C 6901-0	MOC8021 OPTO-ISOLATOR
U509	C 4345-2	LM339N VOLT COMPARATOR
U900	C 5826-0	LM234Z-6 THERMAL SENSE

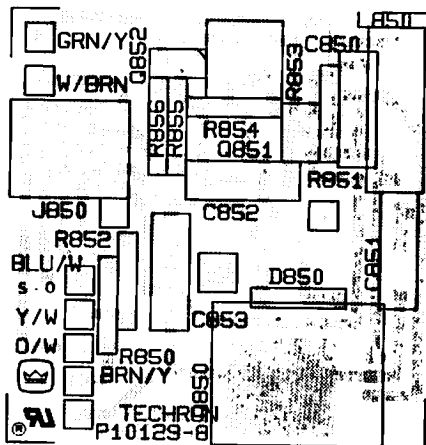
## 8.11 Printed Circuit Boards



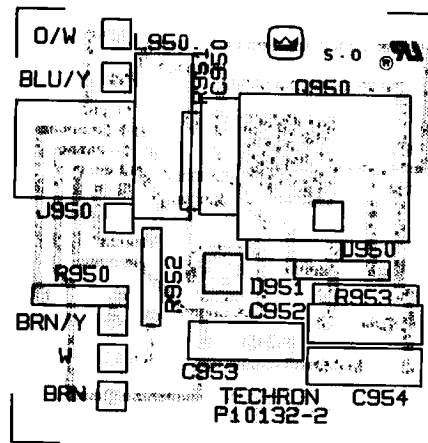
**Illustration 8-5**  
**HI NPN Predriver Circuit Board**



**Illustration 8-6**  
**HI PNP Predriver Circuit Board**

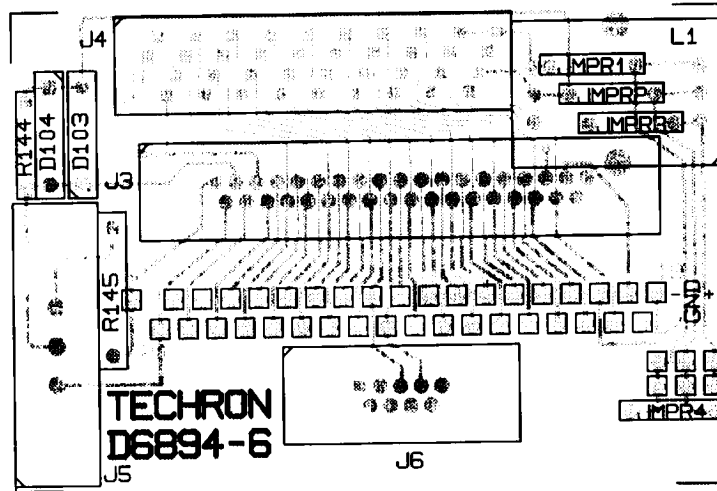
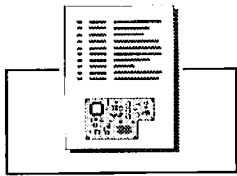


**Illustration 8-7**  
**LO NPN Predriver Circuit Board**



**Illustration 8-8**  
**LO PNP Predriver Circuit Board**





**Illustration 8-9**  
**Input Connection Circuit Board**