



Advanced Test Equipment Corp.

www.atecorp.com 800-404-ATEC (2832)

**2558A**

**AC Voltage Current Standard**

**U S E R ' S M A N U A L**

---

# User Registration

YOKOGAWA provides registered users with useful information and services. Please allow us to serve you best by completing the user registration form accessible from our website.

<https://tmi.yokogawa.com/support/>



# Contact Us

If you want to resolve a technical support issue or need to contact YOKOGAWA, please fill out the inquiry form on our website.

<https://tmi.yokogawa.com/contact/>



Thank you for purchasing the 2558A AC Voltage Current Standard.

The 2558A is a stable signal generator that produces the following voltage and current signals.

- AC voltage: 1 mV to 1200 V; frequency: 40 Hz to 1000 Hz
- AC current: 1 mA to 60 A; frequency: 40 Hz to 1000 Hz

This user's manual explains the features, operating procedures, and handling precautions of the 2558A. To ensure correct use, please read this manual thoroughly before beginning operation. Keep this manual in a safe place for quick reference in the event that a question arises.

## List of Manuals

The following manuals, including this one, are provided as manuals for the 2558A. Please read all manuals.

Manual Title	Manual No.	Description
2558A AC Voltage Current Standard User's Manual	IM 2558A-01EN	This manual. The manual explains the handling precautions, features, specifications, communication interfaces, how to operate the 2558A, and so on.
2558A AC Voltage Current Standard Safety Instruction Manual	IM 2558A-92Z1 IM 00C01C01-01Z1	Document for China Safety manual (European languages)

The "EN" and "Z1" in the manual numbers are the language codes.

Contact information of Yokogawa offices worldwide is provided on the following sheet.

Document No.	Description
PIM 113-01Z2	List of worldwide contacts

## Notes

- The contents of this manual are subject to change without prior notice as a result of continuing improvements to the instrument's performance and functionality. The figures given in this manual may differ from those that actually appear on your screen.
- Every effort has been made in the preparation of this manual to ensure the accuracy of its contents. However, should you have any questions or find any errors, please contact your nearest YOKOGAWA dealer.
- Copying or reproducing all or any part of the contents of this manual without the permission of YOKOGAWA is strictly prohibited.
- The TCP/IP software of this product and the documents concerning it have been developed/created by YOKOGAWA based on the BSD Networking Software, Release 1 that has been licensed from the Regents of the University of California.



### High voltage

The 2558A generates sinusoidal of up to 1440 Vrms.

- To prevent electric shock, be sure to read this manual before use.
- Improper operation may lead to serious, life-threatening accidents. Keep this manual close to the 2558A so that the operator can refer to it anytime.

### French



### Haute tension

2558A génère un sinusoïdal jusqu'à 1440 Vrms.

- Afin d'éviter tout choc électrique, bien lire le présent manuel avant utilisation.
- Une utilisation incorrecte entraînerait des risques d'accidents graves voire mortels. Conservez ce manuel à proximité du 2558A, de sorte que l'opérateur puisse le consulter à tout moment.

---

## Trademarks

- Microsoft, Internet Explorer, MS-DOS, Windows, Windows NT, Windows XP, Windows Vista and Windows 7 are either registered trademarks or trademarks of Microsoft Corporation in the United States and/or other countries.
- Adobe and Acrobat are either registered trademarks or trademarks of Adobe Systems Incorporated.
- In this manual, the ® and TM symbols do not accompany their respective registered trademark or trademark names.
- Other company and product names are registered trademarks or trademarks of their respective holders.

## Revisions

- 1st Edition: May 2013
- 2nd Edition: March 2016
- 3rd Edition : October 2017
- 4th Edition : August 2019
- 5th Edition : March 2021
- 6th Edition : November 2021

# Checking the Contents of the Package

Unpack the box and check the contents before operating the instrument. If the wrong items have been delivered, if items are missing, or if there is a problem with the appearance of the items, contact your nearest YOKOGAWA dealer.

## 2558A

Check that the product that you received is what you ordered by referring to the model name and suffix code given on the name plate on the side panel.

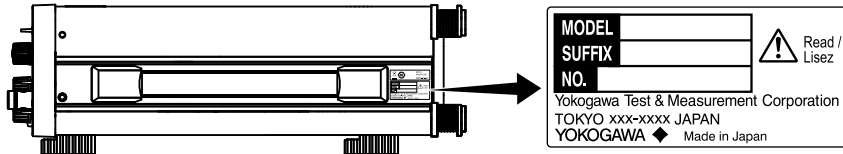

### MODEL and SUFFIX Codes

Model	Suffix Code <sup>1</sup>	Specifications
2558A		1200 V, 60 A
Power cord <sup>2</sup>	-D	UL/CSA standard power cord, <b>maximum rated voltage: 125 V</b>
	-F	VDE standard power cord, <b>maximum rating: 250 V</b>
	-R	AS standard power cord, <b>maximum rating: 250 V</b>
	-Q	BS standard power cord, <b>maximum rating: 250 V</b>
	-H	GB standard power cord, <b>maximum rating: 250 V</b>
	-N	NBR standard power cord, <b>maximum rating: 250 V</b>
	-T	Taiwanese standard power cord, <b>maximum rating: 125 V</b>
	-B	Indian standard power cord, <b>maximum rating: 250 V</b>
	-U	IEC Plug Type B power cord, <b>maximum rating: 250 V</b>
	-Y	No power cord included. <sup>3</sup>
Additional specifications (options)	/C1	<b>GP-IB interface</b>

- 1 For products whose suffix code contains "Z," an exclusive manual may be included. Please read it along with the standard manual.
- 2 Make sure that the attached power cord meets the designated standards of the country and area that you are using it in.
- 3 Prepare a power cord that complies with the standard specified by the country or region that the instrument will be used in.

### No. (Instrument number)

When contacting the dealer from which you purchased the instrument, please give them the instrument number.

## Standard Accessories

The instrument is shipped with the following accessories. Make sure that all accessories are present and undamaged.

Power cord (one cord that matches the suffix code is included)<sup>1</sup>

UL/CSA Standard  
A1006WD

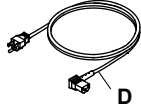

D

VDE Standard  
A1009WD

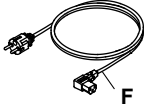

F

BS Standard  
A1054WD

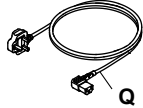

Q

AS Standard  
A1024WD



R

GB Standard  
A1064WD

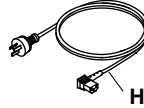

H

NBR Standard  
A1088WD



N

Taiwanese standard  
A1100WD

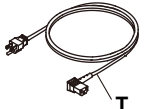

T

Indian standard  
A1101WD

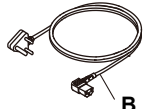

B

IEC plug Type B  
A1102WD

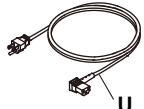

U

Measurement lead<sup>2</sup>  
set B8506ZK



Measurement lead<sup>2</sup>  
set B8506WA



Alligator clip  
adapter<sup>2</sup>  
set B8506ZL

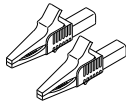

Rubber leg cap  
A9088ZM



Manuals

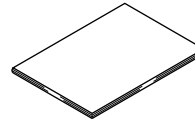

IM 2558A-01EN  
User's Manual (this manual)  
IM 2558A-92Z1  
Document for China  
IM 00C01C01-01Z1  
Safety manual  
(European languages)  
PIM 113-01Z2  
List of worldwide contacts

Standard accessories are not covered by warranty.

- 1 Make sure that the attached power cord meets the designated standards of the country and area that you are using it in. If the suffix code is -Y, a power cord is not included.
- 2 The included measurement leads and alligator clip adapter set are exclusive to this product.

## Optional Accessories (Sold separately)

The following optional accessories are available for purchase separately.

For information about ordering accessories, contact your nearest YOKOGAWA dealer.

Item	Model/ Part No.	Min. Q'ty	Notes	Manual No.
Measurement lead	758917	1 set	Safety terminal cable with 2 leads (red and black) in a set. Length: 0.75 m. Rating: 1000 V, 32 A.	—
	758933	1 set	Safety terminal cable with 2 leads (red and black) in a set. Length: 1 m. Rating: 1000 V, 19 A.	—
	B8506ZK	1 set	Safety terminal cable with 2 leads (red and black) in a set. Length: 1 m. Rating: 1500 V, 19 A.	—
	B8506WA	1 set	Current output cable with 2 leads (red and black) in a set. Length: 1.5 m. Rating: 42 V, 80 A.	—
Alligator clip adapter (small)	758922	1 set	Safety terminal-to-alligator clip adapter. Red and black, 1 pc each. Rating: 300 V, 15 A.	—
Alligator clip adapter (large)	758929	1 set	Safety terminal-to-alligator clip adapter. Red and black, 1 pc each. Rating: 1000 V, 32 A.	—
	B8506ZL	1 set	Safety terminal-to-alligator clip adapter. Red and black, 1 pc each. Rating: 1500 V, 32 A.	—
Fork terminal adapter	758921	1 set	Safety terminal-to-fork terminal adapter. Red and black, 1 pc each. Rating: 1000 V, 20 A.	—
BNC cable	366924	1	BNC-BNC. Length: 1 m. Rating: 42 V.	—
	366925	1	BNC-BNC. Length: 2 m. Rating: 42 V.	—
Safety terminal adapter	758923	1 set	Spring clamp type. Red and black, 1 pc. each. Rating: 600 V, 10 A.	—
	758931	1 set	Screw-in type. Red and black, 1 pc. each. Rating: 1000 V, 36 A.	—

Accessories (sold separately) are not covered by warranty.

### WARNING

- Use the accessories specified in this manual. Moreover, use the accessories of this product only with Yokogawa products that specify them as accessories.
- Use the accessories of this product within the rated range of each accessory. When using several accessories together, use them within the specification range of the accessory with the lowest rating.
- Due to the structure of the product, it is possible to touch the metal parts of the fork terminal adapter 758921. Be careful as this constitutes an electric shock hazard.

### CAUTION

Use BNC cables 366924 and 366925 for the BNC I/O terminals.

## French

### AVERTISSEMENT

- Utiliser les accessoires spécifiés dans ce manuel. En outre, utiliser les accessoires de ce produit uniquement avec des produits Yokogawa pour lesquels ils sont spécifiés comme accessoires.
- Utilisez les accessoires de ce produit en fonction des valeurs nominales de chacun. Lorsque vous employez plusieurs accessoires en même temps, utilisez les valeurs de l'accessoire ayant les valeurs nominales les plus faibles.

## **Checking the Contents of the Package**

---

- Compte tenu de la structure du produit, il est possible de toucher les pièces métalliques de l'adaptateur de borne à fourche 758921. Procédez avec soin, car cette opération présente un risque de choc électrique.
- 
- 

### **ATTENTION**

---

Utiliser les câbles BNC 366924 et 366925 pour les bornes E/S BNC.

---



# Safety Precautions

This product is designed to be used by a person with specialized knowledge.

This instrument is an IEC safety class I instrument (provided with a terminal for protective earth grounding).

The general safety precautions described herein must be observed during all phases of operation. If the instrument is used in a manner not specified in this manual, the protection provided by the instrument may be impaired. YOKOGAWA assumes no liability for the customer's failure to comply with these requirements.

This manual is part of the product and contains important information. Store this manual in a safe place close to the instrument so that you can refer to it immediately. Keep this manual until you dispose of the instrument.

## The following symbols are used on this instrument.



Warning: handle with care. Refer to the user's manual or service manual. This symbol appears on dangerous locations on the instrument which require special instructions for proper handling or use. The same symbol appears in the corresponding place in the manual to identify those instructions.



Electric shock, danger



Ground (earth) or functional ground terminal (do not use this terminal as a protective ground terminal)



Alternating current



On (power)



Off (power)



Power-on state



Power-off state

## French



Avertissement : À manipuler délicatement. Toujours se reporter aux manuels d'utilisation et d'entretien. Ce symbole a été apposé aux endroits dangereux de l'instrument pour lesquels des consignes spéciales d'utilisation ou de manipulation ont été émises. Le même symbole apparaît à l'endroit correspondant du manuel pour identifier les consignes qui s'y rapportent.



Choc électrique, danger



Borne de terre ou borne de terre fonctionnelle (ne pas utiliser cette borne comme prise de terre.)



Courant alternatif



Marche (alimentation)



Arrêt (alimentation)



Marche



Arrêt

**Failure to comply with the precautions below could lead to injury or death or damage to the instrument.**

---

**WARNING**

**Use the Instrument Only for Its Intended Purpose**

This instrument is an AC voltage and current standard that generates AC voltage and AC current. Use this instrument only for this purpose.

**Check the Physical Appearance**

Do not use the instrument if there is a problem with its physical appearance.

**Use the Correct Power Supply**

Make sure that the power supply voltage matches the instrument's rated supply voltage and that it does not exceed the maximum voltage range of the power cord to use.

**Use the Correct Power Cord and Plug**

To prevent the possibility of electric shock or fire, be sure to use the power cord for the instrument. The main power plug must be plugged into an outlet with a protective earth terminal. Do not invalidate this protection by using an extension cord without protective earth grounding.

Further, do not use this power cord with other instruments.

**Connect the Protective Grounding Terminal**

Make sure to connect the protective earth to prevent electric shock before turning on the power. The power cord that you can use for the instrument is a three-prong cord. Connect the power cord to a properly grounded three-prong outlet.

**Do Not Impair the Protective Grounding**

Never cut off the internal or external protective earth wire or disconnect the wiring of the protective earth terminal. Doing so may result in electric shock or damage to the instrument.

**Do Not Use When the Protection Functions Are Defective**

Before using this instrument, check that the protection functions, such as the protective grounding and fuse, are working properly. If you suspect a defect, do not use the instrument.

**Do Not Operate in an Explosive Atmosphere**

Do not operate the instrument in the presence of flammable gasses or vapors. Doing so is extremely dangerous.

**Do Not Remove the Covers or Disassemble or Alter the Instrument**

Only qualified YOKOGAWA personnel may remove the covers and disassemble or alter the instrument. The inside of the instrument is dangerous because parts of it have high voltages.

**Ground the Instrument before Making External Connections**

Securely connect the protective grounding before connecting to the target device or to an external control unit. Before touching the target device, turn off this instrument and check that there is no voltage or current being generated.

**Measurement Category**

The measurement category of the 2558A terminals is Other (O). Do not use it for main power supply circuits or circuits that fall under Measurement Categories II, III, and IV.

**Install or Use the Instrument in Appropriate Locations**

- Do not install the instrument outdoors or in locations subject to rain or water. Or, use the instrument in such locations.
- Install the instrument so that you can immediately remove the power cord if an abnormal or dangerous condition occurs.

**Be Careful When Generating High Voltage**

- This product generates high voltage. Be careful of electric shock and electric discharge.
- To prevent electric shock, remove rings, watches, and other metallic accessories and jewelry before operation.

**Connect Cables Correctly**

This instrument can generate large voltage and current. If you do not connect the devices correctly, not only will it damage the instrument or the target device, it may also lead to electric shock or fire. Be careful when you connect the cables, and be sure to check the following points.

Before output (before turning on the output), check that:

- Cables have been connected to the instrument's output terminals correctly.  
Check that there are no voltage output cables that have been connected to the current terminals.  
Check that there are no current output cables that have been connected to the voltage terminals.
- Cables have been connected to the target device correctly.  
Check that there are no short circuits between voltage terminals or between the cables connected to the voltage terminals.
- The cables are connected firmly to the current terminals.
- There are no problems with the current terminals and the crimping terminals, such as the presence of foreign substances.

During output (never touch the terminals or the connected cables when this instrument is on), check that:

- There are no problems with the current terminals and the crimping terminals, such as the presence of foreign substances.
- The current terminals are not abnormally hot.
- The cables are connected firmly to the current terminals.

The terminal connections may become loose over time. If this happens, heat may be generated due to changes in contact resistance. If you are going to take measurements using the same setup for a long time, periodically check that the cables are firmly connected to the terminals. Be sure to turn off both this instrument and the target device before you check the connections.

After output (immediately after the output is turned off)

After you output a voltage or current, voltage may remain for some time even after you turn the output off. This residual voltage may lead to electric shock. Do not touch the terminals immediately after you turn the output off. The amount of time that voltage remains varies depending on the target device.

---

---

**CAUTION**

---

---

**Operating Environment Limitations**

This product is classified as Class A (for use in industrial environments). Operation of this product in a residential area may cause radio interference, in which case the user will be required to correct the interference.

---

## French

---

### AVERTISSEMENT

#### **Utiliser l'instrument aux seules fins pour lesquelles il est prévu**

Cet instrument comprend une tension CA et courant standard. Il génère une tension CA et un courant CA. Utilisez cet instrument à cette fin uniquement.

#### **Inspecter l'apparence physique**

Ne pas utiliser l'instrument si son intégrité physique semble être compromise.

#### **Vérifier l'alimentation**

Assurez-vous que la tension d'alimentation correspond à la tension d'alimentation nominale de l'appareil et qu'elle ne dépasse pas la plage de tension maximale du cordon d'alimentation à utiliser.

#### **Utiliser le cordon d'alimentation et la fiche adaptés**

Pour éviter tout risque de choc électrique, utiliser exclusivement le cordon d'alimentation prévu pour cet instrument. La fiche doit être branchée sur une prise secteur raccordée à la terre. En cas d'utilisation d'une rallonge, celle-ci doit être impérativement reliée à la terre. Par ailleurs, ne pas utiliser ce cordon d'alimentation avec d'autres instruments.

#### **Brancher la prise de terre**

Avant de mettre l'instrument sous tension, penser à brancher la prise de terre pour éviter tout choc électrique. Le cordon d'alimentation que vous utilisez pour l'instrument est un cordon à trois broches. Brancher le cordon d'alimentation sur une prise de courant à trois plots et mise à la terre.

#### **Ne pas entraver la mise à la terre de protection**

Ne jamais neutraliser le fil de terre interne ou externe, ni débrancher la borne de mise à la terre. Cela pourrait entraîner un choc électrique ou endommager l'instrument.

#### **Ne pas utiliser lorsque les fonctions de protection sont défectueuses**

Avant d'utiliser l'instrument, vérifier que les fonctions de protection, telles que le raccordement à la terre et le fusible, fonctionnent correctement. En cas de dysfonctionnement possible, ne pas utiliser l'instrument.

#### **Ne pas utiliser dans un environnement explosif**

Ne pas utiliser l'instrument en présence de gaz ou de vapeurs inflammables. Cela pourrait être extrêmement dangereux.

#### **Ne pas retirer le capot, ni démonter ou modifier l'instrument**

Seul le personnel YOKOGAWA qualifié est habilité à retirer le capot et à démonter ou modifier l'instrument. Certains composants à l'intérieur de l'instrument sont à haute tension et par conséquent, représentent un danger.

#### **Relier l'instrument à la terre avant de le brancher sur des connexions externes**

Connectez le conducteur de terre avant de raccorder le dispositif cible ou une unité de commande externe. Avant de toucher le dispositif cible, mettez l'instrument hors tension, et vérifiez qu'aucune tension ni aucun courant ne sont émis.

#### **Catégorie de mesure**

La catégorie de mesure des bornes 2558A est O (Other, Autre). Ne l'utilisez pas pour les circuits d'alimentation principale ou ceux correspondant aux catégories de mesure II, III et IV.

#### **Installer et utiliser l'instrument aux emplacements appropriés**

- Ne pas installer, ni utiliser l'instrument à l'extérieur ou dans des lieux exposés à la pluie ou à l'eau.
- Installer l'instrument de manière à pouvoir immédiatement le débrancher du secteur en cas de fonctionnement anormal ou dangereux.

**Manipulez avec précaution lors de la génération de tension élevée**

- Le produit génère une tension élevée. Faites attention au choc électrique et à la décharge électrique.
- Afin d'éviter tout choc électrique, retirez les bagues, les montres et autres accessoires métalliques ainsi que les bijoux avant la mise en service.

**Câblage correct**

Cet équipement délivre une tension et une intensité élevées. Si vous ne raccordez pas correctement les appareils, non seulement cela risque d'endommager l'équipement ou l'appareil cible, mais en plus cela risque d'entraîner un choc électrique ou un incendie. Branchez toujours les câbles en plomb correctement et vérifiez les points suivants.

Avant le sortie (avant la mise sous tension), vérifiez que :

- Les câbles en plomb sont correctement raccordés aux bornes de sortie de l'équipement. Les câbles de sortie de la tension n'ont pas été malencontreusement branchés sur les bornes de courant. Les câbles de sortie du courant n'ont pas été malencontreusement branchés sur les bornes de tension.
- Les câbles ont été correctement branchés sur l'appareil voulu. Vérifier qu'il n'y a pas de court-circuit entre les bornes de tension ou entre les câbles raccordés aux bornes de tension.
- Les câbles ont été correctement branchés sur les bornes de courant.
- Il n'y a aucun problème avec les bornes d'entrée de courant et les bornes de sertissage, comme par exemple une présence de corps étrangers.

Pendant la sortie (ne pas toucher les bornes ni les câbles branchés lorsque l'instrument est sous tension), vérifiez que :

- Il n'y a aucun problème avec les bornes d'entrée de courant et les bornes de sertissage, comme par exemple une présence de corps étrangers.
- Les bornes d'entrée ne chauffent pas anormalement.
- Les câbles ont été correctement branchés sur les bornes de courant. Les raccordements de bornes risquent de se détacher dans le temps. Le cas échéant, une chaleur peut être générée suite aux changements de résistance au contact. Vérifiez régulièrement que les câbles en plomb sont bien raccordés aux bornes. Éteignez bien à la fois cet équipement et l'appareil cible avant de vérifier les raccordements.

Après la sortie (tout de suite après la mise hors tension)

Une fois une tension ou un courant obtenu(e), la tension peut rester un certain temps, même après la mise hors tension. Cette tension résiduelle peut entraîner un choc électrique. Ne touchez pas immédiatement les bornes après la mise hors tension. La durée pendant laquelle la tension reste varie en fonction de l'appareil cible.

---

---

**ATTENTION**

---

---

**Limitations relatives à l'environnement opérationnel**

Ce produit est classé dans classe A (pour utilisation dans des environnements industriels). L'utilisation de ce produit dans une zone résidentielle peut entraîner une interférence radio que l'utilisateur sera tenu de rectifier.

---

---

# Regulations and Sales in Various Countries and Regions

## Waste Electrical and Electronic Equipment (WEEE)



(EU WEEE Directive valid only in the EEA\* and UK WEEE Regulation in the UK)

This product complies with the WEEE marking requirement. This marking indicates that you must not discard this electrical/electronic product in domestic household waste. When disposing of products in the EEA or UK, contact your local Yokogawa office in the EEA or UK respectively.

\* EEA: European Economic Area

## Authorized Representative in the EEA

Yokogawa Europe B.V. is the authorized representative of Yokogawa Test & Measurement Corporation for this product in the EEA. To contact Yokogawa Europe B.V., see the separate list of worldwide contacts, PIM 113-01Z2.

## 關於在台灣銷售

This section is valid only in Taiwan.

關於在台灣所販賣的符合其相關規定的電源線 A1100WD 的限用物質含量信息，請至下麵的網址進行查詢  
<https://tmi.yokogawa.com/support/service-warranty-quality/product-compliance/>

## Disposal

When disposing of YOKOGWA products, follow the laws and ordinances of the country or region where the product will be disposed of.

---

# Conventions Used in This Manual

## Notes

The notes and cautions in this manual are categorized using the following symbols.



*Improper handling or use can lead to injury to the user or damage to the instrument.* This symbol appears on the instrument to indicate that the user must refer to the user's manual for special instructions. The same symbol appears in the corresponding place in the user's manual to identify those instructions. In the user's manual, the symbol is used in conjunction with the word "WARNING" or "CAUTION."

### **WARNING**

Calls attention to actions or conditions that could cause serious or fatal injury to the user, and precautions that can be taken to prevent such occurrences.

---

### **CAUTION**

Calls attention to actions or conditions that could cause light injury to the user or cause damage to the instrument or user's data, and precautions that can be taken to prevent such occurrences.

## French

### **AVERTISSEMENT**

Attire l'attention sur des gestes ou des conditions susceptibles de provoquer des blessures graves (voire mortelles), et sur les précautions de sécurité pouvant prévenir de tels accidents.

---

### **ATTENTION**

Attire l'attention sur des gestes ou des conditions susceptibles de provoquer des blessures légères ou d'endommager l'instrument ou les données de l'utilisateur, et sur les précautions de sécurité susceptibles de prévenir de tels accidents.

### **Note**

Calls attention to information that is important for the proper operation of the instrument.

## Characters That Appear on the 7-Segment LED

Because this instrument uses a 7-segment LED display, numbers, letters, and mathematical symbols are displayed using special characters. For details, see section 1.3, "Digital Numbers and Characters."

## Symbols and Conventions Used in Procedural Explanations

The contents of the procedural explanations are indicated using the following symbols.

### **Procedure**

Carry out the procedure according to the step numbers. All procedures are written under the assumption that you are starting operation at the beginning of the procedure, so you may not need to carry out all the steps in a procedure when you are changing the settings.

### **Explanation**

This section describes the setup items and the limitations regarding the procedures. It may not give a detailed explanation of the feature. For a detailed explanation of the feature, see chapter 2.

### **<<Command Mnemonic>>**

Indicates a communication command that corresponds to some of the features described on the procedural explanation page.





## Characters and Terminology Used in Procedural Explanations

### **Dial and Switches**

Bold characters used in the procedural explanations indicate dials and switches on the panel.



# Contents

List of Manuals.....	i
Checking the Contents of the Package.....	iii
Safety Precautions.....	vii
Regulations and Sales in Various Countries and Regions.....	xii
Conventions Used in This Manual .....	xiii
<b>Chapter 1 Component Names and Functions</b>	
1.1 Panel .....	1-1
1.2 Dial and Switches.....	1-3
1.3 Digital Numbers and Characters .....	1-6
<b>Chapter 2 Features</b>	
2.1 System Configuration .....	2-1
2.2 Output.....	2-2
2.3 Output Divider .....	2-4
2.4 Deviation and Presets .....	2-5
2.5 Sweeping.....	2-7
2.6 Synchronous Operation.....	2-8
2.7 Other Features .....	2-9
<b>Chapter 3 Preparation</b>	
3.1 Handling Precautions .....	3-1
3.2 Installing the Instrument .....	3-3
 3.3 Connecting to the Power Supply .....	3-6
3.4 Turning On and Off the Power Switch.....	3-8
 3.5 Wiring Precautions .....	3-10
 3.6 Connecting Cables.....	3-14
<b>Chapter 4 How to Use the SETUP Menu</b>	
4.1 SETUP Menu Tree Structure.....	4-1
4.2 SETUP Menu and Dial Assignments.....	4-3
4.3 Entering and Displaying Values.....	4-4
<b>Chapter 5 Voltage and Current Generation</b>	
5.1 Selecting Whether to Ground the LO Terminal (COMMON Terminal).....	5-1
5.2 Setting the Frequency .....	5-3
5.3 Selecting the Voltage or Current Range.....	5-6
5.4 Main Voltage and Current Settings.....	5-7
5.5 Dividing the Output.....	5-8
 5.6 Turning the Output On and Off.....	5-9
5.7 Finely Adjusting the Output (Deviation and Preset).....	5-11
5.8 Sweeping.....	5-13

1

2

3

4

5

6

7

8

9

10

11

12

13

14

15

16

App

Index

**Chapter 6 Calibrating the Frequency Meter**

- 6.1 Selecting Whether to Ground the LO Terminal (COMMON Terminal)..... 6-1
- 6.2 Setting the Frequency ..... 6-3
- 6.3 Selecting the Voltage or Current Range..... 6-4
- 6.4 Main Voltage and Current Settings..... 6-5
- 6.5 Dividing the Output..... 6-6
- ⚠ 6.6 Turning the Output On and Off..... 6-7
- 6.7 Finely Adjusting the Output (Deviation and Preset)..... 6-9
- 6.8 Sweeping..... 6-11

**Chapter 7 Synchronous Operation**

- ⚠ 7.1 External Signal Input and Internal Signal Output ..... 7-1
- 7.2 Synchronous Operation..... 7-3

**Chapter 8 Other Features**

- 8.1 Turning the Beep Sound On and Off..... 8-1
- 8.2 Error Log Display..... 8-2
- 8.3 Initializing the Settings..... 8-4
- 8.4 Displaying the Product Information ..... 8-5

**Chapter 9 USB Interface**

- 9.1 USB Interface Features and Specifications..... 9-1
- 9.2 Connecting to the USB Interface..... 9-2

**Chapter 10 Ethernet Interface**

- 10.1 Ethernet Interface Features and Specifications ..... 10-1
- 10.2 Connecting to the Ethernet Interface..... 10-2
- 10.3 Configuring the 2558A Ethernet Settings ..... 10-3

**Chapter 11 GP-IB Option**

- 11.1 GP-IB Interface Features and Specifications ..... 11-1
- 11.2 Connecting to the GP-IB Interface ..... 11-3
- 11.3 Configuring the 2558A GP-IB Settings ..... 11-5
- 11.4 Responses to Interface Messages ..... 11-7

**Chapter 12 Programming Overview**

- 12.1 Messages ..... 12-1
- 12.2 Commands ..... 12-3
- 12.3 Responses ..... 12-5
- 12.4 Data ..... 12-6
- 12.5 Synchronization with the Controller..... 12-8

**Chapter 13 Commands**

13.1	List of Commands .....	13-1
13.2	COMMunicate Group .....	13-3
13.3	DIVider Group.....	13-4
13.4	FREQUency Group.....	13-5
13.5	OUTPut Group .....	13-6
13.6	DEViation Group.....	13-7
13.7	SOURce Group .....	13-8
13.8	STATus Group .....	13-9
13.9	SWEep Group .....	13-10
13.10	SYSTem Group .....	13-11
13.11	Common Command Group .....	13-13

**Chapter 14 Status Reports**

14.1	About Status Reports .....	14-1
14.2	Status Byte .....	14-3
14.3	Standard Event Register .....	14-4
14.4	Extended Event Register.....	14-5
14.5	Output and Error Queues .....	14-6

**Chapter 15 Troubleshooting, Maintenance, and Inspection**

15.1	Troubleshooting.....	15-1
15.2	Error Code Descriptions and Corrective Actions .....	15-2
15.3	Communication Error Messages .....	15-3
15.4	Instrument Error Detection and Clearance.....	15-7
15.5	Self-test .....	15-8
 15.6	Cleaning the Filter .....	15-9
15.7	Recommended Part Replacement .....	15-11
15.8	Adjustment and Calibration .....	15-11

**Chapter 16 Specifications**

16.1	Output.....	16-1
16.2	Accuracy.....	16-2
16.3	Functions.....	16-4
16.4	External Input and Output .....	16-5
16.5	Computer Interface.....	16-5
16.6	General Specifications .....	16-6
16.7	External Dimensions .....	16-8

**Appendix**

Appendix 1	Block Diagram .....	App-1
Appendix 2	Example of Using the 2558A to Calibrate an Analog Meter .....	App-2
Appendix 3	Example of Using the 2558A to Calibrate a Power Meter .....	App-4
Appendix 4	Phase Shift Feature .....	App-5
Appendix 5	Factory Default Settings.....	App-6
Appendix 6	About the IEEE 488.2-1992 Standard .....	App-7

**Index**

1

2

3

4

5

6

7

8

9

10

11

12

13

14

15

16

App

Index

# 1.1 Panel

## Front Panel

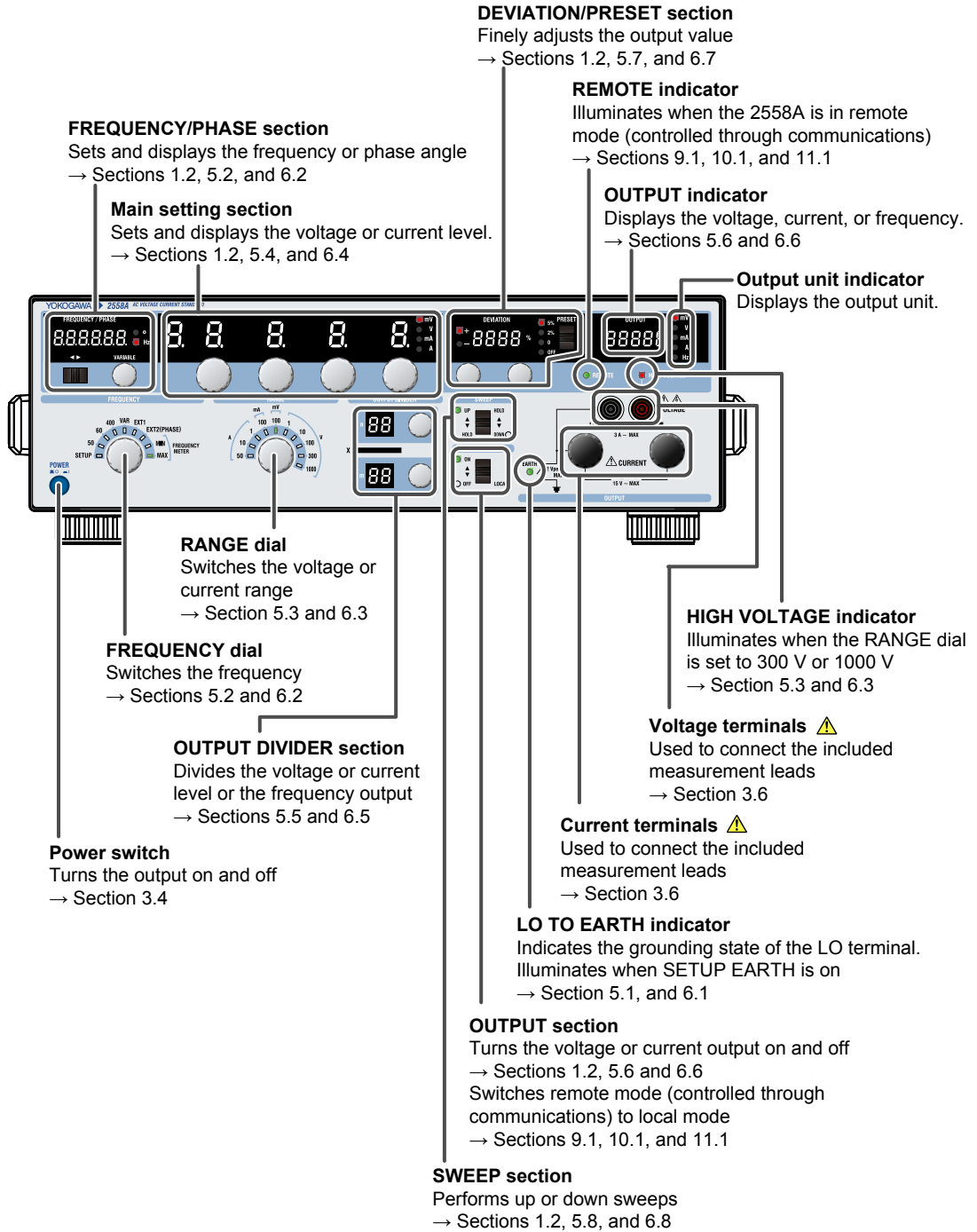

## Rear Panel

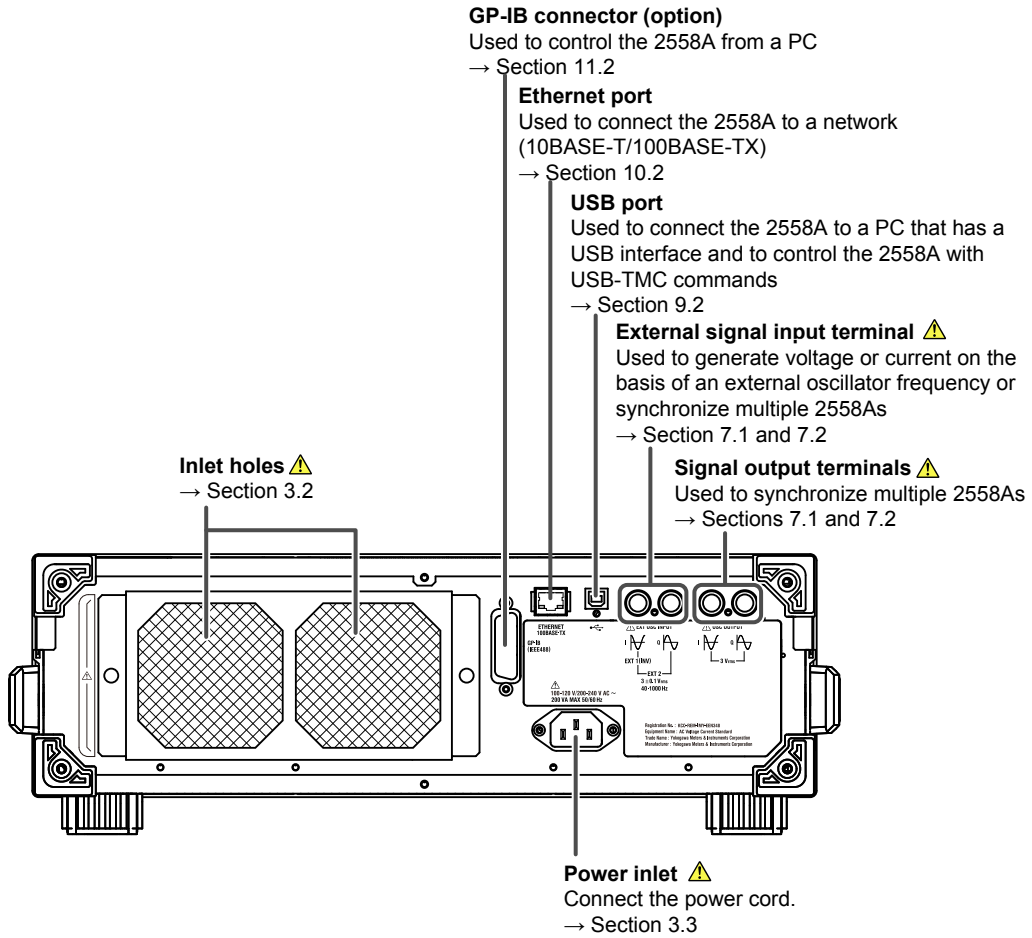

## Top and Bottom Panels

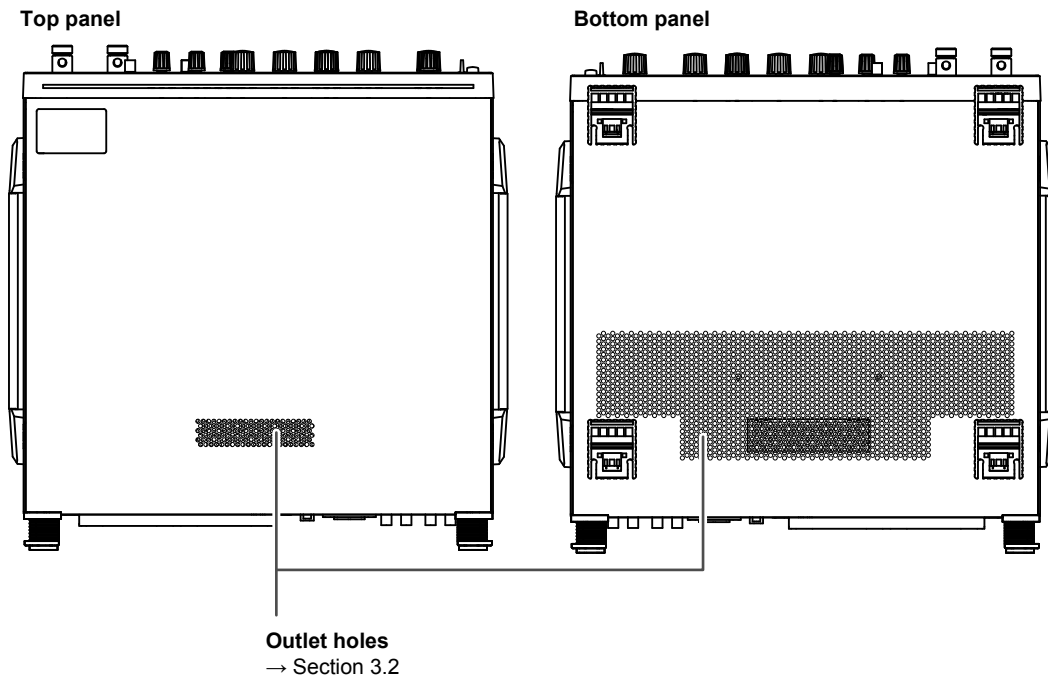

## 1.2 Dial and Switches

### FREQUENCY/PHASE Section

The FREQUENCY/PHASE section consists of a cursor switch (◀▶), a VARIABLE dial, a 6-digit FREQUENCY/PHASE display, and a unit indicator. These controls work differently depending on the FREQUENCY dial setting.

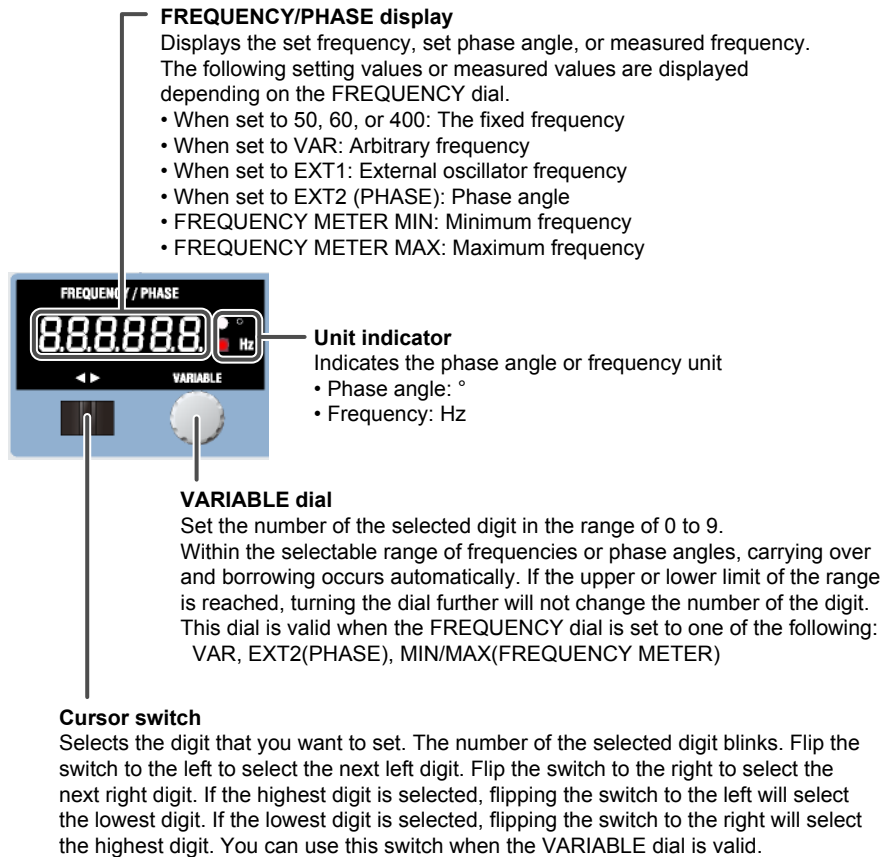

### Main Setting Section

The main setting section consists of four main setting dials, a 5-digit main setting display, and a unit indicator. The decimal place varies depending on the RANGE dial setting.

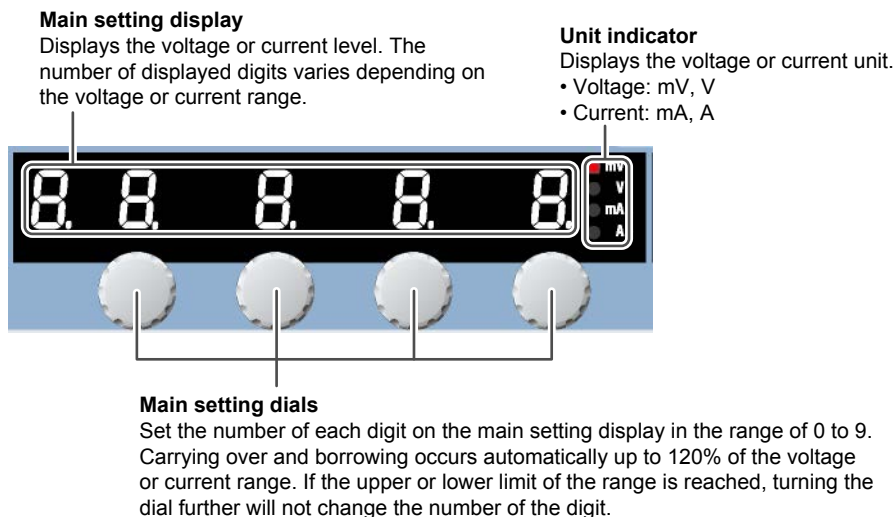

## DEVIATION/PRESET Section

The DEVIATION/PRESET section consists of two deviation dials, a 4-digit DEVIATION display, a PRESET switch, and a preset indicator.

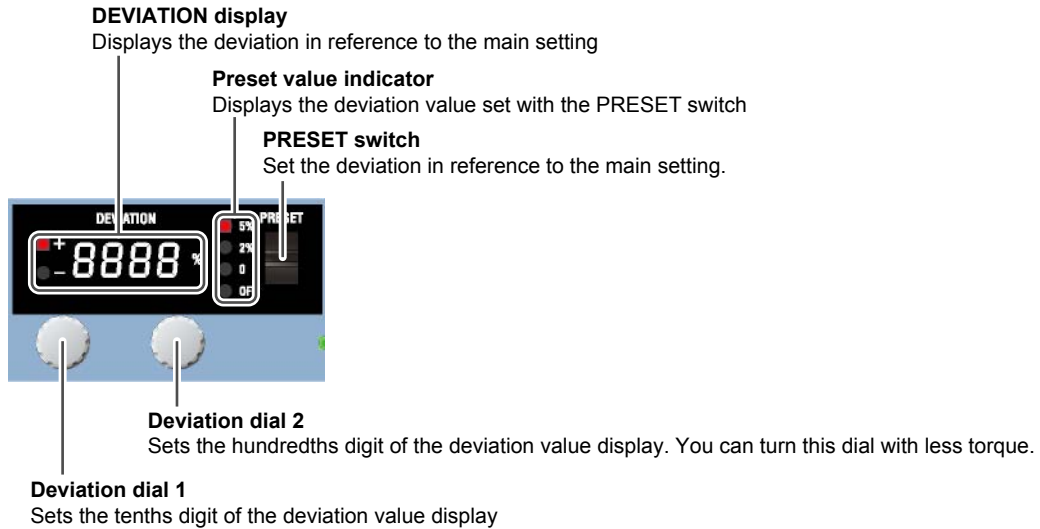

The deviation dial sets the number of each digit in the range of 0 to 9. Dial 1 changes the number in increments of 2; Dial 2 changes the number in increments of 1. Carrying over and borrowing occurs automatically up to  $\pm 20\%$ . If the upper or lower limit of the range is reached, turning the dial further will not change the number.

## SWEEP Section

The SWEEP section consists of a SWEEP switch and a pair of UP and DOWN indicators for indicating the sweep direction.

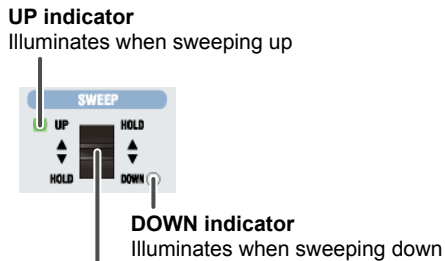

**SWEEP switch**  
**UP sweep**  
 Flip the switch up to sweep up. Flipping the switch down while sweeping up stops the sweeping (HOLD state).  
**DOWN sweep**  
 Flip the switch down to sweep down. Flipping the switch up while sweeping down stops the sweeping (HOLD state).

## OUTPUT Section

The OUTPUT section consists of a OUTPUT switch and a pair of ON and OFF indicators.

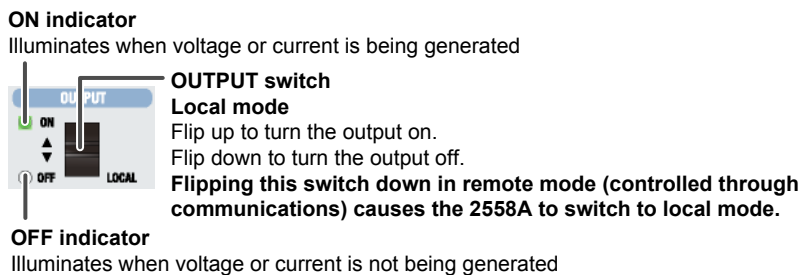

### OUTPUT DIVIDER Section

The OUTPUT DIVIDER section consists of m and n dials for setting the divider value (n/m) and m and n displays to show the value.

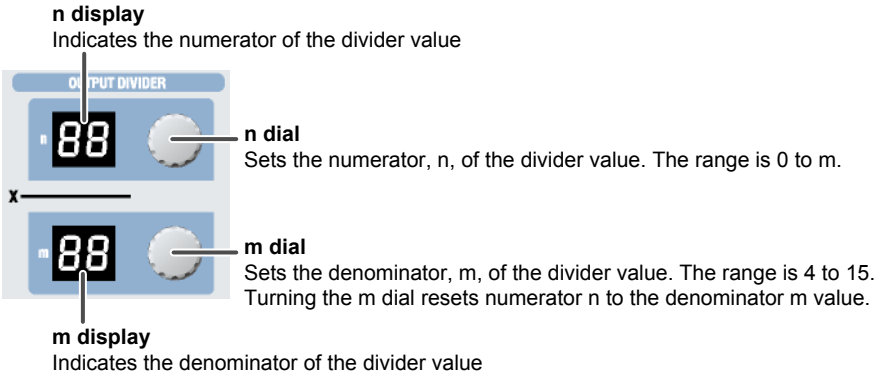



## 1.3 Digital Numbers and Characters

Because this instrument uses a 7-segment LED display, numbers, letters, and mathematical symbols are displayed using special characters in the manner shown below. Some of the characters shown below are not used by this instrument.

0 → 0	A → A	K → K	U → U	^(power) → ^
1 → 1	B → b	L → L	V → V	
2 → 2	C → C lowercase c → c	M → M	W → W	
3 → 3	D → d	N → n	X → X	
4 → 4	E → E	O → o	Y → Y	
5 → 5	F → F	P → P	Z → Z	
6 → 6	G → G	Q → Q	+ → +	
7 → 7	H → H lowercase h → h	R → r	- → -	
8 → 8	I → i	S → S	x → x	
9 → 9	J → J	T → t	÷ → ÷	

# 2.1 System Configuration

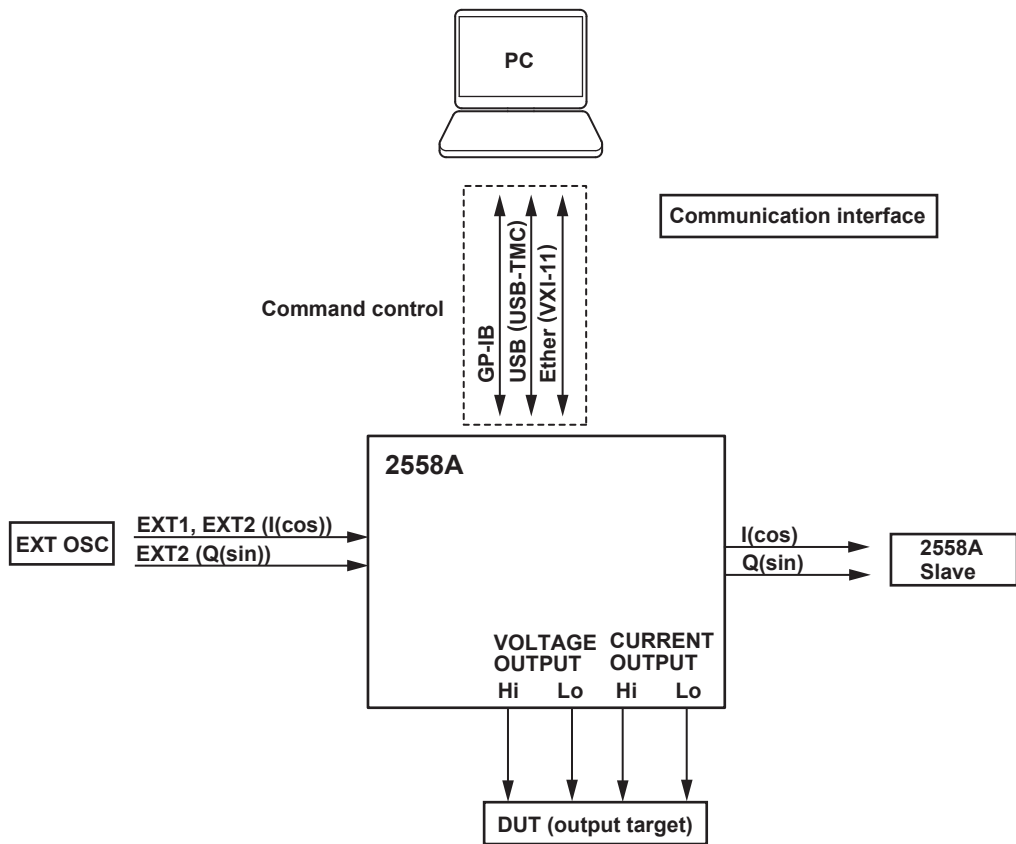

## 2.2 Output

### CAUTION

When voltage or current is being generated, if a load that would cause the range generated indicated below to be exceeded is connected, the instrument will detect the abnormal load and turn off the output.

### French

### ATTENTION

Lors de la génération de la tension ou du courant, si la charge appliquée risque de sortir de la plage générée indiquée ci-dessous, l'instrument détecte une charge anormale et coupe la sortie.

### Voltage Range and Range Generated

The maximum output at each voltage range is shown in the figure below. The maximum output is 120% of each voltage range rating. If you set the voltage range to 300 V or 1000 V, the HIGH VOLTAGE indicator will illuminate. If you set the voltage to 150 V or higher, a high-voltage caution beep will sound.

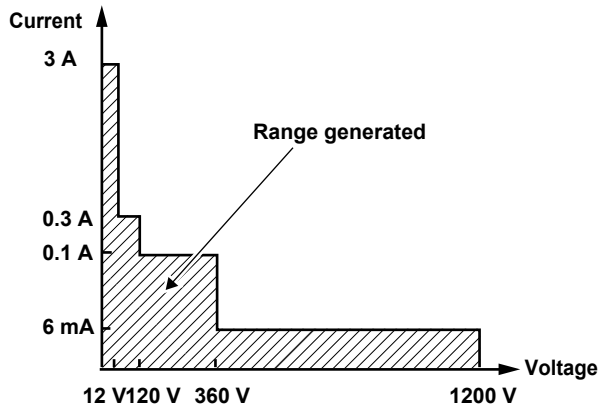

Voltage Range	Range Generated <sup>1</sup>	Maximum Output <sup>2</sup>
100 mV	0 mV to 120.00 mV	—
1 V	0 V to 1.2000 V	0.5 A or higher
10 V	0 V to 12.000V	approx. 3 A
100V	0 V to 120.00 V	approx. 0.3 A
300 V	0 V to 360.0 V	approx. 0.1 A
1000 V	0 V to 1200.0 V	approx. 6 mA

- 1 Generates 144% of the range when used with deviation (–20%)
- 2 At 1% to 120% of the range

### Current Range and Range Generated

The maximum output at each current range is shown in the figure below. The maximum output is 120% of each current range rating.

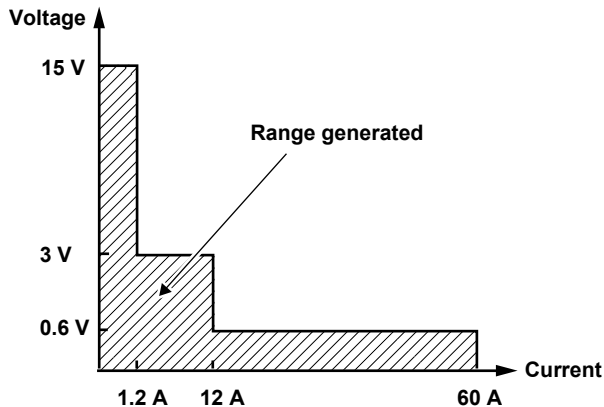

Current Range	Range Generated <sup>1</sup>	Maximum Output <sup>2</sup>
100 mA	0 mA to 120.00 mA	approx. 15 V
1 A	0 A to 1.2000 A	approx. 15 V
10 A	0 A to 12.000 A	approx. 3 V
50 A	0 A to 120.00 A	approx. 0.6 V

- 1 Generates 144% of the range when used with deviation (–20%)
- 2 At 1% to 120% of the range

## Turning the Output On and Off

There are two output modes: OFF and ON.

OFF: The output is disconnected. The specified output level is not generated.

ON: The output is connected, and the specified output level is generated. During output, the output display shows the voltage or current.

## Frequency and Phase Angle

### Fixed Frequency (50 Hz, 60 Hz, or 400 Hz)

The 2558A uses its internal oscillator to output sinusoidal voltage or current. 50 Hz and 60 Hz are used for devices that receive power line signals. 400 Hz is mainly used for meters used in aircrafts and marine vessels.

### Specific Frequency (VAR)

The 2558A uses its internal variable oscillator to output sinusoidal voltage or current. You can specify a frequency of your choice using a dial on the front panel. The setting is shown on the front panel. The accuracy is the same if you set one of the fixed frequencies with this feature.

Selectable range: 40 Hz to 1000 Hz

### External Oscillator EXT1

To output voltage or current, connect an external oscillator to the I side (EXT1) of the 2558A's external signal input terminal. Use this feature when you need to synchronize with other signals (i.e., function generator). The phase between input and output is reversed in order to accommodate compatibility with the predecessor model, 2558. The 2558A measures the external oscillator frequency and shows it on the front panel.

Input range: 40 Hz to 1000 Hz

### External Oscillator EXT2 (PHASE)

To output voltage or current, connect the two signal outputs from another 2558A. Use this feature to perform synchronous operation between multiple 2558As. You can set the phase angle according to the measurement system. The setting is shown on the front panel.

Selectable range:  $-180.000^\circ$  to  $+359.999^\circ$

Input range: 40 Hz to 1000 Hz. The frequency is not shown on the front panel.

## 2.3 Output Divider

When calibrating the target meter, the output divider feature divides the voltage or current level or the frequency into as many points as you need to calibrate. You can set the main setting to the maximum indication on the target meter, and vary the divider value to calibrate the various points on the meter.

Divider value range:  $n/m$  where  $n = 0$  to  $m$  and  $m = 4$  to  $15$

Setup example: When the main setting is 10 A,  $n$  is 2, and  $m$  is 4,  
output value =  $10 \text{ A} \times 2/4 = 5 \text{ A}$  (divider value:  $1/2$ )

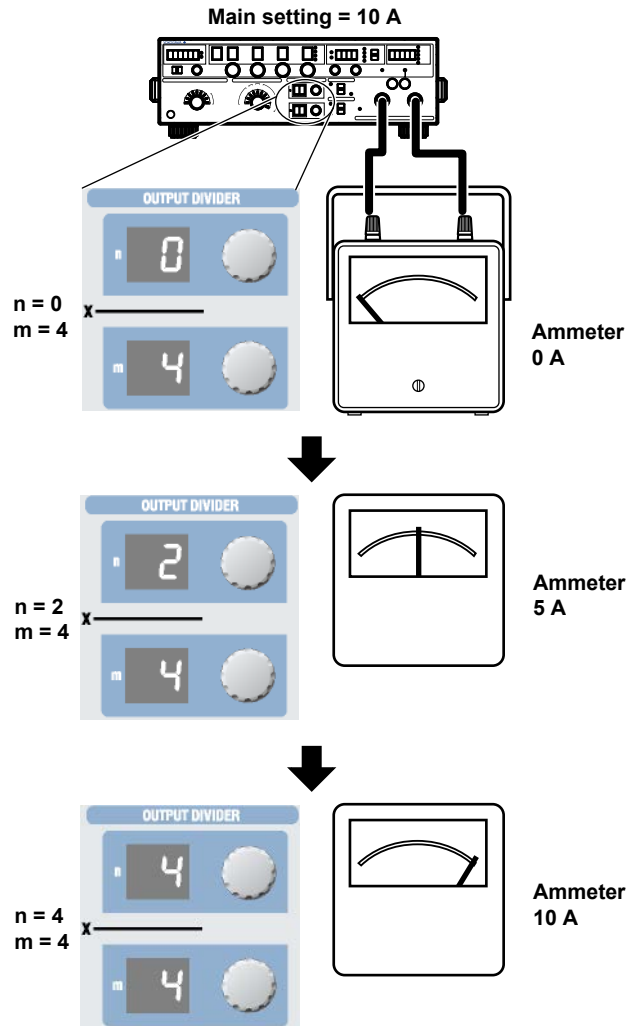

### Frequency Output Divider

If the frequency is set to FREQUENCY METER MIN or FREQUENCY METER MAX, the oscillation frequency is divided and output. The main setting is not divided.

For example, if the MIN frequency is 45 Hz, the MAX frequency is 65 Hz, and the main setting is 100 V, the following result is obtained.

At  $n = 0$  and  $m = 4$ , the output voltage is 100 V, and the frequency meter shows 45 Hz.

At  $n = 2$  and  $m = 4$ , the output voltage is 100 V, and the frequency meter shows 55 Hz.

At  $n = 4$  and  $m = 4$ , the output voltage is 100 V, and the frequency meter shows 65 Hz.

In this example, the frequency width of 20 Hz is divided into four parts and output at 5 Hz intervals.

The voltage level is not divided.

## 2.4 Deviation and Presets

### Deviation

This feature is used to check the relative error (deviation) of the meter scale calibration. If the meter needle is not pointing accurately to the appropriate scale mark, you can turn a deviation dial on the front panel to finely adjust the voltage or current output level or the frequency so that the needle points accurately to the mark. The amount of fine adjustment is displayed as the deviation.

Deviation setting range:  $\pm 20.00\%$

Setup example: Main setting = 10 A, divider value  $n/m = 1$

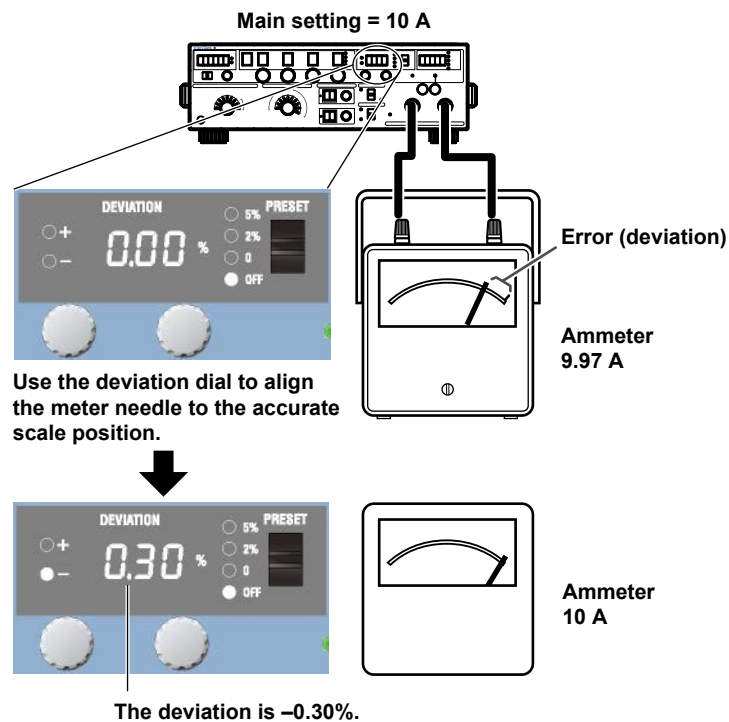

In the example above, before fine adjustment, the meter needle is pointing to 9.97 A, which is 0.30% smaller than the 10 A current output from the 2558A. The deviation polarity (the sign) of the 2558A indicates whether the target device indication is larger or smaller than the accurate position. In this example, because the meter is pointing to a value that is 0.30% smaller than the 2558A output value, the 2558A displays  $-0.30\%$ .

### Deviation at Each Calibration Point

When the deviation feature is used in conjunction with the output divider feature explained in section 2.3, you can check at each calibration point the deviation in reference to the maximum scale value. Note that if the frequency is set to FREQUENCY METER MIN or FREQUENCY METER MAX, the deviation is in reference to the span.

When the maximum scale value is 10 A, 1% is 0.1 A.

If you are using the output divider feature at  $n = 2$  and  $m = 10$ , when 2 A is being output, 1% will also be 0.1 A.

### Presets

Deviation presets can be used to make the meter indicate values that are short of the accurate scale positions when you change the output divider setting.

You can use this feature to calibrate a meter when using the output divider feature to calibrate the points in increasing or decreasing order.

5%: When calibrating in increasing order, the deviation is set to +5.00%.

When calibrating in decreasing order, the deviation is set to -5.00%.

2%: When calibrating in increasing order, the deviation is set to +2.00%.

When calibrating in decreasing order, the deviation is set to -2.00%.

0%: The deviation is cleared when the divider value is changed.

OFF: The specified deviation is retained even when the divider value is changed.

#### Example when calibrating in increasing order

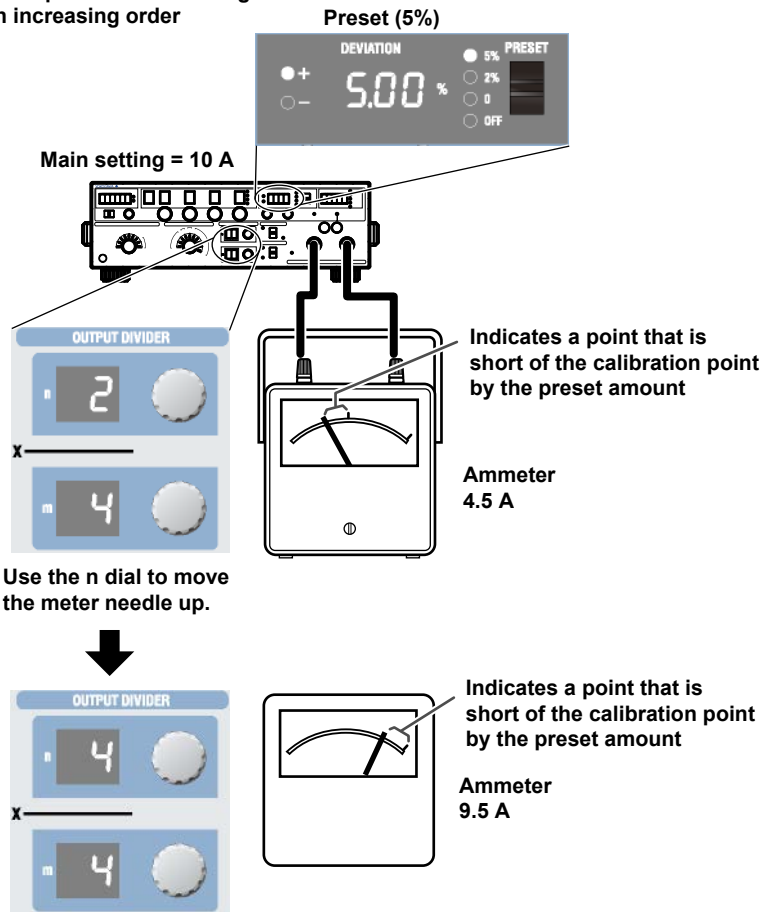

In the above example, the 2558A is generating -5.00% of the output setting. To calibrate the scale, turn a deviation dial to move the meter needle to the correct position. For details on how to read the deviation, see “Deviation” on the previous page.

## 2.5 Sweeping

The sweep feature moves the meter needle from the minimum scale value to 120% of the maximum scale value at a constant speed. It is used to check whether the needle is sticky when it moves. You can select the sweep time depending on the meter type. To sweep a wide-angle meter, you can select a long sweep time to move the needle slowly.

Sweep time: 8 s, 16 s, 32 s, or 64 s

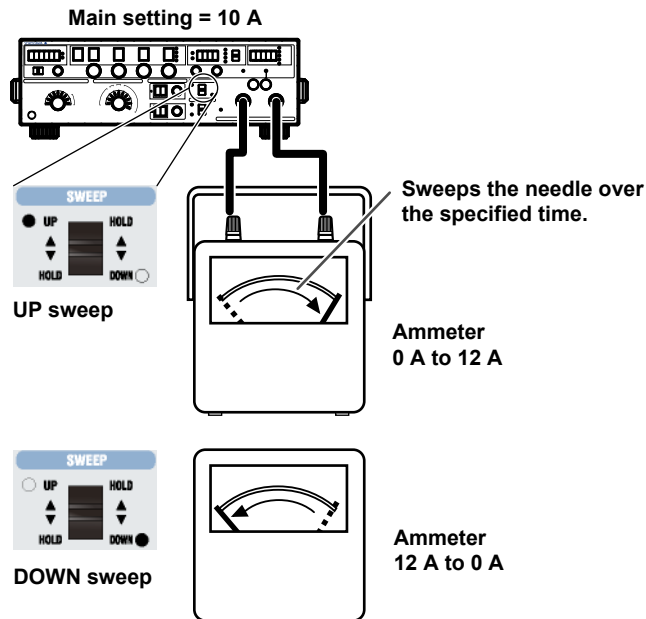

When sweeping up, sweeping is performed up to 120% of the maximum scale value.



## 2.6 Synchronous Operation

You can connect multiple 2558As together and output voltage or current in sync with the frequency of the master 2558A.

Synchronous operation is used when using two 2558As, one as a voltage generator and the other as a current generator, to calibrate a power meter or when using two 2558As in parallel to generate large current.

### External I/O Connection

Connect the signal output terminals (I and Q) on the rear panel of the master 2558A to the external input terminals (I and Q) of the slave 2558A.

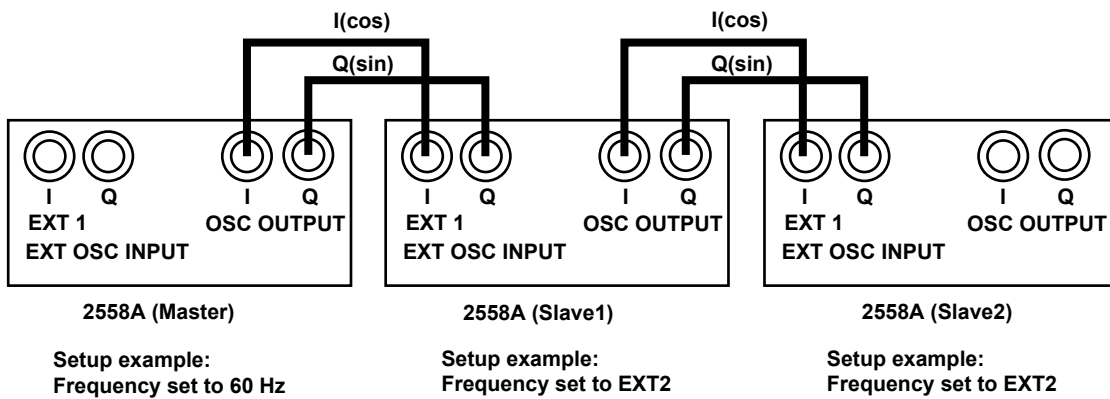

## 2.7 Other Features

### Turning the Beep Sound On and Off

Beeps are used to indicate the operation status of the device. You can turn it on and off from the SETUP menu.

You can turn the beep sound on or off for the following notifications. You cannot change the volume.

- When an error is detected during a self-test executed at power-on or executed manually (error codes: E.911 to E950)
- When the voltage output is set to 150 V or higher
- When a sweep operation is held

You can not turn off the beep sound for the following notifications.

- When the cooling fan stops (error code: E.901)
- When an abnormal temperature is detected (error code: E.902 to E.903)
- When an internal power supply error is detected (error code: E.904)

### Error Log Display

The error log keeps a record of error codes that occur in communication and self-tests while the 2558A is on. You can display the error log from the SETUP menu. The error log is cleared when the power is turned off.

### Initialization

You can initialize the 2558A settings to their factory defaults. You can execute initialization from the SETUP menu.

GP-IB and Ethernet settings are not initialized.

For a list of factory default settings, see appendix 5.

### Product Information Display

You can view the firmware version, serial number, and so on. You can view the product information from the SETUP menu.

- Firmware version
- Logic program version
- Boot program version
- Serial number

## 3.1 Handling Precautions

### Safety Precautions

If you are using the 2558A for the first time, make sure to read "Safety Precautions," on pages vi to x.

#### Do Not Remove the Case

Do not remove the case from the instrument. Some parts of the instrument use high voltages and are extremely dangerous. For internal inspection and adjustment, contact your nearest YOKOGAWA dealer.

#### Unplug If Abnormal Behavior Occurs

If you notice smoke or unusual odors coming from the instrument, immediately turn off the power and unplug the power cord. Also, turn off the power to the target device that are connected to the output terminals. Then, contact your nearest YOKOGAWA dealer.

#### Do Not Damage the Power Cord

Nothing should be placed on top of the power cord. The power cord should also be kept away from any heat sources. When removing the plug from the power outlet, do not pull on the cord. Pull from the plug. If the power cord is damaged or if you are using the instrument in a location where the power supply specifications are different, purchase a power cord that matches the specifications of the region that the instrument will be used in.

#### Correct the Problem If Output Is Forcibly Turned Off

If an abnormality is detected in the internal circuit due to a voltage or current overloading, voltage or current output oscillation, and so on, the 2558A will turn off the output and display a warning message (No. 031 to 035) on the output display.

In the case of voltage output, remove the cause of the problem, such as the external load, and turn the output on again.

In the case of current output, remove the cause of the problem, such as the external load, short the current terminals, and turn the output on again.

If the output still turns off after you have corrected the problem, the 2558A may be malfunctioning. Contact your nearest YOKOGAWA dealer.

#### Turn the Power Switch Off If Overheat is Detected

If internal overheating is detected due to a fan malfunction, and so on, the 2558A will turn off the output, display an error code (No. 901 to 903), and beep intermittently. If this happens, immediately turn the power switch off. Check that the inlet or outlet holes for the cooling fan are not blocked and that there is adequate space around the 2558A. Check for and remove any foreign objects that are caught in the filter on the rear panel. If the same error code appears when you turn the power switch on after waiting at least an hour, the 2558A may be malfunctioning. Contact your nearest YOKOGAWA dealer.

#### Operating Environment and Conditions

This instrument complies with the EMC standard under specific operating environment and operating conditions. If the installation, wiring, and so on are not appropriate, the compliance conditions of the EMC standard may not be met. In such cases, the user will be required to take appropriate measures.

### General Handling Precautions

#### Do Not Place Objects on Top of the Instrument

Never place other instruments or any objects containing water on top of it. Doing so may damage the instrument. For details on stacking the 2558A, see section 3.2.

#### Keep Electrically Charged Objects Away from the Instrument

Keep electrically charged objects away from the input and output terminals. They may damage the internal circuitry.

#### Unplug during Extended Non-Use

Turn off the instrument and remove the power cord from the outlet.

#### When Carrying the Instrument

Use two people to carry this instrument. Firmly hold the handles on the side of the case. The instrument weighs approximately 20 kg (the center of gravity is somewhat toward the back).

Be careful of injury.

In addition, be sure to turn off the power switch and remove the power cord and other connected cables before carrying the instrument.

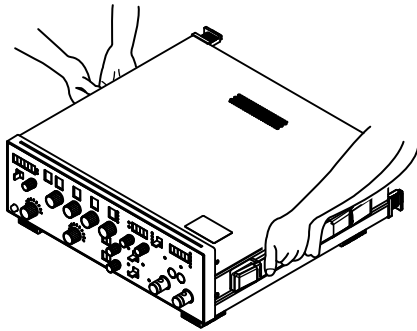

#### When Cleaning the Instrument

When cleaning the case or the operation panel, turn the instrument and remove the instrument's power cord from the outlet. Then, wipe the instrument lightly with a clean dry cloth. Do not use chemicals such as benzene or thinner. Doing so may cause discoloring and deformation.

## 3.2 Installing the Instrument

### WARNING

- Do not install the instrument outdoors or in locations subject to rain or water.
- Install the instrument so that you can immediately remove the power cord if an abnormal or dangerous condition occurs.

### CAUTION

If you block the outlet holes on the top and bottom or the inlet holes on the rear of the instrument, the instrument will become hot and may break down.

#### French

### AVERTISSEMENT

- Ne pas installer l'instrument à l'extérieur ou dans des lieux exposés à la pluie ou à l'eau.
- Installer l'instrument de manière à pouvoir immédiatement le débrancher du secteur en cas de fonctionnement anormal ou dangereux.

### ATTENTION

Si vous bloquez les orifices de sortie sur le dessus ou le dessous de l'équipement ou les orifices d'entrée à l'arrière de l'équipement, ce dernier s'échauffe et risque de tomber en panne.

## Installation Conditions

Install the instrument in a place that meets the following conditions.

### Well-Ventilated Location

Outlet holes are located on the top and bottom of the instrument. There are also inlet holes on the rear. To prevent internal overheating, allow for enough space around the instrument (see the figure below), and do not block the inlet and outlet holes.

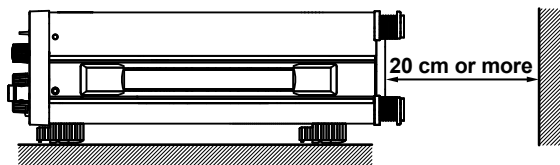

When connecting cables, allow for enough space, above and beyond the space shown in the figure above, to carry out the procedure.

#### Ambient temperature and humidity

Ambient temperature	5°C to 40°C
Ambient humidity	20% RH to 80% RH (no condensation)

## 3.2 Installing the Instrument

---

### Note

Condensation may form when the instrument is moved from a low temperature or humidity environment to a high temperature or humidity environment, or when there is a sudden change in temperature. In such cases, before you use the instrument, allow it to adjust to the surrounding temperature for at least an hour.

If you transport the instrument in its packing box, to prevent condensation, allow it to adjust to the new ambient temperature for at least an hour before taking it out of the box.

---

## Installation Position

### Desktop

Install the instrument on a stable surface that is level in all directions and that is not slippery.

The supplied rubber stoppers can be attached to the feet at the rear of the instrument to prevent the instrument from sliding. You can install the instrument in a tilted position using the movable legs.

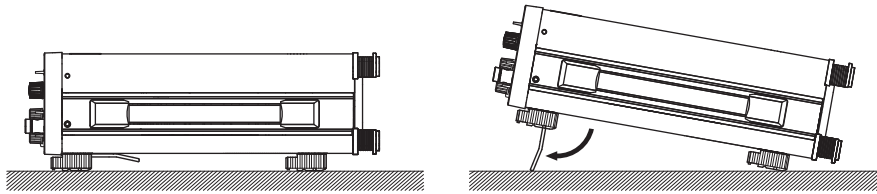

### WARNING

- Do not adjust the movable legs in an unstable condition.
  - Do not place the instrument in any position other than those shown in the above figures.
  - Do not stack the instruments with the movable legs pulled out.
  - Only one instrument can be stacked on top of another. Do not stack multiple instruments on top of one instrument.
- 

### French

---

### AVERTISSEMENT

- Ne pas manipuler les pieds escamotables lorsque l'instrument est instable.
  - Ne pas placer l'instrument dans des positions autres celles indiquées ci-dessus.
  - Ne pas empiler des instruments lorsque les pieds escamotables sont sortis.
  - Seul un instrument peut être empilé sur un autre instrument. Ne pas empiler plusieurs instruments les uns sur les autres.
- 

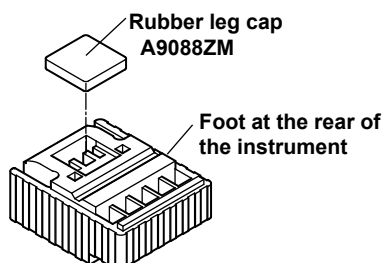

### Note

If you attach the front rubber leg cap, you will not be able to stack the 2558A.

---

### Rack Mounting

To rack-mount the instrument, use the separately sold rack mount kit.

Item	Model
Model 751535-E3 Rack mount kit (for mounting one 2558A on an EIA standard rack)	751535-E3
Model 751535-J3 Rack mount kit (for mounting one 2558A on a JIS standard rack)	751535-J3

An outline of the mounting procedure is given below. For detailed instructions, see the manual that is included with the rack mount kit.

1. Remove the handles from both sides of the instrument.
2. Remove the four feet from the bottom of the instrument.
3. Remove the four seals covering the rack mount attachment holes. The holes are on the sides of the instrument near the front.
4. Place seals over the feet and handle attachment holes.
5. Attach the rack mount kit to the instrument.
6. Mount the instrument on a rack.

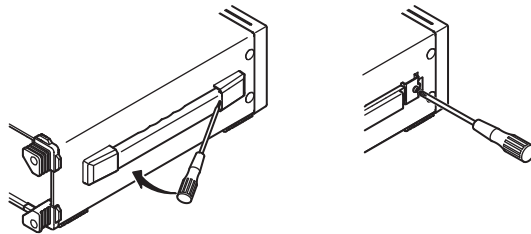

How to remove a handle cover

#### Note

- When rack-mounting the instrument, allow at least 5cm of space around the top panel outlet holes to prevent internal heating. Allow at least 20 cm around the rear panel inlet holes.
- Make sure to provide adequate support from the bottom of the instrument. The support should not block the inlet and outlet holes.
- Store the removed parts in a safe place.
- When rack-mounting the instrument, remove the feet from the rear of the instrument if they are coming into contact with the rack and are thus preventing you from rack-mounting the instrument. After you have rack-mounted the instrument, re-attach the feet to the rear of the instrument.
- Dials and current terminals protrude further out than the front panel position. Make sure you do not hit them against the rack when mounting the instrument.

### Do Not Install the Instrument in the Following Kinds of Places

- In direct sunlight or near heat sources
- In an environment with excessive amounts of soot, steam, dust, or corrosive gas
- Near strong magnetic field sources
- Near high-voltage equipment or power lines
- In an environment that is subject to large levels of mechanical vibration
- On an unstable surface
- Outdoors or in locations subject to rain or water

---

## 3.3 Connecting to the Power Supply

### Before Connecting the Power Supply

Make sure to follow the warnings below when connecting the power supply. Failure to do so may cause electric shock or damage to the instrument.



#### WARNING

- Make sure that the power supply voltage matches the instrument's rated supply voltage and that it does not exceed the maximum voltage range of the power cord to use.
- Connect the power cord after checking that the power switch of the instrument is turned off.
- To prevent electric shock or fire, use the power cord for the instrument.
- Make sure to connect protective earth grounding to prevent electric shock. Connect the power cord to a three-prong power outlet with a protective earth terminal.
- Do not use an ungrounded extension cord. If you do, the instrument will not be grounded.
- If there is no AC outlet that is compatible with the power cord that you will be using and you cannot ground the instrument, do not use the instrument.

#### French



#### AVERTISSEMENT

- Assurez-vous que la tension d'alimentation correspond à la tension d'alimentation nominale de l'appareil et qu'elle ne dépasse pas la plage de tension maximale du cordon d'alimentation à utiliser.
- Brancher le cordon d'alimentation après avoir vérifié que l'interrupteur d'alimentation de l'instrument est sur OFF.
- Pour éviter tout risque de choc électrique, utiliser exclusivement le cordon d'alimentation prévu pour cet instrument.
- Relier l'instrument à la terre pour éviter tout risque de choc électrique. Brancher le cordon d'alimentation sur une prise de courant à trois plots reliée à la terre.
- Toujours utiliser une rallonge avec broche de mise à la terre, à défaut de quoi l'instrument ne serait pas relié à la terre.
- Si une sortie CA conforme au câble d'alimentation fourni n'est pas disponible et que vous ne pouvez pas relier l'instrument à la terre, ne l'utilisez pas.



## Connecting the Power Cord

1. Check that the power switch (POWER) on the front panel of the instrument is turned off.
2. Connect the power cord plug to the power inlet on the rear panel.
3. Connect the other end of the cord to an outlet that meets the following conditions. Use a grounded three-prong outlet.

Item	
Rated supply voltage*	100 VAC to 120 VAC, 200 VAC to 240 VAC
Permitted supply voltage range	90 VAC to 132 VAC, 180 VAC to 264 VAC
Rated supply frequency	50 Hz/60 Hz
Permitted supply frequency range	48 Hz to 63 Hz
Maximum power consumption	Approx. 200 VA

\* This instrument can use a 100 V or a 200 V power supply. The maximum rated voltage differs according to the type of power cord. Check that the voltage supplied to the instrument is less than or equal to the maximum rated voltage of the power cord that you will be using before use.

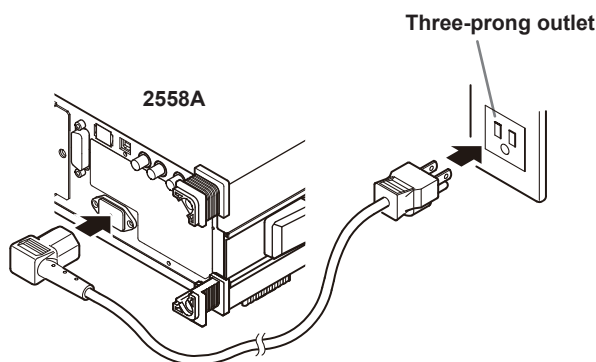

## 3.4 Turning On and Off the Power Switch

### Before Turning On the Power, Check That:

- The instrument is installed properly. → section 3.2, “Installing the Instrument”
- The power cord is connected properly → see section 3.3, “Connecting to the Power Supply”

### Power Switch Location

The power switch is located in the lower left of the front panel.

### Turning On and Off the Power Switch

The power switch is a push button. Press the button once to turn the instrument on and press it again to turn the instrument off.

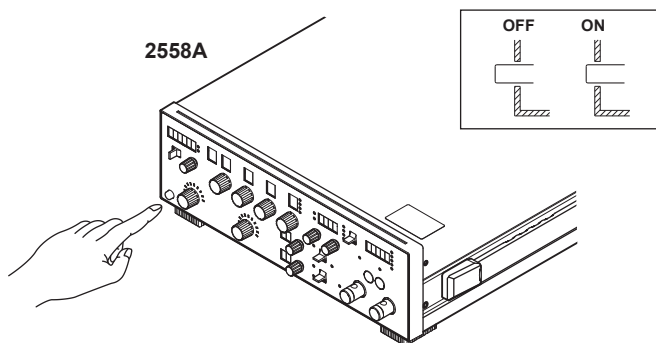

### Operations Performed When the Power Is Turned On

When the power switch is turned on, a self-test starts automatically. When the self-test completes successfully, the instrument will be configured with the settings that were in use immediately before the power was turned off. For the settings that are retained even when the power is turned off, see appendix 5.

Before using the instrument, make sure that the self-test completes successfully.

#### Note

- After turning the power switch off, wait at least 10 seconds before you turn it on again.

#### When the Power-on Operation Does Not Finish Normally

- If the instrument does not operate as described above when the power switch is turned on, turn the power switch off, and then:
  - Check that the power cord is securely connected.
  - Check that the correct voltage is coming to the power outlet. → section 3.3, “Connecting the Power Supply”
  - Initialize the instrument. See section 8.3.
- If the instrument still does not work properly, contact your nearest YOKOGAWA dealer for repairs.
- If an error code is displayed, check the information in section 15.2, and take the appropriate actions.

### To Generate Accurate Output

- Allow the instrument to warm up for at least 30 minutes after turning on the power switch. If the instrument has been stored in a hot-temperature, high-humidity environment, warm up the instrument for at least a day before starting use.
- Keep the OUTPUT switch turned off during warm-up. After warm-up is complete, turn the OUTPUT switch on.

## Operations Performed When the Power Is Turned Off

After the power is turned off, the instrument stores the setup parameters in its memory before shutting down. The same is true when the power cord is disconnected from the outlet. The next time the power is turned on, the instrument powers up using the stored settings (for the settings that are stored, see appendix 5).

---

### **CAUTION**

Do not turn off the power when the instrument's output is turned on. Doing so can damage the 2558A. It can also cause damage to the devices connected to the 2558A. Turn the output off first, and then turn off the power.

---

### **French**

---

### **ATTENTION**

Ne pas tourner l'appareil hors tension quand la sortie de l'instrument est activée. Cela peut endommager le 2558A. Il peut aussi endommager les appareils connectés à la 2558A. Tourner la sortie première et la coupez l'alimentation.

---

## 3.5 Wiring Precautions



### WARNING

This product generates high voltage. Be careful of electric shock and electric discharge. To prevent electric shock, remove rings, watches, and other metallic accessories and jewelry before wiring.

#### Before Wiring

- Ground the instrument before connecting the instrument to the target device. The power cord to use is a three-prong type power cord. Insert the power cord into a grounded three-prong outlet.
- Be sure to turn off the output before connecting or disconnecting the target device.
- To prevent damage that would occur if the OUTPUT switch is flipped inadvertently during wiring, check that the minimum and maximum values on the scale are all set to 0 (zero).
- If a large capacitive load or oscillating circuit is connected to the voltage terminals, the output may oscillate and cause high voltage to appear at the voltage output terminals. If the output oscillates, turn it off immediately.
- If a large inductive load or oscillating circuit is connected to the current terminals, the output may oscillate and cause high voltage to appear at the current output terminals. If the output oscillates, turn it off immediately.

#### Wiring

- Make sure to fasten the output terminal screws securely so that cables do not come loose.
- Only use cables whose conductive parts are covered for connecting to the voltage output terminals. Exposed conductive parts can lead to electric shock.
- Do not use cables whose conductive parts are exposed due to tears in the insulation or broken cables as they may lead to a short circuit or electric shock.
- For connecting to terminals used for voltage output, only use lead wires that have safety terminals that cover their conductive parts. Using a terminal with bare conductive parts (such as a banana plug) can be dangerous if the terminal comes loose.
- Do not use the fork terminal adapter 758921 when outputting from the voltage output terminals. Due to the structure of the product, it is possible to touch the metal parts of the fork terminal adapter 758921. Be careful as this constitutes an electric shock hazard.
- Use the accessories of this product within the rated range of each accessory (see page iv). When using several accessories together, use them within the specification range of the accessory with the lowest rating.

#### Before output (before turning on the output), check that:

- Cables are connected to the instrument's output terminals correctly.
- Cables are connected to the target device correctly.  
Cables are not shorted because of wiring errors, broken insulation of lead wires, unintended contact with conductive parts, and so on.
- The cables are fastened firmly to the terminals.
- There are no problems with the terminals, such as the presence of foreign substances.

**During output (do not touch the terminals or the connected cables when this instrument is on), check that:**

- There no problems with the terminals, such as the presence of foreign substances.
- The terminals are not abnormally hot.  
The terminal connections may become loose over time. If this happens, heat may be generated due to changes in contact resistance. Periodically check that the cables are firmly connected to the terminals. Be sure to turn off both this instrument and the target device before you check the connections.
- If the voltage output exceeds 33 Vrms or 46.7 Vpeak, there is a danger of electric shock due to the high voltage. Be extremely careful.

**After output (immediately after the output is turned off)**

After you output a voltage or current, voltage may remain for some time even after you turn the output off. This residual voltage may lead to electric shock. Do not touch the terminals immediately after you turn the output off. The amount of time that voltage remains varies depending on the target device.

**CAUTION**

- Use cables that have adequate margins of withstand voltage and current capacity with respect to the voltage or current to be sourced.  
Example: To use a current of 20 A, use copper wires that have a conductive cross-sectional area of 4 mm<sup>2</sup> or greater.
- When outputting current, do not open the current terminals. Doing so will trigger a protection feature, and the output will turn off.
- When outputting voltage, do not short the voltage terminals. Doing so will trigger a protection feature, and the output will turn off.
- Use twisted-pair cables to prevent oscillation.
- May cause abnormal voltage output when turn off 2558A. 2558A output turned OFF and then turn off 2558A.
- Do not connect an external voltage source or current source with a frequency or phase different from the 2558A setting to the output terminals. Doing so may damage the 2558A.

### French



## AVERTISSEMENT

Ce produit génère une tension élevée. Faites attention au choc électrique et à la décharge électrique. Afin d'éviter tout choc électrique, retirer les bagues, les montres et autres accessoires métalliques ainsi que les bijoux avant le câblage.

#### Avant le câblage

- Relier l'instrument à la terre avant de le brancher sur l'appareil cible. Le cordon d'alimentation à utiliser est un cordon d'alimentation à trois broches. Brancher le cordon d'alimentation sur une prise de courant à trois plots mise à la terre.
- Toujours mettre hors tension avant de brancher ou de débrancher l'appareil cible.
- Afin d'éviter tout endommagement susceptible de se produire si l'interrupteur OUTPUT (Sortie) est actionné accidentellement lors du câblage, vérifiez que les valeurs minimales et maximales sur l'échelle sont toutes définies sur 0 (zéro).
- En cas de branchement d'une importante charge capacitive ou de circuit oscillant sur les bornes de tension, la sortie peut osciller et entraîner l'alimentation d'une tension élevée sur les bornes de sortie de tension. En cas d'oscillation de la sortie, mettre immédiatement hors tension.
- En cas de branchement d'une importante charge inductive ou de circuit oscillant sur les bornes de courant, la sortie peut osciller et entraîner l'alimentation d'une tension élevée sur les bornes de sortie de tension. En cas d'oscillation de la sortie, mettre immédiatement hors tension.

#### Câblage

- Serrez bien les vis des bornes de sortie de telle sorte que les câbles en plomb ne se détachent pas.
- Utiliser seulement des câbles dont les pièces conductrices sont recouvertes pour un raccordement aux bornes de sortie de tension. Des pièces conductrices exposées peuvent entraîner une choc électrique.
- N'utilisez pas de câble de plomb dont les pièces conductrices sont exposées, en raison de traces d'usure de l'isolation ou de câbles cassés, car ceci risque d'entraîner un court-circuit ou un choc électrique.
- Pour le raccordement à des bornes utilisées pour une sortie de tension, utiliser uniquement des câbles en plomb présentant des bornes de sécurité recouvrant leurs pièces conductrices. L'utilisation d'une borne dotée d'éléments conducteurs nus (comme une fiche banane) serait dangereuse si la borne venait à se détacher.
- Ne pas utiliser l'adaptateur 758921 à la sortie des bornes de sortie de tension. Compte tenu de la structure du produit, il est possible de toucher les pièces métalliques de l'adaptateur de borne à fourche 758921. Procédez avec soin, car cette opération présente un risque de choc électrique.
- Utilisez les accessoires de ce produit en fonction des valeurs nominales de chacun (reportez-vous à la page iv). Lorsque vous employez plusieurs accessoires en même temps, utilisez les valeurs de l'accessoire ayant les valeurs nominales les plus faibles.

#### Avant le sortie (avant la mise sous tension), vérifier que :

- Les câbles en plomb sont correctement raccordés aux bornes de sortie de l'équipement.
- Les câbles en plomb sont correctement raccordés à l'appareil cible.  
Les câbles en plomb ne sont pas court-circuités en raison d'erreurs de câblage, d'absence d'isolation des câbles en plomb, de contact accidentel avec des pièces conductrices etc.
- Les câbles sont fermement vissés sur les bornes.
- Les bornes ne présentent aucune anomalie, telle la présence de corps étrangers.

**Pendant la sortie (ne pas toucher les bornes ni les câbles branchés lorsque l'instrument est sous tension), vérifier que :**

- Les bornes ne présentent aucune anomalie, telle la présence de corps étrangers.
- Les bornes ne chauffent pas anormalement.  
Les raccordements de bornes risquent de se détacher dans le temps. Le cas échéant, une chaleur peut être générée suite aux changements de résistance au contact. Vérifiez régulièrement que les câbles en plomb sont bien raccordés aux bornes. Éteignez bien à la fois cet équipement et l'appareil cible avant de vérifier les raccordements.
- Si la sortie de tension dépasse 33 Vrms ou 46,7 Vpic, il existe un risque de choc électrique dû à la tension élevée. Soyez extrêmement attentif.

**Après la sortie (tout de suite après la mise hors tension)**

Une fois une tension ou un courant obtenu(e), la tension peut rester un certain temps, même après la mise hors tension. Cette tension résiduelle peut entraîner un choc électrique. Ne touchez pas immédiatement les bornes après la mise hors tension. La durée pendant laquelle la tension reste varie en fonction de l'appareil cible.

**ATTENTION**

- Utiliser des câbles qui ont suffisamment de marge de tension de maintien ou de capacité de courant par rapport à la tension ou au courant à émettre.  
Exemple : Pour utiliser un courant de 20 A, utilisez des câbles en cuivre présentant une section de coupe transversale conductrice de 4 mm<sup>2</sup> ou plus.
- Lorsqu'un courant est délivré, n'ouvrez pas les bornes de courant. Ceci risquerait de déclencher une option de protection et de couper la sortie.
- Lorsqu'une tension est délivrée, ne court-circuitez pas les bornes de tension. Ceci risquerait de déclencher une option de protection et de couper la sortie.
- Utiliser une paire torsadée de câbles pour éviter l'oscillation.
- Avec des gammes de thermocouples, ne pas alimenter en tension externe, ni courant. En outre, ne connectez pas à une charge capacitive chargée. Cela pourrait endommager le diviseur de tension à l'intérieur du 2558A.
- Peut cause de tension anormale de sortie quand désactiver 2560A. 2560A sortie éteint et puis désactiver le 2558A.
- Aux bornes de sortie, ne connectez pas une source de tension externe ou une source de courant avec une fréquence ou une phase différente du réglage du 2558A. Cela pourrait endommager le 2558A.

## 3.6 Connecting Cables

Connect cables from the target device to the voltage or current terminals.

To prevent electric shock and damage to the instrument, follow the warnings given in section 3.5, "Wiring Precautions."

### Voltage Terminals

The terminals are safety banana jacks (female) that are 4 mm in diameter.

Only insert safety terminals whose conductive parts are not exposed into the voltage terminals.

#### Wiring Example for Calibrating a Voltmeter or Frequency Meter

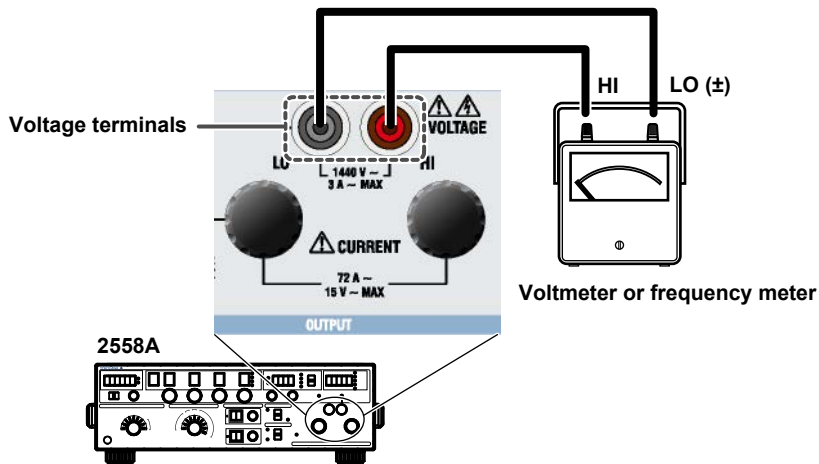

### Current Terminals

The terminals are binding posts. The fastening screws are M6. Either wind the wire around the screw or pass a crimped terminal through the screw hole, and then tighten firmly with the terminal knob. The terminal or knob may break if you apply excessive torque.

#### Wiring Example for Calibrating an Ammeter

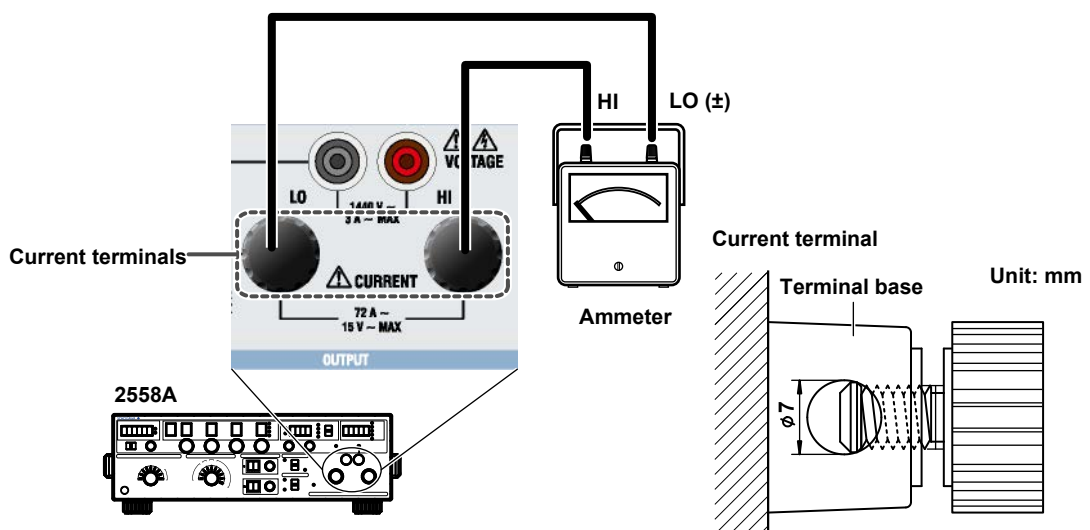





### CAUTION

- Confirm that no foreign materials are caught in the contact area between the current terminal and the cable.
- Periodically confirm that the current terminals are not loose and that there are no foreign materials caught in the contact area between the current terminal and the cable.

### French



### ATTENTION

- Vérifier l'absence de corps étrangers dans la zone de contact entre la borne de courant et le câble.
- Vérifier régulièrement que les bornes de courant sont bien serrées et qu'il n'y a aucun corps étranger dans la zone de contact entre la borne de courant et le câble.

### Connecting to a Round Crimped Terminal

To connect a cable with a round crimped terminal to a current terminal, follow the procedure below.

1. Turn the current terminal knob to remove it.

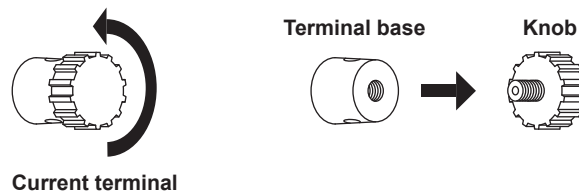

2. Insert the screw of the knob into the crimped terminal, and then tighten firmly with the terminal knob. The terminal or knob may break if you apply excessive torque.

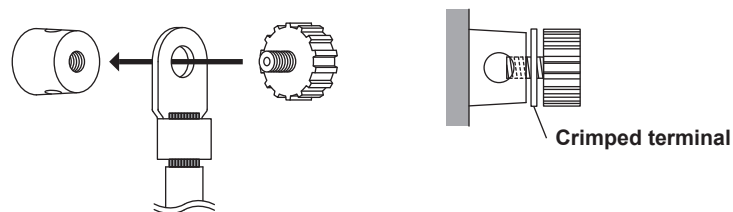

# 4.1 SETUP Menu Tree Structure

The SETUP menu appears when you turn the FREQUENCY dial and select SETUP. This section describes the types and contents of the menu items using a tree diagram.

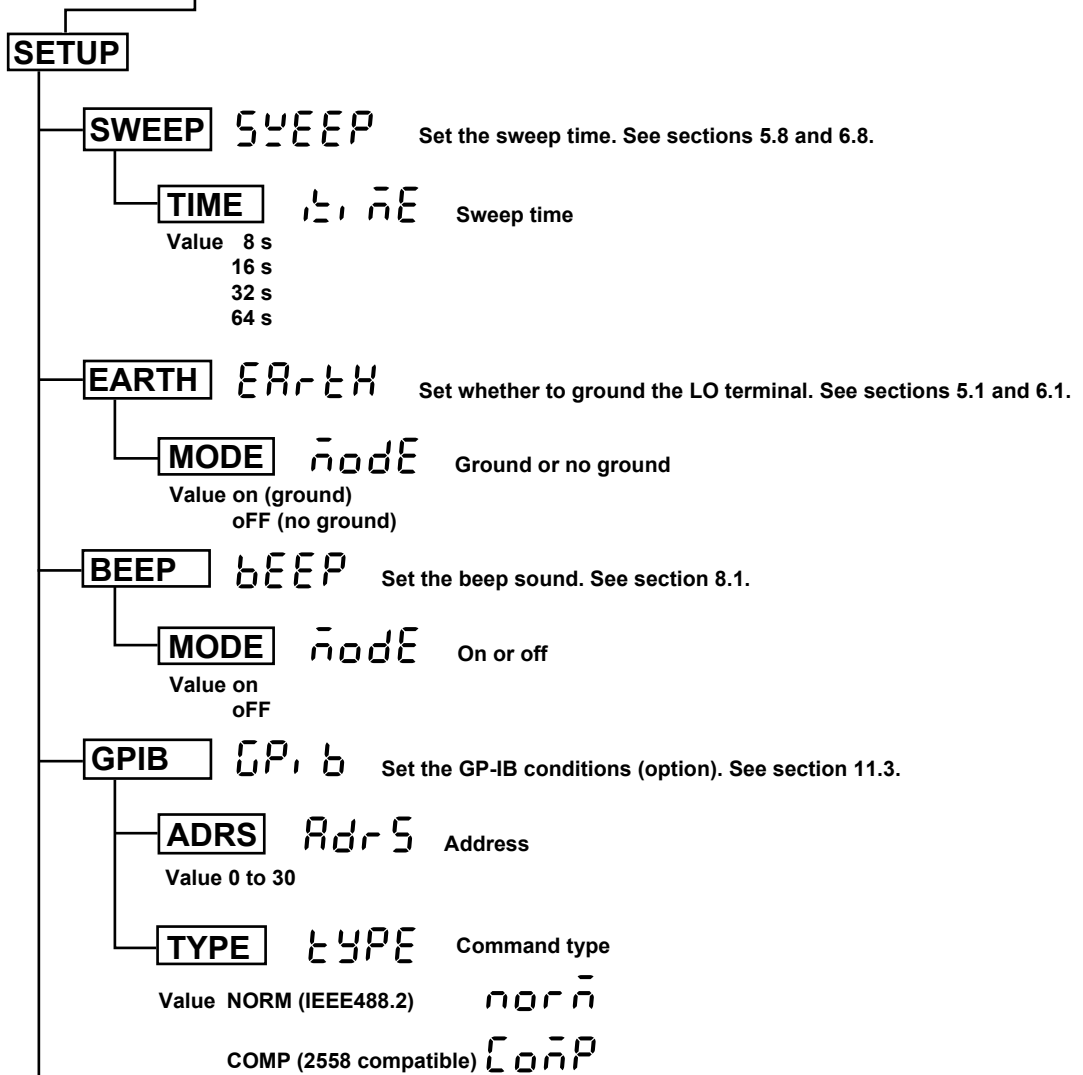
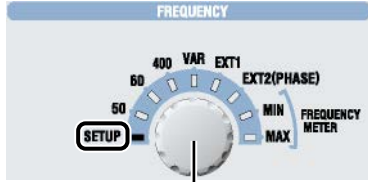

To LAN on the next page

4.1 SETUP Menu Tree Structure

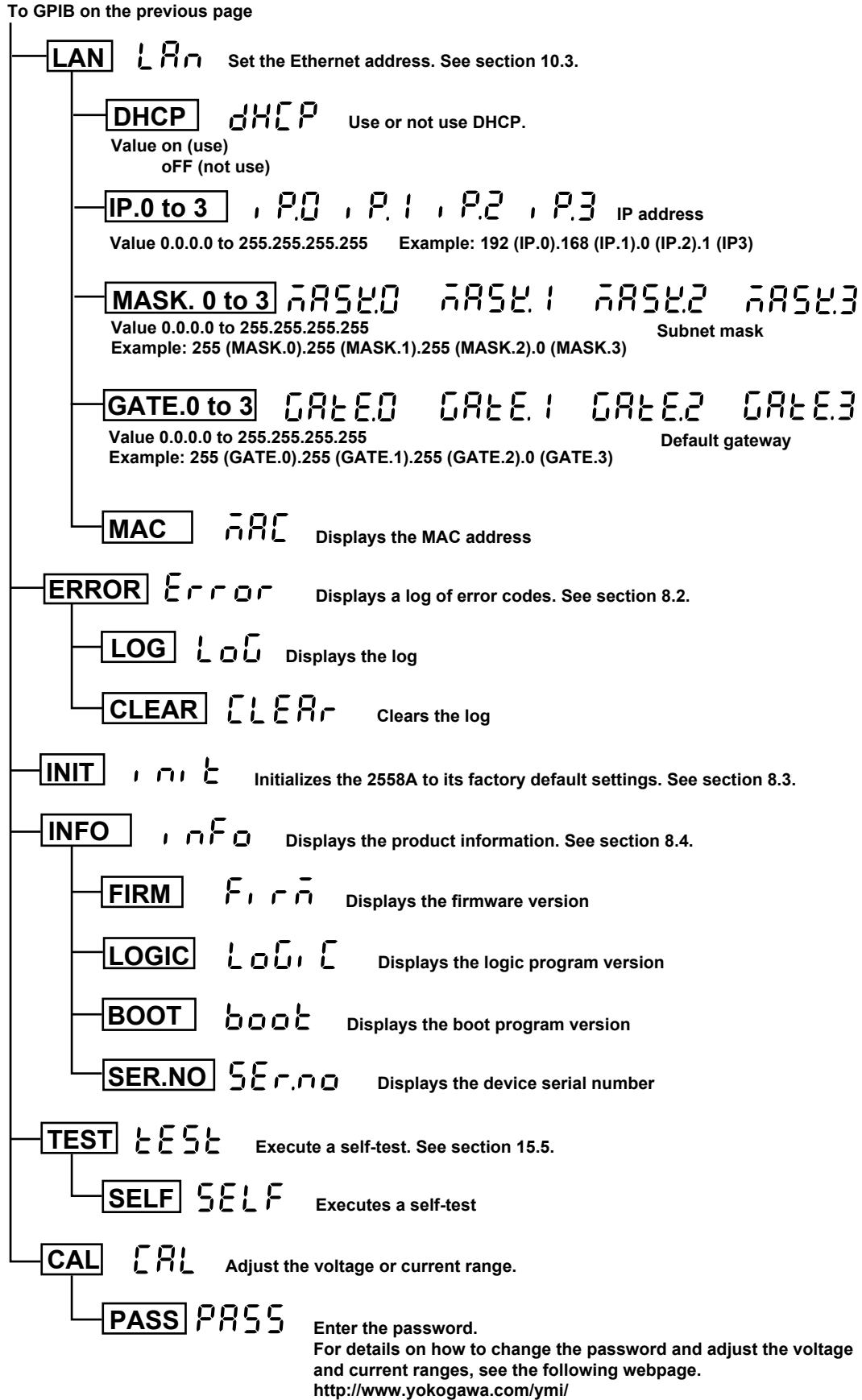

## 4.2 SETUP Menu and Dial Assignments

When the SETUP menu is displayed, only the dials and switches for selecting menu and display items can be used. You cannot use the other dials and switches. Displays that are not used in the SETUP menu turn off.

### Select the SETUP Menu.

Displays the SETUP menu (the first level in the tree diagram of section 4.1) Turn the VARIABLE dial to select a menu.

Example: SWEEP, LAN, INFO

### Setup menu item

Displays a SETUP menu item (the second level in the tree diagram of section 4.1) Turn a main setting dial to select an item.

Example: In the case of LAN, select DHCP, IP, MASK, etc.

### The values of a SETUP menu item

Displays the value or information of a SETUP menu item. See section 4.3.

If there is a value, turn a deviation dial to set the value.

Flip the PRESET switch up or down to confirm the selected value.

When the value has not been confirmed, all the PRESET LEDs light. When

it has been confirmed, all the PRESET LEDs turn off.

Example: ON/OFF, a value, etc.

### Auxiliary information display

Displays the auxiliary information of a SETUP menu item when available

Example: Error code in the error log

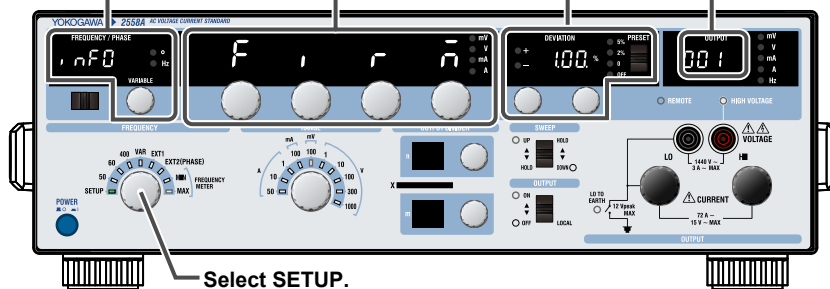

## How SETUP Menu Items Are Displayed

### When There Are No Items (INIT)

Items are not displayed.

### When There Is a Single Item (SWEEP, BEEP, etc.)

The appropriate item is displayed. You do not use the main setting dials.

### When There Are Multiple Items

Turn a main setting dial to display the appropriate item. You can use any of the main setting dials.

### When a Single Item Has Four Sub Items (LAN IP, MASK, etc.)

Turn the right-most main setting dial to display the four sub items of all items one at a time.

Example: DHCP→IP.0→IP.1→IP.2→IP.3→MASK.0→MASK.1. . .

Turn any of the other three main setting dials to display one of the four sub items of all items one at a time.

Example: DHCP→IP.0→MASK.0→GATE.0. . .

---

## 4.3 Entering and Displaying Values

The following methods are available in entering and displaying values depending on the SETUP menu item.

- Selecting parameters
- Entering values
- Displaying the log
- Executing a function

### Selecting Parameters

Turn a deviation dial to select the parameter.

You can use either deviation dial.

Example: ON/OFF, 8 s/16 s/32 s/64 s, etc.

### Entering Values

Turn the deviation dials to enter a value.

Turn the deviation dial 1 to enter the tens digit.

Turn the deviation dial 2 to enter the ones digit.

The dial 2 changes the value by 1.

The dial 1 changes the value by 1 or 2 depending on the item.

Carrying over and borrowing occurs automatically. When the upper or lower limit is reached, the value will no longer change even if you turn the dial further.

### Displaying the Log

The availability of logging information and a number indicating the order of logging information are displayed.

The logging information is indicated on the auxiliary information display (OUTPUT display).

If logging information is available, turn the deviation dial to switch the display.

Example: NO (none), 3.10 (displaying the third one out of 10)

### Executing a Function

For items that represent functions that are to be executed, such as INIT and TEST, EXEC is displayed.

Depending on the item, executing the function will initialize the settings or clear the logging information.

You cannot undo it, so make sure it is okay to execute the function in advance.

EXEC display **EXEC**

# 5.1 Selecting Whether to Ground the LO Terminal (COMMON Terminal)

## Procedure

### CAUTION

If the target device is not grounded, ground the LO terminal (ON). If it is not grounded (OFF), electric shock may occur.

### French

### ATTENTION

Si le dispositif cible n'est pas relié à la terre, relier la borne LO (ON) à la terre. Sans mise à la terre (OFF), il existe un risque d'électrocution.

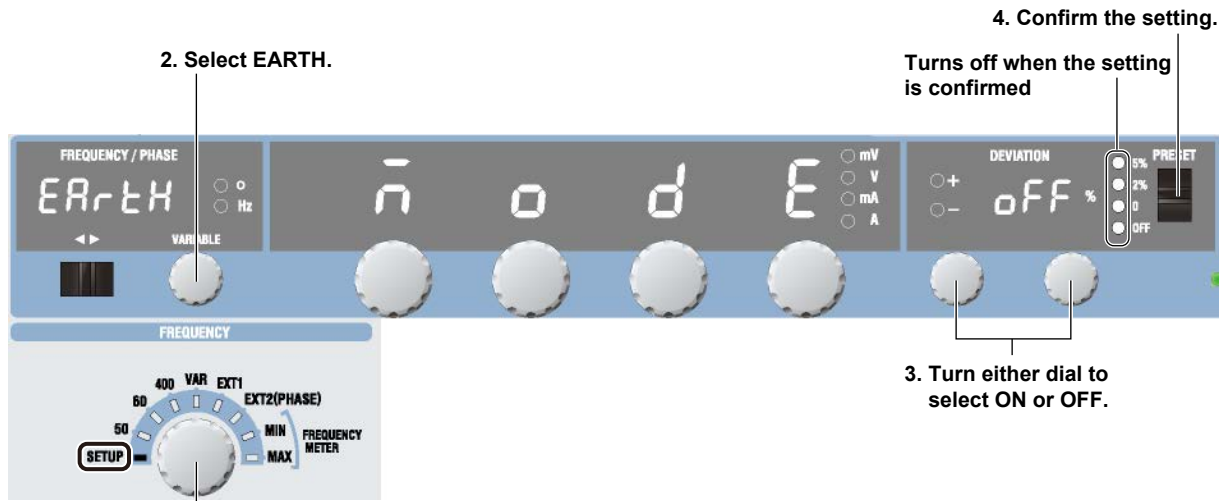

#### 1. Select SETUP.

1. Turn the **FREQUENCY** dial to select SETUP.  
The indicator corresponding to the selected SETUP range illuminates, and the frequency/phase angle display area shows the SETUP menu.
2. Turn the **VARIABLE** dial to select EARTH.
3. Turn the **deviation dial** to select ON or OFF.  
When you change the setting, all four preset indicators will illuminate.
4. Flip the **PRESET** switch up or down.  
The setting is confirmed, and all the preset indicator turn off.  
When you turn it on, the LO TO EARTH indicator will illuminate.

## 5.1 Selecting Whether to Ground the LO Terminal (COMMON Terminal)

---

### Explanation

Set whether to ground the LO terminal of the voltage and current output.

ON: The LO terminal is grounded.

OFF: The LO terminal is not grounded.

If one of the terminals on the output target is grounded to avoid errors caused by a ground loop, connect the LO terminal of the 2558A to the terminal that is grounded, and set the LO terminal to “no ground” (OFF). If the target device is not grounded, ground the LO terminal (ON). If the LO terminals of multiple 2558As are connected in parallel, ground the LO terminal of a single 2558A (set to ON) and leave the others ungrounded (set to OFF).

### <<Command Mnemonic>>

:SYSTem:EARTh <Boolean>

## 5.2 Setting the Frequency

### Procedure

#### Selecting a Fixed Frequency (50 Hz, 60 Hz, or 400 Hz)

Turn the **FREQUENCY** dial to set the output frequency to 50, 60, or 400 (Hz).

The indicator corresponding to the selected frequency and the Hz unit indicator illuminate. In addition, the selected frequency is displayed.

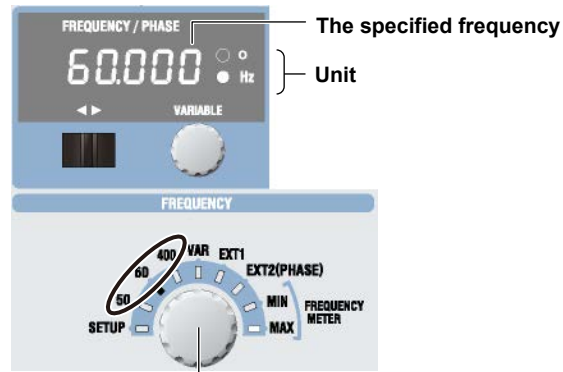

Select 50, 60, or 400 (Hz).

#### Selecting a Specific Frequency (VAR)

1. Turn the **FREQUENCY** dial to select VAR.

The VAR range indicator and the Hz unit indicator illuminate. In addition, the specified frequency is displayed.

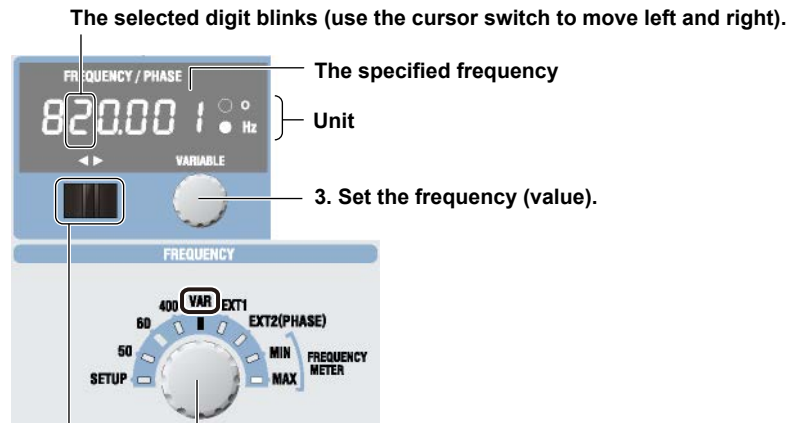

The selected digit blinks (use the cursor switch to move left and right).

1. Select VAR.
2. Select the digit you want to set.

2. Use the **cursor** switch (◀▶) to select the digit you want to set. The selected digit blinks.
3. Turn the **VARIABLE** dial to set the value.



## 5.2 Setting the Frequency

### Selecting External Oscillator EXT1

Perform this procedure to obtain an output that is synchronized to an external oscillator. Connect the oscillator to the I side of the external signal input terminal.

Turn the **FREQUENCY** dial to select EXT1.

The EXT1 range indicator and the Hz unit indicator illuminate. In addition, the external oscillator frequency is displayed.

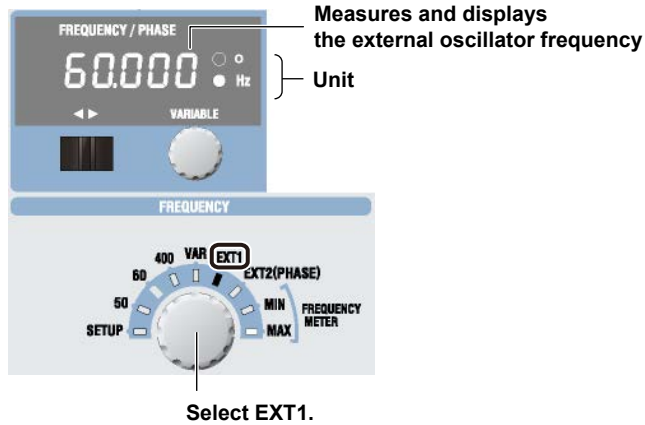

#### Note

If an external oscillator is not connected, the frequency display shows OVER, and the voltage or current output is turned off.

### Selecting External Oscillator EXT2

Perform this procedure to obtain an output that is synchronized to another 2558A. Connect the signals to the external input terminals I and Q. With this setting, you can shift the 2558A output phase.

1. Turn the **FREQUENCY** dial to select EXT2 (PHASE).

The EXT2(PHASE) range indicator and the degree (°) indicator illuminate. In addition, the shift phase angle (relative value) is displayed.

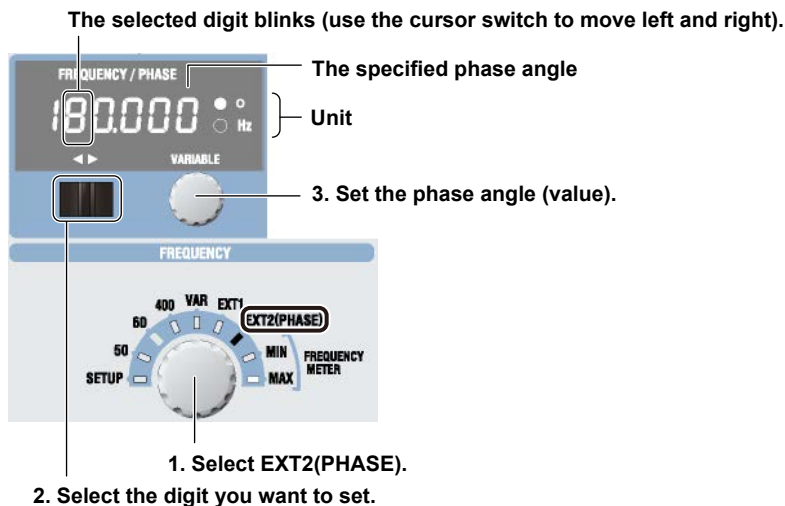

2. Use the **cursor** switch (◀▶) to select the digit you want to set. The selected digit blinks.
3. Turn the **VARIABLE** dial to set the value.

#### Note

- If an external oscillator is not connected, the voltage or current output is turned off.
- For details on the external input terminal, see section 7.1.

**Explanation****Fixed Frequency (50 Hz, 60 Hz, or 400 Hz)**

The 2558A generates AC voltage or current at a fixed frequency.

If the output frequency of the 2558A and the frequency of the commercial power line are close, the output may fluctuate due to the beat phenomenon. You can obtain stable output by setting the 2558A output frequency to 50 Hz when using a 60 Hz commercial power line and setting the 2558A output frequency to 60 Hz when using a 50 Hz commercial power line.

**Specific Frequency**

The 2558A generates AC voltage or current at a frequency of your choice in the range of 40 Hz to 1000 Hz. The resolution is 0.001 Hz.

**External Oscillator EXT1**

The 2558A generates AC voltage or current at the frequency of the signal received through external input terminal EXT1. The phase is the same as when EXT2 is selected and the phase is set to 180°.

Allowable frequency range: 40 Hz to 1000 Hz

**External Oscillator EXT2**

The 2558A generates AC voltage or current with the specified phase shift in reference to the two signals received through the external input terminals (I and Q).

Allowable frequency range: 40 Hz to 1000 Hz

Phase angle range: -180.000° to +359.999°; relative value in steps of 0.001°

If you turn the FREQUENCY dial when the output is on, the 2558A tries to maintain the voltage or current output, but the output may turn off due to the discontinuity when the internal oscillator and external oscillator switch or some other reason.

When the 2558A starts, the FREQUENCY dial setting that was used previously is restored, except for SETUP.

**<<Command Mnemonic>>**

```
:FREQUENCY:FUNCTION {50|60|400|VAR|EXT1|EXT2}
:FREQUENCY:INTERNAL:VARIABLE <Frequency>
:FREQUENCY:EXTERNAL:PHASE <Phase>
```

## 5.3 Selecting the Voltage or Current Range

### Procedure

Turn the **RANGE** dial to set the voltage or current range.  
The indicator for the selected range illuminates.

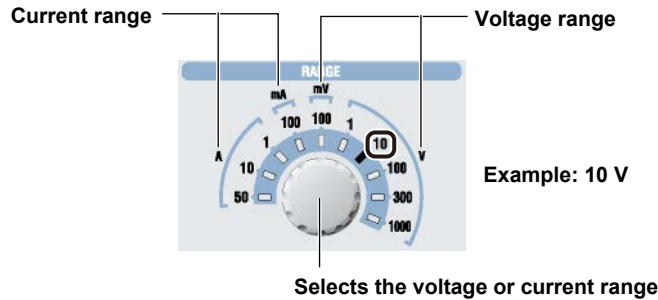

### Explanation

The selectable range and resolution vary depending on the specified range.  
For details on the function, see section 2.2.

#### Voltage Range

Range	Selectable range <sup>1</sup>	Resolution
100 mV	0 mV to 120.00 mV	0.01 mV
1 V	0 V to 1.2000 V	0.0001 V
10 V	0 V to 12.000 V	0.001 V
100 V	0 V to 120.00 V	0.01 V
300 V	0 V to 360.0 V	0.1 V
1000 V	0 V to 1200.0 V	0.1 V

<sup>1</sup> Generates 144% of the range when used with deviation (–20%)

#### Current Range

Range	Selectable range <sup>1</sup>	Resolution
100 mA	0 mA to 120.00 mA	0.01 mA
1 A	0 A to 1.2000 A	0.0001 A
10 A	0 A to 12.000 A	0.001 A
50 A	0 A to 60.00 A	0.01 A

<sup>1</sup> Generates 144% of the range when used with deviation (–20%)

If you select the 300 V or 1000 V range, the HIGH VOLTAGE indicator will illuminate even if the voltage or current output is off.

The voltage and current ranges are fixed. The 2558A does not have an auto range feature.

When the power is turned on, the setting that was used previously is restored.

If you change the voltage or current range when the output is on, the output automatically turns off.

The ratio of the main setting value to the voltage or current range is passed on to the main setting value even after you change the voltage or current range.

Example: If the main setting is 0.5 V (50%) at the 1 V voltage range and you change the voltage range to 10 V, the main setting value will be 5 V.

#### <<Command Mnemonic>>

```
:SOURce:FUNCTION {VOLTage|CURRent}
:SOURce:RANGe {<Voltage>|<Current>}
```

## 5.4 Main Voltage and Current Settings

### Procedure

Turn the **main setting** dial to set the voltage or current level to generate.  
The main setting display shows the voltage or current level.

#### Example of setting 100.00 V

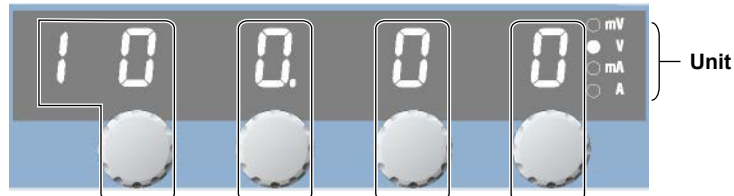

Use each dial to set the corresponding digit or digits, shown by the frames.  
Carrying over and borrowing occurs automatically within the selectable range.

### Explanation

#### Range

For details, see the explanation in section 5.3.

#### Maximum and Minimum Settings

Minimum: 0% of each range rating.

Maximum: 120% of each range rating.

For details on the accuracy specifications, see section 16.2.

You can control the main setting while the voltage or current is being output. If you set the voltage level to 150 V or higher, beeps will be generated. For details on how to turn the beeps on and off, see section 8.1.

The setting appears flush right within the display resolution range of each voltage or current range setting.

#### 1 V range



#### 300 V range



#### <<Command Mnemonic>>

```
:SOURCE:FUNCTION {VOLTage|CURRent}
```

```
:SOURCE:LEVel {<Current>|<Voltage>|MINimum|MAXimum}
```

## 5.5 Dividing the Output

### Procedure

1. Turn the **m** dial.  
The m display shows the denominator of the divider value (the number of divisions).
2. Turn the **n** dial.  
The n display shows the numerator of the divider value.

Divider value example:  $x \frac{1}{5}$

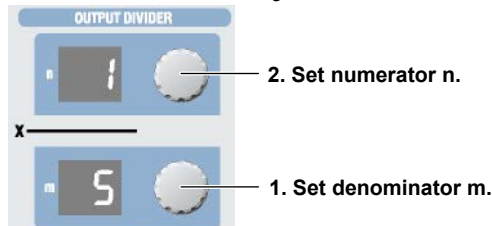

### Explanation

This feature divides the voltage or current level set with the main setting dials (main setting  $\times$  divider value).

The range for denominator m is 4 to 15.

The range for numerator n is 0 to m.

Turning the m dial resets numerator n to the denominator m value.

The n value cannot be set larger than the m value.

Setting a divider value does not affect the value shown on the main setting display.

When the power is turned on, denominator m that was used previously is restored. The numerator n is reset to the denominator m value.

For example, if 100.00 V is specified by the range and main setting, the voltage is divided as follows:

$$n/m = 0/5 : 0 \text{ V}$$

$$n/m = 1/5 : 20 \text{ V}$$

$$n/m = 2/5 : 40 \text{ V}$$

$$n/m = 3/5 : 60 \text{ V}$$

$$n/m = 4/5 : 80 \text{ V}$$

$$n/m = 5/5 : 100 \text{ V}$$

#### <<Command Mnemonic>>

```
:DIVider:NUMerator {<NRf>|MINimum|MAXimum}
```

```
:DIVider:DENominator {<NRf>|MINimum|MAXimum}
```

## 5.6 Turning the Output On and Off



### WARNING

Never touch the terminals or cables when the 2558A output is on. Doing so may cause electric shock.

### French



### AVERTISSEMENT

Ne touchez jamais les bornes ou les câbles lorsque la sortie du dispositif 2558A est sous tension. Ceci risquerait d'entraîner un choc électrique.

### Procedure

Flip the **OUTPUT** switch up.

The output turns on, the ON indicator illuminates, and the OFF indicator turns off. Flipping the OUTPUT switch while the output is on will turn off the output and the ON indicator and turn on the OFF indicator. When the output is on, the voltage or current output value is displayed.

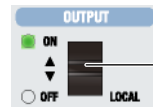

Turn the output on or off.

Display example of 100.00 V

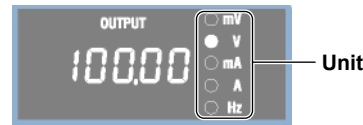

Unit

### Note

When outputting current from the current terminals, do not open the current terminals.

When outputting voltage from the voltage terminals, do not short the voltage terminals.

In either case, the overload protection function will be activated, an error code will be displayed, and the output will be turned off.

### Explanation

#### Turning the Output On and Off

When you turn on the output, if a voltage range is selected, the 2558A outputs voltage from the voltage terminals. If a current range is selected, the 2558A outputs current from the current terminals.

If you change the voltage or current range, the output automatically turns off.

#### Indicator and Output States

Output State	ON Indicator (green)	OFF Indicator (Red)
ON	On	Off
OFF	Off	On

#### <<Command Mnemonic>>

```
:OUTPut[:STATE] <Boolean>
```

```
:SOURce:READ?
```

```
:FREQuency:READ?
```

## 5.6 Turning the Output On and Off

---

### Output Value Display

The output from the voltage or current terminals is monitored and displayed.

Display update time: 200 ms

The output value is the sum of the output divider value and deviation.

Output value = Main setting × divider value + main setting × (– deviation)

Range	Display Range
100 mV	0.00 mV to 144.00 mV
1 V	0.0000 V to 1.44000 V
10 V	0.000 V to 14.400 V
100 V	0.00 V to 144.00 V
300 V	0.00 V to 432.00 V
1000 V	0.0 V to 1440.0 V
100 mA	0.00 V to 144.00 mA
1 A	0.0000 V to 1.4400 A
10 A	0.000 V to 14.400 A
50 A	0.000 V to 72.000 A

## 5.7 Finely Adjusting the Output (Deviation and Preset)

### Procedure

#### Deviation

Turn the **deviation** dial to set the value. The DEVIATION display shows the value. Turn the deviation dial right to decrease the deviation and increase the output.

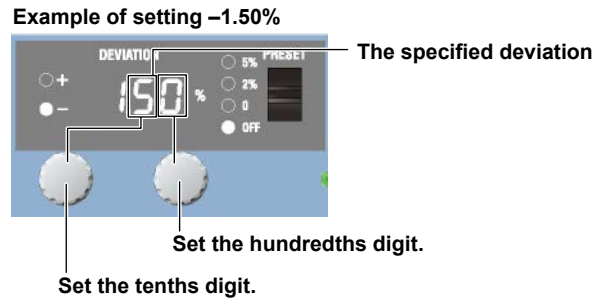

#### Preset

Flip the **PRESET** switch up or down to select a preset. The selected preset indicator illuminates, and the deviation display shows the value.

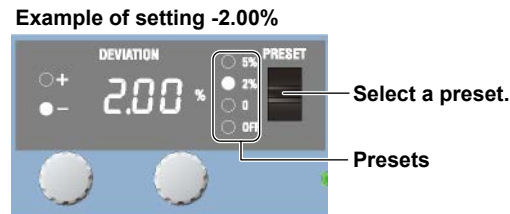

### Explanation

#### Deviation

When you calibrate a meter using the 2558A, use the deviation dials to read the deviation of the target meter (the error between a scale value and needle). Use the main setting and the output divider feature to output the meter scale values (nominal values) and use the deviation dials to align the meter needle to the scale values.

If you turn a dial to the right and set a negative value, the 2558A outputs a value that is larger by the main setting value  $\times$  the deviation. A negative deviation means that the meter needle is indicating a value less than the 2558A output.

**Example** If the main setting is 100 V, the divider value is 5/10, and the deviation is -1%, you will obtain the following result.

$$\text{Deviation} = 100 \times 0.01 = 1 \text{ V}$$

Because the divider value is 5/10, the output value is 50 V + the deviation (1 V), which is 51 V.

- If you change the main setting or the divider value, the value set with the deviation dial will be cleared.
- If the preset is set to 0%, 2%, or 5% and you change the main setting or the denominator  $m$  of the output divider, the deviation will be cleared. If you change the numerator  $n$ , the deviation is set based on the preset setting.
- You cannot control this setting while a sweep is in progress.
- If the output range is exceeded, the display blinks.



## 5.7 Finely Adjusting the Output (Deviation and Preset)

---

Selectable range: -20.00% to +20.00%

Resolution: 0.01%

Deviation target: Voltage or current output. Frequency if FREQUENCY METER is selected in the frequency settings.

### Preset

When you change the numerator *n* of the output divider feature, the deviation is set to a value based on the change in *n* and the preset.

When you calibrate a meter, you will change the numerator *n* of the output divider feature to move the calibration point. A preset is used to take the meter error or overshoot into consideration so that when you move the calibration point, the calibration point is not exceeded.

The sign of the deviation preset is positive when calibrating in increasing order (calibrating from the smallest value) and negative when calibrating in decreasing order (calibrating from the largest value).

Value

- 5%: The deviation is set to +5% when the numerator *n* of the output divider feature increases and -5% when it decreases.
- 2%: The deviation is set to +2% when the numerator *n* of the output divider feature increases and -2% when it decreases.
- 0: The deviation is set to 0% when the numerator *n* of the output divider feature changes.
- OFF: Presets are not used.

- When you change the preset setting, the deviation is set to the preset value.
- You cannot change the preset while a sweep is in progress.
- If you flip the PRESET switch down from the OFF position, the deviation will be set to 0.00%.
- The default preset is 0.

### <<Command Mnemonic>>

:DEVIation:PRESet {<Percentage>|OFF}

:DEVIation:VALue {<Percentage>|MINimum|MAXmam}

## 5.8 Sweeping

### Procedure

#### Setting the Sweep Time

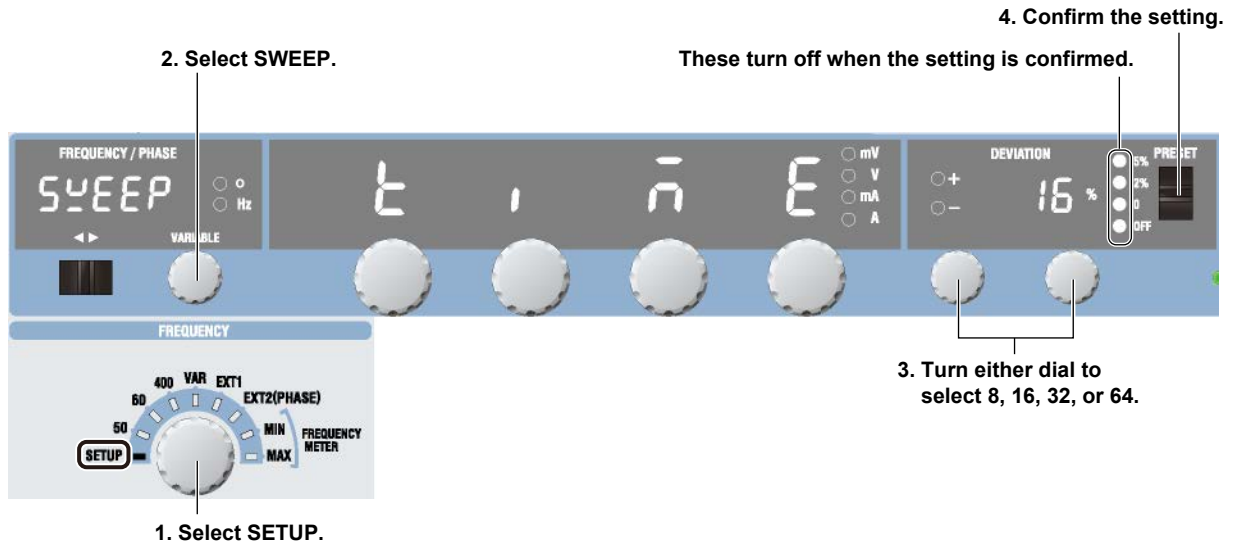

1. Turn the **FREQUENCY** dial to select SETUP.  
The indicator corresponding to the selected SETUP range illuminates, and the frequency/phase angle display area shows the SETUP menu.
2. Turn the **VARIABLE** dial to select SWEEP.
3. Turn the **deviation dial** to select 8, 16, 32, or 64 (s).  
When you change the setting, all four preset indicators will illuminate.
4. Flip the **PRESET** switch up or down.  
The setting is confirmed, and all the preset indicator turn off.

#### Starting to Sweep

##### UP Sweep

Flip the **SWEEP** switch up.

The UP indicator illuminates, and an up sweep starts. When the maximum output is reached or if you flip the SWEEP switch down while sweeping is in progress, sweeping will stop (HOLD state). A beep will sound when the sweep is held.

##### DOWN Sweep

Flip the **SWEEP** switch down.

The DOWN indicator illuminates, and a down sweep starts. When the minimum output is reached or if you flip the SWEEP switch up while sweeping is in progress, sweeping will stop (HOLD state). A beep will sound when the sweep is held.

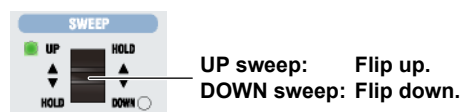

**Explanation****Sweep Time**

Taking the main setting value to be 100%, set the time to sweep the output from 0 to 100%.

The sweep range is 0 to 120% of the main setting value, but the sweep time is the time for the output to swept from 0 to 100%. Therefore, the time needed to sweep the entire range is 120% of the specified time.

The available settings are 8 s, 16 s, 32 s, or 64 s. You cannot specify any other value.

For example, if you select 16 s, the 2558A will sweep from 0% to 100% of the voltage or current level in 16 s. The time it takes to sweep from 0% to 120% is 19.2 s.

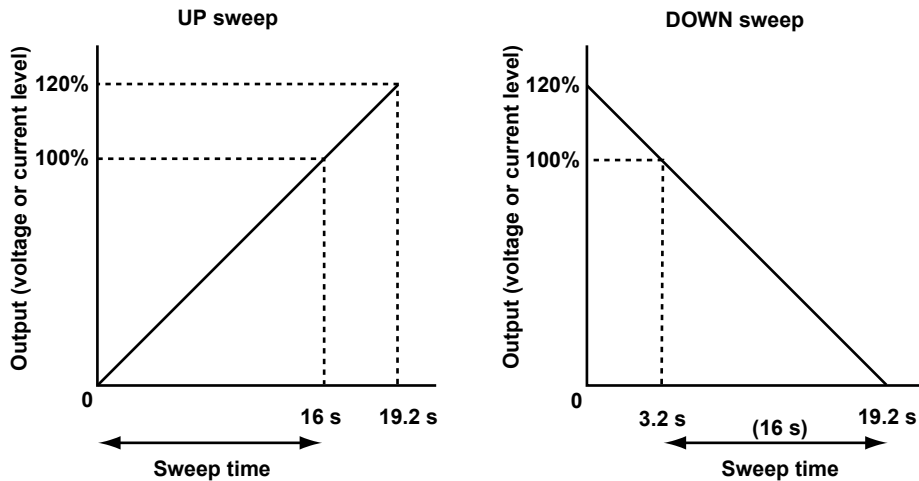
**Sweep Direction**

- UP: Sweeps towards larger values of the meter
- DOWN: Sweeps towards smaller values of the meter
- HOLD: Stops sweeping and holds the output value, normal operation

To sweep up from 0, set the output divider value (n) to 0 and the deviation to 0%. For the procedure, see sections 5.5 and 5.7.

Sweeping will stop if you change the voltage or current frequency (when you operate the FREQUENCY dial), the main setting, or the phase angle. Sweeping will not stop if you change the frequency with the VARIABLE dial.

**Output to Sweep**

The sweep operation is achieved through the automatic and continuous changing of the output divider value and deviation. Because sweeping begins at the current output divider value and deviation, you can set these in advance to start sweeping from any point within the sweep range.

Holding the sweep operation stops the automatic changing of the output divider value and deviation, which means that normal operation returns. The deviation setting and output divider value when normal operation returns are those that have been set at the end of the sweep operation.

When sweeping is held, the 2558A operates in normal mode. If you see a phenomenon that you want to observe closely while sweeping, you can hold the sweep operation and use the deviation dial to observe the situation slowly. Afterward, you can resume the sweep operation if you want.

**<<Command Mnemonic>>**

```
:SWEep:TIME <Time>
:SWEep:DIRection {HOLD|UP|DOWN}
```

## 6.1 Selecting Whether to Ground the LO Terminal (COMMON Terminal)

### Procedure

#### CAUTION

If you select “no ground” (OFF), do not apply a voltage exceeding the withstand voltage to ground (12 Vpk). If you do, the 2558A may malfunction.

#### French

#### ATTENTION

Si le dispositif cible n'est pas relié à la terre, relier la borne LO (ON) à la terre. Sans mise à la terre (OFF), il existe un risque d'électrocution.

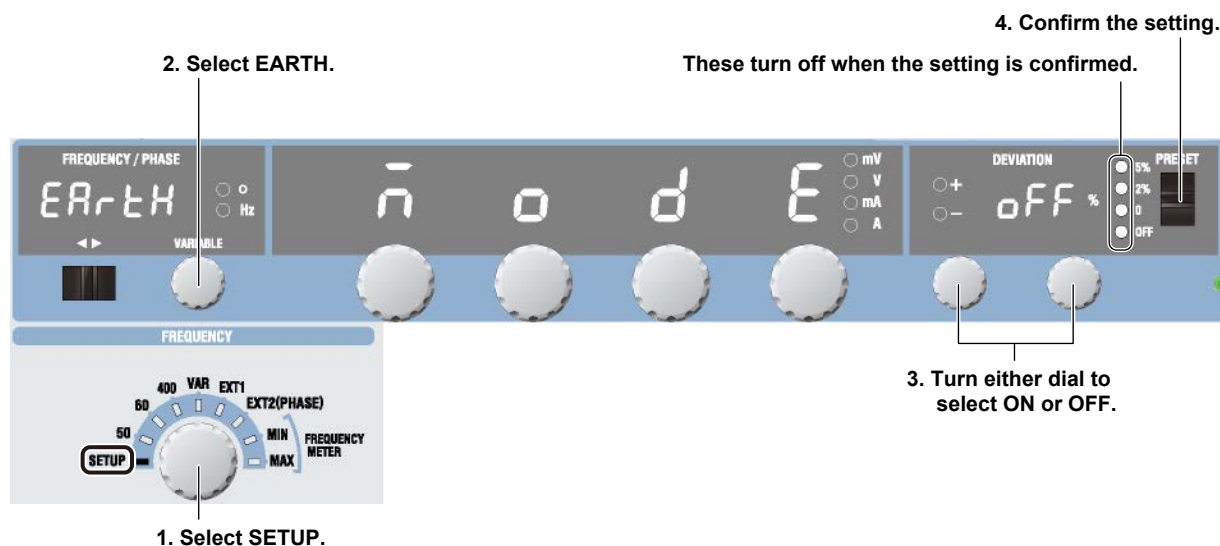

1. Turn the **FREQUENCY** dial to select SETUP.  
The indicator corresponding to the selected SETUP range illuminates, and the frequency/phase angle display area shows the SETUP menu.
2. Turn the **VARIABLE** dial to select EARTH.
3. Turn the **deviation dial** to select ON or OFF.  
When you change the setting, all four preset indicators will illuminate.
4. Flip the **PRESET** switch up or down.  
The setting is confirmed, and all the preset indicators turn off.  
When you turn it on, the LO TO EARTH indicator will illuminate.

## 6.1 Selecting Whether to Ground the LO Terminal (COMMON Terminal)

---

### Explanation

Set whether to ground the LO terminal of the voltage and current output.

ON: The LO terminal is grounded.

OFF: The LO terminal is not grounded.

If one of the terminals on the output target is grounded to avoid errors caused by a ground loop, connect the LO terminal of the 2558A to the terminal that is grounded, and set the LO terminal to “no ground” (OFF). If the target device is not grounded, ground the LO terminal (ON).

### <<Command Mnemonic>>

:SYSTem:EARTh <Boolean>

## 6.2 Setting the Frequency

### Procedure

#### Selecting the Frequency Meter (FREQUENCY METER MIN/MAX)

- 1 Turn the **FREQUENCY** dial to select FREQUENCY MAX or MIN.

The indicator corresponding to the selected frequency and the Hz unit indicator illuminate. In addition, the selected frequency is displayed.

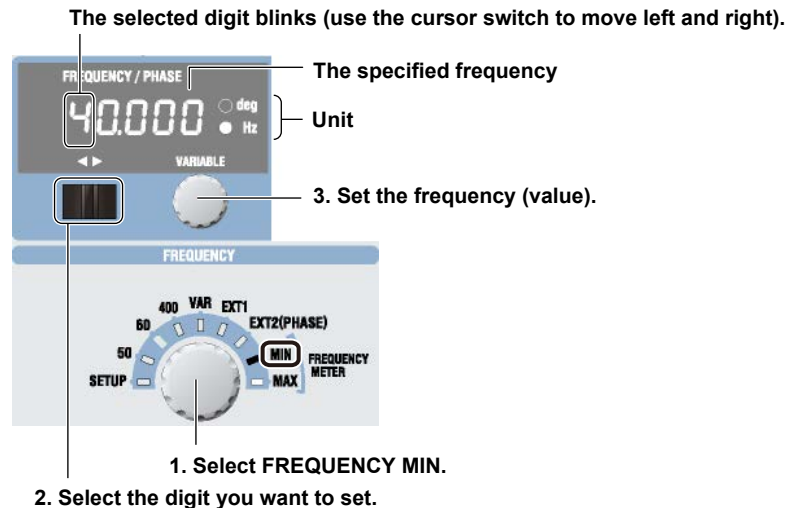

2. Use the **cursor** switch (◀▶) to select the digit you want to set.  
The selected digit blinks.
3. Turn the **VARIABLE** dial to set the value.

### Explanation

Set the minimum scale value (MIN) and the maximum scale value (MAX) of the frequency meter that you want to calibrate.

Frequency range    FREQUENCY METER MIN: 20 Hz to 1000 Hz  
                              FREQUENCY METER MAX: 20 Hz to 1000 Hz

Display resolution    Frequency other than 1000 Hz: 0.001 Hz  
                              1000 Hz:                               0.01 Hz

The FREQUENCY MIN value cannot be set to a value greater than the FREQUENCY MAX value.  
If the frequency is 40 Hz or less, the maximum output oscillation decreases.

To calibrate a frequency meter whose rating is 100 V, use the 300 V range, not the 100 V range.

#### <<Command Mnemonic>>

:FREQuency:INTernal:FMETer:MINimum {<Frequency>|MINimum|MAXimum}

:FREQuency:INTernal:FMETer:MAXimum {<Frequency>|MINimum|MAXimum}

## 6.3 Selecting the Voltage or Current Range

### Procedure

Turn the **RANGE** dial to set the voltage or current range.  
The indicator for the selected range illuminates.

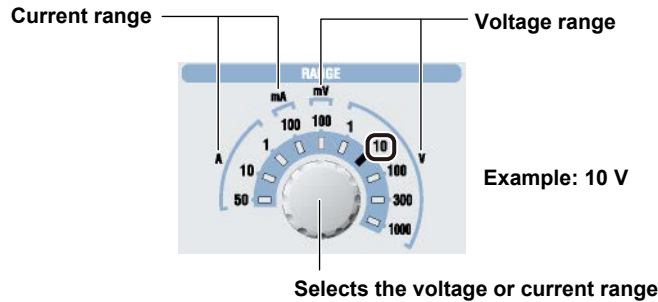

### Explanation

The selectable range and resolution vary depending on the specified range.  
For details on the function, see section 2.2.

#### Voltage Range

Voltage Range	Selectable range <sup>1</sup>	Resolution
100 mV	0 mV to 120.00 mV	0.01 mV
1 V	0 V to 1.2000 V	0.0001 V
10 V	0 V to 12.000 V	0.001 V
100 V	0 V to 120.00 V	0.01 V
300 V	0 V to 360.0 V	0.1 V
1000 V	0 V to 1200.0 V	0.1 V

<sup>1</sup> Generates 144% of the range when used with deviation (–20%)

#### Current Range

Current Range	Selectable range <sup>1</sup>	Resolution
100 mA	0 mA to 120.00 mA	0.01 mA
1 A	0 A to 1.2000 A	0.0001 A
10 A	0 A to 12.000 A	0.001 A
50 A	0 A to 60.00 A	0.01 A

<sup>1</sup> Generates 144% of the range when used with deviation (–20%)

If you select the 300 V or 1000 V range, the HIGH VOLTAGE indicator will illuminate even if the voltage or current output is off.

The voltage and current ranges are fixed. The 2558A does not have an auto range feature.

When the power is turned on, the setting that was used previously is restored.

If you change the voltage or current range when the output is on, the output automatically turns off.

The ratio of the main setting value to the voltage or current range is passed on to the main setting value even after you change the voltage or current range.

Example: If the main setting is 0.5 V (50%) at the 1 V voltage range and you change the voltage range to 10 V, the main setting value will be 5 V.

#### <<Command Mnemonic>>

```
:SOURCE:FUNCTION {VOLTage|CURRent}
:SOURCE:RANGe {<Voltage>|<Current>}
```

## 6.4 Main Voltage and Current Settings

### Procedure

Turn the **main setting** dials to set the voltage or current level to generate.  
The main setting display shows the voltage or current level.

#### Example of setting 100.00 V

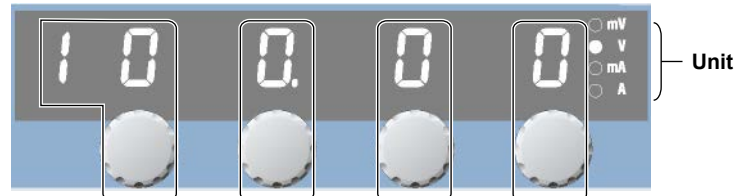

Use each dial to set the corresponding digit or digits, shown by the frames.  
Carrying over and borrowing occurs automatically within the selectable range.

### Explanation

#### Range

For details, see the explanation in section 6.3.

#### Maximum and Minimum Settings

Minimum: 0% of each range rating.

Maximum: 120% of each range rating.

The amplitude accuracy applies only in the frequency range of 40 Hz to 1000 Hz.

For details on the accuracy specifications, see section 16.2.

You can control the main setting while the voltage or current is being output. If you set the voltage level to 150 V or higher, beeps will be generated. For details on how to turn the beep on and off, see section 8.1.

The setting appears flush right within the display resolution range of each range setting.

#### 1V range



#### 300V range



#### <<Command Mnemonic>>

```
:SOURce:FUNction {VOLTage|CURRent}
:SOURce:LEVel {<Current>|<Voltage>|MINimum|MAXimum}
:FREQuency:FUNction {FMIN|FMAX}
```



## 6.5 Dividing the Output

### Procedure

1. Turn the **m** dial.  
The m display shows the denominator of the divider value (the number of divisions).
2. Turn the **n** dial.  
The n display shows the numerator of the divider value.

Divider value example:  $x \frac{1}{5}$

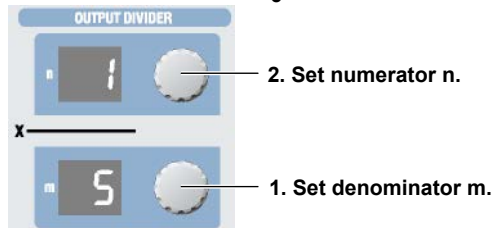

### Explanation

The 2558A outputs voltage or current by dividing the frequency specified in section 6.2.

The voltage and current levels are not divided.

The range for denominator m is 4 to 15.

The range for numerator n is 0 to m.

Turning the m dial resets numerator n to the denominator m value.

The n value cannot be set larger than the m value.

When the power is turned on, denominator m that was used previously is restored. The numerator n is reset to the denominator m value.

For example, if FREQUENCY METER MIN is set to 45 Hz and MAX is set to 65 Hz and you set the denominator m to 4, the following division occurs.

$$65 \text{ Hz} - 45 \text{ Hz} = 20 \text{ Hz}$$

The output is divided at 5 Hz intervals (1/4 of 20 Hz).

$$n/m = 0/4 : 45\text{Hz}$$

$$n/m = 1/4 : 50\text{Hz}$$

$$n/m = 2/4 : 55\text{Hz}$$

$$n/m = 3/4 : 60\text{Hz}$$

$$n/m = 4/4 : 65\text{Hz}$$

#### <<Command Mnemonic>>

```
:DIVider:NUMerator {<NRf>|MINimum|MAXimum}
```

```
:DIVider:DENominator {<NRf>|MINimum|MAXimum}
```

## 6.6 Turning the Output On and Off



### WARNING

Never touch the terminals or cables when the 2558A output is on. Doing so may cause electric shock.

### French



### AVERTISSEMENT

Ne touchez jamais les bornes ou les câbles lorsque la sortie du dispositif 2558A est sous tension. Ceci risquerait d'entraîner un choc électrique.

### Procedure

Flip the **OUTPUT** switch up.

The output turns on, the ON indicator illuminates, and the OFF indicator turns off. Flipping the OUTPUT switch while the output is on will turn off the output and the ON indicator and turn on the OFF indicator. When the output is on, the frequency output value is displayed.

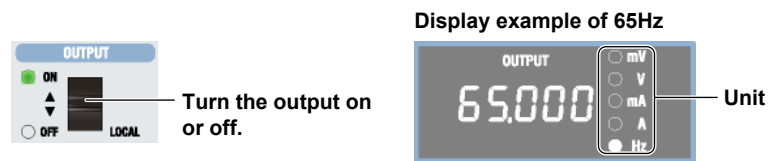

### Note

When outputting current from the current terminals, do not open the current terminals.

When outputting voltage from the voltage terminals, do not short the voltage terminals.

If you do, the overload protection function will be activated, an error code will be displayed, and the output will be turned off.

### Explanation

#### Turning the Output On and Off

When you turn on the output, if a voltage range is selected, the 2558A outputs voltage from the voltage terminals. If a current range is selected, the 2558A outputs current from the current terminals.

If you change the voltage or current range, the output automatically turns off.

#### Indicator and Output States

Output State	ON Indicator (green)	OFF Indicator (Red)
ON	On	Off
OFF	Off	On

### OUTPUT Display

Displays the frequency of the voltage or current output.

Display update time: 200 ms

If the difference between the FREQUENCY METER MAX and MIN values is defined as Fspan, the output frequency is the sum of the value that results when Fspan is divided by the divider value, the MIN value, and the deviation relative to Fspan.

$Fspan = (FREQUENCY\ METER\ MAX) - (FREQUENCY\ METER\ MIN)$

$Output\ frequency = Fspan \times divider\ value + (FREQUENCY\ METER\ MIN) + Fspan \times (-deviation)$

Display range: 20.000 Hz to 1000.0 Hz

#### <<Command Mnemonic>>

:OUTPut[:STATe] <Boolean>

:SOURce:READ?

:FREQuency:READ?

## 6.7 Finely Adjusting the Output (Deviation and Preset)

### Procedure

#### Deviation

Turn the **deviation** dials to set the value. The DEVIATION display shows the deviation. Turn a deviation dial right to decrease the deviation and increase the output.

##### Example of setting $-1.50\%$

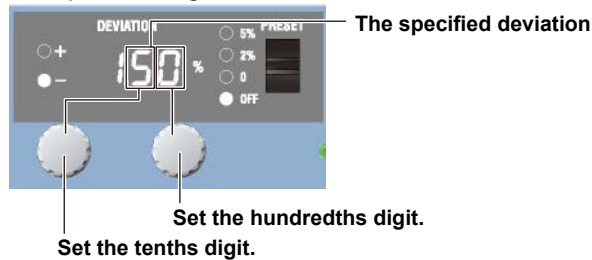

#### Presets

Flip the **PRESET** switch up or down to select a preset. The selected preset indicator illuminates, and the deviation display shows the deviation.

##### Example of setting $-2.00\%$



### Explanation

#### Deviation

When you calibrate a frequency meter using the 2558A, use the deviation dials to read the deviation of the target meter (the error between a scale value and needle). Use FREQUENCY METER MAX, MIN and the output divider feature to output the meter scale values (nominal frequency) and use the deviation dials to align the meter needle to the scale values.

If you turn a dial to the right and set a negative value, the 2558A outputs a value that is larger by the  $F_{span} \times$  the deviation. A negative deviation means that the meter needle is indicating a value less than the 2558A output.

The deviation is relative to the difference between FREQUENCY METER MAX and MIN. This is also true even when the output divider feature is in use.

$$F_{span} = (\text{FREQUENCY METER MAX}) - (\text{FREQUENCY METER MIN})$$

$$\text{Output frequency} = F_{span} \times \text{divider value} + (\text{FREQUENCY METER MIN}) + F_{span} \times (-\text{deviation})$$

**Example** If FREQUENCY METER MIN is 45 Hz, MAX is 65 Hz, and the divider value is 1/4, setting the deviation to  $-1\%$  will produce the following result.

When the divider value is 1/4, the output value is 5 Hz + the deviation ( $+0.2$  Hz), and the output frequency is 50.2 Hz.

$$F_{span} = 65 \text{ Hz} - 45 \text{ Hz} = 20 \text{ Hz}$$

$$\text{The meter scale value} = 20 \text{ Hz} \times 1/4 + 45 \text{ Hz} = 50 \text{ Hz}$$

$$\text{Deviation frequency} = 20 \text{ Hz} \times (-(-1\%)) = 0.2 \text{ Hz}$$

$$\text{Output frequency} = 50 \text{ Hz} + 0.2 \text{ Hz}$$

## 6.7 Finely Adjusting the Output (Deviation and Preset)

---

- If you change the FREQUENCY METER MIN, MAX, main setting, or divider value, the value set with the deviation dial will be cleared.
- If the preset is set to 0%, 2%, or 5% and you change the main setting or the denominator  $m$  of the output divider, the deviation will be cleared. If you change the numerator  $n$ , the deviation is set based on the preset setting.
- You cannot control this setting while a sweep is in progress.
- When an up sweep is in progress, the deviation is monitored and displayed in accordance with the changes in the output value. Sweeping stops when the deviation reaches  $-20\%$ . However, output is not possible at 1000 Hz or higher.
- When an down sweep is in progress, the deviation is monitored and displayed in accordance with the changes in the output value. Sweeping stops when the deviation reaches  $+20\%$ . However, output is not possible at 20 Hz or lower.
- If the output range is exceeded, the display blinks.

Selectable range:  $-20.00\%$  to  $+20.00\%$

You cannot set a deviation that would cause the frequency to be 1000 Hz or higher.

Resolution: 0.01%

### Presets

When you change the numerator  $n$  of the output divider feature, the deviation is set to a value based on the change in  $n$  and the preset.

When you calibrate a meter, you will change the numerator  $n$  of the output divider feature to move the calibration point. A preset is used to take the meter error or overshoot into consideration so that when you move the calibration point, the calibration point is not exceeded.

The sign of the deviation preset is positive when calibrating in increasing order (calibrating from the smallest value) and negative when calibrating in decreasing order (calibrating from the largest value).

Value

5%: The deviation is set to  $+5\%$  when the numerator  $n$  of the output divider feature increases and  $-5\%$  when it decreases.

2%: The deviation is set to  $+2\%$  when the numerator  $n$  of the output divider feature increases and  $-2\%$  when it decreases.

0: The deviation is set to  $0\%$  when the numerator  $n$  of the output divider feature changes.

OFF: Presets are not used.

- When you change the preset setting, the deviation is set to the preset value.
- You cannot change the preset while a sweep is in progress.
- If you flip the PRESET switch down from the OFF position, the deviation will be set to  $0\%$ .
- The default preset is 0.

#### <<Command Mnemonic>>

```
:DEVIation:PRESet {<Percentage>|OFF}
```

```
:DEVIation:VALue {<Percentage>|MINimum|MAXimum}
```

## 6.8 Sweeping

### Procedure

#### Setting the Sweep Time

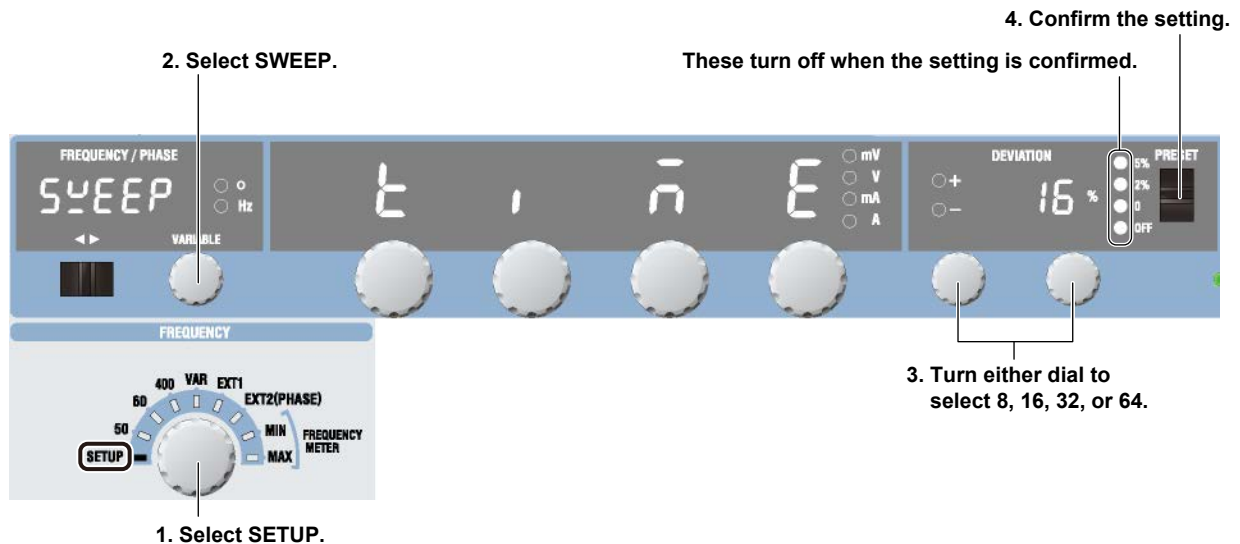

1. Turn the **FREQUENCY** dial to select SETUP.  
The indicator corresponding to the selected SETUP range illuminates, and the frequency/phase angle display area shows the SETUP menu.
2. Turn the **VARIABLE** dial to select SWEEP.
3. Turn the **deviation dials** to select 8, 16, 32, or 64.  
When you change the setting, all four preset indicators will illuminate.
4. Flip the **PRESET** switch up or down.  
The setting is confirmed, and all the preset indicators turn off.

#### Starting to Sweep

##### UP Sweep

Flip the **SWEEP** switch up.

The UP indicator illuminates, and the 2558A starts sweeping toward higher values. When the maximum output is reached or if you flip the SWEEP switch down while sweeping is in progress, sweeping will stop (hold state). A beep will sound when the sweep is held.

##### DOWN Sweep

Flip the **SWEEP** switch down.

The DOWN indicator illuminates, and the 2558A starts sweeping toward lower values. When the minimum output is reached or if you flip the SWEEP switch up while sweeping is in progress, sweeping will stop (hold state). A beep will sound when the sweep is held.



UP sweep: Flip up.  
DOWN sweep: Flip down.

**Explanation****Sweep Time**

Taking the frequency span to be 100%, set the time to sweep the output from 0 to 100%.

The frequency span is the difference between FREQUENCY METER MAX and MIN.

The sweep range is 0 to 120% of the main setting value, but the sweep time is the time for the output to swept from 0 to 100%. Therefore, the time needed to sweep the entire range is 140% of the specified time.

The available settings are 8 s, 16 s, 32 s, or 64 s. You cannot specify any other value.

For example, if you select 16 s, the 2558A will sweep the frequency from 0 to 100% in 16 s. The time it takes to sweep from -20% to 120% is 22.4 s.

The default sweep time is 16 s.

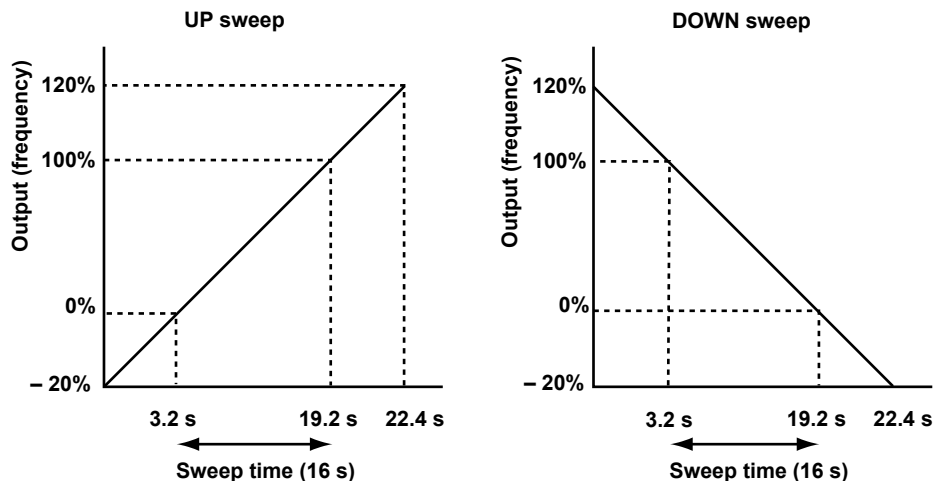
**Sweep Direction**

UP: Sweeps toward larger values of the meter

DOWN: Sweeps toward smaller values of the meter

HOLD: Stops sweeping and holds the output value. Normal operation.

To sweep up from 0, set the output divider value (n) to 0 and the deviation to 0%. For the procedure, see sections 6.5 and 6.7.

Sweeping will stop if you change the voltage or current frequency (when you operate the FREQUENCY dial), the main setting, or the FREQUENCY METER MIN or MAX value.

**Sweep Source**

The sweep operation is achieved through the automatic and continuous changing of the output divider value and deviation. Because sweeping begins at the current output divider value and deviation, you can set these in advance to start sweeping from any point within the sweep range.

Holding the sweep operation stops the automatic changing of the output divider value and deviation, which means that normal operation returns. The deviation setting and output divider value when normal operation returns are those that have been set at the end of the sweep operation.

When sweeping is held, the 2558A operates in normal mode. If you see a phenomenon that you want to observe closely while sweeping, you can hold the sweep operation and use the deviation dial to observe the situation slowly. Afterward, you can resume the sweep operation if you want.

**<<Command Mnemonic>>**

```
:SWEep:TIME <Time>
```

```
:SWEep:DIRection {HOLD|UP|DOWN}
```

# 7.1 External Signal Input and Internal Signal Output

## I/O Circuit Diagram

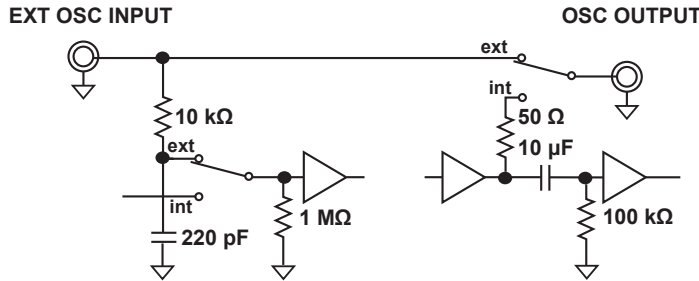

## External Signal Input



### CAUTION

The input voltage is 3 Vrms, and the input resistance is approximately 1 MΩ. Do not apply excessive voltage.

### French



### ATTENTION

La tension d'entrée est de 3 Vrms et la résistance d'entrée est de 1 MΩ environ. Ne pas appliquer de tension excessive.

Connect the external oscillator to this terminal.

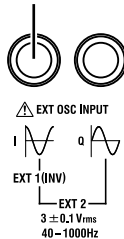

### Input Section (EXT OSC INPUT)

Input voltage:  $3 \pm 0.1$  Vrms, sine wave  
 Frequency range: 40 Hz to 1000 Hz  
 Input resistance: Approx. 1MΩ

There are two ways to apply external signals.

- Connecting an external oscillator  
 Set the frequency to EXT1. For details, see section 2.2 and “Selecting External Oscillator EXT1” in section 5.2.
- Connecting another 2558A as the master oscillator (synchronous operation)  
 Set the frequency to EXT2 (PHASE). For details, see section 2.2 and “Selecting External Oscillator EXT2” in section 5.2. For details on the connection for synchronous operation, see section 7.2.



## Internal Signal Output



### CAUTION

Do not short or apply external voltage to the output.

---

#### French



### ATTENTION

Ne court-circuitiez pas la sortie et n'appliquez pas de tension externe à cette dernière.

---

Connect to the corresponding external input terminals  
on the other 2558A (see section 7.2).

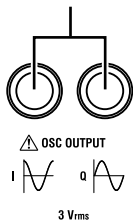

#### Output Section (OSC OUTPUT)

Output voltage:  $3 \pm 0.1$  Vrms, sinusoidal

Frequency range: 40 Hz to 1000 Hz

Output resistance: Approx.  $50\Omega$

If the frequency is set to EXT1 or EXT2, these terminals output the signal connected to EXT OSC INPUT.

## 7.2 Synchronous Operation

This section explains how to synchronize three 2558As.

### Procedure

- **Connecting the 2558As**

1. Using BNC cables, connect the OSC OUTPUT I and Q signals from the 2558A that will be the master device to the EXT OSC INPUT I and Q connectors on the first slave 2558A.
2. Using BNC cables, connect the OSC OUTPUT I and Q signals from the first slave 2558A to the EXT OSC INPUT I and Q connectors on the second slave 2558A.

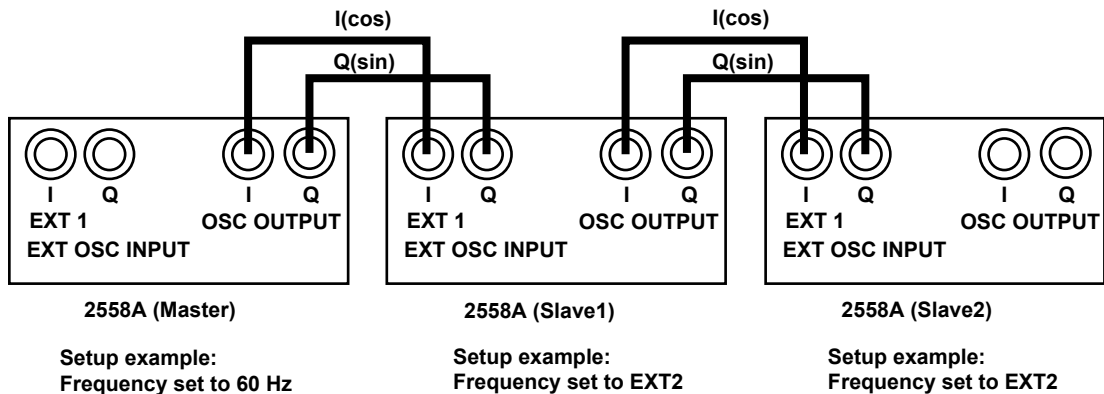

- **Configuring the Master 2558A**

Turn the **FREQUENCY** dial to select 60 Hz.

See "Selecting a Fixed Frequency (50 Hz, 60 Hz, or 400 Hz)" in section 5.2.

- **Configuring the Slave 2558As**

1. Turn the **FREQUENCY** dial to select EXT2(PHASE).  
See "Selecting External Oscillator EXT2" in section 5.2.
2. If necessary, adjust the phase angle.  
See "Selecting External Oscillator EXT2" in section 5.2.

### Explanation

#### OSC OUTPUT Signal and the Phase of Voltage or Current Output

If you configure a 2558A to use the internal oscillator with the **FREQUENCY** dial, the 2558A will output a cosine signal of the internal two-phase oscillator from the OSC OUTPUT I connector and a sine signal from the Q connector. In this case, the amplitude of the voltage or current output is adjusted on the basis of the cosine signal, so the phase will be close to the cosine signal, but the phase of the circuit will be added to it.

If you select EXT1 or EXT2 with the **FREQUENCY** dial, the 2558A will output the EXT OSC INPUT I and Q signals from the corresponding OSC OUTPUT connectors. In this case, the signals will not be affected by the phase values. This makes it easy to connect multiple 2558A in a daisy chain. The maximum number of devices that can be connected is six.

## 8.1 Turning the Beep Sound On and Off

### Procedure

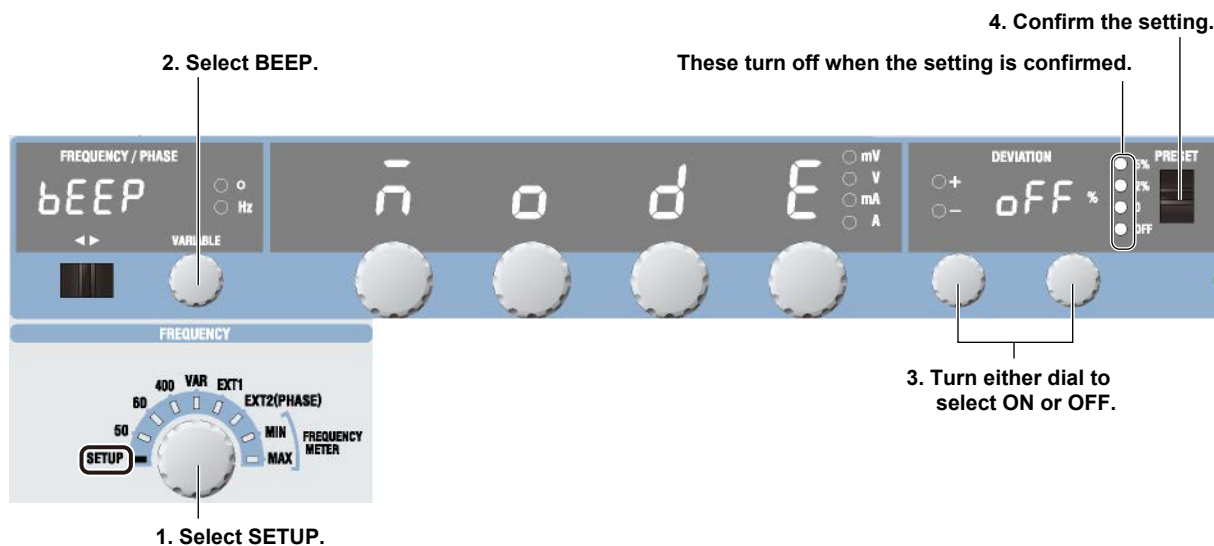

1. Turn the **FREQUENCY** dial to select SETUP.  
The indicator corresponding to the selected SETUP range illuminates, and the frequency/phase angle display area shows the SETUP menu.
2. Turn the **VARIABLE** dial to select BEEP.
3. Turn a **deviation dial** to select ON or OFF.  
When you change the setting, all four preset indicators will illuminate.
4. Flip the **PRESET** switch up or down.  
The setting is confirmed, and all the preset indicators turn off.

### Explanation

Set whether to turn the beep sound on or off.

ON: The beep sound is on.

OFF: The beep sound is off.

You can turn the beep sound on or off for the following notifications. You cannot change the volume.

- When an error is detected during a self-test executed at power-on or executed manually (error codes: E.911 to E.950)
- When the voltage output is set to 150 V or higher
- When a sweep operation is held

## 8.2 Error Log Display

### Procedure

### Displaying the Error Log

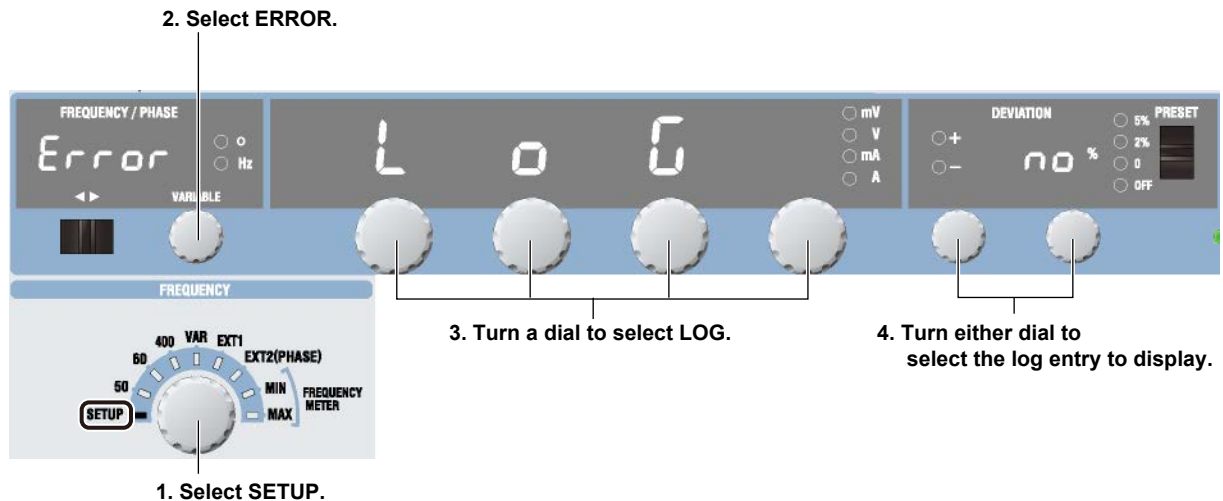

1. Turn the **FREQUENCY** dial to select **SETUP**.  
The indicator corresponding to the selected **SETUP** range illuminates, and the frequency/phase angle display area shows the **SETUP** menu.
2. Turn the **VARIABLE** dial to select **ERROR**.
3. Turn a **main setting** dial to select **LOG**.
4. Turn a **deviation dial** to select the error log entry to display.  
If there are no error log entries, **NO** is displayed.  
If there are, an error code is displayed.

### Clearing the Error Log

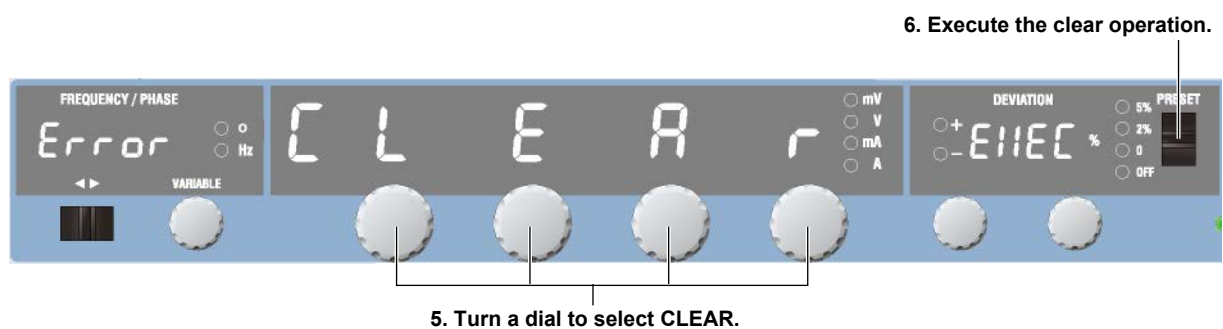

5. Turn a **main setting** dial to select **CLEAR**.
6. Flip the **PRESET** switch up or down.  
The error log is cleared.

**Explanation****Displaying the Error Log**

If there are error log entries, the deviation display shows an error code. If there are other error codes, turning a deviation dial shows the other error codes one by one in order.

The output display shows the total number of error log entries and which error code is being displayed.

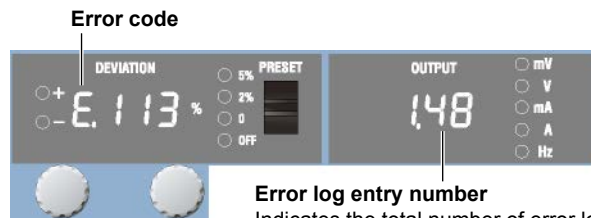
**Error log entry number**

Indicates the total number of error log entries and which error log entry is being displayed. In this example, the first error log entry from 48 log entries is being displayed.

NO: There are no error log entries.

E.XXX: An error code in the log. For details on error codes, see section 15.3.

## 8.3 Initializing the Settings

### Procedure

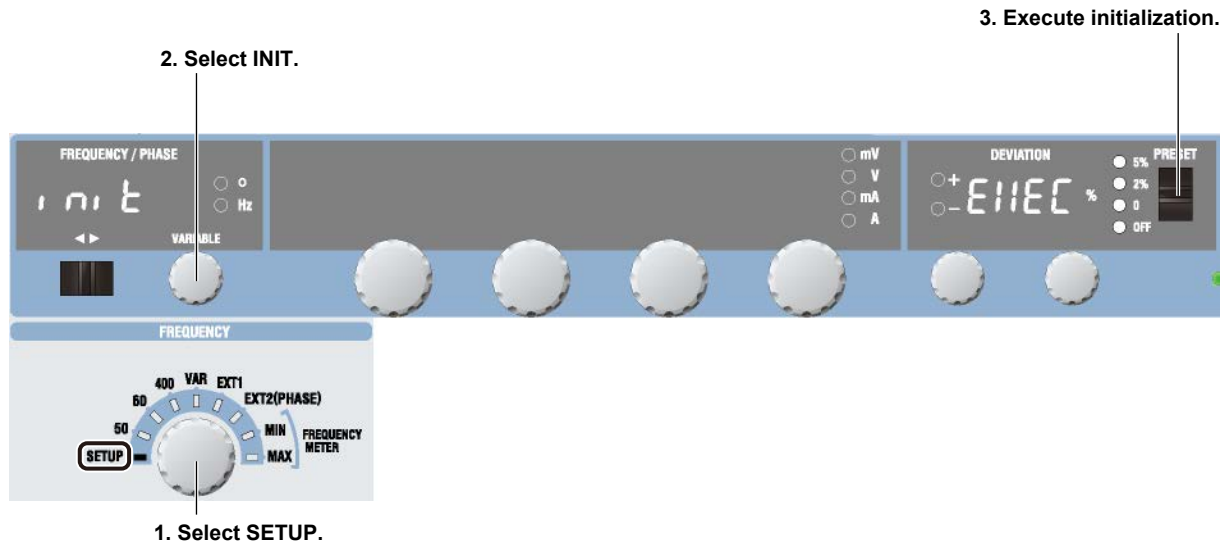

1. Turn the **FREQUENCY** dial to select SETUP.  
The indicator corresponding to the selected SETUP range illuminates, and the frequency/phase angle display area shows the SETUP menu.
2. Turn the **VARIABLE** dial to select INIT.
3. Flip the **PRESET** switch up or down.  
The 2558A settings are initialized.

### Explanation

You can initialize the 2558A to its factory default settings.  
GP-IB and Ethernet settings are not initialized.  
For details on the items that are initialized, see appendix 5.

## 8.4 Displaying the Product Information

### Procedure

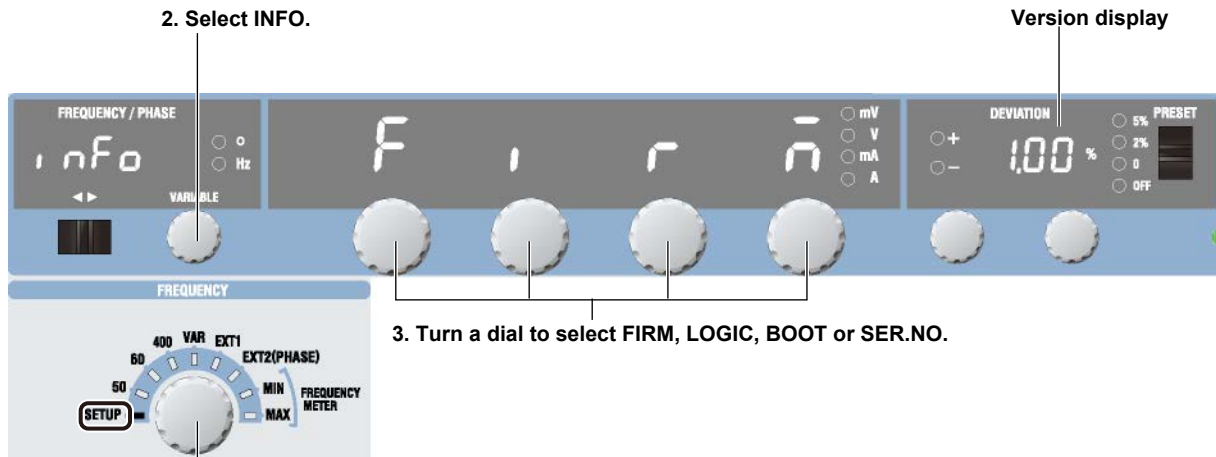

1. Select **SETUP**.

- Turn the **FREQUENCY** dial to select **SETUP**.  
The indicator corresponding to the selected **SETUP** range illuminates, and the frequency/phase angle display area shows the **SETUP** menu.
- Turn the **VARIABLE** dial to select **INFO**.
- Turn a **main setting** dial to select **FIRM**, **LOGIC**, **BOOT**, or **SER.NO.**  
The product information is displayed.

### Explanation

#### Firmware (FIRM), Logic (LOGIC), and Boot (BOOT) Program Information

The version of each item is displayed.

Display example: 1.00

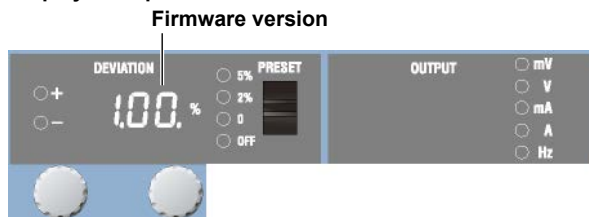

#### Serial Number Information (SER.NO)

You can view the 2558A serial number. To specify the serial number for USB communication, use uppercase letters for the alphabet letters.

Display example: 12AB34567



## 9.1 USB Interface Features and Specifications

### USB Interface Features

#### Reception Feature

- With the exception of turning the power switch on and off, you can use the reception feature to specify the same settings that you specify by using the front panel keys.
- The 2558A can receive output requests for output values, output frequencies, panel setup parameters, and error codes.

#### Transmission Feature

- The 2558A can transmit output values and output frequencies.
- The 2558A can transmit panel setup parameters and the status byte.
- The 2558A can transmit error codes when errors occur.

### USB Interface Specifications

Item	Specifications
Number of ports	1
Connector	Type B connector (receptacle)
Electrical and mechanical	Complies with USB Rev. 2.0
Supported transfer modes	HS (High Speed; 480 Mbps) and FS (Full Speed; 12 Mbps)
Supported protocols	USBTMC-USB488 (USB Test and Measurement Class Ver. 1.0)
PC system requirements	A PC with a USB port, running the English or Japanese version of Windows 7 (32 bit/64bit), Windows Vista (32 bit), or Windows XP (32 bit, SP2 or later)

### Switching between Remote and Local Modes

#### When Switching from Local to Remote Mode

The 2558A switches to remote mode when it is in local mode and it receives a `:COMMunicate:REMOte ON` command from the PC.

- The REMOTE indicator illuminates.
- All dials and switches are disabled except for the flipping of the **OUTPUT** switch to the LOCAL side to change the 2558A to local mode.
- Settings entered in local mode are retained even when the 2558A switches to remote mode.

#### When Switching from Remote to Local Mode

When the 2558A is in remote mode and you flip the **OUTPUT** switch to the LOCAL side, the 2558A switches to local mode. However, this does not work if the 2558A has received a `:COMMunicate:LOCKout ON` command from the PC. The 2558A switches to local mode when it receives a `:COMMunicate:REMOte OFF` command from the PC, regardless of the local lockout state.

- The REMOTE indicator turns off.
- Dials and switches can be used.
- Settings entered in remote mode are retained even when the 2558A switches to local mode.

#### Note

You cannot use the USB interface simultaneously with other interfaces (GP-IB and Ethernet interfaces).



---

## 9.2 Connecting to the USB Interface

### Connection Procedure

Connect the cable as shown below.

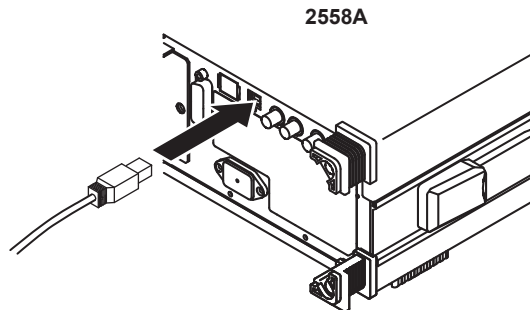

### Notes on Connection

- Be sure to insert the USB cable connector firmly into the USB port.
- If you are connecting multiple devices by using a USB hub, connect the 2558A to the USB hub port that is closest to the port that the controller is connected to.
- Do not connect or remove the USB cable from the time when the 2558A is turned on until operation becomes available (approximately 20 to 30 seconds). Doing so may damage the 2558A.

### Note

- Only use one communication interface: USB, GP-IB, or Ethernet. If you send commands simultaneously from more than one communication interface, the 2558A will not execute the commands properly.
  - Install the YOKOGAWA USB TMC (Test and Measurement Class) driver on your PC. For information about how to obtain the YOKOGAWA USB TMC driver, contact your nearest YOKOGAWA dealer. You can also access the YOKOGAWA USB driver download web page and download the driver.  
<http://tmi.yokogawa.com/>
  - Do not use USB TMC drivers (or software) supplied by other companies.
-

## 10.1 Ethernet Interface Features and Specifications

### Ethernet Interface Features

#### Reception Feature

- With the exception of turning the power switch on and off, you can use the reception feature to specify the same settings that you specify by using the front panel keys.
- The 2558A can receive output requests for output values, output frequencies, panel setup parameters, and error codes.

#### Transmission Feature

- The 2558A can transmit output values and output frequencies.
- The 2558A can transmit panel setup parameters and the status byte.
- The 2558A can transmit error codes when errors occur.

### Ethernet Interface Specifications

Item	Specifications
Electrical and mechanical	IEEE802.3 compliant
Simultaneous connections	3
Communication protocol	TCP/IP (VXI-11)
Transmission system	Ethernet (100BASE-TX/10BASE-T)
Supported services	DHCP, VXI-11
Connector type	RJ-45

### Switching between Remote and Local Modes

#### When Switching from Local to Remote Mode

The 2558A switches to remote mode when it is in local mode and it receives a `:COMMunicate:REMOte ON` command from the PC.

- The REMOTE indicator illuminates.
- All dials and switches are disabled except for the flipping of the **OUTPUT** switch to the LOCAL side to change the 2558A to local mode.
- Settings entered in local mode are retained even when the 2558A switches to remote mode.

#### When Switching from Remote to Local Mode

When the 2558A is in remote mode and you flip the **OUTPUT** switch to the LOCAL side, the 2558A switches to local mode. However, this does not work if the 2558A has received a `:COMMunicate:LOCKout ON` command from the PC. The 2558A switches to local mode when it receives a `:COMMunicate:REMOte OFF` command from the PC, regardless of the local lockout state.

- The REMOTE indicator turns off.
- Dials and switches can be used.
- Settings entered in remote mode are retained even when the 2558A switches to local mode.

#### Note

You cannot use the Ethernet interface simultaneously with other interfaces (GP-IB and USB).

## 10.2 Connecting to the Ethernet Interface

### Connection Procedure

Connect a UTP (Unshielded Twisted-Pair) or STP (Shielded Twisted-Pair) cable that is connected to a hub or other network device to the Ethernet port on the 2558A rear panel.

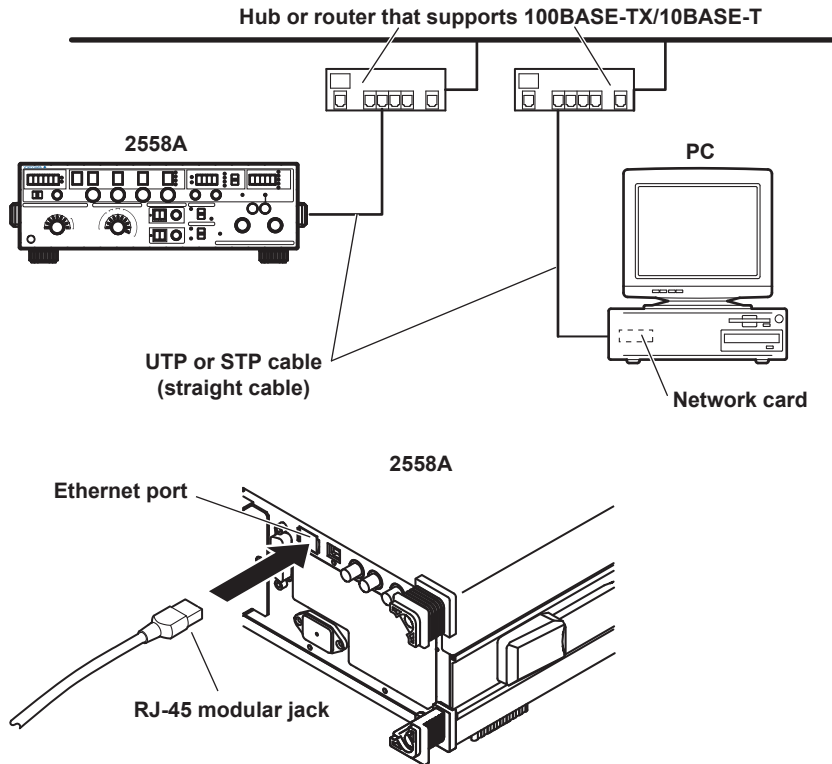

### Notes on Connection

- To connect the 2558A to a PC through a hub or router, use straight cables. To directly connect the 2558A to a PC (one-to-one connection), use a crossover cable.
- Use a network cable that supports the data rate of your network.

## 10.3 Configuring the 2558A Ethernet Settings

This section explains the following setting for remotely controlling the 2558A via the Ethernet interface:

### Procedure

#### Turning DHCP On and Off

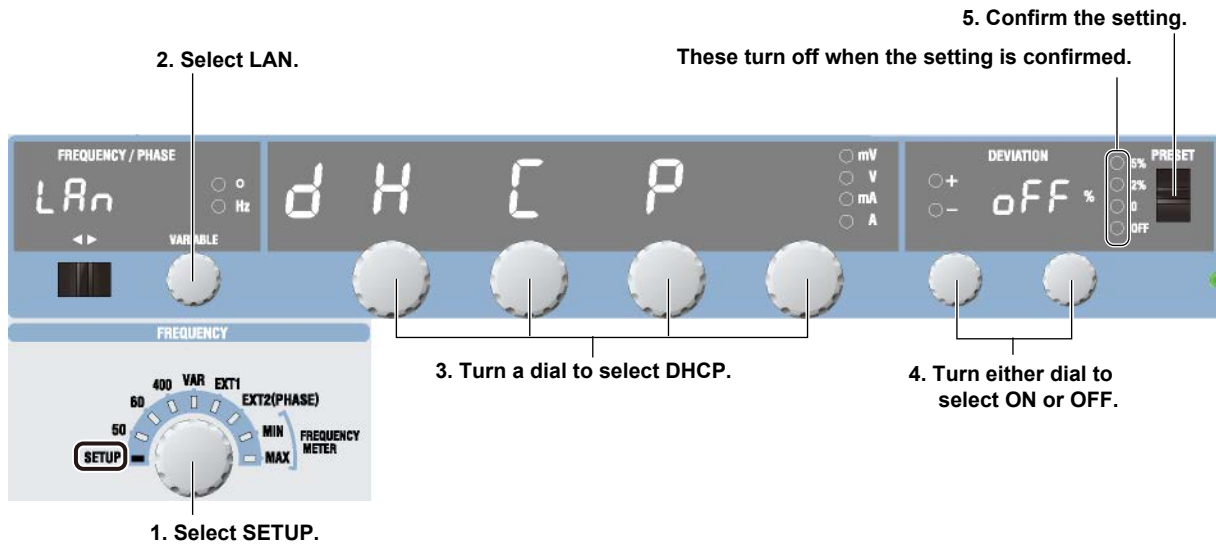

1. Turn the **FREQUENCY** dial to select SETUP.  
The indicator corresponding to the selected SETUP range illuminates, and the frequency/phase angle display area shows the SETUP menu.
2. Turn the **VARIABLE** dial to select LAN.
3. Turn a **main setting** dial to select DHCP.
4. Turn a **deviation dial** to select ON or OFF.  
When you change the setting, all four preset indicators will illuminate.
5. Flip the **PRESET** switch up or down.  
The setting is confirmed, and all the preset indicators turn off.

#### Setting the IP Address, Subnet Mask, and Default Gateway

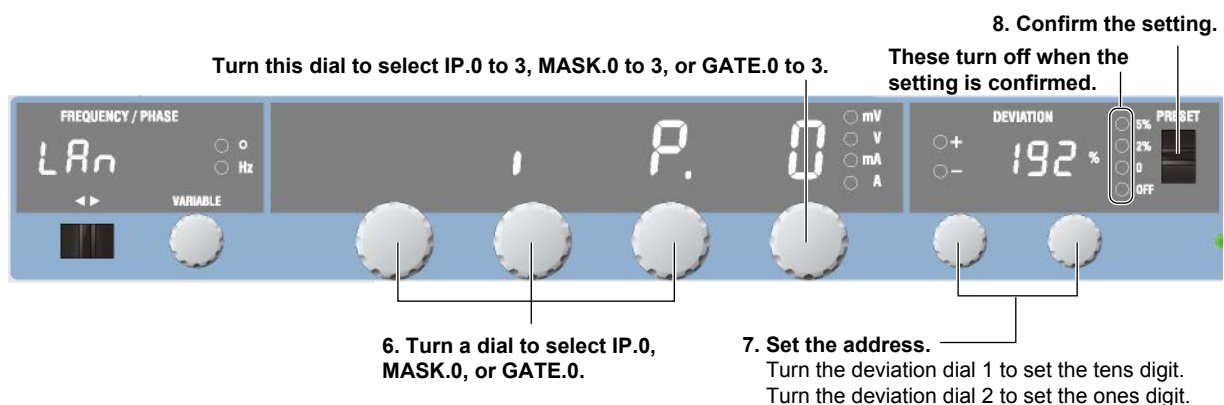

6. Turn a **main setting** dial to select IP, MASK, or GATE.  
Turn the right-most main setting dial to display the four octets of all items one at a time.  
Turn any of the other three main setting dials to display only the first octet.

### 10.3 Configuring the 2558A Ethernet Settings

7. Turn the **deviation** dials to set the address.  
When you change the setting, all four preset indicators will illuminate.
8. Flip the **PRESET** switch up or down.  
The setting is confirmed, and all the preset indicators turn off.

### Displaying the MAC Address

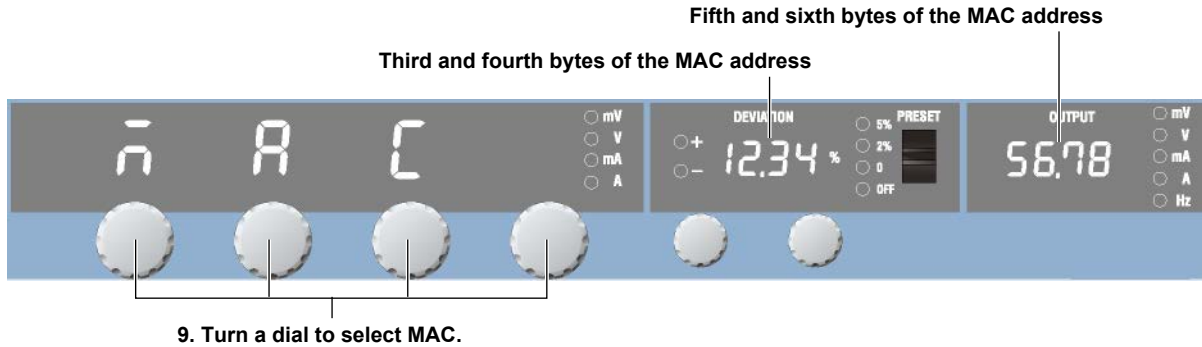

9. Turn a **main setting** dial to select MAC.  
The third to the sixth byte of the MAC address appears. The first and second bytes do not appear (they are fixed at 0).

### Explanation

To use the Ethernet interface, you must specify TCP/IP settings.

### DHCP

DHCP is a protocol that temporarily allocates necessary information to a device so that it can connect to the Internet.

#### ON

If you are connecting the 2558A to a network with a DHCP server, you can turn on the DHCP setting. If you do, the IP address will be automatically assigned to the 2558A when it is connected to the network, so you do not have to set the address.

#### OFF

If you set DHCP to OFF, set the appropriate IP address, subnet mask, and default gateway for your network.

### IP Address, Subnet Mask, and Default Gateway

The IP address, subnet mask, and default gateway appear in the following manner.

#### IP address display example

<b>192.</b>	<b>168.</b>	<b>0.</b>	<b>1</b>
IP.0	IP.1	IP.2	IP.3

### Displaying the MAC address

Because the first and second bytes are fixed at zero, they are not displayed.

Example: If the MAC address is 00.00.12.34.56.78, "12.34.56.78" is displayed.

## 11.1 GP-IB Interface Features and Specifications

### GP-IB Interface Features

#### Reception Feature

- With the exception of turning the power switch on and off, you can use the reception feature to specify the same settings that you specify by using the front panel keys.
- The 2558A can receive output requests for output values, output frequencies, panel setup parameters, and error codes.

#### Transmission Feature

- The 2558A can transmit output values and output frequencies.
- The 2558A can transmit panel setup parameters and the status byte.
- The 2558A can transmit error codes when errors occur.

#### Note

Talk-only, listen-only, and controller capabilities are not available.

### GP-IB Interface Specifications

Item	Specifications
Supported devices	National Instruments Corporation <ul style="list-style-type: none"> <li>• PCI-GPIB or PCI-GPIB+</li> <li>• PCIe-GPIB or PCIe-GPIB+</li> <li>• PCMCIA-GPIB or PCMCIA-GPIB+ (not supported on Windows Vista or Windows 7.)</li> <li>• GPIB-USB-HS</li> </ul> Driver NI-488.2M Version 2.8.1 and later
Electrical and mechanical	Conforms to IEEE St'd 488-1978
Functional specifications	See the table below.
Protocol	Complies with IEEE St'd 488.2-1992 (when using standard commands)
Code	ISO (ASCII) codes
Mode	Addressable mode
Address	The address can be set in the range of 0 to 30.
Clear remote mode	Clear remote mode by flipping the OUTPUT switch to the LOCAL side. This is not possible when local lockout has been activated by the controller.

#### Functional Specifications

Function	Subset Name	Description
Source handshaking	SH1	Full source handshaking capability
Acceptor handshaking	AH1	Full acceptor handshaking capability
Talker	T6	Basic talker capability, serial polling, and untalk on MLA (My Listen Address). No talk-only capability.
Listener	L4	Basic listener capability and unlisten on MTA (My Talk Address). No listen-only capability
Service request	SR1	Full service request capability
Remote local	RL1	Full remote/local capability
Parallel polling	PP0	No parallel polling capability
Device clear	DC1	Full device clear capability
Device trigger	DT1	Device trigger capability
Controller	C0	No controller capability
Electric characteristics	E1	Open collector

### Switching between Remote and Local Modes

#### When Switching from Local to Remote Mode

The 2558A switches to remote mode when it is in local mode and it receives a REN (Remote Enable) message from the PC.

- The REMOTE indicator turns on.
- All dials and switches are disabled except for the flipping of the **OUTPUT** switch to the LOCAL side to change the 2558A to local mode.
- Settings entered in local mode are retained even when the 2558A switches to remote mode.

#### When Switching from Remote to Local Mode

When the 2558A is in remote mode and you flip the OUTPUT switch to the LOCAL side, the 2558A switches to local mode. This is not possible when local lockout (see section 11.4) has been activated by the controller.

- The REMOTE indicator turns off.
- Dials and switches can be used.
- Settings entered in remote mode are retained even when the 2558A switches to local mode.

#### **Note**

---

You cannot use the GP-IB interface simultaneously with other interfaces (USB and Ethernet interfaces).

---

## 11.2 Connecting to the GP-IB Interface

### GP-IB Cable

The 2558A is equipped with an IEEE St'd 488-1978 24-pin GP-IB connector. Use a GP-IB cable that conforms to this standard.

### Connection Procedure

Connect the cable as shown below.

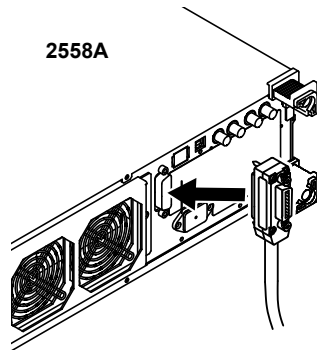

### Notes on Connection

- Firmly tighten the screws on the GP-IB cable connector.
- On the PC end, use a GP-IB board (or card) made by National Instruments. For details, see section 11.1.
- The 2558A may not operate properly if the 2558A is connected to the PC through converters (such as a GP-IB to USB converter). For more details, contact your nearest YOKOGAWA dealer.
- Multiple cables can be used to connect multiple devices. However, no more than 15 devices, including the controller, can be connected on a single bus.
- When connecting multiple devices, you must assign a unique address to each device.
- Use cables that are no longer than 2 m in length to connect devices.
- Make sure the total length of all cables does not exceed 20 m.
- When devices are communicating, have at least two-thirds of the devices on the bus turned on.
- To connect multiple devices, wire them in a daisy-chain or star configuration as shown below. You can also mix these configurations. Loop configuration is not allowed.

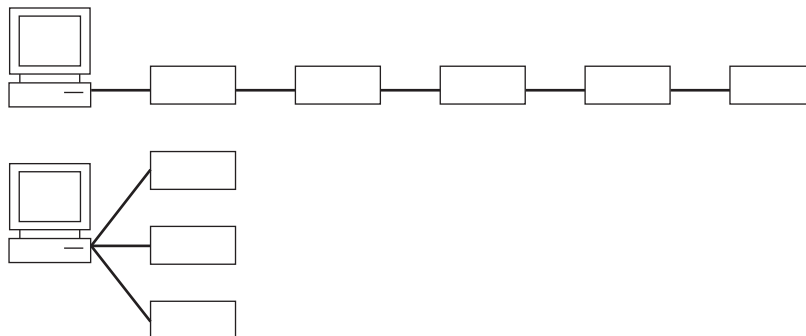



---

### **CAUTION**

Be sure to turn off the PC and the 2558A before you connect or remove communication cables. Otherwise, erroneous operation may result, or the internal circuitry may break.

---

### **French**

---

### **ATTENTION**

Toujours mettre le PC et le 2558A hors tension avant de brancher ou de débrancher des câbles de communication, pour éviter tout dysfonctionnement ou panne du circuit interne.

---

## 11.3 Configuring the 2558A GP-IB Settings

This section explains the following setting for controlling the 2558A remotely through a GP-IB interface:

### Procedure

#### Setting the GP-IB Address

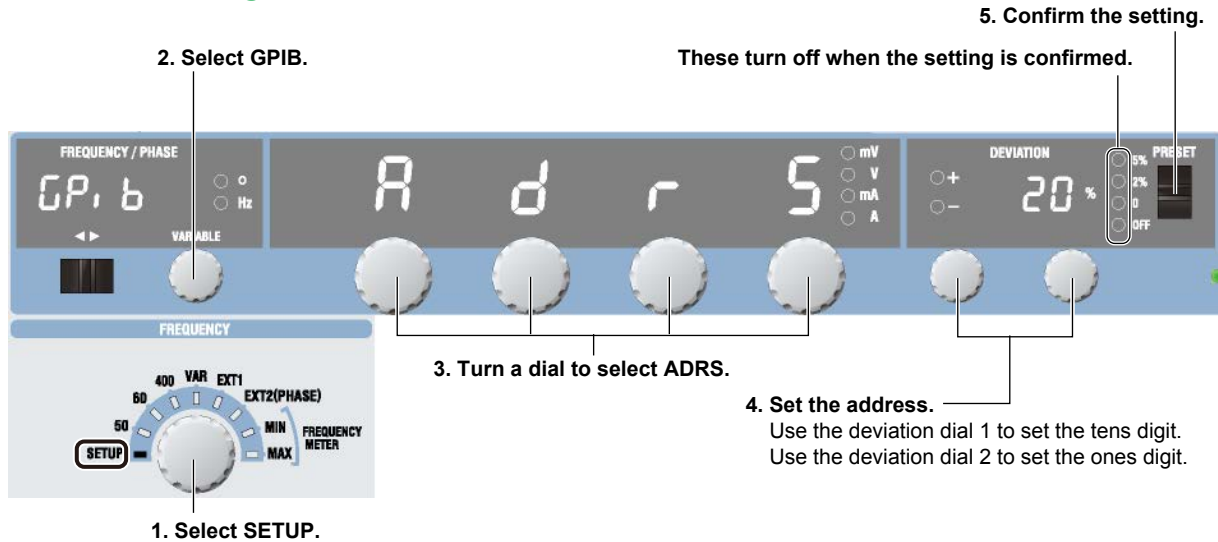

1. Turn the **FREQUENCY** dial to select SETUP.  
The indicator corresponding to the selected SETUP range illuminates, and the frequency/phase angle display area shows the SETUP menu.
2. Turn the **VARIABLE** dial to select GPIB.
3. Turn a **main setting** dial to select ADRS.
4. Turn the **deviation** dials to select the address.  
When you change the setting, all four preset indicators will illuminate.
5. Flip the **PRESET** switch up or down.  
The setting is confirmed, and all the preset indicators turn off.

#### Command Type

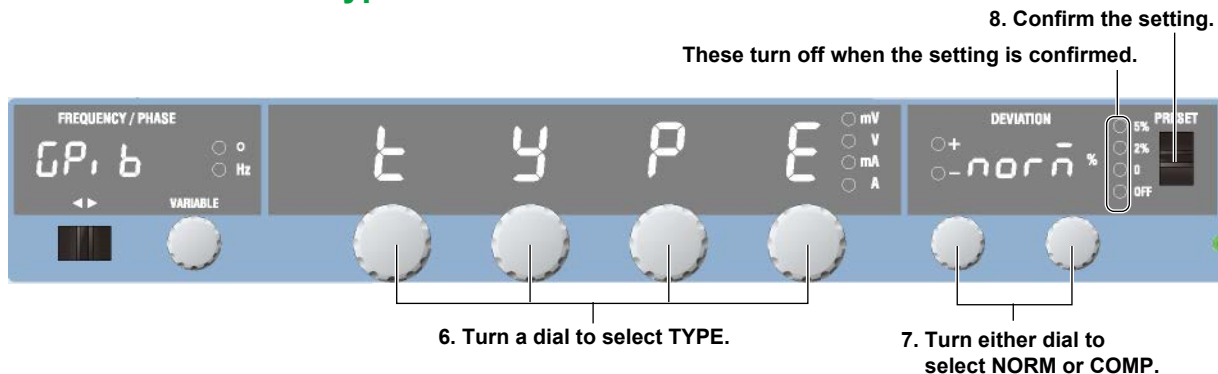

6. Turn a **main setting** dial to select TYPE.
7. Turn a **deviation** dial to select NORM or COMP.  
When you change the setting, all four preset indicators will illuminate.
8. Flip the **PRESET** switch up or down.  
The setting is confirmed, and all the preset indicators turn off.

## 11.3 Configuring the 2558A GP-IB Settings

---

### **Note**

- Only use one communication interface: USB, GP-IB, or Ethernet. If you send commands simultaneously from more than one communication interface, the 2558A will not execute the commands properly.
  - When the controller is communicating with the 2558A or with other devices through GP-IB, do not change the address.
  - Each device that is connected in a GP-IB system has its own unique address. This address is used to distinguish between different devices. Therefore, you must assign a unique address to the 2558A when connecting it to a PC or other device.
  - The command type setting takes effect when you turn the 2558A off and then back on. If you select COMP, the 2558A will not accept standard commands nor communicate using the USB or LAN interface.
- 

## **Explanation**

### **Command Type**

The 2558A is compatible with the remote control commands of its predecessor model, the 2558. Select the command type depending on your situation.

NORM: Standard commands. These commands comply with IEEE488.2 (see chapter 13).

COMP: 2558 compatible commands.

### **Notes on Using Existing Programs**

To use existing programs for the 2558 on the 2558A, insert a wait time of 3 seconds in operations that change the output. If you do not, the program may not work properly.

For details on COMP commands, see the 2558 user's manual.

## 11.4 Responses to Interface Messages

### Responses to Interface Messages

#### Responses to Uni-Line Messages

- **IFC (Interface Clear)**  
Clears the talker and listener functions. Stops data transmission if it is in progress.
- **REN (Remote Enable)**  
Switches between the remote and local modes.  
  
IDY (Identify) is not supported.

#### Responses to Multi-Line Messages (Address commands)

- **GTL (Go To Local)**  
Switches the instrument to local mode.
- **SDC (Selected Device Clear)**
  - Clears the program message (command) being received and the output queue (see section 14.5).
  - Discards \*OPC and \*OPC? commands that are being executed.
  - Immediately aborts \*WAI and COMMunicate:WAIT commands.  
PPC (Parallel Poll Configure) and TCT (Take Control) are not supported.
- **GET (Group Execute Trigger)**  
When the GP-IB command type is set to COMP (compatible commands), this command outputs information about configuration changes and operation status.

#### Responses to Multi-Line Messages (Universal commands)

- **LLO (Local Lockout)**  
Prohibits switching to local mode through the use of the OUTPUT key on the front panel.
- **DCL (Device Clear)**  
The same operation as the SDC message.
- **SPE (Serial Poll Enable)**  
Sets the talker function on all devices on the bus to serial polling mode. The controller will poll each device one by one.
- **SPD (Serial Poll Disable)**  
Clears the serial polling mode of the talker function on all devices on the bus.  
  
PPU (Parallel Poll Unconfigure) is not supported.

### What Are Interface Messages?

Interface messages are also referred to as interface commands or bus commands. They are commands that are issued by the controller. They are classified as follows:

#### Uni-line Messages

A single control line is used to transmit uni-line messages. The following three types are available.

- IFC (Interface Clear)
- REN (Remote Enable)
- IDY (Identify)

## 11.4 Responses to Interface Messages

---

### Multi-line Messages

Eight data lines are used to transmit multi-line messages. The messages are classified as follows:

- **Address Commands**

Some address commands are valid when a device is designated as a listener, and some are valid when it is designated as a talker. The following five commands are available.

Commands available to a device designated as a listener

- GTL (Go To Local)
- SDC (Selected Device Clear)
- PPC (Parallel Poll Configure)
- GET (Group Execute Trigger)

Commands available to a device designated as a talker

- TCT (Take Control)

- **Universal commands**

Universal commands are available to all devices regardless of their listener or talker designation. The following five commands are available.

- LLO (Local Lockout)
- DCL (Device Clear)
- PPU (Parallel Poll Unconfigure)
- SPE (Serial Poll Enable)
- SPD (Serial Poll Disable)

There are other interface messages: listener-address, talk-address, and secondary commands.

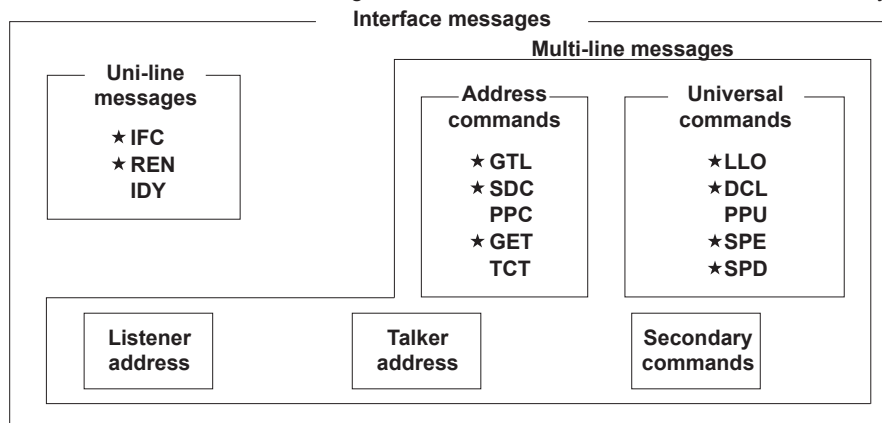

The 2558A supports interface messages marked with a ★.

### Note

---

#### Difference between SDC and DCL

In multi-line messages, SDC messages are those that require talker or listener designation and DCL messages are those that do not require a designation. Therefore, SDC messages are directed at a particular instrument while DCL messages are directed at all instruments on the bus.

---

# 12.1 Messages

## Messages

Messages are used to exchange information between the controller and the 2558A. Messages that are sent from the controller to the 2558A are called program messages, and messages that are sent from the 2558A back to the controller are called response messages. If a program message contains a command that requests a response (a query), the 2558A returns a response message upon receiving the program message. The 2558A returns a single response message in response to a single program message.

## Program Messages

The program message format is shown below.

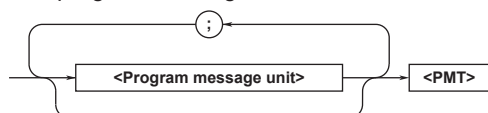

### <Program Message Unit>

A program message consists of one or more program message units. Each unit corresponds to one command. The 2558A executes the commands in the order that they are received.

Separate each program message unit with a semicolon.

For details on the program message syntax, see the next section.

Example

```
:SOURce:FUNCTION VOLTage; :SOURce:LEVel 1A
      Unit                Unit
```

### <PMT>

This is a program message terminator. The following three types are available.

- NL (new line): Same as LF (line feed). ASCII code "0AH."
- ^END: The END message as defined by IEEE 488.1 (The data byte that is sent with the END message is the last data byte of the program message.)
- NL^END: NL with an END message attached. (NL is not included in the program message.)

## Program Message Unit Syntax

The program message unit syntax is shown below.

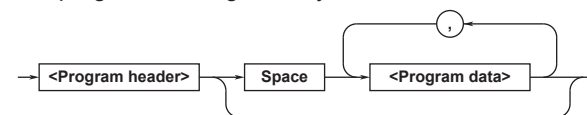

### <Program Header>

The program header indicates the command type. For details, see section 12.2.

### <Program Data>

Attach program data if there are conditions that are required to execute a command. Separate the program data from the header with a space (ASCII code 20H). If there are multiple sets of program data, separate each set with a comma.

For details, see section 12.4.

```
Example :SOURce:LEVel 1A<PMT>
          Header      Data
```

## Response Messages

The response message syntax is as follows:

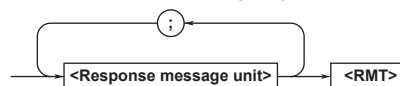

### <Response Message Unit>

A response message consists of one or more response message units. Each unit corresponds to one response.

Separate each response message unit with a semicolon.

For details on the response message syntax, see the next page.

Example

```
Unit 1
└ :SOURCE:FUNCTION VOLTAGE;
Unit 2
└ RANGE 100V
```

### <RMT>

RMT is a response message terminator. It is NL^END.



## 12.2 Commands

### Commands

There are three types of commands (program headers) that a controller may send to the 2558A. The commands differ in their program header formats.

### Common Command Header

Commands that are defined in IEEE 488.2-1992 are called common commands. The common command header syntax is shown below. Be sure to include an asterisk (\*) at the beginning of a common command.

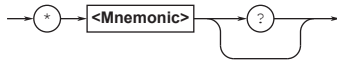

Common command example \*CLS

### Compound Header

Commands, other than common commands, that are specific to the 2558A are classified and arranged in a hierarchy according to their functions. The compound header syntax is shown below. Be sure to use a colon to specify a lower hierarchical level.

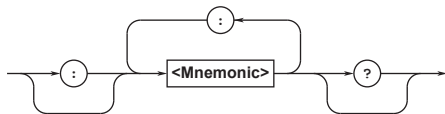

Compound header example :SOURCE:FUNCTION

### Simple Header

These commands are functionally independent and are not contained within a hierarchy. The format of a simple header is shown below.



Simple header example :OUTPUT

### Note

A <mnemonic> is an alphanumeric character string.

### When Concatenating Commands

#### • Command Groups

A command group is a group of commands that have common compound headers arranged in a hierarchy. A command group may contain sub-groups.

Example A portion of the commands from the frequency sweep command group

```
:FREQuency:INTernal:FMETer:
MAXimum
:FREQuency:INTernal:FMETer:
MINimum
```

#### • When Concatenating Commands of the Same Group

The 2558A stores the hierarchical level of the command that is currently being executed and processes the next command on the assumption that it belongs to the same level. Therefore, the common header section can be omitted for commands that belong to the same group.

Example :FREQuency:INTernal:FMETer:
MAXimum 400Hz;MINimum 40Hz

#### • When Concatenating Commands of Different Groups

If the subsequent command does not belong to the same group, place a colon in front of the header (this colon cannot be omitted).

Example :FREQuency:INTernal:FMeter:
MAXimum 400Hz;
:FREQuency:INTernal:VARiable 40Hz;

#### • When Concatenating Simple Headers

If a simple header follows another command, place a colon in front of the simple header (this colon cannot be omitted).

Example :SOURCE:LEVEL 1A;:OUTPUT ON

#### • When Concatenating Common Commands

Common commands that are defined in IEEE 488.2-1992 are independent of hierarchy. A colon is not needed before a common command.

Example :SOURCE:RANGE 10A ;\*CLS;
:SOURCE:LEVEL 1A <PMT>

#### • When Separating Commands with <PMT>

If you separate two commands with a terminator, two program messages will be sent. Therefore, the common header must be specified for each command even when commands belonging to the same command group are being concatenated.

Example :FREQuency:INTernal:FMETer:
MINimum 40Hz
:FREQuency:INTernal:FMETer:
MAXimum 400Hz



## 12.2 Commands

---

### Upper-level Query

An upper-level query is a query that is made by appending a question mark to a command higher in the group. The controller can receive all of the settings in a group collectively by executing a highest-level query. Some upper-level queries of a group, which may be comprised of more than three hierarchical levels, can cause the 2558A to transmit all the lower level settings.

**Example** :FREQUENCY?<PMT> -> :FREQUENCY:  
FUNCTION 60;INTERNAL:VARIABLE  
50.000;  
FMETER:MAXIMUM 100.000;  
MINIMUM 60.000;:FREQUENCY:EXTERN  
AL:PHASE 0.000<PMT>

The response to an upper-level query can be sent back to the 2558A as a program message. This enables the settings that were present when the upper-level query was made to be reproduced later on. However, some upper-level queries do not return setup parameters that are not currently in use. Exercise caution because not all of a group's information is necessarily returned in a response.

### Header Interpretation Rules

The 2558A interprets the header that it receives according to the rules below.

- Mnemonics are not case sensitive.  
Example "SOURce" can also be written as "source" or "SOURCE."
- The lower-case characters can be omitted.  
Example "SOURce" can also be written as "SOURc" or "SOUR."
- The question mark at the end of a header indicates that it is a query. You cannot omit the question mark.  
Example The shortest abbreviation for "SYSTem?" is "SYST?."
- Parts of commands and parameters enclosed in square brackets ( [ ] ) can be omitted.  
Example :OUTPut[:STATe] ON  
can also be written as "OUTP ON."  
However, the last section enclosed in square brackets cannot be omitted in an upper-level query.  
Example "SYSTem?" and "SYSTem:COMMunicate?" are different queries.

---

## 12.3 Responses

### Responses

When the controller sends a query with a question mark, the instrument returns a response in the following format: header+data

```
Example: SOURCE:FUNCTION? <RMT> ->
        :SOURCE:FUNCTION VOLTAGE
```

### If You Want the 2558A to Return Responses without Headers

You can configure the 2558A so that even responses that have both headers and data are returned without headers. Use the `COMMunicate:HEADer` command for this purpose.

### Abbreviated Form

The 2558A normally returns response headers with the lower-case section removed. You can configure the 2558A so that full headers are returned. Use the `COMMunicate: VERBose` command for this purpose. The sections enclosed in square brackets ([ ]) are also omitted in the abbreviated form.

## 12.4 Data

### Data

Data contains conditions and values that are written after the header. A space separates the data from the header. Data is classified as follows:

Data	Meaning
<Decimal>	A value expressed in decimal notation (Example: The denominator of the output divider ->:DIVIder:DENominator 4
<Voltage><Current> <Time>	A physical value (Example: Voltage range setting ->:SOURce:RANGe 300V
<Register>	A register value expressed as binary, octal, decimal, or hexadecimal (Example: Extended event register value -> STATUS:EESE #HFE)
<Character Data>	Predefined character string (mnemonic). Select from the available strings in braces. (Example: Select the source function ->:SOURce:FUNction {VOLTage CURRent}
<Boolean>	Indicates on and off. Specify ON, OFF, or a value. (Example: Turn the output on. ->:OUTPut:STATe ON)
<String Data>	User-defined string (Example: Ethernet IP address setting ->:SYSTem:COMMunicate:ETHernet:IP "192.168.0.1"
<Block Data>	Data that contains 8-bit values

### <Decimal>

<Decimal> indicates a value expressed as a decimal number, as shown in the table below. Decimal values are written in the NR form as specified in ANSI X3.42-1975.

Symbol	Meaning	Example
<NR1>	Integer	125 -1 +1000
<NR2>	Fixed-point number	125.0 -.90 +001.
<NR3>	Floating-point number	125.0E+0 -9E-1 +.1E4
<NRf>	Any of the forms <NR1> to <NR3>	

- The 2558A can receive decimal values that are sent from the controller in any of the forms <NR1> to <NR3>. This is expressed as <NRf>.
- The 2558A returns a response to the controller in one of the forms from <NR1> to <NR3> depending on the query. The same form is used regardless of the size of the value.
- For the <NR3> form, the plus sign after the "E" can be omitted. You cannot omit the minus sign.
- If a value outside the range is entered, the value is adjusted to the closest value within the range.
- If a value has more significant digits than are available, the value will be rounded.

### <Voltage>, <Current>, <Time>, <Frequency>, and <Phase>

<Voltage>, <Current>, <Time>, <Frequency>, and <Phase> indicate decimal values that have physical significance. A <Multiplier> or <Unit> can be attached to the form that was described earlier. Use one of the following syntaxes.

Syntax	Example
<NRf><Multiplier><Unit>	5MV
<NRf><Unit>	5E-3V
<NRf><Multiplier>	5M
<NRf>	5E-3

### <Multiplier>

Multipliers that you can use are indicated in the following table.

Symbol	Word	Multiplier
EX	Exa	10 <sup>18</sup>
PE	Peta	10 <sup>15</sup>
T	Tera	10 <sup>12</sup>
G	Giga	10 <sup>9</sup>
MA	Mega	10 <sup>6</sup>
K	Kilo	10 <sup>3</sup>
M	Milli	10 <sup>-3</sup>
U	Micro	10 <sup>-6</sup>
N	Nano	10 <sup>-9</sup>
P	Pico	10 <sup>-12</sup>
F	Femto	10 <sup>-15</sup>

### <Unit>

Units that you can use are indicated in the following table.

Symbol	Word	Meaning
V	Volt	Voltage
A	Ampere	Current
S	Second	Time
HZ	Hertz	Frequency
PCT	Percent	Percentage
DEG	Degree	Angle

- <Multiplier> and <Unit> are not case sensitive.
- "U" is used to indicate micro ( $\mu$ ).
- "MA" is used for Mega to distinguish it from Milli. However, "MA" is interpreted as milliampere for current.
- If both <Multiplier> and <Unit> are omitted, the basic unit (V, A, or S) is used.

**<Register>**

<Register> indicates an integer, and can be expressed in hexadecimal, octal, or binary as well as a decimal number. This is used when each bit of the value has a particular meaning. Use one of the following syntaxes.

Syntax	Example
<NRf>	1
#H<Hexadecimal value made up of the digits 0 to 9 and A to F>	#H0F
#Q<Octal value made up of the digits 0 to 7>	#Q777
#B<Binary value made up of the digits 0 and 1>	#B001100

- <Register> is not case sensitive.
- Response messages are always expressed in the <NR1> form.

**<Character Data>**

<Character Data> is a specified string of character data (a mnemonic). It is mainly used to indicate options and is chosen from the character strings given in { }. The data interpretation rules are the same as those described in “Header Interpretation Rules” in section 12.2.

Syntax	Example
{VOLTag CURRent}	VOLTag

- As with the header, the COMMunicate:VERBoSe command can be used to select whether to return the response in the full form or in the abbreviated form.
- The COMMunicate:HEADer setting does not affect <Character data>.

**<Boolean>**

<Boolean> is data that indicates ON or OFF. Use one of the following syntaxes.

Syntax	Example
{ON OFF <NRf>}	ON OFF 1 0

- When <NRf> is expressed in the form, “OFF” is selected if the rounded integer value is 0, and “ON” is selected for all other cases.
- A response message is always returned with a 1 if the value is ON and with a 0 if the value is OFF.

**<String Data>**

<String data> is not a specified character string like <Character data>. It is an arbitrary character string. The character string must be enclosed in single quotation marks (') or double quotation marks (").

Syntax	Example
<String Data>	'ABC' "IEEE488.2-1992"

- If a character string contains a double quotation mark ("), the double quotation mark is expressed as two consecutive quotation marks ("" ). This rule also applies to single quotation marks.
- A response message is always enclosed in double quotation marks (").
- <String data> is any character string. Therefore, the instrument assumes that the remaining program message units are part of the character string if no closing single (') or double quotation mark (") is encountered. As a result, no error is detected if a quotation mark is omitted.

**<Block Data>**

<Block data> contains 8-bit values. It is only used in response messages on the 2558A. The syntax is as follows:

Syntax	Example
#N<N-digit decimal number><Data byte sequence>	#80000010ABCDEFGHIJ

- #N  
Indicates that the data is <Block data>. N indicates the number of succeeding data bytes (digits) in ASCII code.
- <N-digit decimal number>  
Indicates the number of bytes of data (example: 00000010 = 10 bytes).
- <Data byte sequence>  
Expresses the actual data (example: ABCDEFGHIJ).
- Data is comprised of 8-bit values (0 to 255). This means that the ASCII code “0AH,” which stands for “NL,” can also be included in the data. Hence, care must be taken when programming the controller.

## 12.5 Synchronization with the Controller

### Overlap Commands and Sequential Commands

There are two types of commands: overlap and sequential.

With overlap commands, the execution of the next command may start before the execution of the previous command is finished.

With sequential commands, the execution of the next command is held until the execution of the previous command is finished (even if multiple commands are sent consecutively).

All 2558A commands are sequential commands. Even when only sequential commands are available, there are times when it is necessary to achieve synchronization to properly query the output voltage or current. For example, if you want to change the output and query the most recent output value, sending `:SOURCE:READ?` at arbitrary times will cause the 2558A to return values even before the specified output is reached. This means that the correct output after the change may not be received. If this happens, you must use the following method to synchronize to the point in time when the new output value is reached.

### Achieving Synchronization without Using Overlap Commands

- **Using the `STATUS:CONDITION?` Query**

`STATUS:CONDITION?` is used to query the contents of the condition register (see section 14.4). You can determine whether the value has reached 90% as a result of an output change by reading bit 3 of the condition register. If bit 3 of the condition register is 1, the output is less than 90%; if the bit is 0, the output has reached 90%.

Example: `SOURCE:LEVEL 1000V<PMT>`  
`:STATUS:CONDITION?<PMT>`  
(Read the response. If the bit 3 is 1, return to the previous line.)  
`:SOURCE:READ?<PMT>`  
`:SOURCE:READ?` is not executed until bit 3 in the condition register becomes 0.

- **Using the Extended Event Register**

The changes in the condition register can be reflected in the extended event register (see section 14.4).

Example: `STATUS:FILTER4`  
`FALL;:STATUS:EESE 8;`  
`EESR?;*SRE 8;:SOURCE:LEVEL`  
`1000V <PMT>`  
(Read the response to `:STATUS:EESR?`)  
(Wait for a service request)  
`:SOURCE:READ?<PMT>`

The `STATUS:FILTER4 FALL` command sets the transition filter so that bit 3 in the extended event is set to 1 when bit 3 in the condition register changes from 1 to 0.

The `:STATUS:EESE 4` command is used to only change the status byte based on bit 3 in the extended event register.

The `:STATUS:EESR?` command is used to clear the extended event register.

The `*SRE 8` command is used to generate service requests based only on the changes in the extended event register bits.

The `:SOURCE:READ?` command is not executed until a service request is generated.

- **Using the `COMMUNICATE:WAIT` Command**

The `COMMUNICATE:WAIT` command is used to wait for a specific event to occur.

Example `:STATUS:FILTER4`  
`FALL;:STATUS:EESR?;`  
`:SOURCE:LEVEL 1000V<PMT>`  
(Read the response to `:STATUS:EESR?`)  
`:COMMUNICATE:WAIT`  
`#H0008;:SOURCE:READ?`  
`<PMT>`

For a description of `:STATUS:FILTER4 FALL` and `:STATUS:EESR?`, see the previous section about the extended event register.

The `:COMMUNICATE:WAIT #H0008` command specifies that the program will wait for bit 3 in the extended event register to be set to 1. `:SOURCE:READ?` is not executed until bit 3 in the extended event register becomes 1.

## 13.1 List of Commands

Command	Function	Page
<b>CALibrate Group</b>		
For details on how to change the password and adjust the voltage and current ranges, see the following webpage. <a href="http://www.yokogawa.com/ymil/">http://www.yokogawa.com/ymil/</a>		
<b>COMMunicate Group</b>		
:COMMunicate?	Queries all communication settings.	13-3
:COMMunicate:HEADer	Sets or queries whether headers are attached to query responses.	13-3
:COMMunicate:LOCKout	Sets or queries the local lockout state.	13-3
:COMMunicate:REMOte	Sets or queries whether the 2558A is in remote or local mode.	13-3
:COMMunicate:VERBose	Sets or queries whether the response to a query is returned fully spelled out or in its abbreviated form.	13-3
:COMMunicate:WAIT	Waits for a specified extended event to occur.	13-3
:COMMunicate:WAIT?	Creates the response that is returned when a specified extended event occurs.	13-3
<b>DIVider Group</b>		
:DIVider?	Queries all output divider settings.	13-4
:DIVider:DENominator	Sets or queries the denominator of the output divider.	13-4
:DIVider:NUMerator	Sets or queries the numerator of the output divider.	13-4
<b>FREQuency Group</b>		
:FREQuency?	Queries all frequency settings.	13-5
:FREQuency:EXTernal:PHASe	Sets or queries the phase angle when EXT2 is selected.	13-5
:FREQuency:FUNCTion	Sets or queries the frequency selection.	13-5
:FREQuency:INTernal:FMETer:MAXimum	Sets or queries the maximum scale value of the frequency meter.	13-5
:FREQuency:INTernal:FMETer:MINimum	Sets or queries the minimum scale value of the frequency meter.	13-5
:FREQuency:INTernal:VARIABLE	Sets or queries the variable frequency value.	13-5
:FREQuency:READ?	Queries the current output frequency.	13-5
<b>OUTPut Group</b>		
:OUTPut[:STATe]	Sets or queries the output's on/off state.	13-6
<b>DEViation Group</b>		
:DEViation?	Queries all deviation settings.	13-7
:DEViation:VALue	Sets or queries the deviation.	13-7
:DEViation:PRESet	Sets or queries the preset value.	13-7
<b>SOURce Group</b>		
:SOURce?	Queries all source settings.	13-8
:SOURce:FUNCTion	Sets or queries the source function (voltage/current).	13-8
:SOURce:LEVel	Sets or queries the main setting.	13-8
:SOURce:RANGe	Sets or queries the voltage or current range.	13-8
:SOURce:READ?	Queries the output value (voltage or current).	13-8

## 13.1 List of Commands

### STATUS Group

:STATUS?	Queries all the settings of the communication status feature.	13-9
:STATUS:CONDition?	Queries the contents of the condition register.	13-9
:STATUS:EESe	Sets or queries the extended event enable register.	13-9
:STATUS:EESR?	Queries the contents of the extended event register and clears the register.	13-9
:STATUS:ERRor?	Queries the error code and message of the last error that has occurred (top of the error queue).	13-9
:STATUS:FILTer	Sets or queries the transition filter.	13-9
:STATUS:QENable	Sets or queries whether messages other than errors will be stored to the error queue.	13-9
:STATUS:QMESsage	Sets or queries whether message information will be attached to the response to the STATUS:ERRor? query.	13-9

### SWEep Group

:SWEep?	Queries all sweep settings.	13-10
:SWEep:DIRection	Sweeps up or down or stops sweeping. Queries the sweep state.	13-10
:SWEep:TIME	Sets or queries the sweep time.	13-10

### SYSTEM Group

:SYSTEM?	Queries all the system settings.	13-11
:SYSTEM:BEEP	Sets or queries the beep sound on/off state.	13-11
:SYSTEM:EARTh	Sets or queries the LO terminal's ground on/off state.	13-11
:SYSTEM:COMMunicate	Queries all the communication settings.	13-11
:SYSTEM:COMMunicate:GPIB?	Queries all the GP-IB communication settings.	13-11
:SYSTEM:COMMunicate:GPIB:ADDre ss	Sets or queries the GP-IB address.	13-11
:SYSTEM:COMMunicate:GPIB:TYPE	Sets or queries the GP-IB command type.	13-11
:SYSTEM:COMMunicate:ETHernet?	Queries all the Ethernet communication settings.	13-11
:SYSTEM:COMMunicate:ETHernet:DH CP	Sets or queries the Ethernet DHCP on/off state.	13-11
:SYSTEM:COMMunicate:ETHernet:IP	Sets or queries the Ethernet IP address.	13-12
:SYSTEM:COMMunicate:ETHernet:MA SK	Sets or queries the Ethernet subnet mask.	13-12
:SYSTEM:COMMunicate:ETHernet:GA TEway	Sets or queries the Ethernet default gateway.	13-12
:SYSTEM:COMMunicate:ETHernet:MA Caddress	Sets or queries the Ethernet MAC address.	13-12
:SYSTEM:REBoot	Restarts the 2558A when the specified time elapses.	13-12

### Common Command Group

*CLS	Clears the standard event register, extended event register, and error queue.	13-13
*ESE	Sets or queries the standard event enable register.	13-13
*ESR?	Queries and clears the standard event register.	13-13
*IDN?	Queries the instrument model.	13-13
*OPC	Sets bit 0 (the OPC bit) of the standard event register to 1 upon the completion of the specified overlap command.	13-13
*OPC?	Returns ASCII code 1 when the specified overlap command is completed.	13-13
*OPT?	Queries the installed options.	13-13
*RST	Initializes settings.	13-14
*SRE	Sets or queries the service request enable register value.	13-14
*STB?	Queries the Status Byte Register value.	13-14
*TST?	Executes a self-test and queries the result.	13-14
*WAI	Holds the execution of the subsequent command until the completion of the specified overlap command.	13-14

## 13.2 COMMunicate Group

The commands in this group deal with communications.

There are no front panel dials and switches that correspond to the commands in this group.

### **:COMMunicate?**

Function Queries all communication settings.

Syntax :COMMunicate?

### **:COMMunicate:HEADer**

Function Sets or queries whether headers are attached to query responses.

Syntax :COMMunicate:HEADer <Boolean>  
:COMMunicate:HEADer?

ON|1: Headers are attached.

OFF|0: Headers are not attached.

Example :COMMUNICATE:HEADER ON  
:COMMUNICATE:HEADER?  
-> :COMMUNICATE:HEADER 1

### **:COMMunicate:LOCKout**

Function Sets or queries the local lockout state.

Syntax :COMMunicate:LOCKout <Boolean>  
:COMMunicate:LOCKout?

Example :COMMUNICATE:LOCKOUT ON  
:COMMUNICATE:LOCKOUT?  
-> :COMMUNICATE:LOCKOUT 1

### **:COMMunicate:REMOte**

Function Sets or queries whether the 2558A is in remote or local mode.

Syntax :COMMunicate:REMOte <Boolean>  
:COMMunicate:REMOte?

ON|1: Remote

OFF|0: Local

Example :COMMUNICATE:REMOTE ON  
:COMMUNICATE:REMOTE?  
-> :COMMUNICATE:REMOTE 1

### **:COMMunicate:VERBose**

Function Sets or queries whether the response to a query is returned fully spelled out or in its abbreviated form.

Syntax :COMMunicate:VERBose <Boolean>  
:COMMunicate:VERBose?

ON|1: Returned fully spelled out

OFF|0: Returned in abbreviated form

Example :COMMUNICATE:VERBOSE ON  
:COMMUNICATE:VERBOSE?  
-> :COMMUNICATE:VERBOSE 1

Description

- Example of a response fully spelled out  
:CALIBRATE:RANGE 1.0E+00
- Example of a response in abbreviated form  
:CAL:RANG 1.0E+00

### **:COMMunicate:WAIT**

Function Waits for a specified extended event to occur.

Syntax :COMMunicate:WAIT <Register>  
<Register> = 0 to 65535

Example :COMMUNICATE:WAIT #H0008

Description

- For details on how to use the :COMMunicate:WAIT command to synchronize the 2558A, see section 12.5.
- For details on the extended event register, see section 14.4.

### **:COMMunicate:WAIT?**

Function Creates the response that is returned when a specified extended event occurs.

Syntax :COMMunicate:WAIT? <Register>  
<Register> = 0 to 65535

Example :COMMUNICATE:WAIT? 65535 -> 1

Description For details on the extended event register, see section 14.4.



## 13.3 DIVider Group

The commands in this group deal with the output divider settings. The commands correspond to the front panel m and n dials.

### **:DIVider?**

Function Queries all output divider settings.

Syntax :DIVider?

### **:DIVider:DENominator**

Function Sets or queries the denominator of the output divider.

Syntax :DIVider:DENominator {<NRf>|MINimum|  
MAXimum}  
:DIVider:DENominator?  
<NRf> = 4 to 15  
MINimum: 4  
MAXimum: 15

Example :DIVIDER:DENOMINATOR 4  
:DIVIDER:DENOMINATOR? -> 4

### **:DIVider:NUMerator**

Function Sets or queries the numerator of the output divider.

Syntax :DIVider:NUMerator {<NRf>|MINimum|  
MAXimum}  
:DIVider:NUMerator?  
<NRf> = 0 to 15  
MINimum: 0  
MAXimum: 15

Example :DIVIDER:NUMERATOR 4  
:DIVIDER:NUMERATOR? -> 4

Description You cannot specify a value greater than the value you specified with the :DIVider:DENominator command (denominator).

## 13.4 FREQUENCY Group

The commands in this group deal with the frequency settings. The commands correspond to the front panel FREQUENCY dial.

### **:FREQUENCY?**

Function Queries all frequency settings.

Syntax :FREQUENCY?

### **:FREQUENCY:EXTERNAL:PHASE**

Function Sets or queries the phase angle when EXT2 is selected.

Syntax :FREQUENCY:EXTERNAL:PHASE {<Phase>|  
MINIMUM|MAXIMUM}  
:FREQUENCY:EXTERNAL:PHASE?

Example :FREQUENCY:EXTERNAL:PHASE 50.000  
:FREQUENCY:EXTERNAL:PHASE?  
-> 180.000

### **:FREQUENCY:FUNCTION**

Function Sets or queries the frequency selection.

Syntax :FREQUENCY:FUNCTION {<Frequency>|VAR|  
EXT1|EXT2|FMIN|FMAX}  
:FREQUENCY:FUNCTION?

<Frequency>: 50|60|400  
50(Hz): Fixed to 50 Hz internal frequency  
60(Hz): Fixed to 60Hz internal frequency  
400(Hz): Fixed to 400Hz internal frequency  
VAR: Variable internal frequency  
EXT1: External oscillator input  
EXT2: External oscillator input (phase angle)  
FMIN: Minimum scale value of the frequency  
meter  
FMAX: Maximum scale value of the frequency  
meter  
Example :FREQUENCY:FUNCTION FMIN  
:FREQUENCY:FUNCTION? -> FMIN

### **:FREQUENCY:INTERNAL:FMETER:MAXIMUM**

Function Sets or queries the maximum scale value of the frequency meter.

Syntax :FREQUENCY:INTERNAL:FMETER:  
MAXIMUM {<Frequency>|MINIMUM|MAXIMUM}  
:FREQUENCY:INTERNAL:FMETER:MAXIMUM?  
<Frequency>: 20.000 to 999.999|1000.00

Example :FREQUENCY:INTERNAL:FMETER:  
MAXIMUM 400Hz  
:FREQUENCY:INTERNAL:FMETER:MAXIMUM?  
-> 400.000  
:FREQUENCY:INTERNAL:FMETER:MAXIMUM?  
-> 1000.00

### **:FREQUENCY:INTERNAL:FMETER:MINIMUM**

Function Sets or queries the minimum scale value of the frequency meter.

Syntax :FREQUENCY:INTERNAL:FMETER:  
MINIMUM {<Frequency>|MINIMUM|MAXIMUM}  
:FREQUENCY:INTERNAL:FMETER:MINIMUM?  
<Frequency>: 20.000 to 999.999|1000.00

Example :FREQUENCY:INTERNAL:FMETER:  
MINIMUM 400Hz  
:FREQUENCY:INTERNAL:FMETER:MINIMUM?  
-> 400.000  
:FREQUENCY:INTERNAL:FMETER:MINIMUM?  
-> 1000.00

### **:FREQUENCY:INTERNAL:VARIABLE**

Function Sets or queries the variable frequency value.

Syntax :FREQUENCY:INTERNAL:  
VARIABLE {<Frequency>|MINIMUM|MAXIMUM}  
:FREQUENCY:INTERNAL:VARIABLE?  
<Frequency>: 40.000 to 999.999|1000.00

Example :FREQUENCY:INTERNAL:VARIABLE 400Hz  
:FREQUENCY:INTERNAL:VARIABLE?  
-> 400.000  
:FREQUENCY:INTERNAL:VARIABLE?  
-> 1000.00

### **:FREQUENCY:READ?**

Function Queries the current output frequency.

Syntax :FREQUENCY:READ?

Example :FREQUENCY:READ? -> 45.000E+0  
:FREQUENCY:READ? -> 400.000E+0  
:FREQUENCY:READ? -> 1.00000E+3

Description The command returns 9.9E+37 if the input is outside the range or cannot be measured.

---

## 13.5 OUTPut Group

The command in this group deals with the output on/off setting. The command corresponds to the front panel OUTPUT switch.

### **:OUTPut [ :STATe]**

**Function** Sets or queries the output's on/off state.

**Syntax** :OUTPut[:STATe] <Boolean>

:OUTPut?

ON|1: Enabled

OFF|0: Disabled

**Example** :OUTPUT ON

:OUTPUT? -> :OUTPUT 1

## 13.6 DEVIation Group

The commands in this group deal with deviation and preset settings. The commands correspond to the front panel deviation dial and PRESET switch.

### **:DEVIation?**

Function Queries all deviation settings.

Syntax `DEVIation?`

### **:DEVIation:VALue**

Function Sets or queries the deviation.

Syntax `:DEVIation:VALue {<Percentage>|  
MINimum|MAXimum}  
:DEVIation:VALue?  
<Percentage>: -20.00(PCT) to 20.00(PCT)`

Example `:DEVIATION:VALUE -20.00  
:DEVIATION:VALUE? -> 20.00`

### **:DEVIation:PRESet**

Function Sets or queries the preset value.

Syntax `:DEVIation:PRESet {<Percentage>|OFF}  
:DEVIation:PRESet?  
<Percentage>: 0|2|5 (PCT)  
0PCT = 0%  
2PCT = 2%  
5PCT = 5%`

OFF: Presets are not used.

Example `:DEVIATION:PRESET 0  
:DEVIATION:PRESET? -> 0`

## 13.7 SOURce Group

The commands in this group deal with voltage and current range settings and output display. The commands correspond to the front panel RANGE dial, main setting dial, and OUTPUT display.

### : SOURce?

Function Queries all source settings.

Syntax :SOURce?

### : SOURce:FUNCTION

Function Sets or queries the source function (voltage/current).

Syntax :SOURce:FUNCTION {VOLTage|CURRent}  
:SOURce:FUNCTION?

VOLTage: Voltage

CURRent: Current

Example :SOURCE:FUNCTION VOLTAGE  
:SOURCE:FUNCTION? -> VOLTAGE

### : SOURce:LEVEl

Function Sets or queries the main setting.

Syntax :SOURce:LEVEl {<Current>|<Voltage>|  
MINimum|MAXimum}

<Voltage>: Voltage value

<Current>: Current value

MINimum: Minimum within the selectable range

MAXimum: Maximum within the selectable range

Example :SOURCE:LEVEL 1A  
:SOURCE:LEVEL?  
-> :SOURCE:LEVEL 1.0000E+00

Description

- Before setting <Voltage>, use the :SOURce:FUNCTION command to set the source function to voltage. Before setting <Current>, use the :SOURce:FUNCTION command to set the source function to current. If you set a main setting of a different source function, a "131: Invalid suffix" error will occur.
- The selectable range varies depending on the voltage or current range setting.

### : SOURce:RANGE

Function Sets or queries the voltage or current range.

Syntax :SOURce:RANGE {<Voltage>|<Current>}  
:SOURce:RANGE?  
<Voltage> = 100 (mV), 1, 10, 100, 300, 1000 (V)  
<Current> = 100 (mA), 1, 10, 50 (A)

Example :SOURCE:RANGE 1V  
:SOURCE:RANGE?  
-> :SOURCE:RANGE 1.0E+00

Description Before setting <Voltage>, use the :SOURce:FUNCTION command to set the source function to voltage. Before setting <Current>, use the :SOURce:FUNCTION command to set the source function to current. If you set a range of a different source function, a "131: Invalid suffix" error will occur.

### : SOURce:READ?

Function Queries the output value (voltage or current).

Syntax :SOURce:READ?

Example :SOURCE:READ?  
-> :SOURCE:READ 100.00E-03  
(Output value: 100 mV or 100 mA)  
:SOURCE:READ?  
-> :SOURCE:READ 1.0000E+00  
(Output value: 1 V or 1 A)  
:SOURCE:READ?  
-> :SOURCE:READ 10.000E+00  
(Output value: 10V or 10A)  
:SOURCE:READ?  
-> :SOURCE:READ 50.00E+00  
(Output value: 50 A)  
:SOURCE:READ?  
-> :SOURCE:READ 100.00E+00  
(Output value: 100 V)  
:SOURCE:READ?  
-> :SOURCE:READ 300.0E+00  
(Output value: 300 V)  
:SOURCE:READ?  
-> :SOURCE:READ 1.0000E+03  
(Output value: 1000 V)

Description

- The 2558A outputs the source function (voltage or current) that has been set with the :SOURce:FUNCTION command.
- If the output is off, the command returns 9.91E+37.

## 13.8 STATUS Group

The commands in this group are used to make settings and queries related to the communication status feature. There are no front panel dials and switches that correspond to the commands in this group. For information about status reports, see chapter 14.

### **:STATUS?**

Function Queries all the settings of the communication status feature.  
Syntax :STATUS?

### **:STATUS:CONDition?**

Function Queries the contents of the condition register.  
Syntax :STATUS:CONDition?  
Example :STATUS:CONDition?  
-> :STATUS:CONDition 16  
Description For information about the condition register, see chapter 14, "Status Reports."

### **:STATUS:EESE**

Function Sets or queries the extended event enable register.  
Syntax :STATUS:EESE {<Register>}  
:STATUS:EESE?  
<Register> = 0 to 65535  
Example :STATUS:EESE #7659  
:STATUS:EESE? -> :STATUS:EESE #7659  
Description For information about the extended event enable register, see chapter 14, "Status Reports."

### **:STATUS:EESR?**

Function Queries the contents of the extended event register and clears the register.  
Syntax :STATUS:EESR?  
Example :STATUS:EESR? -> :STATUS:EESR 1  
Description For information about the extended event register, see chapter 14, "Status Reports."

### **:STATUS:ERRor?**

Function Queries the error code and message of the last error that has occurred (top of the error queue).  
Syntax :STATUS:ERRor?  
Example :STATUS:ERRor?  
-> 113, "Undefined header"

### **:STATUS:FILTER**

Function Sets or queries the transition filter.  
Syntax :STATUS:FILTER<x> {BOTH|FALL|NEVer|RISE}  
:STATUS:FILTER<x>?  
<x> = 1 to 16  
Example :STATUS:FILTER2 RISE  
:STATUS:FILTER2?  
-> :STATUS:FILTER1 RISE  
Description For information about the transition filter, see chapter 14, "Status Reports."

### **:STATUS:QENable**

Function Sets or queries whether messages other than errors will be stored to the error queue.  
Syntax :STATUS:QENable {<Boolean>}  
:STATUS:QENable?  
Example :STATUS:QENABLE ON  
:STATUS:QENABLE?  
-> :STATUS:QENABLE 1

### **:STATUS:QMESsage**

Function Sets or queries whether message information will be attached to the response to the STATUS:ERRor? query.  
Syntax :STATUS:QMESsage {<Boolean>}  
:STATUS:QMESsage?  
Example :STATUS:QMESsage OFF  
:STATUS:QMESsage?  
-> :STATUS:QMESsage 0

---

## 13.9 SWEEP Group

The commands in this group deal with the sweep settings. The command corresponds to the front panel SWEEP switch.

### **:SWEEP?**

Function Queries all sweep settings.

Syntax :SWEEP?

### **:SWEEP:DIRection**

Function Sweeps up or down or stops sweeping. Queries the sweep state.

Syntax :SWEEP:DIRection {HOLD|UP|DOWN}

:SWEEP:DIRection?

HOLD: Sweeping is stopped.

UP: Sweep up to the maximum scale value

DOWN:Sweep down to the minimum scale value

Example :SWEEP:DIRection UP

:SWEEP:DIRection? -> UP

### **:SWEEP:TIme**

Function Sets or queries the sweep time.

Syntax :SWEEP:TIme <Time>

:SWEEP:TIme?

<Time> = 8, 16, 32, 64(S)

Example :SWEEP:TIme 16S

:SWEEP:TIme? -> 16

## 13.10 SYSTEM Group

The commands in this group deal with communication, ground condition, and beep settings. The commands correspond to the front panel SETUP menu commands.

### **:SYSTEM?**

Function Queries all the system settings.  
Syntax :SYSTEM?

### **:SYSTEM:BEEP**

Function Sets or queries the beep sound on/off state.  
Syntax :SYSTEM:BEEP <Boolean>  
:SYSTEM:BEEP?  
ON|1: Enabled  
OFF|0: Disabled  
Example :SYSTEM:BEEP ON  
:SYSTEM:BEEP? -> :SYSTEM:BEEP 1

### **:SYSTEM:EARTH**

Function Sets or queries the LO terminal's ground on/off state.  
Syntax :SYSTEM:EARTH <Boolean>  
:SYSTEM:EARTH?  
ON|1: Ground  
OFF|0: Not ground  
Example :SYSTEM:EARTH ON  
:SYSTEM:EARTH? -> :SYSTEM:EARTH 1

### **:SYSTEM:COMMunicate**

Function Queries all the communication settings.  
Syntax :SYSTEM:COMMunicate?

### **:SYSTEM:COMMunicate:GPIB?**

Function Queries all the GP-IB communication settings.  
Syntax :SYSTEM:COMMunicate:GPIB?

### **:SYSTEM:COMMunicate:GPIB:ADDRESS**

Function Sets or queries the GP-IB address.  
Syntax :SYSTEM:COMMunicate:GPIB:  
ADDRESS <NRf>  
:SYSTEM:COMMunicate:GPIB:ADDRESS?  
<NRf> = 0 to 30 (resolution: 1)  
Example :SYSTEM:COMMUNICATE:GPIB:ADDRESS 1  
:SYSTEM:COMMUNICATE:GPIB:ADDRESS? ->  
:SYSTEM:COMMUNICATE:GPIB:ADDRESS 1  
Description If the /C1 option is not installed, executing this command will result in error (241 Hardware missing).  
The response to this command is omitted in the response to an upper-level query. An error will not occur.

### **:SYSTEM:COMMunicate:GPIB:TYPE**

Function Sets or queries the GP-IB command type.  
Syntax :SYSTEM:COMMunicate:GPIB:  
TYPE {NORMal|COMPAtible}  
:SYSTEM:COMMunicate:GPIB:TYPE?  
NORMal: Standard commands that comply with IEEE488.2-1992  
COMPAtible: Model2558 compatible commands  
Example :SYSTEM:COMMUNICATE:GPIB:  
TYPE COMPATIBLE  
:SYSTEM:COMMUNICATE:GPIB:TYPE?  
-> :SYSTEM:COMMUNICATE:GPIB:  
TYPE COMPATIBLE

Description If the /C1 option is not installed, executing this command will result in error (241 Hardware missing).  
The response to this command is omitted in the response to an upper-level query. An error will not occur.

### **:SYSTEM:COMMunicate:ETHernet?**

Function Queries all the Ethernet communication settings.  
Syntax :SYSTEM:COMMunicate:ETHernet?

### **:SYSTEM:COMMunicate:ETHernet:DHCP**

Function Sets or queries the Ethernet DHCP on/off state.  
Syntax :SYSTEM:COMMunicate:ETHernet:  
DHCP <Boolean>  
:SYSTEM:COMMunicate:ETHernet:  
DHCP?  
ON|1: DHCP is enabled.  
OFF|0: DHCP is disabled.  
Example :SYSTEM:COMMUNICATE:ETHERNET:  
DHCP ON  
:SYSTEM:COMMUNICATE:ETHERNET:  
DHCP?  
-> :SYSTEM:COMMUNICATE:ETHERNET:  
DHCP 1



## 13.10 SYSTem Group

### **:SYSTem:COMMunicate:ETHernet:IP**

Function Sets or queries the Ethernet IP address.

Syntax :SYSTem:COMMunicate:ETHernet:  
IP <String>  
:SYSTem:COMMunicate:ETHernet:IP?  
<String> = "x.x.x.x": x = 0 to 255

Example :SYSTEM:COMMUNICATE:ETHERNET:  
IP "192.168.0.1"  
:SYSTEM:COMMUNICATE:ETHERNET:IP?  
-> :SYSTEM:COMMUNICATE:ETHERNET:  
IP "192.168.0.1"

### **:SYSTem:COMMunicate:ETHernet:MASK**

Function Sets or queries the Ethernet subnet mask.

Syntax :SYSTem:COMMunicate:ETHernet:  
MASK <String>  
:SYSTem:COMMunicate:ETHernet:MASK?  
<String> = "x.x.x.x": x = 0 to 255

Example :SYSTEM:COMMUNICATE:ETHERNET:  
MASK "255.255.255.0"  
:SYSTEM:COMMUNICATE:ETHERNET:MASK?  
-> :SYSTEM:COMMUNICATE:ETHERNET:  
MASK "255.255.255.0"

### **:SYSTem:COMMunicate:ETHernet:GATEway**

Function Sets or queries the Ethernet default gateway.

Syntax :SYSTem:COMMunicate:ETHernet:  
GATE <String>  
:SYSTem:COMMunicate:ETHernet:GATE?  
<String> = "x.x.x.x": x = 0 to 255

Example :SYSTEM:COMMUNICATE:ETHERNET:  
GATE "192.168.0.1"  
:SYSTEM:COMMUNICATE:ETHERNET:GATE?  
-> :SYSTEM:COMMUNICATE:ETHERNET:  
GATE "192.168.0.1"

### **:SYSTem:COMMunicate:ETHernet:MACaddr ess**

Function Sets or queries the Ethernet MAC address.

Syntax :SYSTem:COMMunicate:ETHernet:  
MACaddress?  
<String> = "00:00:64:xx:xx:xx"  
where xx is a value between 0 and FF

Example :SYSTEM:COMMUNICATE:ETHERNET:  
MACADDRESS "00:00:64:01:01:01"  
:SYSTEM:COMMUNICATE:ETHERNET:  
MACADDRESS?  
-> :SYSTEM:COMMUNICATE:ETHERNET:  
MACADDRESS "00:00:64:01:01:01"

### **:SYSTem:REBoot**

Function Restarts the 2558A when the specified time elapses.

Syntax :SYSTem:REBoot <Time>  
<Time> = 0(S) to 60(S)

Example :SYSTEM:REBOOT 3

## 13.11 Common Command Group

The commands in this group are defined in IEEE 488.2-1992 and are independent from the instrument's individual functions. There are no front panel dials and switches that correspond to the commands in this group.

### \*CLS

- Function Clears the standard event register, extended event register, and error queue.
- Syntax \*CLS
- Example \*CLS
- Description
- If the \*CLS command is located immediately after the program message terminator, the output queue is also cleared.
  - For information about each register and queue, see chapter 14.

### \*ESE

- Function Sets or queries the standard event enable register.
- Syntax \*ESE {<NRf>}  
\*ESE?
- <NRf> = 0 to 255
- Example \*ESE 251  
\*ESE? -> 251
- Description
- Specify the value as a sum of the values of each bit in decimal format.
  - For example, specifying \*ESE 251 will cause the standard event register to be set to 11111011. In this case, bit 2 of the standard event register is disabled. This means that bit 5 (ESB) of the status byte register is not set to 1, even if a query error occurs.
  - The default value is \*ESE 0 (all bits disabled).
  - A query using \*ESE? will not clear the contents of the standard event enable register.
  - For information about the standard event enable register, see section 14.3.

### \*ESR?

- Function Queries and clears the standard event register.
- Syntax \*ESR?
- Example \*ESR? -> 32
- Description
- A sum of the values of each bit is returned in decimal format.
  - When an SRQ is sent, you can check what types of events have occurred.
  - For example, if a value of 32 is returned, this indicates that the standard event register is set to 00100000. This means that the SRQ occurred due to a command syntax error.
  - A query using \*ESR? will clear the contents of the Standard Event Register.
  - For information about the standard event register, see section 14.3.

### \*IDN?

- Function Queries the instrument model.
- Syntax \*IDN?
- Example \*IDN?  
-> YOKOGAWA,2558A,123456789,1.01
- Description
- The information is returned in this form: <manufacture>, <model>, <serial number>, <firmware version>. For details on the model, see "Checking the Package Contents."

### \*OPC

- Function Sets bit 0 (the OPC bit) of the standard event register to 1 upon the completion of the specified overlap command.
- Syntax \*OPC
- Example \*OPC
- Description The 2558A does not have overlap commands. The OPC bit is always set to 1.

### \*OPC?

- Function Returns ASCII code 1 when the specified overlap command is completed.
- Syntax \*OPC?
- Example \*OPC? -> 1
- Description The 2558A does not have overlap commands. This command always returns 1.

### \*OPT?

- Function Queries the installed options.
- Syntax \*OPT?
- Example \*OPT? -> C1
- Description
- The command returns the presence or absence of GP-IB (C1).
  - The \*OPT? query must be the last query of a program message. An error occurs if there is a query after the \*OPT query.

## 13.11 Common Command Group

### \*RST

Function Initializes settings.

Syntax \*RST

Example \*RST

Description All settings except communication settings are reset to their factory default values.  
For details on initialization, see section 8.3.

### \*SRE

Function Sets or queries the service request enable register value.

Syntax \*SRE {<NRf>}

\*SRE?

<NRf> = 0 to 255

Example \*SRE 239

\*SRE? -> 175 (because the bit 6, MSS, setting is ignored)

Description

- Specify the value as a sum of the values of each bit in decimal format.
- For example, specifying \*SRE 239 will cause the standard enable register to be set to 11101111.  
In this case, bit 4 of the service request enable register is disabled. This means that bit 4 (MAV) of the status byte register is not set to 1, even if the output queue is not empty.
- Bit 6 (MSS) of the status byte register is the MSS bit itself and is therefore ignored.
- The default value is \*SRE 0 (all bits disabled).
- A query using \*SRE? will not clear the contents of the service request enable register.
- For information about the service request enable register, see section 14.1.

### \*STB?

Function Queries the Status Byte Register value.

Syntax \*STB?

Example \*STB? -> 4

Description

- A sum of the values of each bit is returned as a decimal value.
- Because the register is read without executing serial polling, bit 6 is an MSS bit, not an RQS bit.
- For example, if a value of 4 is returned, this indicates that the status byte register is set to 00000100.  
This means that the error queue is not empty (in other words, an error occurred).
- A query using \*STB? will not clear the contents of the status byte register.
- For information about the status byte register, see section 14.2.

### \*TST?

Function Executes a self-test and queries the result.

Syntax \*TST?

Example \*TST? -> 0

Description

- For details on the self-test, see section 15.4.
- This command returns 0 if the self-test is successful and 1 otherwise.
- It takes approximately 3 seconds for the test to complete. When receiving a response from the 2558A, set the timeout to a relatively large value.

### \*WAI

Function Holds the execution of the subsequent command until the completion of the specified overlap command.

Syntax \*WAI

Example \*WAI

Description The 2558A does not have overlap commands. This command will be ignored.

# 14.1 About Status Reports

## Status Reports

The figure below shows the format of status reports that are read by serial polling. This status report format is an extended version of the status report format defined in IEEE 488.2-1992.

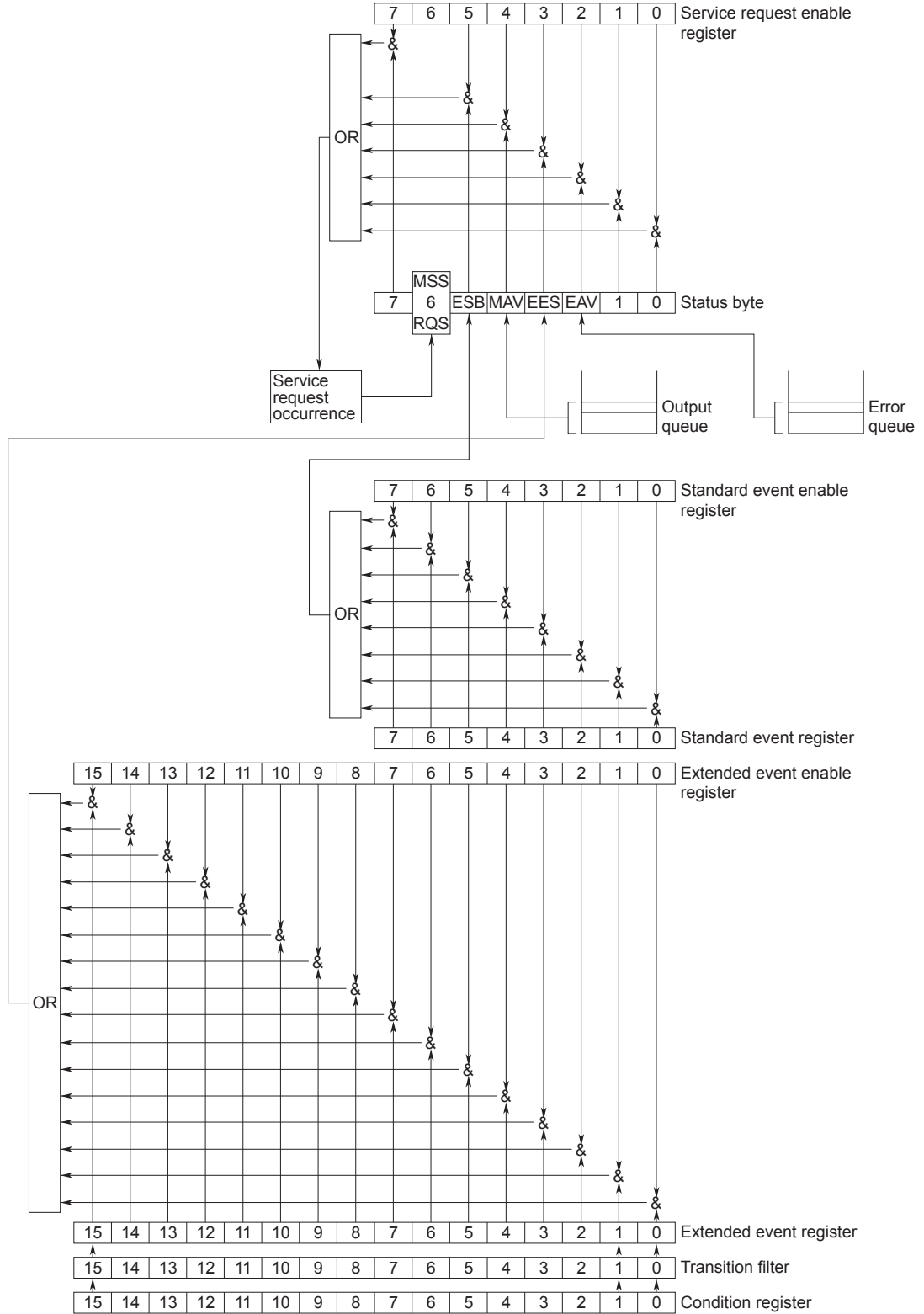

## 14.1 About Status Reports

### Overview of Registers and Queues

Name	Function	Write	Read
Status byte	—	—	Serial polling (RQS), *STB? (MSS)
Service request enable register	Status byte mask	*SRE	*SRE?
Standard event register	Indicates device status changes	—	*ESR?
Standard event enable register	Standard event register mask	*ESE	*ESE?
Extended event register	Indicates device status changes	—	STATUS:EESR?
Extended event enable register	Extended event register mask	STATUS:EESE	STATUS:EESE?
Condition register	Current device status	—	STATUS:CONDition?
Transition filter	Conditions that change the extended event register	STATUS:FILTer<x>	STATUS:FILTer<x>?
Output queue	Stores response messages for queries	Query commands	
Error queue	Stores error numbers and messages	—	STATUS:ERRor?

### Registers and Queues That Affect the Status Byte

The following registers affect the status byte bits.

Register	Affected Status Byte Bit
Standard event register	Sets bit 5 (ESB) to 1 or 0
Output queue	Sets bit 4 (MAV) to 1 or 0
Extended event register	Sets bit 3 (EES) to 1 or 0
Error queue	Sets bit 2 (EAV) to 1 or 0

### Enable Registers

The following registers are used to mask a bit so that the bit will not affect the status byte even when it is set to 1.

Masked Register	Mask Register
Status byte	Service request enable register
Standard event register	Standard event enable register
Extended event register	Extended event enable register

### Reading and Writing to Registers

For example, use the \*ESE command to set the standard event enable register bits to 1 and 0. You can use the \*ESE? command to query whether the standard event enable register bits are ones or zeros. For details on these commands, see chapter 13.

## 14.2 Status Byte

### Status Byte



- **Bits 0, 1, and 7**  
Not used (always 0)
- **Bit 2 EAV (Error Available)**  
This bit is 1 when the error queue is not empty. In other words, this bit is set to 1 when an error occurs. See section 14.5.
- **Bit 3 EES (Extend Event Summary Bit)**  
This bit is set to 1 when the logical AND of the extended event register and the extended event enable register is 1. In other words, this bit is set to 1 when a certain event takes place inside the instrument. See section 14.4.
- **Bit 4 MAV (Message Available)**  
This bit is 1 when the output queue is not empty. In other words, this bit is set to 1 when there is data to be transmitted in response to a query. See section 14.5.
- **Bit 5 ESB (Event Summary Bit)**  
This bit is set to 1 when the logical AND of the standard event register and the standard event enable register is 1. In other words, this bit is set to 1 when a certain event takes place inside the instrument. See section 14.3.
- **Bit 6 RQS (Request Service)/MSS (Master Status Summary)**  
This bit is 1 when the logical AND of the status byte excluding bit 6 and the service request enable register is 1. In other words, this bit is set to 1 when the instrument requests service from the controller. RQS is set to 1 when the MSS bit changes from 0 to 1 and is cleared when serial polling is carried out or when the MSS bit changes to 0.

### Bit Masking

To mask a bit in the status byte so that it does not cause an SRQ, set the corresponding bit of the service request enable register to 0.

For example, to mask bit 2 (EAV) so that service is not requested when an error occurs, set bit 2 of the service request enable register to 0. Do this using the \*SRE command. To query whether each bit of the service request enable register is 1 or 0, use \*SRE?. For details on the \*SRE command, see chapter 13.

### Status Byte Operation

A service request is issued when bit 6 in the status byte becomes 1. Bit 6 is set to 1 when any other bit becomes 1 (when the corresponding bit of the service request enable register is also set to 1). For example, if an event occurs and the logical OR of a standard event register bit and its corresponding enable register bit is 1, then bit 5 (ESB) is set to 1. At this point, if bit 5 of the service request enable register is 1, bit 6 (MSS) is set to 1, and the 2558A requests service from the controller.

You can check what type of event occurred by reading the contents of the status byte.

### Reading the Status Byte

There are two ways to read the contents of the status byte.

- **\*STB? Query**  
Bit 6 functions as MSS when a query is made using \*STB?. This causes the MSS to be read. This query does not cause any of the status byte bits to be cleared after the status byte is read.
- **Serial Polling**  
Serial polling causes bit 6 to function as an RQS bit. This causes the RQS to be read. After the status byte is read, only the RQS bit is cleared. You cannot read the MSS bit when serial polling is used.

### Clearing the Status Byte

There is no way to clear all the bits in the status byte. The bits that are cleared for each operation are shown below.

- **\*STB? Query**  
None of the bits are cleared.
- **Serial Polling**  
Only the RQS bit is cleared.
- **When a \*CLS Command Is Received**  
When a \*CLS command is received, the status byte itself is not cleared, but the contents of the standard event register, which affects the bits in the status byte, are cleared. As a result, the corresponding status byte bits are cleared. Because the output queue is not cleared with a \*CLS command, bit 4 (MAV) in the status byte is not affected. However, the output queue will be cleared if the \*CLS command is received just after a program message terminator.

## 14.3 Standard Event Register

### Standard Event Register

7	6	5	4	3	2	1	0
PON	URQ	CME	EXE	DDE	QYE	RQC	OPC

- **Bit 7 PON (Power ON)**  
This bit is set to 1 when the instrument is turned on.
- **Bit 6 URQ (User Request)**  
Not used (always 0)
- **Bit 5 CME (Command Error)**  
This bit is set to 1 when there is a command syntax error.  
Example Command names are misspelled, or character data that is not one of the available options has been received.
- **Bit 4 EXE (Execution Error)**  
This bit is set to 1 when the command syntax is correct, but the command cannot be executed in the current state.  
Example A command whose parameter is outside the allowable range was received.
- **Bit 3 DDE (Device Error)**  
This bit is set to 1 when a command cannot be executed for internal reasons other than a command syntax error or command execution error.
- **Bit 2 QYE (Query Error)**  
This bit is set to 1 when a query command is received, but the output queue is empty or the data is lost.  
Example There is no response data, or data is lost due to an overflow in the output queue.
- **Bit 1 RQC (Request Control)**  
Not used (always 0)
- **Bit 0 OPC (Operation Complete)**  
This bit is set to 1 upon the completion of the operation designated by the \*OPC command (see chapter 13 for details).

### Bit Masking

To mask a certain bit of the standard event register so that it does not cause bit 5 (ESB) in the status byte to change, set the corresponding bit of the standard event enable register to 0.

For example, to mask bit 2 (QYE) so that ESB will not be set to 1 even if a query error occurs, set bit 2 of the standard event enable register to 0. Do this using the \*ESE command. To query whether each bit of the standard event enable register is 1 or 0, use \*ESE?. For details on the \*ESE command, see chapter 13.

### Standard Event Register Operation

The standard event register indicates eight types of events that occur inside the instrument. When one of the bits in this register becomes 1 (and the corresponding bit of the standard event enable register is also 1), bit 5 (ESB) in the status byte is set to 1.

Example

1. A query error occurs.
2. Bit 2 (QYE) is set to 1.
3. When bit 2 of the standard event enable register is 1, bit 5 (ESB) in the status byte is set to 1.

You can also check what type of event occurred in the 2558A by reading the contents of the standard event register.

### Reading the Standard Event Register

You can use the \*ESR? command to read the contents of the standard event register. The register is cleared after it is read.

### Clearing the Standard Event Register

The standard event register is cleared in the following three cases.

- When the contents of the standard event register are read using the \*ESR command.
- When a \*CLS command is received.
- When the 2558A is restarted.

## 14.4 Extended Event Register

The extended event register receives information about changes in the condition register, which indicates the instrument's internal condition. The information is the result of edge detection performed by the transition filter.

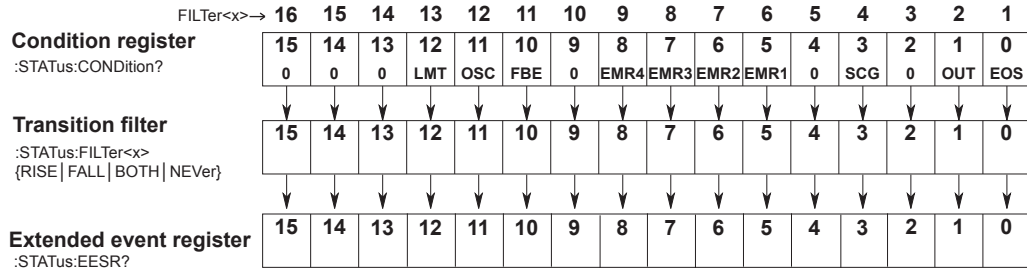

The condition register bits are described below.

Bit 0	EOS (End of Sweep)	Set to 1 during a sweep operation. EOS changing from 1 to 0 indicates that sweeping has been completed (held).
Bit 1	OUT (Output ON)	Set to 1 during output.
Bit 3	SCG (Source Change)	When the output value is changed, this bit is 1 until the output reaches 90% of the value.
Bit 5	EMR1 (FAN Stop)	Set to 1 when the cooling fan stops.
Bit 6	EMR2 (Temprature Error)	Set to 1 when an abnormal temperature is detected inside the 2558A.
Bit 7	EMR3 (Amplitude Temprature Error)	Set to 1 when an abnormal amplifier temperature is detected inside the 2558A.
Bit 8	EMR4 (Internal Power Error)	Set to 1 when an internal power supply error is detected in side the 2558A.
Bit 10	FBE (Feedback Error)	Set to 1 when a feedback correction error is detected.
Bit 11	OSC (Oscillating)	Set to 1 when an amplifier oscillation error is detected.
Bit 12	LMT (Limting)	Set to 1 when an overload is detected.

The transition filter parameters detect changes in the specified condition register bits (numeric suffixes 1 to 16) and overwrite the extended event register in the following ways.

RISE	The specified extended event register bit is set to 0 when the corresponding condition register bit changes from 0 to 1.
FALL	The specified extended event register bit is set to 1 when the corresponding condition register bit changes from 1 to 0.
BOTH	The specified extended event register bit is set to 1 when the corresponding condition register bit changes from 0 to 1 or from 1 to 0.
NEVer	Always zero.



## 14.5 Output and Error Queues

### Output Queue

The output queue stores query response messages. For example, if you send a `:SOURCE:READ?` command, which requests for the transmission of voltage or current output value, the response message is stored in the output queue until it is read.

As shown below, error messages are stored in order and read from the oldest message first. The output queue is cleared in the following cases.

- When a new message is received from the controller.
- When a deadlock occurs (see section 12.1).
- When a device clear command (DCL or SDC) is received.
- When the 2558A is restarted.

The `*CLS` command does not clear the output queue. You can determine whether or not the output queue is empty by checking bit 4 (MAV) in the status byte.

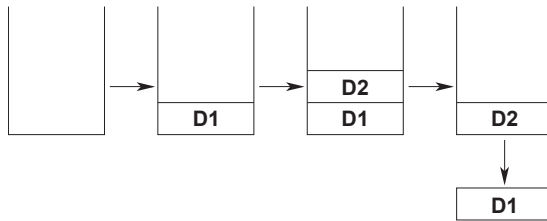

### Error Queue

When an error occurs, the error queue stores the error number and message. For example, if the instrument receives an incorrect program message from the controller, the error number (113) and the error message (“Undefined header”) are stored in the error queue when the instrument displays the error message.

You can use the `:STATUS:ERROR?` query to read the contents of the error queue. Like the output queue, the messages in the error queue are read from the oldest one first.

If the error queue overflows, the last message is replaced with the following message: 350, “Queue overflow”

The error queue is cleared in the following cases.

- When a `*CLS` command is received.
- When the 2558A is restarted.

You can determine whether or not the error queue is empty by checking bit 2 (EAV) in the status byte.

## 15.1 Troubleshooting

### Faults and Corrective Actions

- If an error code appears on the output display, see section 15.2.
- If servicing is necessary, or if the instrument does not operate properly even after you have attempted to deal with the problem according to the instructions in this section, contact your nearest YOKOGAWA dealer.

Problems and Solutions	Refer to Section
Nothing appears on the 7-segment LED display when you turn on the power.	
Securely connect the power cord to the instrument and to the power outlet.	3.3
Set the supply voltage and frequency to within the permitted range.	3.3
The output does not turn on.	
Confirm that the ambient temperature and humidity are within their specified ranges.	3.2
Check that the inlet and outlet holes are not blocked.	3.2
Check the cable wiring.	3.7, 5.3
Turn the power off and then on again.	3.4
Dials and switches do not work.	
Check the REMOTE indicator. If the REMOTE indicator is on, flip the OUTPUT switch down to turn off the indicator.	1.1, 1.2
The external oscillator frequency cannot be monitored. The phase angle is not displayed.	
Check the signal connection.	7.1
Check that the frequency setting is EXT1 (frequency monitor).	5.2
Check that the frequency setting is EXT2 (PHASE; phase angle display).	5.2
Unable to configure or control the instrument through the communication interface.	
Check to make sure that the GP-IB address setting matches the specifications.	11.3
Check to make sure that the TCP/IP settings match the specifications.	10.3
Confirm that the interface meets the electrical and mechanical specifications.	10.1, 11.1

## 15.2 Error Code Descriptions and Corrective Actions

This section explains error codes that may appear on the front panel.

### Error Codes

If any of the following error codes appears, the instrument will beep intermittently. Immediately turn off the power. Servicing is required.

Code	Description
E.901	The cooling fan error has detected.
E.902, E.903	Internal temperature error has been detected.
E.904	Internal circuit error has been detected.

### Error Codes That Appear at Power-on or during the Self-test

If any of the following error codes appears, servicing is required. If the error appears at power-on, the instrument beeps.

Code	Description
E.911 to E.914	Internal circuit error has been detected.
E.915	The cooling fan error has detected.
E.921 to E.934	Internal circuit error has been detected.
E.941	The 100 mV range error has detected.
E.942	The 1 V range error has detected.
E.943	The 10 V range error has detected.
E.944	The 100 V range error has detected.
E.945	The 300 V range error has detected.
E.946	The 1000 V range error has detected.
E.947	The 100 mA range error has detected.
E.948	The 1 A range error has detected.
E.949	The 10 A range error has detected.
E.950	The 50 A range error has detected.

### Warning Codes

Code	Description	Corrective Action	Refer to Section
E.031	Amplitude control error has been detected.	Check the external signal input terminal connection. Check the wiring of the voltage or current terminals. Check the load connected to the voltage or current terminals.	7.1 3.6 3.5
E.032	Voltage amplifier oscillation error has been detected.	Check the external signal input terminal connection. Check the wiring of the voltage terminals. Check the load connected to the voltage terminals.	7.1 3.6 3.5
E.033	Current amplifier oscillation error has been detected.	Check the external signal input terminal connection. Check the wiring of the current terminals. Check the load connected to the current terminals.	7.1 3.6 3.5
E.034	Overvoltage load has been detected.	Check the wiring of the current terminals. Check the load connected to the current terminals.	3.6 3.5
E.035	Overcurrent load has been detected.	Check the wiring of the voltage terminals. Check the load connected to the voltage terminals.	3.6 3.5
E.036	External input level error has been detected.	Check the external input level.	7.1

## 15.3 Communication Error Messages

This section explains communication error messages.

- Error messages that are read from a PC such as through the :STATus:ERRor? command are output in English.
- If servicing is necessary to solve the problem indicated by a message, contact your nearest YOKOGAWA dealer.
- The error messages described here are only those that you can read with the :STATus:ERRor? command from a PC. For other messages, which are displayed on the front panel, see section 15.2.

### Communication Syntax Errors (100 to 199)

Code	Message	Corrective Action	Page
102	Syntax error.	A syntax error not covered by error codes 100 to 199.	Chapter 12, chapter 13
103	Invalid separator.	Separate data values with a comma.	12-1
104	Data type error.	See page 12-6 and 12-7 and use the correct data type for each parameter.	12-6 and 12-7
108	Parameter not allowed.	Check the number of data values.	12-6, Chapter 13
109	Missing parameter.	Be sure to include all necessary data values.	12-6 and chapter 13
111	Header separator error.	Use a comma to separate each header from its data.	12-1
112	Program mnemonic too long.	Check the command length.	Chapter 13
113	Undefined header.	Check the header.	Chapter 13
114	Header suffix out of range.	Check the header.	Chapter 13
120	Numeric data error.	A value must be specified where the syntax contains <NRf>.	12-6
123	Exponent too large.	Where the syntax contains <NR3>, make the exponent that follows E smaller.	12-6 and chapter 13
124	Too many digits.	Limit numeric values to 255 digits or less.	12-6 and chapter 13
128	Numeric data not allowed.	Use a data type other than <NRf>.	12-6 and chapter 13
131	Invalid suffix.	Check the unit of <Voltage>, <Current>, <Time>, <Frequency>, or <Phase>.	12-6
134	Suffix too long.	Check the unit of <Voltage>, <Current>, <Time>, <Frequency>, or <Phase>.	12-6
138	Suffix not allowed.	Only the following units can be used: <Voltage>, <Current>, <Time>, <Frequency>, <Phase>.	12-6
141	Invalid character data.	Be sure to select one of the listed choices when the syntax contains {... ... ...}.	Chapter 12, chapter 13
144	Character data too long.	Check the spelling of the strings when the syntax contains {... ... ...}.	Chapter 13
148	Character data not allowed.	Use a data type other than {... ... ...}.	Chapter 13
150	String data error.	Enclose parameters with single or double quotation marks where the syntax contains <String>.	12-7
151	Invalid string data.	The <String> is either too long, or it contains an unusable character.	Chapter 13
158	String data not allowed.	Use a data type other than <String>.	Chapter 13
161	Invalid block data.	<Block data> cannot be used.	12-7 and chapter 13
168	Block data not allowed.	<Block data> cannot be used.	5-7 and chapter 6
171	Missing Right	Mathematical operations cannot be used.	—
172	Invalid expression.	Mathematical operations cannot be used.	Chapter 13
178	Expression data not allowed.	Mathematical operations cannot be used.	Chapter 13
181	Invalid outside macro definition.	The 2558A does not support the IEEE 488.2 macro specifications.	—

## Communication Execution Errors (200 to 299)

Code	Message	Corrective Action	Page
203	Command protected	See "Adjustment and Calibration" in section 15.8.	15-11
221	Setting conflict.	Check settings that are related to each other.	Chapter 13
222	Data out of range.	Check the ranges of the settings.	Chapter 13
223	Too much data.	Check data byte lengths.	Chapter 13
224	Illegal parameter value.	Check the ranges of the settings.	Chapter 13
225	OverFlow.	Keep program messages to 1024 bytes or less in length, including <PMT>.	12-2
226	Out Of Memory.	Keep program messages to 1024 bytes or less in length, including <PMT>.	12-2
241	Hardware missing.	Check that the specified options are all installed.	—
260	Expression error.	Mathematical operations cannot be used.	—
270	Macro error.	The 2558A does not support the IEEE 488.2 macro specifications.	—
272	Macro execution error.	The 2558A does not support the IEEE 488.2 macro specifications.	—
273	Illegal macro label.	The 2558A does not support the IEEE 488.2 macro specifications.	—
275	Macro definition too long.	The 2558A does not support the IEEE 488.2 macro specifications.	—
276	Macro recursion error.	The 2558A does not support the IEEE 488.2 macro specifications.	—
277	Macro redefinition not allowed.	The 2558A does not support the IEEE 488.2 macro specifications.	—
278	Macro header not found.	The 2558A does not support the IEEE 488.2 macro specifications.	—

## Communication Query Errors (400 to 499)

Code	Message	Corrective Action	Page
410	Query INTERRUPTED.	Check the transmission and reception order.	12-2
420	Query UNTERMINATED.	Check the transmission and reception order.	12-2
430	Query DEADLOCKED.	Keep program messages to 1024 bytes or less in length, including <PMT>.	12-2
440	Query UNTERMINATED after indefinite response. Do not write a query after *IDN? or *OPT?.		—

## System Communication Errors (300 and 399)

Code	Message	Corrective Action	Page
300	Communication device-specific error.	Servicing is required.	—
399	Fatal error in the communication driver.	Servicing is required.	—

## Communication Warning (50)

Code	Message	Corrective Action	Page
50	*OPC/? exists in message.	Write *OPC or *OPC? at the end of program messages.	—

## Other Errors (350)

Code	Message	Corrective Action	Page
350	Queue overflow.	Read the error queue.	12-6

### Note

Code 350 occurs when the error queue overflows.

## Information (1 to 99)

Code	Message	Corrective Action	Page
51	Sweeping in progress.	You can only make changes when sweeping is held.	5-12 and 6-9
52	The upper and lower sweep limits are set to the same value.	Check the upper and lower sweeping limits.	5-13 and 6-10
53	The output is off.	Sweeping is not possible because the output is off. Turn the output on.	5-8, 6-6

## 15.3 Communication Error Messages

---

### Execution Errors (800 to 899)

Code	Message	Corrective Action	Page
802	Invalid command.	CAL on the SETUP menu cannot be executed during adjustment mode.	4-2
804	Invalid command.	Cannot be executed because the communication command type is set to COMP (compatible mode).	11-5

### System Errors (900 to 999)

Code	Message	Corrective Action	Page
911 to 950	CPU board error.	For details about the message and corrective action, see section 15.2.	15-2

---

## 15.4 Instrument Error Detection and Clearance

### Trip Detection

When voltage or current is being generated, if a load that would cause the output range to be exceeded is connected, the instrument will detect the abnormal load and automatically turn off (trip) the output. If tripping occurs, an error code is displayed on the output display. Connect a load that is within the output range. For more details on error codes, see “Warning Codes” in section 15.2.

#### Clearing the Error Display

Flip the OUTPUT switch down (OFF) to clear the error display.

Flip the OUTPUT switch up (OFF) to clear the error display and turn the output on.

### High Voltage Notification

If you set the voltage output to 150 V or higher, beeps will be generated.

If you set the voltage range to 300 V or higher, the HIGH VOLTAGE indicator will illuminate.

This feature is to warn you of the risk of electric shock due to high voltage.

It is not a malfunction.

#### Clearing of the Notification

Beeping stops when the voltage output falls below 150 V.

The HIGH VOLTAGE indicator turns off when you set the voltage range below 300 V.



# 15.5 Self-test

## Procedure

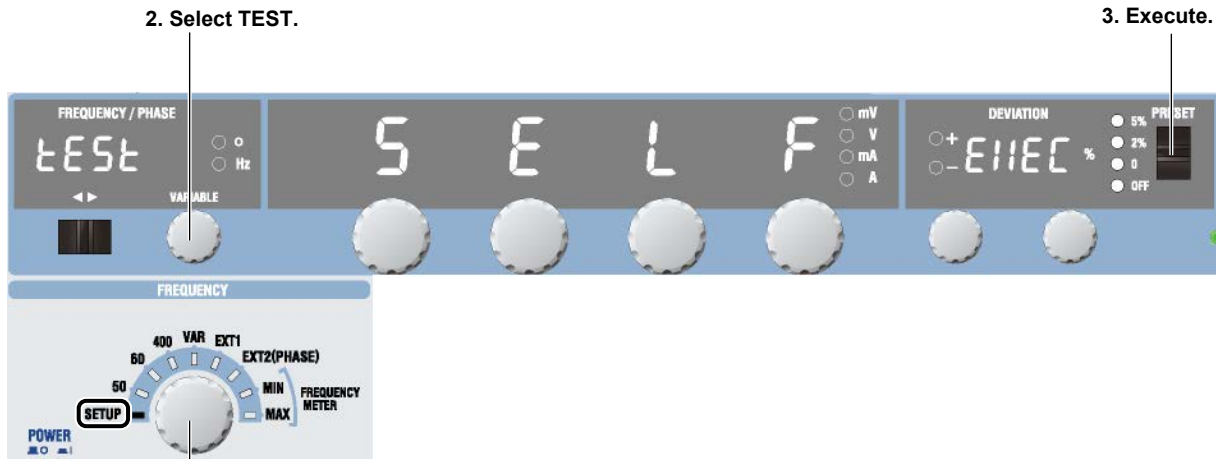

1. Select SETUP.

1. Turn the **FREQUENCY** dial to select SETUP.  
The indicator corresponding to the selected SETUP range illuminates, and the frequency/phase angle display area shows the SETUP menu.
2. Turn the **VARIABLE** dial to select TEST.
3. Flip the **PRESET** switch up or down.  
The self-test starts.

## Explanation

While the self-test is in progress, the test item is displayed on the deviation display. When a self-test completes successfully, the OUTPUT display shows "DONE." If an error is detected, the display shows the error code. The deviation display will show EXIT. If you flip the PRESET switch up or down the OUTPUT display is cleared, and the deviation display returns to the original EXEC display. For details on error codes, see section 15.2.

### Displays the self-test item



**Displays the self-test result**  
Normal completion: DONE  
Error detected: Error code

### Test Items

- Cooling fan
- Voltage and current ranges
- Internal circuit

## 15.6 Cleaning the Filter



### CAUTION

If the filter attached to the Inlet holes is dirty, the air intake may be obstructed causing the instrument to heat up and break down.

### French



### ATTENTION

Si le filtre raccordé aux orifices d'entrée est poussiéreux, l'admission d'air risque de s'obstruer, ce qui risque d'entraîner une surchauffe de l'équipement et sa panne.

There is a filter attached to the Inlet holes on the rear panel of the 2558A.  
Check the filter periodically to see that it is not clogged.

### Removing the Filter

1. Turn off the 2558A.
2. Pull the lock buttons at the left and right edges of the filter cover toward you.  
Pull them until you hear a click. This will release the lock.

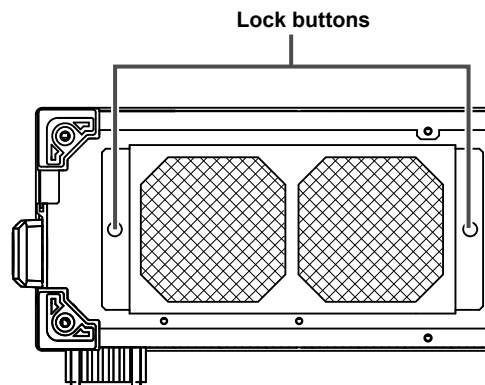

3. Pull the filter cover toward you.  
The filter cover will come off.
4. Remove the filter from the filter cover.

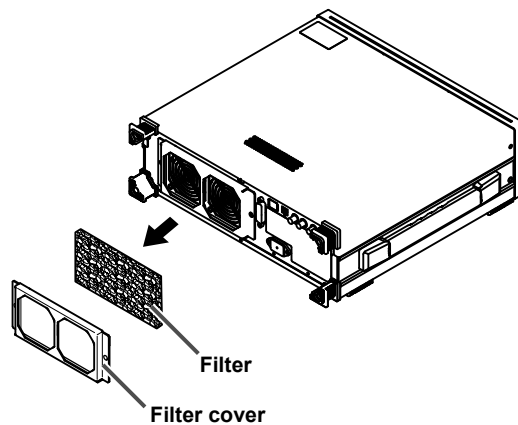

### Attaching the Filter

1. Attach the filter to the filter cover.  
There is no front or back distinction.
2. Insert the filter cover lock buttons into the filter cover attachment holes on the rear panel.  
Make sure that the locks are released.
3. Push the lock buttons.  
Push them until you hear a click.

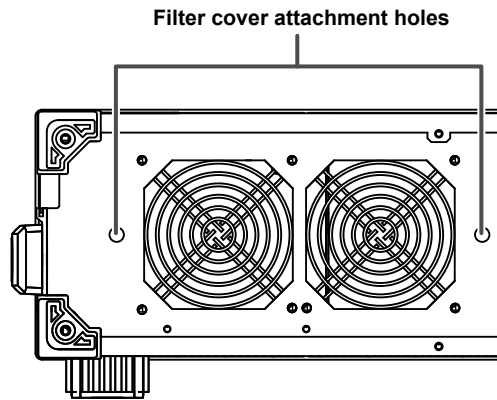

### Cleaning the Filter

Clean the filter with neutral detergent.  
Rinse well with tap water. Drain off excess water.  
To do so do not wring the filter; swing it up and down.  
After cleaning, let the filter dry naturally.

#### **Note**

If the filter is clogged, the temperature inside the 2558A will increase and will affect the operation and performance.

Check the filter once three months. How fast the filter gets dirty depends on the environment.

If the filter is extremely dirty and cannot be cleaned completely, you need to replace the filter. Contact your nearest YOKOGAWA dealer.

---

## 15.7 Recommended Part Replacement

The life and replacement period for expendable items varies depending on the conditions of use. Refer to the table below as a general guideline.

For part replacement and purchase, contact your nearest YOKOGAWA dealer.

Part Name	Recommended Replacement Interval
Cooling fan	3 years
Filter	1 year
Output relay <sup>1</sup>	Approx. 25000 operations

1 The number of relay operations may increase if the relay is controlled with the communication (USB, Ethernet, or GP-IB) feature.

## 15.8 Adjustment and Calibration

### Adjustment

The 2558A should be adjusted by a qualified engineer at a qualified facility with sufficient precision. For information on how to adjust the 2558A, see the following webpage. To download the information, you need to register.

<http://tmi.yokogawa.com/products/generators-sources/standard/2558a-ac-voltage-current-standard/>

### Calibration

We recommend that you calibrate the 2558A once every 180 days to assure its accuracy. Contact your nearest YOKOGAWA dealer to have your 2558A calibrated.

## 16.1 Output

### Output

#### AC Voltage

Range	Output range	Guaranteed Accuracy Range <sup>1</sup>	Resolution	Maximum Output <sup>2</sup>	Output Resistance <sup>3</sup>
100 mV	0 mV to 144.00 mV	1% to 120%	10 $\mu$ V	—	Approx. 10 $\Omega$
1 V	0 V to 1.4400 V	1% to 120%	100 $\mu$ V	0.5 A or greater	Approx. 6 m $\Omega$
10 V	0 to 14.400 V	1% to 120%	1 mV	Approx. 3 A	Approx. 6 m $\Omega$
100 V	0 V to 144.00 V	1% to 120%	10 mV	Approx. 0.3 A	Approx. 6 m $\Omega$
300 V	0 V to 432.0 V	1% to 120%	100 mV	Approx. 0.1 A	Approx. 6 m $\Omega$
1000 V	0 V to 1440.0 V	1% to 120%	100 mV	Approx. 6 mA	Approx. 6 m $\Omega$

#### AC Current

Range	Output range	Guaranteed Accuracy Range <sup>1</sup>	Resolution	Maximum Output <sup>2</sup>
100 mA	0 mA to 144.00 mA	1% to 120%	10 $\mu$ A	Approx. 15 V
1 A	0 A to 1.4400 A	1% to 120%	100 $\mu$ A	Approx. 15 V
10 A	0 A to 14.400 A	1% to 120%	1 mA	Approx. 3 V
50 A	0 A to 72.00 A	1% to 120%	10 mA	Approx. 0.6 V

1 1% to 144% when the output frequency is 50 Hz or 60 Hz.

2 With the voltage or current at 1% to 120% of the range.

3 When <758933> or <758917> is in use; excluding aging and the effects of measurement leads.

## 16.2 Accuracy

Item	Specifications	
AC Voltage	Conditions: Frequency:	Using the internal oscillator
	Temperature, humidity:	23°C±3°C, 20%RH to 80%RH When the temperature is in the range of 5°C to 20°C or 26°C to 40°C, add the temperature coefficient.
	Output terminals:	LO terminal grounding
	Measurement bandwidth:	Up to 50 kHz

Output range: 10% to 120% of range

Range	Display Resolution	Accuracy (180 days), ±(% of Setting + % of Range) <sup>1,2</sup>		
		50 Hz/60 Hz	40 Hz ≤ f ≤ 400 Hz	400 Hz < f ≤ 1 kHz
100 mV	10 μV	0.03 + 0.01 <sup>3</sup>	0.05 + 0.01	0.10 + 0.02
1 V	100 μV			
10 V	1 mV			
100 V	10 mV			
300 V	10 mV			
1000 V	100 mV			

Output range: 1% to 10% of range

Range	Display Resolution	Accuracy (180 days), ±(% of Range) <sup>1,4</sup>		
		50 Hz/60 Hz	40 Hz ≤ f ≤ 400 Hz	400 Hz < f ≤ 1 kHz
100 mV	10 μV	0.013	0.015	0.03
1 V	100 μV			
10 V	1 mV			
100 V	10 mV			
300 V	10 mV			
1000 V	100 mV			

- 1 Excludes voltage drop due to the output resistance
- 2 Add ±(0.01% of Setting) for the 1 year accuracy.
- 3 For all voltage and current ranges, if the output range is between 120% to 144% of the range and the output frequency is 50 Hz or 60 Hz, add 0.1% of range to the accuracy.
- 4 Add ±(0.001% of Range) for the 1 year accuracy.

Item	Specifications	
AC Current	Conditions: Frequency:	Using the internal oscillator
	Temperature, humidity:	23°C±3°C, 20%RH to 80%RH When the temperature is in the range of 5°C to 20°C or 26°C to 40°C, add the temperature coefficient.
	Output terminals:	LO terminal grounding
	Measurement bandwidth:	Up to 50 kHz

Output range: 10% to 120% of range

Range	Display Resolution	Accuracy (180 days), ±(% of Setting + % of Range) <sup>1</sup>		
		50 Hz/60 Hz	40 Hz ≤ f ≤ 400 Hz	400 Hz < f ≤ 1 kHz
100 mA	10 μA	0.04 + 0.01 <sup>2</sup>	0.06 + 0.01	0.12 + 0.02
1 A	100 μA			
10 A	1 mA			
50 A	1 mA			

Output range: 1% to 10% of range

Range	Display Resolution	Accuracy (180 days), ±(% of Range) <sup>3</sup>		
		50 Hz/60 Hz	40 Hz ≤ f ≤ 400 Hz	400 Hz < f ≤ 1 kHz
100 mA	10 μA	0.014	0.016	0.032
1 A	100 μA			
10 A	1 mA			
50 A	1 mA			

- 1 Add ±(0.0015% of Range) for the 1 year accuracy.
- 2 For all voltage and current ranges, if the output range is between 120% to 144% of the range and the output frequency is 50 Hz or 60 Hz, add 0.1% of range to the accuracy.
- 3 Add ±(0.015% of Setting) for the 1 year accuracy.

Item	Specifications
Stability	$\pm(20 \text{ ppm of setting} + 30 \text{ ppm of range})$ Conditions: Output value: 1% to 120% of range Frequency: Using the internal oscillator Output terminals: LO terminal grounding Temperature, humidity: $23^{\circ}\text{C} \pm 3^{\circ}\text{C}$ , 20%RH to 80%RH, no fluctuation Other conditions: No fluctuation (such as wind) Time: From 1 minute after the output is turned on to 1 hour
Temperature coefficient	50 Hz/60 Hz: $\pm 30 \text{ ppm}/^{\circ}\text{C}$ of setting, at $5^{\circ}\text{C}$ to $20^{\circ}\text{C}$ and $26^{\circ}\text{C}$ to $40^{\circ}\text{C}$ Other frequencies: 40 Hz to 1 kHz $\pm 50 \text{ ppm}/^{\circ}\text{C}$ of setting, at $5^{\circ}\text{C}$ to $20^{\circ}\text{C}$ and $26^{\circ}\text{C}$ to $40^{\circ}\text{C}$
Response time	Approx. 2 s, at 0 -> 100% of the setting (until the output converges to 0.02% of the last value)
Distortion factor	Voltage output: 0.07% or less Current output: 0.18% or less Conditions: Frequency range: 40 Hz to 1 kHz Load: Pure resistance The load current during voltage generation and the load voltage during current generation are less than or equal to 20% of the maximum output Range Generated: 40% to 120% of range But, 40% to 144% when the output frequency is 50 Hz or 60 Hz
Internal oscillator accuracy	$\pm 50 \text{ ppm}/180 \text{ days}$ , $\pm 100 \text{ ppm}/\text{year}$ Conditions: Temperature: $5^{\circ}\text{C}$ to $40^{\circ}\text{C}$ Humidity: 20%RH to 80%RH

## 16.3 Functions

Item	Specifications
Frequency range	
Mode	Internal oscillators, external oscillator, FREQUENCY METER
Internal oscillators	50 Hz, 60 Hz, 400 Hz: Fixed frequencies VAR: Variable frequency 40 Hz to 1000 Hz (0.001 Hz resolution)
External oscillator	Using the synchronous operation input terminal EXT1: Receives a single signal EXT2: Receives two signals (90° phase difference), phase shift feature available Phase shift range –180.000° to +359.999° (0.001° resolution)
FREQUENCY METER	Assign sweep, output divider, and deviation output features to frequencies MIN: Lower frequency limit MAX: Upper frequency limit Upper and lower frequency limit range: 20 Hz to 1000 Hz (resolution is the same as VAR) Lower sweep frequency limit: 20 Hz Upper sweep frequency limit: 1000 Hz
Sweep function	
Target	Deviation and output divider settings and their related voltage, current, and frequency
Speed	0% to 100% or 100% to 0% of the setting; select from approx. 8 s, 16 s, 32 s, 64 s
Output divider feature <sup>1</sup>	
Target	Voltage, current, frequency
Denominator range	m : 4, 5, . . . 15 (12 divisions)
Numerator range	n : 0, 1, . . . 15 (where n ≤ m)
Deviation output feature <sup>1</sup>	
Source	Voltage, current, frequency
Variable range	±20.00%
Setting method	Two dial setting Resolution of dial 1: 0.2% of main setting Resolution of dial 2: 0.01% of main setting
Preset feature	
5%	The deviation is set to ±5% when the preset value is changed or when the output divider n is changed. (+5% when increased, –5% when decreased)
2%	The deviation is set to ±2% when the preset value is changed or when the output divider n is changed. (+2% when increased, –2% when decreased)
0	The deviation is reset to 0 when the preset value is changed or when the output divider n is changed.
OFF	The deviation is held. (Preset is not applied.)
1	Equation for setting (setting) = (main setting) X (n/m) + (main setting) X (–deviation) The upper output limit is obtained by adding 20% to the value given in section 16.1, “Range Generated.” The accuracy is according to section 16.2, “Accuracy.”
Output terminals	
Output terminal type	Voltage: Plug-in terminal (safety terminal) Current: Large binding post
Output LO terminal	Ground or not ground selectable Withstand voltage to ground when open: 12 Vpk
Displays	Main setting display: 5-digit LED display Output divider coefficient display: 2-digit LED display for numerator and denominator Output display: Displays nominal output value on the 5-digit LED display Unit display: mV, V, mA, A, Hz, ° Deviation value display: 4-digit LED display Deviation preset values: 5%, 2%, 0, OFF
Other features (SETUP)	Communication settings (GP-IB, Ethernet) Beep setting Self-test Error log Product information display Sweep time setting Grounding setting



## 16.4 External Input and Output

### Master/Slave Synchronous Operation Input and Output (Two terminals each; four terminals total)

Item		Specifications		
Input/output voltage		3 ± 0.1 V (rms), sinusoidal		
Frequency range		40 Hz to 1000 Hz		
Input impedance		Approx. 1 MΩ		
Output impedance		Approx. 50 Ω		
Terminal		Frequency selection		
		Internal oscillators	EXT1	EXT2
Input	cos(I) (EXT1)	Not used	Used	Used
	sin(Q)	Not used	Not used	Used
Output	cos(I)	Internal cos (I) signal	Connect to input terminal cos (I)	Connect to input terminal cos (I)
	sin(Q)	Internal sin (Q) signal	Connect to input terminal sin(Q)	Connect to input terminal sin(Q)

## 16.5 Computer Interface

### USB for PC Connection

Item	Specifications
Number of ports	1
Connector type	Type B connector (receptacle)
Electrical and mechanical	Conforms to USB Revision 2.0
Supported transfer modes	HS (High Speed; 480 Mbps) and FS (Full Speed; 12 Mbps)
Supported protocols	USBTMC-USB488 (USB Test and Measurement Class Ver. 1.0)
PC system requirements	A PC with a USB port, running the English or Japanese version of Windows 7 (32 bit), Windows Vista (32 bit), or Windows XP (32 bit, SP2 or later)

### Ethernet

Item	Specifications
Ports	1
Connector type	RJ-45
Electrical and mechanical	Conforms to IEEE 802.3
Transmission system	100BASE-TX/10BASE-T
Transfer rate	100 Mbps max.
Protocol	TCP-IP
Supported services	VXI-11, DHCP

### GP-IB (/C1 Option)

Item	Specifications
Electrical and mechanical	Conforms to IEEE St'd 488-1978
Functional specifications	SH1, AH1, T6, L4, SR1, RL1, PP0, DC1, DT1, and C0
Protocol	Conforms to IEEE St'd 488.2-1992
Address	0 to 30

## 16.6 General Specifications

Item	Specifications
Warm-up time	Approx. 30 minutes (after acclimatizing the 2558A to the operating environment for at least an hour)
Operating environment	Temperature: 5°C to 40°C Humidity: 20% RH to 80% RH (no condensation)
Storage environment	Temperature: -15°C to 60°C Humidity: 20% RH to 80% RH (no condensation)
Operating altitude	2000 m or less
Installation location	Indoors
Orientation	Horizontal
Rated power supply voltage	100 VAC to 120 VAC, 200 VAC to 240 VAC
Permitted supply voltage range	90 VAC to 132 VAC, 180 VAC to 264 VAC
Rated power supply frequency	50 Hz/60 Hz
Permitted power supply frequency range	48 Hz to 63 Hz
Maximum power consumption	Approx. 200 VA
Withstand voltage	1500 VAC for 1 minute between the power supply and case
External dimensions	132 H × 426 W × 400 D mm
Weight	Approx. 20 kg
Safety standards	Compliant standards EN 61010-1, EN 61010-2-030 Indoor use Overvoltage Category II <sup>1</sup> Pollution degree 2 <sup>2</sup> Measurement category; Other (O) <sup>3</sup>
Emissions	Compliant standards EN 61326-1 Class A EN 55011 Class A, Group 1 EN 61000-3-2 EN 61000-3-3 EMC standards of Australia and New Zealand EN 55011 Class A, Group 1 Korea Electromagnetic Conformity Standard ( 한국 전자파적합성기준 ) This product is a Class A (for industrial environment) product. Operation of this product in a residential area may cause radio interference in which case the user will be required to correct the interference. Cable conditions Signal output terminals (OSC OUTPUT) Use a BNC cable that is 3 m or less in length. External signal input terminal (EXT OSC INPUT) Use a BNC cable that is 3 m or less in length. Voltage terminals (VOLTAGE) Use the included measurement leads (B8506ZK; red and black, one pc. each; length: 1 m). Current terminal (CURRENT) Use the included measurement leads (B8506WA; red and black, one pc. each; length: 1.5 m). GP-IB connector (GP-IB) Use a shielded cable that is 3 m in length or less. Ethernet port (ETHERNET) Use a category 5 or better Ethernet cable (STP) that is 30 m in length or less. USB port for PCs (USB) Use a shielded USB cable that is 3 m in length or less.
Immunity	Compliant standards EN 61326-1 Table 2 (for use in industrial locations) Influence in the immunity test environment : Within ±15% of the range setting Cable conditions Same as the cable conditions for emission above.
Environmental standards <sup>4</sup>	EU RoHS Directive compliant.

1 The overvoltage category is a value used to define the transient overvoltage condition and includes the rated impulse withstand voltage. Overvoltage category II applies to electrical equipment that is powered through a fixed installation, such as a switchboard.

- 2 Pollution Degree applies to the degree of adhesion of a solid, liquid, or gas that deteriorates withstand voltage or surface resistivity. Pollution degree 2 applies to normal indoor atmospheres (with only non-conductive pollution).
- 3 The measurement category of the 2558A terminals is Other (O). Do not use it to measure the main power supply or for Measurement Categories II, III, and IV.  
Measurement category O applies to measurement of circuits that are not directly connected to a main power source. This category applies to measurement of secondary electric circuits in equipment across a transformer. The estimated transient overvoltage that may appear at the 2558A signal input terminals is 1500 V.  
Measurement category II applies to measurement of circuits, such as household electric appliances and portable electric tools, that are connected to low-voltage installations.  
Measurement category III applies to measurement of facility circuits, such as distribution boards and circuit breakers.  
Measurement category IV applies to measurement of power source circuits, such as entrance cables to buildings and cable systems, for low-voltage installations.
- 4 For conformity to environmental regulations and/or standards other than EU, contact your nearest YOKOGAWA office (PIM113-01Z2).

## 16.7 External Dimensions

Unit: mm

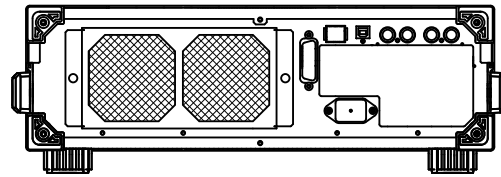
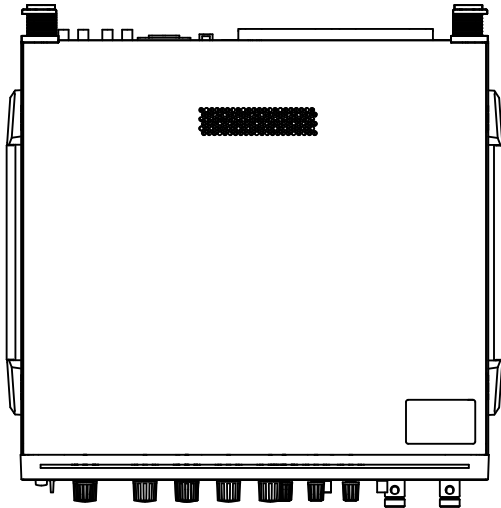

Rear view

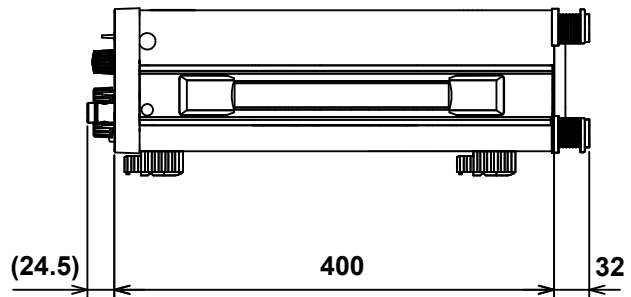
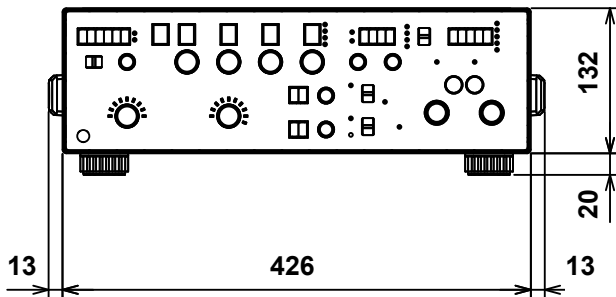

Unless otherwise specified, tolerances are  $\pm 3\%$   
(however, tolerances are  $\pm 0.3$  mm when below 10 mm).

# Appendix 1 Block Diagram

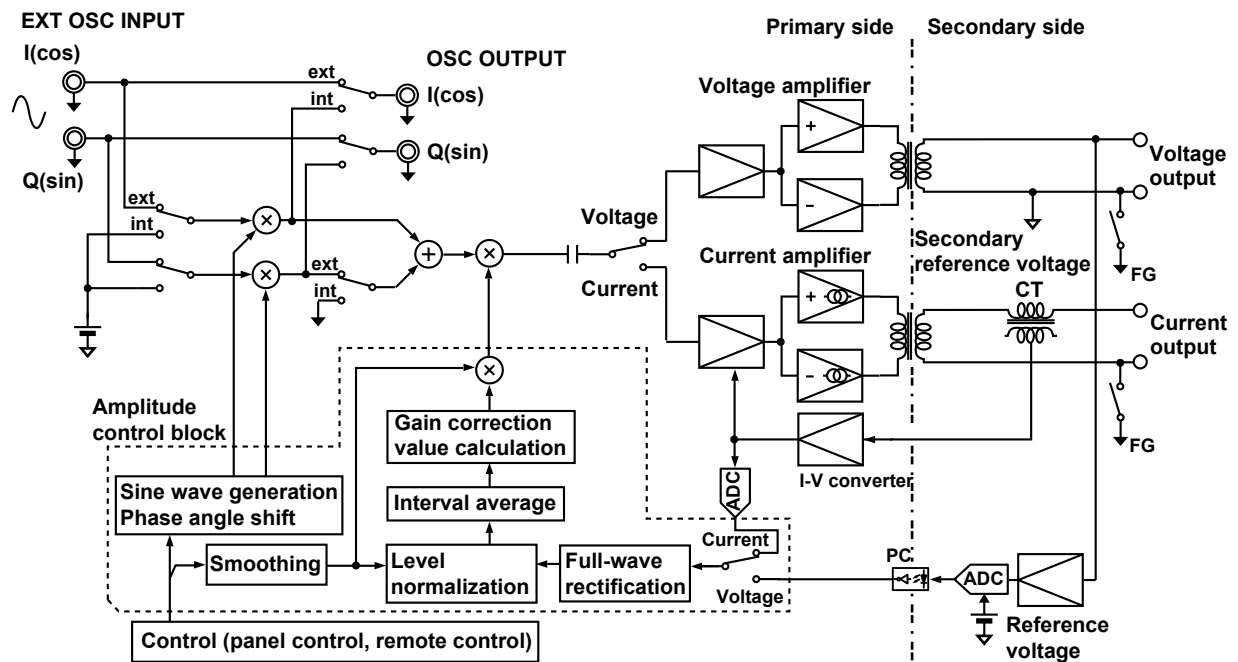

The 2558A consists of a primary side that controls the oscillator output and a secondary side that is isolated by a transformer. The oscillator signal (the sine wave from the amplitude control block or from an external signal) is multiplied by the digital signal from the amplitude control block and amplified by the voltage/current amplifier to produce the voltage and current outputs. In the case of voltage output, the electrical potential at the LO terminal of the secondary side is used as a reference to detect the output voltage. Then, the detected value is A-to-D converted, isolated by a photocoupler, and fed back into the amplitude control block. In the case of current output, a current transformer is used to detect and isolate the output current. Then, I-V conversion and A-to-D conversion is performed at the primary electric potential, and the digital signal is fed back into the amplitude control block.

In the amplitude control block, the target output level is set through the panel or remote control. Smoothing is used to prevent output overshoot and transformer biasing that could occur due to drastic changes in the output when the setting is changed by a great amount.

The amplifier control block immediately after the output is turned on assumes temporarily that there are no errors in the amplification factor or input amplitude and provides a coefficient that corresponds to the setting (after it has been smoothed) to the multiplying DAC. After the operation starts, the amplitude is adjusted every 0.4 seconds on the basis of the feedback voltage or current signal. The signal that is fed back to the amplifier control block is fully rectified. Then, level normalization is used to determine the ratio of the setting to the output amplitude. Next, this ratio is averaged and weighted over a given interval. The average reflects the amplifier gain and other factors, and is not directly affected by the setting. This value is then used to calculate the gain correction value to control the amplitude of the voltage or current output.

As described above, because the 2558A output amplitude is controlled on the basis of waveform average values, if the output waveform distortion increases due to overloading, the use of a nonlinear load, or the use of an external signal with large distortion, an error results in the rms output level that is measured.

On the other hand, if the 2558A is used in a test that checks the excitation current of a transformer or other device or in a similar application, high reproducibility is achieved because the value depends on the voltage waveform average.

Though omitted in the block diagram, the value indicated on the OUTPUT display is a weighted average of the signal fed back to the amplifier control block without any level normalization. To make it easy to check the output setting, the average duration and display update interval are set to 0.2 s, which is half the processing time of the amplifier control block. The OUTPUT display and amplifier control block use the output from the same A-to-D converter. Therefore, if the amplitude is being controlled stably, the difference between the target value that is calculated digitally and the value on the OUTPUT display will be about as large as the rounding error (lowest digit  $\pm 1$ ).

## Appendix 2 Example of Using the 2558A to Calibrate an Analog Meter

### Output Divider

When an analog meter is calibrated, the 2558A is used to output different voltages or currents so that the meter needle can be adjusted to match the minimum and maximum scale marks and the scale marks in between. The 2558A enables you to set the voltage or current output for the maximum scale mark with the main setting and calibrate the different points of the meter by dividing the output, rather than changing the main setting. See sections 2.3 and 5.5.

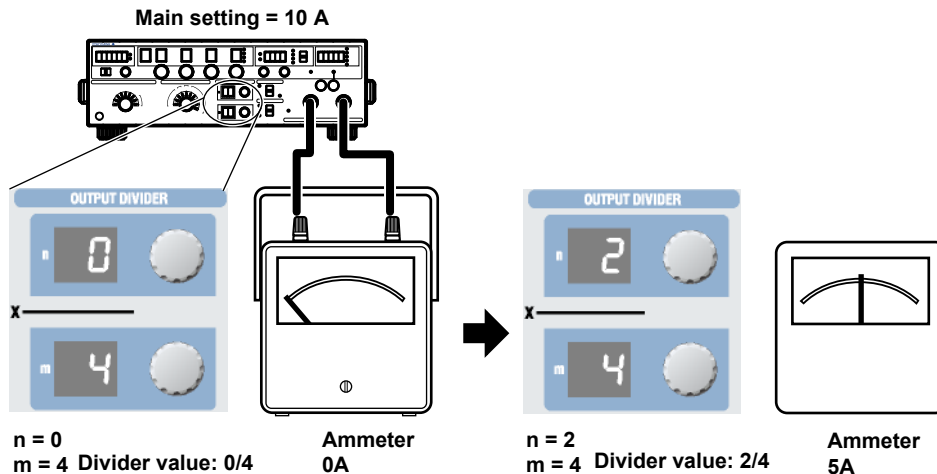

### Presets

There are two ways to calibrate an analog meter. One is to calibrate from the minimum value up, and the other is to calibrate from the maximum value down. In either case, it is necessary to keep the needle from exceeding the next calibration position when the meter needle is moved to the next calibration point. The 2558A enables you to set a preset to make the meter needle point to a position short of the accurate scale position of the next calibration point when the voltage or current is output. See sections 2.4 and 5.7.

#### Example when calibrating in increasing order

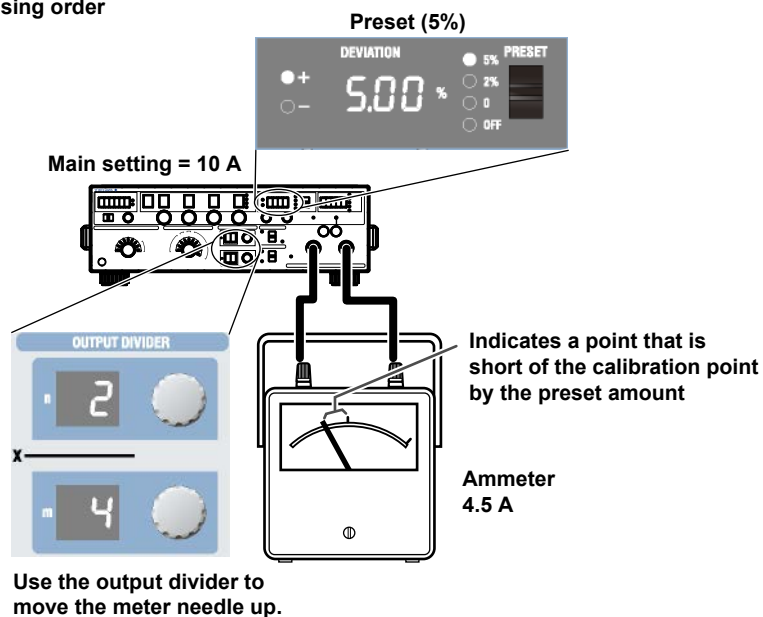

## Deviation

The deviation dials are used to move the meter needle that has been forced to point to a position short of the accurate position with the preset feature (see the previous page) to the accurate scale position. The value shown on the deviation display when the needle is pointing to the accurate position is the calibration deviation. See sections 2.4 and 5.7.

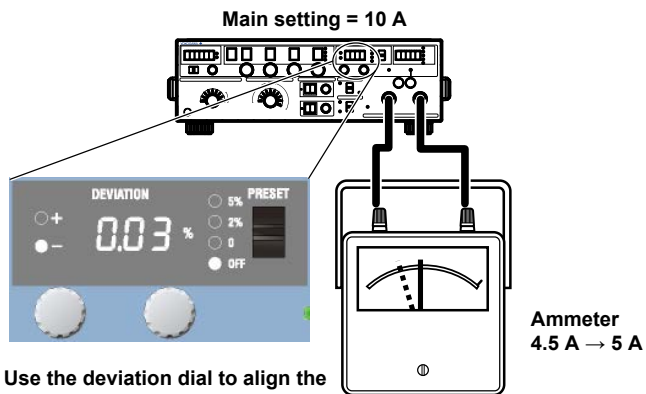

Use the deviation dial to align the meter needle to the accurate scale position.

Example: 4.5 A → 5 A

The deviation is -0.03%.

# Appendix 3 Example of Using the 2558A to Calibrate a Power Meter

To calibrate a power meter, two 2558As are used: one for voltage output and another for current output.

In addition, a Precision Power Analyzer of WT3000E series is used as a reference power meter.

## Synchronous Operation

To synchronize the voltage and current outputs, one 2558A is used as a master device to transmit a synchronization signal to the other 2558A (slave). See sections 2.6 and 5.2.

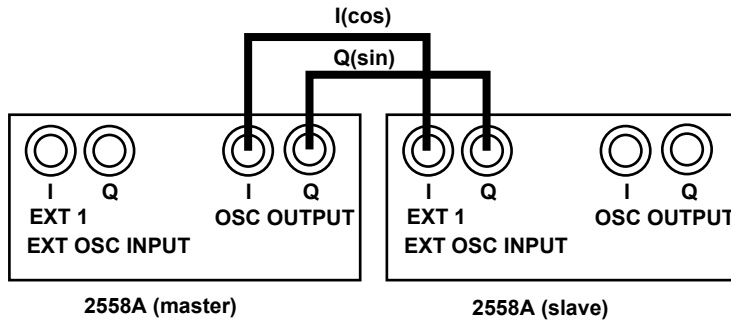

Setup example: Frequency set to 60 Hz

Setup example: Frequency set to EXT2

## Adjusting the Phase Angle

Connect the reference power meter and the power meter under calibration as shown below. Set appropriate ranges and values on the master and slave devices. Turn the output on, and adjust the phase difference between the voltage and current outputs. Adjust the phase angle on the slave 2558A. Turn the VARIABLE dial on the slave 2558A so that the power factor of the reference power meter is at the calibration point. See sections 2.2 and 5.2.

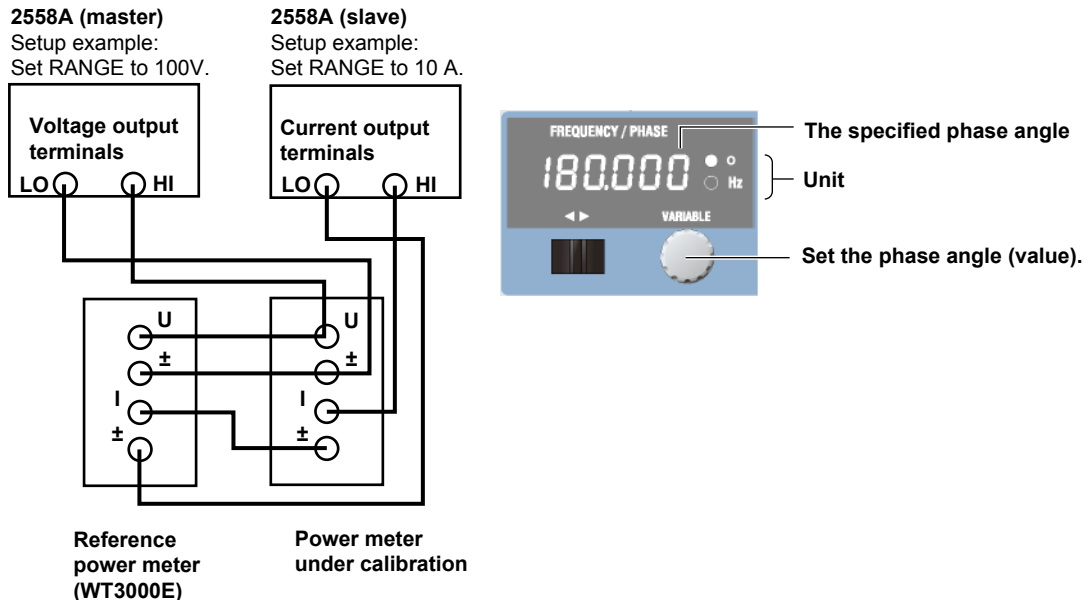

## Calibration

Apply the same voltage and current to the reference power meter and the power meter under calibration.

Use the voltage, current, and phase values on the reference power meter, not the 2558A.



---

## Appendix 4 Phase Shift Feature

### Phase Shift Feature When the Frequency Is Set to EXT2

When EXT2 is selected, the 2558A generates voltage or current by adjusting the amplitude on the basis of a signal computed by  $I \times \cos(\varphi) - Q \times \sin(\varphi)$ , where  $\varphi$  is the phase setting. Here, when  $\varphi$  is  $0^\circ$  or  $180^\circ$ ,  $\sin(\varphi)$  becomes 0, so the Q signal is not used. When  $\varphi$  is  $\pm 90^\circ$ ,  $\cos(\varphi)$  becomes 0, so the I signal is not used.

### Phase When the Frequency Is Set to EXT1

To produce a behavior that is close to the predecessor model, 2558, the phase when EXT1 is selected will correspond to a phase setting of  $180^\circ$  for when EXT2 is selected. In this case, because the Q signal is not used, operation at the same frequency is possible simply through the connection of the I signal.

If an external oscillator is not used, two 2558As are synchronized according to section 7.2, and EXT1 is selected on the slave device, the output phase of the slave device will be approximately the opposite to the output phase of the master device.

## Appendix 5 Factory Default Settings

Item		Factory Default Value	Initialized by Setup Initialization or *RST?	Value Saved When Powered Off?
Output		OFF	Yes	No
Voltage and current ranges		1 V	Yes	Yes
Main setting		0.0000	Yes	No (the decimal place depends on the range setting)
Frequency	Mode	50 Hz	Yes	Yes
	VAR	50.000 Hz	Yes	Yes
	MIN	45.000 Hz	Yes	Yes
	MAX	65.000 Hz	Yes	Yes
Divider output	n	10	Yes	No
	m	10	Yes	Yes
Presets		0%	Yes	No
Deviation		0.00%	Yes	No
Phase angle		0.000	Yes	Yes
Sweeping		HOLD	Yes	No
BEEP		ON	Yes	Yes
SWEEP TIME		16 s	Yes	No
GP-IB	Address	1	No	Yes
	Type	NORMAL	No	Yes
LAN	DHCP	ON	No	Yes
	IP address	192.168.0.1	No	Yes
	Subnet mask	255.255.255.0	No	Yes
	Gateway address	0.0.0.0	No	Yes

## Appendix 6 About the IEEE 488.2-1992 Standard

The 2558A's GP-IB interface conforms to the IEEE 488.2-1992 standard. This standard specifies that the following 23 items be stated in the document. This section describes these items.

**(1) Of the IEEE 488.1 interface functions, the subsets that are supported**

See section 11.1, "GP-IB Interface Features and Specifications."

**(2) The operation of the device when it is assigned an address outside the 0 to 30 range.**

The address of this instrument cannot be set to an address outside the 0 to 30 range.

**(3) Reaction of the device when the user changes the address**

The address change is detected when the user uses the FREQUENCY dial and changes the address on the GPib menu. The new address is valid until the next time it is changed.

**(4) Device settings at power-up. The commands that can be used at power-up.**

As a basic rule, the previous settings (the settings that were in use when the 2558A was turned off) are used.

There are no limitations on the commands that can be used at power-up.

**(5) Message exchange options**

**(a) Input buffer size**

1024 bytes.

**(b) Queries that return multiple response messages**

See the example of the commands given in chapter 13.

**(c) Queries that create response data when the command syntax is being analyzed**

All queries create response data when the command syntax is analyzed.

**(d) Queries that create response data during reception**

There are no queries of which the response data are created upon receiving a send request from the controller.

**(e) Commands that have parameters that restrict one another**

See the example of the commands given in chapter 13.

**(6) Items that are included in the functional or composite header elements constituting a command**

See chapters 12 and 13.

**(7) Buffer sizes that affect block data transmission**

When block data is being transmitted, the output queue is expanded to match the size of the data that is being transmitted.

**(8) A list of program data elements that can be used in equations and their nesting limitations**  
Equations cannot be used.

**(9) Syntax of the responses to queries**

See the example of the commands given in chapter 13.

**(10) Communication between devices that do not follow the response syntax**

Not supported.

**(11) Size of the response data block**

0

**(12) A list of supported common commands**

See section 13.11, "Common Command Group."

**(13) Device condition after a successful calibration**

\*CAL? is not supported.

**(14) The maximum length of block data that can be used for the \*DDT trigger macro definition**

Not supported.

**(15) The maximum length of the macro label for defining macros, the maximum length of block data that can be used for the macro definition, and the process when recursion is used in macro definitions**

Macro functions are not supported.

**(16) Reply to the \*IDN? query**

See section 13.11, "Common Command Group."

**(17) Size of storage area for protected user data for PUD and \*PUD?**

\*PUD and \*PUD? are not supported.

**(18) The length of the \*RDT and \*RDT? resource names**

\*RDT and \*RDT? are not supported.

**(19) The change in the status due to \*RST, \*LRN?, \*RCL, and \*SAV**

\*RST

See section 13.11, "Common Command Group."

\*LRN?, \*RCL, and \*SAV

These common commands are not supported.

**(20) The extent of the self-test using the \*TST? command**

See section 13.11, "Common Command Group."

**(21) The structure of the extended return status**

See chapter 14.

**(22) Whether each command is processed in an overlapped manner or sequentially**

See section 12.5, "Synchronization with the Controller" and chapter 13.

**(23) The description of the execution of each command**

See the functions of the commands in chapter 13.

# Index

## Symbols

	Page
50Hz .....	13-5
50 Hz, 60 Hz, or 400 Hz .....	2-3, 5-3
60Hz .....	13-5
400Hz .....	13-5

## A

abbreviated form.....	12-5
-----------------------	------

## B

beep.....	2-2, 2-9, 5-7, 6-5, 8-1, 13-11, 15-2, 15-7
block data .....	12-7
Boolean .....	12-7
bottom panel.....	1-2

## C

calibrate from the maximum value down.....	App-2
calibrate from the minimum value up.....	App-2
character data.....	12-7
compatible commands.....	11-6, 13-11
crimped terminal.....	3-15
current .....	12-6
current range .....	5-6, 6-4
current range and range generated.....	2-2
current terminals.....	3-14
cursor switch.....	1-3

## D

DCL (Device Clear) .....	11-7
deadlock .....	12-2
decimal .....	12-6
default gateway .....	10-3, 13-12
deviation .....	2-5, 5-11, 6-9, App-3
deviation dial.....	5-11, 13-7
deviation dials.....	1-4, 6-9
DEVIATION display .....	1-4
DEVIATION/PRESET .....	1-4
DHCP .....	10-3, 13-11
divider value .....	2-4, 5-8
DOWN .....	5-14, 6-12, 13-10
DOWN indicator.....	1-4

## E

E.901 .....	15-2
E.902 .....	15-2
E.903 .....	15-2
E.904 .....	15-2
error log .....	2-9, 8-2
EXT1.....	2-3, 5-4, 13-5
EXT2.....	13-5
EXT2 (PHASE).....	2-3, 5-4
EXT OSC INPUT .....	7-1

## F

firmware version .....	13-13
FMAX.....	13-5
FMIN.....	13-5
frequency.....	2-3, 12-6, 13-5
FREQUENCY dial .....	5-3, 6-3, 13-5
FREQUENCY METER MIN/MAX.....	6-3

FREQUENCY/PHASE.....	1-3
FREQUENCY/PHASE display.....	1-3
front panel.....	1-1

## G

GET (Group Execute Trigger).....	11-7
GP-IB address .....	11-5, 13-11
ground loop.....	5-2, 6-2
GTL (Go To Local).....	11-7

## H

HIGH VOLTAGE indicator .....	2-2, 5-6, 6-4, 15-7
HOLD.....	5-14, 6-12, 13-10

## I

I connector.....	7-3
IFC (Interface Clear).....	11-7
initialization .....	2-9, 13-14
installation conditions .....	3-3
I/O circuit .....	7-1
IP address .....	10-3, 13-12

## L

LLO (Local Lockout).....	11-7
LOCAL.....	9-1, 10-1, 11-2

## M

MAC address.....	10-4, 13-12
main setting .....	1-3, 13-8
main setting dials.....	1-3, 5-7, 6-5
main setting display .....	1-3
master.....	2-8, 7-3
m dial.....	1-5, 5-8, 6-6, 13-4
m display .....	1-5
messages.....	12-1
movable legs .....	3-4
multiplier .....	12-6

## N

n dial.....	1-5, 5-8, 6-6, 13-4
n display .....	1-5

## O

OFF indicator.....	1-4, 5-9, 6-7
ON indicator.....	1-4, 5-9, 6-7
optional accessories.....	v
options .....	13-13
OSC OUTPUT .....	7-2
OUTPUT .....	1-4, 6-8
OUTPUT display.....	13-8
output divider.....	13-4, App-2
OUTPUT DIVIDER .....	1-5
OUTPUT switch.....	1-4, 5-9, 6-7, 13-6
output, turing on and off.....	2-3
output value .....	5-10
overlap commands .....	12-8

## Index

<b>P</b>	<b>Page</b>
parameters, selecting .....	4-4
phase .....	12-6
phase angle .....	2-3, 13-5
PMT .....	12-1
preset .....	5-12
preset indicator .....	1-4
presets .....	2-6, 6-10, App-2
PRESET switch .....	1-4, 5-11, 6-9, 13-7
program data .....	12-1
program header .....	12-1
program messages .....	12-1

<b>Q</b>	<b>Page</b>
Q connector .....	7-3

<b>R</b>	<b>Page</b>
rack mounting .....	3-5
RANGE dial .....	5-6, 6-4, 13-8
rear panel .....	1-2
register .....	12-7
REMOTE indicator .....	9-1, 10-1, 11-2
REN (Remote Enable) .....	11-7
response data .....	12-2
response header .....	12-2
response messages .....	12-1
RMT .....	12-1
rubber leg cap .....	3-4

<b>S</b>	<b>Page</b>
SDC (Selected Device Clear) .....	11-7
self-test .....	13-14, 15-8
sequential commands .....	12-8
serial number .....	2-9, 8-5, 13-13
SETUP menu .....	13-11
slave .....	2-8, 7-3
source function .....	13-8
SPD (Serial Poll Disable) .....	11-7
special characters .....	1-6
SPE (Serial Poll Enable) .....	11-7
standard accessories .....	iv
standard commands .....	11-6, 13-11
string data .....	12-7
subnet mask .....	10-3, 13-12
SWEEP .....	1-4
SWEEP switch .....	1-4, 13-10
sweep time .....	5-13, 6-12, 13-10

<b>T</b>	<b>Page</b>
terminal's ground .....	13-11
time .....	12-6
top panel .....	1-2

<b>U</b>	<b>Page</b>
unit .....	12-6
unit indicator .....	1-3
UP .....	5-14, 6-12, 13-10
UP indicator .....	1-4
USB driver .....	9-2

<b>V</b>	<b>Page</b>
values, entering .....	4-4
VAR .....	2-3, 5-3, 13-5
VARIABLE dial .....	1-3
version .....	2-9, 8-5
voltage .....	12-6
voltage range .....	5-6, 6-4
voltage range and range generated .....	2-2
voltage terminals .....	3-14

<b>W</b>	<b>Page</b>
warm-up .....	3-8