



# NSG 4070C TEST SYSTEM FOR CONDUCTED AND RADIATED IMMUNITY



The NSG 4070 is a multi-functional device for carrying out EMC immunity tests to accompany development and conformity testing in accordance to IEC/EN 61000-4-6, Namur and several automotive BCI standards. Anyone who spends a considerable amount of time on test level setting, connecting EUT monitoring or writing test reports can now carry out immunity testing in a much more efficient manner with the 4th generation of NSG 4070.

Its modular set-up using internal or external amplifiers enables a large variety of applications. The powerful and easy to use firmware makes the NSG 4070 independent from an external PC and control software, however it can also be remote controlled for system operation. A state-of-the-art data transfer of test and measurement data for documentation is provided by USB stick to be plugged into the front panel.

- **Integrated signal generator**  
4 kHz to 1 GHz
- **3 power meter inputs**  
4 kHz to 1 GHz
- **Integrated class A power amplifier module for different applications:**  
35 W, 150 kHz to 230 MHz;  
40 W, 10 kHz to 400 MHz;  
45 W, 9 kHz to 1 GHz;  
60 W, 10 kHz to 400 MHz (>10 W, 4 kHz to 10 kHz);  
80 W, 150 kHz to 230 MHz
- **Multiple EUT monitoring options**
- **5,7" TFT color display**
- **Internal, menu-based control software**
- **Basic remote control software and report generator included**
- **Optically decoupled remote control**
- **Whisper mode**

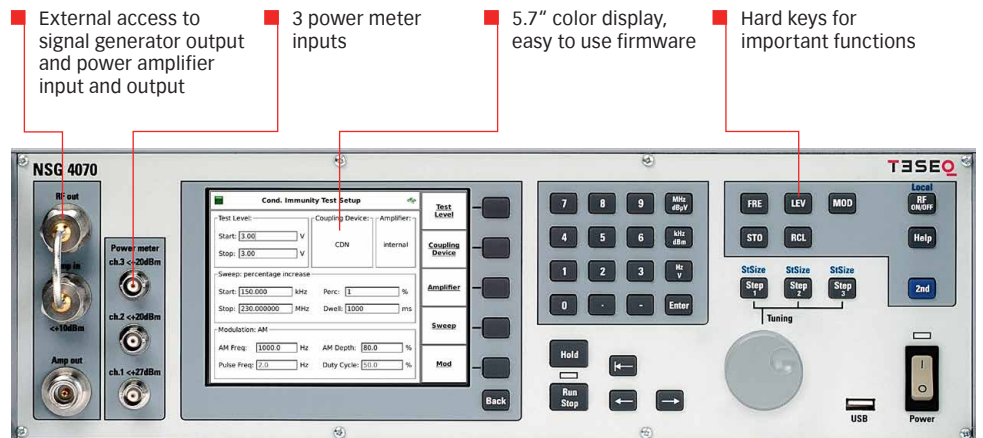

- Standards:**
- IEC/EN 61000-4-3
  - IEC/EN 61000-4-6
  - IEC/EN 61000-4-20
  - IEC/EN 61000-4-21
  - IEC 62132
  - ISO 11452-4
  - MIL-STD-461 CS114
  - Ford FMC1278
  - GM GMW3097
  - Nissan 28400NDS
  - Peugeot PSA B21 7110
  - Renault 36-00-808
  - And others

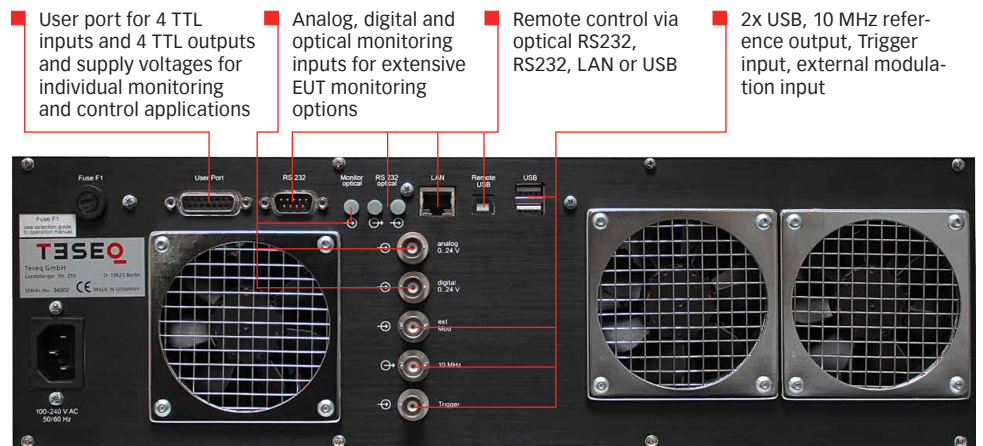

# NSG 4070C TEST SYSTEM FOR CONDUCTED AND RADIATED IMMUNITY

## Selection guide for the power amplifier

Product	Power amplifier nominal power	Power amplifier frequency range	Immunity testing IEC/EN 61000-4-6 ) <sup>1</sup> 150 kHz to 230 MHz			Immunity testing Namur ) <sup>1</sup> 10 kHz to 80 MHz			Automotive BCI testing ) <sup>2</sup> ISO 11452-4: 2011		Automotive BCI testing Ford FMC1278 ) <sup>2</sup>		MIL-STD-461G CS114 ) <sup>2</sup>	RTCA DO-160G CS Test ) <sup>2</sup>
			CDN	EM clamp	Current injection probe	CDN	EM clamp	Current injection probe	Substitution	Closed loop with k = 4	Substitution	Closed loop with k = 4	Substitution	Closed loop with k = 4
<b>NSG 4070C-0</b>	-	-	*	*	*	*	*	*	*	*	*	*	*	*
<b>NSG 4070C-0 + external amp</b>	110 W (>10W at 4 kHz)	10 kHz (4 kHz) to 400 MHz	30 V	24 V	10 V	30 V	5.5 V	2 V	400 mA > Level IV	200 mA > Level IV	112 dBµA Level 2	106 dBµA Level 2	114 dBµA Level 5	200 mA Level: M, R, S, T, W
<b>NSG 4070C-0 + external amp</b>	260 W (>10W at 4 kHz)	10 kHz (4 kHz) to 400 MHz	30 V	30 V	16 V	30 V	8 V	3 V	600 mA > Level IV	300 mA > Level IV	115 dBµA Level 2	109 dBµA Level 2	114 dBµA Level 5	300 mA Level: M, O, R, S, T, W, Y
<b>NSG 4070C-35</b>	35 W	150 kHz to 230 MHz	19 V	14 V	6 V	*	*	*	*	*	*	*	*	*
<b>NSG 4070C-40</b>	40 W	10 kHz to 400 MHz	21 V	15 V	6 V	21 V	3 V	1 V	240 mA > Level IV	120 mA Level III	108 dBµA Level 2	102 dBµA Level 1	108 dBµA Level 5	120 mA Level: M, R, S, T
<b>NSG 4070C-45</b>	45 W	9 kHz to 1 GHz	22 V	16 V	7 V	22 V	3 V	1 V	260 mA > Level IV	130 mA Level III	108 dBµA Level 2	102 dBµA Level 1	108 dBµA Level 5	130 mA Level: M, R, S, T
<b>NSG 4070C-60 )<sup>3</sup></b>	60 W (>10W at 4 kHz)	10 kHz (4 kHz) to 400 MHz	26 V	19 V	8 V	26 V	4 V	1 V	300 mA > Level IV	150 mA Level III	109 dBµA Level 2	103 dBµA Level 1	109 dBµA Level 5	150 mA Level: M, R, S, T, W
<b>NSG 4070C-80</b>	80 W	150 kHz to 230 MHz	30 V	22 V	10 V	*	*	*	*	*	*	*	*	*

All level calculated in relation to the standard requirements with typical values of the coupling device.

<sup>1)</sup> Calculated with 6 dB attenuator, 0.5 dB cable loss and AM with 80% modulation depth. Calculated with typical insertion loss of Teseq CDN with 10.5 dB, Teseq EM clamp KEMZ 801A with 13.5 dB (range 150 kHz to 230 MHz) or 27.5 dB (range 10 kHz to 80 MHz) and Teseq CIP 9136A with 21 dB (range 150 kHz to 230 MHz) or 35.5 dB (range 10 kHz to 80 MHz).

<sup>2)</sup> Calculated with highest test level in the frequency range and related typical insertion loss of the BCI probe Teseq CIP 9136A.

<sup>3)</sup> The NSG 4070C-60 measures the reverse power also with selected internal power amplifier (5 channel power meter and bidirectional coupler) as may required by the BCI standard.

\*) Requires external directional coupler and external power amplifier for the frequency range and test level.



Advanced Test Solutions for EMC

# NSG 4070C TEST SYSTEM FOR CONDUCTED AND RADIATED IMMUNITY

## Technical specifications

### Generator

RF	
Frequency range:	4 kHz to 1 GHz
Resolution:	1 Hz
Reference frequency:	10 MHz
Aging:	25 ppm
RF Level	
Level range:	-60 dBm to +10 dBm
Resolution:	0.1 dB
Settling time:	10 ms
Amplitude modulation	
Modulation depth:	0 to 100%
Modulation frequency range:	1 Hz to 50 kHz
Frequency resolution:	1 Hz
Pulse modulation (possible to interlace up to three pulse modulations)	
Rise/fall time (10% / 90%):	< 1 $\mu$ s
Modulation frequency range:	0.01 Hz to 1 MHz
Frequency resolution:	0.01 Hz
Duty cycle:	0.1% to 100%
External modulation	
Delay time:	< 1 $\mu$ s / 180°
Period:	min. 20 $\mu$ s
Pulse width:	min. 10 $\mu$ s

### Power meter

Frequency range:	4 kHz to 1 GHz
Linear measurement range	
channel 1:	-35 dBm to +27 dBm (NSG 4070C-60: -40 dBm to +27 dBm)
channel 2,3:	-45 dBm to +20 dBm
Max. input / no damage	
channel 1-3:	+28 dBm
Noise level:	>5 dB below the measurement range
Input return loss:	>20 dB (below 500 MHz), >17 dB (500 MHz to 1 GHz)
Connector:	BNC socket, 50 $\Omega$
Accuracy 10 to 30°C:	<0.5 dB, typ. <0.3 dB

# NSG 4070C TEST SYSTEM FOR CONDUCTED AND RADIATED IMMUNITY

## Power amplifier

Nominal output power:	35 W	40 W (preliminary)		45 W	60 W (preliminary)		80 W	
Frequency range:	150 kHz to 230 MHz	10 kHz to 400 MHz		9 kHz to 1 GHz	10 kHz (4 kHz) to 400 MHz		150 kHz to 230 MHz	
Type:	single band, class A	single band, class A		single band, class A	single band, class A		single band, class A	
Input/output impedance (nominal):	50 Ω	50 Ω		50 Ω	50 Ω		50 Ω	
Input return loss (minimum):	10 dB	10 dB		10 dB	10 dB		10 dB	
Output return loss (nominal):	min. 9.5 dB	min. 9.5 dB		min. 9.5 dB	min. 9.5 dB		min. 9.5 dB	
Output return loss without damage:	0 dB	0 dB		0 dB	0 dB		0 dB	
Gain (minimum):	48 dB	10 kHz to 20 MHz 50 dB	20 MHz to 400 MHz 47 dB	50 dB		4 kHz to 10 kHz 45 dB	10 kHz to 400 MHz 53 dB	50 dB
Gain flatness (maximum):	+/- 3 dB	+/- 3 dB		+/- 3 dB		+/- 3 dB		+/- 3 dB
Saturated output power (minimum):	45.4 dBm	10 kHz to 20 MHz 46 dBm	20 MHz to 400 MHz 44.5 dBm	< 400 MHz 46.5 dBm	> 400 MHz 45.4 dBm	4 kHz to 10 kHz 42 dBm	10 kHz to 400 MHz 49 dBm	49 dBm
Linear output power (minimum):	44 dBm	10 kHz to 20 MHz 45 dBm	20 MHz to 400 MHz 43 dBm	< 400 MHz 45.4 dBm	> 400 MHz 43 dBm	4 kHz to 10 kHz 40 dBm	10 kHz to 400 MHz 48 dBm	48 dBm
Input power without damage (maximum):	+10 dBm	+10 dBm		+10 dBm		+10 dBm		+10 dBm
Harmonic distortion at linear output power (typical):	< -17 dBc	< -20 dBc		< -20 dBc		< -18 dBc		< -20 dBc

# NSG 4070C TEST SYSTEM FOR CONDUCTED AND RADIATED IMMUNITY

Power amplifier of NSG 4070C-35

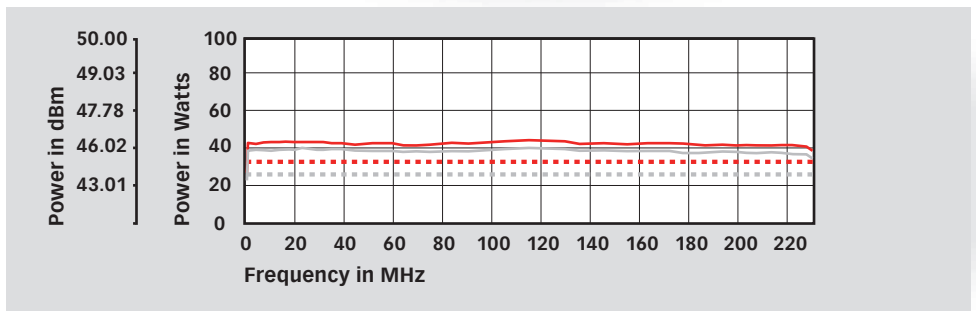

Power amplifier of NSG 4070C-40 (preliminary data)

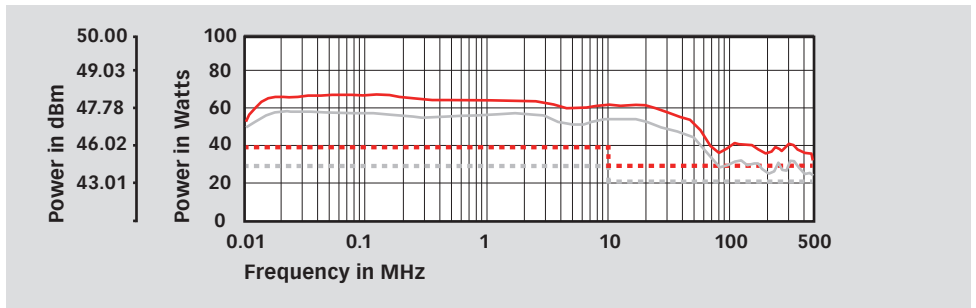

Power amplifier of NSG 4070C-45

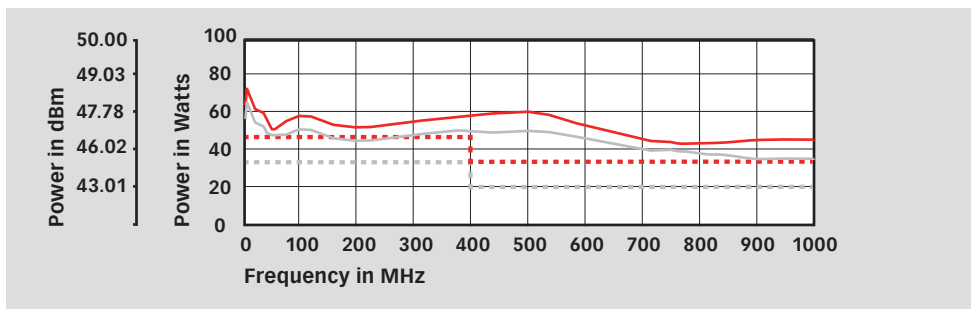

**Legend**

- typical saturated power
- typical linear power
- - - specification saturated power
- - - specification linear power

# NSG 4070C TEST SYSTEM FOR CONDUCTED AND RADIATED IMMUNITY

Power amplifier of NSG 4070C-60 (preliminary data)

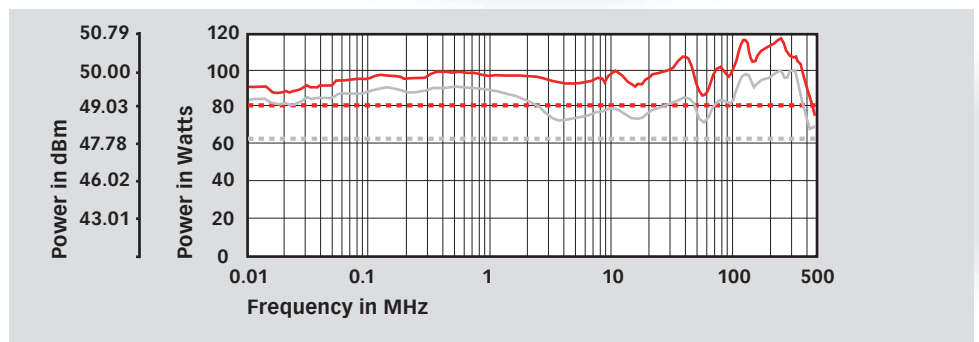

Power amplifier of NSG 4070C-80

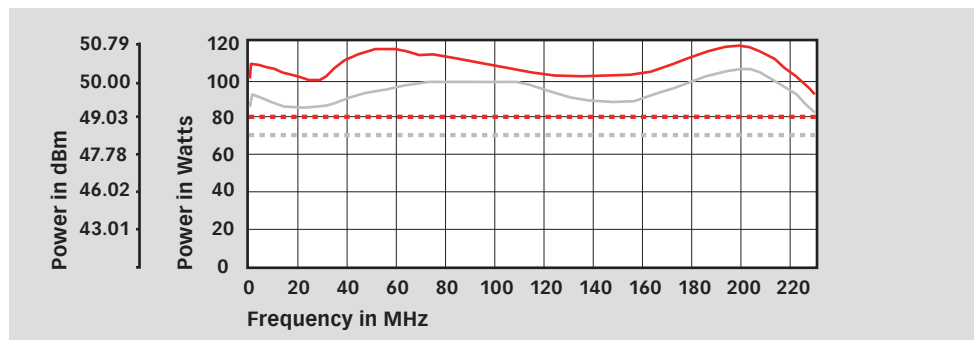

## Legend

- typical saturated power
- typical linear power
- - - specification saturated power
- - - specification linear power

# NSG 4070C TEST SYSTEM FOR CONDUCTED AND RADIATED IMMUNITY

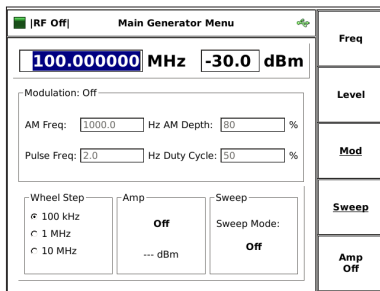

Firmware: Main generator menu

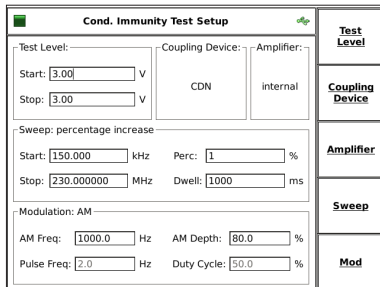

Firmware: Immunity test setup

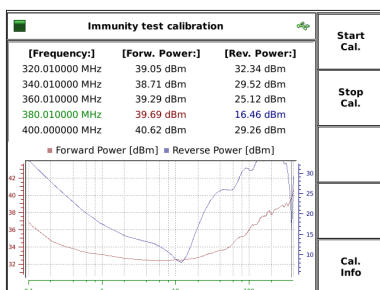

Firmware: Calibration result

## Test and measurement routines

### Firmware: Generator mode

Sweep:	Frequency sweep, level sweep
Modulation:	AM, AM PC (peak conservation), pulse modulation and external
Others:	Free parameter setting from 9 kHz to 1 GHz, high power mode using power amplifier

### Firmware: Immunity mode

Level:	start and stop level or sections can be defined, max test levels depending on power amplifier or for IEC 61000-4-6 limited to 30 V EMF, for BCI tests levels in units mA or dBµA
Test methods IEC 61000-4-6:	CDN, EM clamp, current clamp and direct injection, clamp injection with test level control using monitoring probe
Test methods BCI:	substitution method with optional use of the monitoring probe, closed loop method with power limitation (factor adjustable)
Sweep:	frequency or section sweep with linear, steps per decade or percentage increase
Modulation:	AM, AM PC (peak conservation), pulse modulation, external or mixed (e.g. 1 kHz AM internal modulated with 1 Hz PM external)
EUT monitoring:	Individual configuration of the port's functionality, display of events during the test, in the result file and in the test report
Calibration:	Test set-up and monitoring probe calibration, display, store and recall function of calibration files (limitation of file numbers only by the disk space, typical >340 files)
EUT threshold search:	Manual search by changing frequency or stress level
Store and recall:	Store and recall function of test configurations, calibration results and test results (number of files is only limited by the disk space, typical >340 files), supports USB sticks
Component check:	Quick check of system components, e.g. cable, attenuator max. 52 dB/54 dB/58 dB attenuation for 35 W/45 W/80 W amplifier, max. +16 dB gain at 27 dBm output level
Amplifier saturation check:	Validation that the power amplifier is not in saturation for the selected test level including 80% AM, see IEC 61000-4-6 Ed. 4 for more information (only available for firmware operation)
Additional features:	Free parameter setting from 9 kHz to 1 GHz, supports external power amplifier, RF switch SW 4070, monitoring probe MD 4070, directional coupler and attenuator

# NSG 4070C TEST SYSTEM FOR CONDUCTED AND RADIATED IMMUNITY

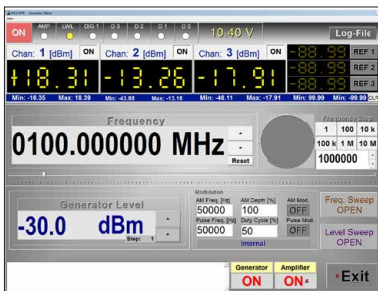

## Windows software

General:	The windows software includes the firmware functionality. The following <b>additional</b> features are available see below. The software allows the use of the report generator and all post processing features without the remote connection to the NSG 4070.
Remote control:	Remote control of NSG 4070 via LAN, USB or RS232
Data transfer:	Transfer between NSG 4070 and PC via remote connection or with USB stick

## Software: Generator menu



## Windows software: Generator mode

Display:	Power meter display (units dBm, V, dBμV) with reference value setting, min./max. display and export to a log file (frequency, time, power), EUT monitoring display
Single step mode:	Synchronized frequency sweep with power measurement, output as graph and ASCII file (application: scalar analysis on quadripole networks)

## Software: Immunity test setup

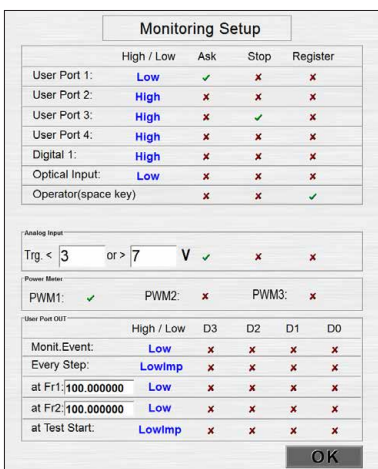

## Windows software: Immunity mode

Sweep:	Level sweep with start and stop value or with free editable table, level profile editor and sweep function for BCI tests
EUT threshold search:	Different opportunities for manual and automatic control
EUT monitoring:	Power meter use as EUT monitoring device, keyboard activity for test interrupt with possibility for writing test report comments (EUT reaction etc.), output control for user port
Additional features:	For each frequency step or each monitoring event output control for user port (to control a RF switch for the use of two amplifier)
One click report generation:	Tool for test report generation in rtf format, works with different user changeable templates, post processing of measurement data (input for test conditions, EUT parameters and comments), free changeable structure and items of the report, user support of repetitive inputs
Export function:	Result and calibration files can be converted to txt files, graphs can be zoomed and converted to jpg files

## Software: EUT monitoring setup



Advanced Test Solutions for EMC



# NSG 4070C TEST SYSTEM FOR CONDUCTED AND RADIATED IMMUNITY



NSG 4070 front panel with RF ports

## Analog ports

Front panel	
Generator output:	N socket 50 $\Omega$ , 4 kHz to 1 GHz
Power amplifier input:	N socket 50 $\Omega$ , max. +10 dBm
Power amplifier output:	N socket 50 $\Omega$
Power meter channel 1 to 3:	as defined in chapter "Power meter"
Back panel	
Monitoring input analog:	BNC socket, 0 to 24 V Ri=15 k $\Omega$ , 6 mV resolution
External modulation input:	BNC socket, impedance >10 k $\Omega$ , level: 1 Vpp to get 100% AM, 1 Hz to 50 kHz
10 MHz reference output:	BNC socket, approx. 1 Vpp/50 $\Omega$

## Digital ports

Front panel	
USB:	USB host connector for USB stick, keyboard, mouse
Back panel	
User port:	D-Sub 15 pole 4 TTL inputs 4 TTL outputs +12 V / 800 mA, -12 V / 200 mA, +5 V / 800 mA power supply
Monitoring digital input:	BNC socket 0 to 24 V via optical coupler Ri=1.5 k $\Omega$ , switching threshold approx. 2 to 3 V
Monitoring optical input:	LWL (Light wave connector), HP versatile link HFBR0501 series 40 kBd, (avoid scattered light on the back panel)
Trigger input:	BNC socket, TTL for external triggering, max. frequency 100 Hz, trigger delay <10 ms
RS232:	D-Sub 9 pole, up to 115200 Bd
RS232 optical:	Connector 2 x HFBRx523 socket for 1 mm fiber optic cable with length between 5 m and 30 m with 115200 Bd, for other distances 38400 Bd, max. 50 m
2x USB:	USB host connector for USB stick, keyboard, mouse
USB device connector:	For remote control
Network:	RJ45, Ethernet 10/100 BASE-T

# NSG 4070C

## TEST SYSTEM FOR CONDUCTED AND RADIATED IMMUNITY

### Power supply

Power consumption	100 to 240 VAC 50/60 Hz autoranging	Recommended fuse F1 for nominal 110 V	Recommended fuse F1 for nominal 230 V
NSG 4070C-0	approx. 80 W	1 A (slow)	0.5 A (slow)
NSG 4070C-35, NSG 4070C-40, NSG 4070C-45, NSG 4070C-60 and NSG 4070C-80	approx. 415 W	6.3 A (slow)	2.5 A (slow)

### General data

Operating temperature range:	0°C to 40°C
Storage temperature range:	-20°C to 60°C
Relative humidity:	95%/30°C (no moisture condensation)
EMC:	DIN/EN 61326-1:2006
Shock:	DIN/EN 60068-2-27
Vibration:	DIN/EN 60068-2-6
Protection class:	DIN/EN 61010-1/IEC 61010-1

### Mechanical specifications

Size (W x H x D) :	45 cm (19") x 15 cm (3HU) x 42.3 cm (with handle bar and foot)
Weight:	approx. 15 kg (with internal power amplifier), approx. 8 kg (without internal power amplifier)
Size of cardboard box:	80 cm x 61 cm x 34 cm (also for options ATN 60xx and/or LE 4070 additional space available)
Weight of cardboard box:	approx. 8 kg (empty)

# NSG 4070C TEST SYSTEM FOR CONDUCTED AND RADIATED IMMUNITY



NSG 4070 with CDNs

## Application for IEC/EN 61000-4-6, calibration set-up with CDN

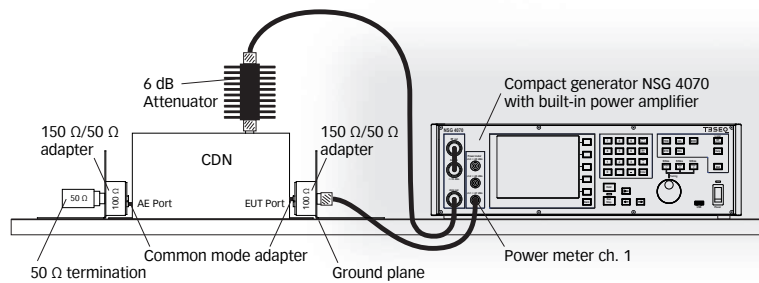

## Application for IEC/EN 61000-4-6, EUT set-up with CDN

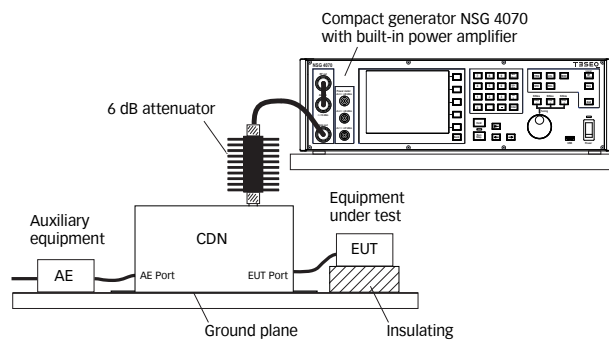

## Application for IEC/EN 61000-4-6, calibration set-up with EM clamp

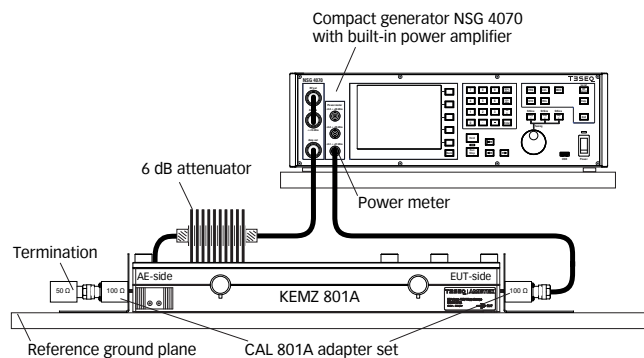

Advanced Test Solutions for EMC

# NSG 4070C TEST SYSTEM FOR CONDUCTED AND RADIATED IMMUNITY



LE 4070, RF cable set for NSG 4070, consist of:

- RF cable, N(m)-N(m), 3 m with one right-angle plug, RG223;
- RF cable, N(m)-BNC(m), 2 m, RG223;
- RF cable, BNC(m)-N(m), 250 mm;
- RF cable, N(m)-N(m), 120 mm;
- Adapter N(m)-N(m);
- Adapter N(f)-BNC(m)

## Application for IEC/EN 61000-4-6, calibration set-up with current injection probe

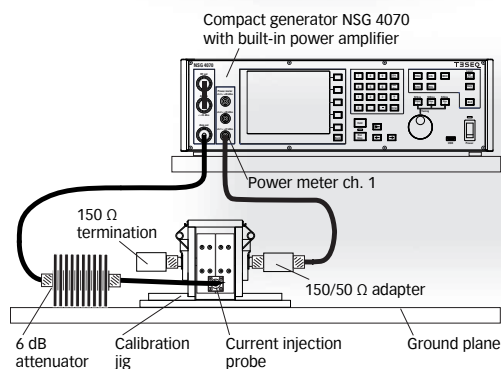

## Application for IEC/EN 61000-4-6, EUT set-up with EM clamp or current injection probe and for example with use of a monitoring probe

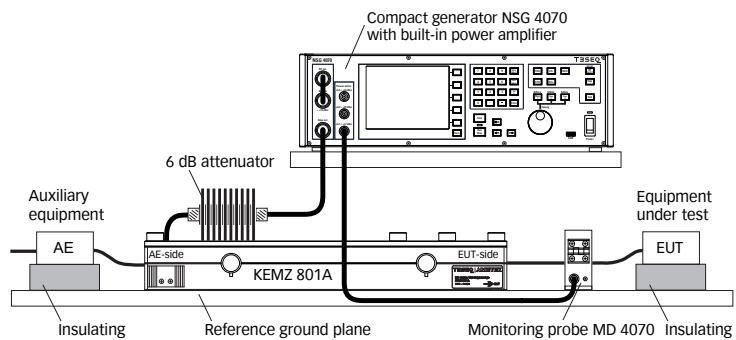

# NSG 4070C TEST SYSTEM FOR CONDUCTED AND RADIATED IMMUNITY



NSG 4070-0 combined with RF switch network and power amplifiers for a complex solution e.g. automotive BCI solution

## Application for automotive BCI, calibration set-up (example with external power amplifier and directional coupler)

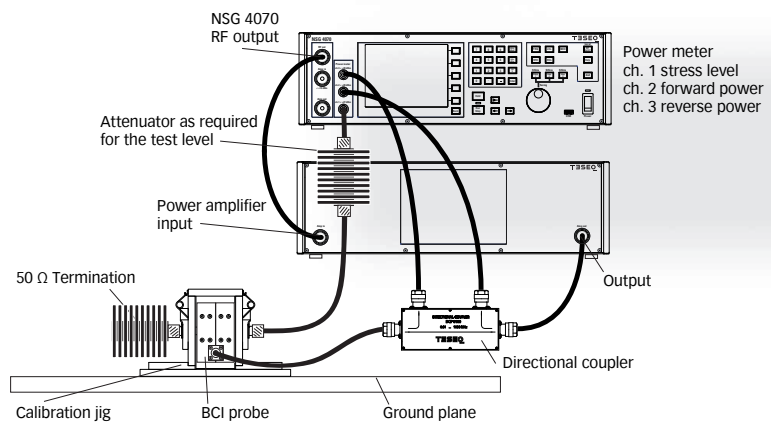

## Application for automotive BCI, EUT set-up with monitoring probe (example with external power amplifier and directional coupler)

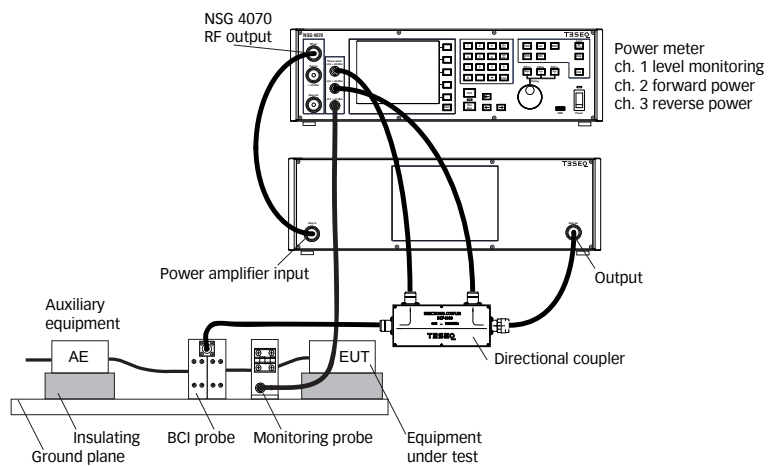

# NSG 4070C TEST SYSTEM FOR CONDUCTED AND RADIATED IMMUNITY

Application for automotive BCI, calibration set-up (example with NSG 4070C-60)

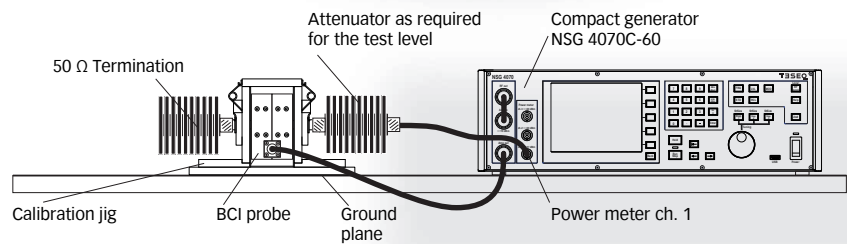

Application for automotive BCI, EUT set-up with monitoring probe and LISN (example with NSG 4070C-60)

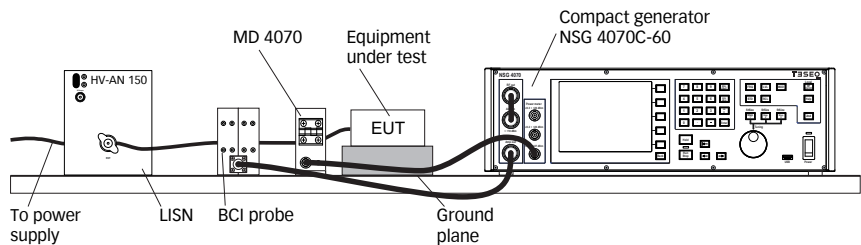

Application for IEC / EN 61000-4-20 up to 1 GHz (example with NSG 4070-45; field probe control requires optional software e.g. WIN 6000)

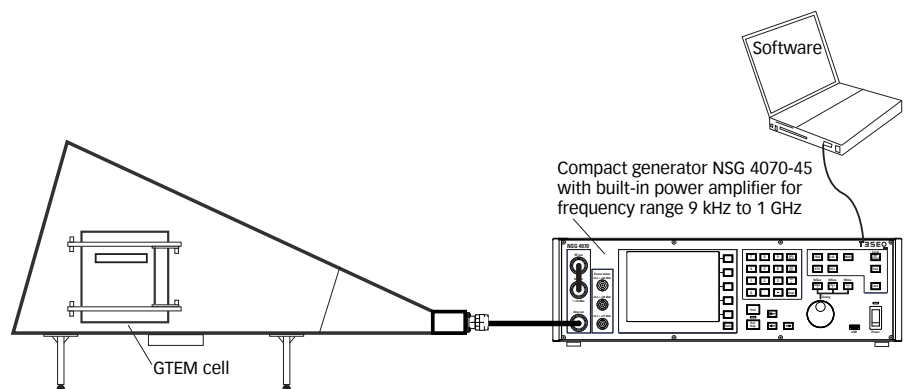

# NSG 4070C TEST SYSTEM FOR CONDUCTED AND RADIATED IMMUNITY



NSG 4070 with rack mounting kit



SW 4070, RF switch network 2xSPDT



ATN 6150, 6 dB attenuator 150 W

**Teseq GmbH**  
Landsberger Str. 255 · 12623 Berlin · Germany  
T +49 30 56 59 88 35 F +49 30 56 59 88 34  
info.rf.cts@ametek.com [www.teseq.com](http://www.teseq.com)

© August 2017 Teseq®  
Specifications subject to change without notice.  
Teseq® is an ISO-registered company. Its products are designed and manufactured under the strict quality and environmental requirements of the ISO 9001. This document has been carefully checked. However, Teseq® does not assume any liability for errors or inaccuracies.

82-257492 E02 August 2017

## Delivery items for the NSG 4070 series

Compact immunity test system NSG 4070, 4 kHz to 1 GHz RF generator and power meter (power amplifier as selected); remote control software on USB stick; spare fuses (2); RS232 cable (Nullmodem); USO 4013 (USB to serial/optical converter with 20 m optical cable); LAN cable, crossover, 3 m; keyboard (English); mains cable GB, CH, USA/JP, EU; operating manual

## Model No. and options

Part number	Description
257495	NSG 4070C-0 Compact immunity test system 4 kHz to 1 GHz RF generator and power meter (without power amplifier)
257491	NSG 4070C-35 Compact immunity test system, 4 kHz to 1 GHz RF generator and power meter (with 35 W module 150 kHz to 230 MHz)
257493	NSG 4070C-40 Compact immunity test system, 4 kHz to 1 GHz RF generator and power meter (with 40 W module 10 kHz to 400 MHz)
257494	NSG 4070C-45 Compact immunity test system, 4 kHz to 1 GHz RF generator and power meter (with 45 W module 9 kHz to 1 GHz)
257408	NSG 4070C-60 Compact immunity test system, 4 kHz to 1 GHz RF generator, 4 kHz to 1 GHz 5-channel power meter (3 inputs, 2 used internal), 60 W power ampl. module 10 kHz to 400 MHz (>10 W 4 to 10 kHz)
257492	NSG 4070C-80 Compact immunity test system NSG 4070, 4 kHz to 1 GHz RF generator and power meter (with 80 W module 150 kHz to 230 MHz)
97-253290	NSG 4070-TC Traceable calibration (ISO17025), order only with the device
98-253290	NSG 4070-DAkKS DAkKS calibration (ISO17025), order only with the device
253840	NSG 4070 Rack Rack mounting kit for NSG 4070 (red handles)
253850	SW 4070 Option for NSG 4070: RF-Switch network 2x SPDT
253104	LE 4070 RF cable set for NSG 4070
235380	ATN 6060 6 dB Attenuator 60 W cw N(f)-N(f)
235376	ATN 6150 6 dB Attenuator 150 W cw N(f)-N(f)
235378	ATN 6200 6 dB Attenuator 200 W cw N(f)-N(f)
257512	icd.control Software License for one generator NSG 4070B-xx, NSG 4070C-xx