



Advanced Test Equipment Corp.

www.atecorp.com 800-404-ATEC (2832)



MODEL 61800 SERIES

KEY FEATURES

- Output power
61830: 30kVA ; 61845: 45kVA
61860: 60kVA ; 61800-100: 105kVA
61800-100 (800VLN): 105kVA
- Output voltage:
0~300V ; 0~400V (option *1) ;
0~500V (option *2) ; 0~800V *3
- Output frequency: DC, 30Hz~100Hz
- User selectable single phase or three phase output
- Accept reverse rated apparent power with regenerative conversion to grid
- Specifically designed for PV inverter, Smart Grid and EV related test applications
- 800VLN output voltage for high voltage high power grid tied PV inverter \ PCS test application (61800-100 800VLN)
- 1kHz output
- Programmable slew rate settings for voltage and frequency
- Programmable voltage and current limits
- Turn on, turn off phase angle control
- LIST, PULSE, STEP mode functions for testing Power Line Disturbance (PLD) simulation
- Voltage dips, short interruption and voltage variation simulation
- Harmonics, inter-harmonics waveform synthesizer
- Comprehensive measurement capability, including current harmonics
- Analog programmable interfaces
- Remote interfaces: GPIB, RS-232, USB and Ethernet
- Parallel output function supports three phase mode only (not single phase mode)
- Regenerative AC load function (option)
- XHV function (option)

*1: 61830/61845/61860 option

*2: 61800-100 option

*3: 61800-100 (800VLN)

REGENERATIVE GRID SIMULATOR MODEL 61800 SERIES

Market demand for Distributed Resource (DR) products such as PV inverters and wind energy systems is steadily growing as the world strives for clean renewable energy sources. This demand has created a need for rigorous regulation testing to standards like UL 1741SA / IEEE 1547 / IEC 62116 which ensure proper and safe operation of on-grid products. It has become critical to manufacturers to conduct these tests in order to prove compliance and to relieve product liability concerns. Chroma's new 61800 family of grid simulators has been designed to fulfill these test requirements by providing a full 4 quadrant, fully regenerative, grid simulator with advanced features for compliance, safety and product verification testing.

The 61800 regenerative grid simulator allows users to vary relevant parameters in order to simulate real world grid environments and conditions. Supported variations include frequency, phase angle, voltage amplitude, voltage drops in either single or three phase modes. Unbalanced three phase conditions can easily be simulated. And most importantly, the regenerative feature of the 61800 grid simulator provides an effective energy saving method since the power generated by the unit under test can be efficiently fed back to the grid instead of dissipated as heat during operation.

The 61800 grid simulator also meets test requirements for smart grid and EV related test applications, such as Vehicle to Grid (V2G) and Energy Storage System (ESS) testing. The 61800 is also capable of meeting IEC regulatory standards (such as IEC 61000-3-2/-3-3/-3-11/-3-12) requirements for AC supplies.

The 61800 regenerative grid simulator is capable of much more than just product development during R&D. Its extensive features are also valuable during design and quality verification as well as throughout various production stages. Using state-of-the-art digital control technology the 61800 can deliver up to 300VAC at output frequencies ranging from 30Hz to 100Hz. The AC+DC provides support for applications which require a DC offset bias.

The 61800 series is also able to provide precision measurements such as RMS voltage, RMS current, true power, power factor, current crest factor and many others. By applying advanced DSP technology, the 61800 can easily simulate power line disturbance (PLD) using LIST, PULSE and STEP modes. Additional features such as the waveform synthesis function allows users to program various distorted harmonic waveforms that are required by some regulatory standards. GPIB (IEEE488.2), RS-232, USB and Ethernet interface are available to control the 61800 grid simulator remotely.



FUNCTIONS AND APPLICATIONS

The 61800 Regenerative Grid Simulator is a full 4 quadrant, full regenerative, AC power supply designed for common electrical product testing such as home appliances, and industrial electronics needing a programmable input source. In addition, the 61800 is designed to simulate grid characteristics for testing PV inverter and on-line UPSs. As shown below, power can be both sink and source from the UUT seamlessly to support different types of applications. In cases where the UUT sources current a detection circuit will sense the excess power and recycled it back to the grid.

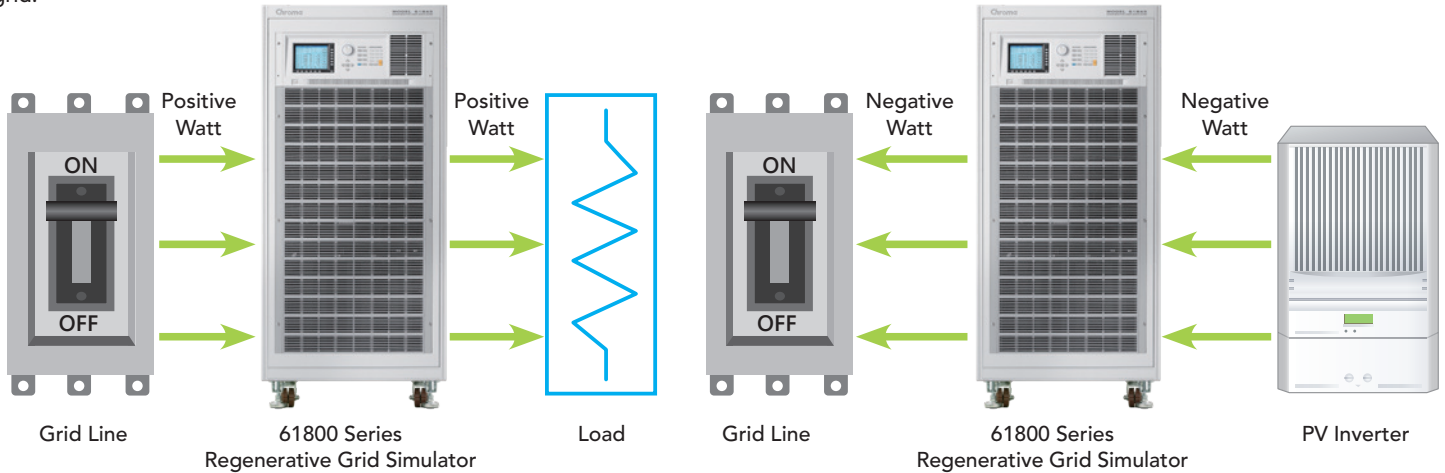

In addition to supplying clean, precise and stable AC voltage for regular applications, the 61800 is capable of simulating various types of distorted voltage waveforms and transient conditions required by product validation testing. These are accomplished as shown below using built-in programmable waveform functions like the LIST/STEP/PULSE modes. The STEP and PUSLE functions allow users to perform single or continuous step changes of output voltage while the LIST mode is a more versatile function as it allows users to compose complex waveforms of up to 100 sequences. Voltage waveforms required by immunity specifications such as IEC 61000-4-11 (short interruption and voltage dropout) can be easily achieved by the 61800 Regenerative Grid Simulator.

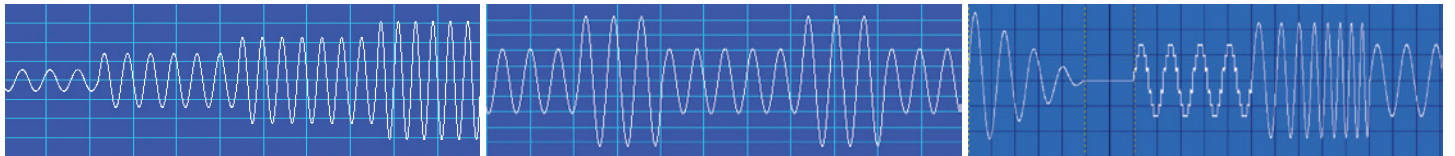

STEP Mode

PULSE Mode

LIST Mode

The SYNTHESIS function allows users to create periodic harmonic voltage waveforms of up to 50 orders based on a 50/60Hz fundamental frequency. The INTERHARMONIC function allows users to perform frequency sweeps ranging from 0.01Hz to 2400Hz on top of the 50/60Hz fundamental frequency. This special function assists users in locating resonance points.

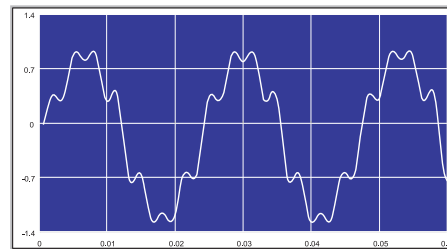

Harmonics Waveform

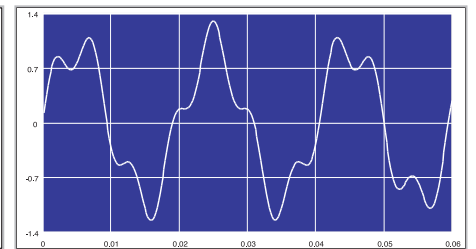

Interharmonics Waveform

Arbitrary Power Amplifier

The external voltage programming input of the 61800 series Regenerative Grid Simulator allows users to feed any AC+DC waveform from an arbitrary signal generator and to amplify the signal accordingly. It can be used to simulate the real mains supply waveforms observed in the field or implemented with real-time digital simulator for HIL (Hardware In Loop) applications. The delay time from external voltage programming input to actual voltage output is approximately 100 μ s.

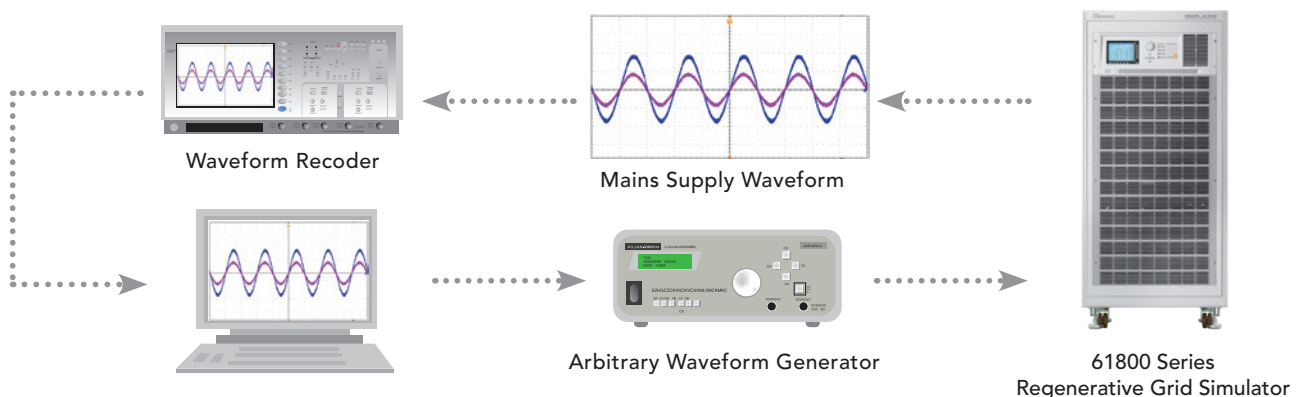

Implement for Low Voltage Ride Through (LVRT) Testing

The Low Voltage Ride Through (LVRT) function of grid tied PV inverter clearly defines that when an abnormality occurs on the main AC grid (such as a voltage drop), the PV inverter must remain operable and sustain the main AC grid for a certain specific time period. For instance : the BDEW standard requires the PV inverter to remain operable and delivering reactive power for at least 150ms when the grid voltage has dropped to 15% of the nominal value.

The 61800 Regenerative Grid Simulator is fully capable of meeting the LVRT test requirements, as the user can program the required transient test conditions through implementation of the LIST mode function, which provides a minimum time resolution setting of 0.1ms. Moreover, the user can also study and evaluate the impact on PV inverter performance due to grid line voltage distortion, by implementing the harmonic synthesis function of the 61800 series product. The frequency resolution of the 61800 is 0.01Hz which meets the BDEW requirement.

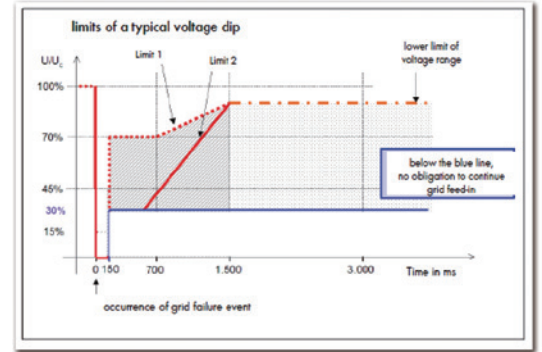

Test number	U/UN	LVRT duration (ms)
1	≤0.05	≥ 150
2	0.2 - 0.5	≥ 550
3	0.45 - 0.55	≥ 950
4	0.7 - 0.8	≥ 1400

Implement for Anti-islanding Testing

By incorporating the 61800 Regenerative Grid Simulator with the 8000 ATS and RLC load, the test system is capable of meeting IEEE 1547/IEC 62116 test requirements for Anti-islanding.

Implement for Grid Tied DG Regulations Testing

The 61800 series Regenerative Grid Simulator is capable of meeting the following regulations designated for Grid Tied Discrete Generator testing for UL 1741SA/IEEE 1547/IEC 62116 :

- ✓ Voltage Abnormality Test
- ✓ Anti-islanding Test
- ✓ Immunity Test (IEC 61000-4-11/-4-34)
- ✓ Frequency Abnormality Test
- ✓ Low Voltage Ride Through Test
- ✓ Limit Test (IEC 61000-3-2/-3-3)

The 61800 series support Master-Slave parallel operation, which allows users for further extend the output power capability by connecting multiple units in parallel for higher power test application. Please refer to the following table as the combination allowed for parallel connection of different 61800 models.

	61830	61845	61860	61800-100	61800-100 (800VLN)
61830	Yes *1	Yes *1	Yes *1	No	No
61845	Yes *1	Yes *1	Yes *1	No	No
61860	Yes *1	Yes *1	Yes *1	No	No
61800-100	No	No	No	Yes *2	No
61800-100 (800VLN)	No	No	No	No	Yes *3

Note*1: The maximum number of parallel unit for 61830/61845/61860 is 5 units.

Note*2: The maximum number of parallel unit for 61800-100 model is 8 units.

Note*3: The maximum number of parallel unit for 61800-100 (800VLN) is 3 units.

High Voltage and High Power Test Solutions: 61800-100 (800VLN) integration of 800VLN transformer

The 61800-100 (800VLN) model with integration of external 800VLN step up transformer is capable of meeting the high voltage grid connected PV inverter, PCS products with AC voltage up to 1000VLL related test requirements, such as: grid connected performance, voltage/frequency adaptability, high voltage ride through, etc. The 61800-100 (800VLN) also support parallel output function to meet the needs of high voltage and high power test requirements.

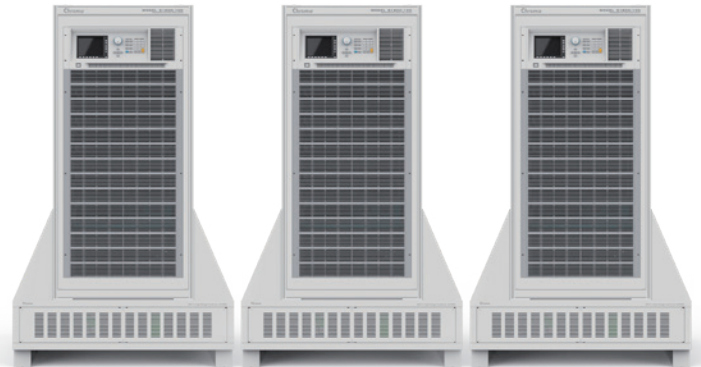

Parallel connection of 3 sets of 61800-100 (800VLN) for 315kVA output power rating

OPTIONAL FUNCTIONS

AC LOAD 3_Phase LOCAL QUIT					
CC-RECTIFIED CONDITION					Main
#1	I _{ac} =	0.0A	CF =	1.414	Measurement Setting
#2	I _{ac} =	0.0A	CF =	1.414	
#3	I _{ac} =	0.0A	CF =	1.414	
MEASUREMENT					
#1	V =	0.00	P _o =	0.0	Waveform Viewer
	I =	0.000	PF =	0.000	
#2	V =	0.00	P _o =	0.0	
	I =	0.000	PF =	0.000	
#3	V =	0.00	P _o =	0.0	
	I =	0.000	PF =	0.000	
Σ	V ₁₂ =	0.00	V ₂₃ =	0.00	Measurement To Page2
	V ₃₁ =	0.00	P _o =	0.0	
CC Rectifier	CP Rectifier	CR	CC Lead/Lag	CP Lead/Lag	2017/08/28 16:22:44

The 61830/61845/61860 models further extend their test application capabilities by including optional functions such as B618000: Regenerative AC load function and B618002: 800V_{LN} XHV function. Connecting two 61860 with the B618002 can achieve 120kVA 800V_{LN} XHV function. Furthermore, the 61800-100 can work with B618003: 500V_{LN} HV function and B618004: regenerative AC load function. Connecting two 61800-100 with the B618002 can achieve 210kVA 900V_{LN} XHV function.

The regenerative AC load function consists of various modes such as CC Rectified mode, CP Rectified mode, CR mode, CC Phase lead/lag mode and CP Phase lead/lag mode.

The Rectified Mode is capable of simulating non-linear rectified loads with characteristics similar to Chroma 63800 series AC load where the voltage and current operate at the 1st and 3rd quadrant. The Rectified Mode supports both CC and CP functions with current, power and CF as parameter settings.

The phase lead/lag mode with phase angle setting ranging from 90 degree ~ -90 degree will simulate the corresponding voltage and current condition under an inductive or capacitive type load. Please note the current waveform is sinusoidal under the Phase Lead/Lag mode (current, PF and phase angle as parameter settings) and when the phase angle setting is in the range of 90.1 degree ~ 180 degree (-90 degree ~ -180 degree), the 61800 will become a current source. The regenerative AC load function is mainly intended for EVSE charging station, hybrid PV inverter, PCS, UPS, and micro-grid related test applications.

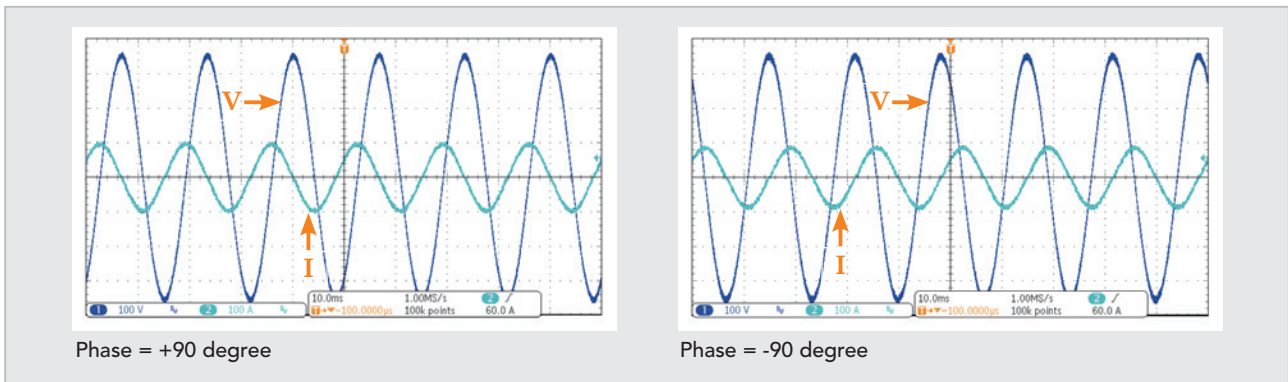

CC Phase Lead/Lag Mode Test

Please refer to the following as 61800 models support list for AC load function:

	61830	61845	61860	61800-100
AC Load Option	B618000			B618004

The XHV option is for achieving high output phase voltage by connecting two regenerative grid simulators in series with high performance output voltage transient capability which is unmatched by the implementation of step up transformer. The XHV option is mainly intended to meet the test requirement of HV PV inverter with line voltage up to 1000V_{LN}.

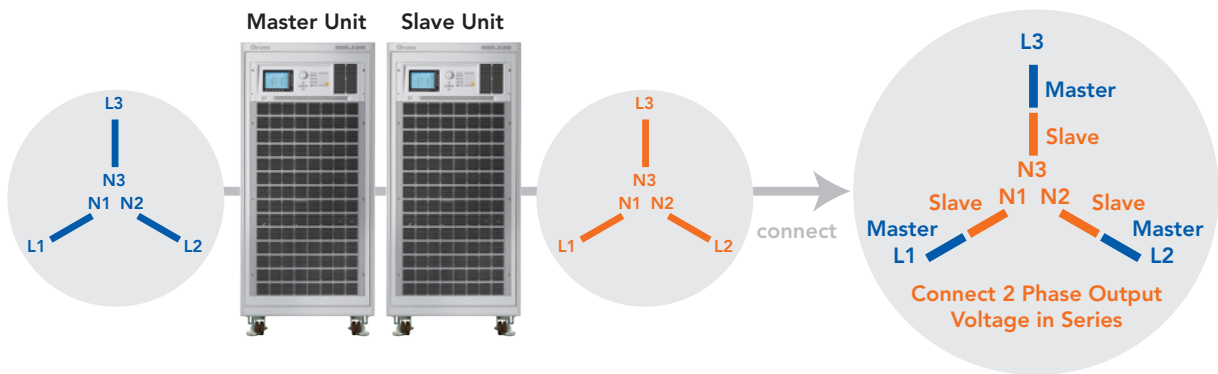

Please refer to the following table as the combinations allowed for high voltage series connection of different 61800 models:

	61830	61845	61860	61800-100
61830	Yes ^{*1}	No	No	No
61845	No	Yes ^{*1}	No	No
61860	No	No	Yes ^{*1}	No
61800-100	No	No	No	Yes ^{*2}

Note*1: B618002: 800V_{LN} XHV function

Note*2: B618005: 900V_{LN} XHV function.

SOFTPANEL

The 61800 Softpanel is a Graphical User Interface specifically designed to provide users with an easy to use interface for configuring the instrument. The intuitive graphical panels provide simple control of the 61800 with just a few clicks of a button. The Softpanel is also equipped with data recording functions allowing multiple measurements to be recorded and saved simultaneously.

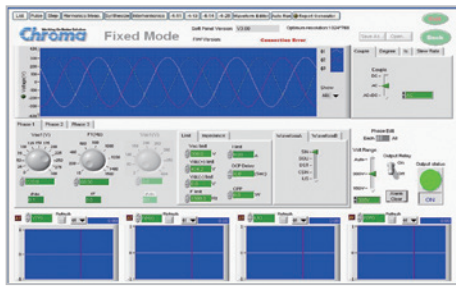

Main Operation Menu

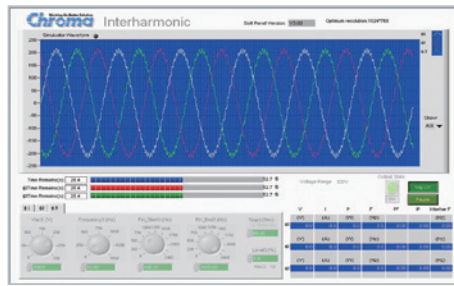

Interharmonic Test



Transient Voltage Programming

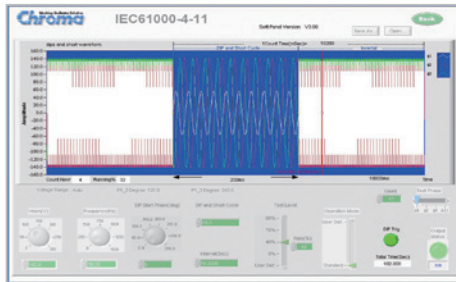

Voltage DIP, Short Interruption, Variation Test



Distorted Waveform Editor

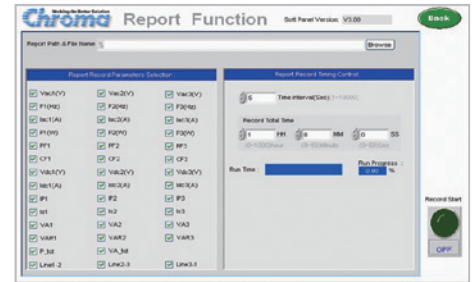

Recording Function

PANEL DESCRIPTION

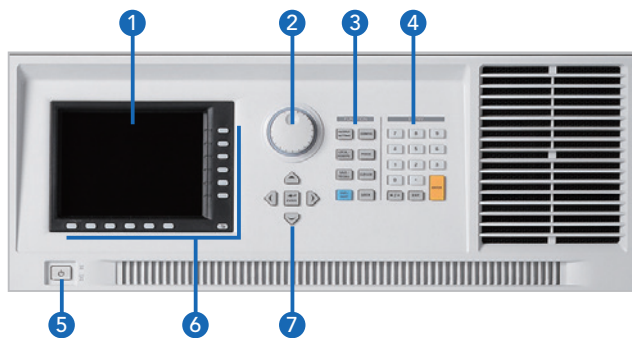

1. LCD Display
2. Rotary Knob: For adjusting voltage, frequency and other parameter setting
3. Function Key: Hot keys for quick parameter setting
4. Numeric Key: For data entry
5. On/Off Power Switch
6. Soft Keys: Supports menu driven interface
7. Cursor movement Keypad
8. External V reference/TTL I/O Port:
External analog signal for voltage control and signals for system integration
9. Remote Control Port: used for handheld controller
10. LAN (Ethernet) Port
11. USB Interface
12. RS-232 Interface
13. GPIB Interface
14. Master/Slave parallel port:
Used when paralleling more then one unit
15. Remote Sense: For line voltage compensation
16. Main Power Breaker:
NFB with leakage current detection ability
17. Input AC power terminal
18. Output Terminal
19. USB Host

61830/61845/61860

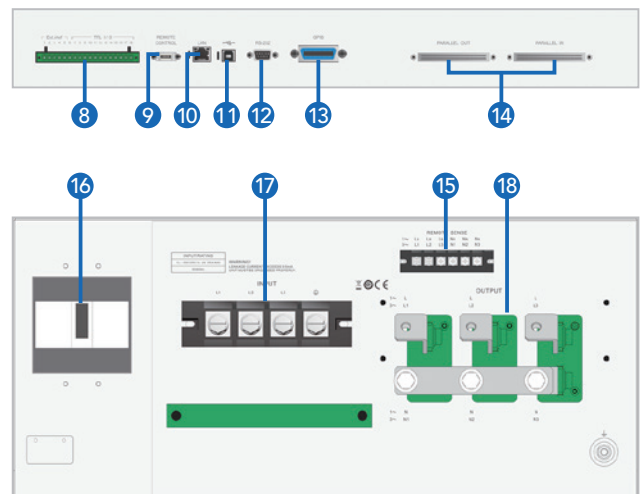

61800-100

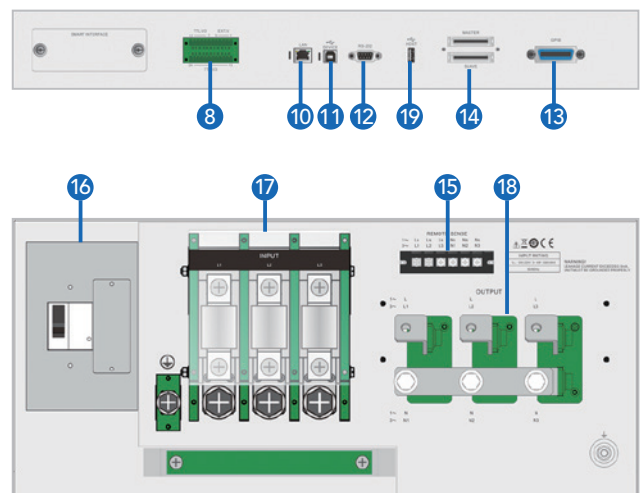

SPECIFICATIONS-1

Model	61830	61845	61860
AC Output Rating			
Output Phase	1 or 3 selectable	1 or 3 selectable	1 or 3 selectable
Max. Power	30kVA	45kVA	60kVA
Per Phase	10kVA	15kVA	20kVA
Voltage			
Range	0~300V _{LN} /0~520V _{LL} Option-HV: 0~400V _{LN} /0~693V _{LL}	0~300V _{LN} /0~520V _{LL} Option-HV: 0~400V _{LN} /0~693V _{LL}	0~300V _{LN} /0~520V _{LL} Option-HV: 0~400V _{LN} /0~693V _{LL}
Accuracy	0.1%+0.2%F.S.	0.1%+0.2%F.S.	0.1%+0.2%F.S.
Resolution	0.1V	0.1V	0.1V
Distortion	< 0.5% @ 50/60Hz *1 < 0.8% @ 30Hz~100Hz	< 0.5% @ 50/60Hz *1 < 0.8% @ 30Hz~100Hz	< 0.5% @ 50/60Hz *1 < 0.8% @ 30Hz~100Hz
Line regulation	0.10%	0.10%	0.10%
Load regulation	0.20%	0.20%	0.20%
Max. Current (1-Phase Mode)			
RMS	150A	225A	300A
Peak	450A	675A	900A
Max. Current (each phase in 3-Phase Mode)			
RMS	50A	75A	100A
Peak	150A	225A	300A
Frequency			
Range	30Hz ~ 100Hz	30Hz ~ 100Hz	30Hz ~ 100Hz
Accuracy	0.01%	0.01%	0.01%
DC Output (1-Phase Mode) *3			
Power	15kW	22.5kW	30kW
Voltage	424V	424V	424V
Current	75A	112.5A	150A
DC Output (3-Phase Mode)			
Power	5kW	7.5kW	10kW
Voltage	424V	424V	424V
Current	25A	37.5A	50A
Harmonics Synthesis Function			
Harmonics range	up to 50 harmonics order @ 50/60Hz fundamental frequency		
Input Rating			
Voltage Operating Range *4	3Ø 200~220V ± 10%V _{LL} , 47~63Hz 3Ø 380~400V ± 10%V _{LL} , 47~63Hz 3Ø 440~480V ± 10%V _{LL} , 47~63Hz	3Ø 200~220V ± 10%V _{LL} , 47~63Hz 3Ø 380~400V ± 10%V _{LL} , 47~63Hz 3Ø 440~480V ± 10%V _{LL} , 47~63Hz	3Ø 200~220V ± 10%V _{LL} , 47~63Hz 3Ø 380~400V ± 10%V _{LL} , 47~63Hz 3Ø 440~480V ± 10%V _{LL} , 47~63Hz
Current	125A Max./Phase (3Ø 200~220V ± 10%V _{LL}) 65A Max./Phase (3Ø 380~400V ± 10%V _{LL}) 58A Max./Phase (3Ø 440~480V ± 10%V _{LL})	190A Max./Phase (3Ø 200~220V ± 10%V _{LL}) 100A Max./Phase (3Ø 380~400V ± 10%V _{LL}) 87A Max./Phase (3Ø 440~480V ± 10%V _{LL})	250A Max./Phase (3Ø 200~220V ± 10%V _{LL}) 130A Max./Phase (3Ø 380~400V ± 10%V _{LL}) 115A Max./Phase (3Ø 440~480V ± 10%V _{LL})
Power factor	0.99 (Typical)		
Measurement			
Voltage			
Range	0~300V	0~300V	0~300V
Accuracy	0.1%+0.2%F.S.	0.1%+0.2%F.S.	0.1%+0.2%F.S.
Current			
Range (peak)	150A	225A	300A
Accuracy (RMS)	0.4%+0.3%F.S.	0.4%+0.3%F.S.	0.4%+0.3%F.S.
Accuracy (peak)	0.4%+0.6%F.S.	0.4%+0.6%F.S.	0.4%+0.6%F.S.
Power			
Accuracy	0.4%+0.4% F.S.	0.4%+0.4% F.S.	0.4%+0.4% F.S.
Others			
Efficiency	80% (Typical)		
Protection	OVP, OCP, OPP, OTP, FAN		
Safety & EMC	CE (include EMC & LVD)		
Dimension (H x W x D)	1740 x 780 x 1000 mm / 68.5 x 30.7 x 39.4 inch (include wheel set)	1740 x 780 x 1000 mm / 68.5 x 30.7 x 39.4 inch (include wheel set)	1740 x 780 x 1000 mm / 68.5 x 30.7 x 39.4 inch (include wheel set)
Weight	850kgs	850kgs	870kgs

Note*1 : Maximum distortion is tested on output 250V with maximum current to linear load.

Note*2 : Maximum distortion is tested on output 500V with maximum current to linear load.

Note*3 : The DC function is mainly intended as DC offset for AC+DC output voltage function.

Note*4 : Must be specified at time of order. All inputs are L-L, 3Ø, 3 wire+GND.

All specifications are subject to change without notice.

SPECIFICATIONS-2

Model	61800-100	61800-100 (800VLN)	
AC Output Rating			
Output Phase	1 or 3 selectable	(800VLN XHV disable) 1 or 3 selectable	(800VLN XHV enable) three phase only
Max. Power	105kVA	105kVA	105kVA
Per Phase	35kVA	35kVA	35kVA
Voltage			
Range	0~300V ; Option : 0~500V	0~500V	0~800V
Accuracy	0.1%+0.2%F.S.	0.1%+0.2%F.S.	0.2%+0.2%F.S.
Resolution	0.1V	0.1V	0.1V
Distortion *1	< 0.5% @ 30~65Hz < 0.8% @ 65~100Hz	< 0.5% @ 30~65Hz < 0.8% @ 65~100Hz	< 0.8% @ 50/60Hz < 1.1% @ 30~100Hz
Line Regulation	0.10%	0.10%	0.10%
Load Regulation	0.20%	0.20%	0.20%
Max. Current (1-Phase Mode)			
RMS	420A	420A	N/A
Peak	1080A	1080A	N/A
Max. Current (each phase in 3-Phase Mode)			
RMS	140A	140A	70A
Peak	360A	360A	140A
Frequency			
Range	30Hz~100Hz	30Hz~100Hz	45~100Hz @ 0~650V 47~100Hz @ 650~800V
Accuracy	0.01%	0.01%	0.02%
DC Output (1-Phase Mode) *2			
Power	52.5kW	52.5kW	N/A
Voltage	424V (Optional HV: 690V)	690V	N/A
Current	210A	210A	N/A
DC Output (3-Phase Mode)			
Power	17.5kW	17.5kW	N/A
Voltage	424V (Optional HV: 690V)	690V	N/A
Current	70A	70A	N/A
Harmonics Synthesis Function			
Harmonics Range	up to 50 harmonics order @ 50/60Hz fundamental frequency		
Input Rating			
Voltage Operating Range *3	3Ø 200~220V ± 10%V _{LL} , 47~63Hz 3Ø 380~400V ± 10%V _{LL} , 47~63Hz 3Ø 440~480V ± 10%V _{LL} , 47~63Hz		
Current	Max. 438A/Phase (3Ø 200~220V ± 10%V _{LL}) Max. 228A/Phase (3Ø 380~400V ± 10%V _{LL}) Max. 200A/Phase (3Ø 440~480V ± 10%V _{LL})		
Power Factor	> 0.95 (Typical)		
Measurement			
Voltage			
Range	0~300V Option: 0~500V	0~500V	0~800V
Accuracy	0.1%+0.2%F.S.	0.1%+0.2%F.S.	0.2%+0.2%F.S.
Current			
Range (Peak)	360A	360A	210A
Accuracy (RMS)	0.4%+0.3%F.S.	0.4%+0.3%F.S.	0.4%+0.3%F.S.
Accuracy (Peak)	0.4%+0.6%F.S.	0.4%+0.6%F.S.	0.4%+0.6%F.S.
Power			
Accuracy	0.4%+0.4% F.S.	0.4%+0.4% F.S.	0.4%+0.5% F.S.
Others			
Efficiency	80% (Typical)		
Protection	OVP, OCP, OPP, OTP, FAN		
Safety & EMC	CE (include EMC & LVD)		
Dimension (H x W x D)	1740 x 780 x 1000 mm / 68.5 x 30.7 x 39.4 inch (include wheel set)	2030 x 1200 x 1215 mm / 79.9 x 47.2 x 47.8 inch (include wheel set)	2030 x 1200 x 1215 mm / 79.9 x 47.2 x 47.8 inch (include wheel set)
Weight	1120 kgs	1900 kgs	1900 kgs

Note*1 : Maximum distortion is tested on output 500V with maximum current to linear load.

Note*2 : The DC function is mainly intended as DC offset for AC+DC output voltage function.

Note*3 : Must be specified at time of order. All inputs are L-L, 3Ø, 3 wire+GND.

All specifications are subject to change without notice.

SPECIFICATIONS - B618000/B618004 REGENERATIVE AC LOAD

Optional ACL AC Load Functions	61830	61845	61860	61800-100
Current (3-phase/per phase)				
Current (RMS)	50A	75A	100A	140A
Current (Peak)	150A _{peak}	225A _{peak}	300A _{peak}	360A _{peak}
Operating Voltage Range	50~300V _{LN} ; Option-HV: 50~400V _{LN}			50~300V _{LN}
Operating Frequency				
Range	30Hz ~ 100Hz			
Accuracy	0.01%			
Resolution	0.1Hz			
CC Rectified Mode (each phase)				
Range	0~50A	0~75A	0~100A	0~140A
Accuracy	0.3%R.D. + 0.5%F.S. (above 2A)	0.3%R.D. + 0.5%F.S. (above 2A)	0.3%R.D. + 0.5%F.S. (above 2A)	0.3%R.D. + 0.5%F.S. (above 5A)
Resolution	0.1A	0.1A	0.1A	0.1A
Crest Factor	1.414~3.0	1.414~3.0	1.414~3.0	1.414~2.57
Resolution	0.001	0.001	0.001	0.001
CP Rectified Mode (each phase)				
Range	0~10kW	0~15kW	0~20kW	0~35kW
Accuracy	0.3%R.D. + 0.6%F.S. (above 200W)	0.3%R.D. + 0.6%F.S. (above 200W)	0.3%R.D. + 0.6%F.S. (above 200W)	0.3%R.D. + 0.6%F.S. (above 1.5kW)
Resolution	10W	10W	10W	10W
Crest Factor	1.414~3.0	1.414~3.0	1.414~3.0	1.414~2.57
Resolution	0.001	0.001	0.001	0.001
CC Phase Lead/Lag Mode (each phase)				
Range	0~50Arms	0~75Arms	0~100Arms	0~140Arms
Accuracy	0.3%R.D. + 0.5%F.S. (above 2A)	0.3%R.D. + 0.5%F.S. (above 2A)	0.3%R.D. + 0.5%F.S. (above 2A)	0.3%R.D. + 0.5%F.S. (above 5A)
Resolution	0.1A	0.1A	0.1A	0.1A
Phase	-90deg ~ +90deg (current source mode: +90.1deg ~ +180deg & -90.1deg ~ -180deg)			
Accuracy	0.6%F.S.(30~70Hz) 1.0%F.S.(71Hz~100Hz)	0.6%F.S.(30~70Hz) 1.0%F.S.(71Hz~100Hz)	0.6%F.S.(30~70Hz) 1.0%F.S.(71Hz~100Hz)	0.6%F.S. (30Hz~100Hz)
Resolution	0.1deg	0.1deg	0.1deg	0.1deg
CP Phase Lead/Lag Mode (each phase)				
Range	0~10kW	0~15kW	0~20kW	0~35kW
Resolution	10W	10W	10W	10W
Accuracy	0.3%R.D. + 0.6%F.S. (above 200W)	0.3%R.D. + 0.6%F.S. (above 200W)	0.3%R.D. + 0.6%F.S. (above 200W)	0.3%R.D. + 0.6%F.S. (above 1.5W)
Phase	-90deg ~ +90deg (current source mode: +90.1deg ~ +180deg & -90.1deg ~ -180deg)			-45deg ~ 0deg & +45deg ~ 0deg (current source mode : +135deg ~ +180deg & -135deg ~ -180deg)
Accuracy	0.6%F.S.(30~60Hz) 0.8%F.S.(61Hz~100Hz)	0.6%F.S.(30~60Hz) 0.8%F.S.(61Hz~100Hz)	0.6%F.S.(30~60Hz) 0.8%F.S.(61Hz~100Hz)	0.6%F.S. (30Hz~100Hz)
Resolution	0.1deg	0.1deg	0.1deg	0.1deg
CR Mode (each phase)				
Range	1~300ohm	1~300ohm	1~300ohm	1~300ohm
Accuracy	Convert to current value 0.3%R.D. + 0.7%F.S. (above 2A)	Convert to current value 0.3%R.D. + 0.7%F.S. (above 2A)	Convert to current value 0.3%R.D. + 0.7%F.S. (above 2A)	Convert to current value 0.3%R.D. + 0.7%F.S. (above 5A)
Resolution	0.1ohm	0.1ohm	0.1ohm	0.1ohm

* All specifications are subject to change without notice.

ORDERING INFORMATION

61830 : Regenerative Grid Simulator 30kVA
 61845 : Regenerative Grid Simulator 45kVA
 61860 : Regenerative Grid Simulator 60kVA
 61800-100 : Regenerative Grid Simulator 105kVA
 61800-100 (800V_{LN}) : Regenerative Grid Simulator 105kVA
 (with 800V_{LN} HV transformer)
 A618001 : Softpanel for 61800 Series
 A618002 : Terminals for parallel connecting

61830/61845/61860 option (factory installation) : 61800-100 option (factory installation) :
 B618000 : Regenerative AC load function B618003 : 500V_{LN} HV option
 B618001 : 400V_{LN} HV option B618004 : Regenerative AC load function
 B618002 : 800V_{LN} XHV function B618005 : 900V_{LN} XHV function

Get more product and distributor information in Chroma ATE APP



iOS



Android

Search Keyword

61800

HEADQUARTERS
 CHROMA ATE INC.
 88 Wenmao Rd.,
 Guishan Dist.,
 Taoyuan City
 333001, Taiwan
 T +886-3-327-9999
 F +886-3-327-8898
 www.chromaate.com
 info@chromaate.com

U.S.A.
 CHROMA SYSTEMS
 SOLUTIONS, INC.
 19772 Pauling,
 Foothill Ranch,
 CA 92610
 T +1-949-600-6400
 F +1-949-600-6401
 www.chromausa.com
 sales@chromausa.com

EUROPE
 CHROMA ATE EUROPE B.V.
 Morsestraat 32, 6716 AH
 Ede, The Netherlands
 T +31-318-648282
 F +31-318-648288
 www.chroma.eu.com
 salesnl@chroma.eu.com

CHROMA GERMANY GMBH
 Südtiroler Str. 9, 86165,
 Augsburg, Germany
 T +49-821-790967-0
 F +49-821-790967-600
 www.chroma.eu.com
 salesde@chroma.eu.com

JAPAN
 CHROMA JAPAN
 CORP.
 888 Nippa-cho,
 Kouhoku-ku,
 Yokohama-shi,
 Kanagawa,
 223-0057 Japan
 T +81-45-542-1118
 F +81-45-542-1080
 www.chroma.co.jp
 info@chroma.co.jp

KOREA
 CHROMA ATE
 KOREA BRANCH
 3F Richtogether
 Center, 14,
 Pangyoyeok-ro 192,
 Bundang-gu,
 Seongnam-si,
 Gyeonggi-do
 13524, Korea
 T +82-31-781-1025
 F +82-31-8017-6614
 www.chromaate.co.kr
 info@chromaate.com

CHINA
 CHROMA ELECTRONICS
 (SHENZHEN) CO., LTD.
 8F, No.4, Nanyou Tian
 An Industrial Estate,
 Shenzhen, China
 T +86-755-2664-4598
 F +86-755-2641-9620
 www.chroma.com.cn
 info@chromaate.com

SOUTHEAST ASIA
 QUANTEL PTE LTD.
 (A company of Chroma Group)
 25 Kallang Avenue #05-02
 Singapore 339416
 T +65-6745-3200
 F +65-6745-9764
 www.quantel-global.com
 sales@quantel-global.com