



Errata

Title & Document Type: 83711, 83712, 83731 and 83732 Synthesized Signal Generator Calibration Guide

Manual Part Number: 83731-90125

Revision Date: November 1998

HP References in this Manual

This manual may contain references to HP or Hewlett-Packard. Please note that Hewlett-Packard's former test and measurement, semiconductor products and chemical analysis businesses are now part of Agilent Technologies. We have made no changes to this manual copy. The HP XXXX referred to in this document is now the Agilent XXXX. For example, model number HP8648A is now model number Agilent 8648A.

About this Manual

We've added this manual to the Agilent website in an effort to help you support your product. This manual provides the best information we could find. It may be incomplete or contain dated information, and the scan quality may not be ideal. If we find a better copy in the future, we will add it to the Agilent website.

Support for Your Product

Agilent no longer sells or supports this product. You will find any other available product information on the Agilent Test & Measurement website:

www.tm.agilent.com

Search for the model number of this product, and the resulting product page will guide you to any available information. Our service centers may be able to perform calibration if no repair parts are needed, but no other support from Agilent is available.

Calibration Guide

**HP 83711A/12A, HP 83711B/12B,
HP 83731A/32A and HP 83731B/32B
Synthesized Signal Generators**



**HP Part No. 83731-90125
Printed in USA November 1998 Supersedes July 1997**

The Calibration Guide

This calibration guide provides procedures for testing all of the HP 837XX Series synthesizers' warranted specifications. All required manual and automated adjustment procedures are also provided for these instruments.

Certain terms and figures that are used throughout this document are meant to apply to the HP 83711A, 83712A, HP 83711B, HP 83712B, HP 83731A, HP 83732A, HP 83731B, HP 83732B. The term synthesizer applies to all of these models.

In This Guide

This book contains the information required to verify and adjust the performance of your synthesizer. It is divided into the following chapters:

- **Chapter 1, “Specifications,”** contains a list of the specifications and supplemental characteristics for each instrument: HP 83711A, HP 83712A, HP 83711B, HP 83712B, HP 83731A, HP 83732A, HP 83731B, HP 83732B.
- **Chapter 2, “Equipment Required,”** contains the “Required Test Equipment” table which lists the equipment necessary for performance tests, along with critical specifications and recommended models.
- **Chapter 3, “Performance Tests,”** contains procedures which verify all of the instrument hard specifications.
- **Chapter 4, “Performance Test Record,”** contains the worksheets for recording performance test values. There is a separate test record for each of the four synthesizers covered in this book. The test record should be treated as a master; copies should be made where actual records are kept.
- **Chapter 5, “Operation Verification,”** contains a procedure used to verify the synthesizer’s functionality.
- **Chapter 6, “Adjustments,”** contain the procedures to manually adjust the synthesizer after certain repairs and for improved performance.
- **Chapter 7, “Service Software,”** contain the procedures to automatically adjust the synthesizer after certain repairs and for improved performance.
- **Chapter 8, “Maintenance and Service,”** contains information about cleaning the instrument, packaging the instrument and shipping it back to Hewlett-Packard, a table of the sales and service offices, and blue service tags.
- **Chapter 9, “Legal and Regulatory Information,”** pertains to the safety and the warranty.

Contents

1. Specifications	
HP 83711A/11B Specifications	1-2
Frequency	1-2
RF Output	1-3
Spectral Purity	1-4
HP 83712A/12B Specifications	1-7
Frequency	1-7
RF Output	1-7
Spectral Purity	1-9
HP 83731A/32A Specifications	1-12
Frequency	1-12
RF Output	1-13
Spectral Purity	1-15
Modulation	1-17
HP 83731B/32B Specifications	1-21
Frequency	1-21
RF Output	1-22
Spectral Purity	1-24
Modulation	1-26
Option 1E2	1-32
General Specifications	1-34
Front Panel Connectors	1-35
Rear Panel Connectors	1-36
Options	1-37
Electrical Options	1-37
2. Equipment Required	
Required Test Equipment Table	2-2
3. Performance Tests	
Introduction	3-1
Performance Test Records	3-1
Calibration Cycle	3-1
Required Test Equipment	3-1
Test Setups	3-2
The Synthesizer Self Test	3-3
If the Procedure Fails	3-3
Internal Timebase Aging Rate (Option 1E5 Only)	3-4
Specification	3-4
Recommended Equipment	3-4
If the Procedure Fails	3-5
Frequency Range and Resolution	3-6
Specification	3-6
Recommended Equipment	3-6
To Set Up the Equipment	3-6
To Check Frequency Resolution	3-7

To Check Frequency Range	3-7
If the Procedure Fails	3-7
External ALC	3-8
Recommended Equipment	3-8
To Set Up the Equipment	3-8
To Level the Signal Externally	3-8
To Verify External Leveling	3-9
If the Procedure Fails	3-9
Maximum Leveled Power	3-10
Recommended Equipment	3-10
To Set Up the Equipment	3-11
To Measure Maximum Power at 1 GHz	3-11
To Measure Maximum Power between 1 GHz and 18 GHz	3-12
To Measure Maximum Power between 18 GHz and 20 GHz	3-13
To Measure Maximum Power for 0.01 to 1 GHz (HP 83712A/12B, HP 83732A/32B, Only)	3-13
If the Procedure Fails	3-14
Vernier Level Accuracy and Flatness	3-15
Recommended Equipment	3-15
To Set Up the Equipment	3-15
To Measure Vernier Level Accuracy	3-16
To Check Flatness	3-17
If the Procedure Fails	3-17
Low Level Accuracy and Flatness (Option 1E1 Only)	3-18
Recommended Equipment	3-18
To Set Up the Equipment for Levels from -24 dBm to +5 dBm	3-18
To Measure Level Accuracy from -24 dBm to +5 dBm with a Power Meter	3-19
To Establish References at -14 dBm and +5 dBm with a Power Meter for Level Flatness	3-19
To Set Up Equipment for Frequencies Below 1 GHz and Levels from -34 dBm to -90 dBm (to -105 for HP 83712B and HP 83732B)	3-20
To Measure Relative Level Accuracy below 1 GHz from -34 dBm to -90 dBm (to -105 for HP 83712B and HP 83732B)	3-20
To Establish Relative References below 1 GHz at -90 dBm for Level Flatness (-105 for HP 83712B and HP 83732B)	3-22
To Set Up Equipment for Frequencies above 1 GHz and levels from -34 dBm to -90 dBm (to -105 for "B" models)	3-23
To Measure Relative Level Accuracy above 1 GHz from -34 dBm to -90 dBm (to -105 for "B" models)	3-24
To Establish Relative References above 1 GHz at -90 dBm for Level Flatness (-105 dBm for "B" models)	3-25
To Calculate the Actual Power Levels from -34 dBm to -95 dBm	3-26
To Calculate Actual Power Levels for Flatness	3-27
To Calculate Flatness from 0.01 to 1 GHz	3-27
To Calculate Actual Power Levels for Flatness	3-27
To Calculate Flatness from 1 to 20 GHz	3-28
If the Procedure Fails	3-28
Harmonics	3-29
Recommended Equipment	3-29
To Set Up the Equipment	3-29
To Measure 2nd Harmonic Level	3-30
If the Procedure Fails	3-31
Single-Sideband Phase Noise	3-32
Recommended Equipment	3-32
To Set Up the Equipment	3-33

To Set Up the Spectrum Analyzer and Carrier Noise Test Set	3-34
To Calibrate the System	3-34
To Phase Lock the Sources	3-34
To Measure Phase Noise at 100 Hz, 1 kHz, and 10 kHz Offsets	3-34
To Calculate Phase Noise for a Dynamic Signal Analyzer	3-35
To Measure Phase Noise at 100 kHz Offset	3-35
To Calculate Phase Noise for an Analog Spectrum Analyzer	3-36
To Check Single-Sideband Phase Noise at 10 GHz	3-36
Dynamic Signal Analyzer Phase Noise Calculation	3-36
Spectrum Analyzer Phase Noise Calculation:	3-36
To Check Single-Sideband Phase Noise at 18 GHz	3-37
Dynamic Signal Analyzer Phase Noise Calculation	3-37
Spectrum Analyzer Phase Noise Calculation	3-37
To Check Single-Sideband Phase Noise at 500 MHz (HP 83712A/12B, HP 83732A/32B Only)	3-37
Dynamic Signal Analyzer Phase Noise Calculation	3-37
Spectrum Analyzer Phase Noise Calculation	3-37
If the Procedure Fails	3-38
Non-Harmonic Spurious Signals 3 kHz to 30 kHz	3-39
Recommended Equipment	3-39
To Set Up the Equipment for 17.005111 GHz	3-40
To Calibrate the System	3-40
To Phase Lock the Sources	3-40
To Measure Spurious Response at 17.005111 GHz	3-41
To Calculate Actual Spurious Signal Level	3-41
To Set Up and Calibrate the System for 17.501777 GHz	3-42
To Phase Lock the Sources	3-42
To Measure Spurious Response at 17.501777 GHz	3-42
If the Procedure Fails	3-43
Non-Harmonic Spurious Signals >30 kHz	3-44
Recommended Equipment	3-44
To Set Up the Equipment	3-44
To Check for Spurs from 1 to 20 GHz	3-45
To Check Spurs from 0.01 to 1 GHz (HP 83712A/12B, HP 83732A/32B Only)	3-45
If the Procedure Fails	3-46
Pulse On/Off Ratio (HP 83731A/31B and HP 83732A/32B Only)	3-47
Recommended Equipment	3-47
To Set Up the Equipment	3-47
To Measure Pulse Modulation On/Off Ratio	3-48
If the Procedure Fails	3-48
Pulse Rise/Fall Time (HP 83731A/31B and HP 83732A/32B Only)	3-49
Recommended Equipment	3-49
To Set Up the Equipment	3-49
To Measure Rise Time	3-50
To Measure Fall Time	3-51
To Measure Rise/Fall Time for 0.01 to 1 GHz (HP 83732A/32B)	3-51
If the Procedure Fails	3-51
Pulse Width (HP 83731A/31B and HP 83732A/32B Only)	3-52
Recommended Equipment	3-52
To Set Up the Equipment	3-52
To Measure Pulse Width	3-53
To Measure Pulse Width for 0.01 to 1 GHz (HP 83732A/32B)	3-53
If the Procedure Fails	3-54
Maximum FM Deviation (HP 83731A/31B and HP 83732A/32B, Only)	3-55
Recommended Equipment	3-55

To Set Up the Equipment	3-56
To Verify 10 MHz Peak Deviation at 2 GHz	3-57
To Verify 10 MHz Peak Deviation at 10 GHz	3-58
To Verify 5 MHz Peak Deviation at 1 GHz	3-58
If the Procedure Fails	3-58
FM Rate and Flatness (HP 83731A/31B and HP 83732A/32B, Only)	3-59
Recommended Equipment	3-59
To Set Up the Equipment	3-59
To Find the 100 kHz Reference 1st Sideband Nulls	3-60
To Find the 1st Sideband Null for a 1 kHz Rate	3-60
To Find the 1st Sideband Null for a 5 kHz Rate	3-61
To Find the 1st Sideband Null for a 1 MHz Rate	3-61
To Calculate the Relative FM frequency response:	3-62
To Calculate FM Flatness	3-62
If the Procedure Fails	3-63
Phase Modulation (ϕM) Flatness (HP 83731B/32B Option 800 Only)	3-64
Recommended Equipment	3-64
To Set Up the Equipment	3-65
To Find the 1 kHz Reference Carrier Null	3-65
To Find the Carrier Null for a 20 kHz Rate	3-65
To Find the Carrier Null for a 100 kHz Rate	3-65
To Calculate the Relative ϕ M frequency response:	3-66
To Calculate ϕ M Flatness	3-66
If the Procedure Fails	3-67
Minimum Log AM Depth (HP 83731A/31B and HP 83732A/32B, Only)	3-68
Recommended Equipment	3-68
To Set Up the Equipment	3-68
To Measure AM depth	3-69
If the Procedure Fails	3-69
Minimum Linear AM Depth (HP 83731B and HP 83732B, Only)	3-70
Recommended Equipment	3-70
To Set Up the Equipment	3-70
To Measure AM depth	3-71
If the Procedure Fails	3-71
Internal AM Rate (HP 83731A/32A and HP 83731B/32B Option 1E2 Only)	3-72
Recommended Equipment	3-72
To Set Up the Equipment	3-72
To Measure Internal AM Rate	3-73
If the Procedure Fails	3-73
Internal FM Source Verification (HP 83731A/32A and HP 83731B/32B Option 1E2 Only)	3-74
Recommended Equipment	3-74
To Set Up the Equipment	3-74
To Verify the Internal FM Source	3-75
If the Procedure Fails	3-76

4. Performance Test Record	
HP 83711A/11B Test Record	4-2
HP 83712A/12B Test Record	4-14
HP 83731A/31B Test Record	4-34
HP 83732A/32B Test Record	4-50
5. Operation Verification	
6. Adjustments	
Instrument Cover Removal	6-2
Cover Removal	6-2
DIP Switch Settings	6-3
YIG Calibration	6-4
High Stability Timebase Adjustment (Option 1E5 Only)	6-6
Recommended Equipment	6-6
Low Stability Timebase Adjustment	6-7
Recommended Equipment	6-7
0.5 V/GHz Output Adjustment	6-8
Recommended Equipment	6-8
If the Procedure Fails	6-8
FM Sensitivity (HP 83731B/32B)	6-9
Recommended Equipment	6-9
Phase Modulation (ϕ M) Sensitivity (HP 83731B/32B)	6-11
Recommended Equipment	6-11
Phase Cross-Over (HP 83731B/32B)	6-13
Recommended Equipment	6-13
Linear AM Offset (HP 83731B/32B)	6-15
Recommended Equipment	6-15
7. Service Software	
Instrument Cover Removal	7-2
Cover Removal	7-2
DIP switch, A3S1, Settings	7-3
System Requirements and Setup	7-4
Hardware	7-4
Operating System	7-4
Software	7-4
Running the Software	7-5
To Edit the USER_FILE	7-5
1 - 20 GHz Vernier Calibration	7-7
Required Equipment	7-7
To Run the Procedure	7-7
If the Procedure Fails	7-8
1 - 20 GHz Frequency Calibration 1	7-9
Required Equipment	7-9
To Run the Procedure	7-9
1 - 20 GHz Frequency Calibration 2	7-10
Required Equipment	7-10
To Run the Procedure	7-10
1 - 20 GHz Attenuator Calibration	7-11
Recommended Equipment	7-11
To Run the Procedure	7-13
If the Test Fails	7-13
1 - 20 GHz Log AM Linearity Calibration	7-14
Required Equipment	7-14

To Run the Procedure	7-14
If the Procedure Fails	7-15
1 - 20 GHz Log AM Gain Calibration	7-16
Required Equipment	7-16
To Run the Procedure	7-16
If the Procedure Fails	7-17
1 - 20 GHz Linear AM Gain Calibration	7-18
Required Equipment	7-18
To Run the Procedure	7-20
If the Procedure Fails	7-20
0.01 - 1 GHz Vernier Calibration	7-21
Required Equipment	7-21
To Run the Procedure	7-21
If the Procedure Fails	7-22
0.01 - 1 GHz Frequency Calibration 1	7-23
Required Equipment	7-23
To Run the Procedure	7-23
0.01 - 1 GHz Frequency Calibration 2	7-24
Required Equipment	7-24
To Run the Procedure	7-24
0.01 - 1 GHz Attenuator Calibration	7-25
Recommended Equipment	7-25
To Run the Procedure	7-26
If the Test Fails	7-26
0.01 - 1 GHz Log AM Calibration	7-27
Required Equipment	7-27
To Run the Procedure	7-27
If the Procedure Fails	7-28
0.01 - 1 GHz Linear AM Calibration	7-29
Required Equipment	7-29
To Run the Procedure	7-30
If the Procedure Fails	7-30
0.01 - 1 GHz Pulse Calibration	7-31
Required Equipment	7-31
To Run the Procedure	7-31
If the Procedure Fails	7-32
Internal AM/FM Source Calibration (HP 83731A/32A and HP 83731B/32B Option 1E2 Only)	7-33
Required Equipment	7-33
To Run the Procedure	7-33
Internal Linear AM Source Calibration (HP 83731B/32B Option 1E2 Only)	7-34
Required Equipment	7-34
To Run the Procedure	7-34
8. Maintenance and Service	
Cleaning the Product	8-2
Returning Instruments for Service	8-2
Service Tag	8-2
Original Packaging	8-2
Other Packaging	8-2
Sales and Service Offices	8-3

9. Legal and Regulatory Information

Safety Symbols	9-2
Miscellaneous Symbols	9-2
Safety Considerations	9-3
Before Applying Power	9-3
Safety Earth Ground	9-3
Cleaning the Product	9-4
Certification	9-5
Warranty	9-5
Limitation of Warranty	9-5
Exclusive Remedies	9-5
Assistance	9-6

Index

Figures

1-1. Typical Maximum Available Output Power from 1 to 20 GHz, at 25°C with Output Step Attenuator (Option 1E1) Installed	1-3
1-2. Typical Output Level Accuracy and Flatness at +10 and -85 dBm	1-4
1-3. Typical single-sideband phase noise at 1 GHz, 10 GHz and 20 GHz, 25°C, CW mode. Offsets less than 100 Hz require the high stability timebase, Option 1E5.	1-5
1-4. Typical 2nd Harmonic Levels Measured at Output Power of +6 dBm	1-5
1-5. Typical Residual FM Measured in 50 Hz - 15 kHz Bandwidth, CW Mode, with High Stability Timebase (Option 1E5)	1-6
1-6. Typical Maximum Available Output Power from 1 to 20 GHz, at 25°C with Output Step Attenuator (Option 1E1) Installed	1-7
1-7. Typical Maximum Available Output Power from 0.01 to 1 GHz at 25°C	1-8
1-8. Typical Output Level Accuracy and Flatness at +10 and -85 dBm	1-9
1-9. Typical single-sideband phase noise at 50 MHz, 1 GHz, 10 GHz and 20 GHz, 25°C, CW mode. Offsets less than 100 Hz require the high stability timebase, Option 1E5.	1-10
1-10. Typical 2nd Harmonic Levels Measured at Output Power of +6 dBm	1-10
1-11. Typical Residual FM Measured in 50 Hz—15 kHz Bandwidth, CW Mode, with High Stability Timebase (Option 1E5)	1-11
1-12. Typical Maximum Available Output Power from 1 to 20 GHz, at 25°C with Output Step Attenuator (Option 1E1) Installed.	1-13
1-13. Typical Maximum Available Output Power from 0.01 to 1 GHz at 25°C	1-13
1-14. Typical Output Level Accuracy and Flatness at +10 and -85 dBm	1-14
1-15. Typical single-sideband phase noise at 50 MHz, 1 GHz and 20 GHz, 25°C, CW mode. Offsets less than 100 Hz require the high stability timebase, Option 1E5.	1-15
1-16. Typical 2nd Harmonic Levels Measured at Output Power of +6 dBm	1-16
1-17. Typical Residual FM Measured in 50 Hz—15 kHz Bandwidth, CW Mode, with High Stability Timebase (Option 1E5)	1-16
1-18. Typical Pulse Modulation On/Off Ratio at +8 dBm	1-17
1-19. Typical Pulse Modulation Envelope Illustrates the Fast Rise and Fall Times, Excellent Flatness and Pulse Fidelity	1-18
1-20. Typical Log AM Error (deviation from desired depth) at 25°C for Carrier Frequencies between 1.0 and 20 GHz	1-20
1-21. Typical Maximum Available Output Power from 1 to 20 GHz, at 25 °C with Output Step Attenuator (Option 1E1) Installed	1-22
1-22. Typical Maximum Available Output Power from 0.01 to 1 GHz at 25 °C	1-22
1-23. Typical Output Level Accuracy and Flatness at +10 and -85 dBm	1-23
1-24. Typical single-sideband phase noise at 50 MHz, 1 GHz, 10 GHz, and 20 GHz, 25 °C, CW mode. Offsets less than 100 Hz require the high stability timebase, Option 1E5.	1-24
1-25. Typical 2nd Harmonic Levels Measured at Output Power of +6 dBm	1-25
1-26. Typical Residual FM Measured in 50 Hz - 15 kHz Bandwidth, CW Mode, with High Stability Timebase (Option 1E5)	1-25
1-27. Typical Pulse Modulation On/Off Ratio at +8 dBm	1-26

1-28. Typical Pulse Modulation Envelope Illustrates the Fast Rise and Fall Times, Excellent Flatness and Pulse Fidelity	1-27
1-29. Typical Log AM Error (deviation from desired depth) at 25 °C for Carrier Frequencies between 1.0 and 20 GHz	1-30
3-1. Internal Timebase Aging Rate Test Equipment Setup	3-4
3-2. Frequency Range and Resolution Test Setup	3-6
3-3. External Leveling Test Setup	3-8
3-4. Maximum Power Test Setup	3-11
3-5. Vernier Level Accuracy and Flatness Test Setup	3-15
3-6. Low Level Accuracy Test Setup using Power Meter	3-18
3-7. 10 MHz to 1 GHz Low Level Accuracy Test Setup using Measuring Receiver	3-20
3-8. 1 GHz to 18 GHz Low Level Accuracy Test Setup using Measuring Receiver	3-23
3-9. Harmonics Test Setup	3-29
3-10. Single-Sideband Phase Noise Test Setup	3-33
3-11. Non-Harmonic Spurious Level <30 kHz Test Setup	3-39
3-12. Non-Harmonic Spurious Level >30 kHz Test Setup	3-44
3-13. Pulse On/Off Ratio Test Setup	3-47
3-14. Pulse Rise/Fall Time Test Setup	3-49
3-15. Pulse Rise Time Measurement	3-50
3-16. Pulse Fall Time Measurement	3-51
3-17. Pulse Width Test Setup	3-52
3-18. Pulse Width Measurement	3-53
3-19. Maximum FM Deviation Test Setup	3-55
3-20. Example Signal Spectrum that Passes Test	3-56
3-21. Example Signal Spectrum that Fails Test	3-57
3-22. FM Rate and Flatness Test Setup	3-59
3-23. ϕ M Flatness Test Setup	3-64
3-24. Minimum AM Depth Test Setup	3-68
3-25. Minimum Linear AM Depth Test Setup	3-70
3-26. Internal AM Rate Test Setup	3-72
3-27. Internal FM Source Verification Test Setup	3-74
3-28. Example Signal Spectrum that Passes Test	3-75
3-29. Example Signal Spectrum that Fails Test	3-76
6-1. DIP Switch, A3S1, Settings	6-3
6-2. High Stability Timebase Adjustment Equipment Setup	6-6
6-3. Low Stability Timebase Equipment Setup	6-7
6-4. 0.5 V/GHz Output Equipment Setup	6-8
6-5. FM Sensitivity Equipment Setup	6-9
6-6. ϕ M Sensitivity Equipment Setup	6-11
6-7. Phase Cross-Over Equipment Setup	6-13
6-8. Linear AM Offset Equipment Setup	6-15
7-1. DIP Switch, A3S1, Settings	7-3
7-2. 1–20 GHz Vernier Calibration Equipment Setup	7-7
7-3. 1–20 GHz Frequency Calibration Equipment Setup	7-9
7-4. 1–20 GHz Frequency Calibration 2 Equipment Setup	7-10
7-5. 1–20 GHz Attenuator Calibration Equipment Setup	7-12
7-6. 1–20 GHz AM Linearity Calibration Equipment Setup	7-14
7-7. 1–20 GHz Log AM Gain Calibration Equipment Setup	7-16
7-8. 1–20 GHz Linear AM Calibration Equipment Setup	7-19
7-9. 0.01–1 GHz Vernier Calibration Equipment Setup	7-21
7-10. 0.01–1 GHz Frequency Calibration 1 Equipment Setup	7-23
7-11. 0.01–1 GHz Frequency Calibration 2 Equipment Setup	7-24
7-12. 0.01–1 GHz Attenuator Calibration Equipment Setup	7-25
7-13. 0.01–1 GHz AM Calibration Equipment Setup	7-27
7-14. 0.01–1 GHz Linear AM Calibration Equipment Setup	7-29

7-15. 0.01–1 GHz Pulse Calibration Equipment Setup	7-31
7-16. Internal AM/FM Source Calibration Equipment Setup	7-33
7-17. Internal Linear AM Source Calibration Equipment Setup	7-34

Tables

1-1. Offsets (HP 83711A only)	1-4
1-2. Offsets (HP 83711B only)	1-4
1-3. Offsets (HP 83712A only)	1-9
1-4. Offsets (HP 83712B only)	1-9
1-5. Offsets	1-15
1-6. Offsets	1-24
1-7. Maximum Deviation (with sine-wave modulation only)	1-29
1-8. Modulation Index	1-29
1-9. Hardware Resolution	1-32
1-10. ϕ M Hardware Resolution (Low Range)	1-33
1-11. ϕ M Hardware Resolution (High Range)	1-33
2-1. Required Test Equipment	2-2
3-1. HP 83711A/11B	3-10
3-2. HP 83712A/12B	3-10
3-3. HP 83731A/31B	3-10
3-4. HP 83732A/32B	3-10
3-5. Offsets for HP 83711A/31A	3-32
3-6. Offsets for HP 83711B/31B	3-32
3-7. Offsets for HP 83712A/32A	3-32
3-8. Offsets for HP 83712B/32B	3-32
3-9. HP 83731A/31B, HP 83732A/32B	3-47
3-10. HP 83731A/31B	3-49
3-11. HP 83732A/32B	3-49
3-12. HP 83731A/31B	3-52
3-13. HP 83732A/32B	3-52
3-14. HP 83731A/31B	3-55
3-15. HP 83732A/32B	3-55
8-1. Hewlett-Packard Sales and Service Offices	8-3



Specifications

This chapter contains the specifications, supplemental characteristics, and electrical options for each of the synthesizers covered in this book. Refer to the User's Guide for your particular instrument for mechanical, documentation, and warranty options.

Specifications for each instrument appear under the instrument number.

HP 83711A/11B Specifications

Specifications describe the instrument's warranted performance over the 0° to 55°C temperature range unless otherwise noted. Supplemental characteristics, *indicated by italics*, are intended to provide information useful in estimating instrument capability in your application by describing typical, but not warranted, performance.

Frequency

Range: 1.0 to 20.0 GHz

Resolution: 1 kHz (1 Hz with Option 1E8)

Stability (with high stability timebase, Option 1E5):

Aging Rate: $<1.5 \times 10^{-9}$ /day after 24-hour warm up.

Temperature Effects: $<1 \times 10^{-7}$ over 0 to 55°C, nominally $<1.4 \times 10^{-9}/^{\circ}\text{C}$

Line Voltage Effects: $<5 \times 10^{-10}$ for 10% change in line voltage

Stability (without high stability timebase):

Aging Rate: $<1.0 \times 10^{-8}$ /day after 72-hours at 25°C ± 10°C

Temperature Effects: $<5 \times 10^{-6}$ over 0 to 55°C referenced to 25°C

Stability (with external 10 MHz reference):

Same as external reference.

Frequency Switching Time: <50 ms to within 1 kHz

For <1 GHz steps, not across 10 GHz band switch point: <35 ms (HP 83711B only)

RF Output

Maximum Levelled Output Power (0°C to +35°C):

Frequency	Standard	with Option 1E1
1–20 GHz	+11 dBm	+10 dBm

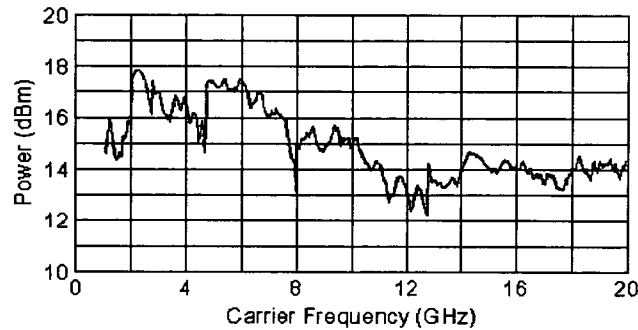

Figure 1-1.

Typical Maximum Available Output Power from 1 to 20 GHz, at 25°C with Output Step Attenuator (Option 1E1) Installed

Minimum Levelled Output Power (without Option 1E1):

0 dBm

Minimum Levelled Output Power (with Option 1E1):

–110 dBm (–90 dBm on HP 83711A)

Display Resolution:

0.01 dB

Accuracy:

±1.0 dB (over all power levels)

(0 dBm to specified maximum levelled output power)

±2.0 dB (power ≥ –90 dBm)

±2.5 dB (power < –90 dBm)

The use of Type-N RF connectors above 18.0 GHz degrades specification typically by 0.2 dB.

Flatness:

±0.5 dB (power ≥ –90 dBm)

±0.7 dB (power < –90 dBm)

The use of Type-N RF connectors above 18.0 GHz degrades specification typically by 0.2 dB.

Level Switching Time: <17 ms (without step attenuator range change).

Attenuator Range Changes Occur At:

HP 83711B, HP 83712B –1 dBm, –11 dBm, –21 dBm, etc.)

Output SWR: <2.0: 1 nominal

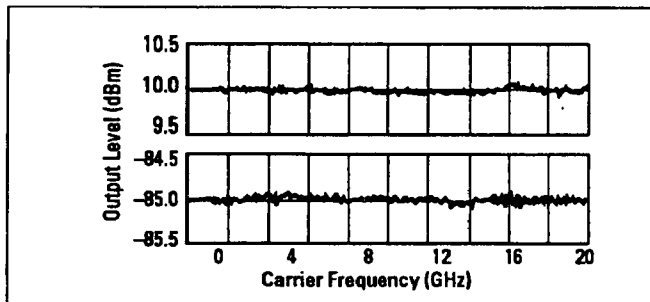

Figure 1-2. Typical Output Level Accuracy and Flatness at +10 and -85 dBm

Spectral Purity

SSB Phase Noise (dBc/Hz):

Table 1-1. Offsets (HP 83711A only)

Carrier Freq.	100 Hz	1 kHz	10 kHz	100 kHz
2 GHz	-66	-74	-91	-107
10 GHz	-69	-75	-79	-101
18 GHz	-63	-70	-73	-99

Table 1-2. Offsets (HP 83711B only)

Carrier Freq.	100 Hz	1 kHz	10 kHz	100 kHz
1 GHz to <2 GHz	-73	-83	-92	-107
2 GHz to <5 GHz	-70	-78	-83	-100
5 GHz to <10 GHz	-69	-78	-82	-100
10 GHz to 20 GHz	-65	-73	-76	-100

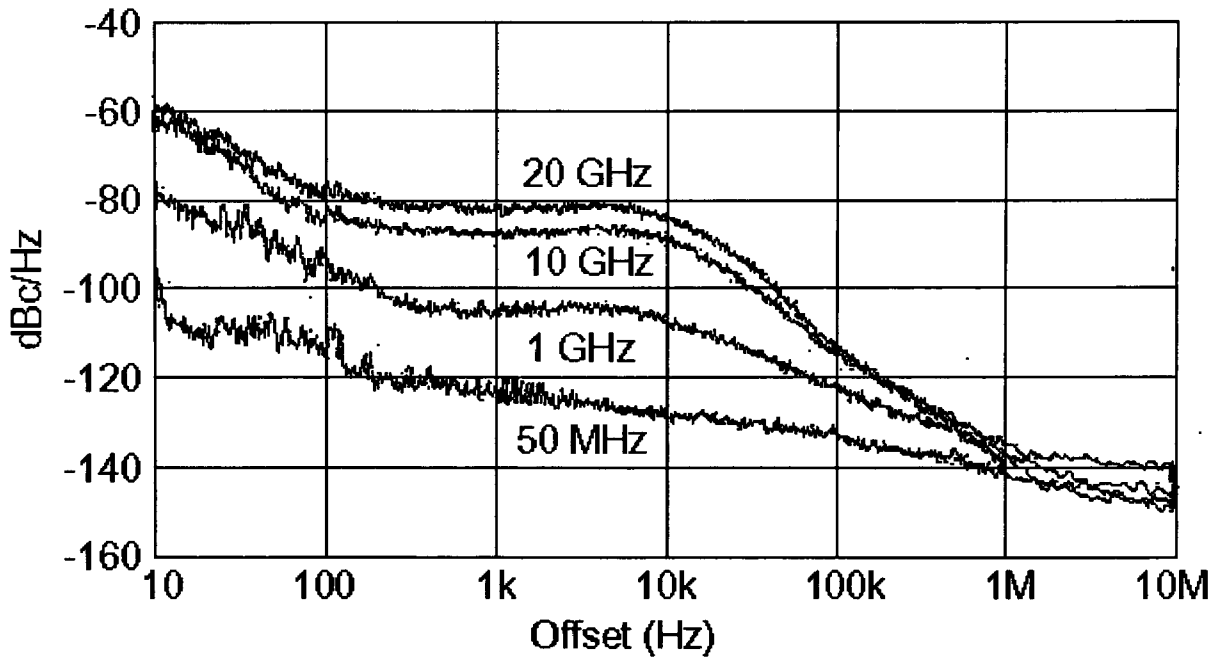

Figure 1-3.

Typical single-sideband phase noise at 1 GHz, 10 GHz and 20 GHz, 25°C, CW mode. Offsets less than 100 Hz require the high stability timebase, Option 1E5.

Harmonics: <-50 dBc at output levels <+6 dBm, 1 to 20 GHz

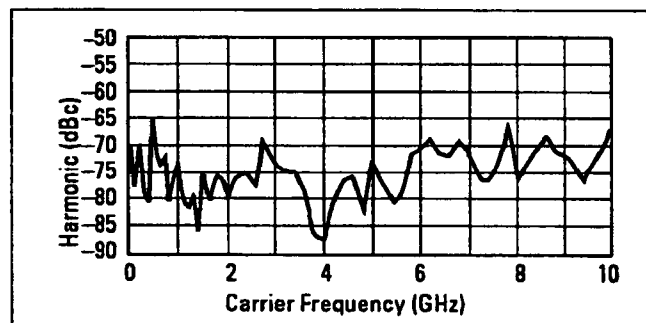

Figure 1-4. Typical 2nd Harmonic Levels Measured at Output Power of +6 dBm

Non-Harmonic Spurious (≥ 3 kHz): <-60 dBc (includes power supply and frequency synthesis spurious).

Non-Harmonic Spurious (<3 kHz): < -50 dBc

Sub-Harmonics: None

Residual FM:

At 1 GHz, <15 Hz in 50 Hz–15 kHz bandwidth.

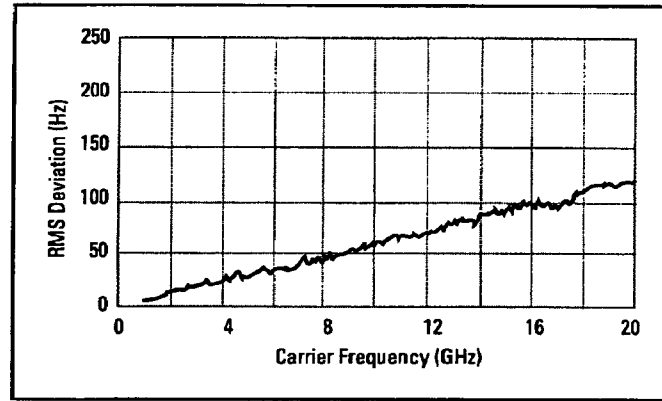

Figure 1-5.
Typical Residual FM Measured in 50 Hz - 15 kHz Bandwidth, CW Mode, with High Stability Timebase (Option 1E5)

AM Noise Floor: (at 0 dBm and offsets greater than 5 MHz from carrier) <-150 dBm/Hz

HP 83712A/12B Specifications

Specifications describe the instrument's warranted performance over the 0° to 55° temperature range unless otherwise noted. Supplemental characteristics, *indicated by italics*, are intended to provide information useful in estimating instrument capability in your application by describing typical, but not warranted, performance.

Frequency

Range: 0.01 to 20.0 GHz

Resolution: 1 kHz (1 Hz with Option 1E8)

Stability (with high stability timebase, Option 1E5):

Aging Rate: $<1.5 \times 10^{-9}$ /day after 24-hour warm up.

Temperature Effects: $<1 \times 10^{-7}$ over 0 to 55°C, nominally $<1.4 \times 10^{-9}/^{\circ}\text{C}$

Line Voltage Effects: $<5 \times 10^{-10}$ for 10% change in line voltage

Stability (without high stability timebase):

Aging Rate: $<1.0 \times 10^{-8}$ /day after 72-hours at 25°C ± 10°C

Temperature Effects: $<5 \times 10^{-6}$ over 0 to 55°C referenced to 25°C

Stability (with external 10 MHz reference):

Same as external reference.

Frequency Switching Time: <50 ms to within 1 kHz

For <1 GHz steps, not across 10 GHz band switch point: <35 ms (HP 83712B only)

RF Output

Maximum Levelled Output Power (0°C to +35°C):

Frequency	Standard	with Option 1E1
0.01–1 GHz	+13 dBm	+13 dBm
1–20 GHz	+11 dBm	+10 dBm

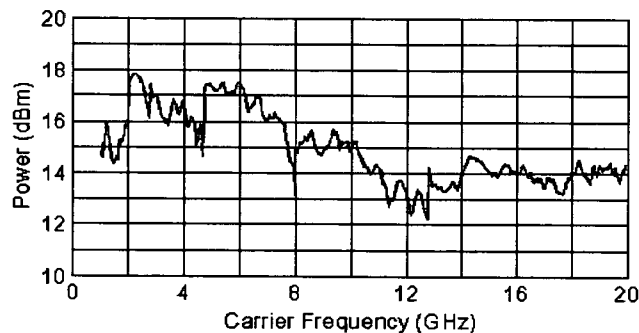

Figure 1-6.

Typical Maximum Available Output Power from 1 to 20 GHz, at 25°C with Output Step Attenuator (Option 1E1) Installed

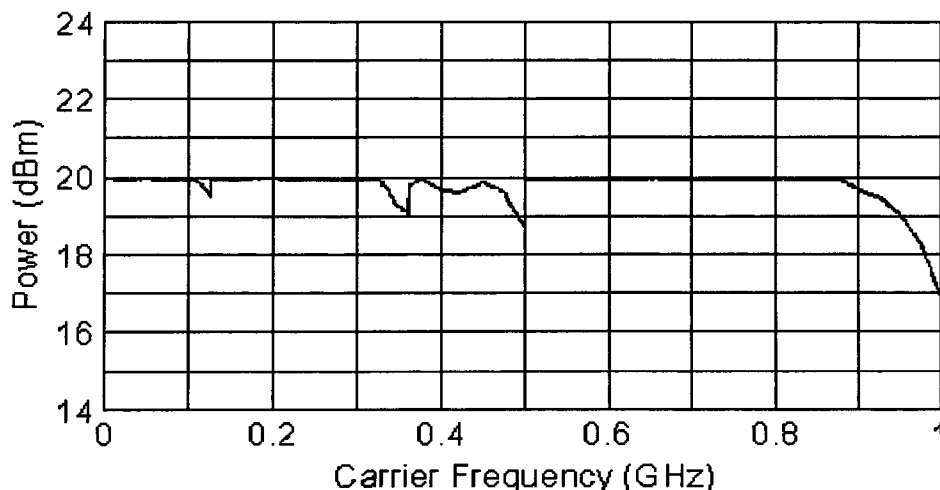

Figure 1-7. Typical Maximum Available Output Power from 0.01 to 1 GHz at 25°C

Minimum Leveled Output Power (without Option 1E1): 0 dBm

Minimum Leveled Output Power (with Option 1E1): -110 dBm (-90 dBm for HP 83712A)

Display Resolution: 0.01 dB

Accuracy: (0 dBm to specified maximum leveled output power)

10 MHz to 50 MHz: ± 1.3 dB

50 MHz to 20 GHz: ± 1.0 dB

Accuracy: (over all power levels)

10 MHz to 50 MHz: ± 2.3 dB (power ≥ -90 dBm)

50 MHz to 20 GHz: ± 2.0 dB (power ≥ -90 dBm)

10 MHz to 20 GHz: ± 2.5 dB (power < -90 dBm)

The use of Type-N RF connectors above 18.0 GHz degrades specification typically by 0.2 dB.

Flatness:

± 0.5 dB (power ≥ -90 dBm)

± 0.7 dB (power < -90 dBm)

The use of Type-N RF connectors above 18.0 GHz degrades specification typically by 0.2 dB.

*Level Switching Time: <17 ms (without step attenuator range change.
Attenuator range changes occur at -1 dBm, -11 dBm, -21 dBm, etc.)
Output SWR: <2.0: 1 nominal*

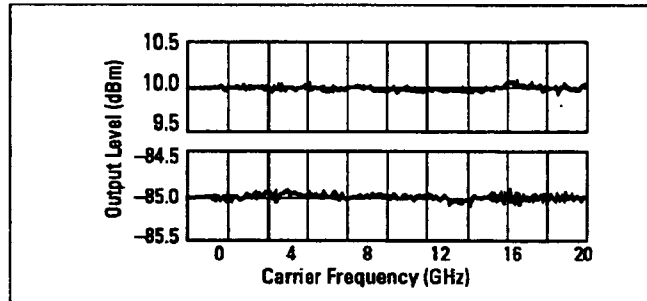

Figure 1-8. Typical Output Level Accuracy and Flatness at +10 and -85 dBm

Spectral Purity

SSB Phase Noise (dBc/Hz):

Table 1-3. Offsets (HP 83712A only)

Carrier Freq.	100 Hz	1 kHz	10 kHz	100 kHz
500 MHz	-70	-86	-103	-119
2 GHz	-66	-74	-91	-107
10 GHz	-69	-75	-79	-101
18 GHz	-69	-70	-73	-99

Table 1-4. Offsets (HP 83712B only)

Carrier Freq.	100 Hz	1 kHz	10 kHz	100 kHz
500 MHz to <1 GHz	-78	-92	-103	-115
1 GHz to <2 GHz	-73	-83	-92	-107
2 GHz to <5 GHz	-70	-78	-83	-100
5 GHz to <10 GHz	-69	-78	-82	-100
10 GHz to 20 GHz	-65	-73	-76	-100

Phase noise decreases 6 dB/octave below 500 MHz and reaches a floor of -140 dBc/Hz.

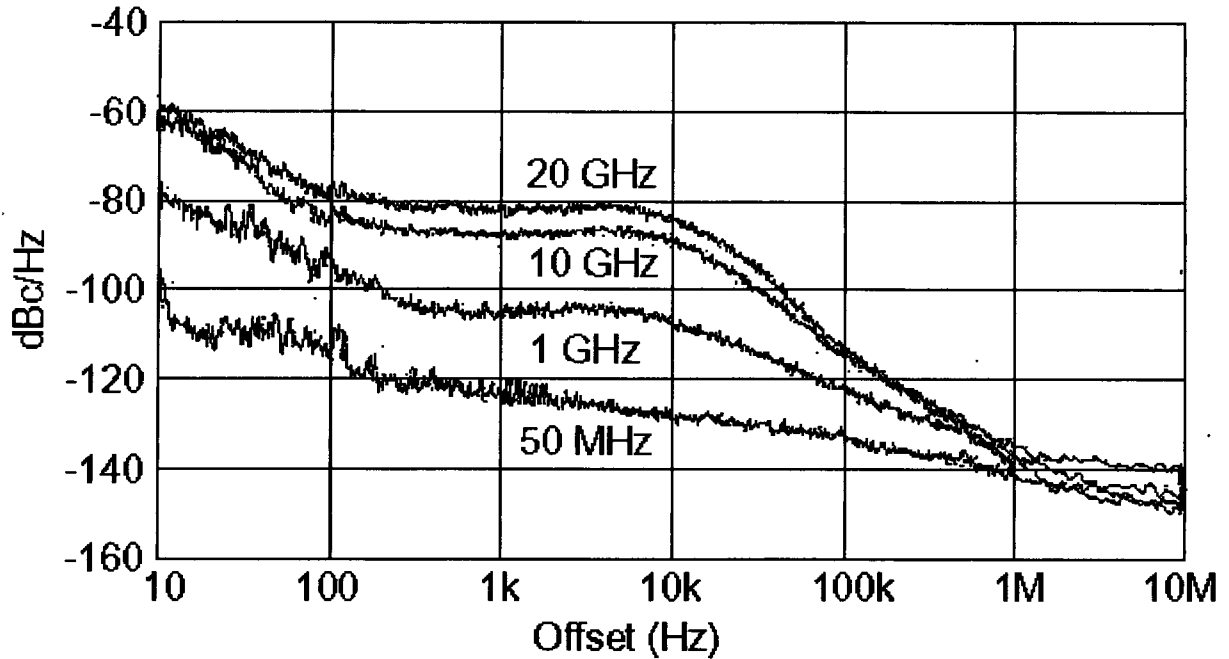

Figure 1-9.

Typical single-sideband phase noise at 50 MHz, 1 GHz, 10 GHz and 20 GHz, 25°C, CW mode. Offsets less than 100 Hz require the high stability timebase, Option 1E5.

Harmonics: <-55 dBc at output levels <+6 dBm, 0.01 to 1 GHz

Harmonics: <-50 dBc at output levels <+6 dBm, 1 to 20 GHz

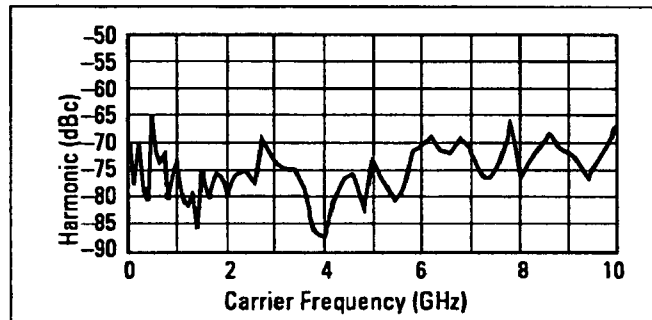

Figure 1-10. Typical 2nd Harmonic Levels Measured at Output Power of +6 dBm

Non-Harmonic Spurious (≥ 3 kHz):

<-60 dBc (includes power supply and frequency synthesis spurious).

Non-Harmonic Spurious (<3 kHz):

< -50 dBc

Sub-Harmonics: None

Residual FM:

At 1 GHz, <15 Hz in 50 Hz–15 kHz bandwidth. Residual FM decreases 6 dB per octave below 1 GHz.

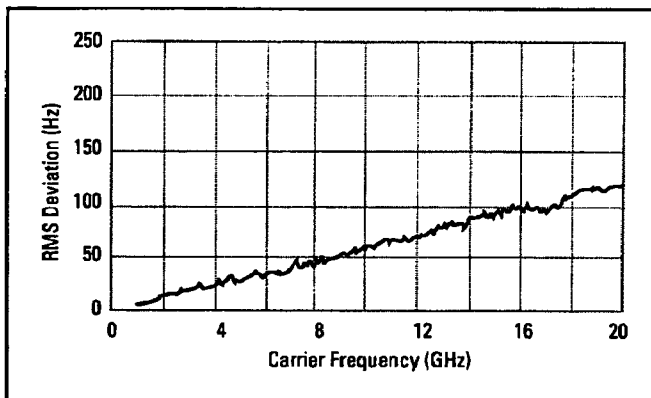

Figure 1-11.
Typical Residual FM Measured in 50 Hz–15 kHz Bandwidth, CW Mode, with High Stability Timebase (Option 1E5)

*AM Noise Floor: (at 0 dBm and offsets greater than 5 MHz from carrier) <-150 dBm/Hz, 1–20 GHz.
< -140 dBm/Hz, 0.01–1 GHz.*

HP 83731A/32A Specifications

Specifications describe the instrument's warranted performance over the 0° to 55°C temperature range unless otherwise noted. Supplemental characteristics (indicated by italics) are intended to provide information useful in estimating instrument capability in your application by describing typical, but not warranted, performance.

Frequency

Range: HP 83731A, 1.0 to 20.0 GHz;

HP 83732A, 0.01 to 20 GHz

Resolution: 1 kHz (1 Hz with Option 1E8)

Stability (with high stability timebase, Option 1E5):

Aging Rate: $<1.5 \times 10^{-9}$ /day after 24-hour warm up.

Temperature Effects: $<1 \times 10^{-7}$ over 0 to 55°C, nominally $<1.4 \times 10^{-9}/^{\circ}\text{C}$

Line Voltage Effects: $<5 \times 10^{-10}$ for 10% change in line voltage

Stability (without high stability timebase):

Aging Rate: $<1.0 \times 10^{-8}$ /day after 72-hours at 25°C $\pm 10^{\circ}\text{C}$

Temperature Effects: $<5 \times 10^{-6}$ over 0 to 55°C referenced to 25°C

Stability (with external 10 MHz reference):

Same as external reference.

Frequency Switching Time: <50 ms to within 1 kHz.

For <1 GHz steps, not across 10 GHz band-switch point: <35 ms

RF Output

Maximum Leveled Output Power:

Frequency	Standard	with Option 1E1
0.01–1 GHz	+13 dBm	+13 dBm
1–18 GHz	+11 dBm	+10 dBm
18–20 GHz	+10 dBm	+8 dBm

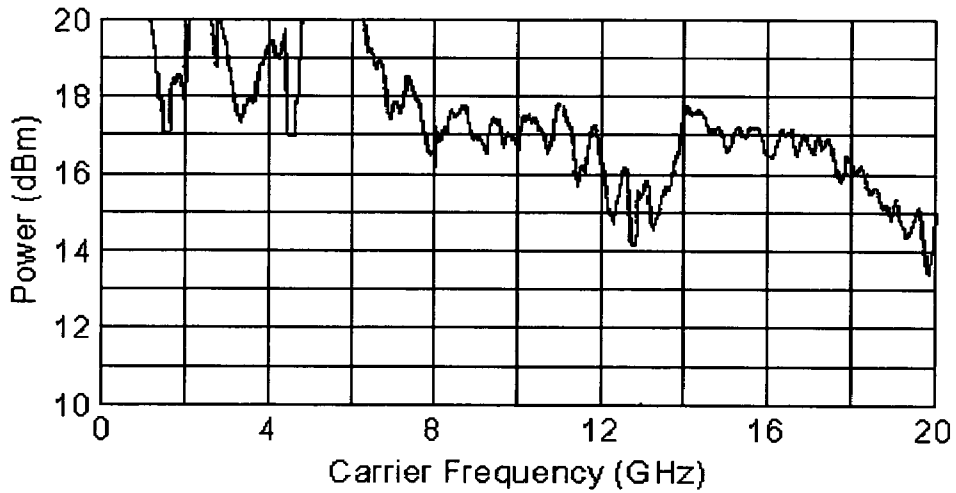

Figure 1-12.

Typical Maximum Available Output Power from 1 to 20 GHz, at 25°C with Output Step Attenuator (Option 1E1) Installed.

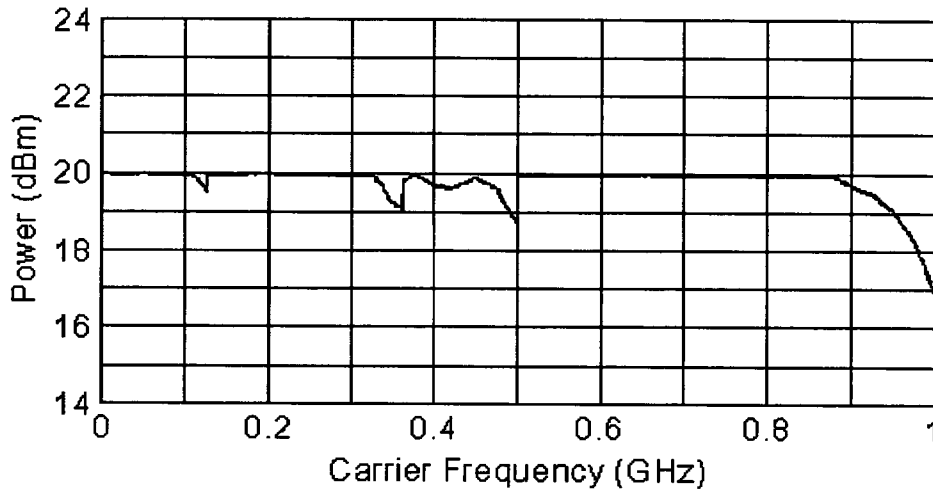

Figure 1-13. Typical Maximum Available Output Power from 0.01 to 1 GHz at 25°C

Minimum Leveled Output Power (without Option 1E1): -4 dBm

Minimum Leveled Output Power (with Option 1E1): -90 dBm

Display Resolution: 0.01 dB

Accuracy: ± 1.0 dB, 50 MHz to 20 GHz; ± 1.3 dB, 10 MHz to 50 MHz (-4 dBm to specified maximum leveled output power).

Accuracy (over all specified temperatures, frequencies and power levels)

10 MHz to 50 MHz: ± 2.3 dB

50 MHz to 20 GHz: ± 2.0 dB

The use of Type-N RF connectors above 18.0 GHz degrades specification typically by 0.2 dB.

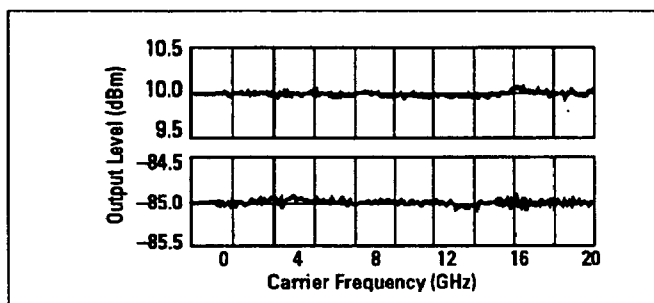

Figure 1-14. Typical Output Level Accuracy and Flatness at +10 and -85 dBm

Flatness: ± 0.5 dB. The use of Type-N RF connectors above 18.0 GHz degrades specification typically by 0.2 dB.

Level Switching Time: Typically < 15 ms (without step attenuator range change.

Attenuator range changes occur at: -4 dBm, -14 dBm, -24 dBm, etc.)

Output SWR: $< 2.0 : 1$ nominal

Spectral Purity

SSB Phase Noise (dBc/Hz):

Table 1-5. Offsets

Carrier Freq.	100 Hz	1 kHz	10 kHz	100 kHz
500 MHz	-70	-86	-103	-119
2 GHz	-66	-74	-91	-107
10 GHz	-69	-75	-79	-101
18 GHz	-63	-70	-73	-99

Phase noise decreases 6 dB/octave below 500 MHz and reaches a floor of < -140 dBc/Hz.

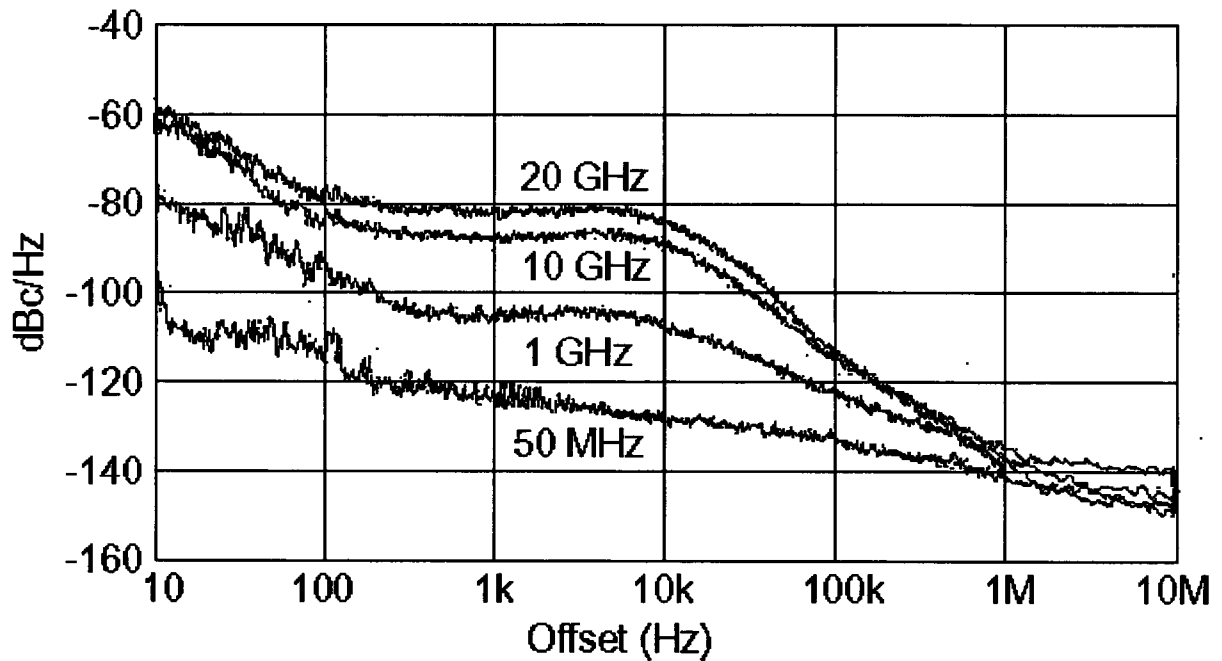

Figure 1-15.

Typical single-sideband phase noise at 50 MHz, 1 GHz and 20 GHz, 25°C, CW mode.
Offsets less than 100 Hz require the high stability timebase, Option 1E5.

Harmonics: < -55 dBc at output levels $< +6$ dBm, 0.01 to 20 GHz

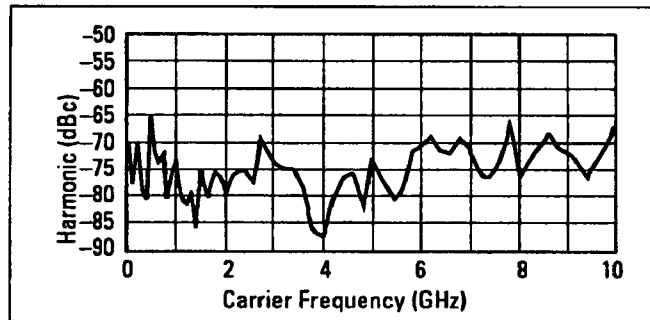

Figure 1-16. Typical 2nd Harmonic Levels Measured at Output Power of +6 dBm

Non-Harmonic Spurious (≥ 3 kHz): < -60 dBc (includes power supply and frequency synthesis spurious).

Non-Harmonic Spurious (< 3 kHz): < -50 dBc

Sub-Harmonics: None

Residual FM:

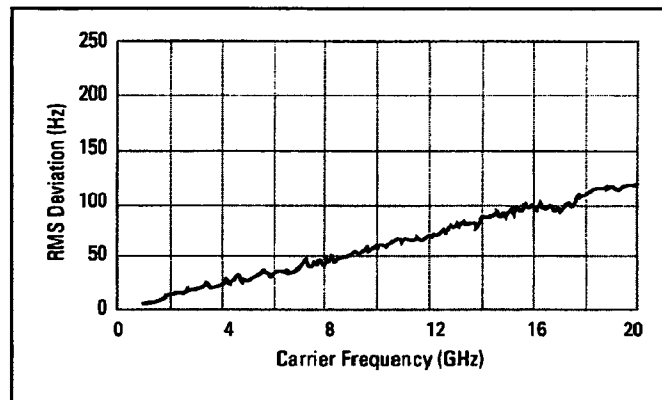

Figure 1-17.

Typical Residual FM Measured in 50 Hz—15 kHz Bandwidth, CW Mode, with High Stability Timebase (Option 1E5)

At 1 GHz, < 15 Hz in 50 Hz to 15 kHz bandwidth. Residual FM decreases 6 dB per octave below 1 GHz.

AM Noise Floor: (at 0 dBm and offsets greater than 5 MHz from carrier) < -150 dBm/Hz, 1 GHz to 20 GHz.

< -140 dBm/Hz, 0.01 GHz to 1 GHz.

Modulation

Carrier Freq.	<25 MHz	25 - <64 MHz	64 - <128 MHz	128 - <500 MHz	500 - <1000 MHz	1 - 20 GHz
Minimum Pulse Width	<1 μ s		<100 ns		<25 ns <i>Typically <10 ns</i>	
Rise/Fall Time	<500 ns	<350 ns	<50 ns	<35 ns	<20 ns	<10 ns
Video Feedthrough	<2 mV peak-to-peak at 0 dBm					<20 mV peak-to-peak at 0 dBm
Pulse Width Compression	± 150 ns		± 15 ns		± 5 ns	
Pulse Delay (Video out to RF out)	<1 μ s		<200 ns		<125 ns	<100 ns

CW power will be present for up to 10 ms when changing frequency or power level.

Pulse Modulation

On/Off Ratio: > 80 dB

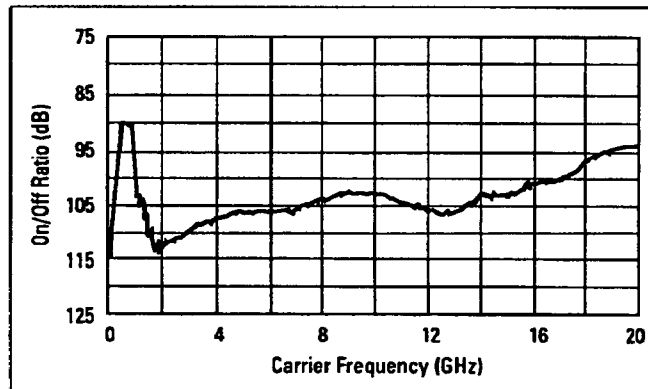

Figure 1-18. Typical Pulse Modulation On/Off Ratio at +8 dBm

Maximum Pulse Repetition Frequency: > 3 MHz

Minimum Pulse Duty Cycle: No restrictions on duty cycle.

Pulse Level Accuracy: ± 1.0 dB (relative to CW)

Pulse Overshoot: < 10%

Input Impedance: 50 Ω nominal; TTL drive levels

Maximum Leveled Output Power in Pulse Mode: -0.5 dB relative to CW

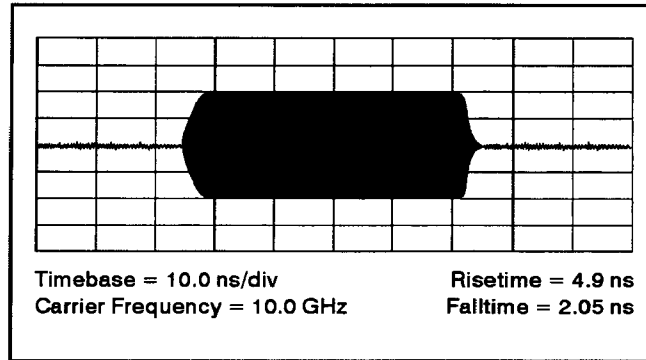

pk619ab

Figure 1-19.
Typical Pulse Modulation Envelope Illustrates the Fast Rise and Fall Times, Excellent Flatness and Pulse Fidelity

Internal Pulse Source

Pulse Source Modes: Free-run, triggered with delay, doublet and gated. Triggered with delay, doublet and gated require external trigger source.

Pulse Repetition Frequency: 3 Hz to >3 MHz

Pulse Repetition Interval (PRI): 300 ns to 419 ms

Pulse Width (T_w): 25 ns to 419 ms

Variable Pulse Delay (free-run mode, T_d): ± 419 ms from sync pulse to video modulation

Variable Pulse Delay (triggered with delay & doublet modes, T_d): 225 ns to 419 ms with ± 25 ns jitter

Pulse Width/Delay/PRI Resolution: 25 ns

Pulse Delay (Video to RF, T_m): Nominally, <20 ns, 1 to 20 GHz

All pulse modulation specifications and supplemental characteristics apply during use of internal pulse source.

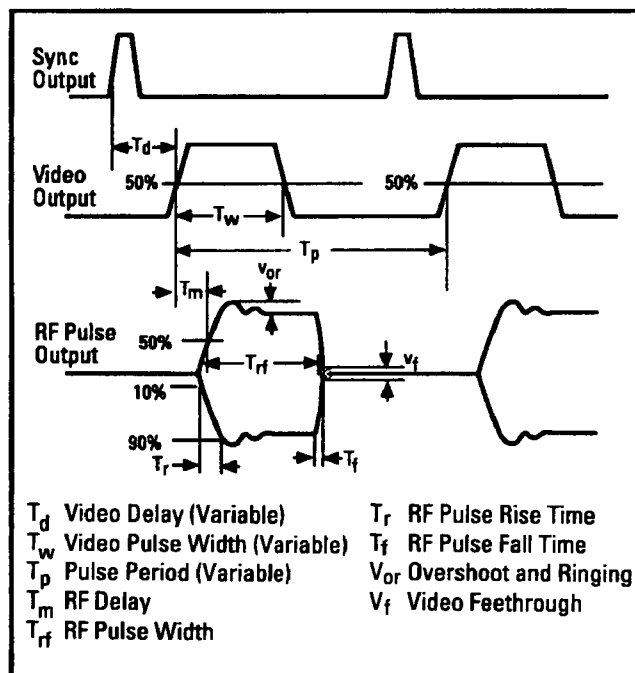

Frequency Modulation

Rates: 1 kHz to 1 MHz

Flatness: ± 2 dB

Maximum Deviation (with sine-wave modulation only): 10 MHz peak, 2 - 20 GHz.

5 MHz peak, 1 - 2 GHz. 2.5 MHz peak, 500 MHz - 1 GHz. 1.25 MHz

peak, 256 - 500 MHz. Maximum deviation decreases by a factor of 2 for each octave below 256 MHz.

Modulation Index: > 300 , 2 - 20 GHz. > 150 , 1 - 2 GHz. > 75 , 500 MHz - 1 GHz. > 37 , 256 - 500 MHz. Modulation index decreases by a factor of 2 for each octave below 256 MHz.

FM Sensitivity Accuracy: $\pm 25\%$ typical at 100 kHz

Incidental AM: $< 5\%$

FM Input Impedance: 600 Ω nominal

Harmonic Distortion: $< 1\%$ (1 MHz peak deviation @ 100 kHz rate)

Logarithmic Amplitude Modulation (Scan Modulation)

Maximum Depth: > 60 dB

Sensitivity: -10 dB/V; (0 to +6 V for 0 to -60 dBc)

Step Response (50 dB change in level): rise and fall $< 5 \mu s$, 1 GHz to 20 GHz. Rise $< 10 \mu s$, < 1 GHz. Fall $< 20 \mu s$, < 1 GHz

Input Impedance: 5000 Ω nominal

Maximum Levelled Output Power in Log AM Mode (relative to CW):

< 1 GHz	1 - 4 GHz	> 4 GHz
0 dB	-4.5 dB	-1.0 dB

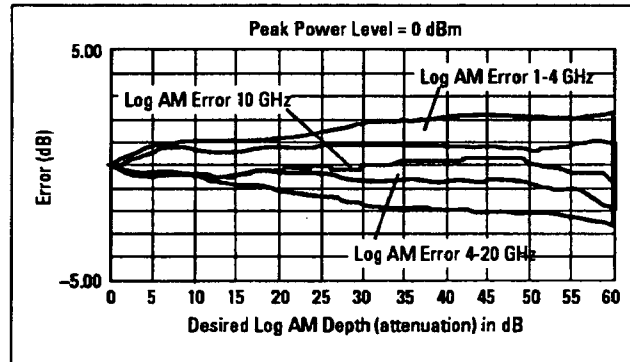

Figure 1-20.
Typical Log AM Error (deviation from desired depth) at 25°C for Carrier Frequencies between 1.0 and 20 GHz

Simultaneous Modulations

Full AM bandwidth and depth is available at any pulse rate or width. FM is completely independent of AM and pulse modulation.

HP 83731B/32B Specifications

Specifications describe the instrument's warranted performance over the 0° to 55°C temperature range unless otherwise noted. Supplemental characteristics (indicated by italics) are intended to provide information useful in estimating instrument capability in your application by describing typical, but not warranted, performance.

Frequency

Range: HP 83731B, 1.0 to 20.0 GHz;
HP 83732B, 0.01 to 20 GHz

Resolution: 1 kHz (1 Hz with Option 1E8)

Stability (with high stability timebase, Option 1E5):

Aging Rate: $<1.5 \times 10^{-9}$ /day after 24-hour warm up.

Temperature Effects: $<1 \times 10^{-7}$ over 0 to 55 °C, nominally $<1.4 \times 10^{-9}/^{\circ}\text{C}$

Line Voltage Effects: $<5 \times 10^{-10}$ for 10% change in line voltage

Stability (without high stability timebase):

Aging Rate: $<1.0 \times 10^{-8}$ /day after 72-hours at 25 °C ± 10 °C

Temperature Effects: $<5 \times 10^{-6}$ over 0 to 55 °C referenced to 25 °C

Stability (with external 10 MHz reference):

Same as external reference.

Frequency Switching Time: <50 ms to within 1 kHz for any frequency step. For <1 GHz steps, not across 10 GHz band-switch point: <35 ms

RF Output

Maximum Leveled Output Power:

Frequency	Standard	with Option 1E1
0.01–1 GHz	+13 dBm	+13 dBm
1–18 GHz	+11 dBm	+10 dBm
18–20 GHz	+10 dBm	+8 dBm

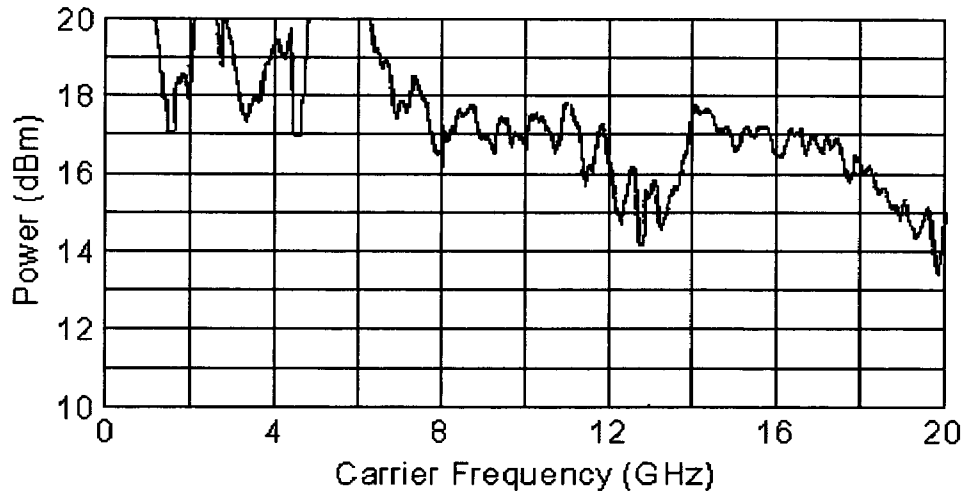

Figure 1-21.

Typical Maximum Available Output Power from 1 to 20 GHz, at 25 °C with Output Step Attenuator (Option 1E1) Installed

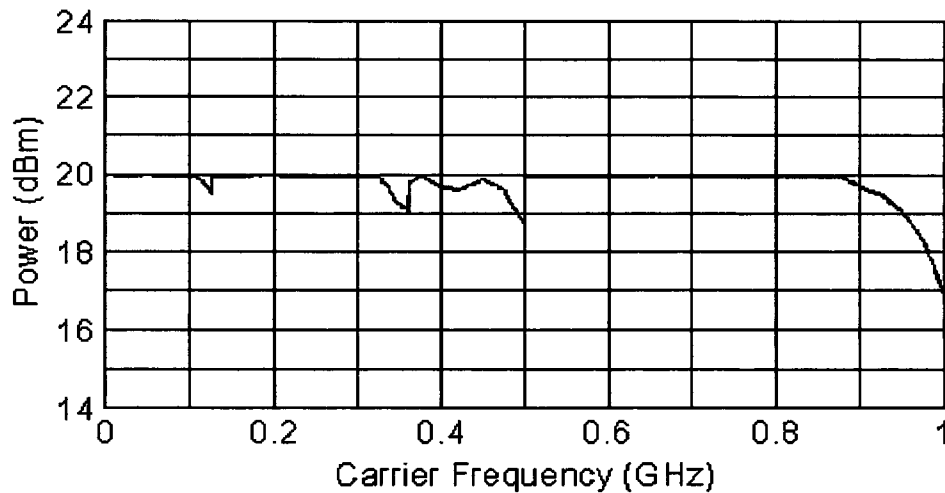

Figure 1-22. Typical Maximum Available Output Power from 0.01 to 1 GHz at 25 °C

Minimum Leveled Output Power -4 dBm; -10 dBm linear AM (-110 dBm with Option 1E1)

Display Resolution: 0.01 dB

Accuracy: ± 1.0 dB, 50 MHz to 20 GHz; ± 1.3 dB, 10 MHz to 50 MHz (-4 dBm to specified maximum leveled output power; with linear AM, -10 dBm to specified maximum leveled output power)

Accuracy (over all power levels)

10 MHz to 50 MHz: ± 2.3 dB (power ≥ -90 dBm)

50 MHz to 20 GHz: ± 2.0 dB (Power ≥ -90 dBm);

10 MHz to 20 GHz ± 2.5 dB (power < -90 dBm)

The use of Type-N RF connectors above 18.0 GHz degrades specification typically by 0.2 dB.

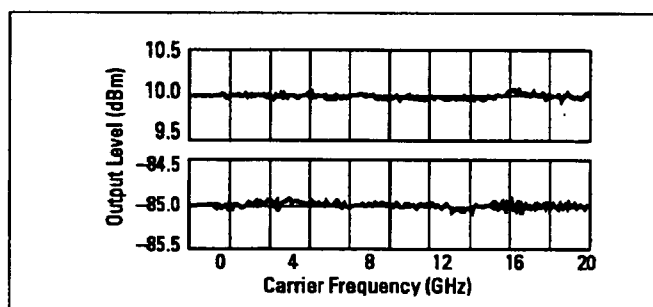

Figure 1-23. Typical Output Level Accuracy and Flatness at +10 and -85 dBm

Flatness: ± 0.5 dB (Power ≥ -90 dBm); ± 0.7 dB (Power < -90 dBm). The use of Type-N RF connectors above 18.0 GHz degrades specification typically by 0.2 dB.

Level Switching Time: Typically < 17 ms (without step attenuator range change).

Attenuator range changes occur at:

-10 dBm, -20 dBm, -30 dBm, etc. (Linear AM);

-4 dBm, -14 dBm, -24 dBm, etc. (all other modes)

Output SWR: $< 2.0 : 1$ nominal

Spectral Purity

SSB Phase Noise (dBc/Hz):

Table 1-6. Offsets

Carrier Freq.	100 Hz	1 kHz	10 kHz	100 kHz
500 MHz to <1 GHz	-78	-92	-103	-115
1 GHz to <2 GHz	-73	-83	-92	-107
2 GHz to <5 GHz	-70	-78	-83	-100
5 GHz to <10 GHz	-69	-78	-82	-100
10 GHz to 20 GHz	-65	-73	-76	-100

Phase noise decreases 6 dB/octave below 500 MHz and reaches a floor of <-140 dBc/Hz.

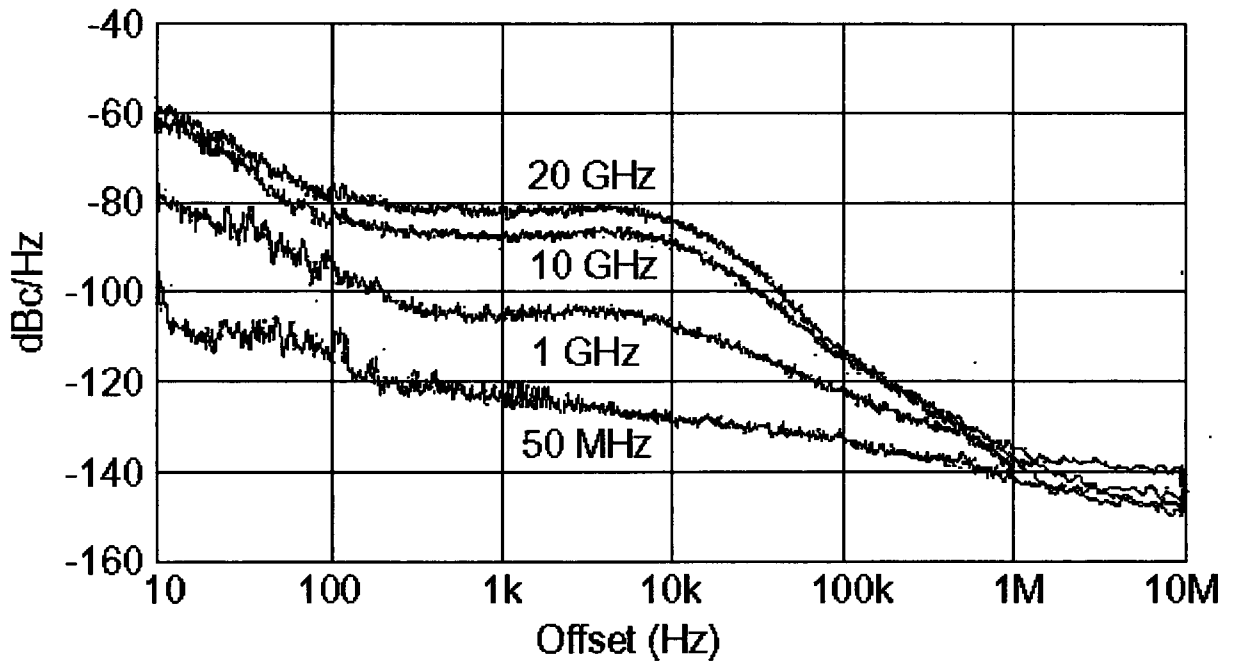

Figure 1-24.

Typical single-sideband phase noise at 50 MHz, 1 GHz, 10 GHz, and 20 GHz, 25 °C, CW mode. Offsets less than 100 Hz require the high stability timebase, Option 1E5.

In CW mode, phase noise degrades with frequency or phase modulation:

Modulation type	Degradation @ 20 kHz offset
FM	typically 10 dB
1 rad/V Phase Modulation	typically 5 dB
50 rad/V Phase Modulation	typically 20 dB

Harmonics: < -55 dBc at output levels $< +6$ dBm

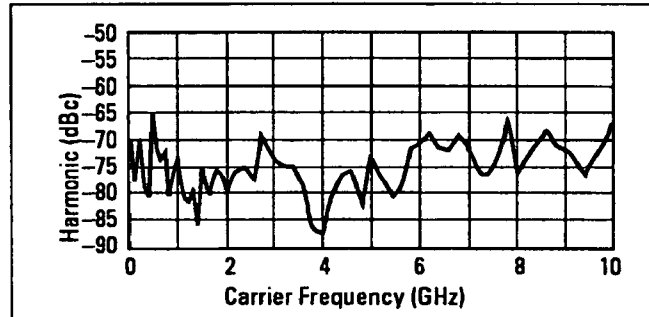

Figure 1-25. Typical 2nd Harmonic Levels Measured at Output Power of +6 dBm

Non-Harmonic Spurious (≥ 3 kHz): < -60 dBc (includes power supply and frequency synthesis spurious).

Non-Harmonic Spurious (< 3 kHz): < -50 dBc

Sub-Harmonics: None

Residual FM:

At 1 GHz, < 15 Hz in 50 Hz to 15 kHz bandwidth. Residual FM decreases 6 dB per octave below 1 GHz.

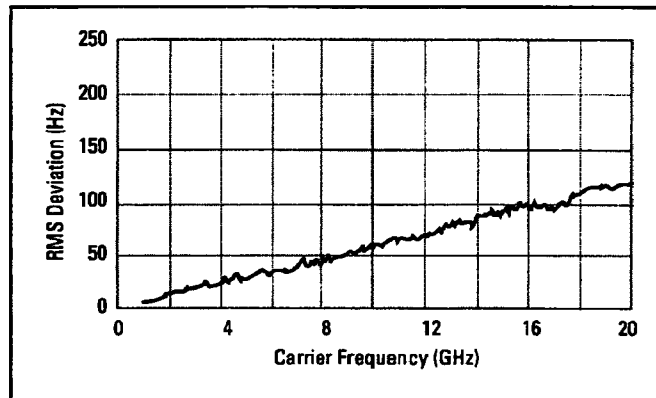

Figure 1-26.
Typical Residual FM Measured in 50 Hz – 15 kHz Bandwidth, CW Mode, with High Stability Timebase (Option 1E5)

AM Noise Floor: (at 0 dBm and offsets greater than 5 MHz from carrier)

< -150 dBm/Hz, 1 GHz to 20 GHz.

< -140 dBm/Hz, 0.01-1 GHz.

Modulation

Carrier Freq.	<25 MHz	25-64 MHz	64-128 MHz	128-500 MHz	500-1000 MHz	1-20 GHz
Minimum Pulse Width	<1 μ s		<100 ns		<25 ns <i>Typically <10 ns</i>	
Rise/Fall Time	<500 ns	<350 ns	<50 ns	<35 ns	<20 ns	<10 ns
Video Feedthrough	<2 mV peak-to-peak at 0 dBm					<20 mV peak-to-peak at 0 dBm
Pulse Width Compression	± 150 ns		± 15 ns		± 5 ns	
Pulse Delay (Video out to RF out)	<1 μ s		<200 ns		<125 ns	<100 ns

Pulse Modulation

Note CW power will be present for up to 10 ms when changing frequency or power level.

On/Off Ratio: > 80 dB

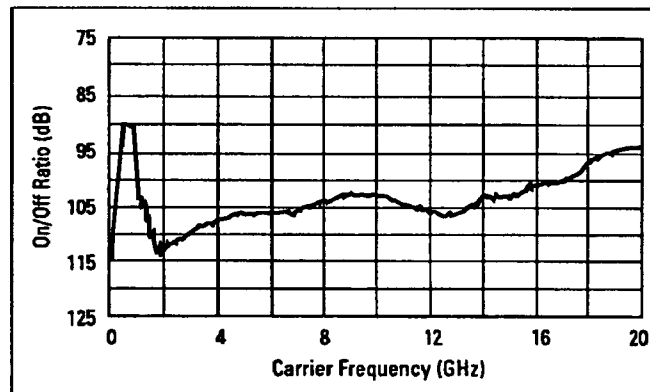
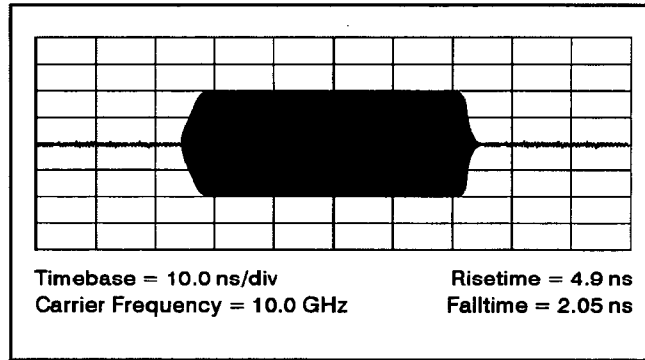

Figure 1-27. Typical Pulse Modulation On/Off Ratio at +8 dBm

Maximum Pulse Repetition Frequency: > 3 MHz
Minimum Pulse Duty Cycle: No restrictions on duty cycle.
Pulse Level Accuracy: ± 1.0 dB (relative to CW)
Pulse Overshoot: < 10%
Input Impedance: 50 Ω nominal; TTL drive levels
Maximum Leveled Output Power in Pulse Mode: -0.5 dB relative to CW



pk819ab

Figure 1-28.
Typical Pulse Modulation Envelope Illustrates the Fast Rise and Fall Times, Excellent Flatness and Pulse Fidelity

Internal Pulse Source

Pulse Source Modes: Free-run, triggered with delay, doublet and gated. Triggered with delay, doublet and gated require external trigger source.

Pulse Repetition Frequency: 3 Hz to >3 MHz

Pulse Repetition Interval (PRI): 300 ns to 419 ms

Pulse Width (T_w): 25 ns to 419 ms

Variable Pulse Delay (free-run mode, T_d): ± 419 ms from synchronizing pulse to video output.

Variable Pulse Delay (triggered with delay & doublet modes, T_d): 225 ns to 419 ms with ± 25 ns jitter

Pulse Width/Delay/PRI Resolution: 25 ns

Pulse Delay (Video to RF, T_m): Nominally, <20 ns, 1 to 20 GHz

All pulse modulation specifications and supplemental characteristics apply during use of internal pulse source.

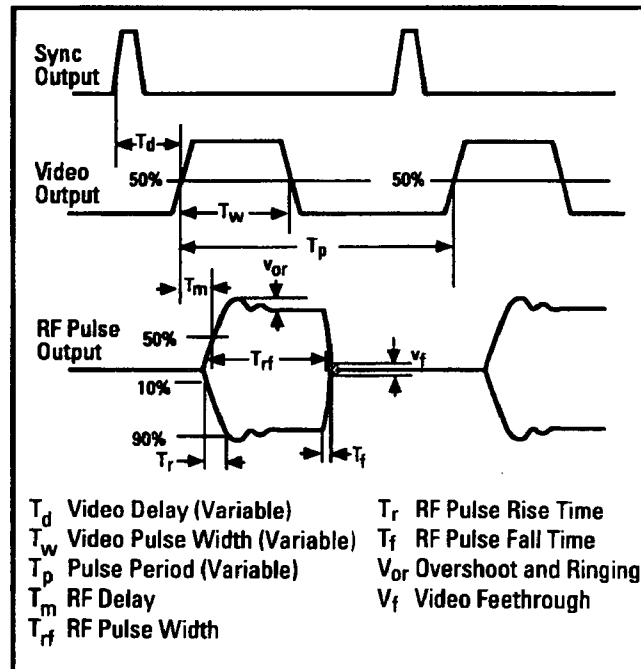

Frequency Modulation

Rates: 1 kHz to 1 MHz
Flatness: ± 2 dB

Table 1-7. Maximum Deviation (with sine-wave modulation only)

Frequency	Maximum Deviation
2 GHz to 20 GHz	10 MHz peak
1 GHz to <2 GHz	5 MHz peak
500 MHz to <1 GHz	2.5 MHz peak
256 MHz to <500 MHz	1.25 MHz peak

Maximum deviation decreases by a factor of 2 for each octave below 256 MHz.

Table 1-8. Modulation Index

Frequency	Modulation Index
2 GHz to 20 GHz	>300
1 GHz to <2 GHz	>150
500 MHz to <1 GHz	>75
256 MHz to <500 MHz	>37

Modulation index decreases by a factor of 2 for each octave below 256 MHz.

Sensitivity: 7 ranges, selectable

Frequency	Selectable Sensitivity	Unit
1 GHz to 20 GHz	10, 5, 3, 1, 0.3, 0.1, 0.03	MHz/V
256 MHz to <1 GHz	2500, 1250, 750, 250, 75, 25, 7.5	kHz/V
64 MHz to <256 MHz	625, 312, 187, 62.5, 18.7, 6.25, 1.87	kHz/V
16 MHz to <64 MHz	156, 78.1, 46.8, 15.6, 4.68, 1.56, 0.468	kHz/V
10 MHz to <16 MHz	78.1, 39.0, 23.4, 7.81, 2.34, 0.781, 0.234	kHz/V

FM Sensitivity Accuracy: $\pm 10\%$ typical at 100 kHz

Incidental AM: < 5%

FM Input Impedance: 600 Ω nominal

Harmonic Distortion: < 1% (1 MHz peak deviation @ 100 kHz rate)

Linear Amplitude Modulation

Sensitivity: 2 ranges, selectable: 30%/Vpk and 100%/Vpk

Sensitivity Accuracy: (1 KHz) $\pm 8\%$ of value $\pm 2\%$, (15 to 35 °C)

Maximum Depth: 90%

Bandwidth: (3 dB, 30% depth) DC to 100 kHz

Incidental Phase Modulation: (30% depth) 0.4 radians peak

Maximum Carrier Level in Linear AM Mode (Relative to CW):

<1 GHz	1–4 GHz	>4 GHz
0 dB	-4.5 dB	-1.0 dB

With modulation: degrades up to 6 dB, depending on depth.

Logarithmic Amplitude Modulation (Scan Modulation)

Maximum Depth: > 60 dB

Sensitivity: -10 dB/V; (0 to +6 V for 0 to -60 dBc)

Step Response (50 dB change in level): rise and fall < 5 μ s, 1 GHz to 20 GHz. Rise <10 μ s, <1 GHz. Fall <20 μ s, <1 GHz

Input Impedance: 5 k Ω nominal

Maximum Leveled Output Power in Log AM Mode (relative to CW):

<1 GHz	1-4 GHz	>4 GHz
0 dB	-4.5 dB	-1.0 dB

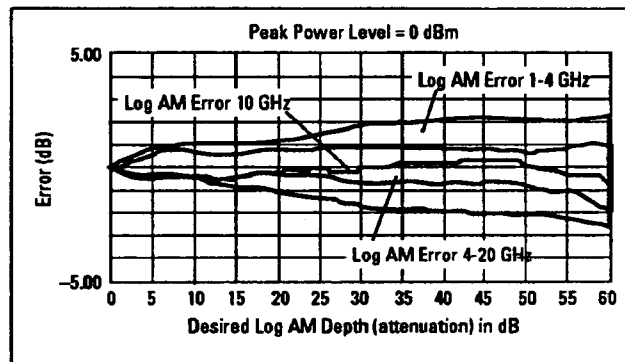

Figure 1-29.

Typical Log AM Error (deviation from desired depth) at 25 °C for Carrier Frequencies between 1.0 and 20 GHz

Simultaneous Modulations

Full AM bandwidth and depth is available at any pulse rate or width. FM/ ϕ M is completely independent of AM and pulse modulation.

Option 800 Phase Modulation

Adds phase modulation. The following specifications apply:
Sensitivity: 2 ranges, selectable:

Frequency	Low Range	High Range
1 GHz to 20 GHz	1 rad/Vpk	50 rad/Vpk
256 MHz to <1 GHz	0.25 rad/Vpk	12.5 rad/Vpk
64 MHz to <256 MHz	0.0625 rad/Vpk	3.12 rad/Vpk
16 MHz to <64 MHz	0.0156 rad/Vpk	0.781 rad/Vpk
10 MHz to <16 MHz	0.00781 rad/Vpk	0.39 rad/Vpk

Accuracy (typical): $\pm 5\%$ typical @ 1 kHz (Low Range); $\pm 10\%$ @ 100 Hz (High Range)

Flatness: DC-100 kHz: ± 1 dB (Low Range); DC-30 kHz: ± 2 dB (High Range)

Bandwidth (typical): 1 MHz (3 dB) (Low Range); useable to 1 MHz (at low deviations) (High Range)

Input Impedance: 600 Ω nominal (Low Range); 600 Ω nominal (High Range)

*Maximum Deviation
(with sine-wave
modulation only):*

Frequency	Low Range	High Range
2 GHz to 20 GHz	4 rad	200 rad
1 GHz to <2 GHz	2 rad	100 rad
500 MHz to <1 GHz	1 rad	50 rad
256 MHz to <500 MHz	.5 rad	25 rad

The maximum deviation decreases by a factor of 2 for each octave below 256 MHz.

Option 1E2

Specifications for internal modulation are the same as those for the base instrument, unless noted below:

Waveforms

Sine-wave: 0.5 Hz to 1 MHz rates.
Ramp, square, triangle: 0.5 Hz to 100 kHz rates
Uniform noise, Gaussian noise
Rate accuracy: $\pm 0.01\%$

Internal Scan Modulation

Rate: 0.5 Hz to 20 kHz
Rate Resolution: 0.5 Hz (3 digits displayed)
Depth Resolution: 0.01 dB (hardware resolution <math><.015\text{ dB}</math>)

Internal Linear AM

Rate: 0.5 Hz to 100 kHz
Rate Resolution: 0.5 Hz (3 digits displayed)
Depth Resolution: 0.1%

Internal FM

Rate: 1 kHz to 1 MHz
Rate Resolution: 0.5 Hz (3 digits displayed)
Deviation Resolution (3 digits displayed):

Table 1-9. Hardware Resolution

FM Deviation	Nominal Resolution
7.5 MHz to 10 MHz	3.66 kHz
3.75 MHz to <math><7.5\text{ MHz}</math>	1.83 kHz
1.875 MHz to <math><3.75\text{ MHz}</math>	916 Hz
938 kHz to <math><1.875\text{ MHz}</math>	458 Hz
469 kHz to <math><938\text{ kHz}</math>	289 Hz
234 kHz to <math><469\text{ kHz}</math>	114 Hz
117 kHz to <math><234\text{ kHz}</math>	57 Hz
<math><117\text{ kHz}</math>	29 Hz

Flatness: ± 2 dB (1 kHz to 500 kHz)

Internal Phase Modulation (with Option 800 only)

Rate: 0.5 Hz to 1 MHz

Rate Resolution: 0.5 Hz (3 digits displayed)

Deviation Resolution (3 digits displayed):

Table 1-10. ϕ M Hardware Resolution (Low Range)

Internal ϕM Deviation (Low Range)	Nominal Resolution
3 rad to 4 rad	1.465 mrad
1.5 rad to <3 rad	732 μ rad
0.75 rad to <1.5 rad	366 μ rad
375 mrad to <750 mrad	183 μ rad
188 mrad to <375 mrad	92 μ rad
94 mrad to <188 mrad	46 μ rad
47 mrad to <94 mrad	23 μ rad
<47 mrad	12 μ rad

Table 1-11. ϕ M Hardware Resolution (High Range)

Internal ϕM Deviation (High Range)	Nominal Resolution
150 rad to 200 rad	73.2 mrad
75 rad to <150 rad	36.6 mrad
37.5 rad to <75 rad	18.3 mrad
18.75 rad to <37.5 rad	9.16 mrad
9.375 rad to <18.75 rad	4.58 mrad
4.688 rad to <9.375 rad	2.89 mrad
2.344 rad to <4.688 rad	1.14 mrad
<2.344 rad	0.57 mrad

Bandwidth (typical): 700 kHz (3 dB) on low range

General Specifications

The general specifications given here apply equally to the HP 83711A/11B, HP 83712A/12B, HP 83731A/31B, and HP 83732A/32B.

Programming

The synthesizers are fully compatible with the Standard Commands for Programmable Instruments (SCPI). SCPI programming complies with IEEE 488.2-1987. In addition, these synthesizers will emulate most applicable HP 8673 commands, providing general compatibility with ATE systems which include HP 8673 series signal generators. Optional CIIL programming compatibility is available. Consult your HP sales representative for details.

Environmental

Operating Temperature Range: 0° to 55°C (for indoor use).

Altitude: Up to 15,000 feet (4,572 meters).

Relative Humidity: 80% for temperatures up to 31°C decreasing linearly to 50% relative humidity at 40°C.

EMC: Complies with CISPR Publication 11/1990, Class A, Group 1 and MIL-STD-461C, Part 2, Methods CE03 (NB full limits, BB 10 dB relaxation 150 kHz to 500 kHz, full limits elsewhere); CS01; CS02; RE02 (Curve 2 +10 dB); RS03 (1 V/m, 15 kHz to 1 GHz).

This product is designed for use in INSTALLATION CATEGORY II and POLLUTION DEGREE 2, per IEC 1010 and 664 respectively.

Acoustic Noise Emission (Geraeuschemission)

LpA <70 dB(A) per ISO 3744 (LpA <70 dB(A) nach DIN 45635 pt. 1)

LpA Operator position: 44.6 dB, based upon type test per ISO 6081. (LpA am Arbeitsplatz: 44.6 dB, typpruefungsergebnis nach DIN 45635 pt. 19)

LpA Bystander position: 38.4 dB, based upon type test per ISO 6081. (LpA fiktiver Arbeitsplatz: 38.4 dB, typpruefungsergebnis nach DIN 45635 pt. 19)

Power Requirements

Power: 90-132 V, 48-440 Hz. 198-264 V, 48-66 Hz.
260 VA maximum.

Physical Dimensions

Net Weight: < 16 kg (35 lb)

Shipping: < 23 kg (49 lb)

Size: 498 mm D × 426 mm W × 133 mm H (19.6"×16.8"×5.2")

Transit case available by ordering HP Part Number 9211-2655.

Front Panel Connectors

RF OUTPUT

The standard front panel RF OUTPUT connector is a Type-N precision connector. When Option 1E9 is installed, this front panel connector is a 3.5 mm precision connector. The nominal source impedance is 50 Ω .

ALC IN

This front panel BNC connector allows the synthesizer to be externally leveled. It is used with external power meter leveling or external diode leveling. The leveling signal at this input must be in the ± 1 V range. The nominal input impedance is 150 k Ω . The damage level is $\geq +12$ V or ≤ -12 V.

AM IN (HP 83731A/32A and HP 83731B/32B only)

Accepts an input signal for external Linear AM or Log AM. Nominal impedance 5 k Ω . Damage level is $\geq +15.5$ V or ≤ -15.5 V.

FM/ ϕ M IN (HP 83731A/32A and HP 83731B/32B only)

Accepts an input signal for external FM or phase modulation (phase modulation is only available on HP 83731B/32B with Option 800 installed). Nominal impedance is 600 Ω . Damage level is $\geq +5$ V or ≤ -5 V.

PULSE/TRIG GATE IN (HP 83731A/32A and HP 83731B/32B only)

Accepts an input signal for external pulse modulation. Also, it accepts an external trigger pulse input for internal pulse modulation (TTL-level compatible, nominal impedance 50 Ω).

PULSE VIDEO OUT (HP 83731A/32A and HP 83731B/32B only)

The output is a signal that follows the RF output in all pulse modes (TTL-level compatible, nominal source impedance 50 Ω).

PULSE SYNC OUT (HP 83731A/32A and HP 83731B/32B only)

The output is a synchronizing pulse, nominally 50 ns width, during internal and triggered pulse modulation (TTL-level compatible, nominal source impedance 50 Ω).

Rear Panel Connectors

10 MHz Input

Accepts a 10 MHz \pm 100 Hz, 0 to +10 dBm, external reference signal for operation from an external high stability timebase. Nominal input impedance is 50 Ω .

10 MHz Output

Outputs the 10 MHz reference signal, nominally +3 dBm, for use as an external reference signal. Nominal source impedance is 50 Ω .

0.5 V/GHz Output

Supplies a voltage proportional to output frequency for use with mm-wave frequency multipliers, including the HP 83550 Series Millimeter Wave Source Modules.

AM Output (HP 83731B/32B Option 1E2 only):

Provides a sample of the modulating signal from the internal AM generator or external AM input.

FM/ ϕ M Output (HP 83731B/32B Option 1E2 only):

Provides a sample of the modulating signal from the internal FM/ ϕ M generator or external FM/ ϕ M input.

Options

There are several electrical, mechanical, warranty, and documentation options available for the synthesizer. The electrical options are described here while the mechanical and warranty options are detailed in Chapter 4 of the User's Guide.

Electrical Options

There are three electrical options available for the synthesizer. These options are as follows:

- Option 1E1 - Add Output Step Attenuator

If Option 1E1 is ordered, an internal step attenuator is included before the RF OUTPUT connector. The step attenuator has a range of 0 to 90 dB in 10 dB steps for HP 83711A/12A and HP 83731A/32A; 0 to 110 dB in 10 dB steps for HP 83711B/12B and HP 83731B/32B. The correct amount of attenuation is selected automatically by the synthesizer dependent on the output power level selected. If this option is installed, you can select whether or not the step attenuator will automatically switch. This function is useful during certain applications, such as when external automatic level control is used.

- Option 1E2 - Internal AM and FM/ ϕ M Sources

If Option 1E2 is ordered, internal Log/Linear AM and FM/ ϕ M sources are provided. These sources are both front panel controllable and programmable using an instrument controller.

Note Option 800 is also required to activate the internal ϕ M source.

- Option 1E5 - Add High Stability Timebase

If Option 1E5 is ordered, the synthesizer is shipped with a 10 MHz temperature controlled crystal reference oscillator for increased frequency accuracy and stability. If Option 1E5 is installed, the synthesizer must be connected to AC mains power to keep the reference oscillator at operating temperature. If the reference oscillator has not been connected to mains power (the oven is cold), the synthesizer requires 30 minutes to warm up.

- Option 1E8 - 1 Hz Frequency Resolution

- Option 1E9 - 3.5 mm RF output Connector

If Option 1E9 is ordered, the RF OUTPUT connector is a male APC-3.5 precision connector in place of the standard female Type-N connector.

- Option 800 - Phase Modulation (HP 83731B/32B Option 800 Only)

If Option 800 is ordered, phase modulation is available. Two phase modulation ranges can be selected: low and high. The low range is from 17 mrad to 4 rads and, the high range is from 1.17 rads to 300 rads, depending on CW frequency.

Equipment Required

This chapter contains required test equipment that is necessary for performance tests, adjustments, and troubleshooting.

Required Test Equipment Table

The Instrument column of the table contains the generic instrument name. The Critical Specifications column contains the specifications which the instrument must meet or exceed. The Recommended Model column contains the suggested instrument model. The Use column contains codes which denote where the equipment is used (P = Performance Tests, A = Adjustments, O = Operator's Check's- upon installation or after repair, T = Troubleshooting).

Table 2-1. Required Test Equipment

Instrument	Critical Specifications	Recommended Model	Use
Spectrum Analyzer ^{1,2}	Frequency Range: 10 MHz to 20 GHz Minimum Resolution Bandwidth: 1 kHz	HP 71210C/ HP 8566B	P,O,T,A
Frequency Counter	Frequency: 10 MHz±1 Hz	HP 5334B	A
Microwave Frequency Counter	Synthesizer's Frequency Range	HP 5343A Option 001	P,O,A,T
Voltmeter	Range: -50 to +50 Vdc Input Impedance: ≥10 MΩ	HP 3456A/ HP 3458B ²	P,O,A,T
Function Generator	Frequency Range: DC to 10 MHz Square/ Sinewave Outputs Level Range: 0 to 10 V Maximum Transition Time: 7 ns Minimum Pulse Width: 25 ns	HP 8116A/HP 3325A ²	O,P,T,A
Pulse/Function Generator ²	Accuracy: 20 mV	HP 3245A	A
Microwave Converter ^{1,2}	RF Frequency Range: 1 GHz to 20 GHz 10 dBm maximum loss between RF input and IF LO: +8 dBm to +13 dBm	11793A	A,P
Synthesized Sweeper ^{1,2}	Frequency Range: 10 MHz to 20 GHz Power Out: +8 dBm	83640A	A,P
Power Meter ²	Power Range: 1 μW to 100 mW Accuracy: ±0.02 dB	HP 437B	P,O,A

1 Required for Option 1E1 (add step attenuator) low level accuracy performance test and adjustment, only.

2 The programming language for this equipment must be compatible with the language used in the automated adjustment procedures.

Table 2-1. Required Test Equipment (continued)

Instrument	Critical Specifications	Recommended Model	Use
Power Sensor	Frequency Range: 50 MHz to 20 GHz SWR < 1.25 Power Range: 1 μ W to 100 mW	HP 8485A	O ¹ ,P ¹ ,A
Power Sensor	Frequency Range: 10 MHz to 18 GHz Power Range: 1 μ W to 100 mW SWR < 1.28	HP 8481A	O,P,T
Power Sensor	Frequency Range: 10 MHz to 1 GHz SWR < 1.10 Power Range: 1.0 μ W to 100 mW	HP 8482A	A
Adapter	Type N (m) to APC 3.5 mm (f); no substitute	HP 1250-1744	P
Step Attenuator	0 to 11 dB	HP 8494B	P
Measuring Receiver ²	Tuned Frequency: 21.4 MHz Power Range: 0 to -127 dBm Relative Power Accuracy: \pm .5 dB	HP 8902A	O,P,T,A
Carrier Noise Test Set	no substitute	HP 11729C	P
Dynamic Signal Analyzer	Center Frequency Range: 100 Hz to 10 kHz Frequency Span: 200 Hz to 33 kHz Start Frequency: 3 kHz	HP 3561A	P
Digitizing Oscilloscope	General Purpose	HP 54100D	T,P,A
Digitizing Oscilloscope	Frequency Range: dc to 20 GHz Rise Time: 17.5 ps maximum Time Interval Accuracy: 10 ps maximum	HP 54121T	P
Frequency Standard	Frequency: 10 MHz Aging Rate: $<1.5 \times 10^{-10}$ /day	HP 5061B	P,A
6 dB BNC Attenuator	BNC (m) to BNC (f)	Texscan FP-50	P

1 Required for Option 1E9 (3.5 mm RF output connector, only).

2 The programming language for this equipment must be compatible with the language used in the automated adjustment procedures.

Table 2-1. Required Test Equipment (continued)

Instrument	Critical Specifications	Recommended Model	Use
10 dB Attenuator	APC 3.5 mm (m) to APC 3.5 mm (f)	HP 8493C Opt 010	P,A
20 dB Attenuator	APC 3.5 mm (m) to APC 3.5 mm (f)	HP 8493C Opt 020	P
20 dB BNC Attenuator	BNC (m) to BNC (f)	Texscan FP-50	P
Reference Oscillator	Frequency Range: 80 MHz to 720 MHz Power Output: 0 dBm to -40 dBm	HP 8662A Opt 003	P
Controller	HP BASIC 5.1 HP-IB Capability	HP Series 300	A
Printer	HP-IB Capability		A

Performance Tests

Introduction

The procedures detailed here test the electrical performance of the synthesizer. These tests do not require access to the interior of the instrument.

Notes

1. If these tests are to be considered valid, the following conditions must be met:
 - Allow the synthesizer to warm up for at least 1 hour before running any tests.
 - Perform the tests in the order that they appear.
 - Select test equipment as listed in each test or according to the “Required Test Equipment” table in Chapter 2, “Equipment Required.”
 - The tests are performed under normal operating conditions as stated in the specification tables in the Specifications chapter of this book.
 2. The person who performs the test supplies whatever cables, connectors, and adapters are necessary.
 3. These tests contain a minimum set of data points. The performance of the synthesizer *can* be checked at other points within the specified range.
-

Performance Test Records

Calculations and results of the performance tests may be recorded in the appropriate performance test record in Chapter 4, “Performance Test Record,” of this book. Results recorded can be used for comparison in periodic maintenance and troubleshooting, and after repairs or adjustments.

Calibration Cycle

This instrument requires periodic verification of performance. Under normal use and environmental conditions, the instrument should be calibrated every two years. Normal use is defined to be about 2000 hours of use per year.

Required Test Equipment

The Required Test Equipment information in Chapter 2 contains equipment that is necessary for performance tests, adjustments, and troubleshooting.

Test equipment is also listed in each procedure with the test setup. Other equipment can be substituted for the recommended models (except where noted otherwise) if it meets or exceeds the critical specifications listed.

Test Setups

A diagram showing the test setup is included at the beginning of each procedure. The diagrams for procedures that apply to any of the synthesizers, show only the HP 83731 (or HP 83732). The instrument is labeled as HP 837xx in these diagrams. Note that arrows in the diagrams indicate a connection to the instrument rear panel and do not indicate signal flow.

The Synthesizer Self Test

The synthesizer Self Test is designed to determine the functionality of the instrument under normal (room temperature, low humidity) environmental conditions.

This procedure must be performed for all instrument models.

Notes

1. Running the self test will leave the synthesizer in the preset state.
 2. Error codes generated under conditions of environmental stress may or may not indicate a failure of the synthesizer circuitry.
-

1. Disconnect any external connections to the synthesizer.
2. Check the synthesizer for any pre-existing error conditions.

For the synthesizer:

Error conditions are indicated by the front panel MSG annunciator. If the MSG annunciator is lit, read the error messages and resolve any problems before continuing with this procedure. Refer to the procedure, "To Read the Contents of the Error Queue" in Chapter 2, "Performing Fundamental Synthesizer Operations," of the User's Guide.

Note

If any problems cannot be resolved (one or more error messages cannot be cleared), go to the troubleshooting chapter of the Service Guide for the instrument.

3. To run the self test routine.

On the synthesizer:

- a. Press the **(SPCL)** key.
- b. Type **(5)** on the numeric keypad and terminate the entry by pressing **(Hz)** (ENTER).

The left-most display reads, SELF TEST?, PRESS ENTER

- c. Press **(Hz)** (ENTER) again.

When the self test routine is running, the left-most display will alternately flash SELF TESTING! and PRESETTING INSTRUMENT. After the test completes, the left-most display reads Self Test passed. If the self test fails, the left-most display will momentarily read TEST XX = YY where "XX" and "YY" are numbers indicating the error condition.

If the Procedure Fails

- Check that the Error Indicator is not flashing.

Internal Timebase Aging Rate (Option 1E5 Only)

This procedure checks the accuracy of the internal high stability time base (Option 1E5). The time required for a specific phase change is measured both before and after a specified waiting period. The aging rate is inversely proportional to the absolute value of the difference in the measured times.

Specification

Specification	Conditions
$<1.5 \times 10^{-9}$ /day	after a 24-hour warm up.

Note The internal timebase can be tested after reconnecting ac power for 10 minutes, but, for best accuracy, test again after the instrument has been on for 24 hours.

Recommended Equipment

HP 54100D Digitizing Oscilloscope
HP 5061A Frequency Standard

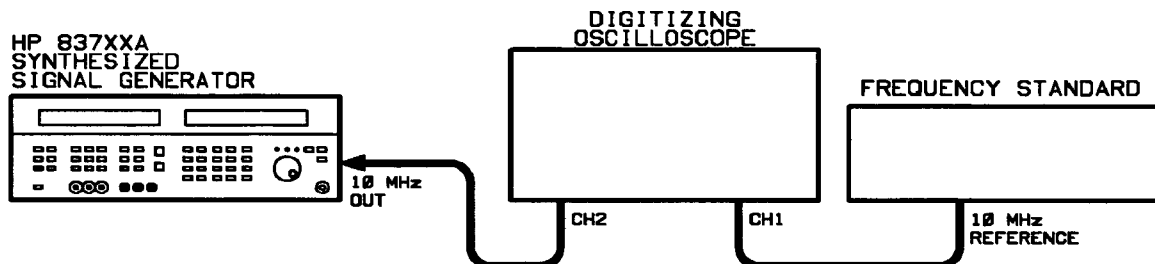

Figure 3-1. Internal Timebase Aging Rate Test Equipment Setup

1. Connect the equipment as shown in Figure 3-1.
2. Preset the synthesizer.
3. Set the RF output level on the synthesizer to 0 dBm.
4. Press **AUTOSCALE** on the oscilloscope.
5. Monitor the time and the channel 2 display in order to determine the time required for a 360 degree phase change.
6. Record this time, T1 (in seconds), in the space provided.
T1 = _____ seconds
7. Wait anywhere between 3 and 24 hours.
8. Note how long you waited, T2 (in hours), in the space provided.
T2 = _____ hours
9. Monitor the time and the channel 2 display, again, in order to determine the time required for a 360 degree phase change.

10. Record this time, T3 (in seconds), in the space provided.

T3 = _____ seconds

11. Calculate the aging rate and record it in the performance test record chapter of this book.

$$\text{Aging Rate} = (1 \text{ cycle}/10 \text{ MHz})(1/T1 - 1/T3)(24 \text{ hours}/T2)$$

Note If the absolute frequency of the standard and of the time base oscillator are extremely close, you can reduce the measurement time (T1 and T3) by measuring the time required for a phase change of less than 360 degrees. For instance, in step 9, change 1 cycle to 0.5 cycle for a 180 degree phase shift.

If the Procedure Fails

- Verify the test setup and instrument settings.
- Ensure that the instruments have warmed up long enough and that environmental conditions have not changed throughout the test.
- If the 360 degree phase shift takes less than 2 minutes, perform the "10 MHz Standard" adjustment, and, then, repeat this procedure.

Frequency Range and Resolution

This procedure uses a frequency counter to verify the frequency range and the tuning resolution of the synthesizer.

Specification

Specification	Conditions
HP 83711A/11B and HP 83731A/31B 1 kHz 1 Hz	1 to 20 GHz 1 to 20 GHz (Option 1E8)
HP 83712A/12B and HP 83732A/32B 1 kHz 1 Hz	0.01 to 20 GHz 0.01 to 20 GHz (Option 1E8)

Recommended Equipment

HP 5343A Frequency Counter Option 001

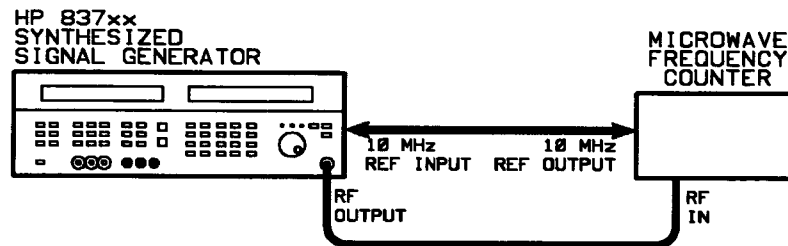

Figure 3-2. Frequency Range and Resolution Test Setup

To Set Up the Equipment

1. Set up the equipment as shown in Figure 3-2.

Note Use a cable that has no more than 20 dB of loss over the frequency range being tested to connect the synthesizer RF output to the frequency counter.

2. Preset (or reset) the frequency counter.
3. Set the frequency counter display resolution to 100 Hz (or 1 Hz if your synthesizer has Option 1E8).
4. Preset the synthesizer.
5. Set the RF output level to 0 dBm on the synthesizer.
6. Set the CW frequency on the synthesizer to the following:
 - HP 83711A/11B and HP 83731A/31B: 1 GHz
 - HP 83712A/12B and HP 83732A/32B: 10 MHz

To Check Frequency Resolution

1. Read the value displayed on the frequency counter and record it in the test record chapter of this book.

The display should read as follows:

HP 83711A/11B and HP 83731A/31B: 1 GHz \pm 1 kHz (or \pm 1 Hz for Option 1E8).

HP 83712A/12B and HP 83732A/32B: 10 MHz \pm 1 kHz (or \pm 1 Hz for Option 1E8).

2. Increase the synthesizer CW frequency by 1 kHz (or by 1 Hz for Option 1E8) *as indicated on the synthesizer display*.
3. Read the value displayed on the frequency counter and record it in the test record chapter of this book.

To Check Frequency Range

1. Increase the synthesizer CW frequency to 20 GHz.
2. Read the value displayed on the frequency counter and record it in the test record.

The display should read 20 GHz \pm 1 kHz (or \pm 1 Hz for Option 1E8).

If the Procedure Fails

- Verify the test setup and instrument settings.

External ALC

External automatic leveling control (ALC) capability is verified by using a power meter to level the signal at a point other than the RF OUTPUT connector.

This test must be performed for all instrument models.

Recommended Equipment

- HP 437B Power Meter
- HP 8481A Power Sensor
- HP 8494B 0 to 11 dB Step Attenuator

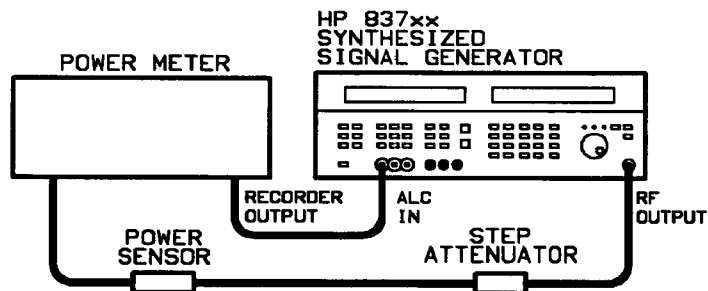

Figure 3-3. External Leveling Test Setup

To Set Up the Equipment

1. Connect the equipment as shown in the Figure 3-3.
2. Set the power meter to dBm mode.
3. Set the step attenuator to 1 dB.
4. Preset the synthesizer.
5. Set the RF output level to 5 dBm on the synthesizer.

To Level the Signal Externally

1. Select the auto-range mode on the power meter.
2. Select range hold mode on the power meter.

For the synthesizer:

- a. Press the **EXT METER** key.
- b. Enter the power shown on the power meter display into the synthesizer using the numeric keypad and **GHz** (dBm) keys.

Once the power meter reading is entered, the synthesizer enters external power meter leveling mode.

To Verify External Leveling

1. Observe the power meter reading.
2. Set the step attenuator to +2 dB.
3. Observe that the power meter reading changes and then returns to about the same level as in step 1.
4. Set the step attenuator to 0 dB.
5. Observe that the power meter reading changes and then returns to about the same level as in step 1.
6. Record your observations in Chapter 4, "Performance Test Record," in this book.

The power meter reading should be about the same as it was in step 1.

If the Procedure Fails

- Verify the test setup and instrument settings.

Maximum Leveled Power

This procedure verifies the maximum power specification over frequency by measuring the power at the output connector of the synthesizer when it is set for maximum vernier and 0 dB of attenuation.

This procedure must be performed for all synthesizer models.

Table 3-1. HP 83711A/11B

Specification	Conditions
+11 dBm	(0°C to 35°C)
+10 dBm	with Option 1E1 (0°C to 35°C)

Table 3-2. HP 83712A/12B

Specification	Conditions
+13 dBm	0.01 to 1 GHz (0°C to 35°C)
+11 dBm	1 to 20 GHz (0°C to 35°C)
+10 dBm	1 to 20 GHz with Option 1E1 (0°C to 35°C)

Table 3-3. HP 83731A/31B

Specification	Conditions
+11 dBm	1 to 18 GHz
+10 dBm	1 to 18 GHz with Option 1E1
+10 dBm	18 to 20 GHz
+8 dBm	18 to 20 GHz with Option 1E1

Table 3-4. HP 83732A/32B

Specification	Conditions
+13 dBm	0.01 to 1 GHz
+11 dBm	1 to 18 GHz
+10 dBm	1 to 18 GHz with Option 1E1
+10 dBm	18 to 20 GHz
+8 dBm	18 to 20 GHz with Option 1E1

Recommended Equipment

HP 437B Power Meter

HP 8482A Power Sensor (for 0.01 to 1 GHz, only)

HP 8485A Power Sensor

HP part number 1250-1744 Type-N (m) to APC 3.5 mm (f) Adapter

Note The adapter used in this procedure must be an HP part number 1250-1744 adapter that is in good condition. A Type-N to SMA adapter is not an acceptable substitute.

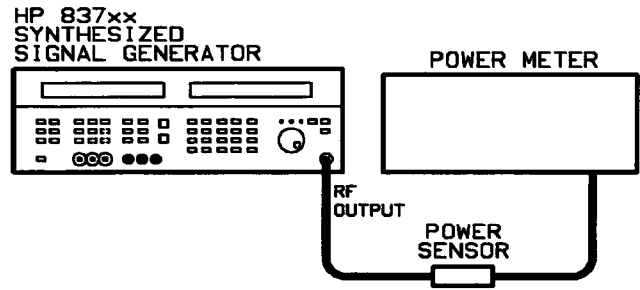

Figure 3-4. Maximum Power Test Setup

To Set Up the Equipment

1. Zero and calibrate the power sensor (HP 8485A) and meter according to the power meter operating manual.
2. Set up the equipment as shown in Figure 3-4.
3. Set the power meter to dBm mode.
4. Preset the synthesizer.
5. Set CW frequency on the synthesizer to 1 GHz.
6. Adjust the RF output level of the synthesizer as follows:

Model	Level Setting
HP 83711A/11B	+ 12 dBm
HP 83711A/11B Option 1E1	+ 11 dBm
HP 83712A/12B	+ 12 dBm
HP 83712A/12B Option 1E1	+ 11 dBm
HP 83731A/31B	+ 12 dBm
HP 83731A/31B Option 1E1	+ 11 dBm
HP 83732A/32B	+ 12 dBm
HP 83732A/32B Option 1E1	+ 11 dBm

Note that the synthesizer level setting is 1 dB greater than the specification.

To Measure Maximum Power at 1 GHz

1. Set the calibration factor on the power meter for the synthesizer's CW frequency.
2. Measure power on the power meter using the HP 8485A sensor.
3. Check the unlevelled indicator and the power level indicated on the power meter.
4. If the unlevelled indicator is off and the power indicated on the power meter is greater than or equal to the maximum leveled power specification shown at the beginning of this procedure, record this observation by circling "yes" in Chapter 4, "Performance Test Record," in this book.
5. If the unlevelled indicator is on *and* the power meter reading is less than the maximum leveled power specification, the instrument does not pass this test. Record this observation by circling "no" in the performance test record chapter of this book. Refer to "If the Procedure Fails".

6. If the unlevelled indicator is on and the power meter reading is greater than the maximum levelled power specification, *slowly* decrease the synthesizer RF output level until the unlevelled indicator turns off.
7. If the unlevelled indicator turns off and the power meter display is still greater than or equal to the maximum levelled power specification, record this observation in the performance test record by circling "yes."
8. If the power meter display is less than the maximum levelled power specification when the unlevelled indicator turns off, the instrument does not pass this test. Record this observation in the performance test record by circling "no," and refer to "If the Procedure Fails."
9. If the unlevelled indicator is off and the power meter reading is less than the maximum levelled power specification, *slowly* increase the synthesizer RF output level until the power meter reading is equal to the maximum levelled power specification.
10. If the power meter reading is equal to the maximum levelled power specification, and the unlevelled indicator is off, record this observation in the performance test record by circling "yes."
11. If the unlevelled indicator turns on before the maximum levelled power specification is attained, the instrument does not pass this test. Record this observation in the performance test record by circling "no," and refer to "If the Procedure Fails."

To Measure Maximum Power between 1 GHz and 18 GHz

1. For the following CW frequencies, set the cal factor, measure power, and verify that: the unlevelled indicator is off and the power meter reading is greater than or equal to the specification as in the procedure, "To Measure Maximum Power at 1 GHz."
 - 1.64 GHz
 - 2.74 GHz
 - 4.79 GHz
 - 5.99 GHz
 - 7.99 GHz
 - 9.99 GHz
 - 10.00 GHz
 - 12.79 GHz
 - 13.99 GHz
 - 17.99 GHz

To Measure Maximum Power between 18 GHz and 20 GHz

1. Set the synthesizer RF output level as follows:

Model	Level Setting
HP 83711A/11B	+ 12 dBm
HP 83711A/11B Option 1E1	+ 11 dBm
HP 83712A/12B	+ 12 dBm
HP 83712A/12B Option 1E1	+ 11 dBm
HP 83731A/31B	+ 11 dBm
HP 83731A/31B Option 1E1	+ 9 dBm
HP 83732A/32B	+ 11 dBm
HP 83732A/32B Option 1E1	+ 9 dBm

2. For the following CW frequencies, set the cal factor, measure power, and verify that: the unlevelled indicator is off and the power meter reading is greater than or equal to the specification as in the procedure, "To Measure Maximum Power at 1 GHz."

Note Set the increment value for CW frequency to 100 MHz, and use the knob or arrow keys to more easily change frequencies.

19.0 GHz
19.1 GHz
19.2 GHz
19.3 GHz
19.4 GHz
19.5 GHz
19.6 GHz
19.7 GHz
19.8 GHz
19.9 GHz
20.00 GHz

To Measure Maximum Power for 0.01 to 1 GHz (HP 83712A/12B, HP 83732A/32B, Only)

1. Replace the HP 8485A sensor with the HP 8482A sensor for this procedure.
2. Set the synthesizer RF output level to 14 dBm.
3. For the following CW frequencies, set the cal factor, measure power, and verify that:

The unlevelled indicator is off and the power meter reading is greater than or equal to the specification as in the procedure, "To Measure Maximum Power at 1 GHz."

Note Set the increment value for CW frequency to 0.1 MHz, and use the knob or arrow keys to more easily change frequencies.

10 MHz
11.2 MHz
11.3 MHz
15.9 MHz
16 MHz
22.5 MHz
22.6 MHz
31.9 MHz
32 MHz
45.3 MHz
45.4 MHz
63.9 MHz
64 MHz
90.4 MHz
90.5 MHz
127.9 MHz
128 MHz
180.9 MHz
181 MHz
255.9 MHz
256 MHz
361.9 MHz
362 MHz
499.9 MHz
500 MHz
699.9 MHz
700 MHz
999 MHz

If the Procedure Fails

- Verify the test setup and instrument settings.
- Check that the proper sensor is being used for the frequency being tested.
- Check that the sensor and power meter are properly calibrated and zeroed.
- Check that the correct sensor calibration factor is used for the frequency being tested.

Vernier Level Accuracy and Flatness

This procedure tests level accuracy throughout the vernier range with a power meter and sensor.

Flatness is measured at several power level settings by identifying the largest and smallest recorded readings at all of the frequency settings, and determining the difference between them.

Specification	Conditions
Level Accuracy:	
±1.0 dB	HP 83711A/11B, (1–20 GHz) 0 dBm to maximum power
±1.3 dB	HP 83712A/12B, (10–50 MHz) 0 dBm to maximum power
±1.0 dB	HP 83712A/12B, (50 MHz – 20 GHz) 0 dBm to maximum power
±1.0 dB	HP 83731A/31B, (1–20 GHz) –4 dBm to maximum power
±1.3 dB	HP 83732A/32B, (10–50 MHz) –4 dBm to maximum power
±1.0 dB	HP 83732A/32B, (50 MHz – 20 GHz) –4 dBm to maximum power ¹¹
Flatness:	
1 dB ¹²	10 MHz to 1 GHz
1 dB	1 GHz to 20 GHz

1 Using standard Type-N RF output connectors, level accuracy is not specified above 18 GHz. Level accuracy in this frequency range is typically degraded by about 0.2 dB.

2 Total deviation from ideal flatness is ±0.5 dB (a range of 1 dB).

Recommended Equipment

HP 437B Power Meter

HP 8481A Power Sensor

HP 8485A Power Sensor (for synthesizer with Option 1E9)

HP part number 1250-1750 3.5 mm to Type-N Adapter (to test to 10 MHz with Option 1E9)

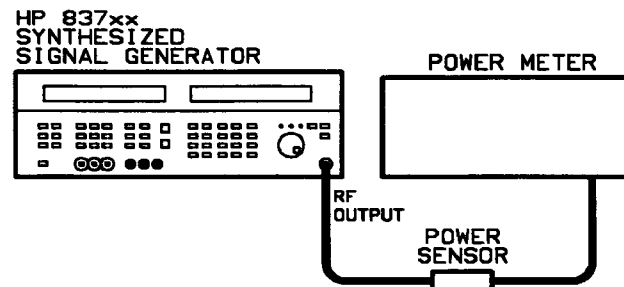

Figure 3-5. Vernier Level Accuracy and Flatness Test Setup

To Set Up the Equipment

1. Select the appropriate power sensor. If you have an Option 1E9 instrument, you will need to use the HP 8481A power sensor and 3.5 mm to Type-N adapter to test from 10 MHz to 50 MHz.
2. Zero and calibrate the power sensor and meter according to the power meter operating manual.
3. Set up the equipment as shown in Figure 3-5.

4. Preset the synthesizer.
5. Set the CW frequency on the synthesizer to the following
 - HP 83711A/11B and HP 83731A/31B: 1.033 GHz
 - HP 83712A/12B and HP 83732A/32B: 10.1 MHz
6. Set the RF output level on the synthesizer to the following levels:
 - HP 83711A/11B: +10 dBm
 - HP 83712A/12B: +10 dBm
 - HP 83731A/31B: +8 dBm
 - HP 83732A/32B: +8 dBm

To Measure Vernier Level Accuracy

1. Set the calibration factor on the power meter as required for a reading at the selected frequency.
2. Measure the power at each of the following level settings and record it in Chapter 4, "Performance Test Record," in this book.

HP 83711A/11B	HP 83712A/12B	HP 83731A/31B	HP 83732A/32B
+10 dBm	+10 dBm	+8 dBm	+8 dBm
+5 dBm	+5 dBm	+6 dBm	+6 dBm
0 dBm	0 dBm	-3.9 dBm	-3.9 dBm

If you have an HP 83712A/12B or HP 83732A/32B:

For 10 MHz to 50 MHz, power levels should be accurate to ± 1.3 dB. For 50 MHz to 20 GHz, power levels should be accurate to ± 1.0 dB.

If you have an HP 83711A/11B or HP 83731A/31B, power levels should be accurate to ± 1.0 dB, 1 to 20 GHz.

3. Repeat steps 1 and 2 for each of the following frequencies:

HP 83711A/11B	HP 83712A/12B	HP 83731A/31B	HP 83732A/32B
	10.1 MHz		10.1 MHz
	18.192 MHz		18.192 MHz
	329.488 MHz		329.488 MHz
	657.168 MHz		657.168 MHz
	984.848 MHz		984.848 MHz
1.033 GHz	1.033 GHz	1.033 GHz	1.033 GHz
5.225 GHz	5.225 GHz	5.225 GHz	5.225 GHz
9.487 GHz	9.487 GHz	9.487 GHz	9.487 GHz
13.75 GHz	13.75 GHz	13.75 GHz	13.75 GHz
18.00 GHz	18.00 GHz	18.00 GHz	18.00 GHz
20.00 GHz ¹	20.00 GHz ¹	20.00 GHz ¹	20.00 GHz ¹

¹ 20 GHz flatness and accuracy is specified for Option 1E9 (3.5 mm RF output) instruments only. Use the HP 8485A power sensor above 18 GHz.

To Check Flatness

1. Review the level readings for the maximum recorded power level at all frequencies in order to determine flatness.

For each RF Level setting, flatness is the absolute difference between the largest recorded level reading and the smallest recorded level reading without regard to frequency. For example, if the recorded level reading is largest at 1.033 GHz (+8.1 dBm, for example) and smallest at +18.00 GHz (+7.9 dBm, for example), then flatness at the +8 dBm setting would be 0.2 dB.

2. Record the calculated flatness in Chapter 4, "Performance Test Record," in this book.

For 10 MHz to 1 GHz, the variation between any two recorded power levels should be less than 1.3 dB.

For 1 GHz to 20 GHz, the variation between any two recorded power levels should be less than 1.0 dB.

Note Flatness is not referenced to any particular frequency. Rather it represents the total power variation over the entire frequency range of the synthesizer. The maximum to minimum power level difference is less than two times the plus-and-minus specification limits. Thus, for a specification of ± 0.5 dB, the maximum to minimum power level difference will be less than 1.0 dB.

If the Procedure Fails

- Verify the test setup and instrument settings.
- Check that the sensor and power meter are properly calibrated and zeroed.
- Check that the correct sensor is used for the power level being measured.
- Check that the correct sensor calibration factor is used for the frequency being tested.
- Run the "Frequency Calibration 1" and the "Vernier Calibration" procedures in Chapter 7, "Service Software."

Low Level Accuracy and Flatness (Option 1E1 Only)

This procedure should be performed for all instrument models with Option 1E1. The procedure measures and verifies low level (-4 dBm to -90 dBm; -105 dBm for "B" models) accuracy using a power meter for -4 to -24 dBm and the HP 8902A measuring receiver for levels down to -90 dBm.

Specification	Conditions	< -90 dBm
Low Level Accuracy		
± 2.3 dB	10 to 50 MHz	± 2.5 dB
± 2.0 dB	50 MHz to 1 GHz	± 2.5 dB
± 1.0 dB	1 to 18 GHz ¹	± 2.5 dB
Flatness:		Flatness:
1 dB	1 MHz to 1 GHz	1.4 dB
1 dB	1 GHz to 18 GHz	1.4 dB

¹ With the standard Type-N RF output connector, level accuracy is not specified above 18 GHz. Level accuracy in this frequency range is typically degraded by about 0.2 dB.

Recommended Equipment

HP 83640A Synthesized Sweeper
 HP 8902A Measuring Receiver
 HP 437B Power Meter
 HP 8481A Power Sensor (for synthesizer without Option 1E9)
 HP 8485A Power Sensor (for synthesizer with Option 1E9)
 HP 8493C Option 010 10 dB Attenuator
 HP 11793A Microwave Converter

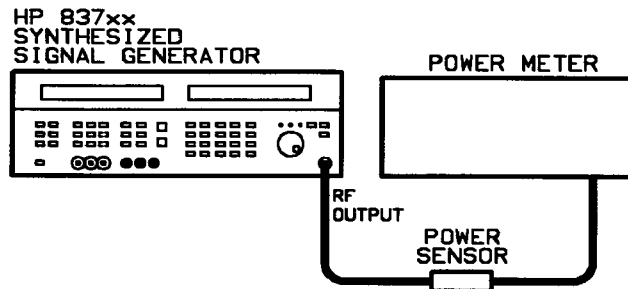

Figure 3-6. Low Level Accuracy Test Setup using Power Meter

To Set Up the Equipment for Levels from -24 dBm to $+5$ dBm

1. Preset the synthesizer.
2. Set CW frequency on the synthesizer 18 GHz.
3. Set RF output level on the synthesizer to -24 dBm.
4. Zero and calibrate the power meter and sensor and enter the appropriate cal factor for the frequency.
5. Connect the equipment as shown in Figure 3-6.

To Measure Level Accuracy from -24 dBm to $+5$ dBm with a Power Meter

1. Read the level displayed on the power meter and record in Chapter 4, "Performance Test Record," in this book.

Note

In this test, data is gathered for accuracy at some frequencies. Data for flatness is gathered at other frequencies. The performance test record for low level accuracy and flatness in Chapter 4 in this book is organized by frequency (from lowest to highest) only.

2. Set the synthesizer RF output to the following levels, and record the displayed power meter reading for each.

-24 dBm
 -14 dBm
 -4 dBm
 $+5$ dBm

Note that the power meter reading at the synthesizer setting of $+5$ dBm, referred to in the performance test record as ABS@(frequency) is used later in this procedure as a reference for relative measurements.

3. Repeat steps 1 and 2 for each of the following frequencies:

HP 83711A/11B	HP 83712A/12B	HP 83731A/31B	HP 83732A/32B
	42.768 MHz		42.768 MHz
	960.272 MHz		960.272 MHz
1.5 GHz	1.5 GHz	1.5 GHz	1.5 GHz
18.00 GHz	18.00 GHz	18.00 GHz	18.00 GHz

To Establish References at -14 dBm and $+5$ dBm with a Power Meter for Level Flatness

1. Read the level displayed on the power meter and record it in Chapter 4, "Performance Test Record," in this book.
2. Set the synthesizer RF output to the following levels, and record the displayed power meter reading for each.

-14 dBm
 $+5$ dBm

3. Repeat steps 1 and 2 at the following frequencies:

HP 83711A/11B	HP 83712A/12B	HP 83731A/31B	HP 83732A/32B
13.75 GHz	13.75 GHz	13.75 GHz	13.75 GHz
9.487 GHz	9.487 GHz	9.487 GHz	9.487 GHz
5.225 GHz	5.225 GHz	5.225 GHz	5.225 GHz
	632.592 MHz		632.592 MHz
	304.912 MHz		304.912 MHz

To Set Up Equipment for Frequencies Below 1 GHz and Levels from –34 dBm to –90 dBm (to –105 for HP 83712B and HP 83732B)

This procedure applies to HP 83712A/12B and HP 83732A/32B instruments only.

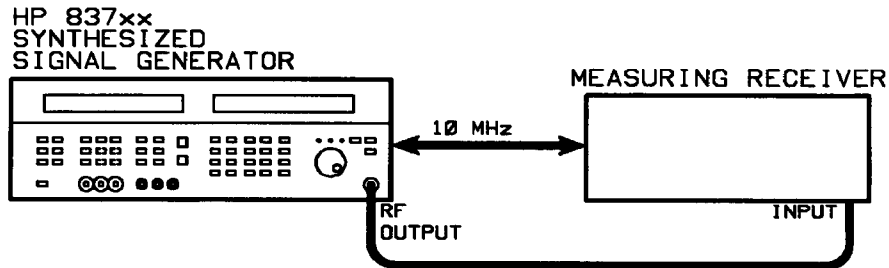

Figure 3-7. 10 MHz to 1 GHz Low Level Accuracy Test Setup using Measuring Receiver

1. Connect the equipment as shown in Figure 3-7.
2. Preset the synthesizer then set RF output level to +5 dBm at 42.768 MHz.
3. Set up the HP 8902A measuring receiver as follows:
 - a. Press **(Blue Shift)** and then the green **(Instrument Preset)** to preset.
 - b. Press **(MHz)** (INPUT FREQ).
The display should read 42.768 MHz
 - c. Press **(Gold S)** and then **(Tuned RF Level)** to set the receiver to tuned RF mode.
Ignore any error indicators such as the UNCAL annunciator.
 - d. Press **(LOG/LIN)** in order to display power in dBm.
 - e. Press **(Blue Shift)** and then **(SET REF)** (the **(ZERO)** key) to set the receiver to relative mode.
The display should read 0.00 dB and no error indicators should be on.

To Measure Relative Level Accuracy below 1 GHz from –34 dBm to –90 dBm (to –105 for HP 83712B and HP 83732B)

This procedure applies to HP 83712A/12B and HP 83732A/32B instruments only.

1. Decrease the synthesizer RF output to –4 dBm.
2. Check to see whether the RECAL annunciator on the measuring receiver is on or off.
If the RECAL annunciator is off, decrease the RF output by 10 dB.
If the RECAL annunciator is on, press the **(CALIBRATE)** key on the measuring receiver, and then, decrease the RF output by 10 dB.
3. Continue to decrease the synthesizer output by 10 dB steps, recalibrating the measuring receiver whenever the RECAL annunciator turns on, until you reach –34 dBm.

4. Record the measuring receiver relative reading, REL, for the following synthesizer levels in Chapter 4, "Performance Test Record," of this book:

- 34 dBm
- 44 dBm
- 54 dBm
- 64 dBm
- 74 dBm
- 84 dBm
- 90 dBm
- 95 dBm (HP 83712B and HP 83732B only)

5. Perform the following steps for a HP 83712B or HP 83732B only:

- a. Set the CW level to -105 dBm.
- b. Press **(SPCL)** **(2)** **(HZ)** (ENTER).
- c. Press **↑** to turn attenuator hold on.
- d. Set synthesizer power level to -100 dBm.
- e. Record the measuring receiver relative reading REL@-105 dBm.

6. Preset the synthesizer.

7. Set the synthesizer frequency to 960.272 MHz.

8. Set the synthesizer CW level to +5 dBm.

9. Establish a +5 dBm reference level on the measuring receiver. Set up the HP 8902A measuring receiver as follows:

- a. Press **(Blue Shift)** and then the green **(Instrument Preset)** to preset.
- b. Press **(MHz)** (INPUT FREQ).

The display should read 960.272 MHz

- c. Press **(Gold S)** and then **(Tuned RF Level)** to set the receiver to tuned RF mode.
- d. Press **(LOG/LIN)** in order to display power in dBm.
- e. Press **(Blue Shift)** and then **(SET REF)** (the **(ZERO)** key) to set the receiver to relative mode.

The display should read 0.00 dB and no error indicators should be on.

10. Repeat steps 1 through 5 and record the levels in the performance test record.

To Establish Relative References below 1 GHz at -90 dBm for Level Flatness (-105 for HP 83712B and HP 83732B)

This procedure applies to HP 83712A/12B and HP 83732A/32B instruments only.

1. Preset the synthesizer then set CW frequency to 304.912 MHz.
2. Establish a +5 dBm reference on the measuring receiver. Set up the HP 8902A measuring receiver as follows:
 - a. Press **(Blue Shift)** and then the green **(Instrument Preset)** to preset.
 - b. Press **(MHz)** (INPUT FREQ).
The display should read 304.912 MHz
 - c. Press **(Gold S)** and then **(Tuned RF Level)** to set the receiver to tuned RF mode.
 - d. Press **(LOG/LIN)** in order to display power in dBm.
 - e. Press **(Blue Shift)** and then **(SET REF)** (the **(ZERO)** key) to set the receiver to relative mode.
The display should read 0.00 dB and no error indicators should be on.
3. Decrease the synthesizer RF output to -4 dBm.
4. Check to see whether the RECAL annunciator on the measuring receiver is on or off.
If the RECAL annunciator is off, decrease the RF output by 10 dB.
If the RECAL annunciator is on, press the **(CALIBRATE)** key on the Measuring Receiver, and then, decrease the RF output by 10 dB.
5. Continue to decrease the synthesizer output by 10 dB steps, recalibrating the measuring receiver whenever the RECAL annunciator turns on, until you reach -90 dBm.
6. Perform the following steps for a HP 83712B or HP 83732B only:
 - a. Set the CW level to -105 dBm.
 - b. Press **(SPCL)** **(2)** **(HZ)** (ENTER).
 - c. Press **↑** to turn attenuator hold on.
 - d. Set synthesizer power level to -100 dBm.
 - e. Record the measuring receiver relative reading REL@-105 dBm.
7. Record the measuring receiver relative reading, REL, in the performance test record chapter of this book.
8. Repeat this procedure for 632.592 MHz.

To Set Up Equipment for Frequencies above 1 GHz and levels from -34 dBm to -90 dBm (to -105 for "B" models)

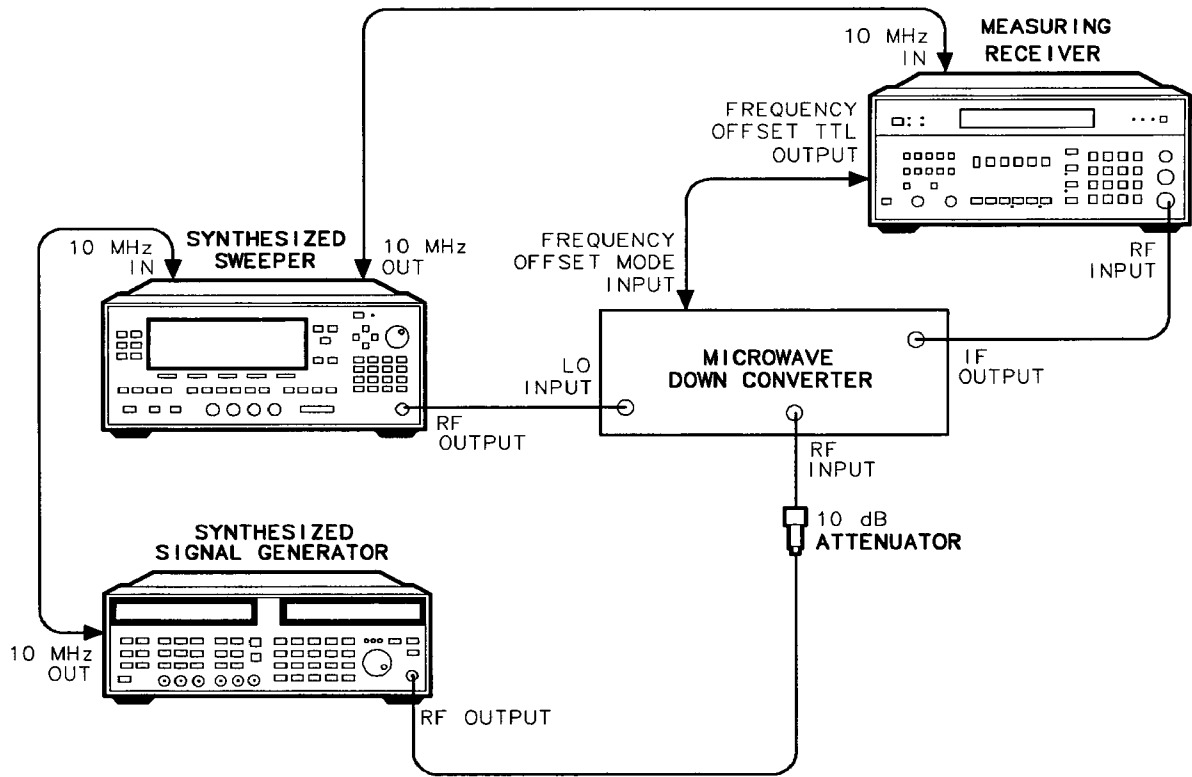

wk62ab

Figure 3-8. 1 GHz to 18 GHz Low Level Accuracy Test Setup using Measuring Receiver

Note

It is recommended that you use a rigid or high quality semi-rigid cable that is less than 2 feet long for this procedure. At 18 GHz, the maximum loss of the cable (connecting synthesizer RF output to microwave down converter RF Input) should be less than 5 dB.

For maximum accuracy, connect the 10 dB attenuator directly to the microwave down converter input.

1. Connect the equipment as shown in Figure 3-8.
 The synthesizer frequency should be 1.5 GHz.
 The synthesizer RF output level should be +5 dBm.

2. Set up the external microwave LO (HP 83640A) as follows:
 - a. Preset
 - b. Center frequency = 1521.4 MHz
 - c. Power level = 8 dBm
3. Set up the HP 8902A measuring receiver as follows:
 - a. Press **Blue Shift** and then the green **Instrument Preset** to preset.
 - b. Press **27.3** **SPCL**.
 - c. Press **1521.4** **MHz**.
 - d. Press **Gold S** and then **Tuned RF Level** to set the receiver to tuned RF mode.
Ignore any error indicators such as the UNCAL annunciator.
 - e. Press **LOG/LIN** in order to display power in dBm.
 - f. Press **Blue Shift** and then **SET REF** (the **ZERO** key) to set the receiver to relative mode.
The display should read 0.00 dB and no error indicators should be on.

To Measure Relative Level Accuracy above 1 GHz from –34 dBm to –90 dBm (to –105 for “B” models)

1. Decrease the synthesizer RF output to –4 dBm.
2. Check to see whether the RECAL annunciator on the measuring receiver is on or off.
If the RECAL annunciator is off, decrease the RF output by 10 dBm.
If the RECAL annunciator is on, press the **CALIBRATION** key on the Measuring Receiver, and then, decrease the RF output by 10 dB.
3. Continue to decrease the synthesizer output by 10 dB steps, recalibrating the measuring receiver whenever the RECAL annunciator turns on, until reaching –90 dBm (–105 dBm for “B” models).
4. Record the measuring receiver relative reading, REL, for the following synthesizer levels in the performance test record chapter in this book:
 - 34 dBm
 - 44 dBm
 - 54 dBm
 - 64 dBm
 - 74 dBm
 - 84 dBm
 - 90 dBm
 - 95 dBm (“B” models only)
5. Perform the following steps for “B” models only:
 - a. Set the CW level to –105 dBm.
 - b. Press **SPCL** **2** **HZ** (ENTER).
 - c. Press **↑** to turn attenuator hold on.
 - d. Press **↑** until the display reads a power level of –100 dBm.
 - e. Record the measuring receiver relative reading REL@–105 dBm.
6. Change the synthesizer frequency to 18 GHz.
7. Increase the synthesizer CW level to +5 dBm.

8. Establish a +5 dBm reference level on the measuring receiver:

- a. Set the external microwave LO (HP 83640A) frequency to 18021.4 MHz.
- b. Set up the HP 8902A measuring receiver as follows:

Press **(Blue Shift)** and then the green **(Instrument Preset)** to preset.

Press **(27.3)** **(SPCL)**.

Press **(18021.4)** **(MHz)**.

Ignore any error indicators such as the UNCAL annunciator.

Press **(Gold S)** and then **(Tuned RF Level)** to set the receiver to tuned RF mode.

Press **(LOG/LIN)** in order to display power in dBm.

Press **(Blue Shift)** and then **(SET REF)** (the **(ZERO)** key) to set the receiver to relative mode.

The display should read 0.00 dB and no error indicators should be on.

9. Repeat steps 1 through 4 and record the results in the performance test record.

To Establish Relative References above 1 GHz at -90 dBm for Level Flatness (-105 dBm for "B" models)

1. Preset synthesizer, then set the CW frequency to 5.225 GHz.
2. Set the external microwave LO (HP 83640A) frequency to 5246.5 MHz.
3. Establish a +5 dBm reference on the measuring receiver. Set up the HP 8902A measuring receiver as follows:

- a. Press **(Blue Shift)** and then the green **(Instrument Preset)** to preset.

- b. Press **(27.3)** **(SPCL)**.

- c. Press **(5246.5)** **(MHz)**.

Ignore any error indicators such as the UNCAL annunciator.

- d. Press **(Gold S)** and then **(Tuned RF Level)** to set the receiver to tuned RF mode.

- e. Press **(LOG/LIN)** in order to display power in dBm.

- f. Press **(Blue Shift)** and then **(SET REF)** (the **(ZERO)** key) to set the receiver to relative mode.

The display should read 0.00 dB and no error indicators should be on.

4. Decrease the synthesizer RF output to -4 dBm.

5. Check to see whether the RECAL annunciator on the measuring receiver is on or off.

If the RECAL annunciator is off, decrease the RF output by 10 dBm.

If the RECAL annunciator is on, press the **(CALIBRATION)** key on the Measuring Receiver, and then, decrease the RF output by 10 dB.

6. Continue to decrease the synthesizer output by 10 dB steps, recalibrating the measuring receiver whenever the RECAL annunciator turns on, until reaching -90 dBm.

7. Perform the following steps for "B" models only:

- a. Set the CW level to -105 dBm.

- b. Press **(SPCL)** **(2)** **(HZ)** (ENTER).

- c. Press \uparrow to turn attenuator hold on.

- d. Set synthesizer power level to -100 dBm.

- e. Record the measuring receiver relative reading REL@-105 dBm.

8. Record the measuring receiver relative reading, REL, for the following synthesizer levels in the performance test record chapter in this book:.
9. Repeat this procedure for:

Synthesizer	External Microwave LO (HP 83640A)
9.487 GHz	9508.4 MHz
13.75 GHz	13771.4 MHz

To Calculate the Actual Power Levels from -34 dBm to -95 dBm

This calculation is an example of how to calculate accuracy at 1.5 GHz. Use this example to calculate level accuracy from -95 dBm to $+5$ dBm at the following frequencies:

HP 83711A/11B and HP 83731A/31B	HP 83712A/12B and HP 83732A/32B
	42.768 MHz
	960.272 MHz
1.5 GHz	1.5 GHz
18 GHz	18 GHz

1. Add the power meter reading at $+5$ dBm, ABS@(frequency) (dBm) to each recorded relative measuring receiver reading, REL (dB), in order to calculate each actual level, ACT (dBm).
2. To calculate actual power level with a synthesizer setting of -34 dBm, refer to the following example:

The power meter reading $+5$ dBm, ABS@1.5 GHz = $+5.25$ dB.

The measuring receiver reading REL@ -34 dBm = -39.5 dB.

$$(+5.25) + (-39.5) = -34.25$$

$$\text{ACT@}-34\text{dBm} = -34.25 \text{ dBm}$$

3. Record in the performance test record chapter in this book:

Each calculated Actual Power Level, ACT, should be within the following specifications:

10 to 50 MHz: ± 2.3 dB

50 MHz to 1 GHz: ± 2.0 dB

1 to 20 GHz: ± 1 dB

To calculate the actual power levels at -105 dBm for HP 83712B and HP 83732B, perform the following steps:

4. Add the power meter reading at $+5$ dBm, ABS@(frequency) (dBm) to the recorded relative measuring receiver reading, REL -105 dBm, then add -5 dBm in order to calculate the actual level at -105 dBm, ACT -105 dBm.
5. To calculate actual power level at -105 dBm, refer to the following example:

The power meter reading $+5$ dBm, ABS@1.5 GHz = $+5.25$ dB.

The measuring receiver reading REL@ -105 dBm = -105.1 dB.

$$(+5.25) + (-105.1) + (-5) = -104.95 \text{ dBm}$$

$$\text{ACT@}-105\text{dBm} = -104.95 \text{ dBm}$$

6. Record in the performance test record chapter in this book:

Each calculated Actual Power Level, ACT, should be within the following specifications (<−90 dBm):

- 10 to 50 MHz: ± 2.5 dB
- 50 MHz to 1 GHz: ± 2.5 dB
- 1 to 20 GHz: ± 2.5 dB

For HP 83712B and HP 83732B <−90 dBm:

- 10 to 50 MHz: ± 2.5 dB
- 50 MHz to 1 GHz: ± 2.5 dB
- 1 to 20 GHz: ± 2.5 dB

To Calculate Actual Power Levels for Flatness

1. Add the power meter reading at +5 dBm for each test frequency, ABS, to each of the recorded relative measuring receiver readings, REL (dB), in order to obtain each Actual Level, ACT (dBm).
2. Record the calculated Actual Levels in the performance test record chapter of this book.

To Calculate Flatness from 0.01 to 1 GHz

1. Review the recorded power meter readings at frequencies between 0.01 and 1 GHz for a synthesizer RF output of −14 dBm in order to determine the minimum value and the maximum value over the frequency range.
2. Subtract the minimum value (dBm) from the maximum value (dBm) in order to obtain the flatness (dB) at −14 dBm.
3. Record the value in the performance test record chapter of this book.

This value should be ≤ 1 dB.

4. Review the recorded Actual Levels (dBm) for a synthesizer RF output of −90 dBm (−105 dBm for HP 83712B and HP 83732B) to determine the minimum value and the maximum value.
5. Subtract the minimum value (dBm) from the maximum value (dBm) in order to obtain the flatness (dB) at −90 dBm (−105 dBm for HP 83712B and HP 83732B).
6. Record this value in the performance test record chapter of this book.

This value should be ≤ 1 dB.

At levels <−90 dBm, this value should be ≤ 1.4 dB.

To Calculate Actual Power Levels for Flatness

1. Add the power meter reading at +5 dBm for each test frequency, ABS, to each of the recorded relative measuring receiver readings, REL (dB), in order to obtain each Actual Level, ACT (dBm).
2. Record the calculated Actual Levels in the performance test record chapter of this book.

To Calculate Flatness from 1 to 20 GHz

1. Review the recorded power meter readings at frequencies between 1 and 20 GHz for a synthesizer RF output of -14 dBm in order to determine the minimum value and the maximum value over the frequency range.
2. Subtract the minimum value (dBm) from the maximum value (dBm) in order to obtain the flatness (dB) at -14 dBm.
3. Record the value in the performance test record chapter of this book.
This value should be ≤ 1 dB.
4. Review the recorded Actual Levels (dBm) for a synthesizer RF output of -90 dBm (-105 dBm for “B” models) to determine the minimum value and the maximum value.
5. Subtract the minimum value (dBm) from the maximum value (dBm) in order to obtain the flatness (dB) at -90 dBm (-105 dBm for “B” models).
6. Record this value in the performance test record chapter of this book.
This value should be ≤ 1 dB.
At levels < -90 dBm, this value should be ≤ 1.4 dB.

If the Procedure Fails

- Verify the test setup and instrument settings.
- Run the “Frequency Calibration 2” and the “Attenuator Calibration” procedures in Chapter 7, “Service Software.”

Harmonics

This procedure must be performed for all instrument models. The test measures and verifies 2nd harmonic power level relative to the carrier power in dBc over the synthesizer's frequency range at appropriate frequencies.

Specification	Conditions
< -55 dBc	< +6 dBm (HP 83731A/32A and HP 83731B/32B)
< -50 dBc	< +6 dBm (HP 83711A/12A and HP 83711B/12B, 1 - 20 GHz)
< -55 dBc	< +6 dBm (HP 83712A/12B, 0.01 - 1 GHz)

Recommended Equipment

HP 71210C Spectrum Analyzer

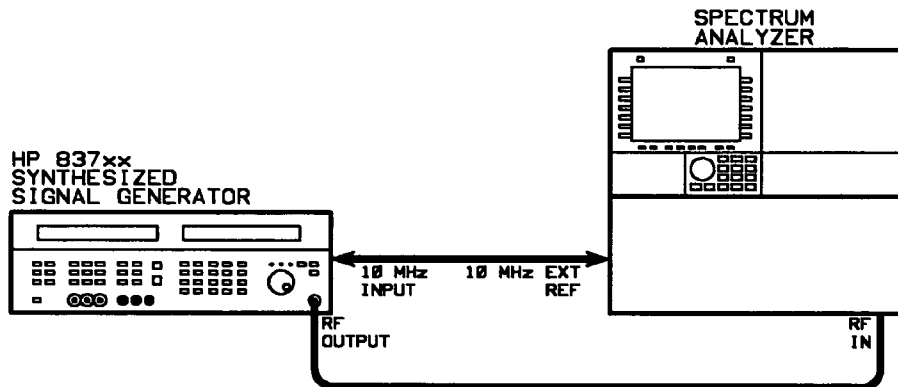

Figure 3-9. Harmonics Test Setup

To Set Up the Equipment

1. Connect the equipment as shown in Figure 3-9.
2. Set up the spectrum analyzer as follows:
 - a. Preset
 - b. Center frequency:
 - For HP 83711A/11B: 1 GHz
 - For HP 83712A/12B: 10 MHz
 - For HP 83731A/31B: 1 GHz
 - For HP 83732A/32B: 10 MHz
 - c. Reference level = 0 dBm
 - d. Scale log = 10 dB/division
 - e. Attenuation = 20 dB
 - f. Span = 100 kHz
 - g. Resolution Bandwidth = 300 Hz
 - h. Video Bandwidth = 1 kHz

3. Preset the synthesizer.
4. Set CW frequency on the synthesizer to:
 - HP 83711A/11B: 1 GHz
 - HP 83712A/12B: 10 MHz
 - HP 83731A/31B: 1 GHz
 - HP 83732A/32B: 10 MHz
5. Set the RF output level on the synthesizer to:
 - HP 83711A/11B: 0 dBm
 - HP 83712A/12B: 0 dBm
 - HP 83731A/31B: -3.9 dBm
 - HP 83732A/32B: -3.9 dBm

To Measure 2nd Harmonic Level

1. Adjust the spectrum analyzer's frequency and level controls to position the carrier peak on the top graticule line. This is the reference level line.
2. Tune the spectrum analyzer's frequency control to $2 \times$ the fundamental frequency and view the 2nd harmonic, if any.

Helpful Hint

Many spectrum analyzers will allow you to set markers. This feature is usually accompanied by an automatic comparison of the difference (delta in dBc) between two markers. If your spectrum analyzer has this feature, set your reference marker at the top of the fundamental frequency then at the top of the 2nd harmonic and read the difference (in dBc) from the screen.

3. Record your observation in the performance test record chapter of this book.

4. Repeat steps 1 through 3 for the following frequencies, and record the results in the performance test record:

HP 83711A/11B	HP 83712A/12B	HP 83731A/31B	HP 83732A/32B
	11.3 MHz		11.3 MHz
	16 MHz		16 MHz
	22.6 MHz		22.6 MHz
	32 MHz		32 MHz
	45.5 MHz		45.5 MHz
	64 MHz		64 MHz
	90.5 MHz		90.5 MHz
	128 MHz		128 MHz
	181 MHz		181 MHz
	256 MHz		256 MHz
	362 MHz		362 MHz
	500 MHz		500 MHz
	700 MHz		700 MHz
1.00 GHz	1.00 GHz	1.00 GHz	1.00 GHz
1.65 GHz	1.65 GHz	1.65 GHz	1.65 GHz
2.75 GHz	2.75 GHz	2.75 GHz	2.75 GHz
4.8 GHz	4.8 GHz	4.8 GHz	4.8 GHz
8.0 GHz	8.0 GHz	8.0 GHz	8.0 GHz
9.9 GHz	9.9 GHz	9.9 GHz	9.9 GHz
10.0 GHz	10.0 GHz	10.0 GHz	10.0 GHz

5. Set the CW frequency on the synthesizer to:

HP 83711A/11B: 1 GHz

HP 83712A/12B: 10 MHz

HP 83731A/31B: 1 GHz

HP 83732A/32B: 10 MHz

6. Set the RF output level on the synthesizer to +6 dBm.

7. Repeat steps 1 through 4 and record the results in the performance test record.

Note Harmonics are not specified for carrier frequencies above 10 GHz.

If the Procedure Fails

- Verify the test setup and instrument settings.

Single-Sideband Phase Noise

This test measures single-sideband phase noise referenced to a 1 Hz bandwidth at 100 Hz, 1 kHz, 10 kHz, and 100 kHz offsets. The synthesizer RF output and the carrier noise test set IF output are phase locked to a reference oscillator. The IF output noise sidebands are measured on a spectrum analyzer.

This procedure must be performed for all synthesizer models.

Table 3-5. Offsets for HP 83711A/31A

Carrier Freq.	100 Hz	1 kHz	10 kHz	100 kHz
2 GHz	-66	-74	-91	-107
10 GHz	-69	-75	-79	-101
18 GHz	-63	-70	-73	-99

Table 3-6. Offsets for HP 83711B/31B

Carrier Freq.	100 Hz	1 kHz	10 kHz	100 kHz
1 GHz to <2 GHz	-73	-83	-92	-107
2 GHz to <5 GHz	-70	-78	-83	-100
5 GHz to <10 GHz	-69	-78	-82	-100
10 GHz to 20 GHz	-65	-73	-76	-100

Table 3-7. Offsets for HP 83712A/32A

Carrier Freq.	100 Hz	1 kHz	10 kHz	100 kHz
500 MHz	-70	-86	-103	-119
2 GHz	-66	-74	-91	-107
10 GHz	-69	-75	-79	-101
18 GHz	-69	-70	-73	-99

Table 3-8. Offsets for HP 83712B/32B

Carrier Freq.	100 Hz	1 kHz	10 kHz	100 kHz
500 MHz to <1 GHz	-78	-92	-103	-115
1 GHz to <2 GHz	-73	-83	-92	-107
2 GHz to <5 GHz	-70	-78	-83	-100
5 GHz to <10 GHz	-69	-78	-82	-100
10 GHz to 20 GHz	-65	-73	-76	-100

Recommended Equipment

HP 11729C Carrier Noise Test Set
HP 3561A Dynamic Signal Analyzer
HP 8662A Option 003 Synthesizer (Reference Oscillator)
HP 71210C Spectrum Analyzer

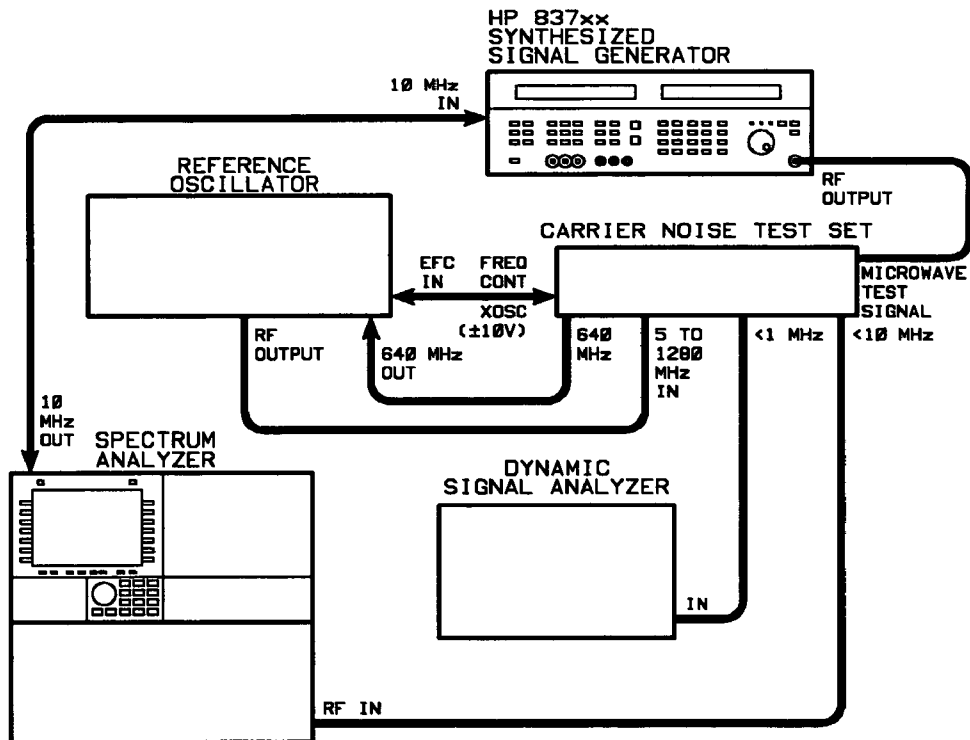

Figure 3-10. Single-Sideband Phase Noise Test Setup

To Set Up the Equipment

1. Set up the equipment as shown in Figure 3-10.
2. Preset the instruments and allow them to warm up for at least 1 hour.
3. On the dynamic signal analyzer, set:
 - Center frequency = 10 kHz
 - Frequency Span = 20 kHz
 - Averaging = Off
4. On the reference oscillator, set:
 - Frequency = 80 MHz
 - Power Level = 0 dBm
5. Set the synthesizer CW frequency to 2.0 GHz.
6. Set the synthesizer RF output level to +8 dBm.

To Set Up the Spectrum Analyzer and Carrier Noise Test Set

1. On the spectrum analyzer set:
 - Center Frequency = 10 kHz
 - Frequency Span = 20 kHz
 - Resolution Bandwidth = 300 Hz
 - Video Averaging = Off
2. On the carrier noise test set, set:
 - Bandpass Filter = 1.92 GHz
 - Lock BW Factor = 100

To Calibrate the System

1. Increase the synthesizer frequency by 10 kHz.
2. Decrease the reference oscillator amplitude by 40 dB.
3. On the dynamic signal analyzer, verify the presence of the beat note at approximately 10 kHz and record its level, V_b , in the performance test record.

The beat note is the reference level for subsequent phase noise measurements, and represents the frequency translated carrier reduced by 40 dB.

4. Set this peak to the top horizontal graticule.

For the dynamic signal analyzer, use the VERT SCALE, DEFINE FULL SCL, and MKR -> FULL SCL functions.

Note Do not change the vertical controls after establishing this reference.

5. Repeat the above calibration steps for the spectrum analyzer, and be certain to record V_b for the spectrum analyzer in the performance test record.

To Phase Lock the Sources

1. Return the synthesizer to its original setting (ie. from 2.00001 GHz to 2.00000 GHz) and the reference oscillator to 0 dBm.
2. Press CAPTURE on the Carrier Noise Test Set, and verify that the signals lock.
3. Reduce the Lock BW Factor to 10 Hz while making certain that the instruments remain phase locked.

To Measure Phase Noise at 100 Hz, 1 kHz, and 10 kHz Offsets

1. Set the dynamic signal analyzer display to single if it is not already.
2. Set the dynamic signal analyzer to a center frequency of 100 Hz and a span of 200 Hz.

Note It is not advisable to change the reference level after the system has been calibrated.

3. On the dynamic analyzer, place a marker on the center frequency.
4. Turn on rms averaging with 10 averages.

5. Note the level of the center frequency at the end of 10 averages, and record this level, V_s , in the performance test record of this book.
6. Convert the dynamic signal analyzer bandwidth to dB using $10\log BW$ as indicated in the performance test record chapter.
For instance, if the $BW = 0.750$ Hz, then $10\log BW = 1.25$ dB.
7. Repeat steps 1 through 6 at center frequencies of 1 kHz and 10 kHz.

To Calculate Phase Noise for a Dynamic Signal Analyzer

1. Calculate the phase noise of the synthesizer as follows:

$$\begin{aligned} \text{Phase Noise} = & V_s \text{ (from "To Measure Phase Noise")} \\ & - V_b \text{ (from "To Calibrate the System")} \\ & - 40 \text{ dB (for attenuation during calibration)} \\ & - 6 \text{ dB (conversion factor)} \\ & - 10\log \text{Bandwidth in Hz} \end{aligned}$$

For example:

Given: Frequency = 2 GHz at 100 Hz Offset, $V_s = -83.39$ dBm, $V_b = -46.70$, and Bandwidth = 1.9097 Hz.

$$\begin{aligned} \text{Phase Noise} = & - 83.39 \text{ dBm} \\ & - (-46.70) \text{ dBm} \\ & - 40.00 \text{ dB} \\ & - 6.00 \text{ dB} \\ & - 2.81 \text{ dB} \end{aligned}$$

$$\text{Phase Noise} = -85.50 \text{ dBc/Hz}$$

2. Record phase noise in the performance test record chapter of this book.

To Measure Phase Noise at 100 kHz Offset

1. Set the spectrum analyzer to a center frequency of 100 kHz, span of 200 Hz, and resolution bandwidth of 10 Hz.
2. Place a marker on the center frequency of the spectrum analyzer.
3. Turn on video averaging with 10 samples.
4. Note the level of the center frequency after at least 10 sweeps, V_s for the spectrum analyzer, and record it.

To Calculate Phase Noise for an Analog Spectrum Analyzer

1. Calculate the phase noise of the synthesizer as follows:

$$\begin{aligned} \text{Phase Noise} &= V_s \text{ (from "To Measure Phase Noise")} \\ &\quad - V_b \text{ (from "To Calibrate the System")} \\ &\quad - 40 \text{ dB (for attenuation during calibration)} \\ &\quad - 6.0 \text{ dB (conversion factor)} \\ &\quad - 10\log\text{Bandwidth in Hz} \\ &\quad + 2.5 \text{ dB (Analog Analyzer)} \end{aligned}$$

For example:

Given: Frequency = 2 GHz at 100 Hz Offset, Resolution BW = 10 Hz, $V_s = -67.60$ dBm, and $V_b = -6.40$

$$\begin{aligned} \text{Phase Noise} &= - 67.60 \text{ dBm} \\ &\quad - (-6.40) \text{ dBm} \\ &\quad - 40.00 \text{ dB} \\ &\quad - 6.0 \text{ dB} \\ &\quad - 10.00 \text{ dB} \\ &\quad + 2.5 \text{ dB} \end{aligned}$$

$$\text{Phase Noise} = -114.70 \text{ dBc/Hz}$$

2. Record phase noise in the performance test record chapter of this book.

To Check Single-Sideband Phase Noise at 10 GHz

1. Set the synthesizer CW frequency to 10 GHz.
2. Set the bandpass filter to 9.60 GHz.
3. Set the reference oscillator frequency to 400 MHz.
4. Repeat this entire procedure (from "To Set Up the Spectrum Analyzer and Carrier Noise Test Set") for a synthesizer frequency of 10 GHz.

The phase noise calculations are repeated here:

Dynamic Signal Analyzer Phase Noise Calculation

$$\begin{aligned} \text{Phase Noise} &= V_s \text{ (from "To Measure Phase Noise")} \\ &\quad - V_b \text{ (from "To Calibrate the System")} \\ &\quad - 40 \text{ dB (for attenuation during calibration)} \\ &\quad - 6 \text{ dB (conversion factor)} \\ &\quad - 10\log\text{Bandwidth in Hz} \end{aligned}$$

Spectrum Analyzer Phase Noise Calculation:

$$\begin{aligned} \text{Phase Noise} &= V_s \text{ (from "To Measure Phase Noise")} \\ &\quad - V_b \text{ (from "To Calibrate the System")} \\ &\quad - 40 \text{ dB (for attenuation during calibration)} \\ &\quad - 6.0 \text{ dB (conversion factor)} \\ &\quad - 10\log\text{Bandwidth in Hz} \\ &\quad + 2.5 \text{ dB (Analog Analyzer)} \end{aligned}$$

To Check Single-Sideband Phase Noise at 18 GHz

1. Set the synthesizer CW frequency to 18 GHz.
2. Set the bandpass filter to 17.28 GHz.
3. Set the reference oscillator frequency to 720 MHz.
4. Repeat this entire procedure (from "To Set Up the Spectrum Analyzer and Carrier Noise Test Set") for a synthesizer frequency of 18 GHz.

The phase noise calculations are repeated here:

Dynamic Signal Analyzer Phase Noise Calculation

$$\begin{aligned} \text{Phase Noise} = & V_s \text{ (from "To Measure Phase Noise")} \\ & - V_b \text{ (from "To Calibrate the System")} \\ & - 40 \text{ dB (for attenuation during calibration)} \\ & - 6 \text{ dB (conversion factor)} \\ & - 10\log\text{Bandwidth in Hz} \end{aligned}$$

Spectrum Analyzer Phase Noise Calculation

$$\begin{aligned} \text{Phase Noise} = & V_s \text{ (from "To Measure Phase Noise")} \\ & - V_b \text{ (from "To Calibrate the System")} \\ & - 40 \text{ dB (for attenuation during calibration)} \\ & - 6.0 \text{ dB (conversion factor)} \\ & - 10\log\text{Bandwidth in Hz} \\ & + 2.5 \text{ dB (Analog Analyzer)} \end{aligned}$$

To Check Single-Sideband Phase Noise at 500 MHz (HP 83712A/12B, HP 83732A/32B Only)

1. Set the synthesizer CW frequency to 500 MHz.
2. Select the 0.01 to 1.28 BAND RANGE on the Carrier Noise Test Set.
3. Set the reference oscillator frequency to 500 MHz.
4. Repeat this entire procedure (from "To Set Up the Spectrum Analyzer and Carrier Noise Test Set") for a synthesizer frequency of 500 MHz.

The phase noise calculations are repeated here:

Dynamic Signal Analyzer Phase Noise Calculation

$$\begin{aligned} \text{Phase Noise} = & V_s \text{ (from "To Measure Phase Noise")} \\ & - V_b \text{ (from "To Calibrate the System")} \\ & - 40 \text{ dB (for attenuation during calibration)} \\ & - 6 \text{ dB (conversion factor)} \\ & - 10\log\text{Bandwidth in Hz} \end{aligned}$$

Spectrum Analyzer Phase Noise Calculation

$$\begin{aligned} \text{Phase Noise} = & V_s \text{ (from "To Measure Phase Noise")} \\ & - V_b \text{ (from "To Calibrate the System")} \\ & - 40 \text{ dB (for attenuation during calibration)} \\ & - 6.0 \text{ dB (conversion factor)} \\ & - 10\log\text{Bandwidth in Hz} \\ & + 2.5 \text{ dB (Analog Analyzer)} \end{aligned}$$

If the Procedure Fails

- Verify the test setup and instrument settings.
- Check to see if spurious signals are present in the trace.

If spurious signals are present, they may exceed the phase noise specification and should be ignored.

Non-Harmonic Spurious Signals 3 kHz to 30 kHz

This test measures the non-harmonic spurious power level (known, fixed offset spurs) between 3 kHz and 30 kHz relative to the carrier power in dBc. The synthesizer is set to various CW frequencies where these spurious signals are likely to occur. The synthesizer RF output and the carrier noise test set IF output are phase locked to a reference oscillator. The IF output spurious response is measured on a dynamic signal analyzer.

This test must be performed for all instrument models.

Note Spurious response greater than 30 kHz is tested in a separate test.

Specification	Conditions
< -60 dBc	≥ 3 kHz

Recommended Equipment

- HP 11729C Carrier Noise Test Set
- HP 3561A Dynamic Signal Analyzer
- HP 8662A Option 003 Synthesizer (Reference Oscillator)
- HP 71210C Spectrum Analyzer

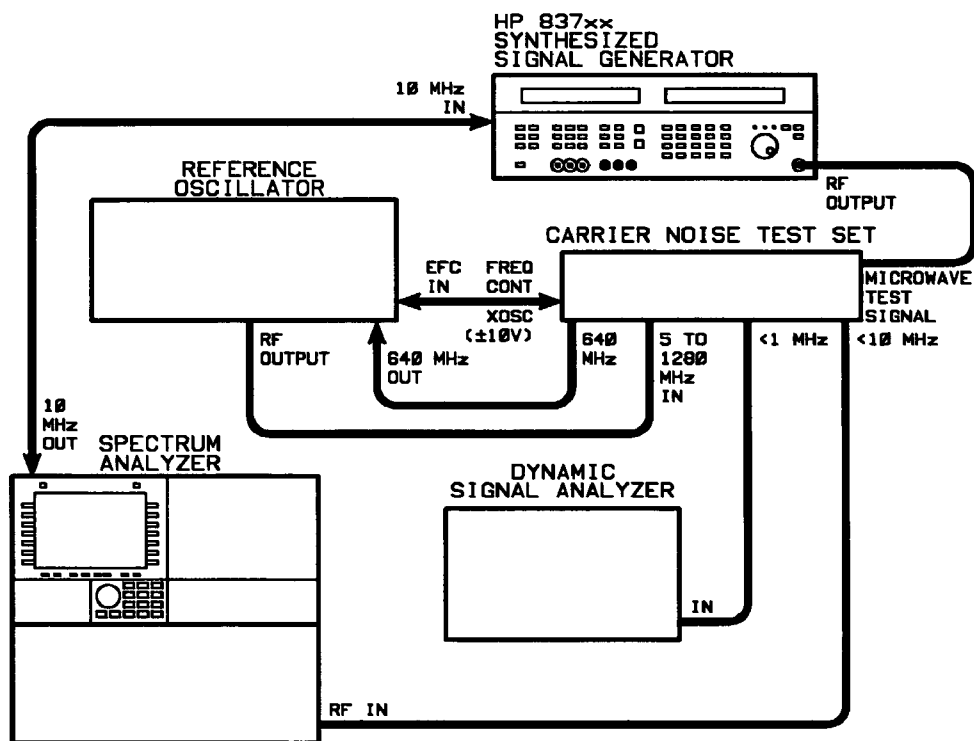

Figure 3-11. Non-Harmonic Spurious Level <30 kHz Test Setup

To Set Up the Equipment for 17.005111 GHz

1. Connect the equipment as shown in Figure 3-11.
2. Preset the instruments and allow them to warm up for at least 1 hour.
3. On the carrier noise test set, set:
Bandpass Filter = 17.28 GHz
Lock BW Factor = 100
4. On the dynamic signal analyzer, set:
Center Frequency = 10 kHz
Frequency Span = 20 kHz
5. On the reference oscillator, set:
Frequency = 274.889 MHz
Power Level = -40 dBm
6. Set the CW frequency on the synthesizer to 17.005121 GHz
7. Set the RF output level on the synthesizer as follows:

Model	Level Setting
HP 83711A/11B	+ 10 dBm
HP 83712A/12B	+ 10 dBm
HP 83731A/31B	+ 8 dBm
HP 83732A/32B	+ 8 dBm

To Calibrate the System

1. Verify the presence of the beat note (at approximately 10 kHz offset from the center frequency) on the dynamic signal analyzer and record the value, V_b , in the performance test record chapter of this book.
2. Set the beat note level to the top graticule line, and do not change the vertical scale.
The beat note is the reference level for subsequent measurements, and represents the frequency translated carrier reduced by 40 dB.

To Phase Lock the Sources

1. Reduce the synthesizer frequency by 10 kHz to 17.005111 GHz.
2. Set the reference oscillator level to 0.0 dBm.
3. Press CAPTURE on the Carrier Noise Test Set, and verify that the signals lock.
4. Reduce the Lock BW Factor to 10 Hz while making certain that the instruments remain phase locked.

To Measure Spurious Response at 17.005111 GHz

Note It is not advisable to change the reference level after the system has been calibrated.

1. Set the start frequency to 3 kHz and the span to 5 kHz on the dynamic signal analyzer.
2. Turn on averaging with number of averages equal to 10.
3. Place the marker on any spurious signal, and read the signal amplitude, V_s .

The signal or noise should be at least 14 dB below the top graticule on the dynamic signal analyzer.

4. If the signal is less than 14 dB below the top graticule line, decrease the span and observe the level again.

The span can be reduced in this manner until the bandwidth approaches 1 Hz.

Note Turn off video averaging after this procedure is complete.

5. Record the averaged signal (or noise level), V_s , in the performance test record chapter of this book.

To Calculate Actual Spurious Signal Level

1. Calculate the actual spurious level as follows:

$$\begin{aligned}\text{Corrected Level} &= - V_b \text{ (from "To Calibrate the System")} \text{ in dBm} \\ &\quad - 46.00 \text{ dB (correction)} \\ &\quad + V_s \text{ (Measured Level) in dBm}\end{aligned}$$

For example:

$$\begin{aligned}\text{Corrected Level} &= - (-47.20) \text{ dBm} \\ &\quad - 46.00 \text{ dB (correction)} \\ &\quad + (-63.81) \text{ dBm}\end{aligned}$$

$$\text{Corrected Level} = - 62.61 \text{ dBc}$$

2. If a spurious signal is displayed, record its actual level (corrected level) and frequency offset in the performance test record chapter of this book.
3. If the signal displayed is noise, record its actual level (corrected level) and the fact that it is noise in the performance test record.
4. Change the dynamic signal analyzer to the following frequency spans and repeat this procedure starting with "To Measure Spurious Response at 17.005111 GHz."

8 kHz to 13 kHz
13 kHz to 23 kHz
23 kHz to 33 kHz

Note Be sure to turn video averaging off before switching to a new span.

To Set Up and Calibrate the System for 17.501777 GHz

1. Set the Lock BW Factor on the carrier noise test set to 100.
2. Set the frequency of the reference oscillator to 221.777 MHz.
3. Set the CW frequency on the synthesizer to 17.501781 GHz.
4. Verify the presence of the beat note (at approximately 10 kHz offset from the center frequency) on the dynamic signal analyzer and record the value, V_b , in the performance test record chapter of this book.
5. Set the beat note level to the top graticule line, and do not change the vertical scale.
The beat note is the reference level for subsequent measurements, and represents the frequency translated carrier reduced by 40 dB.

To Phase Lock the Sources

1. Reduce the synthesizer frequency by 10 kHz to 17.501777 GHz.
2. Set the reference oscillator level to 0.0 dBm.
3. Press CAPTURE on the Carrier Noise Test Set, and verify that the signals lock.
4. Reduce the Lock BW Factor to 10 Hz while making certain that the instruments remain phase locked.

To Measure Spurious Response at 17.501777 GHz

Note It is not advisable to change the reference level after the system has been calibrated.

1. Set the start frequency to 3 kHz and the span to 5 kHz on the dynamic signal analyzer.
2. Turn on averaging with the number of averages equal to 10.
3. Place the marker on any spurious signal, read the signal amplitude, V_s , and record it in the performance test record chapter of this book.

The signal or noise should be at least 14 dB below the top graticule on the dynamic signal analyzer.

4. If the signal is less than 14 dB below the top graticule line, decrease the span and observe the level again.

The span can be reduced in this manner until the bandwidth approaches 1 Hz.

5. Calculate the actual spurious signal level in the performance test record chapter, and identify the signal as noise or record the frequency offset.
6. Change the dynamic signal analyzer to the following frequency spans and repeat this procedure starting with "To Measure Spurious Response at 17.501777 GHz."

8 kHz to 13 kHz
13 kHz to 23 kHz
23 kHz to 33 kHz

Note

Be sure to turn video averaging off before switching to a new span.

If the Procedure Fails

- Verify the test setup and instrument settings.

Non-Harmonic Spurious Signals >30 kHz

This test measures the non-harmonic spurious power level (known, fixed offset spurs) greater than 3 kHz relative to the carrier power in dBc. The synthesizer is set to various CW frequencies where these spurious signals are likely to occur. The spectrum analyzer is tuned to the spur frequencies so that their power level can be measured.

This test must be performed for all instrument models.

Note Spurious responses at offsets between 3 kHz and 30 kHz are tested in a separate test.

Specification	Conditions
< -60 dBc	>30 kHz

Recommended Equipment

HP 71210C Spectrum Analyzer

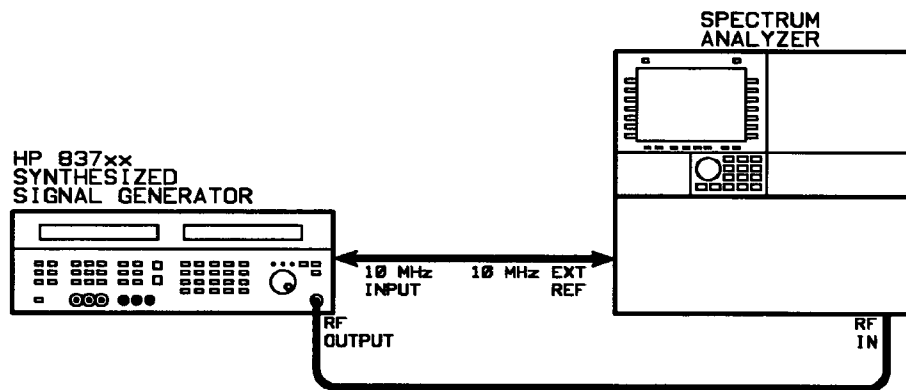

Figure 3-12. Non-Harmonic Spurious Level >30 kHz Test Setup

To Set Up the Equipment

1. Connect the equipment as shown in Figure 3-12.
2. Preset the synthesizer.
3. Set the CW frequency on the synthesizer to 17005.111 MHz
4. Set the RF output level on the synthesizer as follows:

Model	Level Setting
HP 83711A/11B	+ 10 dBm
HP 83712A/12B	+ 10 dBm
HP 83731A/31B	+ 8 dBm
HP 83732A/32B	+ 8 dBm

5. Setup the spectrum analyzer as follows:

Preset
Center Frequency = 17005.111 MHz
Frequency Span = 300 kHz
Reference Level = 10 dBm
Scale Log = 10 dB/div
Resolution Bandwidth = 300 Hz
Video Bandwidth = 300 Hz
Video Averaging = Off
Marker = On

To Check for Spurs from 1 to 20 GHz

1. On the spectrum analyzer, set the marker to the highest peak.
2. Set the spectrum analyzer reference level to the marker amplitude.
This puts the carrier peak on the top graticule.
3. Recheck the carrier peak amplitude, and adjust the reference level if necessary.
The reference level is now the carrier amplitude and all measurements at this center frequency are referenced to this level.
4. Examine the span for points that exceed the -60 dBc level (the sixth horizontal graticule from the top). Ignore the 2 center vertical graticules (± 30 kHz) because offsets that are close to the carrier are tested in another procedure.
5. If any frequencies exceed the -60 dBc limit, turn on video averaging, and set the number of averages to 10.
Do not reset the reference level.
6. If any frequencies still exceed the -60 dBc limit: turn video averaging off, reduce the resolution bandwidth, and after one trace is complete, turn video averaging back on.
Do not reset the reference level.
7. Calculate the relative spurious level in dBc and record this value in the test record chapter of this book:
$$\text{Spur Level(dBc)} = \text{Carrier Amptd(dBm)} - \text{Spur Amptd(dBm)}$$
8. Repeat this procedure for center frequencies of 17501.777 MHz and 19801.511 MHz.

To Check Spurs from 0.01 to 1 GHz (HP 83712A/12B, HP 83732A/32B Only)

1. Set the CW frequency on the synthesizer to 10 MHz.
2. Set the RF output level to +10 dBm.
3. Set the center frequency on the spectrum analyzer to 10 MHz.
4. Set the span on the spectrum analyzer to 800 kHz.
5. Set the spectrum analyzer marker to the highest peak.
6. Set the spectrum analyzer reference level to the marker amplitude.
7. Set the resolution bandwidth and the video bandwidth so that the noise floor is > -70 dBc.
8. Adjust the RBW and VBW so that the carrier skirt is less than 0.5 divisions (40 kHz) wide at -65 dBc.

9. Examine the span for points that exceed the -60 dBc level.

Note Ignore the carrier skirt when measuring spurs.

10. On the spectrum analyzer, set the center frequency as follows, and check each span for spurious signals that exceed -60 dBc.

8.74 MHz
11.26 MHz

11. If any frequencies exceed -60 dBc, turn on video averaging, and set the number of averages to 10.

Do not reset the reference level.

12. If any frequencies still exceed -60 dBc: turn video averaging off, reduce the resolution bandwidth, and after one trace is complete, turn video averaging back on.

Do not reset the reference level.

13. If any frequencies still exceed -60 dBc, reduce the span.

Do not reset the reference level.

14. Calculate the relative spurious level in dBc and record this value in the test record chapter of this book:

$$\text{Spur Level(dBc)} = \text{Carrier Amptd(dBm)} - \text{Spur Amptd(dBm)}$$

15. Follow the 13 steps above to check for spurious response >-60 dBc using the synthesizer CW Frequencies and spectrum analyzer center frequencies that follow.

CW Freq/ Center Freq for Reference	Center Freq for Spurs
63 MHz	61.74 MHz 64.26 MHz
499 MHz	497.74 MHz 500.26 MHz
500 MHz	498.74 MHz 501.74 MHz
999 MHz	997.74 MHz 1000.26 MHz

All spurious signals should be <-60 dBc.

If the Procedure Fails

- Verify the test setup and instrument settings.

Pulse On/Off Ratio (HP 83731A/31B and HP 83732A/32B Only)

This procedure verifies the pulse on/off specification of the HP 83731A/31B and HP 83732A/32B using a spectrum analyzer to measure RF output power with pulse on and then off. The difference in power levels is the pulse on/off ratio.

Table 3-9. HP 83731A/31B, HP 83732A/32B

Specification	Conditions
> 80 dB	none

Recommended Equipment

HP 71210C Spectrum Analyzer

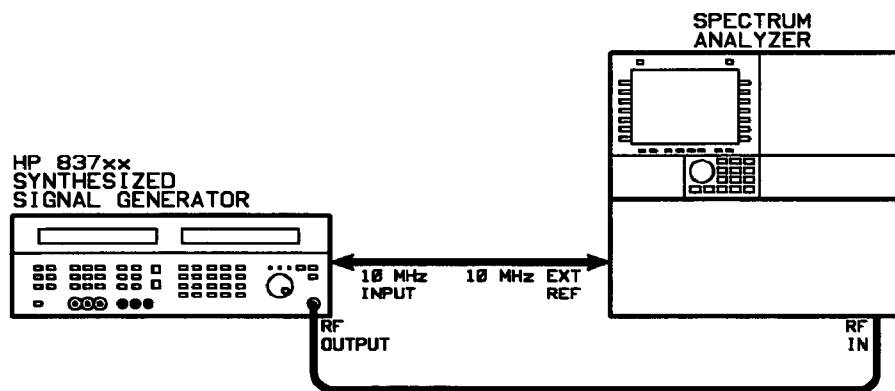

Figure 3-13. Pulse On/Off Ratio Test Setup

To Set Up the Equipment

1. Connect the equipment as shown in Figure 3-13.
2. Preset the synthesizer.
3. Set CW frequency on the synthesizer to 1 GHz.
4. Set RF output level on the synthesizer to -3.99 dBm.
5. To turn on inverted external pulse modulation, press **SHIFT** **EXT ON/OFF** so that the INVERT EXT annunciator is lit. This generates a pulse on condition.
6. On the spectrum analyzer, set:
 - Preset
 - Center Frequency = 1 GHz
 - Frequency Span = 100 Hz
 - Reference Level = -3.99 dBm
 - Resolution Bandwidth = 10 Hz

To Measure Pulse Modulation On/Off Ratio

1. Center the signal on the spectrum analyzer.
2. Place the peak of the signal on the top graticule line (the reference level).
3. To select normal (non-inverted) pulse modulation, press **EXT ON/OFF** so that the EXT annunciator is lit. This generates a pulse on condition.
4. Observe that any residual signal is more than 80 dB below the reference line on the spectrum analyzer. Record your observation in the performance test record chapter of this book.
5. Repeat this procedure for the following synthesizer CW frequencies:

Model	Frequency Settings
HP 83711A/11B	20 GHz
HP 83712A/12B	50 MHz 300 MHz 600 MHz 999 MHz 20 GHz
HP 83731A/31B	20 GHz
HP 83732A/32B	50 MHz 300 MHz 600 MHz 999 MHz 20 GHz

If the Procedure Fails

- Verify the test setup and instrument settings.
- Determine the actual power levels of both the pulse on and pulse off states using a marker on a spectrum analyzer, and subtract one from the other in order to manually calculate the pulse on/off ratio.

This calculated pulse on/off ratio should be greater than 80 dB.

Pulse Rise/Fall Time (HP 83731A/31B and HP 83732A/32B Only)

This test uses a digitizing oscilloscope to measure the HP 83731A/31B or HP 83732A/32B RF pulse rise and fall times.

Table 3-10. HP 83731A/31B

Specification	Conditions
<10 ns	none

Table 3-11. HP 83732A/32B

Specification	Conditions
< 500 ns	10-25 MHz
< 350 ns	25-64 MHz
< 50 ns	64-128 MHz
< 35 ns	128-500 MHz
< 20 ns	500-1000 MHz
<10 ns	1-20 GHz

Recommended Equipment

HP 54121T (HP 54120B with HP 54121A) 20 GHz Digitizing Oscilloscope
 HP 8116A Function Generator
 HP 8493C Option 020 20 dB Attenuator (2)

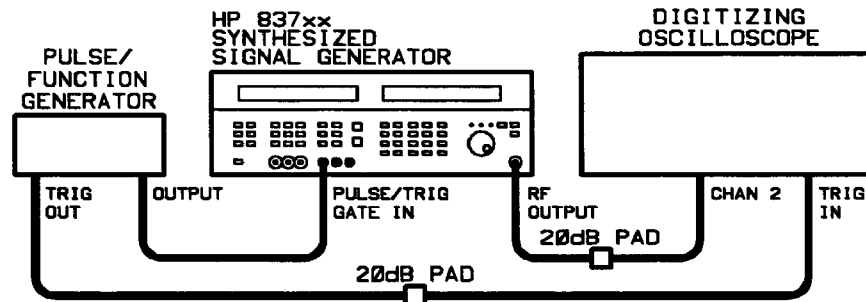

Figure 3-14. Pulse Rise/Fall Time Test Setup

To Set Up the Equipment

1. Connect the equipment as shown in Figure 3-14.
2. Preset the synthesizer.
3. Set the CW frequency of the synthesizer to 1.649999 GHz.
4. Set the RF output level of the synthesizer to -3.99 dBm.

5. Turn pulse modulation on.

On the pulse generator set:

Frequency = 500 kHz
Pulse Width = 1 μ sec
High Level = 3 V
Low Level = 0 V
Disable = Off (to enable pulse generator)

6. On the oscilloscope:

Press **AUTOSCALE**

Set **TIMEBASE** = 10 ns/div

Set **DELAY** so that rising edge of pulse is displayed

Set Display Persistence = 1 sec

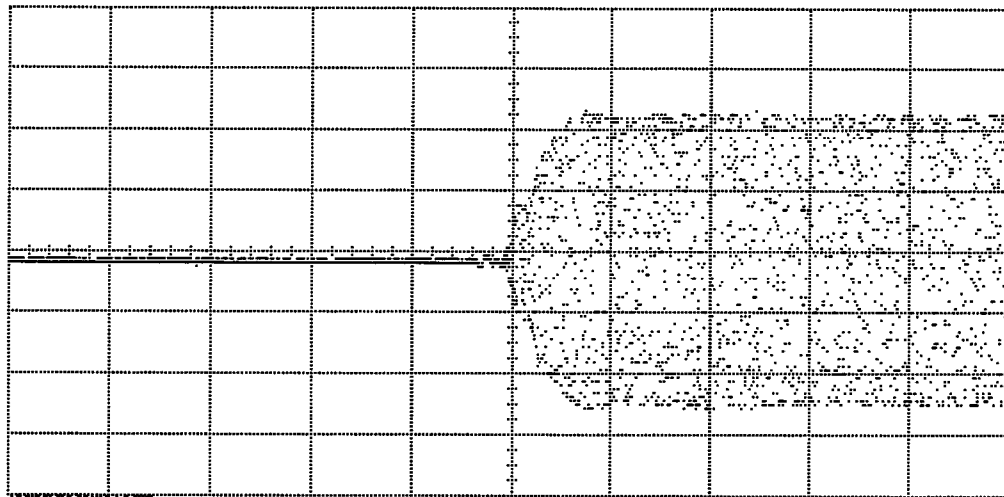

Figure 3-15. Pulse Rise Time Measurement

To Measure Rise Time

1. Adjust the synthesizer RF output level so that the upper half of the envelope spans 2.5 vertical graticules as in Figure 3-15.
2. Adjust the oscilloscope's horizontal DELAY and vertical OFFSET functions in order to position the rising edge of the pulsed RF so that the 10% and 90% points cross horizontal graticules. Refer to Figure 3-15.
3. Measure pulse rise time from 10% to 90% of the rising edge of the waveform using the graticules for reference.

The pulse rise time should be less than one division (<10 ns).

4. Record the measured value in the performance test record chapter.

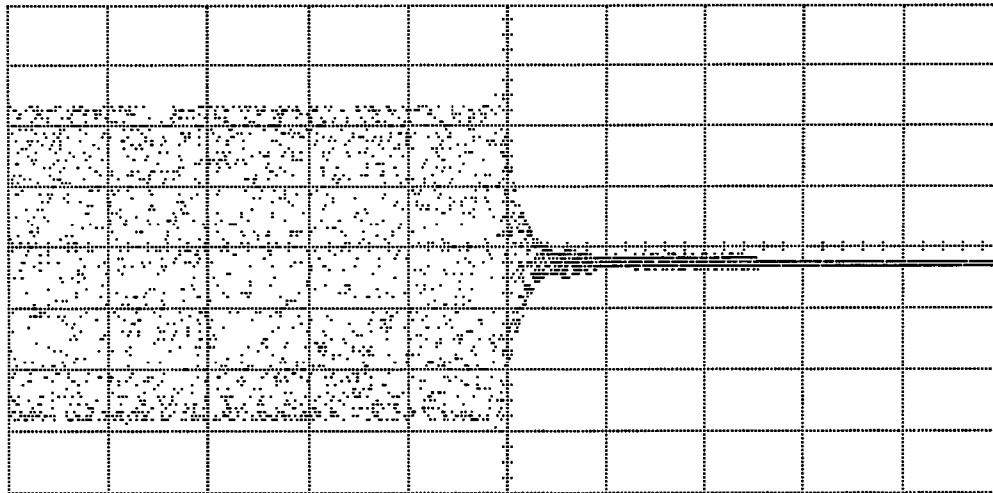

Figure 3-16. Pulse Fall Time Measurement

To Measure Fall Time

1. Adjust the DELAY on the oscilloscope so that the waveform falling edge is visible on the display.
2. Adjust the synthesizer RF output level so that the upper half of the envelope spans 2.5 vertical graticules as in Figure 3-16.
3. Adjust the oscilloscope's horizontal DELAY and vertical OFFSET functions in order to position the falling edge of the pulsed RF so that the 10% and 90% points cross horizontal graticules. Refer to Figure 3-16.
4. Measure pulse rise time from 10% to 90% of the falling edge of the waveform using the graticules for reference.

The pulse fall time should be less than one division (<10 ns).

5. Record the measured value in the performance test record chapter.

To Measure Rise/Fall Time for 0.01 to 1 GHz (HP 83732A/32B)

1. Using the following settings, measure rise times and fall times as in the procedures "To Measure Rise Time" and "To Measure Fall Time."

Synthesizer Frequency Setting	Oscilloscope Timebase Setting
10 MHz	500 ns/div
25 MHz	350 ns/div
64 MHz	50 ns/div
128 MHz	35 ns/div
500 MHz	20 ns/div

2. Record the measured values in the performance test record chapter.

If the Procedure Fails

- Review (verify) the test setup and equipment settings.

Pulse Width (HP 83731A/31B and HP 83732A/32B Only)

This procedure verifies the pulse width specification for the HP 83731A/31B or HP 83732A/32B by observing the pulsed RF output on a digitizing oscilloscope.

Table 3-12. HP 83731A/31B

Specification	Conditions
< 25 ns	none

Table 3-13. HP 83732A/32B

Specification	Conditions
< 1 μ s	0.01 - 0.064 GHz
< 100 ns	0.064 - 0.5 GHz
< 25 ns	0.5 - 20 GHz

Recommended Equipment

HP 54121T (HP 54120B and HP 54121A) 20 GHz Digitizing Oscilloscope
HP 8116A Function Generator
HP 8493C (Option 020) 20 dB Attenuator

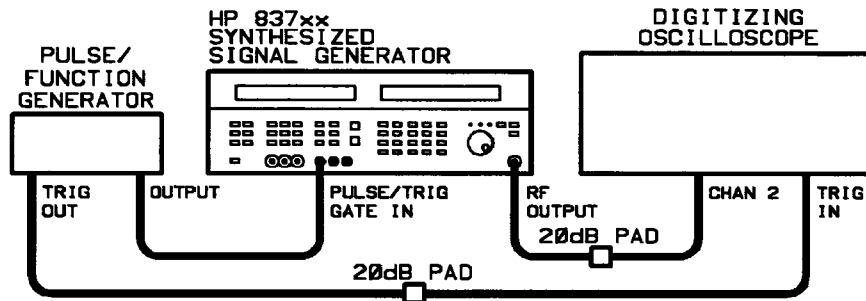

Figure 3-17. Pulse Width Test Setup

To Set Up the Equipment

1. Connect the equipment as shown in Figure 3-17.
2. Preset the synthesizer.
3. Set the RF output level on the synthesizer to -3.99 dBm.
4. Set the CW frequency on the synthesizer to 1 GHz.
5. Turn pulse modulation on.
6. On the pulse generator, set:
 - Frequency = 1 MHz (Period = 1 μ s)
 - Pulse Width = 24 ns
 - High Level = 3.0 V
 - Low Level = 0 V
 - Disable = Off (to enable pulse generator)

7. On the oscilloscope:

Press **AUTOSCALE**

Set Time/Div = 5 ns

Set **DELAY** so that 1 full pulse envelope is displayed

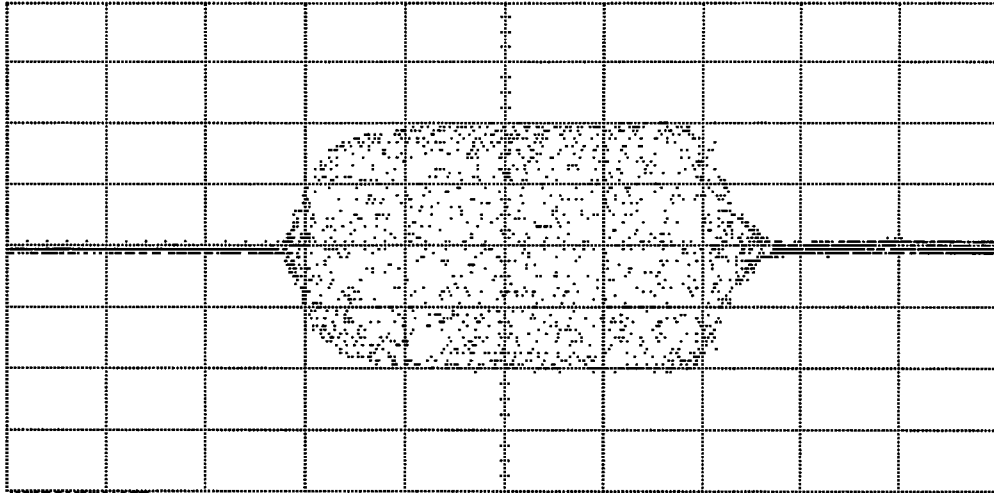

Figure 3-18. Pulse Width Measurement

To Measure Pulse Width

1. Adjust the synthesizer RF output level so that the upper half of the pulse envelope spans 2 vertical divisions.
2. Use the DELAY function on the oscilloscope to position the waveform to place the median of the rising edge on a vertical graticule. Refer to Figure 3-18.
3. Record the displayed pulse width in the performance test record chapter. (Pulse width is measured from the rising edge median to the falling edge median of the pulse.)

The pulse width should be <25 ns.

To Measure Pulse Width for 0.01 to 1 GHz (HP 83732A/32B)

1. Set the synthesizer to 10 MHz.
2. On the pulse generator:
 - Set pulse width to 950 ns.
 - Set pulse period to 2 μ s.
3. On the oscilloscope:
 - Press **AUTOSCALE**
 - Set Time/Div = 200 ns
 - Set DELAY so that 1 full pulse envelope is displayed
 - Set PERSISTENCE to 900 ms
4. Change the Oscilloscope display to single if it is not already.
5. Adjust the synthesizer RF output level so that the upper half of the pulse envelope spans 2 vertical divisions.

6. Use the DELAY function on the oscilloscope to position the waveform to place the median of the rising edge on a vertical graticule. Refer to Figure 3-18.
7. Record the displayed pulse width in the performance test record chapter. (Pulse width is measured from the rising edge median to the falling edge median of the pulse.)

The pulse width should be $<1 \mu\text{s}$.

8. Repeat steps 1 through 6 for the following synthesizer, oscilloscope, and pulse generator settings:

CW Frequency	Time/Div	Pulse Width	Pulse Period
64 MHz	20 ns	95 ns	200 ns
500 MHz	5 ns	24 ns	50 ns

The pulse width should be $<100 \text{ ns}$ for a 64 MHz carrier frequency and $<25 \text{ ns}$ for a 500 MHz carrier frequency.

If the Procedure Fails

- Review (verify) the test setup and equipment settings.
- If the pulse width on the oscilloscope is visible and greater than the specification, narrow the pulse generator pulse width until it is less than the specification. Note, when narrowing the pulse width be sure to maintain the pulse amplitude within 1 dB of the original amplitude.

Maximum FM Deviation (HP 83731A/31B and HP 83732A/32B, Only)

This procedure verifies the FM maximum deviation specification of the HP 83731A/31B or HP 83732A/32B.

Table 3-14. HP 83731A/31B

Specification	Conditions
≥10 MHz peak	2-20 GHz
>5 MHz peak	1-2 GHz

Table 3-15. HP 83732A/32B

Specification	Conditions
≥10 MHz peak	2-20 GHz
≥5 MHz peak	1-2 GHz
≥2.5 MHz peak	500 MHz - 1 GHz
>1.25 MHz peak	256 - 500 MHz

Recommended Equipment

HP 8116A Function Generator
HP 71210C Spectrum Analyzer

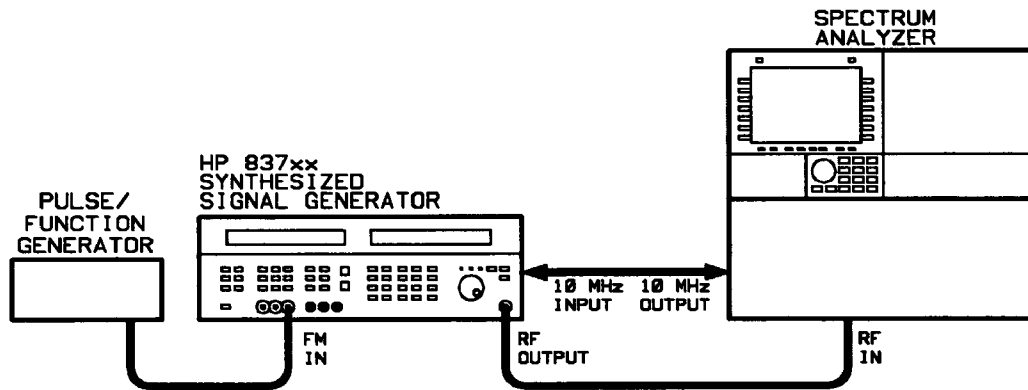
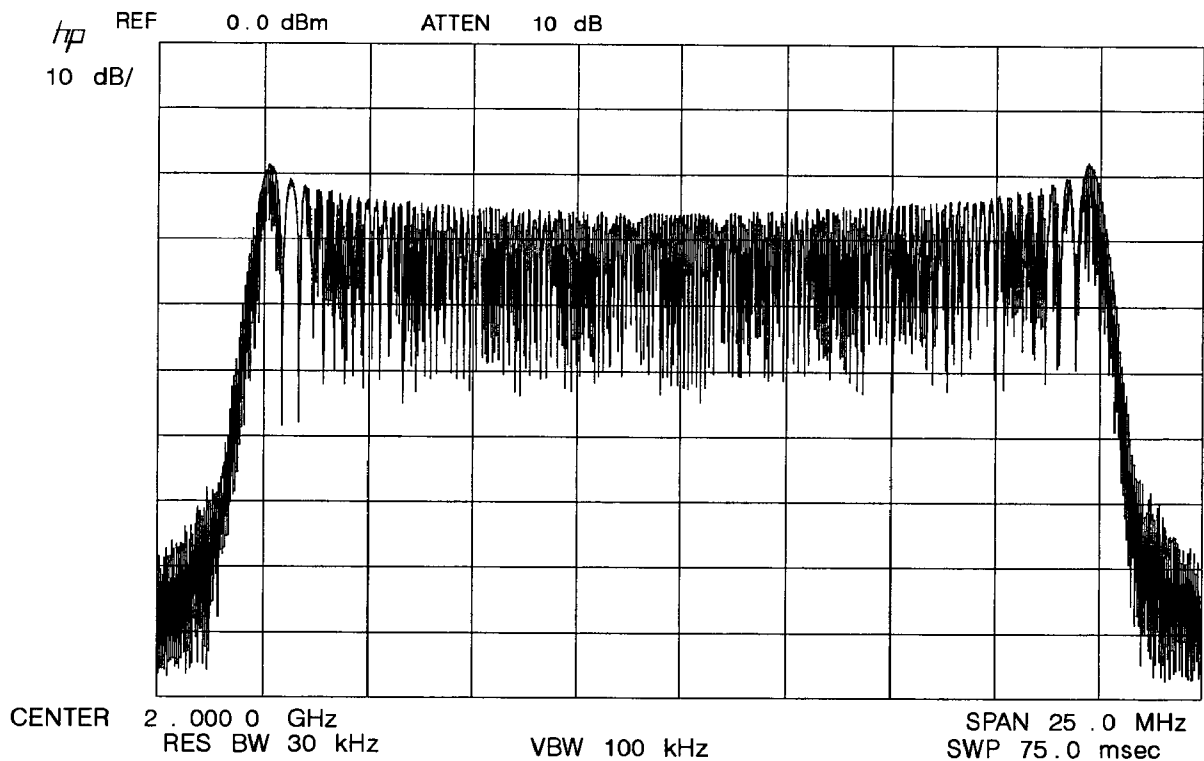

Figure 3-19. Maximum FM Deviation Test Setup

To Set Up the Equipment

1. Connect the equipment as shown in Figure 3-19.
2. Preset the synthesizer.
3. Set the CW frequency on the synthesizer to 2 GHz.
4. Set the RF output level on the synthesizer to 0 dBm.
5. Set the function generator as follows:
Frequency = 50 kHz
Level = 2 Vpk (1.4 Vrms)
6. Set up the spectrum analyzer as follows:
Frequency = 2 GHz
Span = 25 MHz
Resolution Bandwidth = as low as possible for reasonable output



wk614ab

Figure 3-20. Example Signal Spectrum that Passes Test

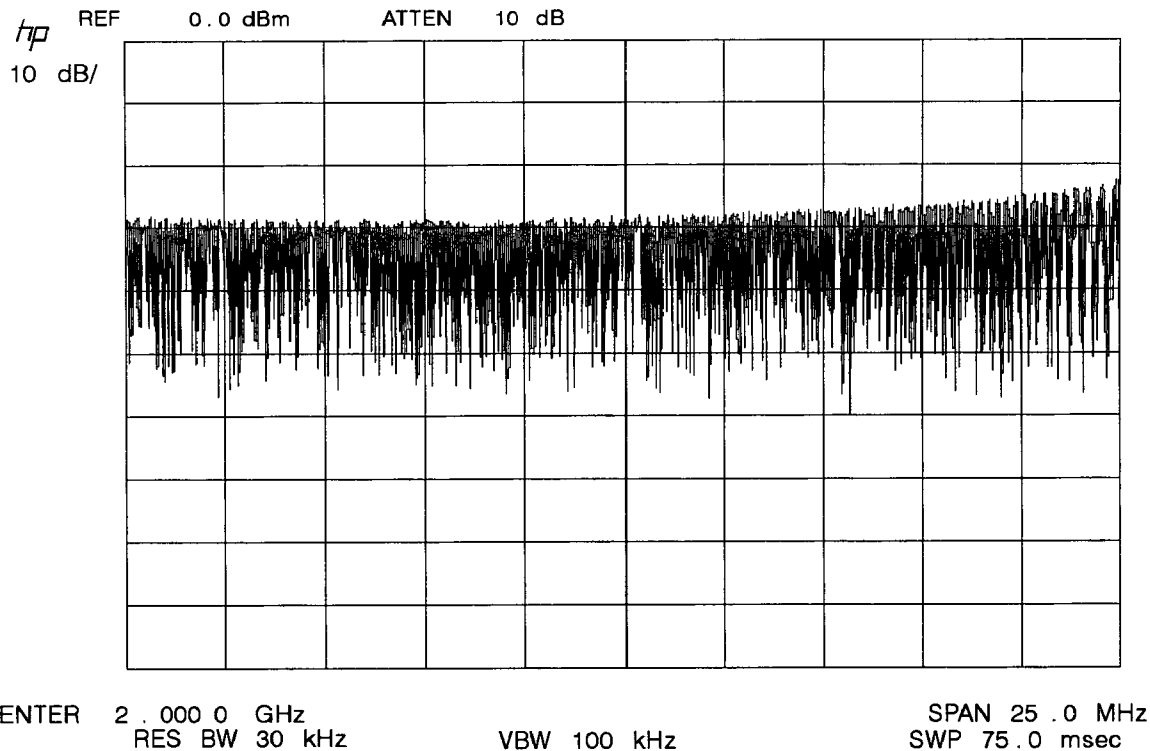

wk615ab

Figure 3-21. Example Signal Spectrum that Fails Test

To Verify 10 MHz Peak Deviation at 2 GHz

1. Verify that the error indicator is off. For the HP 83731A/31B, the error indicator is the LED labeled "MSG" that is above the knob.
2. Turn FM On on the synthesizer.
3. Change the function generator level so that the signal spectrum fills at least the 8 center vertical graticules of the spectrum analyzer display.

Refer to Figure 3-20 for a signal that covers 8 graticules.

4. Observe that the signal is symmetrical on the display.

Refer to Figure 3-20 for a signal which is symmetrical. Refer to Figure 3-21 for a signal which is asymmetrical and, thus, fails to meet the specification.

5. Check that the error indicator is not on.

The error indicator is located on the front panel of the synthesizer.

6. Record your observations in the performance test record chapter of this book.

To Verify 10 MHz Peak Deviation at 10 GHz

1. Set the synthesizer CW frequency to 10 GHz.
2. Set the spectrum analyzer center frequency to 10 GHz.
3. Change the function generator level so that the signal spectrum fills at least the 8 center vertical graticules of the spectrum analyzer display.

Refer to Figure 3-20 for a signal that covers 8 graticules. Note that the center frequency is different than that in the figure.

4. Observe that the signal is symmetrical on the display.

Refer to Figure 3-20 for a signal which is symmetrical. Refer to Figure 3-21 for a signal which is asymmetrical and, thus, fails to meet the specification.

5. Check that the error indicator is not on.
6. Record your observations in the performance test record chapter of this book.

To Verify 5 MHz Peak Deviation at 1 GHz

1. Set the synthesizer CW frequency to 1 GHz.
2. Set the spectrum analyzer center frequency to 1 GHz.
3. Set the spectrum analyzer span to 12.5 MHz.
4. Set the function generator level to 1 Vpk (.7 Vrms).
5. Change the function generator level so that the signal spectrum fills at least the 8 center vertical graticules of the spectrum analyzer display.

Refer to Figure 3-20 for a signal that covers 8 graticules. Note, however, that the span and center frequency are different from those in the figure.

6. Observe that the signal is symmetrical on the display.

Refer to Figure 3-20 for a signal which is symmetrical. Refer to Figure 3-21 for a signal which is asymmetrical and, thus, fails to meet the specification.

7. Check that the error indicator is not on.
8. Record your observations in the performance test record chapter of this book.

If the Procedure Fails

- Verify the test setup and instrument settings.

If the error indicator is on:

1. Check the Error Queue for the messages 712, Frequency loop went out of lock;(712) and 713, Possible FM overmodulation;(713).

If these messages appear, the FM Deviation test fails.

To check the error queue on the synthesizer:

Press the **MSG** key.

The most recent error message will be shown on the synthesizer display. If the **MSG** annunciator is still lit, successive presses of the **MSG** key will display any other messages in the queue.

FM Rate and Flatness (HP 83731A/31B and HP 83732A/32B, Only)

This test measures variations in the HP 83731A/31B or HP 83732A/32B synthesizer's FM sensitivity across the FM band. Measurements are made at 6 and 18 GHz.

Specification	Conditions
4 dB p-p	@ 1 kHz, 5 kHz, 100 kHz, and 1 MHz rates

Recommended Equipment

HP 71210C Spectrum Analyzer
 HP 5343A Option 001 Microwave Frequency Counter
 HP 3458A Voltmeter
 HP 8116A Function Generator
 20 dB BNC Attenuator (2)
 6 dB BNC Attenuator

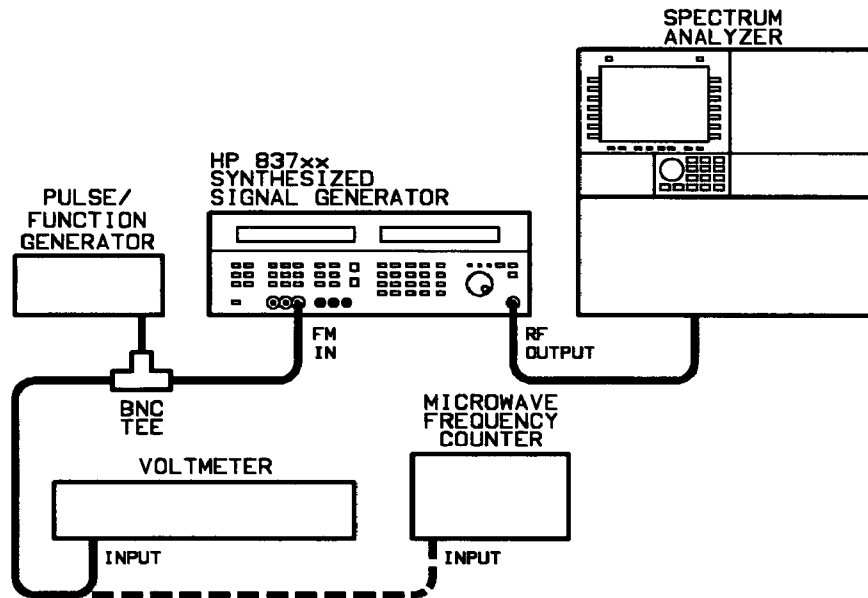

Figure 3-22. FM Rate and Flatness Test Setup

To Set Up the Equipment

1. Connect the equipment as shown in Figure 3-22.
2. Preset the synthesizer.
3. Set the CW frequency of the synthesizer to 6 GHz.
4. Set the RF output level of the synthesizer to 0 dBm.
5. Turn FM on.

6. Set the spectrum analyzer as follows:

Preset
Center Frequency = 6 GHz
Span = 1 MHz

7. Set the function generator as follows:

Waveform = sinewave
Frequency = 100 kHz
Voltage = 10 mV
output = not disabled

To Find the 100 kHz Reference 1st Sideband Nulls

1. Verify the function generator frequency with the frequency counter, and record the measured frequency.
2. Slowly increase the voltage on the function generator until the first sideband ($F_c \pm F_m$) nulls.

If the upper and lower sideband null at different voltages, record the average voltage between them. This reference voltage measured at 100 kHz should be around 54 mVrms.
3. Record the AC voltage indicated on the voltmeter in the performance test record chapter of this book.
4. Continue to increase the function generator voltage until you find the 4th time the first sideband nulls.

If the upper and lower sideband null at different voltages, record the average voltage between them. This reference voltage measured at 100 kHz should be about 200 mVrms.
5. Record the AC voltage indicated on the voltmeter in the performance test record chapter of this book.

Note Use as much attenuation as possible (40 dB) on the output of the function generator in order to improve resolution.

To Find the 1st Sideband Null for a 1 kHz Rate

1. Tune the function generator to 1 kHz.
2. Measure the function generator frequency with the frequency counter, and record the measured frequency.
3. Set the spectrum analyzer span to 10 kHz.
4. Reduce the function generator output level to 0.5 mVrms.
5. Adjust the function generator output voltage to obtain the first sideband null.

If the upper and lower sideband null at different voltages, record the average voltage between them. The level should be about 0.7 mVrms.
6. Record the measured voltage in the performance test record.

Note Use as much attenuation as possible (40 dB) on the output of the function generator in order to improve resolution.

To Find the 1st Sideband Null for a 5 kHz Rate

1. Tune the function generator to 5 kHz, measure the function generator frequency with the frequency counter, and record the value in the performance test record.
2. Reduce the function generator output level to 1 mVrms.
3. Set the spectrum analyzer span to 50 kHz.
4. Adjust the function generator's output voltage to obtain the fourth time the first sideband nulls.

If the upper and lower sideband null at different voltages, record the average voltage between them. The level should be about 10 mVrms. (Nulls will occur about every 2 mVrms.)

5. Record the measured voltage in the performance test record.

Note Use as much attenuation as possible (40 dB) on the output of the function generator in order to improve resolution.

To Find the 1st Sideband Null for a 1 MHz Rate

1. Tune the function generator to 1 MHz, measure the function generator frequency with the frequency counter, and record the value in the performance test record.
2. Set the spectrum analyzer span to 10 MHz.
3. Set the function generator level to 10 mVrms.
4. Replace the 20 dB attenuators with a 6 dB attenuator in the test setup.
5. Slowly increase the function generator level until you find the 1st sideband null.

If the upper and lower sideband null at different voltages, record the average voltage between them. The level should be about 700 mVrms.

6. Record the AC voltage indicated on the voltmeter in the performance test record chapter of this book.

To Calculate the Relative FM frequency response:

1. Solve the following equation 3 times using:
 - a. first, the 1 kHz 1st null and the 100 kHz 1st null.
 - b. second, the 5 kHz 4th null and the 100 kHz 4th null.
 - c. third, the 1 MHz 1st null and the 100 kHz 1st null.

Note

Be certain that you have measured the correct nulls. If the nulls are correct, the following relationships hold:

- a. The 1 kHz 1st null measured voltage is approximately 100 times less than the 100 kHz 1st null.
 - b. The 5 kHz 4th null measured voltage is approximately 20 times less than the 100kHz 4th null.
 - c. The 1 MHz 1st null measured voltage is approximately 10 times greater than the 100 kHz 1st null.
-

$$dB = 20\log \frac{V_x}{V_{100kHz}} - 20\log \frac{f_x}{f_{100kHz}}$$

where dB = the calculated frequency response

V_x = the voltage at the measured frequency

V_{100kHz} = the reference voltage measured at 100 kHz setting

f_x = the measured frequency

f_{100kHz} = the reference frequency measured at 100 kHz setting

2. Record the 3 calculated relative responses in the performance test record chapter of this book.
3. Repeat this entire procedure for a synthesizer CW frequency of 18 GHz.

To Calculate FM Flatness

1. Determine the recorded maximum value and the minimum value of frequency response, dB, for a CW frequency of 6 GHz.
2. If one response is negative and the other positive, record the sum of the two in the performance test record chapter of this book.

The flatness should be less than 4 dB.
3. If both responses are positive or both are negative, record the worst case response in the performance test record.

The flatness should be less than 4 dB.
4. Determine the recorded maximum value and the minimum value of frequency response, dB, for a CW frequency of 18 GHz.
5. If one response is negative and the other positive, record the sum of the two in the performance test record chapter of this book.

The flatness should be less than 4 dB.

6. If both responses are positive or both are negative, record the worst case response in the performance test record.

The flatness should be less than 4 dB.

If the Procedure Fails

- Verify the test setup and instrument settings.

Phase Modulation (ϕ M) Flatness (HP 83731B/32B Option 800 Only)

This test measures variations in the HP 83731B or HP 83732B synthesizer's ϕ M sensitivity across the ϕ M band. Measurements are made at 6 and 18 GHz.

Range	Specification	Conditions
1 rad/V	2 dB	@ 1 kHz, 20 kHz, and 100 kHz
50 rad/V	4 dB	@ 100 Hz, 1 kHz, and 30 kHz

Recommended Equipment

HP 8566B Spectrum Analyzer
 HP 5343A Option 001 Microwave Frequency Counter
 HP 3458A Voltmeter
 HP 8116A Function Generator
 20 dB BNC Attenuator (2)
 6 dB BNC Attenuator

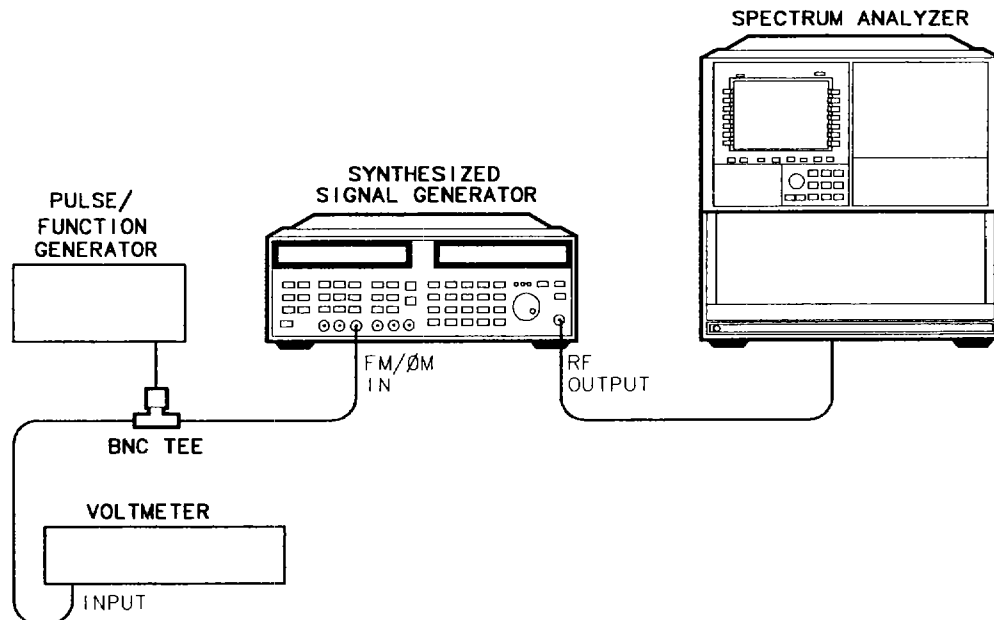

wk6.3ab

Figure 3-23. ϕ M Flatness Test Setup

To Set Up the Equipment

1. Connect the equipment as shown in Figure 3-22.
2. Preset the synthesizer.
3. Set the CW frequency of the synthesizer to 6 GHz.
4. Set the RF output level of the synthesizer to 0 dBm.
5. Turn ϕM on, then select 1 rad/V.
6. Set the spectrum analyzer as follows:

Preset
Center Frequency = 6 GHz
Span = 10 kHz

7. Set the function generator as follows:

Waveform = sinewave
Frequency = 1 kHz
Voltage = 0.353 mVrms
output = not disabled

To Find the 1 kHz Reference Carrier Null

1. Verify the function generator frequency with the frequency counter.
2. Slowly increase the voltage on the function generator until the 1st carrier null.
This reference voltage measured at 1 kHz should be around 1.69 Vrms.
3. Record the AC voltage indicated on the voltmeter in the performance test record chapter of this book.

To Find the Carrier Null for a 20 kHz Rate

1. Tune the function generator to 20 kHz.
2. Verify the function generator frequency with the frequency counter.
3. Set the spectrum analyzer span to 200 kHz.
4. Reduce the function generator output level to 100 mVrms.
5. Adjust the function generator output voltage to obtain the carrier null.

The level should be about 1.67 Vrms.

6. Record the measured voltage in the performance test record.

To Find the Carrier Null for a 100 kHz Rate

1. Tune the function generator to 100 kHz, verify the function generator frequency with the frequency counter.
2. Reduce the function generator output level to 100 mVrms.
3. Set the spectrum analyzer span to 1 MHz.
4. Adjust the function generator's output voltage to obtain the carrier null.

The level should be about 1.68 Vrms.

- Record the measured voltage in the performance test record.

To Calculate the Relative ϕM frequency response:

- Solve the following equation 3 times using:
 - first, the 20 kHz 1st null.
 - second, the 100 kHz 1st null.

$$dB = 20 \log \frac{V_x}{V_{1kHz}}$$

where dB = the calculated frequency response
 V_x = the voltage at the measured frequency
 V_{1kHz} = the reference voltage measured at 1 kHz setting

- Record the 2 calculated relative responses in the performance test record chapter of this book.
- Repeat this entire procedure for a synthesizer CW frequency of 18 GHz.
The flatness should be less than 2 dB.
- Select 50 rad/V, then repeat this entire procedure for CW frequencies of 6 GHz and 18 GHz and modulation frequencies of 100 Hz, 1 KHz, and 30 kHz.
- Calculate the ϕM flatness at 50 rad/V range referenced at 100 Hz:

$$dB = 20 \log \frac{V_x}{V_{100Hz}}$$

where dB = the calculated frequency response
 V_x = the voltage at the measured frequency
 V_{100Hz} = the reference voltage measured at 100 Hz setting

The flatness should be less than 4 dB.

Note Use as much attenuation as possible (40 dB) on the output of the function generator in order to improve resolution.

To Calculate ϕM Flatness

- Determine the recorded maximum value and the minimum value of frequency response, dB, for a CW frequency of 6 GHz.
- If one response is negative and the other positive, record the sum of the two in the performance test record chapter of this book.
The flatness should be less than 2 dB for 1 rad/V.
The flatness should be less than 4 dB for 50 rad/V.
- If both responses are positive or both are negative, record the worst case response in the performance test record.
The flatness should be less than 2 dB for 1 rad/V.
The flatness should be less than 4 dB for 50 rad/V.
- Determine the recorded maximum value and the minimum value of frequency response, dB, for a CW frequency of 18 GHz.

5. If one response is negative and the other positive, record the sum of the two in the performance test record chapter of this book.
The flatness should be less than 2 dB for 1 rad/V.
The flatness should be less than 4 dB for 50 rad/V.
6. If both responses are positive or both are negative, record the worst case response in the performance test record.
The flatness should be less than 2 dB for 1 rad/V.
The flatness should be less than 4 dB for 50 rad/V.

If the Procedure Fails

- Verify the test setup and instrument settings.

Minimum Log AM Depth (HP 83731A/31B and HP 83732A/32B, Only)

This procedure verifies the log AM depth specification of the HP 83731A/31B or HP 83732A/32B by inputting a minimum of 7 Vdc into the EXT AM connector. A spectrum analyzer is used to verify that, when LOG AM is turned on, the RF output signal drops at least 60 dB.

Specification	Conditions
> 60 dB	none

Recommended Equipment

HP 71210C Spectrum Analyzer
HP 8116A Function Generator
HP 3456A Voltmeter

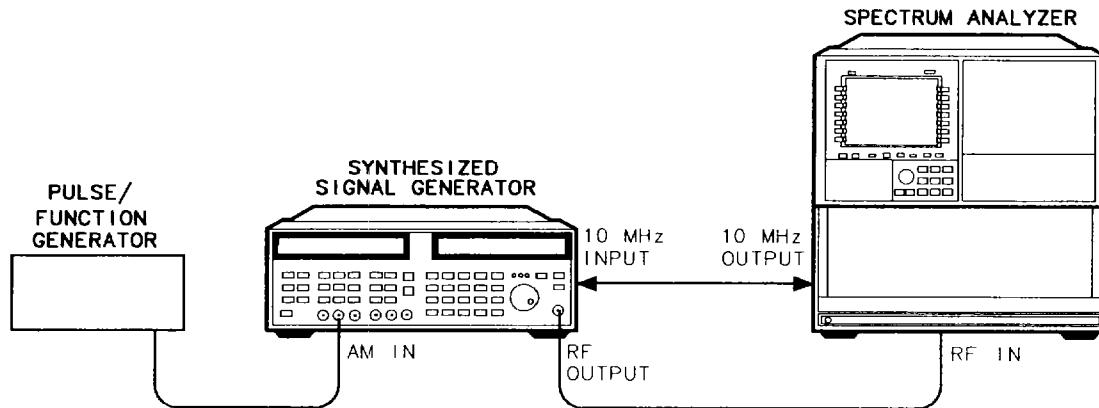

wk61ab

Figure 3-24. Minimum AM Depth Test Setup

To Set Up the Equipment

1. Preset the synthesizer.
2. Set the CW frequency on the synthesizer to:
 - HP 83731A/31B: 1 GHz
 - HP 83732A/32B: 10 MHz
3. Set the RF output level on the synthesizer to 0 dBm.
4. Set the function generator as follows:
 - Waveforms = off
 - Offset = 3.5 Vdc
 - Disable = off (to enable output)
5. Verify that the function generator output is 7 Vdc using a voltmeter.
6. Connect the equipment as shown in Figure 3-24.

7. Set up the spectrum analyzer as follows:

Frequency:

HP 83731A/31B: 1 GHz

HP 83732A/32B: 10 MHz

Span = 500 Hz

Input Attenuation = 10 dB

Reference Level = 0 dBm

Resolution Bandwidth = 10 Hz

To Measure AM depth

1. Adjust the spectrum analyzer controls to set the signal peak on the top graticule line (the reference level).
2. Turn the synthesizer log AM function on.
3. Observe that the signal peak on the spectrum analyzer drops to about the -60 dB line.
4. Record your observations in the performance test record.

If the Procedure Fails

- Verify the test setup and instrument settings.
- Determine the actual power levels of both the AM on and AM off states using a marker on a spectrum analyzer, and subtract one from the other in order to manually calculate the AM depth.
- Increase the function generator output to 10 Vdc and repeat the test procedure.

This calculated AM depth should be greater than 60 dB.

Minimum Linear AM Depth (HP 83731B and HP 83732B, Only)

This procedure verifies the linear AM depth specification of the HP 83731B or HP 83732B by inputting -1 Vdc into the EXT AM connector. A spectrum analyzer is used to verify that, when LIN AM is turned on at 100%/V, the RF output signal drops at least 20 dB (or 90%).

Specification	Conditions
> 20 dB	none

Recommended Equipment

HP 8566B Spectrum Analyzer
HP 8116A Function Generator
HP 3456A Voltmeter

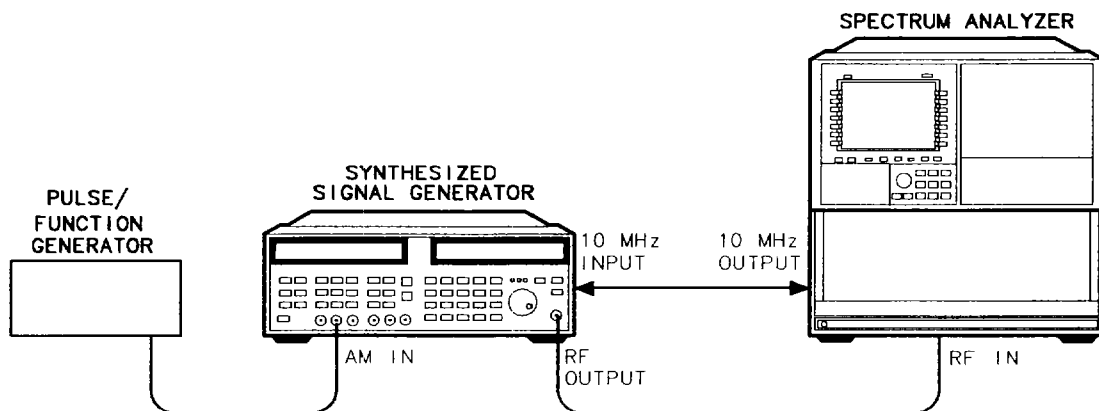

wk61ab

Figure 3-25. Minimum Linear AM Depth Test Setup

To Set Up the Equipment

1. Preset the synthesizer.
2. Set the CW frequency on the synthesizer to:
HP 83731B: 1 GHz
HP 83732B: 10 MHz
3. Set the RF output level on the synthesizer to 0 dBm.
4. Set the function generator as follows:
Waveforms = off
Offset = -0.5 Vdc
Disable = off (to enable output)
5. Verify that the function generator output is -1 Vdc using a voltmeter.
6. Connect the equipment as shown in Figure 3-24.

7. Set up the spectrum analyzer as follows:

Frequency:

HP 83731B: 1 GHz

HP 83732B: 10 MHz

Span = 500 Hz

Input Attenuation = 10 dB

Reference Level = 0 dBm

Resolution Bandwidth = 10 Hz

To Measure AM depth

1. Adjust the spectrum analyzer controls to set the signal peak on the top graticule line (the reference level).
2. Turn the synthesizer ext lin AM function on, then select 100%/V.
3. Observe that the signal peak on the spectrum analyzer drops at least 20 dB.
4. Record your observations in the performance test record.

If the Procedure Fails

- Verify the test setup and instrument settings.
- Determine the actual power levels of both the AM on and AM off states using a marker on a spectrum analyzer, and subtract one from the other in order to manually calculate the AM depth.
- Set the function generator output to -1 Vdc and repeat the test procedure.

This calculated AM depth should be greater than 20 dB.

Internal AM Rate (HP 83731A/32A and HP 83731B/32B Option 1E2 Only)

This procedure verifies the internal log AM rate specification of the HP 83731A/32A and HP 83731B/32B Option 1E2 by viewing the amplitude modulated output of the synthesizer on a spectrum analyzer at a 0.5 Hz and 20 kHz rate.

Specification	Conditions
0.5 Hz - 20 kHz	none

Recommended Equipment

HP 71210C Spectrum Analyzer

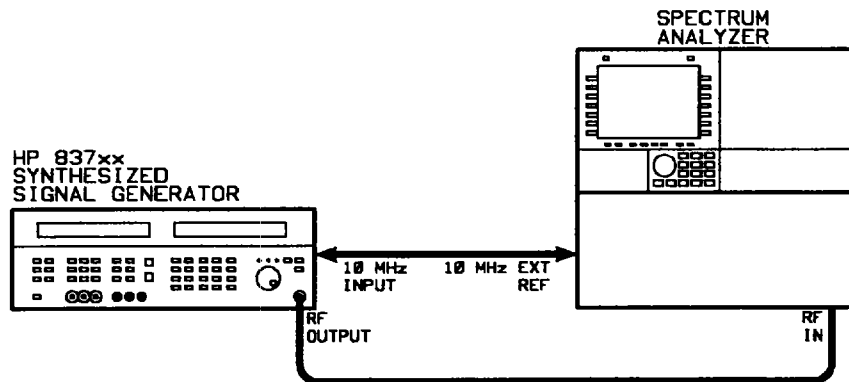

Figure 3-26. Internal AM Rate Test Setup

To Set Up the Equipment

1. Preset the synthesizer.
2. Turn internal AM on by pressing the **(INT ON)** key under "AM."
3. Set up the synthesizer as follows:
 - Frequency = 10 GHz
 - RF output = +0 dBm
 - Internal AM Depth = 30 dB
 - Internal AM Rate = 0.5 Hz
4. Connect the equipment as shown in Figure 3-26.
5. Set up the spectrum analyzer as follows:
 - Center Frequency = 10 GHz
 - Span = 0 Hz
 - Reference Level = +5 dBm
 - Sweep Time = 4 s
 - Resolution Bandwidth = 300 Hz
 - Video Bandwidth = 300 Hz

To Measure Internal AM Rate

1. Allow the spectrum analyzer to complete one sweep, then put it in view mode.
2. Enable markers and set the marker to one of the peaks of the signal on the display.
3. Enable the delta marker function and set the delta marker to the first peak to occur to the right on the display.
4. Read the delta marker value from the spectrum analyzer display. The inverse of the delta marker value is the AM rate. The AM rate value should be $0.5 \text{ Hz} \pm 0.1 \text{ Hz}$. Record your observation in the performance test record.
5. Set AM rate on the synthesizer to 20 kHz.
6. Turn view mode off on the spectrum analyzer.
7. On the synthesizer, change the internal AM depth to 2 dB.
8. Change the following spectrum analyzer parameters:
 - Span = 50 kHz
 - Resolution Bandwidth = 300 Hz
 - Video Bandwidth = 300 Hz
9. On the spectrum analyzer, enable markers and set the marker to the peak of the carrier shown on the display.
10. Enable the delta marker function and set the delta marker to the peak of the closer of the two sidebands shown on the display.
11. Read the delta marker value from the spectrum analyzer display. The delta marker value should be $20 \text{ kHz} \pm 0.2 \text{ kHz}$. Record your observation in the test record.

If the Procedure Fails

- Verify the test setup and instrument settings.

Internal FM Source Verification (HP 83731A/32A and HP 83731B/32B Option 1E2 Only)

This procedure verifies that the internal FM source is functioning correctly. In this procedure, the internal FM source is set for 10 MHz peak deviation at an FM rate of 100 kHz with a carrier frequency of 10 GHz. The resulting signal is viewed on a spectrum analyzer.

Recommended Equipment

HP 71210C Spectrum Analyzer

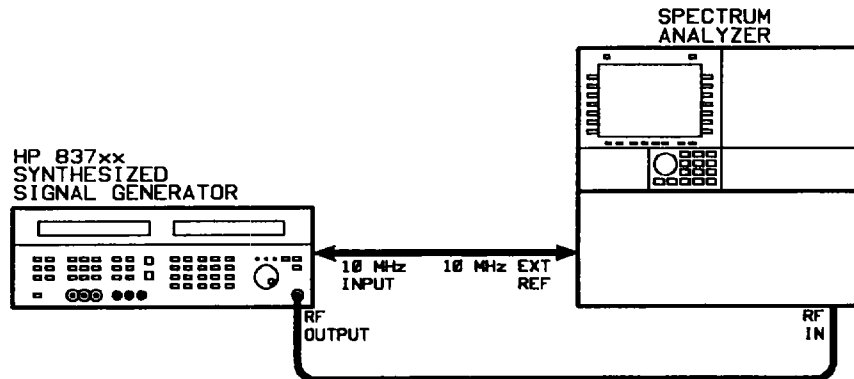

Figure 3-27. Internal FM Source Verification Test Setup

To Set Up the Equipment

1. Connect the equipment as shown in Figure 3-27.
2. Preset the synthesizer.
3. Turn internal FM on by pressing the **(INT ON)** key under "FM."
4. Set the CW frequency on the synthesizer to 10 GHz.
5. Set the RF output level on the synthesizer to 0 dBm.
6. Set the internal FM rate on the synthesizer to 100 kHz.
7. Set the internal FM deviation on the synthesizer to 10 MHz.
8. Set up the spectrum analyzer as follows:
 - Center Frequency = 10 GHz
 - Span = 25 MHz
 - Reference Level = 0 dBm
 - Resolution Bandwidth = as low as possible for reasonable output

To Verify the Internal FM Source

1. Observe that the signal is symmetrical and covers at least 8 graticules on the display.

Refer to Figure 3-28 for an example of a signal which passes this test. Refer to Figure 3-29 for an example of a signal which fails this test.

2. Check that the error indicator is not on.
3. Record the pass/fail test status in the performance test record.

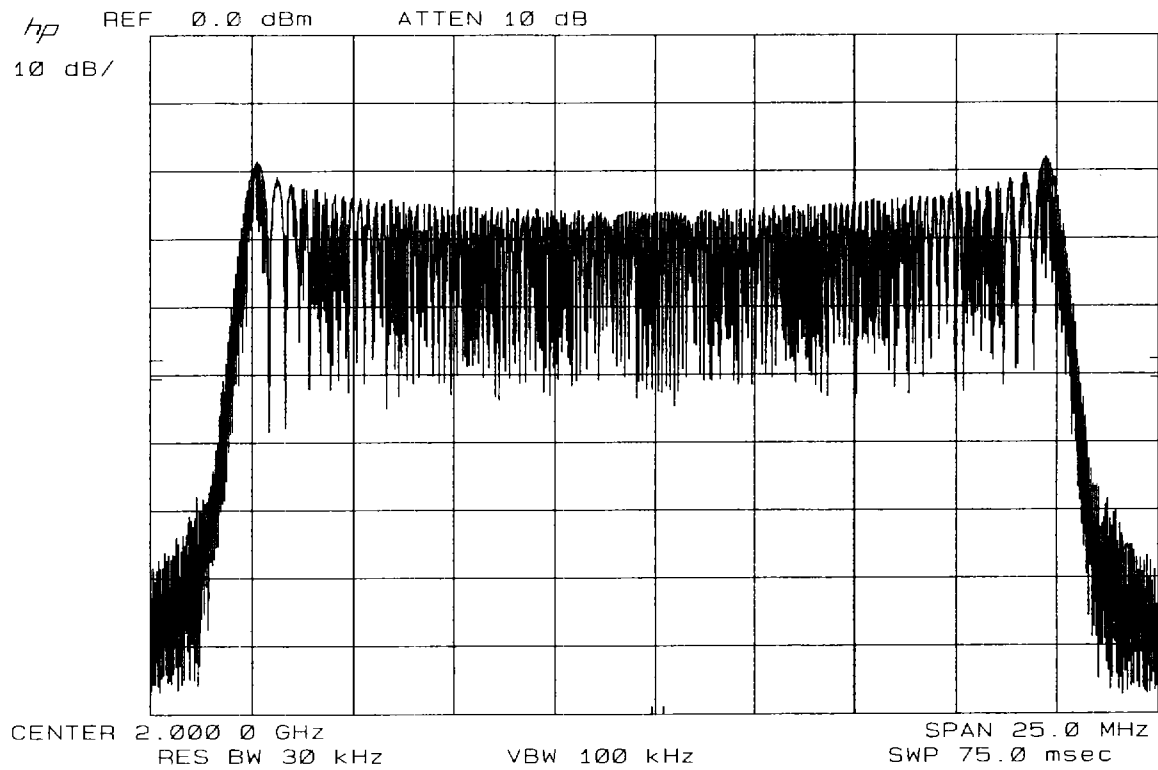

Figure 3-28. Example Signal Spectrum that Passes Test

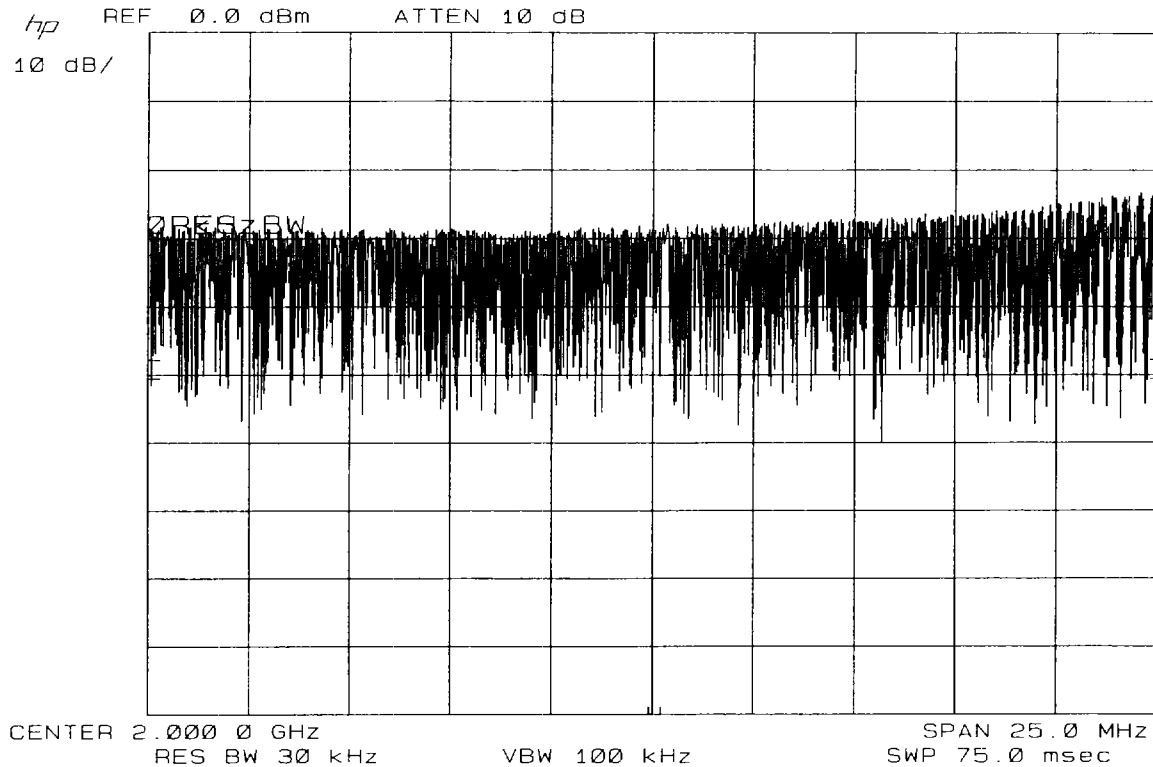

Figure 3-29. Example Signal Spectrum that Fails Test

If the Procedure Fails

- Verify the test setup and instrument settings.

If the error indicator is on:

1. Check the error queue for the messages 712, Frequency loop went out of lock;(712) and 713, Possible FM overmodulation;(713).

If these messages appear, the "Internal FM Source Verification" test fails.

To check the error queue on the synthesizer:

Press the **MSG** key.

The most recent error message will be shown on the synthesizer display. If the **MSG** annunciator is still lit, successive presses of the **MSG** key will display any other messages in the queue.

Performance Test Record

This chapter contains test records for each of the synthesizers covered in this book. The test records are as follows:

- HP 83711A/11B Test Record
- HP 83712A/12B Test Record
- HP 83731A/31B Test Record
- HP 83732A/32B Test Record

Make a copy of the appropriate test record, and use it as a record and worksheet when you run the performance tests.

HP 83711A/11B Test Record

Test Facility _____	Report Number _____
_____	Date _____
_____	Customer _____
_____	Tested By _____
Model _____	Ambient Temperature _____ °C
Serial Number _____	Relative Humidity _____ %
Options _____	Line Frequency _____ Hz (nominal)
Firmware Revision _____	
Special Notes:	

Model _____	Report Number _____	Date _____	
Test Equipment Used	Model Number	Trace Number	Cal Due Date
1. Digital Oscilloscope	_____	_____	_____
2. Measuring Receiver	_____	_____	_____
3. Power Sensor	_____	_____	_____
4. Power Sensor (lowband)	_____	_____	_____
5. Power Meter	_____	_____	_____
6. Microwave Frequency Counter	_____	_____	_____
7. Function Generator	_____	_____	_____
8. Frequency Counter	_____	_____	_____
9. Frequency Standard	_____	_____	_____
10. Digital Voltmeter	_____	_____	_____
11. Spectrum Analyzer	_____	_____	_____
12. Pulse/Function Generator	_____	_____	_____
13. _____	_____	_____	_____
14. _____	_____	_____	_____
15. _____	_____	_____	_____
16. _____	_____	_____	_____
17. _____	_____	_____	_____
18. _____	_____	_____	_____

Test	Minimum	Actual	Maximum
SELF TEST		pass/fail	
INTERNAL TIMEBASE AGING RATE Option 1E5		_____	1.5x10 ⁻⁹
FREQUENCY RANGE AND RESOLUTION			
1.000 000 000 GHz			
without Option 1E8	999 999 900 Hz	_____	1 000 000 100 Hz
with Option 1E8	999 999 999 Hz	_____	1 000 000 001 Hz
One Step Resolution			
without Option 1E8	1 000 001 000 Hz	_____	1 000 001 100 Hz
with Option 1E8	1 000 000 000 Hz	_____	1 000 000 002 Hz
20.000 000 000 GHz			
without Option 1E8	19 999 999 900 Hz	_____	20 000 000 100 Hz
with Option 1E8	19 999 999 999 Hz	_____	20 000 000 001 Hz
EXTERNAL ALC			
Does the signal remain leveled?		yes/no	
MAXIMUM LEVELED POWER			
For the following frequencies, is Unleveled Indicator off, and does power meter read:			
≥ +11 dBm (+10 dBm with Option 1E1)?			
1.0 GHz		yes/no	
1.64 GHz		yes/no	
2.74 GHz		yes/no	
4.79 GHz		yes/no	
5.99 GHz		yes/no	
7.99 GHz		yes/no	
9.99 GHz		yes/no	
10.00 GHz		yes/no	
12.79 GHz		yes/no	
13.99 GHz		yes/no	
17.99 GHz		yes/no	
19.00 GHz		yes/no	
19.20 GHz		yes/no	

Test	Minimum	Actual	Maximum
19.30 GHz		yes/no	
19.40 GHz		yes/no	
19.50 GHz		yes/no	
19.60 GHz		yes/no	
19.70 GHz		yes/no	
19.80 GHz		yes/no	
19.90 GHz		yes/no	
20.00 GHz		yes/no	
VERNIER LEVEL ACCURACY			
1.033 GHz			
+ 10 dBm	+9.0 dBm	_____	+ 11.0 dBm
+ 5 dBm	+4.0 dBm	_____	+ 6.0 dBm
0 dBm	-1 dBm	_____	+ 1.0 dBm
5.225 GHz			
+ 10 dBm	+9.0 dBm	_____	+ 11.0 dBm
+ 5 dBm	+4.0 dBm	_____	+ 6.0 dBm
0 dBm	-1 dBm	_____	+ 1.0 dBm
9.487 GHz			
+ 10 dBm	+9.0 dBm	_____	+ 11.0 dBm
+ 5 dBm	+4.0 dBm	_____	+ 6.0 dBm
0 dBm	-1 dBm	_____	+ 1.0 dBm
13.75 GHz			
+ 10 dBm	+9.0 dBm	_____	+ 11.0 dBm
+ 5 dBm	+4.0 dBm	_____	+ 6.0 dBm
0 dBm	-1 dBm	_____	+ 1.0 dBm
18.00 GHz			
+ 10 dBm	+9.0 dBm	_____	+ 11.0 dBm
+ 5 dBm	+4.0 dBm	_____	+ 6.0 dBm
0 dBm	-1 dBm	_____	+ 1.0 dBm

Test	Minimum	Actual	Maximum
20.00 GHz (Option 1E9 only)			
+ 10 dBm	+9.0 dBm	_____	+ 11.0 dBm
+ 5 dBm	+ 4.0 dBm	_____	+ 6.0 dBm
0 dBm	- 1 dBm	_____	+ 1.0 dBm
FLATNESS			
+ 10 dBm		_____	<1 dB
+ 5 dBm		_____	<1 dB
0 dBm		_____	<1 dB
LOW LEVEL ACCURACY and FLATNESS			
Power Meter Readings at 1.5 GHz			
-24 dBm	-26 dBm	_____ (dBm)	-22 dBm
-14 dBm	-16 dBm	_____ (dBm)	-12 dBm
-4 dBm	-5 dBm	_____ (dBm)	-3 dBm
+ 5 dBm = ABS@1.5 GHz	+ 4 dBm	_____ (dBm)	+ 6 dBm
Measuring Receiver Relative Readings at 1.5 GHz			
-34 dBm setting = REL@-34 dBm = _____			
-44 dBm setting = REL@-44 dBm = _____			
-54 dBm setting = REL@-54 dBm = _____			
-64 dBm setting = REL@-64 dBm = _____			
-74 dBm setting = REL@-74 dBm = _____			
-84 dBm setting = REL@-84 dBm = _____			
-90 dBm setting = REL@-90 dBm = _____			
-95 dBm setting = REL@-95 dBm = _____			
-105 dBm setting = REL@-105 dBm = _____			
Calculated Actual Power Levels at 1.5 GHz			
ABS@1.5 GHz + REL@-34 dBm = ACT@-34 dBm	-36 dBm	_____ (dBm)	-32 dBm
ABS@1.5 GHz + REL@-44 dBm = ACT@-44 dBm	-46 dBm	_____ (dBm)	-42 dBm
ABS@1.5 GHz + REL@-54 dBm = ACT@-54 dBm	-56 dBm	_____ (dBm)	-52 dBm
ABS@1.5 GHz + REL@-64 dBm = ACT@-64 dBm	-66 dBm	_____ (dBm)	-62 dBm
ABS@960.272MHz + REL@-74 dBm = ACT@-74 dBm	-76 dBm	_____ (dBm)	-72 dBm
ABS@960.272MHz + REL@-84 dBm = ACT@-84 dBm	-86 dBm	_____ (dBm)	-82 dBm
ABS@960.272MHz + REL@-90 dBm = ACT@-90 dBm	-92 dBm	_____ (dBm)	-88 dBm
ABS@960.272MHz + REL@-95 dBm = ACT@-95 dBm	-97 dBm	_____ (dBm)	-93 dBm
ABS@960.272MHz + REL@-105 dBm - 5 dBm = ACT@-105 dBm	-107.5 dBm	_____ (dBm)	-102.5 dBm

Test	Minimum	Actual	Maximum
5.225 GHz			
Power Meter Readings			
-14 dBm	-16 dBm	_____ (dBm)	-12 dBm
+5 dBm = ABS@5.225 GHz	+4 dBm	_____ (dBm)	+6 dBm
Measuring Receiver Relative Readings			
-90 dBm setting = REL@-90 dBm = _____			
-105 dBm setting = REL@-105 dBm = _____			
Calculated Actual Power Level			
ABS@5.225 GHz + REL@-90 dBm = ACT@-90 dBm	-92 dBm	_____ (dBm)	-88 dBm
ABS@5.225 GHz + REL@-105 dBm - 5 dBm = ACT@-105 dBm	-107.5 dBm	_____ (dBm)	-102.5 dBm
9.487 GHz			
Power Meter Readings			
-14 dBm	-16 dBm	_____ (dBm)	-12 dBm
+5 dBm = ABS@9.487 GHz	+4 dBm	_____ (dBm)	+6 dBm
Measuring Receiver Relative Reading			
-90 dBm setting = REL@-90 dBm = _____			
-105 dBm setting = REL@-105 dBm = _____			
Calculated Actual Power Level			
ABS@9.487 GHz + REL@-90 dBm = ACT@-90 dBm	-92 dBm	_____ (dBm)	-88 dBm
ABS@9.487 GHz + REL@-105 dBm - 5 dBm = ACT@-105 dBm	-107.5 dBm	_____ (dBm)	-102.5 dBm
13.75 GHz			
Power Meter Readings			
-14 dBm	-16 dBm	_____ (dBm)	-12 dBm
+5 dBm = ABS@13.75 GHz	+4 dBm	_____ (dBm)	+6 dBm
Measuring Receiver Relative Reading			
-90 dBm setting = REL@-90 dBm = _____			
-105 dBm setting = REL@-105 dBm = _____			
Calculated Actual Power Level			
ABS@13.75 GHz + REL@-90 dBm = ACT@-90 dBm	-92 dBm	_____ (dBm)	-88 dBm
ABS@13.75 GHz + REL@-105 dBm - 5 dBm = ACT@-105 dBm	-107.5 dBm	_____ (dBm)	-102.5 dBm

Test	Minimum	Actual	Maximum
Power Meter Readings at 18 GHz			
-24 dBm	-26 dBm	_____ (dBm)	-22 dBm
-14 dBm	-16 dBm	_____ (dBm)	-12 dBm
-4 dBm	-5 dBm	_____ (dBm)	-3 dBm
+5 dBm = ABS@18 GHz	+4 dBm	_____ (dBm)	+6 dBm
Measuring Receiver Relative Readings at 18 GHz			
-34 dBm setting = REL@-34 dBm = _____			
-44 dBm setting = REL@-44 dBm = _____			
-54 dBm setting = REL@-54 dBm = _____			
-64 dBm setting = REL@-64 dBm = _____			
-74 dBm setting = REL@-74 dBm = _____			
-84 dBm setting = REL@-84 dBm = _____			
-90 dBm setting = REL@-90 dBm = _____			
-95 dBm setting = REL@-95 dBm = _____			
-105 dBm setting = REL@-105 dBm = _____			
Calculated Actual Power Levels at 18 GHz			
ABS@18 GHz + REL@-34 dBm = ACT@-34 dBm	-36 dBm	_____ (dBm)	-32 dBm
ABS@18 GHz + REL@-44 dBm = ACT@-44 dBm	-46 dBm	_____ (dBm)	-42 dBm
ABS@18 GHz + REL@-54 dBm = ACT@-54 dBm	-56 dBm	_____ (dBm)	-52 dBm
ABS@18 GHz + REL@-64 dBm = ACT@-64 dBm	-66 dBm	_____ (dBm)	-62 dBm
ABS@18 GHz + REL@-74 dBm = ACT@-74 dBm	-76 dBm	_____ (dBm)	-72 dBm
ABS@18 GHz + REL@-84 dBm = ACT@-84 dBm	-86 dBm	_____ (dBm)	-82 dBm
ABS@18 GHz + REL@-90 dBm = ACT@-90 dBm	-92 dBm	_____ (dBm)	-88 dBm
ABS@18 GHz + REL@-95 dBm = ACT@-95 dBm	-97.5 dBm	_____ (dBm)	-92.5 dBm
ABS@18 GHz + REL@-105 dBm = ACT@-105 dBm	-107.5 dBm	_____ (dBm)	-102.5 dBm
Flatness Power Meter Readings			
-14 dBm at 1.5 GHz = _____ (dBm)			
-14 dBm at 5.225 GHz = _____ (dBm)			
-14 dBm at 9.487 GHz = _____ (dBm)			
-14 dBm at 13.75 GHz = _____ (dBm)			
-14 dBm at 18.00 GHz = _____ (dBm)			

Test	Minimum	Actual	Maximum
<p>Flatness Calculated Actual Power Levels</p> <p>1.5 GHz ACT@-90 dBm = _____</p> <p>5.225 GHz ACT@-90 dBm = _____</p> <p>9.487 GHz ACT@-90 dBm = _____</p> <p>13.75 GHz ACT@-90 dBm = _____</p> <p>18.00 GHz ACT@-90 dBm = _____</p> <p>Flatness Calculated for HP 8711B</p> <p>1.5 GHz ACT@-105 dBm = _____</p> <p>5.225 GHz ACT@-105 dBm = _____</p> <p>9.487 GHz ACT@-105 dBm = _____</p> <p>13.75 GHz ACT@-105 dBm = _____</p> <p>18.00 GHz ACT@-105 dBm = _____</p> <p>Flatness Calculated</p> <p>for -14 dBm</p> <p>Minimum Power Meter Reading = _____(dBm)</p> <p>Maximum Power Meter Reading = _____(dBm)</p> <p>Maximum Reading - Minimum Reading</p> <p>_____ (dBm)</p> <p>for -90 dBm</p> <p>Minimum Calculated Actual Power = _____(dBm)</p> <p>Maximum Calculated Actual Power = _____(dBm)</p> <p>Maximum Power - Minimum Power</p> <p>_____ (dBm)</p>			<p>1 dBm</p> <p>1 dBm</p>
<p>HARMONICS</p> <p>Carrier Level of 0 dBm</p> <p>2nd Harmonic (2.0 GHz)</p> <p>2nd Harmonic (3.30 GHz)</p> <p>2nd Harmonic (5.50 GHz)</p> <p>2nd Harmonic (9.6 GHz)</p> <p>2nd Harmonic (16.0 GHz)</p> <p>2nd Harmonic (19.8 GHz)</p> <p>2nd Harmonic (20.0 GHz)</p> <p>Carrier Level of +6.0 dBm</p> <p>2nd Harmonic (2.0 GHz)</p> <p>2nd Harmonic (3.30 GHz)</p>		<p>yes/no</p> <p>yes/no</p> <p>yes/no</p> <p>yes/no</p> <p>yes/no</p> <p>yes/no</p> <p>yes/no</p> <p>yes/no</p> <p>yes/no</p> <p>yes/no</p>	<p>-50 dBc</p> <p>-50 dBc</p> <p>-50 dBc</p> <p>-50 dBc</p> <p>-50 dBc</p> <p>-50 dBc</p> <p>-50 dBc</p> <p>-50 dBc</p> <p>-50 dBc</p>

Test	Minimum	Actual	Maximum
2nd Harmonic (5.50 GHz)		yes/no	-50 dBc
2nd Harmonic (9.6 GHz)		yes/no	-50 dBc
2nd Harmonic (16.0 GHz)		yes/no	-50 dBc
2nd Harmonic (19.8 GHz)		yes/no	-50 dBc
2nd Harmonic (20.0 GHz)		yes/no	-50 dBc
SINGLE-SIDEBAND PHASE NOISE			
@ 2 GHz			
Vb (for dynamic signal analyzer) = _____ dBm			
@ 100 Hz Offset			
10logBW = _____ dB			
Vs (Measured Level @ 100 Hz Offset) = _____			
Constants = -46.00 dB			
Calculated Phase Noise (@ 100 Hz Offset) =			
Vs - Vb - 10logBW - 46 dB			
		_____ dBc/Hz	-70 dBc/Hz (HP 83711B)
		_____ dBc/Hz	-66 dBc/Hz (HP 83711A)
@ 1 kHz Offset			
Vs (Measured Level @ 1 kHz Offset) = _____			
Constants = -46.00 dB			
Calculated Phase Noise (@ 1 kHz Offset) =			
Vs - Vb - 10logBW - 46 dB			
		_____ dBc/Hz	-78 dBc/Hz (HP 83711B)
		_____ dBc/Hz	-74 dBc/Hz (HP 83711A)
@ 10 kHz Offset			
Vs (Measured Level @ 10 kHz Offset) = _____			
Constants = -46.00 dB			
Calculated Phase Noise (@ 10 kHz Offset) =			
Vs - Vb - 10logBW - 46 dB			
		_____ dBc/Hz	-83 dBc/Hz (HP 83711B)
		_____ dBc/Hz	-91 dBc/Hz (HP 83711A)
@ 100 kHz Offset			
Vb (for spectrum analyzer) = _____ dBm			
10logBW = _____ dB			
Constants = -43.50 dB			
Vs (Measured Level @ 100 kHz Offset) = _____			
Calculated Phase Noise (@ 100 kHz Offset) =			
Vs - Vb - 10logBW - 43.50 dB			
		_____ dBc/Hz	-100 dBc/Hz (HP 83711B)
		_____ dBc/Hz	-107 dBc/Hz (HP 83711A)

Test	Minimum	Actual	Maximum
@ 10 GHz Vb (for dynamic signal analyzer) = _____ dBm			
@ 100 Hz Offset Vs (Measured Level @ 100 Hz Offset) = _____ Constants = -46.00 dB Calculated Phase Noise (@ 100 Hz Offset) = $V_s - V_b - 10\log BW - 46 \text{ dB}$		_____ dBc/Hz _____ dBc/Hz	-65 dBc/Hz (HP 83711B) -69 dBc/Hz (HP 83711A)
@ 1 kHz Offset Vs (Measured Level @ 1 kHz Offset) = _____ Constants = -46.00 dB Calculated Phase Noise (@ 1 kHz Offset) = $V_s - V_b - 10\log BW - 46 \text{ dB}$		_____ dBc/Hz _____ dBc/Hz	-73 dBc/Hz (HP 83711B) -75 dBc/Hz (HP 83711A)
@ 10 kHz Offset Vs (Measured Level @ 10 kHz Offset) = _____ Constants = -46.00 dB Calculated Phase Noise (@ 10 kHz Offset) = $V_s - V_b - 10\log BW - 46 \text{ dB}$		_____ dBc/Hz _____ dBc/Hz	-76 dBc/Hz (HP 83711B) -79 dBc/Hz (HP 83711A)
@ 100 kHz Offset Vb (for spectrum analyzer) = _____ dBm Constants = -43.50 dB Vs (Measured Level @ 100 kHz Offset) = _____ Calculated Phase Noise (@ 100 kHz Offset) = $V_s - V_b - 10\log BW - 43.50 \text{ dB}$		_____ dBc/Hz _____ dBc/Hz	-100 dBc/Hz (HP 83711B) -101 dBc/Hz (HP 83711A)
@ 18 GHz Vb (for dynamic signal analyzer) = _____ dBm			

Test	Minimum	Actual	Maximum
<p>@ 100 Hz Offset Vs (Measured Level @ 100 Hz Offset) = _____ Constants = -46.00 dB Calculated Phase Noise (@ 100 Hz Offset)= Vs - Vb - 10logBW -46 dB</p> <p>@ 1 kHz Offset Vs (Measured Level @ 1 kHz Offset) = _____ Constants = -46.00 dB Calculated Phase Noise (@ 1 kHz Offset)= Vs - Vb - 10logBW -46 dB</p> <p>@ 10 kHz Offset Vs (Measured Level @ 10 kHz Offset) = _____ Constants = -46.00 dB Calculated Phase Noise (@ 10 kHz Offset)= Vs - Vb - 10logBW -46 dB</p> <p>@ 100 kHz Offset Vb (for spectrum analyzer) = _____ dBm Constants = -43.50 dB Vs (Measured Level @ 100 kHz Offset) = _____ Calculated Phase Noise (@ 100 kHz Offset) = Vs - Vb - 10logBW - 43.50 dB</p>		<p>_____ dBc/Hz</p> <p>_____ dBc/Hz</p> <p>_____ dBc/Hz</p> <p>_____ dBc/Hz</p> <p>_____ dBc/Hz</p> <p>_____ dBc/Hz</p> <p>_____ dBc/Hz</p> <p>_____ dBc/Hz</p>	<p>-65 dBc/Hz (HP 83711B)</p> <p>-63 dBc/Hz (HP 83711A)</p> <p>-73 dBc/Hz (HP 83711B)</p> <p>-70 dBc/Hz (HP 83711A)</p> <p>-76 dBc/Hz (HP 83711B)</p> <p>-73 dBc/Hz (HP 83711A)</p> <p>-100 dBc/Hz (HP 83711B)</p> <p>-99 dBc/Hz (HP 83711A)</p>
<p>NON-HARMONIC SPURS 3 - 30 kHz @17005.111 MHz Vb (from "To Calibrate the System") = _____ dBm Total Correction Factor = -Vb - 46.00 dB = _____ dB for 3 kHz to 8 kHz Span Vs (Measured Level) = _____ dBm Calculated Spurious Level = Total Correction Factor + Vs Noise ___ or Offset Frequency _____ dBm for 8 kHz to 13 kHz Span Vs (Measured Level) = _____ dBm Calculated Spurious Level = Total Correction Factor + Vs</p>		<p>_____ dBc</p> <p>_____ dBc</p>	<p>-60 dBc</p> <p>-60 dBc</p>

Test	Minimum	Actual	Maximum
<p>for 13 kHz to 23 kHz Span Vs (Measured Level) = _____ dBm Calculated Spurious Level = Total Correction Factor + Vs Noise ___ or Offset Frequency _____ dBm</p> <p>for 23 kHz to 33 kHz Span Vs (Measured Level) = _____ dBm Calculated Spurious Level = Total Correction Factor + Vs Noise ___ or Offset Frequency _____ dBm</p>		<p>_____ dBc</p> <p>_____ dBc</p>	<p>-60 dBc</p> <p>-60 dBc</p>
<p>@17501.777 MHz Vb (from "To Calibrate the System") = _____ dBm Total Correction Factor = -Vb - 46.00 dB = _____ dB</p> <p>for 3 kHz to 8 kHz Span Vs (Measured Level) = _____ dBm Calculated Spurious Level = Total Correction Factor + Vs Noise ___ or Offset Frequency _____ dBm</p> <p>for 8 kHz to 13 kHz Span Vs (Measured Level) = _____ dBm Calculated Spurious Level = Total Correction Factor + Vs</p> <p>for 13 kHz to 23 kHz Span Vs (Measured Level) = _____ dBm Calculated Spurious Level = Total Correction Factor + Vs Noise ___ or Offset Frequency _____ dBm</p> <p>for 23 kHz to 33 kHz Span Vs (Measured Level) = _____ dBm Calculated Spurious Level = Total Correction Factor + Vs Noise ___ or Offset Frequency _____ dBm</p>		<p>_____ dBc</p> <p>_____ dBc</p> <p>_____ dBc</p> <p>_____ dBc</p>	<p>-60 dBc</p> <p>-60 dBc</p> <p>-60 dBc</p> <p>-60 dBc</p>
<p>NON-HARMONIC SPURS >30 kHz Is the spurious level no greater than -60 dBc for the following frequencies and spans?</p>			
<p>@17005.111 MHz</p>		<p>yes/no</p>	
<p>@17501.777 MHz</p>		<p>yes/no</p>	
<p>@19801.511 MHz</p>		<p>yes/no</p>	

HP 83712A/12B Test Record

Test Facility _____	Report Number _____
_____	Date _____
_____	Customer _____
_____	Tested By _____
Model _____	Ambient Temperature _____ °C
Serial Number _____	Relative Humidity _____ %
Options _____	Line Frequency _____ Hz (nominal)
Firmware Revision _____	
Special Notes:	

Model	Report Number	Date	
Test Equipment Used	Model Number	Trace Number	Cal Due Date
1. Digital Oscilloscope			
2. Measuring Receiver			
3. Power Sensor			
4. Power Sensor (lowband)			
5. Power Meter			
6. Microwave Frequency Counter			
7. Function Generator			
8. Frequency Counter			
9. Frequency Standard			
10. Digital Voltmeter			
11. Spectrum Analyzer			
12. Pulse/Function Generator			
13. _____			
14. _____			
15. _____			
16. _____			
17. _____			
18. _____			

Test	Minimum	Actual	Maximum
SELF TEST		pass/fail	
INTERNAL TIMEBASE AGING RATE Option 1E5		_____	1.5x10 ⁻⁹
FREQUENCY RANGE AND RESOLUTION			
010 000 000 GHz			
without Option 1E8	009 999 900 Hz	_____	010 000 100 Hz
with Option 1E8	009 999 999 Hz	_____	009 000 001 Hz
One Step Resolution			
without Option 1E8	010 001 000 Hz	_____	010 001 100 Hz
with Option 1E8	010 000 000 Hz	_____	010 000 002 Hz
20.000 000 000 GHz			
without Option 1E8	19 999 999 900 Hz	_____	20 000 000 100 Hz
with Option 1E8	19 999 999 999 Hz	_____	20 000 000 001 Hz
EXTERNAL ALC			
Does the signal remain leveled?		yes/no	
MAXIMUM LEVELED POWER			
For the following frequencies, is Unleveled Indicator off, and does power meter read: ≥ +11 dBm (+10 dBm with Option 1E1)?			
1.0 GHz		yes/no	
1.64 GHz		yes/no	
2.74 GHz		yes/no	
4.79 GHz		yes/no	
5.99 GHz		yes/no	
7.99 GHz		yes/no	
9.99 GHz		yes/no	
10.00 GHz		yes/no	
12.79 GHz		yes/no	
13.99 GHz		yes/no	
17.99 GHz		yes/no	

Test	Minimum	Actual	Maximum
19.00 GHz		yes/no	
19.20 GHz		yes/no	
19.30 GHz		yes/no	
19.40 GHz		yes/no	
19.50 GHz		yes/no	
19.60 GHz		yes/no	
19.70 GHz		yes/no	
19.80 GHz		yes/no	
19.90 GHz		yes/no	
20.00 GHz		yes/no	
For the following frequencies, is Unleveled Indicator off, and does power meter read:			
$\geq +13$ dBm?			
10 MHz		yes/no	
11.2 MHz		yes/no	
11.3 MHz		yes/no	
15.9MHz		yes/no	
16 MHz		yes/no	
22.5 MHz		yes/no	
22.6 MHz		yes/no	
31.9 MHz		yes/no	
32 MHz		yes/no	
45.3MHz		yes/no	
45.4 MHz		yes/no	
63.9 MHz		yes/no	
64 MHz		yes/no	
90.4 MHz		yes/no	
90.5 MHz		yes/no	
127.9 MHz		yes/no	
128 MHz		yes/no	
180.9 MHz		yes/no	

Test	Minimum	Actual	Maximum
181 MHz 255.9 MHz 256 MHz 361.9 MHz 362 MHz 499.9 MHz 500 MHz 699.9 MHz 700 MHz 999 MHz		yes/no yes/no yes/no yes/no yes/no yes/no yes/no yes/no yes/no yes/no	
VERNIER LEVEL ACCURACY			
10.1 MHz +10 dBm +5 dBm 0 dBm	+8.7 dBm +3.7 dBm -1.3 dBm	_____ _____ _____	+11.3 dBm +6.3 dBm +1.3 dBm
18.192 MHz +10 dBm +5 dBm 0 dBm	+8.7 dBm +3.7 dBm -1.3 dBm	_____ _____ _____	+11.3 dBm +6.3 dBm +1.3 dBm
329.488 GHz +10 dBm +5 dBm 0 dBm	+9.0 dBm +4.0 dBm -1.0 dBm	_____ _____ _____	+11.0 dBm +6.0 dBm +1.0 dBm
657.168 GHz +10 dBm +5 dBm 0 dBm	+9.0 dBm +4.0 dBm -1.0 dBm	_____ _____ _____	+11.0 dBm +6.0 dBm +1.0 dBm
984.848 GHz +10 dBm +5 dBm 0 dBm	+9.0 dBm +4.0 dBm -1.0 dBm	_____ _____ _____	+11.0 dBm +6.0 dBm +1.0 dBm

Test	Minimum	Actual	Maximum
1.033 GHz			
+ 10 dBm	+9.0 dBm	_____	+ 11.0 dBm
+ 5 dBm	+4.0 dBm	_____	+ 6.0 dBm
0 dBm	-1.0 dBm	_____	+ 1.0 dBm
5.225 GHz			
+ 10 dBm	+9.0 dBm	_____	+ 11.0 dBm
+ 5 dBm	+4.0 dBm	_____	+ 6.0 dBm
0 dBm	-1.0 dBm	_____	+ 1.0 dBm
9.487 GHz			
+ 10 dBm	+9.0 dBm	_____	+ 11.0 dBm
+ 5 dBm	+4.0 dBm	_____	+ 6.0 dBm
0 dBm	-1.0 dBm	_____	+ 1.0 dBm
13.75 GHz			
+ 10 dBm	+9.0 dBm	_____	+ 11.0 dBm
+ 5 dBm	+4.0 dBm	_____	+ 6.0 dBm
0 dBm	-1.0 dBm	_____	+ 1.0 dBm
18.00 GHz			
+ 10 dBm	+9.0 dBm	_____	+ 11.0 dBm
+ 5 dBm	+4.0 dBm	_____	+ 6.0 dBm
0 dBm	-1.0 dBm	_____	+ 1.0 dBm
20.00 GHz (Option 1E9 only)			
+ 10 dBm	+9.0 dBm	_____	+ 11.0 dBm
+ 5 dBm	+4.0 dBm	_____	+ 6.0 dBm
0 dBm	-1.0 dBm	_____	+ 1.0 dBm
FLATNESS .01 - 1 GHz:			
+ 10 dBm		_____	<1 dB
+ 5 dBm		_____	<1 dB
0 dBm		_____	<1 dB
FLATNESS 1 - 20 GHz:			
+ 10 dBm		_____	<1 dB
+ 5 dBm		_____	<1 dB
0 dBm		_____	<1 dB

Test	Minimum	Actual	Maximum
LOW LEVEL ACCURACY and FLATNESS			
Power Meter Readings at 42.768 MHz			
-24 dBm	-26.3 dBm	_____ (dBm)	-21.7 dBm
-14 dBm	-16.3 dBm	_____ (dBm)	-11.7 dBm
-4 dBm	-5 dBm	_____ (dBm)	-3 dBm
+5 dBm = ABS@42.768MHz	+4 dBm	_____ (dBm)	+6 dBm
Measuring Receiver Relative Readings at 42.768 MHz			
-34 dBm setting = REL@-34 dBm = _____			
-44 dBm setting = REL@-44 dBm = _____			
-54 dBm setting = REL@-54 dBm = _____			
-64 dBm setting = REL@-64 dBm = _____			
-74 dBm setting = REL@-74 dBm = _____			
-84 dBm setting = REL@-84 dBm = _____			
-90 dBm setting = REL@-90 dBm = _____			
-95 dBm setting = REL@-95 dBm = _____			
-105 dBm setting = REL@-105 dBm = _____			
Calculated Actual Power Levels at 42.768 MHz			
ABS@42.768MHz + REL@-34 dBm = ACT@-34 dBm	-36.3 dBm	_____ (dBm)	-31.7 dBm
ABS@42.768MHz + REL@-44 dBm = ACT@-44 dBm	-46.3 dBm	_____ (dBm)	-41.7 dBm
ABS@42.768MHz + REL@-54 dBm = ACT@-54 dBm	-56.3 dBm	_____ (dBm)	-51.7 dBm
ABS@42.768MHz + REL@-64 dBm = ACT@-64 dBm	-66.3 dBm	_____ (dBm)	-61.7 dBm
ABS@42.768MHz + REL@-74 dBm = ACT@-74 dBm	-76.3 dBm	_____ (dBm)	-71.7 dBm
ABS@42.768MHz + REL@-84 dBm = ACT@-84 dBm	-86.3 dBm	_____ (dBm)	-81.7 dBm
ABS@42.768MHz + REL@-90 dBm = ACT@-90 dBm	-92.3 dBm	_____ (dBm)	-87.7 dBm
ABS@42.768MHz + REL@-95 dBm = ACT@-95 dBm	-97.5 dBm	_____ (dBm)	-92.5 dBm
ABS@42.768MHz + REL@-105 dBm -5 dBm = ACT@-105 dBm	-107.5 dBm	_____ (dBm)	-102.5 dBm
304.912 MHz			
Power Meter Readings			
-14 dBm	-16 dBm	_____ (dBm)	-12 dBm
+5 dBm = ABS@304.912MHz	+4 dBm	_____ (dBm)	+6 dBm
Measuring Receiver Relative Readings			
-90 dBm setting = REL@-90 dBm = _____			
-105 dBm setting = REL@-105 dBm = _____			

Test	Minimum	Actual	Maximum
Calculated Actual Power Levels			
ABS@304.912MHz + REL@-90 dBm = ACT@-90 dBm	-92.0 dBm	_____ (dBm)	-88.0 dBm
ABS@304.912MHz + REL@-105 dBm -5 dBm = ACT@-105 dBm	-107.5 dBm	_____ (dBm)	-102.5 dBm
632.592 MHz			
Power Meter Readings			
-14 dBm	-16 dBm	_____ (dBm)	-12 dBm
+5 dBm = ABS@632.592MHz	+4 dBm	_____ (dBm)	+6 dBm
Measuring Receiver Relative Readings			
-90 dBm setting = REL@-90 dBm = _____			
-105 dBm setting = REL@-105 dBm = _____			
Calculated Actual Power Levels			
ABS@632.592MHz + REL@-90 dBm = ACT@-90 dBm	-92.0 dBm	_____ (dBm)	-88.0 dBm
ABS@632.592MHz + REL@-105 dBm -5 dBm = ACT@-105 dBm	-107.5 dBm	_____ (dBm)	-102.5 dBm
Power Meter Readings at 960.272 MHz			
-24 dBm	-26 dBm	_____ (dBm)	-22 dBm
-14 dBm	-16 dBm	_____ (dBm)	-12 dBm
-4 dBm	-5 dBm	_____ (dBm)	-3 dBm
+5 dBm = ABS@960.272MHz	+4 dBm	_____ (dBm)	+6 dBm
Measuring Receiver Relative Readings at 960.272 MHz			
-34 dBm setting = REL@-34 dBm = _____			
-44 dBm setting = REL@-44 dBm = _____			
-54 dBm setting = REL@-54 dBm = _____			
-64 dBm setting = REL@-64 dBm = _____			
-74 dBm setting = REL@-74 dBm = _____			
-84 dBm setting = REL@-84 dBm = _____			
-90 dBm setting = REL@-90 dBm = _____			
-95 dBm setting = REL@-95 dBm = _____			
-105 dBm setting = REL@-105 dBm = _____			

Test	Minimum	Actual	Maximum
Calculated Actual Power Levels at 960.272 MHz			
ABS@960.272MHz + REL@-34 dBm = ACT@-34 dBm	-36 dBm	_____ (dBm)	-32 dBm
ABS@960.272MHz + REL@-44 dBm = ACT@-44 dBm	-46 dBm	_____ (dBm)	-42 dBm
ABS@960.272MHz + REL@-54 dBm = ACT@-54 dBm	-56 dBm	_____ (dBm)	-52 dBm
ABS@960.272MHz + REL@-64 dBm = ACT@-64 dBm	-66 dBm	_____ (dBm)	-62 dBm
ABS@960.272MHz + REL@-74 dBm = ACT@-74 dBm	-76 dBm	_____ (dBm)	-72 dBm
ABS@960.272MHz + REL@-84 dBm = ACT@-84 dBm	-86 dBm	_____ (dBm)	-82 dBm
ABS@960.272MHz + REL@-90 dBm = ACT@-90 dBm	-92 dBm	_____ (dBm)	-88 dBm
ABS@960.272MHz + REL@-95 dBm = ACT@-95 dBm	-97.5 dBm	_____ (dBm)	-92.5 dBm
ABS@960.272MHz + REL@-105 dBm -5 dBm = ACT@-105 dBm	-107.5 dBm	_____ (dBm)	-102.5 dBm
Power Meter Readings at 1.5 GHz			
-24 dBm	-26 dBm	_____ (dBm)	-22 dBm
-14 dBm	-16 dBm	_____ (dBm)	-12 dBm
-4 dBm	-5 dBm	_____ (dBm)	-3 dBm
+5 dBm = ABS@1.5 GHz	+4 dBm	_____ (dBm)	+6 dBm
Measuring Receiver Relative Readings at 1.5 GHz			
-34 dBm setting = REL@-34 dBm = _____			
-44 dBm setting = REL@-44 dBm = _____			
-54 dBm setting = REL@-54 dBm = _____			
-64 dBm setting = REL@-64 dBm = _____			
-74 dBm setting = REL@-74 dBm = _____			
-84 dBm setting = REL@-84 dBm = _____			
-90 dBm setting = REL@-90 dBm = _____			
-95 dBm setting = REL@-95 dBm = _____			
-105 dBm setting = REL@-105 dBm = _____			
Calculated Actual Power Levels at 1.5 GHz			
ABS@1.5 GHz + REL@-34 dBm = ACT@-34 dBm	-36 dBm	_____ (dBm)	-32 dBm
ABS@1.5 GHz + REL@-44 dBm = ACT@-44 dBm	-46 dBm	_____ (dBm)	-42 dBm
ABS@1.5 GHz + REL@-54 dBm = ACT@-54 dBm	-56 dBm	_____ (dBm)	-52 dBm
ABS@1.5 GHz + REL@-64 dBm = ACT@-64 dBm	-66 dBm	_____ (dBm)	-62 dBm
ABS@960.272MHz + REL@-74 dBm = ACT@-74 dBm	-76 dBm	_____ (dBm)	-72 dBm
ABS@960.272MHz + REL@-84 dBm = ACT@-84 dBm	-86 dBm	_____ (dBm)	-82 dBm

Test	Minimum	Actual	Maximum
ABS@960.272MHz + REL@-90 dBm = ACT@-90 dBm	-92 dBm	_____ (dBm)	-88 dBm
ABS@960.272MHz + REL@-95 dBm = ACT@-95 dBm	-97.5 dBm	_____ (dBm)	-92.5 dBm
ABS@960.272MHz + REL@-105 dBm -5 dBm = ACT@-105 dBm	-107.5 dBm	_____ (dBm)	-102.5 dBm
5.225 GHz			
Power Meter Readings			
-14 dBm	-16 dBm	_____ (dBm)	-12 dBm
+5 dBm = ABS@5.225 GHz	+4 dBm	_____ (dBm)	+6 dBm
Measuring Receiver Relative Readings			
-90 dBm setting = REL@-90 dBm = _____			
-105 dBm setting = REL@-105 dBm = _____			
Calculated Actual Power Level			
ABS@5.225 GHz + REL@-90 dBm = ACT@-90 dBm	-92 dBm	_____ (dBm)	-88 dBm
ABS@5.225 GHz + REL@-105 dBm -5 dBm = ACT@-105 dBm	-107.5 dBm	_____ (dBm)	-102.5 dBm
9.487 GHz			
Power Meter Readings			
-14 dBm	-16 dBm	_____ (dBm)	-12 dBm
+5 dBm = ABS@9.487 GHz	+4 dBm	_____ (dBm)	+6 dBm
Measuring Receiver Relative Reading			
-90 dBm setting = REL@-90 dBm = _____			
-105 dBm setting = REL@-105 dBm = _____			
Calculated Actual Power Level			
ABS@9.487 GHz + REL@-90 dBm = ACT@-90 dBm	-92 dBm	_____ (dBm)	-88 dBm
ABS@9.487 GHz + REL@-105 dBm -5 dBm = ACT@-105 dBm	-107.5 dBm	_____ (dBm)	-102.5 dBm
13.75 GHz			
Power Meter Readings			
-14 dBm	-16 dBm	_____ (dBm)	-12 dBm
+5 dBm = ABS@13.75 GHz	+4 dBm	_____ (dBm)	+6 dBm
+10 dBm = ABS@13.75 GHz	+9 dBm	_____ (dBm)	+11 dBm
Measuring Receiver Relative Reading			
-90 dBm setting = REL@-90 dBm = _____			
-105 dBm setting = REL@-105 dBm = _____			

Test	Minimum	Actual	Maximum
Calculated Actual Power Level			
ABS@13.75 GHz + REL@-90 dBm = ACT@-90 dBm	-92 dBm	_____ (dBm)	-88 dBm
ABS@13.75 GHz + REL@-105 dBm -5 dBm = ACT@-105 dBm	-107.5 dBm	_____ (dBm)	-102.5 dBm
Power Meter Readings at 18 GHz			
-24 dBm	-26 dBm	_____ (dBm)	-22 dBm
-14 dBm	-16 dBm	_____ (dBm)	-12 dBm
-4 dBm	-5 dBm	_____ (dBm)	-3 dBm
+5 dBm = ABS@18 GHz	+4 dBm	_____ (dBm)	+6 dBm
Measuring Receiver Relative Readings at 18 GHz			
-34 dBm setting = REL@-34 dBm = _____			
-44 dBm setting = REL@-44 dBm = _____			
-54 dBm setting = REL@-54 dBm = _____			
-64 dBm setting = REL@-64 dBm = _____			
-74 dBm setting = REL@-74 dBm = _____			
-84 dBm setting = REL@-84 dBm = _____			
-90 dBm setting = REL@-90 dBm = _____			
-95 dBm setting = REL@-95 dBm = _____			
-105 dBm setting = REL@-105 dBm = _____			
Calculated Actual Power Levels at 18 GHz			
ABS@18 GHz + REL@-34 dBm = ACT@-34 dBm	-36 dBm	_____ (dBm)	-32 dBm
ABS@18 GHz + REL@-44 dBm = ACT@-44 dBm	-46 dBm	_____ (dBm)	-42 dBm
ABS@18 GHz + REL@-54 dBm = ACT@-54 dBm	-56 dBm	_____ (dBm)	-52 dBm
ABS@18 GHz + REL@-64 dBm = ACT@-64 dBm	-66 dBm	_____ (dBm)	-62 dBm
ABS@18 GHz + REL@-74 dBm = ACT@-74 dBm	-76 dBm	_____ (dBm)	-72 dBm
ABS@18 GHz + REL@-84 dBm = ACT@-84 dBm	-86 dBm	_____ (dBm)	-82 dBm
ABS@18 GHz + REL@-90 dBm = ACT@-90 dBm	-92 dBm	_____ (dBm)	-88 dBm
ABS@18 GHz + REL@-95 dBm = ACT@-95 dBm	-97.5 dBm	_____ (dBm)	-92.5 dBm
ABS@18 GHz + REL@-105 dBm -5 dBm = ACT@-105 dBm	-107.5 dBm	_____ (dBm)	-102.5 dBm
Flatness Power Meter Readings 10 MHz to 1 GHz			
-14 dBm at 42.768 MHz = _____ (dBm)			
-14 dBm at 304.912 MHz = _____ (dBm)			

Test	Minimum	Actual	Maximum
-14 dBm at 632.592 MHz = _____(dBm) -14 dBm at 960.272 MHz= _____(dBm)			
Flatness Power Meter Readings 1 GHz to 18 GHz			
-14 dBm at 1.5 GHz= _____(dBm)			
-14 dBm at 5.225 GHz= _____(dBm)			
-14 dBm at 9.487 GHz= _____(dBm)			
-14 dBm at 13.75 GHz= _____(dBm)			
-14 dBm at 18.00 GHz= _____(dBm)			
Flatness Calculated Actual Power Levels 10 MHz to 1 GHz			
42.768MHz ACT@-90 dBm = _____(dBm)			
304.912 MHz ACT@-90 dBm = _____(dBm)			
632.592MHz ACT@-90 dBm = _____(dBm)			
960.272MHz ACT@-90 dBm = _____(dBm)			
Flatness Calculated Actual Power Levels 10 MHz to 1 GHz for HP 83712B			
42.768MHz ACT@-105 dBm = _____(dBm)			
304.912 MHz ACT@-105 dBm = _____(dBm)			
632.592MHz ACT@-105 dBm = _____(dBm)			
960.272MHz ACT@-105 dBm = _____(dBm)			
Flatness Calculated Actual Power Levels 1 GHz to 18 GHz			
1.5 GHz ACT@-90 dBm = _____(dBm)			
5.225 GHz ACT@-90 dBm = _____(dBm)			
9.487 GHz ACT@-90 dBm = _____(dBm)			
13.75 GHz ACT@-90 dBm = _____(dBm)			
18.00 GHz ACT@-90 dBm = _____(dBm)			

Test	Minimum	Actual	Maximum
Flatness Calculated Actual Power Levels 1 GHz to 18 GHz for HP 83712B 1.5 GHz ACT@-105 dBm = _____(dBm) 5.225 GHz ACT@-105 dBm = _____(dBm) 9.487 GHz ACT@-105 dBm = _____(dBm) 13.75 GHz ACT@-105 dBm = _____(dBm) 18.00 GHz ACT@-105 dBm = _____(dBm)			
Flatness Calculated 10 MHz to 1 GHz for -14 dBm			
Maximum Power Meter Reading = _____(dBm)			
Minimum Power Meter Reading = _____(dBm)			
Maximum Reading – Minimum Reading		_____ (dB)	1 dB
for -90 dBm			
Maximum Calculated Actual Power = _____(dBm)			
Minimum Calculated Actual Power = _____(dBm)			
Maximum Power – Minimum Power		_____ (dB)	1 dB
for -105 dBm			
Maximum Calculated Actual Power = _____(dBm)			
Minimum Calculated Actual Power = _____(dBm)			
Maximum Power – Minimum Power		_____ (dB)	1 dB

Test	Minimum	Actual	Maximum
<p>Flatness Calculated 1 GHz to 18 GHz for -14 dBm Maximum Power Meter Reading = ____ (dBm) Minimum Power Meter Reading = ____ (dBm) Maximum Reading - Minimum Reading</p> <p>for -90 dBm Maximum Calculated Actual Power = ____ (dBm) Minimum Calculated Actual Power = ____ (dBm) Maximum Power - Minimum Power</p>		<p>____ (dB)</p> <p>____ (dB)</p>	<p>1 dB</p> <p>1 dB</p>
<p>HARMONICS</p> <p>Carrier Level of 0 dBm</p> <p>2nd Harmonic (20.0 MHz)</p> <p>2nd Harmonic (22.6 MHz)</p> <p>2nd Harmonic (32.0 MHz)</p> <p>2nd Harmonic (45.2 MHz)</p> <p>2nd Harmonic (64 MHz)</p> <p>2nd Harmonic (91.0 MHz)</p> <p>2nd Harmonic (128.0 MHz)</p> <p>2nd Harmonic (181.0 MHz)</p> <p>2nd Harmonic (256.0 MHz)</p> <p>2nd Harmonic (362.0 MHz)</p> <p>2nd Harmonic (512.0 MHz)</p> <p>2nd Harmonic (724.0 MHz)</p> <p>2nd Harmonic (1.0 GHz)</p> <p>2nd Harmonic (1.4 GHz)</p> <p>2nd Harmonic (2.0 GHz)</p> <p>2nd Harmonic (3.3 GHz)</p> <p>2nd Harmonic (5.5 GHz)</p> <p>2nd Harmonic (9.6 GHz)</p> <p>2nd Harmonic (16.0 GHz)</p> <p>2nd Harmonic (19.8 GHz)</p> <p>2nd Harmonic (20.0 GHz)</p>		<p>yes/no</p> <p>yes/no</p> <p>yes/no</p> <p>yes/no</p> <p>yes/no</p> <p>yes/no</p> <p>yes/no</p> <p>yes/no</p> <p>yes/no</p> <p>yes/no</p> <p>yes/no</p> <p>yes/no</p> <p>yes/no</p> <p>yes/no</p> <p>yes/no</p> <p>yes/no</p> <p>yes/no</p> <p>yes/no</p> <p>yes/no</p> <p>yes/no</p> <p>yes/no</p>	<p>-55 dBc</p> <p>-55 dBc</p> <p>-55 dBc</p> <p>-55 dBc</p> <p>-55 dBc</p> <p>-55 dBc</p> <p>-55 dBc</p> <p>-55 dBc</p> <p>-55 dBc</p> <p>-55 dBc</p> <p>-55 dBc</p> <p>-55 dBc</p> <p>-55 dBc</p> <p>-55 dBc</p> <p>-55 dBc</p> <p>-50 dBc</p> <p>-50 dBc</p> <p>-50 dBc</p> <p>-50 dBc</p> <p>-50 dBc</p> <p>-50 dBc</p>

Test	Minimum	Actual	Maximum
Carrier Level of +6.0 dBm			
2nd Harmonic (20.0 MHz)		yes/no	-50 dBc
2nd Harmonic (22.6 MHz)		yes/no	-50 dBc
2nd Harmonic (32.0 MHz)		yes/no	-50 dBc
2nd Harmonic (45.2 MHz)		yes/no	-50 dBc
2nd Harmonic (64 MHz)		yes/no	-50 dBc
2nd Harmonic (91.0 MHz)		yes/no	-50 dBc
2nd Harmonic (128.0 MHz)		yes/no	-50 dBc
2nd Harmonic (181.0 MHz)		yes/no	-50 dBc
2nd Harmonic (256.0 MHz)		yes/no	-50 dBc
2nd Harmonic (362.0 MHz)		yes/no	-50 dBc
2nd Harmonic (512.0 MHz)		yes/no	-50 dBc
2nd Harmonic (724.0 MHz)		yes/no	-50 dBc
2nd Harmonic (1.0 GHz)		yes/no	-50 dBc
2nd Harmonic (1.4 GHz)		yes/no	-50 dBc
2nd Harmonic (2.0 GHz)		yes/no	-50 dBc
2nd Harmonic (3.3 GHz)		yes/no	-50 dBc
2nd Harmonic (5.5 GHz)		yes/no	-50 dBc
2nd Harmonic (9.6 GHz)		yes/no	-50 dBc
2nd Harmonic (16.0 GHz)		yes/no	-50 dBc
2nd Harmonic (19.8 GHz)		yes/no	-50 dBc
2nd Harmonic (20.0 GHz)		yes/no	-50 dBc

Test	Minimum	Actual	Maximum
<p>SINGLE-SIDEBAND PHASE NOISE @ 2 GHz Vb (for dynamic signal analyzer) = _____ dBm</p> <p>@ 100 Hz Offset 10logBW = _____ dB Vs (Measured Level @ 100 Hz Offset) = _____ Constants = -46.00 dB Calculated Phase Noise (@ 100 Hz Offset)= Vs - Vb - 10logBW -46 dB</p> <p>@ 1 kHz Offset Vs (Measured Level @ 1 kHz Offset) = _____ Constants = -46.00 dB Calculated Phase Noise (@ 1 kHz Offset)= Vs - Vb - 10logBW -46 dB</p> <p>@ 10 kHz Offset Vs (Measured Level @ 10 kHz Offset) = _____ Constants = -46.00 dB Calculated Phase Noise (@ 10 kHz Offset)= Vs - Vb - 10logBW -46 dB</p> <p>@ 100 kHz Offset Vb (for spectrum analyzer) = _____ dBm 10logBW = _____ dB Constants = -43.50 dB Vs (Measured Level @ 100 kHz Offset) = _____ Calculated Phase Noise (@ 100 kHz Offset) = Vs - Vb - 10logBW - 43.50 dB</p>		<p>_____ dBc/Hz</p> <p>_____ dBc/Hz</p> <p>_____ dBc/Hz</p> <p>_____ dBc/Hz</p> <p>_____ dBc/Hz</p> <p>_____ dBc/Hz</p> <p>_____ dBc/Hz</p> <p>_____ dBc/Hz</p>	<p>-70 dBc/Hz (HP 83712B)</p> <p>-66 dBc/Hz (HP 83712A)</p> <p>-78 dBc/Hz (HP 83712B)</p> <p>-74 dBc/Hz (HP 83712A)</p> <p>-83 dBc/Hz (HP 83712B)</p> <p>-91 dBc/Hz (HP 83712A)</p> <p>-100 dBc/Hz (HP 83712B)</p> <p>-107 dBc/Hz (HP 83712A)</p>

Test	Minimum	Actual	Maximum
@ 10 GHz Vb (for dynamic signal analyzer) = _____dBm			
@ 100 Hz Offset Vs (Measured Level @ 100 Hz Offset) = _____ Constants = -46.00 dB Calculated Phase Noise (@ 100 Hz Offset)= $V_s - V_b - 10\log BW - 46 \text{ dB}$		_____dBc/Hz _____dBc/Hz	-65 dBc/Hz (HP 83712B) -69 dBc/Hz (HP 83712A)
@ 1 kHz Offset Vs (Measured Level @ 1 kHz Offset) = _____ Constants = -46.00 dB Calculated Phase Noise (@ 1 kHz Offset)= $V_s - V_b - 10\log BW - 46 \text{ dB}$		_____dBc/Hz _____dBc/Hz	-73 dBc/Hz (HP 83712B) -75 dBc/Hz (HP 83712A)
@ 10 kHz Offset Vs (Measured Level @ 10 kHz Offset) = _____ Constants = -46.00 dB Calculated Phase Noise (@ 10 kHz Offset)= $V_s - V_b - 10\log BW - 46 \text{ dB}$		_____dBc/Hz _____dBc/Hz	-76 dBc/Hz (HP 83712B) -79 dBc/Hz (HP 83712A)
@ 100 kHz Offset Vb (for spectrum analyzer) = _____dBm Constants = -43.50 dB Vs (Measured Level @ 100 kHz Offset) = _____ Calculated Phase Noise (@ 100 kHz Offset) = $V_s - V_b - 10\log BW - 43.50 \text{ dB}$		_____dBc/Hz _____dBc/Hz	-100 dBc/Hz (HP 83712B) -101 dBc/Hz (HP 83712A)
@ 18 GHz Vb (for dynamic signal analyzer) = _____dBm			

Test	Minimum	Actual	Maximum
@ 100 Hz Offset Vs (Measured Level @ 100 Hz Offset) = _____ Constants = -46.00 dB Calculated Phase Noise (@ 100 Hz Offset)= Vs - Vb - 10logBW -46 dB		_____ dBc/Hz	-65 dBc/Hz (HP 83712B)
		_____ dBc/Hz	-63 dBc/Hz (HP 83712A)
@ 1 kHz Offset Vs (Measured Level @ 1 kHz Offset) = _____ Constants = -46.00 dB Calculated Phase Noise (@ 1 kHz Offset)= Vs - Vb - 10logBW -46 dB		_____ dBc/Hz	-73 dBc/Hz (HP 83712B)
		_____ dBc/Hz	-70 dBc/Hz (HP 83712A)
@ 10 kHz Offset Vs (Measured Level @ 10 kHz Offset) = _____ Constants = -46.00 dB Calculated Phase Noise (@ 10 kHz Offset)= Vs - Vb - 10logBW -46 dB		_____ dBc/Hz	-76 dBc/Hz (HP 83712B)
		_____ dBc/Hz	-73 dBc/Hz (HP 83712A)
@ 100 kHz Offset Vb (for spectrum analyzer) = _____ dBm Constants = -43.50 dB Vs (Measured Level @ 100 kHz Offset) = _____ Calculated Phase Noise (@ 100 kHz Offset) = Vs - Vb - 10logBW - 43.50 dB		_____ dBc/Hz	-100 dBc/Hz (HP 83712B)
		_____ dBc/Hz	-99 dBc/Hz (HP 83712A)
@ 500 MHz Vb (for dynamic signal analyzer) = _____ dBm			
@ 100 Hz Offset Vs (Measured Level @ 100 Hz Offset) = _____ Constants = -46.00 dB Calculated Phase Noise (@ 100 Hz Offset)= Vs - Vb - 10logBW -46 dB		_____ dBc/Hz	-78 dBc/Hz (HP 83712B)
		_____ dBc/Hz	-70 dBc/Hz (HP 83712A)

Test	Minimum	Actual	Maximum
<p>@ 1 kHz Offset Vs (Measured Level @ 1 kHz Offset) = _____ Constants = -46.00 dB Calculated Phase Noise (@ 1 kHz Offset)= Vs - Vb - 10logBW -46 dB</p> <p>@ 10 kHz Offset Vs (Measured Level @ 10 kHz Offset) = _____ Constants = -46.00 dB Calculated Phase Noise (@ 10 kHz Offset)= Vs - Vb - 10logBW -46 dB</p> <p>@ 100 kHz Offset Vb (for spectrum analyzer) = _____ dBm Constants = -43.50 dB Vs (Measured Level @ 100 kHz Offset) = _____ Calculated Phase Noise (@ 100 kHz Offset) = Vs - Vb - 10logBW - 43.50 dB</p>		<p>_____ dBc/Hz</p> <p>_____ dBc/Hz</p> <p>_____ dBc/Hz</p> <p>_____ dBc/Hz</p> <p>_____ dBc/Hz</p> <p>_____ dBc/Hz</p>	<p>-92 dBc/Hz (HP 83712B)</p> <p>-86 dBc/Hz (HP 83712A)</p> <p>-103 dBc/Hz (HP 83712B)</p> <p>-103 dBc/Hz (HP 83712A)</p> <p>-115 dBc/Hz (HP 83712B)</p> <p>-119 dBc/Hz (HP 83712A)</p>
<p>NON-HARMONIC SPURS 3 - 30 kHz</p> <p>@17005.111 MHz Vb (from "To Calibrate the System") = _____ dBm Total Correction Factor = - Vb - 46.00 dB = _____ dB for 3 kHz to 8 kHz Span Vs (Measured Level) = _____ dBm Calculated Spurious Level = Total Correction Factor + Vs Noise ___ or Offset Frequency _____ dBm</p> <p>for 8 kHz to 13 kHz Span Vs (Measured Level) = _____ dBm Calculated Spurious Level = Total Correction Factor + Vs Noise ___ or Offset Frequency _____ dBm</p> <p>for 13 kHz to 23 kHz Span Vs (Measured Level) = _____ dBm Calculated Spurious Level = Total Correction Factor + Vs Noise ___ or Offset Frequency _____ dBm</p> <p>for 23 kHz to 33 kHz Span Vs (Measured Level) = _____ dBm Calculated Spurious Level = Total Correction Factor + Vs Noise ___ or Offset Frequency _____ dBm</p>		<p>_____ dBc</p> <p>_____ dBc</p> <p>_____ dBc</p> <p>_____ dBc</p>	<p>-60 dBc</p> <p>-60 dBc</p> <p>-60 dBc</p> <p>-60 dBc</p>

Test	Minimum	Actual	Maximum
<p>@17501.777 MHz Vb (from "To Calibrate the System") = _____ dBm Total Correction Factor = - Vb - 46.00 dB = _____ dB</p> <p>for 3 kHz to 8 kHz Span Vs (Measured Level) = _____ dBm Calculated Spurious Level = Total Correction Factor + Vs Noise ___ or Offset Frequency _____ dBm</p> <p>for 8 kHz to 13 kHz Span Vs (Measured Level) = _____ dBm Calculated Spurious Level = Total Correction Factor + Vs</p> <p>for 13 kHz to 23 kHz Span Vs (Measured Level) = _____ dBm Calculated Spurious Level = Total Correction Factor + Vs Noise ___ or Offset Frequency _____ dBm</p> <p>for 23 kHz to 33 kHz Span Vs (Measured Level) = _____ dBm Calculated Spurious Level = Total Correction Factor + Vs Noise ___ or Offset Frequency _____ dBm</p>		<p>_____ dBc</p> <p>_____ dBc</p> <p>_____ dBc</p> <p>_____ dBc</p>	<p>-60 dBc</p> <p>-60 dBc</p> <p>-60 dBc</p> <p>-60 dBc</p>
<p>NON-HARMONIC SPURS >30 kHz Is the spurious level no greater than -60 dBc for the following frequencies and spans?</p> <p>@17005.111 MHz @17501.777 MHz @19801.511 MHz @10 MHz @8.74 MHz @11.26 MHz @63 MHz @61.74 MHz @64.26 MHz @499 MHz @497.74 MHz @500.26 MHz @500 MHz @498.74 MHz @501.74 MHz @999 MHz @997.74 MHz @1000.26 MHz</p>		<p>yes/no</p> <p>yes/no</p> <p>yes/no</p> <p>yes/no</p> <p>yes/no</p> <p>yes/no</p> <p>yes/no</p> <p>yes/no</p> <p>yes/no</p> <p>yes/no</p> <p>yes/no</p> <p>yes/no</p> <p>yes/no</p> <p>yes/no</p> <p>yes/no</p> <p>yes/no</p> <p>yes/no</p> <p>yes/no</p>	

HP 83731A/31B Test Record

Test Facility _____	Report Number _____
_____	Date _____
_____	Customer _____
_____	Tested By _____
Model _____	Ambient Temperature _____ °C
Serial Number _____	Relative Humidity _____ %
Options _____	Line Frequency _____ Hz (nominal)
Firmware Revision _____	
Special Notes:	

Model _____	Report Number _____	Date _____	
Test Equipment Used	Model Number	Trace Number	Cal Due Date
1. Digital Oscilloscope	_____	_____	_____
2. Measuring Receiver	_____	_____	_____
3. Power Sensor	_____	_____	_____
4. Power Sensor (lowband)	_____	_____	_____
5. Power Meter	_____	_____	_____
6. Microwave Frequency Counter	_____	_____	_____
7. Function Generator	_____	_____	_____
8. Frequency Counter	_____	_____	_____
9. Frequency Standard	_____	_____	_____
10. Digital Voltmeter	_____	_____	_____
11. Spectrum Analyzer	_____	_____	_____
12. Pulse/Function Generator	_____	_____	_____
13. _____	_____	_____	_____
14. _____	_____	_____	_____
15. _____	_____	_____	_____
16. _____	_____	_____	_____
17. _____	_____	_____	_____
18. _____	_____	_____	_____

Test	Minimum	Actual	Maximum
SELF TEST		pass/fail	
INTERNAL TIMEBASE AGING RATE Option 1E5		_____	1.5x10 ⁻⁹
FREQUENCY RANGE AND RESOLUTION			
1.000 000 000 GHz			
without Option 1E8	999 999 900 Hz	_____	1 000 000 100 Hz
with Option 1E8	999 999 999 Hz	_____	1 000 000 001 Hz
One Step Resolution			
without Option 1E8	1 000 001 000 Hz	_____	1 000 001 100 Hz
with Option 1E8	1 000 000 000 Hz	_____	1 000 000 002 Hz
20.000 000 000 GHz			
without Option 1E8	19 999 999 900 Hz	_____	20 000 000 100 Hz
with Option 1E8	19 999 999 999 Hz	_____	20 000 000 001 Hz
EXTERNAL ALC			
Does the signal remain leveled?		yes/no	
MAXIMUM LEVELED POWER			
For the following frequencies, is Unleveled Indicator off, and does power meter read: ≥ +11 dBm (+10 dBm with Option 1E1)?			
1.0 GHz		yes/no	
1.64 GHz		yes/no	
2.74 GHz		yes/no	
4.79 GHz		yes/no	
5.99 GHz		yes/no	
7.99 GHz		yes/no	
9.99 GHz		yes/no	
10.00 GHz		yes/no	
12.79 GHz		yes/no	
13.99 GHz		yes/no	
17.99 GHz		yes/no	

Test	Minimum	Actual	Maximum
<p>For the following frequencies, is Unleveled Indicator off, and does power meter read: $\geq +10$ dBm (+8 dBm with Option 1E1)?</p> <p>19.00 GHz 19.20 GHz 19.30 GHz 19.40 GHz 19.50 GHz 19.60 GHz 19.70 GHz 19.80 GHz 19.90 GHz 20.00 GHz</p>		<p>yes/no yes/no yes/no yes/no yes/no yes/no yes/no yes/no yes/no</p>	
<p>VERNIER LEVEL ACCURACY</p> <p>1.033 GHz +8 dBm +6 dBm -3.9 dBm</p> <p>5.225 GHz +8 dBm +6 dBm -3.9 dBm</p> <p>9.487 GHz +8 dBm +6 dBm -3.9 dBm</p> <p>13.75 GHz +8 dBm +6 dBm -3.9 dBm</p> <p>18.00 GHz +8 dBm +6 dBm -3.9 dBm</p>	<p>+7.0 dBm +5.0 dBm -4.9 dBm</p> <p>+7.0 dBm +5.0 dBm -4.9 dBm</p> <p>+7.0 dBm +5.0 dBm -4.9 dBm</p> <p>+7.0 dBm +5.0 dBm -4.9 dBm</p> <p>+7.0 dBm +5.0 dBm -4.9 dBm</p>	<p>_____</p> <p>_____</p> <p>_____</p> <p>_____</p> <p>_____</p> <p>_____</p> <p>_____</p> <p>_____</p> <p>_____</p> <p>_____</p>	<p>+9 dBm +7. dBm -2.9 dBm</p> <p>+9 dBm +7. dBm -2.9 dBm</p> <p>+9 dBm +7. dBm -2.9 dBm</p> <p>+9 dBm +7. dBm -2.9 dBm</p> <p>+9 dBm +7. dBm -2.9 dBm</p>

Test	Minimum	Actual	Maximum
20.00 GHz (Option 1E9 only)			
+ 8 dBm	+ 7.0 dBm	_____	+ 9 dBm
+ 6 dBm	+ 5.0 dBm	_____	+ 7. dBm
-3.9 dBm	-4.9 dBm	_____	-2.9 dBm
FLATNESS		_____	1 dB
LOW LEVEL ACCURACY and FLATNESS			
Power Meter Readings at 1.5 GHz			
-24 dBm	-26 dBm	_____ (dBm)	-22 dBm
-14 dBm	-16 dBm	_____ (dBm)	-12 dBm
-4 dBm	-5 dBm	_____ (dBm)	-3 dBm
+ 5 dBm = ABS@1.5 GHz	+ 4 dBm	_____ (dBm)	+ 6 dBm
Measuring Receiver Relative Readings at 1.5 GHz			
-34 dBm setting = REL@-34 dBm = _____			
-44 dBm setting = REL@-44 dBm = _____			
-54 dBm setting = REL@-54 dBm = _____			
-64 dBm setting = REL@-64 dBm = _____			
-74 dBm setting = REL@-74 dBm = _____			
-84 dBm setting = REL@-84 dBm = _____			
-90 dBm setting = REL@-90 dBm = _____			
-95 dBm setting = REL@-95 dBm = _____			
-105 dBm setting = REL@-105 dBm = _____			
Calculated Actual Power Levels at 1.5 GHz			
ABS@1.5 GHz + REL@-34 dBm = ACT@-34 dBm	-36 dBm	_____ (dBm)	-32 dBm
ABS@1.5 GHz + REL@-44 dBm = ACT@-44 dBm	-46 dBm	_____ (dBm)	-42 dBm
ABS@1.5 GHz + REL@-54 dBm = ACT@-54 dBm	-56 dBm	_____ (dBm)	-52 dBm
ABS@1.5 GHz + REL@-64 dBm = ACT@-64 dBm	-66 dBm	_____ (dBm)	-62 dBm
ABS@960.272MHz + REL@-74 dBm = ACT@-74 dBm	-76 dBm	_____ (dBm)	-72 dBm
ABS@960.272MHz + REL@-84 dBm = ACT@-84 dBm	-86 dBm	_____ (dBm)	-82 dBm
ABS@960.272MHz + REL@-90 dBm = ACT@-90 dBm	-92 dBm	_____ (dBm)	-88 dBm
ABS@960.272MHz + REL@-95 dBm = ACT@-95 dBm	-97.5 dBm	_____ (dBm)	-92.5 dBm
ABS@960.272MHz + REL@-105 dBm -5 dBm = ACT@-105 dBm	-107.5 dBm	_____ (dBm)	-102.5 dBm

Test	Minimum	Actual	Maximum
5.225 GHz			
Power Meter Readings			
-14 dBm	-16 dBm	_____ (dBm)	-12 dBm
+5 dBm = ABS@5.225 GHz	+4 dBm	_____ (dBm)	+6 dBm
Measuring Receiver Relative Readings			
-90 dBm setting = REL@-90 dBm = _____			
-105 dBm setting = REL@-105 dBm = _____			
Calculated Actual Power Level			
ABS@5.225 GHz + REL@-90 dBm = ACT@-90 dBm	-92 dBm	_____ (dBm)	-88 dBm
ABS@5.225 GHz + REL@-105 dBm -5 dBm = ACT@-105 dBm	-107.5 dBm	_____ (dBm)	-102.5 dBm
9.487 GHz			
Power Meter Readings			
-14 dBm	-16 dBm	_____ (dBm)	-12 dBm
+5 dBm = ABS@9.487 GHz	+4 dBm	_____ (dBm)	+6 dBm
Measuring Receiver Relative Reading			
-90 dBm setting = REL@-90 dBm = _____			
-105 dBm setting = REL@-105 dBm = _____			
Calculated Actual Power Level			
ABS@9.487 GHz + REL@-90 dBm = ACT@-90 dBm	-92 dBm	_____ (dBm)	-88 dBm
ABS@9.487 GHz + REL@-105 dBm -5 dBm = ACT@-105 dBm	-107.5 dBm	_____ (dBm)	-102.5 dBm
13.75 GHz			
Power Meter Readings			
-14 dBm	-16 dBm	_____ (dBm)	-12 dBm
+5 dBm = ABS@13.75 GHz	+4 dBm	_____ (dBm)	+6 dBm
+10 dBm = ABS@13.75 GHz	+9 dBm	_____ (dBm)	+11 dBm
Measuring Receiver Relative Reading			
-90 dBm setting = REL@-90 dBm = _____			
-105 dBm setting = REL@-105 dBm = _____			

Test	Minimum	Actual	Maximum
Calculated Actual Power Level			
ABS@13.75 GHz + REL@-90 dBm = ACT@-90 dBm	-92 dBm	_____ (dBm)	-88 dBm
ABS@13.75 GHz + REL@-105 dBm -5 dBm = ACT@-105 dBm	-107.5 dBm	_____ (dBm)	-102.5 dBm
Power Meter Readings at 18 GHz			
-24 dBm	-26 dBm	_____ (dBm)	-22 dBm
-14 dBm	-16 dBm	_____ (dBm)	-12 dBm
-4 dBm	-5 dBm	_____ (dBm)	-3 dBm
+5 dBm = ABS@18 GHz	+4 dBm	_____ (dBm)	+6 dBm
Measuring Receiver Relative Readings at 18 GHz			
-34 dBm setting = REL@-34 dBm = _____			
-44 dBm setting = REL@-44 dBm = _____			
-54 dBm setting = REL@-54 dBm = _____			
-64 dBm setting = REL@-64 dBm = _____			
-74 dBm setting = REL@-74 dBm = _____			
-84 dBm setting = REL@-84 dBm = _____			
-90 dBm setting = REL@-90 dBm = _____			
-95 dBm setting = REL@-95 dBm = _____			
-105 dBm setting = REL@-105 dBm = _____			
Calculated Actual Power Levels at 18 GHz			
ABS@18 GHz + REL@-34 dBm = ACT@-34 dBm	-36 dBm	_____ (dBm)	-32 dBm
ABS@18 GHz + REL@-44 dBm = ACT@-44 dBm	-46 dBm	_____ (dBm)	-42 dBm
ABS@18 GHz + REL@-54 dBm = ACT@-54 dBm	-56 dBm	_____ (dBm)	-52 dBm
ABS@18 GHz + REL@-64 dBm = ACT@-64 dBm	-66 dBm	_____ (dBm)	-62 dBm
ABS@18 GHz + REL@-74 dBm = ACT@-74 dBm	-76 dBm	_____ (dBm)	-72 dBm
ABS@18 GHz + REL@-84 dBm = ACT@-84 dBm	-86 dBm	_____ (dBm)	-82 dBm
ABS@18 GHz + REL@-90 dBm = ACT@-90 dBm	-92 dBm	_____ (dBm)	-88 dBm
ABS@18 GHz + REL@-95 dBm = ACT@-95 dBm	-97.5 dBm	_____ (dBm)	-92.5 dBm
ABS@18 GHz + REL@-105 dBm = ACT@-105 dBm	-107.5 dBm	_____ (dBm)	-102.5 dBm
Flatness Power Meter Readings			
-14 dBm at 1.5 GHz = _____ (dBm)			
-14 dBm at 5.225 GHz = _____ (dBm)			
-14 dBm at 9.487 GHz = _____ (dBm)			
-14 dBm at 13.75 GHz = _____ (dBm)			
-14 dBm at 18.00 GHz = _____ (dBm)			

Test	Minimum	Actual	Maximum
<p>Flatness Calculated Actual Power Levels</p> <p>1.5 GHz ACT@-90 dBm = _____</p> <p>5.225 GHz ACT@-90 dBm = _____</p> <p>9.487 GHz ACT@-90 dBm = _____</p> <p>13.75 GHz ACT@-90 dBm = _____</p> <p>18.00 GHz ACT@-90 dBm = _____</p> <p>Flatness Calculated for HP 83731B</p> <p>1.5 GHz ACT@-105 dBm = _____</p> <p>5.225 GHz ACT@-105 dBm = _____</p> <p>9.487 GHz ACT@-105 dBm = _____</p> <p>13.75 GHz ACT@-105 dBm = _____</p> <p>18.00 GHz ACT@-105 dBm = _____</p> <p>Flatness Calculated for -14 dBm</p> <p>Minimum Power Meter Reading = _____(dBm)</p> <p>Maximum Power Meter Reading = _____(dBm)</p> <p>Maximum Reading - Minimum Reading</p> <p>_____ (dBm)</p> <p>for -90 dBm</p> <p>Minimum Calculated Actual Power = _____(dBm)</p> <p>Maximum Calculated Actual Power = _____(dBm)</p> <p>Maximum Power - Minimum Power</p> <p>_____ (dBm)</p>			<p>1 dBm</p> <p>1 dBm</p>
<p>HARMONICS</p> <p>Carrier Level of -3.9 dBm</p> <p>2nd Harmonic (2.0 GHz)</p> <p>2nd Harmonic (3.30 GHz)</p> <p>2nd Harmonic (5.50 GHz)</p> <p>2nd Harmonic (9.6 GHz)</p> <p>2nd Harmonic (16.0 GHz)</p> <p>2nd Harmonic (19.8 GHz)</p> <p>2nd Harmonic (20.0 GHz)</p>		<p>yes/no</p> <p>yes/no</p> <p>yes/no</p> <p>yes/no</p> <p>yes/no</p> <p>yes/no</p> <p>yes/no</p>	<p>-55 dBc</p> <p>-55 dBc</p> <p>-55 dBc</p> <p>-55 dBc</p> <p>-55 dBc</p> <p>-55 dBc</p> <p>-55 dBc</p>

Test	Minimum	Actual	Maximum
Carrier Level of +6 dBm 2nd Harmonic (2.0 GHz) 2nd Harmonic (3.30 GHz) 2nd Harmonic (5.50 GHz) 2nd Harmonic (9.6 GHz) 2nd Harmonic (16.0 GHz) 2nd Harmonic (19.8 GHz) 2nd Harmonic (20.0 GHz)		yes/no yes/no yes/no yes/no yes/no yes/no yes/no	-55 dBc -55 dBc -55 dBc -55 dBc -55 dBc -55 dBc -55 dBc
SINGLE-SIDEBAND PHASE NOISE @ 2 GHz Vb (for dynamic signal analyzer) = _____ dBm @ 100 Hz Offset 10logBW = _____ dB Vs (Measured Level @ 100 Hz Offset) = _____ Constants = -46.00 dB Calculated Phase Noise (@ 100 Hz Offset)= Vs - Vb - 10logBW -46 dB @ 1 kHz Offset Vs (Measured Level @ 1 kHz Offset) = _____ Constants = -46.00 dB Calculated Phase Noise (@ 1 kHz Offset)= Vs - Vb - 10logBW -46 dB @ 10 kHz Offset Vs (Measured Level @ 10 kHz Offset) = _____ Constants = -46.00 dB Calculated Phase Noise (@ 10 kHz Offset)= Vs - Vb - 10logBW -46 dB @ 100 kHz Offset Vb (for spectrum analyzer) = _____ dBm 10logBW = _____ dB Constants = -43.50 dB Vs (Measured Level @ 100 kHz Offset) = _____ Calculated Phase Noise (@ 100 kHz Offset) = Vs - Vb - 10logBW - 43.50 dB		_____ dBc/Hz _____ dBc/Hz _____ dBc/Hz _____ dBc/Hz _____ dBc/Hz _____ dBc/Hz _____ dBc/Hz _____ dBc/Hz	-70 dBc/Hz (HP 83731B) -66 dBc/Hz (HP 83731A) -78 dBc/Hz (HP 83731B) -74 dBc/Hz (HP 83731A) -83 dBc/Hz (HP 83731B) -91 dBc/Hz (HP 83731A) -100 dBc/Hz (HP 83731B) -107 dBc/Hz (HP 83731A)

Test	Minimum	Actual	Maximum
@ 10 GHz Vb (for dynamic signal analyzer) = _____ dBm			
@ 100 Hz Offset Vs (Measured Level @ 100 Hz Offset) = _____ Constants = -46.00 dB Calculated Phase Noise (@ 100 Hz Offset) = $V_s - V_b - 10\log BW - 46 \text{ dB}$		_____ dBc/Hz _____ dBc/Hz	-65 dBc/Hz (HP 83731B) -69 dBc/Hz (HP 83731A)
@ 1 kHz Offset Vs (Measured Level @ 1 kHz Offset) = _____ Constants = -46.00 dB Calculated Phase Noise (@ 1 kHz Offset) = $V_s - V_b - 10\log BW - 46 \text{ dB}$		_____ dBc/Hz _____ dBc/Hz	-73 dBc/Hz (HP 83731B) -75 dBc/Hz (HP 83731A)
@ 10 kHz Offset Vs (Measured Level @ 10 kHz Offset) = _____ Constants = -46.00 dB Calculated Phase Noise (@ 10 kHz Offset) = $V_s - V_b - 10\log BW - 46 \text{ dB}$		_____ dBc/Hz _____ dBc/Hz	-76 dBc/Hz (HP 83731B) -79 dBc/Hz (HP 83731A)
@ 100 kHz Offset Vb (for spectrum analyzer) = _____ dBm Constants = -43.50 dB Vs (Measured Level @ 100 kHz Offset) = _____ Calculated Phase Noise (@ 100 kHz Offset) = $V_s - V_b - 10\log BW - 43.50 \text{ dB}$		_____ dBc/Hz _____ dBc/Hz	-100 dBc/Hz (HP 83731B) -101 dBc/Hz (HP 83731A)
@ 18 GHz Vb (for dynamic signal analyzer) = _____ dBm			

Test	Minimum	Actual	Maximum
<p>@ 100 Hz Offset Vs (Measured Level @ 100 Hz Offset) = _____ Constants = -46.00 dB Calculated Phase Noise (@ 100 Hz Offset)= Vs - Vb - 10logBW -46 dB</p>		<p>_____ dBc/Hz</p> <p>_____ dBc/Hz</p>	<p>-65 dBc/Hz (HP 83731B)</p> <p>-63 dBc/Hz (HP 83731A)</p>
<p>@ 1 kHz Offset Vs (Measured Level @ 1 kHz Offset) = _____ Constants = -46.00 dB Calculated Phase Noise (@ 1 kHz Offset)= Vs - Vb - 10logBW -46 dB</p>		<p>_____ dBc/Hz</p> <p>_____ dBc/Hz</p>	<p>-73 dBc/Hz (HP 83731B)</p> <p>-70 dBc/Hz (HP 83731A)</p>
<p>@ 10 kHz Offset Vs (Measured Level @ 10 kHz Offset) = _____ Constants = -46.00 dB Calculated Phase Noise (@ 10 kHz Offset)= Vs - Vb - 10logBW -46 dB</p>		<p>_____ dBc/Hz</p> <p>_____ dBc/Hz</p>	<p>-76 dBc/Hz (HP 83731B)</p> <p>-73 dBc/Hz (HP 83731A)</p>
<p>@ 100 kHz Offset Vb (for spectrum analyzer) = _____ dBm Constants = -43.50 dB Vs (Measured Level @ 100 kHz Offset) = _____ Calculated Phase Noise (@ 100 kHz Offset) = Vs - Vb - 10logBW - 43.50 dB</p>		<p>_____ dBc/Hz</p> <p>_____ dBc/Hz</p>	<p>-100 dBc/Hz (HP 83731B)</p> <p>-99 dBc/Hz (HP 83731A)</p>
<p>NON-HARMONIC SPURS 3 - 30 kHz @17005.111 MHz Vb (from "To Calibrate the System") = _____ dBm Total Correction Factor = - Vb - 46.00 dB = _____ dB</p> <p>for 3 kHz to 8 kHz Span Vs (Measured Level) = _____ dBm Calculated Spurious Level = Total Correction Factor + Vs Noise ___ or Offset Frequency _____ dBm</p>		<p>_____ dBc</p>	<p>-60 dBc</p>

Test	Minimum	Actual	Maximum
for 8 kHz to 13 kHz Span Vs (Measured Level) = _____ dBm Calculated Spurious Level = Total Correction Factor + Vs _____ dBc			-60 dBc
for 13 kHz to 23 kHz Span Vs (Measured Level) = _____ dBm Calculated Spurious Level = Total Correction Factor + Vs _____ dBc			-60 dBc
Noise ___ or Offset Frequency _____ dBm for 23 kHz to 33 kHz Span Vs (Measured Level) = _____ dBm Calculated Spurious Level = Total Correction Factor + Vs _____ dBc			-60 dBc
@17501.777 MHz Vb (from "To Calibrate the System") = _____ dBm Total Correction Factor = -Vb - 46.00 dB = _____ dB			
for 3 kHz to 8 kHz Span Vs (Measured Level) = _____ dBm Calculated Spurious Level = Total Correction Factor + Vs _____ dBc			-60 dBc
Noise ___ or Offset Frequency _____ dBm for 8 kHz to 13 kHz Span Vs (Measured Level) = _____ dBm Calculated Spurious Level = Total Correction Factor + Vs _____ dBc			-60 dBc
for 13 kHz to 23 kHz Span Vs (Measured Level) = _____ dBm Calculated Spurious Level = Total Correction Factor + Vs _____ dBc			-60 dBc
Noise ___ or Offset Frequency _____ dBm for 23 kHz to 33 kHz Span Vs (Measured Level) = _____ dBm Calculated Spurious Level = Total Correction Factor + Vs _____ dBc			-60 dBc
NON-HARMONIC SPURS >30 kHz Is the spurious level no greater than -60 dBc for the following frequencies and spans? @17005.111 MHz @17501.777 MHz @19801.511 MHz		yes/no yes/no yes/no	
PULSE ON/OFF RATIO 1 GHz 20 GHz		yes/no yes/no	-80 dBc -80 dBc

Test	Minimum	Actual	Maximum
PULSE RISE/FALLTIME 1-20 GHz Rise Time Fall Time		_____(ns) _____(ns)	10 ns 10 ns
PULSE WIDTH Pulse Width (@ 1 GHz)		_____(ns)	25 ns
FM DEVIATION 2 GHz Does spectrum fill 8 center graticules symmetrically? 10 GHz Does spectrum fill 8 center graticules symmetrically? 1 GHz Does spectrum fill 8 center graticules symmetrically?		yes/no yes/no yes/no	
FM RATE AND FLATNESS 6 GHz CW Frequency @100 kHz First 1st Sideband Null f100kHz = _____ kHz V100kHz = _____ m @100 kHz Fourth 1st Sideband Null f100kHz = _____ kHz V100kHz = _____ mV @1 kHz First 1st Sideband Null fx = _____ kHz Vx = _____ mV @5 kHz Fourth 1st Sideband Null fx = _____ kHz Vx = _____ mV @1 MHz First 1st Sideband Null fx = _____ kHz Vx = _____ mV Relative FM Response @1kHz = $20\log(Vx/V100kHz) - 20\log(fx/f100kHz) =$ _____			

Test	Minimum	Actual	Maximum
Relative FM Response @5kHz = $20\log(V_x/V_{100kHz}) - 20\log(f_x/f_{100kHz}) = \underline{\hspace{2cm}}$			
Relative FM Response @1MHz = $20\log(V_x/V_{100kHz}) - 20\log(f_x/f_{100kHz}) = \underline{\hspace{2cm}}$			
Calculated FM Flatness for 18 GHz CW Frequency =		$\underline{\hspace{2cm}}$	4 dB
18 GHz CW Frequency			
@100 kHz First 1st Sideband Null			
f100kHz = $\underline{\hspace{1cm}}$ kHz			
V100kHz = $\underline{\hspace{1cm}}$ mVrms			
@100 kHz Fourth 1st Sideband Null			
f100kHz = $\underline{\hspace{1cm}}$ kHz			
V100kHz = $\underline{\hspace{1cm}}$ mVrms			
@1 kHz First 1st Sideband Null			
f _x = $\underline{\hspace{1cm}}$ kHz			
V _x = $\underline{\hspace{1cm}}$ mVrms			
@5 kHz Fourth 1st Sideband Null			
f _x = $\underline{\hspace{1cm}}$ kHz			
V _x = $\underline{\hspace{1cm}}$ mVrms			
@1 MHz First 1st Sideband Null			
f _x = $\underline{\hspace{1cm}}$ kHz			
V _x = $\underline{\hspace{1cm}}$ mVrms			
Relative FM Response @1kHz = $20\log(V_x/V_{100kHz}) - 20\log(f_x/f_{100kHz}) = \underline{\hspace{2cm}}$			
Relative FM Response @5kHz = $20\log(V_x/V_{100kHz}) - 20\log(f_x/f_{100kHz}) = \underline{\hspace{2cm}}$			
Relative FM Response @1MHz = $20\log(V_x/V_{100kHz}) - 20\log(f_x/f_{100kHz}) = \underline{\hspace{2cm}}$			

Test	Minimum	Actual	Maximum
Calculated FM Flatness for 18 GHz CW Frequency =		_____	4 dB
PM RATE AND FLATNESS (1 rad/V) 6 GHz CW Frequency @1 kHz Carrier Null V1kHz = _____ mVrms @20 kHz Carrier Null Vx = _____ mVrms @100 kHz Carrier Null Vx = _____ mVrms Relative PM Response @20kHz = $20\log(Vx/V1kHz)$ = _____ dB Relative PM Response @100kHz = $20\log(Vx/V1kHz)$ = _____ dB Calculated PM Flatness for 6 GHz CW Frequency =		_____	2 dB
PM RATE AND FLATNESS (1 rad/V) 18 GHz CW Frequency @1 kHz Carrier Null V1kHz = _____ mVrms @20 kHz Carrier Null Vx = _____ mVrms @100 kHz Carrier Null Vx = _____ mVrms Relative PM Response @20kHz = $20\log(Vx/V1kHz)$ = _____ dB Relative PM Response @100kHz = $20\log(Vx/V1kHz)$ = _____ dB Calculated PM Flatness for 18 GHz CW Frequency =		_____	2 dB

Test	Minimum	Actual	Maximum
PM RATE AND FLATNESS (50 rad/V) 6 GHz CW Frequency @100 Hz Carrier Null V100 Hz = _____ mVrms @1 kHz Carrier Null Vx = _____ mVrms @30 kHz Carrier Null Vx = _____ mVrms Relative PM Response @20kHz = $20\log(Vx/V100 \text{ Hz}) =$ _____ dB Relative PM Response @100kHz = $20\log(Vx/V100 \text{ Hz}) =$ _____ dB Calculated PM Flatness for 6 GHz CW Frequency = _____		_____	4 dB
PM RATE AND FLATNESS (50 rad/V) 18 GHz CW Frequency @100 Hz Carrier Null V100 Hz = _____ mVrms @1 kHz Carrier Null Vx = _____ mVrms @30 kHz Carrier Null Vx = _____ mVrms Relative PM Response @20kHz = $20\log(Vx/V100 \text{ Hz}) =$ _____ dB Relative PM Response @100kHz = $20\log(Vx/V100 \text{ Hz}) =$ _____ dB Calculated PM Flatness for 18 GHz CW Frequency = _____		_____	4 dB
MINIMUM AM DEPTH	60 dBc	yes/no	
MINIMUM LINEAR AM DEPTH (100%/V)	20 dBc	yes/no	
INTERNAL AM RATE 0.5 Hz 20 kHz	0.4 Hz 19.8 kHz	_____ _____	0.6 Hz 20.2 kHz
INTERNAL FM SOURCE VERIFICATION		pass/fail	

HP 83732A/32B Test Record

Test Facility _____	Report Number _____
_____	Date _____
_____	Customer _____
_____	Tested By _____
Model _____	Ambient Temperature _____ °C
Serial Number _____	Relative Humidity _____ %
Options _____	Line Frequency _____ Hz (nominal)
Firmware Revision _____	
Special Notes:	

Model _____	Report Number _____	Date _____	
Test Equipment Used	Model Number	Trace Number	Cal Due Date
1. Digital Oscilloscope	_____	_____	_____
2. Measuring Receiver	_____	_____	_____
3. Power Sensor	_____	_____	_____
4. Power Sensor (lowband)	_____	_____	_____
5. Power Meter	_____	_____	_____
6. Microwave Frequency Counter	_____	_____	_____
7. Function Generator	_____	_____	_____
8. Frequency Counter	_____	_____	_____
9. Frequency Standard	_____	_____	_____
10. Digital Voltmeter	_____	_____	_____
11. Spectrum Analyzer	_____	_____	_____
12. Pulse/Function Generator	_____	_____	_____
13. _____	_____	_____	_____
14. _____	_____	_____	_____
15. _____	_____	_____	_____
16. _____	_____	_____	_____
17. _____	_____	_____	_____
18. _____	_____	_____	_____

Test	Minimum	Actual	Maximum
SELF TEST		pass/fail	
INTERNAL TIMEBASE AGING RATE Option 1E5		_____	1.5×10^{-9}
FREQUENCY RANGE AND RESOLUTION			
010 000 000 Hz			
without Option 1E8	9 999 900 Hz	_____	010 000 100 Hz
with Option 1E8	9 999 999 Hz	_____	010 000 001 Hz
One Step Resolution			
without Option 1E8	010 000 900 Hz	_____	010 001 100 Hz
with Option 1E8	010 000 000 Hz	_____	010 000 002 Hz
20.000 000 000 GHz			
without Option 1E8	19 999 999 900 Hz	_____	20 000 000 100 Hz
with Option 1E8	19 999 999 999 Hz	_____	20 000 000 001 Hz
EXTERNAL ALC			
Does the signal remain leveled?		yes/no	
MAXIMUM LEVELED POWER			
For the following frequencies, is Unleveled Indicator off, and does power meter read: $\geq +11$ dBm (+10 dBm with Option 1E1)?			
1.0 GHz		yes/no	
1.64 GHz		yes/no	
2.74 GHz		yes/no	
4.79 GHz		yes/no	
5.99 GHz		yes/no	
7.99 GHz		yes/no	
9.99 GHz		yes/no	
10.00 GHz		yes/no	
12.79 GHz		yes/no	
13.99 GHz		yes/no	
17.99 GHz		yes/no	

Test	Minimum	Actual	Maximum
<p>For the following frequencies, is Unleveled Indicator off, and does power meter read: $\geq +10$ dBm (+8 dBm with Option 1E1)?</p> <p>19.00 GHz 19.20 GHz 19.30 GHz 19.40 GHz 19.50 GHz 19.60 GHz 19.70 GHz 19.80 GHz 19.90 GHz 20.00 GHz</p>		<p>yes/no yes/no yes/no yes/no yes/no yes/no yes/no yes/no yes/no yes/no</p>	
<p>For the following frequencies, is Unleveled Indicator off, and does power meter read: $\geq +13$ dBm?</p> <p>10 MHz 11.2 MHz 11.3 MHz 15.9MHz 16 MHz 22.5 MHz 22.6 MHz 31.9 MHz 32 MHz 45.3MHz 45.4 MHz 63.9 MHz 64 MHz 90.4 MHz 90.5 MHz 127.9 MHz 128 MHz</p>		<p>yes/no yes/no yes/no yes/no yes/no yes/no yes/no yes/no yes/no yes/no yes/no yes/no yes/no yes/no yes/no yes/no</p>	

Test	Minimum	Actual	Maximum
180.9 MHz		yes/no	
181 MHz		yes/no	
255.9 MHz		yes/no	
256 MHz		yes/no	
361.9 MHz		yes/no	
362 MHz		yes/no	
499.9 MHz		yes/no	
500 MHz		yes/no	
699.9 MHz		yes/no	
700 MHz		yes/no	
999 MHz		yes/no	
VERNIER LEVEL ACCURACY			
10.1 MHz			
+ 8 dBm	+ 6.7 dBm	_____	+ 9.3 dBm
+ 6 dBm	+ 4.7 dBm	_____	+ 7.3 dBm
- 3.9 dBm	- 4.6 dBm	_____	- 2.6 dBm
18.192 MHz			
+ 8 dBm	+ 6.7 dBm	_____	+ 9.3 dBm
+ 6 dBm	+ 4.7 dBm	_____	+ 7.3 dBm
- 3.9 dBm	- 4.6 dBm	_____	- 2.6 dBm
329.488 MHz			
+ 8 dBm	+ 7.0 dBm	_____	+ 9 dBm
+ 6 dBm	+ 5.0 dBm	_____	+ 7. dBm
- 3.9 dBm	- 4.9 dBm	_____	- 2.9 dBm
657.168 MHz			
+ 8 dBm	+ 7.0 dBm	_____	+ 9 dBm
+ 6 dBm	+ 5.0 dBm	_____	+ 7. dBm
- 3.9 dBm	- 4.9 dBm	_____	- 2.9 dBm
984.848 MHz			
+ 8 dBm	+ 7.0 dBm	_____	+ 9 dBm
+ 6 dBm	+ 5.0 dBm	_____	+ 7. dBm
- 3.9 dBm	- 4.9 dBm	_____	- 2.9 dBm

Test	Minimum	Actual	Maximum
1.033 GHz			
+ 8 dBm	+ 7.0 dBm	_____	+ 9 dBm
+ 6 dBm	+ 5.0 dBm	_____	+ 7. dBm
- 3.9 dBm	- 4.9 dBm	_____	- 2.9 dBm
5.225 GHz			
+ 8 dBm	+ 7.0 dBm	_____	+ 9 dBm
+ 6 dBm	+ 5.0 dBm	_____	+ 7. dBm
- 3.9 dBm	- 4.9 dBm	_____	- 2.9 dBm
9.487 GHz			
+ 8 dBm	+ 7.0 dBm	_____	+ 9 dBm
+ 6 dBm	+ 5.0 dBm	_____	+ 7. dBm
- 3.9 dBm	- 4.9 dBm	_____	- 2.9 dBm
13.75 GHz			
+ 8 dBm	+ 7.0 dBm	_____	+ 9 dBm
+ 6 dBm	+ 5.0 dBm	_____	+ 7. dBm
- 3.9 dBm	- 4.9 dBm	_____	- 2.9 dBm
18.00 GHz			
+ 8 dBm	+ 7.0 dBm	_____	+ 9 dBm
+ 6 dBm	+ 5.0 dBm	_____	+ 7. dBm
- 3.9 dBm	- 4.9 dBm	_____	- 2.9 dBm
20.00 GHz (Option 1E9 only)			
+ 8 dBm	+ 7.0 dBm	_____	+ 9 dBm
+ 6 dBm	+ 5.0 dBm	_____	+ 7. dBm
- 3.9 dBm	- 4.9 dBm	_____	- 2.9 dBm
FLATNESS 0.01 - 1 GHz			
+ 8 dBm		_____	< 1 dB
+ 6 dBm		_____	< 1 dB
- 3.9 dBm		_____	< 1 dB
FLATNESS 1 - 20 GHz			
+ 8 dBm		_____	< 1 dB
+ 6 dBm		_____	< 1 dB
- 3.9 dBm		_____	< 1 dB

Test	Minimum	Actual	Maximum
LOW LEVEL ACCURACY and FLATNESS			
Power Meter Readings at 42.768 MHz			
-24 dBm	-26.3 dBm	_____ (dBm)	-21.7 dBm
-14 dBm	-16.3 dBm	_____ (dBm)	-11.7 dBm
-4 dBm	-5 dBm	_____ (dBm)	-3 dBm
+5 dBm = ABS@42.768MHz	+4 dBm	_____ (dBm)	+6 dBm
Measuring Receiver Relative Readings at 42.768 MHz			
-34 dBm setting = REL@-34 dBm = _____			
-44 dBm setting = REL@-44 dBm = _____			
-54 dBm setting = REL@-54 dBm = _____			
-64 dBm setting = REL@-64 dBm = _____			
-74 dBm setting = REL@-74 dBm = _____			
-84 dBm setting = REL@-84 dBm = _____			
-90 dBm setting = REL@-90 dBm = _____			
-95 dBm setting = REL@-95 dBm = _____			
-105 dBm setting = REL@-105 dBm = _____			
Calculated Actual Power Levels at 42.768 MHz			
ABS@42.768MHz + REL@-34 dBm = ACT@-34 dBm	-36.3 dBm	_____ (dBm)	-31.7 dBm
ABS@42.768MHz + REL@-44 dBm = ACT@-44 dBm	-46.3 dBm	_____ (dBm)	-41.7 dBm
ABS@42.768MHz + REL@-54 dBm = ACT@-54 dBm	-56.3 dBm	_____ (dBm)	-51.7 dBm
ABS@42.768MHz + REL@-64 dBm = ACT@-64 dBm	-66.3 dBm	_____ (dBm)	-61.7 dBm
ABS@42.768MHz + REL@-74 dBm = ACT@-74 dBm	-76.3 dBm	_____ (dBm)	-71.7 dBm
ABS@42.768MHz + REL@-84 dBm = ACT@-84 dBm	-86.3 dBm	_____ (dBm)	-81.7 dBm
ABS@42.768MHz + REL@-90 dBm = ACT@-90 dBm	-92.3 dBm	_____ (dBm)	-87.7 dBm
ABS@42.768MHz + REL@-95 dBm = ACT@-95 dBm	-97.5 dBm	_____ (dBm)	-92.5 dBm
ABS@42.768MHz + REL@-105 dBm -5 dBm = ACT@-105 dBm	-107.5 dBm	_____ (dBm)	-102.5 dBm
304.912 MHz			
Power Meter Readings			
-14 dBm	-16 dBm	_____ (dBm)	-12 dBm
+5 dBm = ABS@304.912MHz	+4 dBm	_____ (dBm)	+6 dBm
Measuring Receiver Relative Readings			
-90 dBm setting = REL@-90 dBm = _____			
-105 dBm setting = REL@-105 dBm = _____			

Test	Minimum	Actual	Maximum
Calculated Actual Power Levels			
ABS@304.912MHz + REL@-90 dBm = ACT@-90 dBm	-92.0 dBm	_____ (dBm)	-88.0 dBm
ABS@304.912MHz + REL@-105 dBm = ACT@-105 dBm	-107.5 dBm	_____ (dBm)	-102.5 dBm
632.592 MHz			
Power Meter Readings			
-14 dBm	-16 dBm	_____ (dBm)	-12 dBm
+5 dBm = ABS@632.592MHz	+4 dBm	_____ (dBm)	+6 dBm
Measuring Receiver Relative Readings			
-90 dBm setting = REL@-90 dBm = _____			
-105 dBm setting = REL@-105 dBm = _____			
Calculated Actual Power Levels			
ABS@632.592MHz + REL@-90 dBm = ACT@-90 dBm	-92.0 dBm	_____ (dBm)	-88.0 dBm
ABS@632.592MHz + REL@-105 dBm -5 dBm = ACT@-105 dBm	-107.5 dBm	_____ (dBm)	-102.5 dBm
Power Meter Readings at 960.272 MHz			
-24 dBm	-26 dBm	_____ (dBm)	-22 dBm
-14 dBm	-16 dBm	_____ (dBm)	-12 dBm
-4 dBm	-5 dBm	_____ (dBm)	-3 dBm
+5 dBm = ABS@960.272MHz	+4 dBm	_____ (dBm)	+6 dBm
Measuring Receiver Relative Readings at 960.272 MHz			
-34 dBm setting = REL@-34 dBm = _____			
-44 dBm setting = REL@-44 dBm = _____			
-54 dBm setting = REL@-54 dBm = _____			
-64 dBm setting = REL@-64 dBm = _____			
-74 dBm setting = REL@-74 dBm = _____			
-84 dBm setting = REL@-84 dBm = _____			
-90 dBm setting = REL@-90 dBm = _____			
-95 dBm setting = REL@-95 dBm = _____			
-105 dBm setting = REL@-105 dBm = _____			

Test	Minimum	Actual	Maximum
Calculated Actual Power Levels at 960.272 MHz			
ABS@960.272MHz + REL@-34 dBm = ACT@-34 dBm	-36 dBm	_____ (dBm)	-32 dBm
ABS@960.272MHz + REL@-44 dBm = ACT@-44 dBm	-46 dBm	_____ (dBm)	-42 dBm
ABS@960.272MHz + REL@-54 dBm = ACT@-54 dBm	-56 dBm	_____ (dBm)	-52 dBm
ABS@960.272MHz + REL@-64 dBm = ACT@-64 dBm	-66 dBm	_____ (dBm)	-62 dBm
ABS@960.272MHz + REL@-74 dBm = ACT@-74 dBm	-76 dBm	_____ (dBm)	-72 dBm
ABS@960.272MHz + REL@-84 dBm = ACT@-84 dBm	-86 dBm	_____ (dBm)	-82 dBm
ABS@960.272MHz + REL@-90 dBm = ACT@-90 dBm	-92 dBm	_____ (dBm)	-88 dBm
ABS@960.272MHz + REL@-95 dBm = ACT@-95 dBm	-97.5 dBm	_____ (dBm)	-92.5 dBm
ABS@960.272MHz + REL@-105 dBm -5 dBm = ACT@-105 dBm	-107.5 dBm	_____ (dBm)	-102.5 dBm
Power Meter Readings at 1.5 GHz			
-24 dBm	-26 dBm	_____ (dBm)	-22 dBm
-14 dBm	-16 dBm	_____ (dBm)	-12 dBm
-4 dBm	-5 dBm	_____ (dBm)	-3 dBm
+5 dBm = ABS@1.5 GHz	+4 dBm	_____ (dBm)	+6 dBm
Measuring Receiver Relative Readings at 1.5 GHz			
-34 dBm setting = REL@-34 dBm = _____			
-44 dBm setting = REL@-44 dBm = _____			
-54 dBm setting = REL@-54 dBm = _____			
-64 dBm setting = REL@-64 dBm = _____			
-74 dBm setting = REL@-74 dBm = _____			
-84 dBm setting = REL@-84 dBm = _____			
-90 dBm setting = REL@-90 dBm = _____			
-95 dBm setting = REL@-95 dBm = _____			
-105 dBm setting = REL@-105 dBm = _____			
Calculated Actual Power Levels at 1.5 GHz			
ABS@1.5 GHz + REL@-34 dBm = ACT@-34 dBm	-36 dBm	_____ (dBm)	-32 dBm
ABS@1.5 GHz + REL@-44 dBm = ACT@-44 dBm	-46 dBm	_____ (dBm)	-42 dBm
ABS@1.5 GHz + REL@-54 dBm = ACT@-54 dBm	-56 dBm	_____ (dBm)	-52 dBm
ABS@1.5 GHz + REL@-64 dBm = ACT@-64 dBm	-66 dBm	_____ (dBm)	-62 dBm
ABS@960.272MHz + REL@-74 dBm = ACT@-74 dBm	-76 dBm	_____ (dBm)	-72 dBm
ABS@960.272MHz + REL@-84 dBm = ACT@-84 dBm	-86 dBm	_____ (dBm)	-82 dBm
ABS@960.272MHz + REL@-90 dBm = ACT@-90 dBm	-92 dBm	_____ (dBm)	-88 dBm
ABS@960.272MHz + REL@-95 dBm = ACT@-95 dBm	-97.5 dBm	_____ (dBm)	-92.5 dBm
ABS@960.272MHz + REL@-105 dBm -5 dBm = ACT@-105 dBm	-107.5 dBm	_____ (dBm)	-102.5 dBm

Test	Minimum	Actual	Maximum
5.225 GHz			
Power Meter Readings			
-14 dBm	-16 dBm	_____ (dBm)	-12 dBm
+5 dBm = ABS@5.225 GHz	+4 dBm	_____ (dBm)	+6 dBm
Measuring Receiver Relative Readings			
-90 dBm setting = REL@-90 dBm = _____			
-105 dBm setting = REL@-105 dBm = _____			
Calculated Actual Power Level			
ABS@5.225 GHz + REL@-90 dBm = ACT@-90 dBm	-92 dBm	_____ (dBm)	-88 dBm
ABS@5.225 GHz + REL@-105 dBm -5 dBm = ACT@-105 dBm	-107.5 dBm	_____ (dBm)	-102.5 dBm
9.487 GHz			
Power Meter Readings			
-14 dBm	-16 dBm	_____ (dBm)	-12 dBm
+5 dBm = ABS@9.487 GHz	+4 dBm	_____ (dBm)	+6 dBm
Measuring Receiver Relative Reading			
-90 dBm setting = REL@-90 dBm = _____			
-105 dBm setting = REL@-105 dBm = _____			
Calculated Actual Power Level			
ABS@9.487 GHz + REL@-90 dBm = ACT@-90 dBm	-92 dBm	_____ (dBm)	-88 dBm
ABS@9.487 GHz + REL@-105 dBm -5 dBm = ACT@-105 dBm	-107.5 dBm	_____ (dBm)	-102.5 dBm
13.75 GHz			
Power Meter Readings			
-14 dBm	-16 dBm	_____ (dBm)	-12 dBm
+5 dBm = ABS@13.75 GHz	+4 dBm	_____ (dBm)	+6 dBm
Measuring Receiver Relative Reading			
-90 dBm setting = REL@-90 dBm = _____			
-105 dBm setting = REL@-105 dBm = _____			
Calculated Actual Power Level			
ABS@13.75 GHz + REL@-90 dBm = ACT@-90 dBm	-92 dBm	_____ (dBm)	-88 dBm
ABS@13.75 GHz + REL@-105 dBm -5 dBm = ACT@-105 dBm	-107.5 dBm	_____ (dBm)	-102.5 dBm

Test	Minimum	Actual	Maximum
Power Meter Readings at 18 GHz			
-24 dBm	-26 dBm	_____ (dBm)	-22 dBm
-14 dBm	-16 dBm	_____ (dBm)	-12 dBm
-4 dBm	-5 dBm	_____ (dBm)	-3 dBm
+5 dBm = ABS@18 GHz	+4 dBm	_____ (dBm)	+6 dBm
Measuring Receiver Relative Readings at 18 GHz			
-34 dBm setting = REL@-34 dBm = _____			
-44 dBm setting = REL@-44 dBm = _____			
-54 dBm setting = REL@-54 dBm = _____			
-64 dBm setting = REL@-64 dBm = _____			
-74 dBm setting = REL@-74 dBm = _____			
-84 dBm setting = REL@-84 dBm = _____			
-90 dBm setting = REL@-90 dBm = _____			
-95 dBm setting = REL@-95 dBm = _____			
-105 dBm setting = REL@-105 dBm = _____			
Calculated Actual Power Levels at 18 GHz			
ABS@18 GHz + REL@-34 dBm = ACT@-34 dBm	-36 dBm	_____ (dBm)	-32 dBm
ABS@18 GHz + REL@-44 dBm = ACT@-44 dBm	-46 dBm	_____ (dBm)	-42 dBm
ABS@18 GHz + REL@-54 dBm = ACT@-54 dBm	-56 dBm	_____ (dBm)	-52 dBm
ABS@18 GHz + REL@-64 dBm = ACT@-64 dBm	-66 dBm	_____ (dBm)	-62 dBm
ABS@18 GHz + REL@-74 dBm = ACT@-74 dBm	-76 dBm	_____ (dBm)	-72 dBm
ABS@18 GHz + REL@-84 dBm = ACT@-84 dBm	-86 dBm	_____ (dBm)	-82 dBm
ABS@18 GHz + REL@-90 dBm = ACT@-90 dBm	-92 dBm	_____ (dBm)	-88 dBm
ABS@18 GHz + REL@-95 dBm = ACT@-95 dBm	-97.5 dBm	_____ (dBm)	-92.5 dBm
ABS@18 GHz + REL@-105 dBm -5 dBm = ACT@-105 dBm	-107.5 dBm	_____ (dBm)	-102.5 dBm
Flatness Power Meter Readings 10 MHz to 1 GHz			
-14 dBm at 42.768 MHz = _____ (dBm)			
-14 dBm at 304.912 MHz = _____ (dBm)			

Test	Minimum	Actual	Maximum
-14 dBm at 632.592 MHz = _____(dBm)			
-14 dBm at 960.272 MHz = _____(dBm)			
Flatness Power Meter Readings 1 GHz to 18 GHz			
-14 dBm at 1.5 GHz = _____(dBm)			
-14 dBm at 5.225 GHz = _____(dBm)			
-14 dBm at 9.487 GHz = _____(dBm)			
-14 dBm at 13.75 GHz = _____(dBm)			
-14 dBm at 18.00 GHz = _____(dBm)			
Flatness Calculated Actual Power Levels 10 MHz to 1 GHz			
42.768MHz ACT@-90 dBm = _____(dBm)			
304.912 MHz ACT@-90 dBm = _____(dBm)			
632.592MHz ACT@-90 dBm = _____(dBm)			
960.272MHz ACT@-90 dBm = _____(dBm)			
Flatness Calculated Actual Power Levels 10 MHz to 1 GHz			
for HP 83712B			
42.768MHz ACT@-105 dBm = _____(dBm)			
304.912 MHz ACT@-105 dBm = _____(dBm)			
632.592MHz ACT@-105 dBm = _____(dBm)			
960.272MHz ACT@-105 dBm = _____(dBm)			
Flatness Calculated Actual Power Levels 1 GHz to 18 GHz			
1.5 GHz ACT@-90 dBm = _____(dBm)			
5.225 GHz ACT@-90 dBm = _____(dBm)			
9.487 GHz ACT@-90 dBm = _____(dBm)			
13.75 GHz ACT@-90 dBm = _____(dBm)			
18.00 GHz ACT@-90 dBm = _____(dBm)			

Test	Minimum	Actual	Maximum
Flatness Calculated Actual Power Levels 1 GHz to 18 GHz for HP 83712B 1.5 GHz ACT@-105 dBm = _____(dBm) 5.225 GHz ACT@-105 dBm = _____(dBm) 9.487 GHz ACT@-105 dBm = _____(dBm) 13.75 GHz ACT@-105 dBm = _____(dBm) 18.00 GHz ACT@-105 dBm = _____(dBm)			
Flatness Calculated 10 MHz to 1 GHz for -14 dBm Maximum Power Meter Reading = _____(dBm) Minimum Power Meter Reading = _____(dBm) Maximum Reading – Minimum Reading _____(dB)			1 dB
for -90 dBm Maximum Calculated Actual Power = _____(dBm) Minimum Calculated Actual Power = _____(dBm) Maximum Power – Minimum Power			1 dB
for -105 dBm Maximum Calculated Actual Power = _____(dBm) Minimum Calculated Actual Power = _____(dBm) Maximum Power – Minimum Power			1.4 dB

Test	Minimum	Actual	Maximum
Flatness Calculated 1 GHz to 18 GHz for -14 dBm Maximum Power Meter Reading = _____(dBm) Minimum Power Meter Reading = _____(dBm) Maximum Reading – Minimum Reading for -90 dBm Maximum Calculated Actual Power = _____(dBm) Minimum Calculated Actual Power = _____(dBm) Maximum Power – Minimum Power		_____(dB)	1 dB
HARMONICS Carrier Level of -3.9 dBm 2nd Harmonic (20.0 MHz) 2nd Harmonic (22.6 MHz) 2nd Harmonic (32.0 MHz) 2nd Harmonic (45.2 MHz) 2nd Harmonic (64 MHz) 2nd Harmonic (91.0 MHz) 2nd Harmonic (128.0 MHz) 2nd Harmonic (181.0 MHz) 2nd Harmonic (256.0 MHz) 2nd Harmonic (362.0 MHz) 2nd Harmonic (512.0 MHz) 2nd Harmonic (724.0 MHz) 2nd Harmonic (1.0 GHz) 2nd Harmonic (1.4 GHz) 2nd Harmonic (2.0 GHz) 2nd Harmonic (3.3 GHz) 2nd Harmonic (5.5 GHz) 2nd Harmonic (9.6 GHz)		yes/no yes/no yes/no yes/no yes/no yes/no yes/no yes/no yes/no yes/no yes/no yes/no yes/no yes/no yes/no yes/no yes/no yes/no	-55 dBc -55 dBc -55 dBc -55 dBc -55 dBc -55 dBc -55 dBc -55 dBc -55 dBc -55 dBc -55 dBc -55 dBc -55 dBc -55 dBc -55 dBc

Test	Minimum	Actual	Maximum
2nd Harmonic (16.0 GHz)		yes/no	-55 dBc
2nd Harmonic (19.8 GHz)		yes/no	-55 dBc
2nd Harmonic (20.0 GHz)		yes/no	-55 dBc
Carrier Level of + 6.0 dBm			
2nd Harmonic (20.0 MHz)		yes/no	-55 dBc
2nd Harmonic (22.6 MHz)		yes/no	-55 dBc
2nd Harmonic (32.0 MHz)		yes/no	-55 dBc
2nd Harmonic (45.2 MHz)		yes/no	-55 dBc
2nd Harmonic (64 MHz)		yes/no	-55 dBc
2nd Harmonic (91.0 MHz)		yes/no	-55 dBc
2nd Harmonic (128.0 MHz)		yes/no	-55 dBc
2nd Harmonic (181.0 MHz)		yes/no	-55 dBc
2nd Harmonic (256.0 MHz)		yes/no	-55 dBc
2nd Harmonic (362.0 MHz)		yes/no	-55 dBc
2nd Harmonic (512.0 MHz)		yes/no	-55 dBc
2nd Harmonic (724.0 MHz)		yes/no	-55 dBc
2nd Harmonic (1.0 GHz)		yes/no	-55 dBc
2nd Harmonic (1.4 GHz)		yes/no	-55 dBc
2nd Harmonic (2.0 GHz)		yes/no	-55 dBc
2nd Harmonic (3.3 GHz)		yes/no	-55 dBc
2nd Harmonic (5.5 GHz)		yes/no	-55 dBc
2nd Harmonic (9.6 GHz)		yes/no	-55 dBc
2nd Harmonic (16.0 GHz)		yes/no	-55 dBc
2nd Harmonic (19.8 GHz)		yes/no	-55 dBc
2nd Harmonic (20.0 GHz)		yes/no	-55 dBc
SINGLE-SIDEBAND PHASE NOISE			
@ 2 GHz			
Vb (for dynamic signal analyzer) = _____dBm			
@ 100 Hz Offset			
10logBW = _____dB			
Vs (Measured Level @ 100 Hz Offset) = _____			

Test	Minimum	Actual	Maximum
Constants = -46.00 dB Calculated Phase Noise (@ 100 Hz Offset)= $V_s - V_b - 10\log BW - 46 \text{ dB}$		_____ dBc/Hz	-70 dBc/Hz (HP 83732B)
		_____ dBc/Hz	-66 dBc/Hz (HP 83732A)
@ 1 kHz Offset Vs (Measured Level @ 1 kHz Offset) = _____ Constants = -46.00 dB Calculated Phase Noise (@ 1 kHz Offset)= $V_s - V_b - 10\log BW - 46 \text{ dB}$		_____ dBc/Hz	-78 dBc/Hz (HP 83732B)
		_____ dBc/Hz	-74 dBc/Hz (HP 83732A)
@ 10 kHz Offset Vs (Measured Level @ 10 kHz Offset) = _____ Constants = -46.00 dB Calculated Phase Noise (@ 10 kHz Offset)= $V_s - V_b - 10\log BW - 46 \text{ dB}$		_____ dBc/Hz	-83 dBc/Hz (HP 83732B)
		_____ dBc/Hz	-91 dBc/Hz (HP 83732A)
@ 100 kHz Offset Vb (for spectrum analyzer) = _____ dBm $10\log BW = \text{_____ dB}$ Constants = -43.50 dB Vs (Measured Level @ 100 kHz Offset) = _____ Calculated Phase Noise (@ 100 kHz Offset) = $V_s - V_b - 10\log BW - 43.50 \text{ dB}$		_____ dBc/Hz	-100 dBc/Hz (HP 83732B)
		_____ dBc/Hz	-107 dBc/Hz (HP 83732A)
@ 10 GHz Vb (for dynamic signal analyzer) = _____ dBm			
@ 100 Hz Offset Vs (Measured Level @ 100 Hz Offset) = _____ Constants = -46.00 dB Calculated Phase Noise (@ 100 Hz Offset)= $V_s - V_b - 10\log BW - 46 \text{ dB}$		_____ dBc/Hz	-65 dBc/Hz (HP 83732B)
		_____ dBc/Hz	-69 dBc/Hz (HP 83732A)

Test	Minimum	Actual	Maximum
<p>@ 1 kHz Offset Vs (Measured Level @ 1 kHz Offset) = _____ Constants = -46.00 dB</p> <p>Calculated Phase Noise (@ 1 kHz Offset)= Vs - Vb - 10logBW -46 dB</p>		_____ dBc/Hz _____ dBc/Hz	-73 dBc/Hz (HP 83732B) -75 dBc/Hz (HP 83732A)
<p>@ 10 kHz Offset Vs (Measured Level @ 10 kHz Offset) = _____ Constants = -46.00 dB</p> <p>Calculated Phase Noise (@ 10 kHz Offset)= Vs - Vb - 10logBW -46 dB</p>		_____ dBc/Hz _____ dBc/Hz	-76 dBc/Hz (HP 83732B) -79 dBc/Hz (HP 83732A)
<p>@ 100 kHz Offset Vb (for spectrum analyzer) = _____ dBm Constants = -43.50 dB</p> <p>Vs (Measured Level @ 100 kHz Offset) = _____ Calculated Phase Noise (@ 100 kHz Offset) = Vs - Vb - 10logBW - 43.50 dB</p>		_____ dBc/Hz _____ dBc/Hz	-100 dBc/Hz (HP 83732B) -101 dBc/Hz (HP 83732A)
<p>@ 18 GHz Vb (for dynamic signal analyzer) = _____ dBm</p>			
<p>@ 100 Hz Offset Vs (Measured Level @ 100 Hz Offset) = _____ Constants = -46.00 dB</p> <p>Calculated Phase Noise (@ 100 Hz Offset)= Vs - Vb - 10logBW -46 dB</p>		_____ dBc/Hz _____ dBc/Hz	-65 dBc/Hz (HP 83732B) -63 dBc/Hz (HP 83732A)
<p>@ 1 kHz Offset Vs (Measured Level @ 1 kHz Offset) = _____ Constants = -46.00 dB</p> <p>Calculated Phase Noise (@ 1 kHz Offset)= Vs - Vb - 10logBW -46 dB</p>		_____ dBc/Hz _____ dBc/Hz	-73 dBc/Hz (HP 83732B) -70 dBc/Hz (HP 83732A)

Test	Minimum	Actual	Maximum
<p>@ 10 kHz Offset Vs (Measured Level @ 10 kHz Offset) = _____ Constants = -46.00 dB Calculated Phase Noise (@ 10 kHz Offset) = Vs - Vb - 10logBW -46 dB</p>		<p>_____ dBc/Hz</p> <p>_____ dBc/Hz</p>	<p>-76 dBc/Hz (HP 83732B)</p> <p>-73 dBc/Hz (HP 83732A)</p>
<p>@ 100 kHz Offset Vb (for spectrum analyzer) = _____ dBm Constants = -43.50 dB Vs (Measured Level @ 100 kHz Offset) = _____ Calculated Phase Noise (@ 100 kHz Offset) = Vs - Vb - 10logBW - 43.50 dB</p>		<p>_____ dBc/Hz</p> <p>_____ dBc/Hz</p>	<p>-100 dBc/Hz (HP 83732B)</p> <p>-99 dBc/Hz (HP 83732A)</p>
<p>@ 500 MHz Vb (for dynamic signal analyzer) = _____ dBm</p>			
<p>@ 100 Hz Offset Vs (Measured Level @ 100 Hz Offset) = _____ Constants = -46.00 dB Calculated Phase Noise (@ 100 Hz Offset) = Vs - Vb - 10logBW -46 dB</p>		<p>_____ dBc/Hz</p> <p>_____ dBc/Hz</p>	<p>-78 dBc/Hz (HP 83732B)</p> <p>-70 dBc/Hz (HP 83732A)</p>
<p>@ 1 kHz Offset Vs (Measured Level @ 1 kHz Offset) = _____ Constants = -46.00 dB Calculated Phase Noise (@ 1 kHz Offset) = Vs - Vb - 10logBW -46 dB</p>		<p>_____ dBc/Hz</p> <p>_____ dBc/Hz</p>	<p>-92 dBc/Hz (HP 83732B)</p> <p>-86 dBc/Hz (HP 83732A)</p>
<p>@ 10 kHz Offset Vs (Measured Level @ 10 kHz Offset) = _____ Constants = -46.00 dB Calculated Phase Noise (@ 10 kHz Offset) = Vs - Vb - 10logBW -46 dB</p>		<p>_____ dBc/Hz</p> <p>_____ dBc/Hz</p>	<p>-103 dBc/Hz (HP 83732B)</p> <p>-103 dBc/Hz (HP 83732A)</p>

Test	Minimum	Actual	Maximum
@ 100 kHz Offset Vb (for spectrum analyzer) = _____ dBm Constants = -43.50 dB Vs (Measured Level @ 100 kHz Offset) = _____ Calculated Phase Noise (@ 100 kHz Offset) = Vs - Vb - 10logBW - 43.50 dB			
		_____ dBc/Hz	-115 dBc/Hz (HP 83732B)
		_____ dBc/Hz	-119 dBc/Hz (HP 83732A)
NON-HARMONIC SPURS 3 - 30 kHz @17005.111 MHz Vb (from "To Calibrate the System") = _____ dBm Total Correction Factor = -Vb - 46.00 dB = _____ dB for 3 kHz to 8 kHz Span Vs (Measured Level) = _____ dBm Calculated Spurious Level = Total Correction Factor + Vs Noise ___ or Offset Frequency _____ dBm for 8 kHz to 13 kHz Span Vs (Measured Level) = _____ dBm Calculated Spurious Level = Total Correction Factor + Vs for 13 kHz to 23 kHz Span Vs (Measured Level) = _____ dBm Calculated Spurious Level = Total Correction Factor + Vs for 23 kHz to 33 kHz Span Vs (Measured Level) = _____ dBm Calculated Spurious Level = Total Correction Factor + Vs Noise ___ or Offset Frequency _____ dBm			
		_____ dBc	-60 dBc
		_____ dBc	-60 dBc
		_____ dBc	-60 dBc
		_____ dBc	-60 dBc
@17501.777 MHz Vb (from "To Calibrate the System") = _____ dBm Total Correction Factor = -Vb - 46.00 dB = _____ dB for 3 kHz to 8 kHz Span Vs (Measured Level) = _____ dBm Calculated Spurious Level = Total Correction Factor + Vs Noise ___ or Offset Frequency _____ dBm for 8 kHz to 13 kHz Span Vs (Measured Level) = _____ dBm Calculated Spurious Level = Total Correction Factor + Vs for 13 kHz to 23 kHz Span Vs (Measured Level) = _____ dBm Calculated Spurious Level = Total Correction Factor + Vs			
		_____ dBc	-60 dBc
		_____ dBc	-60 dBc
		_____ dBc	-60 dBc

Test	Minimum	Actual	Maximum
Noise ___ or Offset Frequency _____ dBm for 23 kHz to 33 kHz Span Vs (Measured Level) = _____ dBm Calculated Spurious Level = Total Correction Factor + Vs Noise ___ or Offset Frequency _____ dBm		_____ dBc	-60 dBc
NON-HARMONIC SPURS >30 kHz Is the spurious level no greater than -60 dBc for the following frequencies and spans? @17005.111 MHz @17501.777 MHz @19801.511 MHz @10 MHz @8.74 MHz @11.26 MHz @63 MHz @61.74 MHz @64.26 MHz @499 MHz @497.74 MHz @500.26 MHz @500 MHz @498.74 MHz @501.74 MHz @999 MHz @997.74 MHz @1000.26 MHz		yes/no yes/no yes/no yes/no yes/no yes/no yes/no yes/no yes/no yes/no yes/no yes/no yes/no yes/no yes/no	

Test	Minimum	Actual	Maximum
PULSE ON/OFF RATIO			
1 GHz		yes/no	-80 dBc
50 MHz		yes/no	-80 dBc
300 MHz		yes/no	-80 dBc
600 MHz		yes/no	-80 dBc
999 MHz		yes/no	-80 dBc
20 GHz		yes/no	-80 dBc
PULSE RISE/FALLTIME			
10-25 MHz			
Rise Time		_____ (ns)	500 ns
Fall Time		_____ (ns)	500 ns
25-64 MHz			
Rise Time		_____ (ns)	350 ns
Fall Time		_____ (ns)	350 ns
64-128 MHz			
Rise Time		_____ (ns)	50 ns
Fall Time		_____ (ns)	50 ns
128-500 MHz			
Rise Time		_____ (ns)	35 ns
Fall Time		_____ (ns)	35 ns
500-1000 MHz			
Rise Time		_____ (ns)	15 ns
Fall Time		_____ (ns)	15 ns
1-20 GHz			
Rise Time		_____ (ns)	10 ns
Fall Time		_____ (ns)	10 ns
PULSE WIDTH			
Pulse Width (@ 1 GHz)		_____ (ns)	25 ns
Pulse Width (0.01 to 0.064 GHz)		_____ (μs)	1 μs
Pulse Width (0.064 to 0.5 GHz)		_____ (ns)	100 ns
Pulse Width (0.5 to 20 GHz)		_____ (ns)	25 ns

Test	Minimum	Actual	Maximum
<p>FM DEVIATION</p> <p>2 GHz Does spectrum fill 8 center graticules symmetrically?</p> <p>10 GHz Does spectrum fill 8 center graticules symmetrically?</p> <p>1 GHz Does spectrum fill 8 center graticules symmetrically?</p>		<p>yes/no</p> <p>yes/no</p> <p>yes/no</p>	
<p>FM RATE AND FLATNESS</p> <p>6 GHz CW Frequency</p> <p>@100 kHz First 1st Sideband Null f100kHz = _____ kHz V100kHz = _____ mVrms</p> <p>@100 kHz Fourth 1st Sideband Null f100kHz = _____ kHz V100kHz = _____ mVrms</p> <p>@1 kHz First 1st Sideband Null fx = _____ kHz Vx = _____ mVrms</p> <p>@5 kHz Fourth 1st Sideband Null fx = _____ kHz Vx = _____ mVrms</p> <p>@1 MHz First 1st Sideband Null fx = _____ kHz Vx = _____ mVrms</p> <p>Relative FM Response @1kHz = $20\log(V_x/V_{100kHz}) - 20\log(f_x/f_{100kHz}) = \underline{\hspace{2cm}}$</p> <p>Relative FM Response @5kHz = $20\log(V_x/V_{100kHz}) - 20\log(f_x/f_{100kHz}) = \underline{\hspace{2cm}}$</p> <p>Relative FM Response @1MHz = $20\log(V_x/V_{100kHz}) - 20\log(f_x/f_{100kHz}) = \underline{\hspace{2cm}}$</p> <p>Calculated FM Flatness for 18 GHz CW Frequency =</p>		<p>_____</p>	<p>4 dB</p>

Test	Minimum	Actual	Maximum
<p>18 GHz CW Frequency</p> <p>@100 kHz First 1st Sideband Null f100kHz = _____ kHz V100kHz = _____ mVrms</p> <p>@100 kHz Fourth 1st Sideband Null f100kHz = _____ kHz V100kHz = _____ mVrms</p> <p>@1 kHz First 1st Sideband Null fx = _____ kHz Vx = _____ mVrms</p> <p>@5 kHz Fourth 1st Sideband Null fx = _____ kHz Vx = _____ mVrms</p> <p>@1 MHz First 1st Sideband Null fx = _____ kHz Vx = _____ mVrms</p> <p>Relative FM Response @1kHz = $20\log(Vx/V100kHz) - 20\log(fx/f100kHz) =$ _____</p> <p>Relative FM Response @5kHz = $20\log(Vx/V100kHz) - 20\log(fx/f100kHz) =$ _____</p> <p>Relative FM Response @1MHz = $20\log(Vx/V100kHz) - 20\log(fx/f100kHz) =$ _____</p> <p>Calculated FM Flatness for 18 GHz CW Frequency = _____</p>		<p>_____</p>	<p>4 dB</p>
<p>PM RATE AND FLATNESS (1 rad/V)</p> <p>6 GHz CW Frequency</p> <p>@1 kHz Carrier Null V1kHz = _____ mVrms</p> <p>@20 kHz Carrier Null Vx = _____ mVrms</p> <p>@100 kHz Carrier Null Vx = _____ mVrms</p> <p>Relative PM Response @20kHz = $20\log(Vx/V1kHz) =$ _____ dB</p> <p>Relative PM Response @100kHz = $20\log(Vx/V1kHz) =$ _____ dB</p>			

Test	Minimum	Actual	Maximum
Calculated PM Flatness for 6 GHz CW Frequency =		_____	2 dB
PM RATE AND FLATNESS (1 rad/V) 18 GHz CW Frequency @1 kHz Carrier Null V1kHz = _____ mVrms @20 kHz Carrier Null Vx = _____ mVrms @100 kHz Carrier Null Vx = _____ mVrms Relative PM Response @20kHz = $20\log(Vx/V1kHz)$ = _____ dB Relative PM Response @100kHz = $20\log(Vx/V1kHz)$ = _____ dB Calculated PM Flatness for 18 GHz CW Frequency =		_____	2 dB
PM RATE AND FLATNESS (50 rad/V) 6 GHz CW Frequency @100 Hz Carrier Null V100 Hz = _____ mVrms @1 kHz Carrier Null Vx = _____ mVrms @30 kHz Carrier Null Vx = _____ mVrms Relative PM Response @20kHz = $20\log(Vx/V100\text{ Hz})$ = _____ dB Relative PM Response @100kHz = $20\log(Vx/V100\text{ Hz})$ = _____ dB Calculated PM Flatness for 6 GHz CW Frequency = PM RATE AND FLATNESS (50 rad/V) 18 GHz CW Frequency @100 Hz Carrier Null V100 Hz = _____ mVrms @1 kHz Carrier Null Vx = _____ mVrms @30 kHz Carrier Null Vx = _____ mVrms		_____	4 dB

Test	Minimum	Actual	Maximum
Relative PM Response @20kHz = $20\log(V_x/V_{100\text{ Hz}})$ = _____ dB Relative PM Response @100kHz = $20\log(V_x/V_{100\text{ Hz}})$ = _____ dB Calculated PM Flatness for 18 GHz CW Frequency = _____		_____	4 dB
MINIMUM AM DEPTH 1 - 20 GHz 0.01 - 1 GHz	60 dBc 60 dBc	yes/no yes/no	
MINIMUM LINEAR AM DEPTH (100%/V) 1 - 20 GHz 0.01 - 1 GHz	20 dBc 20 dBc	yes/no yes/no	
INTERNAL AM RATE 0.5 Hz 20 kHz	0.4 Hz 19.8 kHz	_____ _____	0.6 Hz 20.2 kHz
INTERNAL FM SOURCE VERIFICATION		pass/fail	

Operation Verification

The operation verification procedure is suitable for incoming inspection; however, you can refer to the Service Guide or the Calibration Guide for procedures that test all warranted specifications.

1. Activate the SELF TEST special function.

To activate the SELF TEST special function, perform the following procedure:

- a. Press the **[SPCL]** key.
- b. Press **[5]** on the synthesizer numeric keypad.
- c. Terminate the special function entry by pressing the **[Hz]** (ENTER) key.

The left-most display will read SELF TEST?, PRESS ENTER

2. Press the ENTER key again to initiate the synthesizer self test routine.

When the self test routine is running, the left-most display will read SELF TESTING. After the test completes, the left-most display momentarily reads Test Result=XX and then SELF TEST DONE!.

3. If the self test indicates an error condition, refer to the section entitled, "Main Troubleshooting" in the service guide.

An error condition exists when XX in the statement Test Result=XX is a non-zero value.

Adjustments

The procedures which follow must be performed manually, (that is, they require operator interaction).

The following lists each procedure and when it should be performed:

Adjustment	When Required
YIG CAL	after replacing either YIG Oscillator (A8G1 or A8G2), the YIG Driver assembly (A9), or when calibration data is lost
Low Stability Time Base	after replacing the LO Synthesizer and Reference assembly (A6) or for improved accuracy
0.5 V/GHz	after replacing the CPU assembly (A3) or for improved accuracy
FM Sensitivity	after replacing either YIG Oscillator (A8G1 or A8G2), the YIG Driver assembly (A9), or the YO Loop/Offset assembly (A7)
Phase Modulation (ϕ M) Sensitivity	after replacing either YIG Oscillator (A8G1 or A8G2), the YIG Driver assembly (A9), or the YO Loop/Offset assembly (A7)
Phase Cross-Over	after replacing either YIG Oscillator (A8G1 or A8G2), the YIG Driver assembly (A9), or the YO Loop/Offset assembly (A7)
Linear AM Offset	after replacing the Pulse/AM Driver assembly (A5)

Instrument Cover Removal

To perform the adjustments in this chapter, you must have access to internal components.

Cover Removal

1. Place the synthesizer with the top cover up.
2. Unscrew the four screws that attach the handles to the sides of the instrument and remove the handles.
3. Unscrew the eight screws that are under the handles. There are four screws per side.

Warning **Voltages in the instrument can cause personal injury; be extremely careful. Capacitors can be charged even if the instrument has been disconnected from line power.**

4. Unscrew the captive screw at the middle of the rear edge of the cover. This is a captive screw, and will cause the cover to pull away from the front frame.
5. Slide the cover to the rear to remove.

DIP Switch Settings

For many of the adjustment procedures, you must access the DIP switch, A3S1, located on assembly A3 in order to close PG(8). PG(8) must then be opened at the end of the procedure in order to ensure that the calibration data is saved. For the procedures which require access to this switch, refer to the following figure.

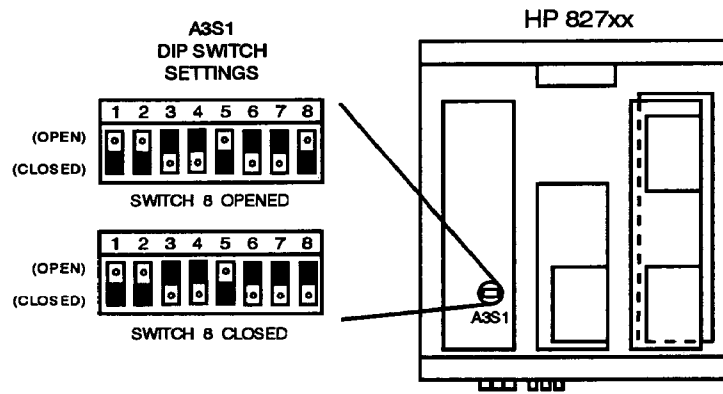

wk617ab

Figure 6-1. DIP Switch, A3S1, Settings

YIG Calibration

This calibration is performed via the front panel of the instrument using special function 71. The calibration traces the hysteresis curve of the YIG Oscillator at 200 MHz intervals and uses the curve to calculate the average values for the DAC. This procedure is performed in two bands, 2 to 10 GHz and 10 to 20 GHz.

It is necessary to perform this procedure after replacing the YIG Driver Assembly (A9) or either YIG Oscillator (A8G1 or A8G2). It is also necessary when calibration data is lost.

Caution Be sure that the POWER (LINE switch on an HP 83711A/12A and HP 83731A/32A) switch is in the "off" position before removing the synthesizer cover.

1. Close PG(8) on the DIP switch, A3S1, as shown in Figure 6-2.
2. Turn on the equipment and allow it to warm up for one hour.
3. Clear any errors from the error queue:
 - a. Press the **(MSG)** key.
 - b. The most recent error message will be shown on the synthesizer display. If the MSG annunciator is still lit, successive presses of the **(MSG)** key will display any other messages in the queue.

4. Run the YIG Calibration:

- a. Press the **(SPCL)** key.
- b. Press **(71)** on the numeric keypad and then press **(Hz)** (ENTER).

The synthesizer will display the message CAL YIG OSC?, PRESS ENTER.

- c. Press **(Hz)** (ENTER) key again to start the YIG Calibration.

The message CALIBRATION YIG OSC is briefly displayed followed by the message, YTO Cal is starting now.

While the routine is running, DAC values appear on the screen. The message, Cal Freq XXX, DAC = XXX is shown with "DAC" in *uppercase* letters, indicating that the calibration is running successfully.

5. When the routine completes, open PG(8) of the DIP switch, S1. Refer to Figure 6-1.

The message YTO Cal successful should appear when the calibration is complete.

Note This routine completes in about 20 minutes.

6. If you see the message Cal Freq xxx, dac = xxx where "dac" is in lowercase letters, abort the routine by pressing the **(LOCAL)** key, open PG(8) of the DIP switch, A3S1, and refer to the troubleshooting section in the Service Guide.

If the calibration fails any point or points, the message Cal Freq xxx, dac = xxx is shown where "dac" is in lowercase letters from the first failed point on. Old data for the failed band remains intact if the calibration fails any point in that band.

7. If the message YTO Cal failed appears, the calibration has failed. If this message is displayed:
 - a. Open PG(8) of the DIP switch, S1. Refer to Figure 6-1.

- b. Check the error queue for error messages.
- c. Refer to the troubleshooting section in the Service Guide.

Note Within a band, new DAC values are not saved in ROM unless the YIG calibration completes successfully. It is possible for the calibration to pass in 1 band and fail in the other. In this case the new DAC values are saved for the band that passes and the old DAC values are retained for the band that fails.

High Stability Timebase Adjustment (Option 1E5 Only)

This test calibrates the 10 MHz crystal oscillator to within 1 part in 10 (0.1 Hz) of the calibrated standard frequency reference.

Recommended Equipment

HP 54100D Digitizing Oscilloscope
HP 5061A Frequency Standard

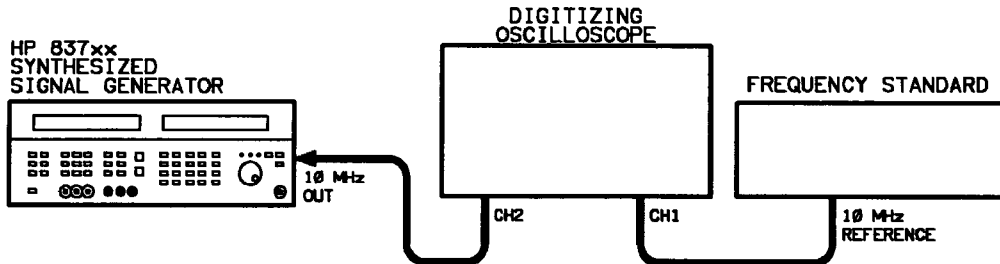

Figure 6-2. High Stability Timebase Adjustment Equipment Setup

1. Set up the equipment as in Figure 6-2.
2. Turn on the instruments and allow them to warm up for at least 20 minutes.
3. Preset the synthesizer.
4. Set the synthesizer RF output level to 0 dBm.
5. Press **AUTOSCALE** on the oscilloscope.
6. Watch the channel 2 display for movement over a period of 10 seconds.

The display should move no more than one cycle in 10 seconds. If the display does move more than one cycle in 10 seconds, adjust the HP 10811E oscillator until the display moves no more than one cycle in 10 seconds (you can access the HP 10811E adjustment location through the side of the instrument). This calibrates the 10 MHz crystal oscillator to within 0.1 Hz of the standard frequency reference.

Low Stability Timebase Adjustment

This procedure verifies the operation of the synthesizer's low stability 10 MHz reference. You should perform this after replacing the LO Synth and Reference Assembly (A6) or when you require improved frequency accuracy.

Recommended Equipment

HP 5334B Frequency Counter
HP 5061A Frequency Standard
HP 8493C Option 010 10 dB Attenuator

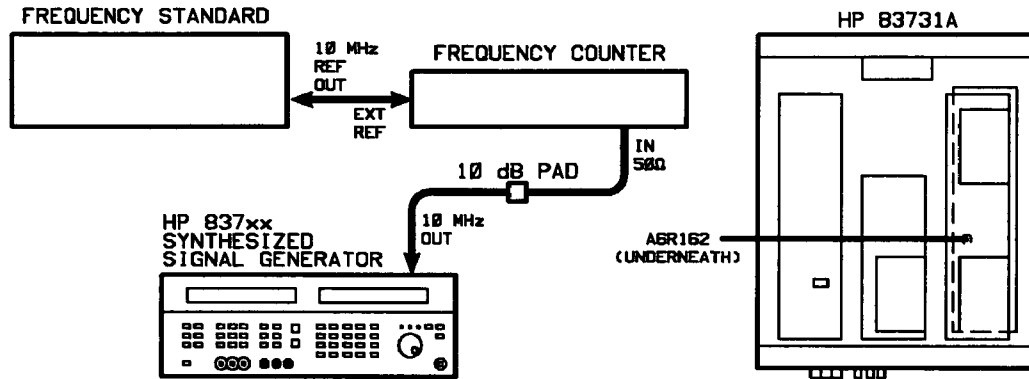

Figure 6-3. Low Stability Timebase Equipment Setup

Caution Be sure that the POWER switch is in the “off” position before removing the synthesizer cover.

1. Connect the equipment as shown in Figure 6-3.
2. Turn on the equipment and allow it to warm up for one hour.
3. Adjust *R162* slightly on the synthesizer's LO Synth and Ref Loop Assembly (A6) until the frequency counter displays 10 MHz \pm 1 Hz.

0.5 V/GHz Output Adjustment

This procedure checks and, if necessary, adjusts the output of the digital to analog converter for accuracy. Perform this adjustment after replacing the CPU assembly or when you desire improved accuracy.

Recommended Equipment

HP 3456A Voltmeter

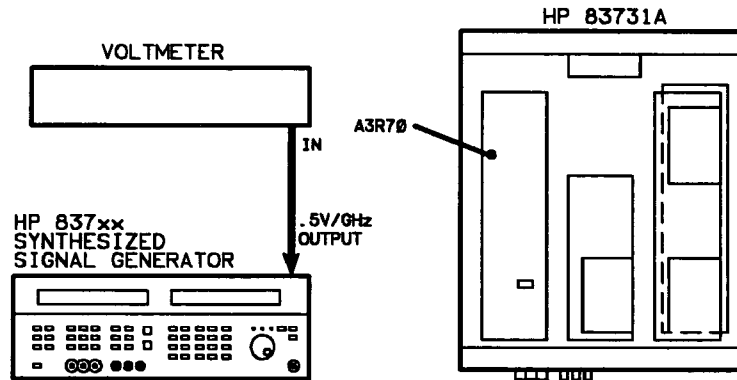

Figure 6-4. 0.5 V/GHz Output Equipment Setup

Caution Be sure that the POWER switch is in the “off” position before removing the synthesizer cover.

1. Turn on the synthesizer and allow it to warm up at least one hour.
2. Set the synthesizer CW frequency to 10 GHz.
This sets the DAC to 5 V.
3. Connect the voltmeter to the 0.5 V/GHz output located on the synthesizer's rear panel as in Figure 6-4.
4. Adjust the *R70* potentiometer on the CPU assembly so that the voltmeter reads +5.000 V \pm 5 mV.

Note that *R70* is the only potentiometer on the CPU assembly.

If the Procedure Fails

- Verify the equipment setup and instrument settings.
- If the potentiometer can not be adjusted for a proper voltmeter reading:

Refer to the *Service Guide* in order to verify the CPU assembly.

FM Sensitivity (HP 83731B/32B)

This procedure is used to adjust the external FM sensitivity. You should perform this procedure after replacing the YIG Driver assembly (A9), the YIG Oscillator (A8G1 or A8G2), or the YO Loop/Offset assembly (A7).

Recommended Equipment

HP 8566B Spectrum Analyzer
HP 8116A Function Generator
HP 3458A Voltmeter

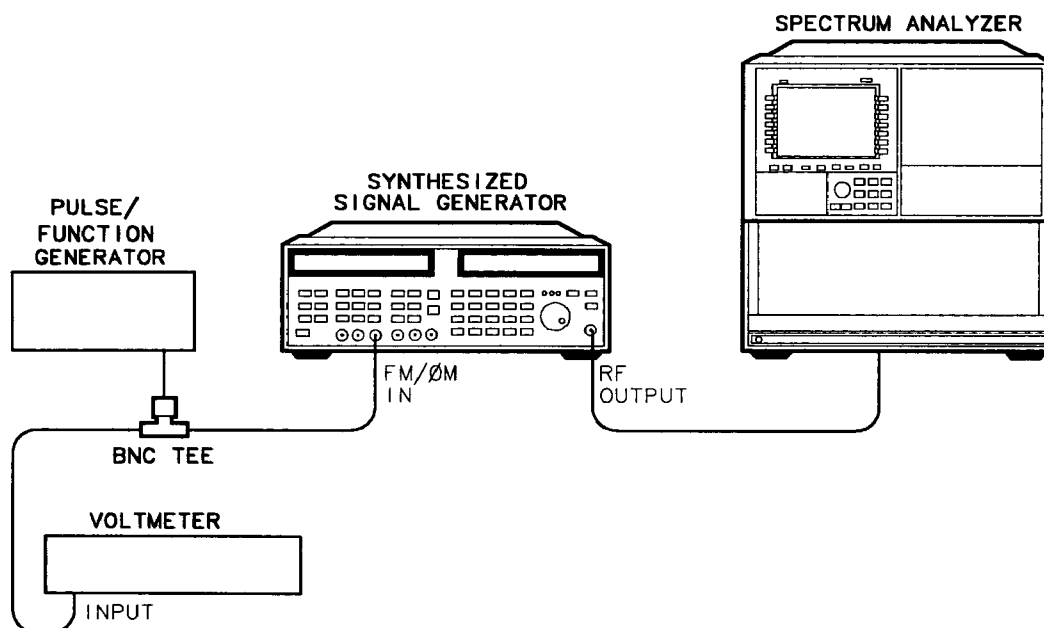

wk63ab

Figure 6-5. FM Sensitivity Equipment Setup

Caution Be sure that the POWER switch is in the “off” position before removing the synthesizer cover.

2 GHz to 10 GHz YO Adjustment

1. Turn on the synthesizer and allow it to warm up for one hour.
2. Connect the equipment as shown in Figure 6-5.
3. Set the synthesizer as follows:
 - a. Press the **PRESET** key.
 - b. Set the CW frequency to 5 GHz.
 - c. Set the power level to 0 dBm.
 - d. Set the FM sensitivity to 5 MHz/V.
 - e. Activate external FM.

4. Set the spectrum analyzer as follows:
 - a. Press the **PRESET** key.
 - b. Set the center frequency to 5 GHz.
 - c. Set the frequency span to 500 kHz.
 - d. Press **PEAK SEARCH** **MARKER REF LEVEL** **MARKER OFF**.
5. Set the function generator as follows:
 - a. Set the frequency to 100 kHz.
 - b. Set the level to read 34 mVrms ± 0.1 mVrms on the voltmeter.
 - c. Turn the function generator on.

Note The carrier signal level should decrease approximately -30 dB as soon as the function generator is turned on.

6. On the YO Loop/Offset assembly (A7), adjust R139 until the carrier level is minimized (typically greater than 40 dB).

10 GHz to 20 GHz Adjustment

7. Change the synthesizer CW frequency to 15 GHz.
8. Set the spectrum analyzer center frequency to 15 GHz.
9. On the YO Loop/Offset assembly (A7), adjust R138 until the carrier level is minimized (typically greater than 40 dB).
10. Turn the function generator's RF off.

Phase Modulation (ϕ M) Sensitivity (HP 83731B/32B)

This procedure is used to adjust the external ϕ M sensitivity. You should perform this procedure after replacing the YIG Driver assembly (A9), the YIG Oscillator (A8G1 or A8G2), or the YO Loop/Offset assembly (A7).

Recommended Equipment

HP 8566B Spectrum Analyzer
HP 8116A Function Generator
HP 3458A Voltmeter

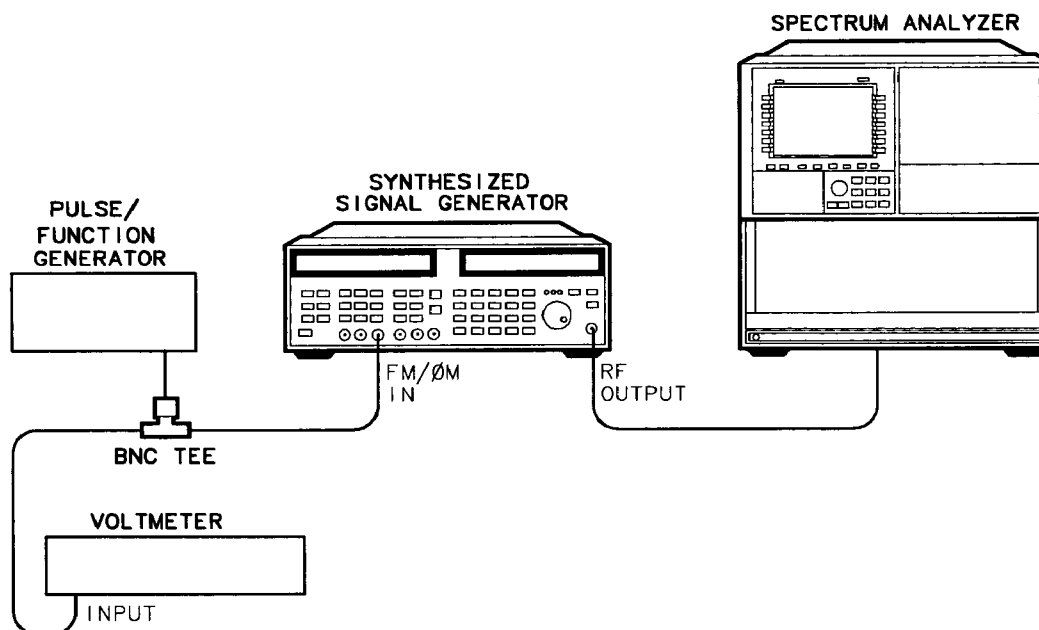

wk63ab

Figure 6-6. ϕ M Sensitivity Equipment Setup

Caution Be sure that the POWER switch is in the "off" position before removing the synthesizer cover.

1 Rad/V Adjustment

1. Turn on the synthesizer and allow it to warm up for one hour.
2. Connect the equipment as shown in Figure 6-6.
3. Set the synthesizer as follows:
 - a. Press the **PRESET** key.
 - b. Set the CW frequency to 15 GHz.
 - c. Set the power level to 0 dBm.
 - d. Turn ϕ M on.
 - e. Set the ϕ M sensitivity to 1 rad/V.

4. Set the spectrum analyzer as follows:
 - a. Press the **PRESET** key.
 - b. Set the center frequency to 15 GHz.
 - c. Set the frequency span to 10 kHz.
 - d. Press **PEAK SEARCH MARKER REF LEVEL MARKER OFF**.
5. Set the function generator as follows:
 - a. Set the frequency to 1 kHz.
 - b. Set the level to read $1.7 \text{ mVrms} \pm 10 \text{ mVrms}$ on the voltmeter.
 - c. Turn the RF on.
6. On the YO Loop/Offset assembly (A7), adjust R337 until the carrier level is minimized (typically greater than 30 dB).

50 Rad/V Adjustment

7. Set the function generator as follows:
 - a. Set the frequency to 100 Hz.
 - b. Set the level to read $34 \text{ mVrms} \pm 0.1 \text{ mVrms}$ on the voltmeter.
8. Set the synthesizer as follows:
 - a. Set the CW frequency to 5 GHz.
 - b. Set the ϕM sensitivity to 50 rad/V.
9. Set the spectrum analyzer as follows:
 - a. Set the center frequency to 5 GHz.
 - b. Set the frequency span to 1 kHz.
 - c. Set the resolution bandwidth to 30 Hz.
10. On the YO Loop/Offset assembly (A7), adjust R340 until the carrier level is minimized (typically greater than 30 dBc).
11. Turn the function generator's RF off.

Phase Cross-Over (HP 83731B/32B)

This procedure is used to adjust phase cross-over. You should perform this procedure after replacing the YIG Driver assembly (A9), the YIG Oscillator (A8G1 or A8G2), or the YO Loop/Offset assembly (A7).

Recommended Equipment

HP 8566B Spectrum Analyzer
HP 8116A Function Generator
HP 3458A Voltmeter

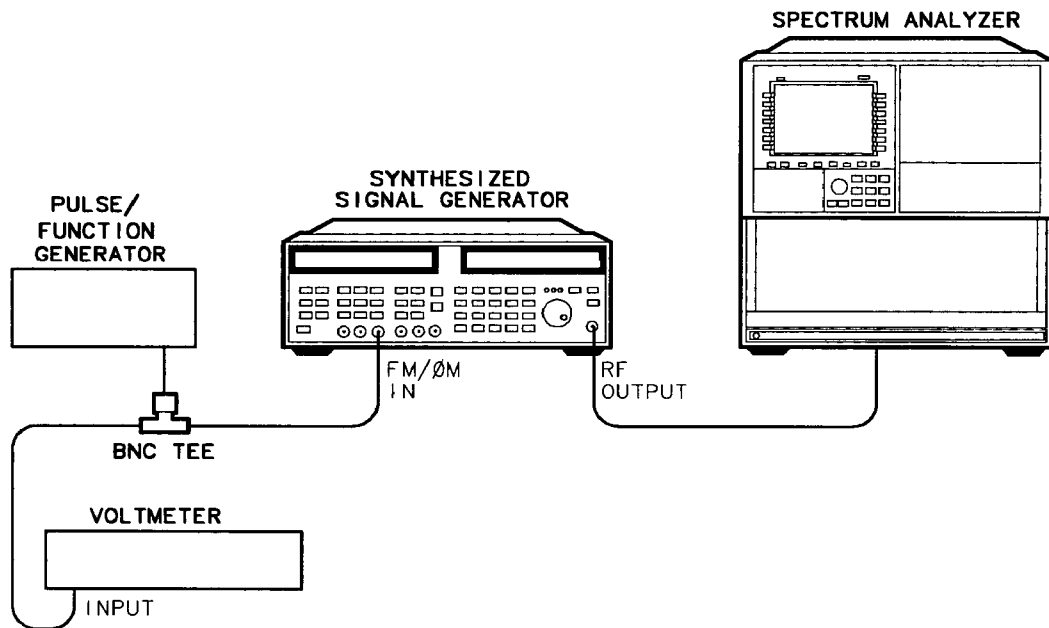

wk63ab

Figure 6-7. Phase Cross-Over Equipment Setup

Caution Be sure that the POWER switch is in the “off” position before removing the synthesizer cover.

1. Turn on the synthesizer and allow it to warm up for one hour.
2. Connect the equipment as shown in Figure 6-7.
3. Set the synthesizer as follows:
 - a. Press the **PRESET** key.
 - b. Set the CW frequency to 5 GHz.
 - c. Set the power level to 0 dBm.
 - d. Turn ϕ M on.
 - e. Set the ϕ M sensitivity to 1 rad/V.
4. Set the spectrum analyzer as follows:

- a. Press the **PRESET** key.
 - b. Set the center frequency to 5 GHz.
 - c. Set the frequency span to 5 kHz.
 - d. Press **PEAK SEARCH** **MARKER REF LEVEL** **MARKER OFF**.
5. Set the function generator as follows:
- a. Set the frequency to 1 kHz.
 - b. Set the level to read .353 mV on the voltmeter.
 - c. Turn the RF on.

Note The 5 GHz carrier and 1 kHz sideband should appear on the spectrum analyzer display.

6. Set the spectrum analyzer as follows:
- a. Set the log scale to 1 dB/div.
 - b. Set the reference level to -7 dBm.
 - c. Adjust the 1 kHz sideband peak to the fifth graticule from the top of the display (4 dB down) using the reference level fine tune knob.
 - d. Set the center frequency to 5.000060 GHz.
 - e. Set the span to 100 kHz.
7. Change the function generator frequency to 20 kHz.

Note The first 20 kHz sideband should appear on the spectrum analyzer display. The 20 kHz sideband level should be around the fifth graticule.

8. Change the function generator frequency to 100 kHz.
9. On the YO Loop/Offset assembly (A7), adjust R338 until both the 20 kHz and 100 kHz sidebands are as close to the fifth graticule as possible (typically ± 0.12 dB). You may need to iterate this adjustment.

Linear AM Offset (HP 83731B/32B)

This procedure is used to adjust linear AM offset. You should perform this procedure after replacing the Pulse/AM Driver assembly (A5).

Note The linear AM offset adjustment must be performed after the log AM linearity calibration and log AM gain calibration.

Recommended Equipment

HP 8116A Function Generator
HP 3458A Voltmeter

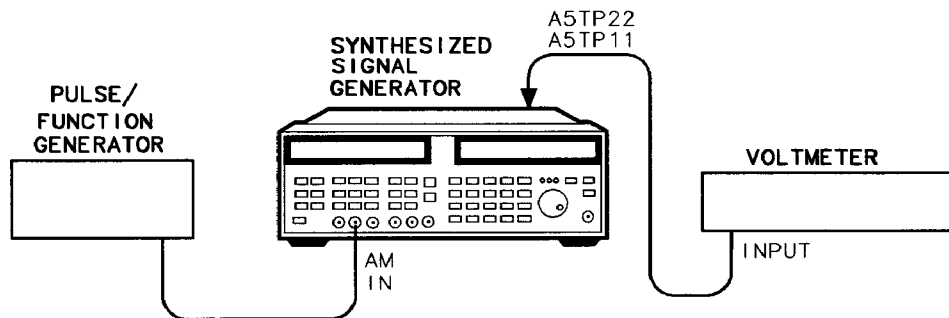

wk64ab

Figure 6-8. Linear AM Offset Equipment Setup

Caution Be sure that the POWER switch is in the “off” position before removing the synthesizer cover.

1. Turn on the synthesizer and allow it to warm up for one hour.
2. Connect the equipment as shown in Figure 6-8.
3. Set the function generator as follows:
 - a. DC mode.
 - b. Set the level to read 0.8 V on the voltmeter.
 - c. Turn the RF on.
4. Connect the positive voltmeter lead to A5TP22 and the ground to A5TP11 (ACOM) of the Pulse/AM Driver assembly.
5. Set the synthesizer as follows:
 - a. Press the **PRESET** key.
 - b. Turn external linear AM on.
 - c. Press **SPCL** **60** **Hz** **97** **Hz** **1** **Hz**
6. On the Pulse/AM Driver assembly (A5), adjust R264 for a -0.509 Vdc reading on the voltmeter.

Service Software

The procedures which follow are automated. Each procedure contains information on the equipment setup as well as how to load and run the program. The automated adjustments require the software disks which accompany this book. Note that some user interaction is required during these procedures even though they are automated. The automated procedures include:

- vernier
- frequency
- attenuator
- AM
- low band (0.01 to 1 GHz)
- attenuator constant calibrations

Perform these adjustments only when directed to do so by the troubleshooting procedures in the Service Guide or when a related performance test fails. The following lists each procedure and summarizes when it should be performed:

Adjustment	When Required
Vernier, Frequency 1 (0.01 to 1 GHz)	This adjustment is required after replacing the ALC assembly (A10), Output Module (A8A1), Coupler/Detector (A8A5), SLPFA (A8A2), RF output connector, semi-rigid cables between Output Module (A8A1) and RF output connector, or Step Attenuator (A8AT1). Calibration is also necessary when calibration data is lost or when the instrument fails the "Vernier Level Accuracy and Flatness" test.
Frequency 2, Attenuator (0.01 to 1 GHz)	This adjustment is required after replacing the ALC assembly (A10), Output Module (A8A1), Coupler/Detector (A8A5), SLPFA (A8A2), RF output connector, semi-rigid cables between Output Module (A8A1) and RF output connector, or Step Attenuator (A8AT1). Calibration is also necessary when calibration data is lost or when the instrument fails the "Low Level Accuracy and Flatness" test.
Vernier, Frequency 1 (1 to 20 GHz)	This adjustment is required after replacing the ALC assembly (A10), Output Module (A8A1), SLPFA (A8A2), RF output connector, semi-rigid cables between Output Module (A8A1) and RF output connector, or Step Attenuator (A8AT1). Calibration is also necessary when calibration data is lost or when the instrument fails the "Vernier Level Accuracy and Flatness" test.
Frequency 2, Attenuator (1 to 20 GHz)	This adjustment is required after replacing the ALC assembly (A10), Output Module (A8A1), SLPFA (A8A2), RF output connector, semi-rigid cables between Output Module (A8A1) and RF output connector, or Step Attenuator (A8AT1). Calibration is also necessary when calibration data is lost or when the instrument fails the "Low Level Accuracy and Flatness" test.
AM, Log AM Gain, Log Am Linearity, Linear AM Gain, Pulse	This adjustment is required after replacing the Pulse and AM Driver assembly (A5), the SLPFA (A8A2), or the Output Module (A8A1). Calibration is also necessary when AM calibration data is lost.

Instrument Cover Removal

To perform the some of the adjustments in this chapter, you must have access to internal components.

Cover Removal

1. Place the synthesizer with the top cover up.
2. Unscrew the four screws that attach the handles to the sides of the instrument and remove the handles.
3. Unscrew the eight screws that are under the handles. There are four screws per side.

Warning **Voltages in the instrument can cause personal injury; be extremely careful. Capacitors can be charged even if the instrument has been disconnected from line power.**

4. Unscrew the captive screw at the middle of the rear edge of the cover. This is a captive screw, and will cause the cover to pull away from the front frame.
5. Slide the cover to the rear to remove.

DIP switch, A3S1, Settings

For many of the adjustment procedures, you must access the DIP switch, A3S1 (S1 on assembly A3) in order to close PG(8). PG(8) must then be opened at the end of the procedure in order to ensure that the calibration data is saved. PG(8) can be accessed through the hole in the top of the instrument cover *without* removing the cover from the instrument. For procedures which require access to this switch, refer to the following figure (Figure 7-1) which shows the location of the PG(8) with the cover removed.

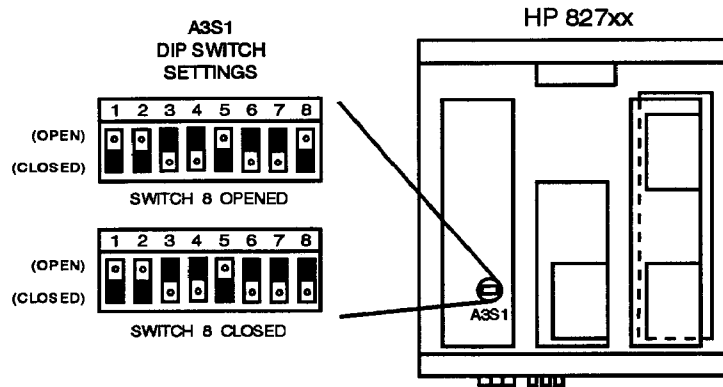

wk617ab

Figure 7-1. DIP Switch, A3S1, Settings

System Requirements and Setup

Hardware

The automated adjustments require an HP 9000 series 200/300 computer with at least 4 megabytes of RAM, a disk drive, and an HP-IB interface. They also require an HP-IB compatible printer. The software disks provided are in the 3.5 inch format. There are a total of four double-sided disks included with the calibration kit.

Operating System

These procedures were developed to run on BASIC version 5.1. However, they may be run on earlier versions of BASIC. Refer to the BASIC user's documentation for instructions on loading the operating system and binaries.

Software

The automated adjustments are contained on four double-sided disks. All disks are required in order to run the procedures.

It is suggested that you make working copies of the master disks.

Running the Software

Caution This software uses RAM volumes for fast access of data files. These volumes may also be used by other programs containing data that will be erased by this program. Be certain that the computer does not contain important data in any memory volumes before you run this program.

Note The computer containing this program must be the only controller on the bus. If more than one controller is present, the software will not run properly.

1. Copy the software from the master disks to working disks.
2. Set the default mass storage to the disk drive which will contain the automated adjustment software using the BASIC "Mass Storage Is" command.

Refer to the BASIC Language Reference for more information on setting the default mass storage.

3. Select a Display device using the PRINTER IS statement.

Specific instructions are shown on the display device that you are using. A hard copy of adjustment outputs is sent to the hard copy printer with the address selected in the "USER_FILE" program that follows.

Note There are various ways to enter data or commands when you are within *this* program. (ENTER), (CONTINUE), (RETURN), and (EXECUTE) are all interchangeable. For consistency, the (ENTER) key is used throughout this book.

To Edit the USER_FILE

The USER_FILE has been set up to allow storage of user supplied information such as instrument HP-IB addresses and calibration factors. These values are entered once and only need to be updated if they are changed.

1. Insert Disk 1 into the default drive.
2. Type LOAD "USER_FILE".
3. Press (ENTER).
4. Type EDIT.
5. Press (ENTER).
6. To enter user parameters:
 - a. Scroll through the file until you read:

Dut=xxx THIS IS THE HP-IB ADDRESS OF THE DEVICE UNDER TEST

HP 7034X OR 837XX

where the default value of xxx is 719

- b. Type in the HP-IB Address if it differs from the value of xxx.

The synthesizer HP-IB address can be viewed by pressing the (SHIFT) key and then the (LOCAL) (ADDRESS) key. Refer to "To Set the HP-IB Address" in your instrument's User's Guide for more information.

- c. Press **ENTER** in order to enter the data into the program.
 - d. Continue to scroll through the program until you read the following heading:

Prnt=yyy THIS IS THE ADDRESS OF THE HARD COPY PRINTER
 where the default value of yyy is 701
 - e. Type in the address of the hardcopy printer if it differs from the value of yyy.
 - f. Continue to scroll through the program in order to modify any of the following parameters:

Power Meter HP-IB Address, default PM = 713
 Measuring Receiver HP-IB Address, default Meas_rec = 713
 Spectrum Analyzer HP-IB Address, default Spec_a = 718
 Voltage Source HP-IB Address, default Source = 709
 RF synthesizer HP-IB Address, default RF_gen = 725 HIGH FREQUENCY POWER
 SENSOR CALIBRATION DATA:
 Number (maximum=40) of Sensor Cal Factor Frequencies, default N_freqs = 20
 Sensor Cal Factor Frequencies in GHz, default Freq:
 .05,2,3,4,5,6,7,8,9,10,11,12,13,14,15,16,17,18,19,20
 Sensor Cal Factors corresponding to Frequencies entered, default Fact:
 99.5,98.2,97.6,97.6,97,97,96.2,95.8,95.8,95.2,95.2,94.8,95,94.8,
 94,93.2,93.5,93,92.6,91.4
 LOW FREQUENCY POWER SENSOR CALIBRATION DATA (HP 837XX .01 - 1 GHz
 Calibrations Only):
 Number (maximum=40) of Sensor Cal Factor Frequencies, default N_lo = 5
 Sensor Cal Factor Frequencies in MHz, default Freq_lo: 10,30,100,300,1000
 Sensor Cal Factors corresponding to Frequencies entered, default Fact_lo:
 99.2,98.7,98.2,97.7,97.2
 - g. Type in the appropriate parameter information according to the prompts and then press **ENTER** for each parameter.
7. Purge the old and store the new "USER_FILE" when you are finished entering user parameters into the file.

1 - 20 GHz Vernier Calibration

This calibration applies to all instrument models. It is necessary after replacing the ALC assembly (A10), Output Module (A8A1), SLPFA (A8A2), RF output connector, semi-rigid cables between Output Module (A8A1) and RF output connector, or Step Attenuator (A8AT1). Calibration is also necessary when calibration data is lost or when the instrument fails the "Vernier Level Accuracy and Flatness" test from 1 - 20 GHz.

Required Equipment

HP 8485A Sensor
HP 437B Power Meter
HP-IB Printer

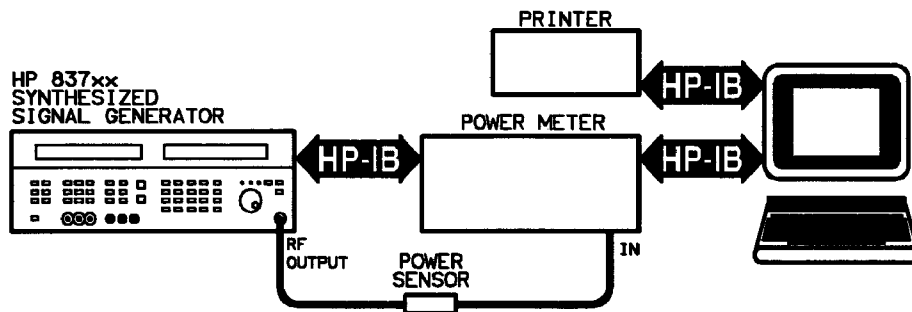

Figure 7-2. 1—20 GHz Vernier Calibration Equipment Setup

To Run the Procedure

1. Zero and calibrate the power meter and sensor.

Be certain that the appropriate calibration factor information is loaded in to USER_FILE on disk 1 prior to running this procedure.

2. Set up the equipment as shown in Figure 7-2.
3. Insert disk 3 into the default drive.
4. Type LOAD "VERN_CAL".
5. Press **ENTER**.
6. Press **RUN** to start the automated adjustment.
7. Follow the computer instructions.

Refer to Figure 7-1 for DIP switch, A3S1, location and positions.

Typically, the program will run through 3 iterations before successfully converging.

8. If the program does not converge (finish running) after about 5 minutes, press **STOP**, rezero and calibrate the power meter, and then press **RUN** to rerun the procedure.
9. If the program still does not converge, there is a hardware problem with the instrument. Refer to the troubleshooting procedures in the Service Guide.

Caution

Be certain to open PG(8) of the DIP switch, A3S1, when you finish running this procedure. If the switch remains closed, you risk the loss of all calibration data. Refer to Figure 7-1.

If the Procedure Fails

- Verify the equipment setup and instrument settings.
- Zero and calibrate the power meter and sensor and then rerun this procedure.

If the program still does not converge, refer to the Service Guide.

1 - 20 GHz Frequency Calibration 1

This calibration applies to all instrument models. It is necessary after replacing the ALC assembly (A10), Output Module (A8A1), SLPFA (A8A2), RF output connector, semi-rigid cables between Output Module (A8A1) and RF output connector, or Step Attenuator (A8AT1). Calibration is also necessary when calibration data is lost or when the instrument fails the "Vernier Level Accuracy and Flatness" test from 1 - 20 GHz.

Required Equipment

HP 8485A Sensor
HP 437B Power Meter
HP-IB Printer

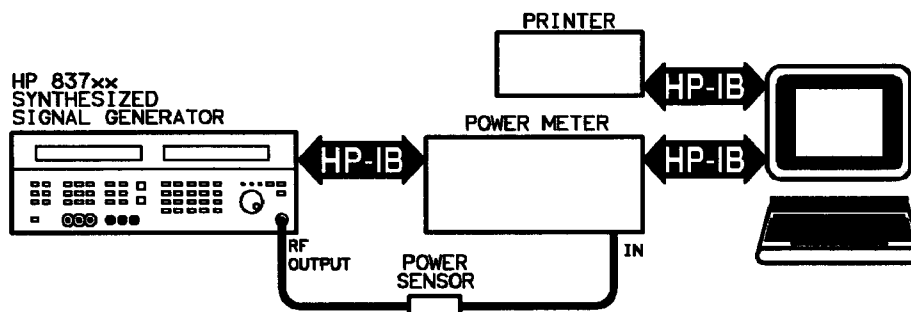

Figure 7-3. 1—20 GHz Frequency Calibration Equipment Setup

To Run the Procedure

1. Zero and calibrate the power meter and sensor.

Be certain that the appropriate calibration factor information is loaded in to USER_FILE on disk 1 prior to running this procedure.

2. Set up the equipment as shown in Figure 7-3.
3. Insert disk 3 into the default drive.
4. Type LOAD "FREQ_CAL".
5. Press **ENTER**.
6. Press **RUN** to start the automated adjustment.
7. Follow the computer instructions.

Refer to Figure 7-1 for DIP switch, A3S1, location and positions.

Upon completion, the program prints out a graph of the instrument's 1 - 20 GHz frequency response.

If the plot is not within the specified limits, the instrument can not be accurately calibrated and a repair is required.

Caution Be certain to open PG(8) of the DIP switch, A3S1, when you finish running this procedure. If the switch remains closed, you risk the loss of all calibration data. Refer to Figure 7-1.

1 - 20 GHz Frequency Calibration 2

This procedure applies to all instrument models with Option 1E1. It is necessary after replacing the ALC assembly (A10), Output Module (A8A1), SLPFA (A8A2), RF output connector, semi-rigid cables between Output Module (A8A1) and RF output connector, or Step Attenuator (A8AT1). Calibration is also necessary when calibration data is lost or when the instrument fails the "Low Level Accuracy and Flatness" test from 1 - 20 GHz.

Required Equipment

HP 8485A Sensor
HP 437B Power Meter
HP-IB Printer

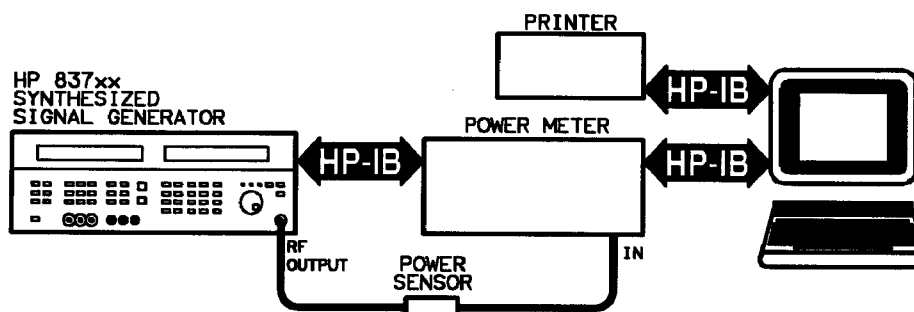

Figure 7-4. 1—20 GHz Frequency Calibration 2 Equipment Setup

To Run the Procedure

1. Zero and calibrate the power meter and sensor.

Be certain that the appropriate calibration factor information is loaded in to USER_FILE on disk 1 prior to running this procedure.

2. Set up the equipment as shown in Figure 7-4.
3. Insert disk 3 into the default drive.
4. Type LOAD "FREQ_CAL2".
5. Press **ENTER**.
6. Press **RUN** to start the automated adjustment.
7. Follow the computer instructions.

Refer to Figure 7-1 for DIP switch, A3S1, location and positions.

Upon completion, the program prints out a graph of the instrument's 1 to 20 GHz frequency response with 10 dB of attenuation.

If the plot is not within the specified limits, the instrument can not be accurately calibrated and a repair is required.

Caution Be certain to open PG(8) of the DIP switch, A3S1, when you finish running this procedure. If the switch remains closed, you risk the loss of all calibration data. Refer to Figure 7-1.

1 - 20 GHz Attenuator Calibration

This calibration applies to all instrument models with Option 1E1. It is necessary after replacing the ALC assembly (A10), Output Module (A8A1), SLPFA (A8A2), RF output connector, semi-rigid cables between Output Module (A8A1) and RF output connector, or Step Attenuator (A8AT1). Calibration is also necessary when calibration data is lost or when the instrument fails the "Low Level Accuracy and Flatness" test from 1 - 20 GHz.

Note This procedure takes about 4 hours to perform.

Recommended Equipment

HP 8902A Measuring Receiver
HP 8493C Option 010 10 dB Attenuator
HP 83640A Synthesized Sweeper
HP 11793A Microwave Converter

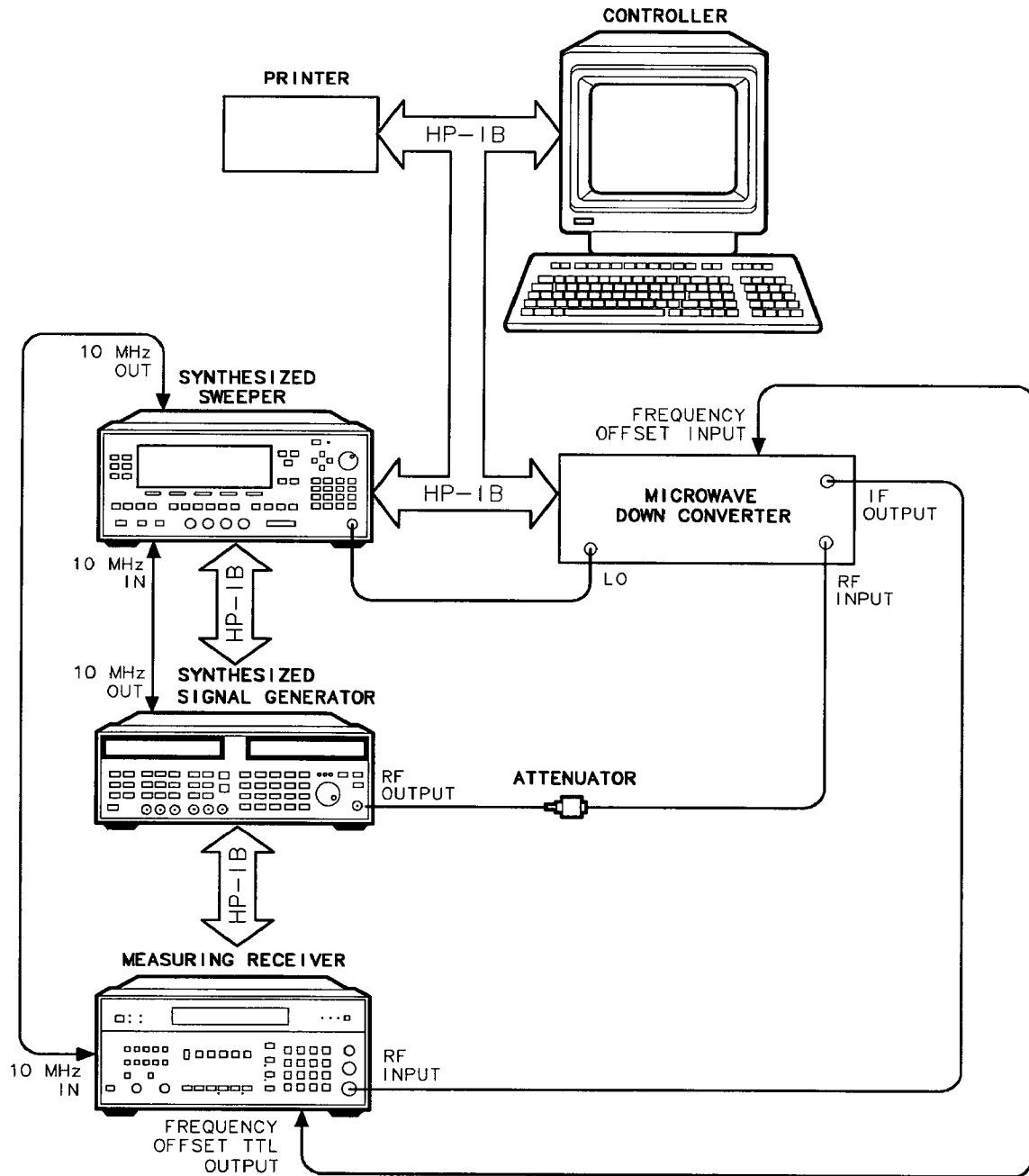

wk616ab

Figure 7-5. 1–20 GHz Attenuator Calibration Equipment Setup

Notes

1. It is recommended that you use a rigid or high quality semi-rigid cable that is less than 2 feet long for this procedure. At 18 GHz, the maximum allowable loss of the cable (connecting synthesizer RF output through a 10 dB Attenuator to spectrum analyzer RF Input) is 5 dB.
2. For maximum accuracy, connect the 10 dB attenuator directly to the spectrum analyzer input.

To Run the Procedure

1. Set up the equipment as shown in Figure 7-5.
2. Insert disk 3 into the default drive.
3. Type LOAD "ATTN_CAL".
4. Press **ENTER**.
5. Press **RUN** to start the automated adjustment.
6. Follow the computer instructions.

Note When the routine starts gathering data, the process takes about 3.5 hours. During this time, the program can run unattended. Once the routine is complete, however, follow the rest of the computer instructions, in order to complete the calibration.

Refer to Figure 7-1 for DIP switch, A3S1, location and positions.

Caution Be certain to open PG(8) of the DIP switch, A3S1, when you finish running this procedure. If the switch remains closed, you risk the loss of all calibration data. Refer to Figure 7-1.

If the Test Fails

- Verify the equipment setup and instrument settings.
- Refer to the troubleshooting section in the Service Guide.

1 - 20 GHz Log AM Linearity Calibration

This calibration applies to the HP 83731A/31B and HP 83732A/32B synthesizers only. Perform this calibration if AM calibration data is lost or after you replace the Pulse and AM Driver assembly (A5), the SLPFA (A8A2), or the Output Module (A8A1).

Note The Log AM Linearity calibration *must* be run before the AM Gain calibration.

Required Equipment

HP-IB Printer
HP 71210C Spectrum Analyzer
HP 3245A Pulse/Function Generator

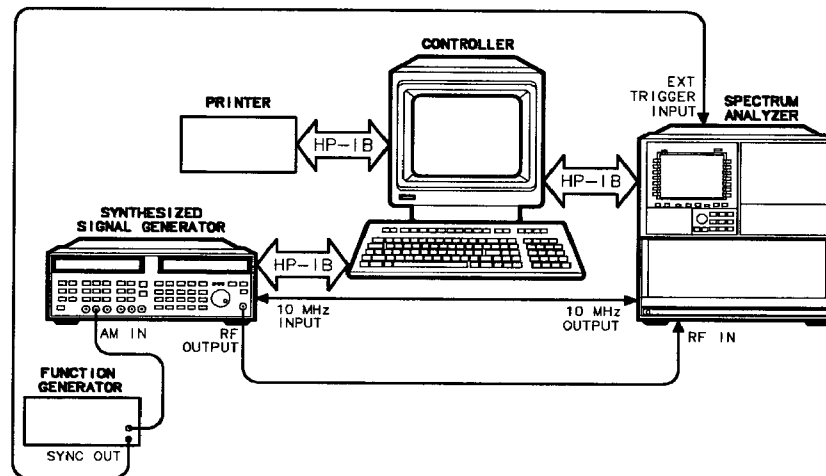

wk612eb

Figure 7-6. 1—20 GHz AM Linearity Calibration Equipment Setup

To Run the Procedure

1. Set up the equipment as shown in Figure 7-6.
2. Insert disk 4 into the default drive.
3. Type LOAD "AM_LIN".
4. Press **(ENTER)**.
5. Press **(RUN)** to start the automated adjustment.
6. Follow the computer instructions.

Note When the routine starts gathering data, the process takes about 2 hours. During this time, the program can run unattended.

Upon completion, the program prints out a table of each calibration DAC's value for a given output frequency. If both DAC values are within the acceptable range, the frequency is labeled "Pass." If all DAC values are *not* within acceptable limits, the instrument can not be accurately calibrated, and a repair is required.

If the Procedure Fails

- Verify the equipment setup and instrument settings.
- Refer to the troubleshooting section in the Service Guide.

1 - 20 GHz Log AM Gain Calibration

This calibration applies to the HP 83731A/31B and HP 83732A/32B synthesizers, only. Perform this calibration if AM calibration data is lost or after you replace the Pulse and AM Driver assembly (A5), the SLPFA (A8A2), or the Output Module (A8A1).

Note The AM Log Linearity calibration *must* be run before the AM Gain calibration.

Required Equipment

HP-IB Printer
HP 71210C Spectrum Analyzer
HP 3245A Pulse/Function Generator

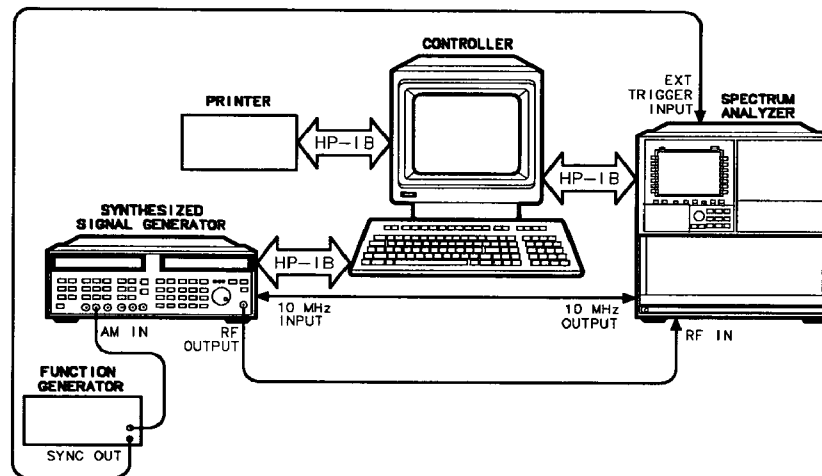

wk612ab

Figure 7-7. 1—20 GHz Log AM Gain Calibration Equipment Setup

To Run the Procedure

1. Set up the equipment as shown in Figure 7-7.
2. Insert disk 4 into the default drive.
3. Type LOAD "AM_GAIN".
4. Press **ENTER**.
5. Press **RUN** to start the automated adjustment.
6. Follow the computer instructions.

Note When the routine starts gathering data, the process takes about 40 minutes. During this time, the program can run unattended.

Upon completion, the program prints out a graph of the instrument's 1 - 20 GHz Log AM Gain Correction.

If the plot is not within the specified limits, the instrument can not be accurately calibrated and a repair is required.

If the Procedure Fails

- Verify the equipment setup and instrument settings.
- Refer to the Service Guide.

1 - 20 GHz Linear AM Gain Calibration

This calibration applies to the HP 83731B/32B synthesizers, only. Perform this calibration if linear AM calibration data is lost or after you replace the Pulse and AM Driver assembly (A5), the SLPFA (A8A2), or the Output Module (A8A1).

Note The 1 - 20 GHz linear AM gain calibration must be performed after the log AM linearity calibration, AM gain calibration, and linear AM offset in Chapter 6, "Adjustments."

Required Equipment

- HP-IB Printer
- HP 83640A Synthesized Sweeper
- HP 8902A Measuring Receiver
- HP 8493C Option 010 10 dB Attenuator
- HP 11793A Microwave Converter
- HP 3325A Function Generator

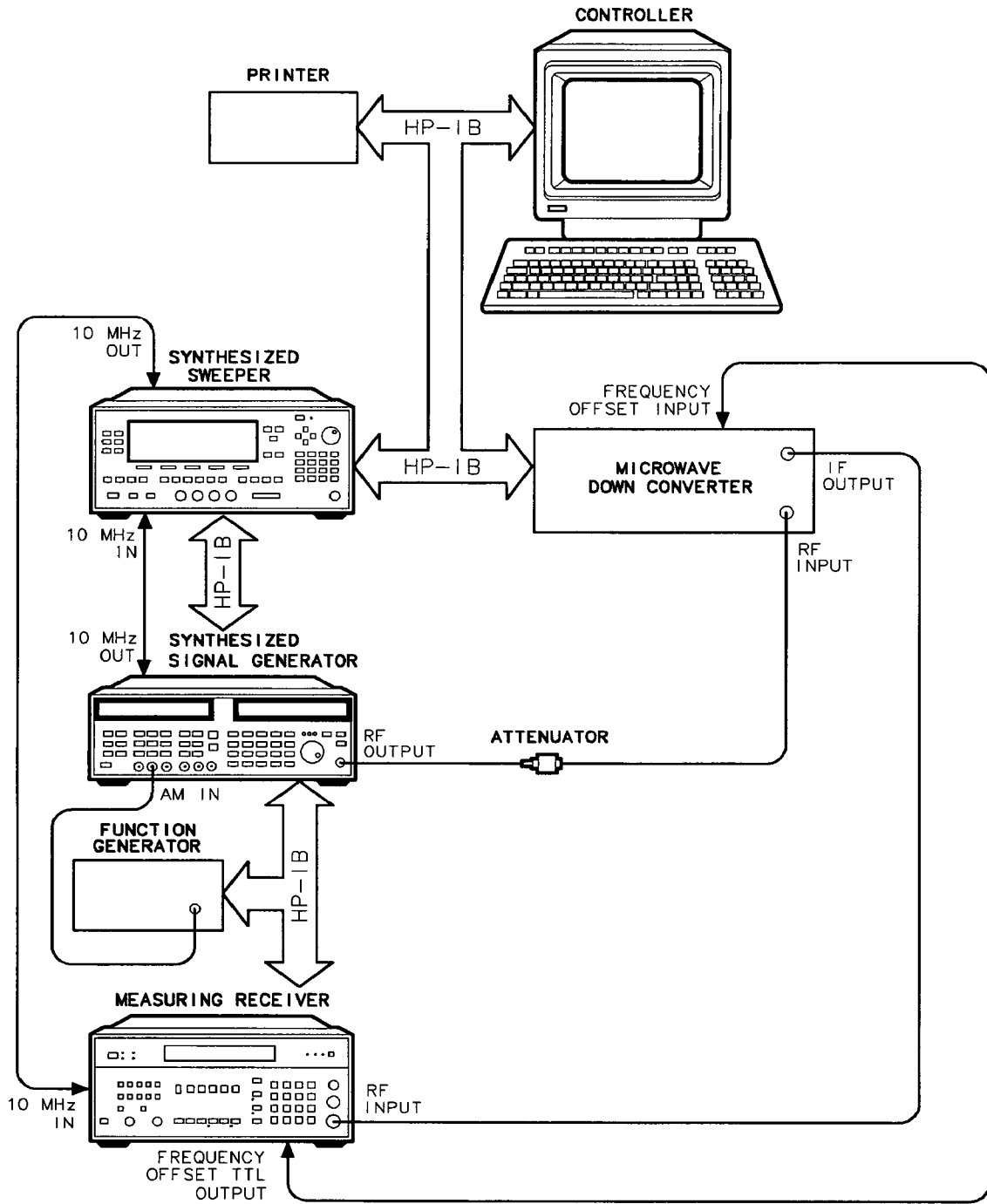

wk613ob

Figure 7-8. 1—20 GHz Linear AM Calibration Equipment Setup

To Run the Procedure

1. Set up the equipment as shown in Figure 7-8.
2. Insert disk 4 into the default drive.
3. Type LOAD "AM_OFF".
4. Press **(ENTER)**.
5. Press **(RUN)** to start the automated adjustment.
6. Follow the computer instructions.

Note When the routine starts gathering data, the process takes about 15 minutes.
 During this time, the program can run unattended.

Upon completion, the program prints out a graph of the instrument's
1 - 20 GHz Linear AM Gain Correction.

If the plot is not within the specified limits, the instrument can not be accurately calibrated
and a repair is required.

If the Procedure Fails

- Verify the equipment setup and instrument settings.
- Refer to the Service Guide.

0.01 - 1 GHz Vernier Calibration

This calibration applies to the HP 83712A/12B and the HP 83732A/32B, only. It is necessary after replacing the ALC assembly (A10), Output Module (A8A1), Coupler/Detector (A8A5), SLPFA (A8A2), RF output connector, semi-rigid cables between Output Module (A8A1) and RF output connector, or Step Attenuator (A8AT1). Calibration is also necessary when calibration data is lost or when the instrument fails the “Vernier Level Accuracy and Flatness” test from 0.01 - 1 GHz.

Required Equipment

HP 8482A Sensor
HP 437B Power Meter
HP-IB Printer

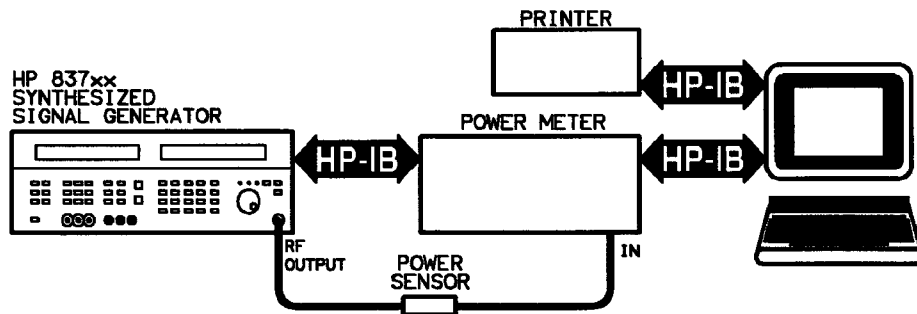

Figure 7-9. 0.01—1 GHz Vernier Calibration Equipment Setup

To Run the Procedure

1. Zero and calibrate the power meter and sensor.

Be certain that the appropriate calibration factor information is loaded in to USER_FILE on disk 1 prior to running this procedure.

2. Set up the equipment as shown in Figure 7-9.
3. Insert disk 3 into the default drive.
4. Type LOAD "L_VERN_CAL".
5. Press **ENTER**.

6. Press **RUN** to start the automated adjustment.

7. Follow the computer instructions.

Refer to Figure 7-1 for DIP switch, A3S1, location and positions.

Typically, the program will run through 3 iterations before successfully converging.

8. If the program does not converge (finish running) after about 5 minutes, press **STOP**, rezero and calibrate the power meter, and then press **RUN** to rerun the procedure.
9. If the program still does not converge, there is a hardware problem with the instrument. Refer to the troubleshooting procedures in the Service Guide.

Caution Be certain to open PG(8) of the DIP switch, A3S1, when you finish running this procedure. If the switch remains closed, you risk the loss of all calibration data. Refer to Figure 7-1.

If the Procedure Fails

- Verify the equipment setup and instrument settings.
- Zero and calibrate the power meter and sensor and then rerun this procedure.

If the program still does not converge, refer to the Service Guide.

0.01 - 1 GHz Frequency Calibration 1

This calibration applies to the HP 83712A/12B and the HP 83732A/32B, only. It is necessary after replacing the ALC assembly (A10), Output Module (A8A1), Coupler/Detector (A8A5), SLPFA (A8A2), RF output connector, semi-rigid cables between Output Module (A8A1) and RF output connector, or Step Attenuator (A8AT1). Calibration is also necessary when calibration data is lost or when the instrument fails the "Vernier Level Accuracy and Flatness" test from 0.01 - 1 GHz.

Required Equipment

HP 8482A Sensor
HP 437B Power Meter
HP-IB Printer

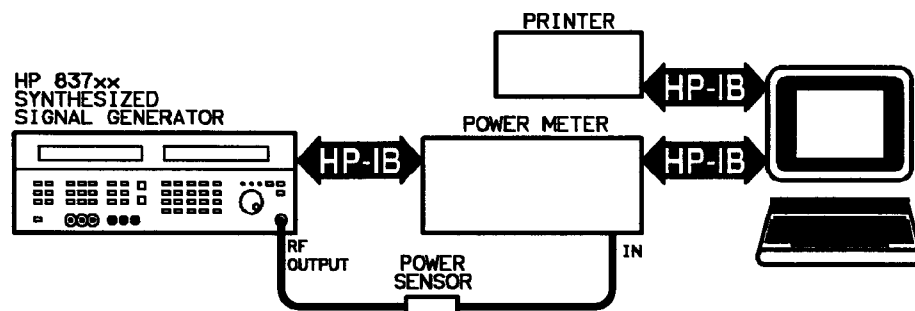

Figure 7-10. 0.01—1 GHz Frequency Calibration 1 Equipment Setup

To Run the Procedure

1. Zero and calibrate the power meter and sensor.

Be certain that the appropriate calibration factor information is loaded in to USER_FILE on disk 1 prior to running this procedure.

2. Set up the equipment as shown in Figure 7-10.
3. Insert disk 3 into the default drive.
4. Type LOAD "L_FREQ_CAL".
5. Press **ENTER**.
6. Press **RUN** to start the automated adjustment.
7. Follow the computer instructions.

Refer to Figure 7-1 for DIP switch, A3S1, location and positions.

This procedure takes less than 5 minutes to run, and upon completion, the program prints out a graph of the instrument's 0.01 to 1 GHz frequency response.

If the plot is not within the specified limits, the instrument can not be accurately calibrated and a repair is required.

Caution Be certain to open PG(8) of the DIP switch, A3S1, when you finish running this procedure. If the switch remains closed, you risk the loss of all calibration data. Refer to Figure 7-1.

0.01 - 1 GHz Frequency Calibration 2

This procedure applies to the HP 83712A/12B and the HP 83732A/32B with Option 1E1. It is necessary after replacing the ALC assembly (A10), Output Module (A8A1), Coupler/Detector (A8A5), SLPPFA (A8A2), RF output connector, semi-rigid cables between Output Module (A8A1) and RF output connector, or Step Attenuator (A8AT1). Calibration is also necessary when calibration data is lost or when the instrument fails the “Low Level Accuracy and Flatness” test from 0.01 to 1 GHz.

Required Equipment

HP 8482A Sensor
HP 437B Power Meter
HP-IB Printer

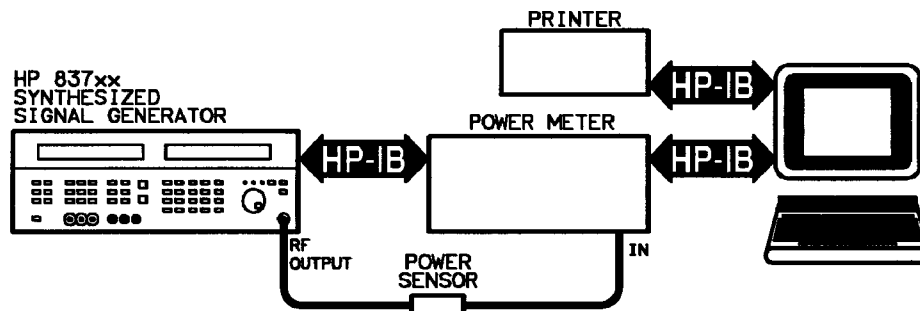

Figure 7-11. 0.01—1 GHz Frequency Calibration 2 Equipment Setup

To Run the Procedure

1. Zero and calibrate the power meter and sensor.

Be certain that the appropriate calibration factor information is loaded in to USER_FILE on disk 1 prior to running this procedure.

2. Set up the equipment as shown in Figure 7-11.
3. Insert disk 3 into the default drive.
4. Type LOAD "L_FREQ_CL2".
5. Press **ENTER**.
6. Press **RUN** to start the automated adjustment.
7. Follow the computer instructions.

Refer to Figure 7-1 for DIP switch, A3S1, location and positions.

This procedure takes less than 5 minutes to run, and upon completion, the program prints out a graph of the instrument's 0.01 to 1 GHz frequency response with 10 dB of attenuation.

If the plot is not within the specified limits, the instrument can not be accurately calibrated and a repair is required.

Caution Be certain to open PG(8) of the DIP switch, A3S1, when you finish running this procedure. If the switch remains closed, you risk the loss of all calibration data. Refer to Figure 7-1.

0.01 - 1 GHz Attenuator Calibration

This calibration applies to the HP 83712A/12B and HP 83732A/32B with Option 1E1. It is necessary after replacing the ALC assembly (A10), Output Module (A8A1), Coupler/Detector (A8A5), SLPFA (A8A2), RF output connector, semi-rigid cables between Output Module (A8A1) and RF output connector, or Step Attenuator (A8AT1). Calibration is also necessary when calibration data is lost or when the instrument fails the Vernier Level Accuracy test.

Recommended Equipment

HP 8902A Measuring Receiver
HP 8493C Option 010 10 dB Attenuator

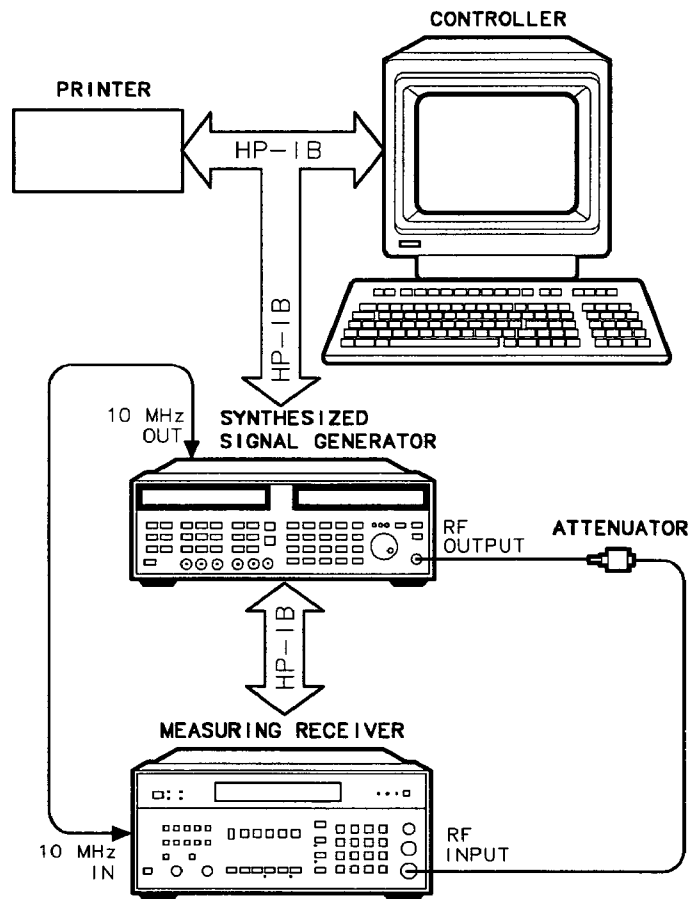

wk66ab

Figure 7-12. 0.01—1 GHz Attenuator Calibration Equipment Setup

Note 1. For maximum accuracy, connect the 10 dB attenuator directly to the spectrum analyzer input.

To Run the Procedure

1. Set up the equipment as shown in Figure 7-12.
2. Insert disk 3 into the default drive.
3. Type LOAD "L_ATT_N_CAL".
4. Press **ENTER**.
5. Press **RUN** to start the automated adjustment.
6. Follow the computer instructions.

Note This procedure takes about 45 minutes to run.

Refer to Figure 7-1 for DIP switch, A3S1, location and positions.

Caution Be certain to open PG(8) of the DIP switch, A3S1, when you finish running this procedure. If the switch remains closed, you risk the loss of all calibration data. Refer to Figure 7-1.

If the Test Fails

- Verify the equipment setup and instrument settings.
- Refer to the troubleshooting section in the Service Guide.

0.01 - 1 GHz Log AM Calibration

This calibration applies to the HP 83732A/32B synthesizer, only. Perform this calibration if AM calibration data is lost or after you replace the Pulse and AM Driver assembly (A5), the SLPFA (A8A2), or the Output Module (A8A1).

Required Equipment

HP-IB Printer
HP 71210C Spectrum Analyzer
HP 3245A Pulse/Function Generator

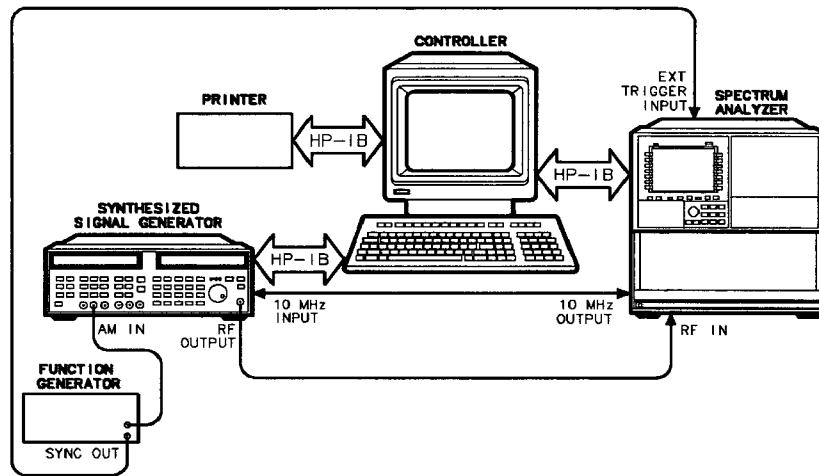

wk612ab

Figure 7-13. 0.01—1 GHz AM Calibration Equipment Setup

To Run the Procedure

1. Set up the equipment as shown in Figure 7-13.
2. Insert disk 4 into the default drive.
3. Type LOAD "LOW_AM".
4. Press **ENTER**.
5. Press **RUN** to start the automated adjustment.
6. Follow the computer instructions.

Note When the routine starts gathering data, the process takes about 5 minutes. During this time, the program can run unattended.

Upon completion, the program prints out a graph of the instrument's 0.01 - 1 GHz AM Gain Correction.

If the plot is not within the specified limits, the instrument can not be accurately calibrated and a repair is required.

If the Procedure Fails

- Verify the equipment setup and instrument settings.
- Refer to the Service Guide.

0.01 - 1 GHz Linear AM Calibration

This calibration applies to the HP 83731B/32B synthesizer, only. Perform this calibration if linear AM calibration data is lost or after you replace the Pulse/AM Driver assembly (A5), the SLPFA (A8A2), or the Output Module (A8A1).

Required Equipment

HP-IB Printer
HP 8902A Measuring Receiver
HP 3325A Function Generator

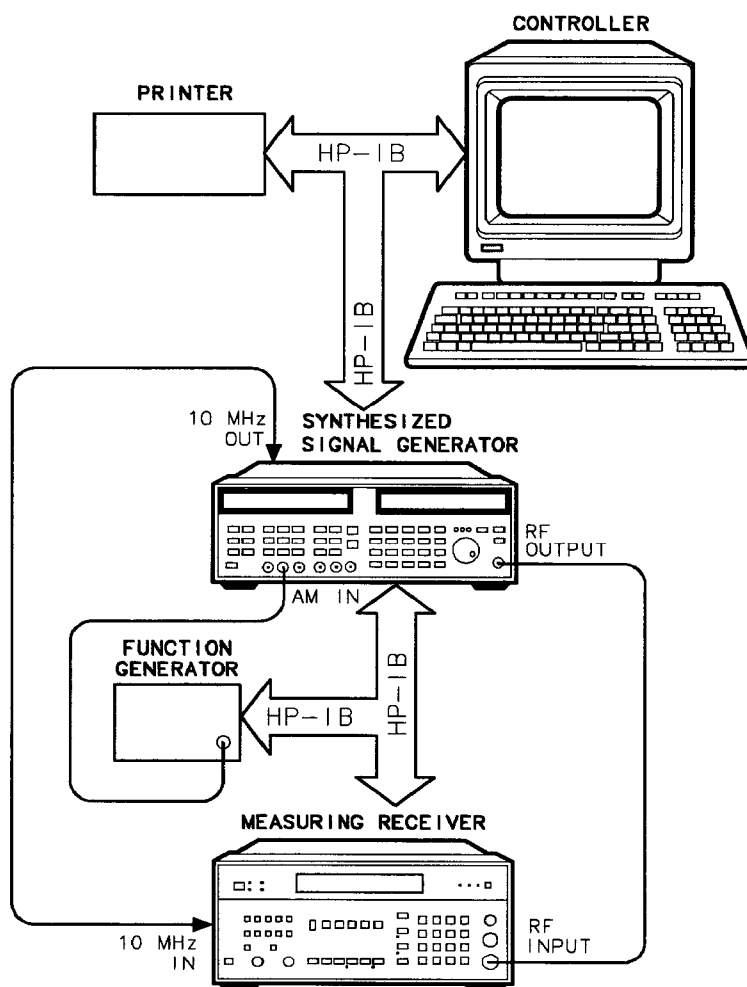

wk67ab

Figure 7-14. 0.01—1 GHz Linear AM Calibration Equipment Setup

To Run the Procedure

1. Set up the equipment as shown in Figure 7-14.
2. Insert disk 4 into the default drive.
3. Type LOAD "L_AM.OFF".
4. Press **(ENTER)**.
5. Press **(RUN)** to start the automated adjustment.
6. Follow the computer instructions.

Note When the routine starts gathering data, the process takes about 5 minutes. During this time, the program can run unattended.

Upon completion, the program prints out a graph of the instrument's 0.01 - 1 GHz Linear AM Gain Correction.

If the plot is not within the specified limits, the instrument can not be accurately calibrated and a repair is required.

If the Procedure Fails

- Verify the equipment setup and instrument settings.
- Refer to the Service Guide.

0.01 - 1 GHz Pulse Calibration

This calibration applies to the HP 83732A/32B synthesizer, only. Perform this calibration if calibration data is lost or after you replace the Pulse and AM Driver assembly (A5), the SLPFA (A8A2), or the Output Module (A8A1).

Required Equipment

HP-IB Printer

HP 54121T (HP 54120B and HP 54121A) 20 GHz Digitizing Oscilloscope

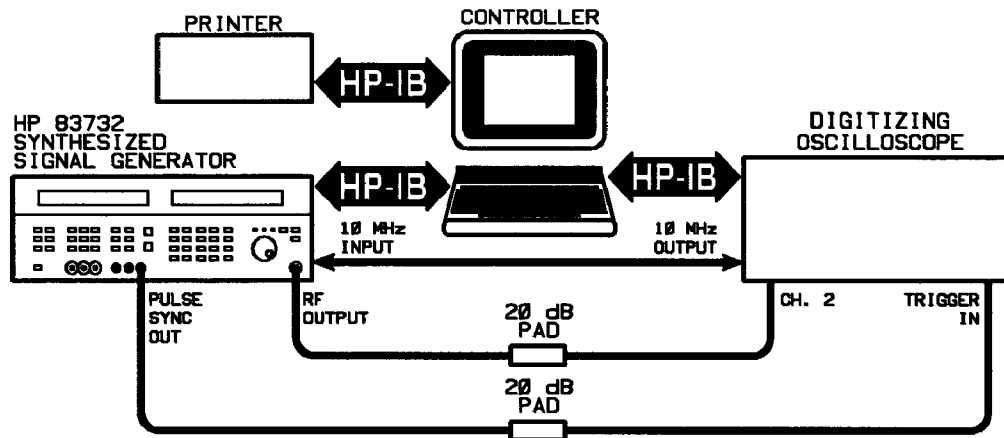

Figure 7-15. 0.01—1 GHz Pulse Calibration Equipment Setup

To Run the Procedure

1. Set up the equipment as shown in Figure 7-15.
2. Insert disk 4 into the default drive.
3. Type LOAD "PULSE".
4. Press **ENTER**.
5. Press **RUN** to start the automated adjustment.
6. Follow the computer instructions.

Note This routine takes about 15 minutes to run.

Caution Be certain to open PG(8) of the DIP switch, A3S1, when you finish running this procedure. If the switch remains closed, you risk the loss of all calibration data. Refer to Figure 7-1.

Upon completion, the program prints out 3 correction factors and the calibration status (pass or fail) is stated. If the corrections are not within limits, the instrument cannot be accurately calibrated and a repair is required.

If the Procedure Fails

- Verify the equipment setup and instrument settings.
- Refer to the Service Guide.

Internal AM/FM Source Calibration (HP 83731A/32A and HP 83731B/32B Option 1E2 Only)

Perform this calibration if internal AM or FM source calibration data is lost or after you replace the Pulse and AM Driver assembly (A5), the SLPFA (A8A2), the AM/FM Modulation Source assembly (A12), or the Output Module (A8A1).

Note The Internal AM/FM Source calibration must be run *after* the AM Linearity calibration or AM Gain calibration.

Required Equipment

HP-IB Printer
HP 71210C Spectrum Analyzer

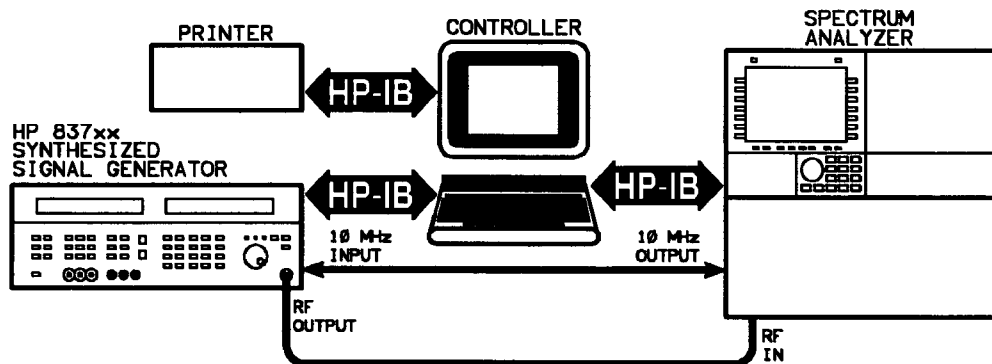

Figure 7-16. Internal AM/FM Source Calibration Equipment Setup

To Run the Procedure

1. Set up the equipment as shown in Figure 7-16.
2. Insert disk 3 into the default drive.
3. Type LOAD "MOD_CAL".
4. Press **ENTER**.
5. Press **RUN** to start the automated adjustment.
6. Follow the computer instructions.

Upon completion, the program prints out "INTERNAL MODULATION SOURCE CALIBRATION ROUTINE COMPLETED."

Internal Linear AM Source Calibration (HP 83731B/32B Option 1E2 Only)

Perform this calibration if internal linear AM source calibration data is lost or after you replace the Pulse and AM Driver assembly (A5), the SLPFA (A8A2), the AM/FM Modulation Source assembly (A12), or the Output Module (A8A1).

Note The Internal Linear AM Source calibration must be run *after* the AM Linearity calibration, AM Gain calibration, or Internal AM/FM Source calibration.

Required Equipment

HP 54121T (HP 54120B and HP 54121A) 20 GHz Digitizing Oscilloscope

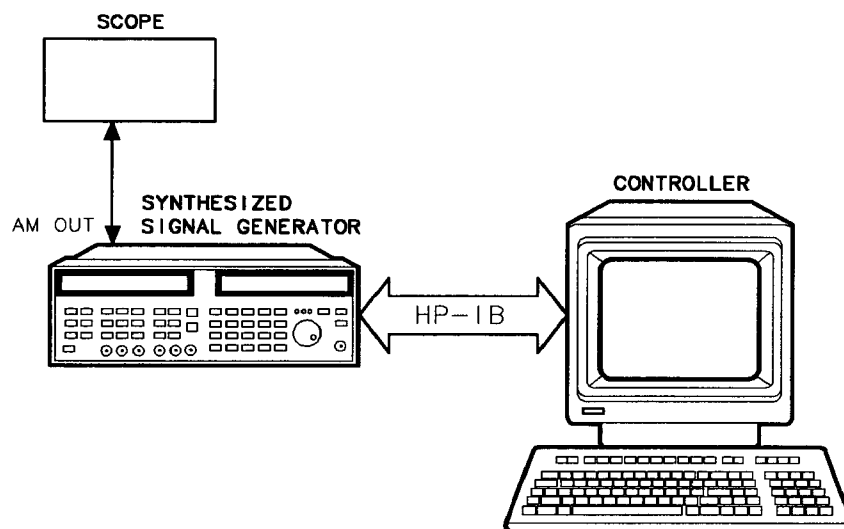

wk69ab

Figure 7-17. Internal Linear AM Source Calibration Equipment Setup

To Run the Procedure

1. Set up the equipment as shown in Figure 7-17.
2. Insert disk 4 into the default drive.
3. Type LOAD "INT_AM".
4. Press **ENTER**.
5. Press **RUN** to start the automated adjustment.
6. Follow the computer instructions.

Upon completion, the program prints out THE INTERNAL LINEAR AM CALIBRATION HAS BEEN SUCCESSFUL.

Maintenance and Service

This chapter contains information about cleaning the instrument, packaging the instrument and shipping it back to Hewlett-Packard, a table of the sales and service offices, and blue service tags.

Cleaning the Product

Clean the synthesizer cabinet using a damp cloth only.

Returning Instruments for Service

Service Tag

If you are returning the instrument to Hewlett-Packard for servicing, fill in and attach a blue service tag. (Service tags are supplied at the end of this chapter.)

Please be as specific as possible about the nature of the problem. If you have recorded any error messages that appeared on the screen, or have completed a performance test record, or have any other specific data on the performance of the synthesizer, please send a copy of this information with the unit.

Original Packaging

Before shipping, pack the unit in the original factory packaging materials if they are available. Original materials are available through any Hewlett-Packard office.

Other Packaging

Caution	Instrument damage can result from using packaging materials other than those specified. Never use styrene pellets as packaging materials. They do not adequately cushion the instrument or prevent it from shifting in the carton. They cause instrument damage by generating static electricity.
----------------	---

You can repackage the instrument with commercially available materials, as follows:

1. Attach a completed service tag to the instrument.
2. Wrap the instrument in antistatic plastic to reduce the possibility of damage caused by ESD.
3. Use a strong shipping container. A double-walled, corrugated cardboard carton of 159 kg (350 lb) bursting strength is adequate. The carton must be large enough and strong enough to accommodate the instrument. Allow at least 3 to 4 inches on all sides of the instrument for packing material.
4. Surround the instrument with 3 to 4 inches of packing material, to protect the instrument and prevent it from moving in the carton. If packing foam is not available, the best alternative is S.D.-240 Air Cap from Sealed Air Corporation (Commerce, California 90001). Air Cap looks like a plastic sheet filled with 1-1/4 inch air bubbles. Use the pink (antistatic) Air Cap to reduce static electricity. Wrapping the instrument several times in this material should both protect the instrument and prevent it from moving in the carton.
5. Seal the carton with strong nylon adhesive tape.
6. Mark the carton "Fragile, Handle with Care."
7. Retain copies of all shipping papers.

Sales and Service Offices

Hewlett-Packard has sales and service offices around the world providing complete support for Hewlett-Packard products. To obtain servicing information, or to order replacement parts, contact the nearest Hewlett-Packard Sales and Service Office listed in Table 8-1.

In any correspondence, be sure to include the pertinent information about model numbers, serial numbers, or assembly part numbers.

Table 8-1. Hewlett-Packard Sales and Service Offices

UNITED STATES		
Instrument Support Center Hewlett-Packard Company (800) 403-0801		
EUROPEAN FIELD OPERATIONS		
Headquarters Hewlett-Packard S.A. 150, Route du Nant-d'Avril 1217 Meyrin 2/Geneva Switzerland (41 22) 780.8111	France Hewlett-Packard France 1 Avenue Du Canada Zone D'Activite De Courtaboeuf F-91947 Les Ulis Cedex France (33 1) 69 82 60 60	Germany Hewlett-Packard GmbH Hewlett-Packard Strasse 61352 Bad Homburg v.d.H Germany (49 6172) 16-0
Great Britain Hewlett-Packard Ltd. Eskdale Road, Winnersh Triangle Wokingham, Berkshire RG41 5DZ England (44 734) 696622		
INTERCON FIELD OPERATIONS		
Headquarters Hewlett-Packard Company 3495 Deer Creek Road Palo Alto, California, USA 94304-1316 (415) 857-5027	Australia Hewlett-Packard Australia Ltd. 31-41 Joseph Street Blackburn, Victoria 3130 (61 3) 895-2895	Canada Hewlett-Packard (Canada) Ltd. 17500 South Service Road Trans-Canada Highway Kirkland, Quebec H9J 2X8 Canada (514) 697-4232
China China Hewlett-Packard Company 38 Bei San Huan X1 Road Shuang Yu Shu Hai Dian District Beijing, China (86 1) 256-6888	Japan Hewlett-Packard Japan, Ltd. 9-1 Takakura-Cho, Hachioji Tokyo 192, Japan (81 426) 60-2111	Singapore Hewlett-Packard Singapore (Pte.) Ltd. 150 Beach Road #29-00 Gateway West Singapore 0718 (65) 291-9088
Taiwan Hewlett-Packard Taiwan 8th Floor, H-P Building 337 Fu Hsing North Road Taipei, Taiwan (886 2) 712-0404		



**HEWLETT
PACKARD**

Should one of your HP instruments need repair, the HP service organization is ready to serve you. However, you can help us serve you more effectively. When sending an instrument to HP for repair, please fill out this card and attach it to the product. Increased repair efficiency and reduced turn-around time should result.

COMPANY _____

ADDRESS _____

TECHNICAL CONTACT PERSON _____

PHONE NO. _____ EXT. _____

MODEL NO. _____ SERIAL NO. _____

MODEL NO. _____ SERIAL NO. _____

P.O. NO. _____ DATE _____

Accessories returned with unit

- NONE CABLE(S)
- POWER CABLE ADAPTER(S)

OTHER _____

over



**HEWLETT
PACKARD**

Should one of your HP instruments need repair, the HP service organization is ready to serve you. However, you can help us serve you more effectively. When sending an instrument to HP for repair, please fill out this card and attach it to the product. Increased repair efficiency and reduced turn-around time should result.

COMPANY _____

ADDRESS _____

TECHNICAL CONTACT PERSON _____

PHONE NO. _____ EXT. _____

MODEL NO. _____ SERIAL NO. _____

MODEL NO. _____ SERIAL NO. _____

P.O. NO. _____ DATE _____

Accessories returned with unit

- NONE CABLE(S)
- POWER CABLE ADAPTER(S)

OTHER _____

over



**HEWLETT
PACKARD**

Should one of your HP instruments need repair, the HP service organization is ready to serve you. However, you can help us serve you more effectively. When sending an instrument to HP for repair, please fill out this card and attach it to the product. Increased repair efficiency and reduced turn-around time should result.

COMPANY _____

ADDRESS _____

TECHNICAL CONTACT PERSON _____

PHONE NO. _____ EXT. _____

MODEL NO. _____ SERIAL NO. _____

MODEL NO. _____ SERIAL NO. _____

P.O. NO. _____ DATE _____

Accessories returned with unit

- NONE CABLE(S)
- POWER CABLE ADAPTER(S)

OTHER _____

over



**HEWLETT
PACKARD**

Should one of your HP instruments need repair, the HP service organization is ready to serve you. However, you can help us serve you more effectively. When sending an instrument to HP for repair, please fill out this card and attach it to the product. Increased repair efficiency and reduced turn-around time should result.

COMPANY _____

ADDRESS _____

TECHNICAL CONTACT PERSON _____

PHONE NO. _____ EXT. _____

MODEL NO. _____ SERIAL NO. _____

MODEL NO. _____ SERIAL NO. _____

P.O. NO. _____ DATE _____

Accessories returned with unit

- NONE CABLE(S)
- POWER CABLE ADAPTER(S)

OTHER _____

over



**HEWLETT
PACKARD**

Should one of your HP instruments need repair, the HP service organization is ready to serve you. However, you can help us serve you more effectively. When sending an instrument to HP for repair, please fill out this card and attach it to the product. Increased repair efficiency and reduced turn-around time should result.

COMPANY _____

ADDRESS _____

TECHNICAL CONTACT PERSON _____

PHONE NO. _____ EXT. _____

MODEL NO. _____ SERIAL NO. _____

MODEL NO. _____ SERIAL NO. _____

P.O. NO. _____ DATE _____

Accessories returned with unit

- NONE CABLE(S)
- POWER CABLE ADAPTER(S)

OTHER _____

over



**HEWLETT
PACKARD**

Should one of your HP instruments need repair, the HP service organization is ready to serve you. However, you can help us serve you more effectively. When sending an instrument to HP for repair, please fill out this card and attach it to the product. Increased repair efficiency and reduced turn-around time should result.

COMPANY _____

ADDRESS _____

TECHNICAL CONTACT PERSON _____

PHONE NO. _____ EXT. _____

MODEL NO. _____ SERIAL NO. _____

MODEL NO. _____ SERIAL NO. _____

P.O. NO. _____ DATE _____

Accessories returned with unit

- NONE CABLE(S)
- POWER CABLE ADAPTER(S)

OTHER _____

over

Service needed

- CALIBRATION ONLY
- REPAIR REPAIR & CAL

OTHER _____

Observed symptoms/problems

FAILURE MODE IS:

- CONSTANT INTERMITTENT

SENSITIVE TO:

- COLD HEAT VIBRATION

FAILURE SYMPTOMS/
SPECIAL CONTROL SETTINGS _____

If unit is part of system list model number(s) of
other interconnected instruments. _____

Service needed

- CALIBRATION ONLY
- REPAIR REPAIR & CAL

OTHER _____

Observed symptoms/problems

FAILURE MODE IS:

- CONSTANT INTERMITTENT

SENSITIVE TO:

- COLD HEAT VIBRATION

FAILURE SYMPTOMS/
SPECIAL CONTROL SETTINGS _____

If unit is part of system list model number(s) of
other interconnected instruments. _____

Service needed

- CALIBRATION ONLY
- REPAIR REPAIR & CAL

OTHER _____

Observed symptoms/problems

FAILURE MODE IS:

- CONSTANT INTERMITTENT

SENSITIVE TO:

- COLD HEAT VIBRATION

FAILURE SYMPTOMS/
SPECIAL CONTROL SETTINGS _____

If unit is part of system list model number(s) of
other interconnected instruments. _____

Service needed

- CALIBRATION ONLY
- REPAIR REPAIR & CAL

OTHER _____

Observed symptoms/problems

FAILURE MODE IS:

- CONSTANT INTERMITTENT

SENSITIVE TO:

- COLD HEAT VIBRATION

FAILURE SYMPTOMS/
SPECIAL CONTROL SETTINGS _____

If unit is part of system list model number(s) of
other interconnected instruments. _____

Service needed

- CALIBRATION ONLY
- REPAIR REPAIR & CAL

OTHER _____

Observed symptoms/problems

FAILURE MODE IS:

- CONSTANT INTERMITTENT

SENSITIVE TO:

- COLD HEAT VIBRATION

FAILURE SYMPTOMS/
SPECIAL CONTROL SETTINGS _____

If unit is part of system list model number(s) of
other interconnected instruments. _____

Service needed

- CALIBRATION ONLY
- REPAIR REPAIR & CAL

OTHER _____

Observed symptoms/problems

FAILURE MODE IS:

- CONSTANT INTERMITTENT

SENSITIVE TO:

- COLD HEAT VIBRATION

FAILURE SYMPTOMS/
SPECIAL CONTROL SETTINGS _____

If unit is part of system list model number(s) of
other interconnected instruments. _____

Legal and Regulatory Information

This chapter contains information pertaining to safety and the warranty. The Declaration of Conformity is located at the end of this chapter.

Safety Symbols



Instruction documentation symbol: The product is marked with this symbol when it is necessary for the user to refer to the instruction in the documentation.



Indicates hazardous voltages.



Indicates earth (ground) terminal.

Warning

The WARNING sign denotes a hazard. It calls attention to a procedure which, if not correctly performed or adhered to, could result in personal injury or loss of life. Do not proceed beyond a WARNING note until the indicated conditions are fully understood and met.

Caution

The CAUTION sign denotes a hazard. It calls attention to a procedure that, if not correctly performed or adhered to, could result in damage to or destruction of part the product. Do not proceed beyond a CAUTION note until the indicated conditions are fully understood and met.

Warning

No operator serviceable parts inside. Refer servicing to qualified personnel.

To prevent electrical shock do not remove covers.

Miscellaneous Symbols

CE The CE symbol is a registered trademark of the European Community (if accompanied by a year, it is when the design was proven).

**ISM
1-A** This is a symbol of an Industrial Scientific and Medical Group 1 Class A product.

CSA The CSA symbol is a registered trademark of the Canadian Standards Association.

Safety Considerations

This product and related documentation must be reviewed for familiarization with safety markings and instructions before operation.

This product is a Safety Class I system (provided with a protective earth terminal).

Before Applying Power

Verify that the product is set to match the available line voltage and the correct fuses are installed.

Caution This product is designed for use in Installation Category II and Pollution Degree 2 per IEC 1010 and 664 respectively.

Caution VENTILATION REQUIREMENTS: When installing the product in a cabinet, the convection into and out of the product must not be restricted. The ambient temperature (outside the cabinet) must be less than the maximum operating temperature of the product by 4°C for every 100 watts dissipated in the cabinet. If the total power dissipated in the cabinet is greater than 800 watts, then forced convection must be used.

Safety Earth Ground

An uninterruptable safety earth ground must be provided from the main power source to the product input wiring terminals through the power cable or supplied power cable set.

Warning

This is a Safety Class I product provided with a protective earthing ground incorporated in the power cord. The mains plug shall only be inserted in a socket outlet provided with a protective earth contact. Any interruption of the protective conductor inside or outside of the product is likely to make the product dangerous. Intentional interruption is prohibited.

Whenever it is likely that the protection has been impaired, the system must be made inoperative and be secured against any unintended operation.

Servicing instructions are for use by service-trained personnel only. To avoid dangerous electric shock, do not perform any servicing unless qualified to do so.

Adjustments described in the manual are performed with power supplied to the system's instruments while protective covers are removed. Energy available at many points may, if contacted, result in personal injury.

Capacitors inside the system's instruments might still be charged even if the system has been disconnected from its source of supply.

For continued protection against fire hazard, replace the line fuses only with 250 V fuses of the same current rating and type (for example, normal blow, time delay, etc.). The use of other fuses or materials is prohibited.

Cleaning the Product

Clean the synthesizer cabinet using a damp cloth only.

Certification

Hewlett-Packard Company certifies that this product met its published specifications at the time of shipment from the factory. Hewlett-Packard further certifies that its calibration measurements are traceable to the United States National Institute of Standards and Technology, (NIST), to the extent allowed by the Institute's calibration facility, and to the calibration facilities of other International Standards Organization members.

Warranty

This Hewlett-Packard instrument product is warranted against defects in material and workmanship for a period of one year from date of shipment. During the warranty period, Hewlett-Packard Company will, at its option, either repair or replace products which prove to be defective.

For warranty service or repair, this product must be returned to a service facility designated by HP. Buyer shall prepay shipping charges to HP and HP shall pay shipping charges to return the product to Buyer. However, Buyer shall pay all shipping charges, duties, and taxes for products returned to HP from another country.

HP warrants that its software and firmware designated by HP for use with an instrument will execute its programming instructions when properly installed on that instrument. HP does not warrant that the operation of the instrument, or software, or firmware will be uninterrupted or error free.

Limitation of Warranty

The foregoing warranty shall not apply to defects resulting from improper or inadequate maintenance by Buyer, Buyer-supplied software or interfacing, unauthorized modification or misuse, operation outside of the environmental specifications for the product, or improper site preparation or maintenance.

NO OTHER WARRANTY IS EXPRESSED OR IMPLIED. HP SPECIFICALLY DISCLAIMS THE IMPLIED WARRANTIES OF MERCHANTABILITY AND FITNESS FOR A PARTICULAR PURPOSE.

Exclusive Remedies

THE REMEDIES PROVIDED HEREIN ARE BUYER'S SOLE AND EXCLUSIVE REMEDIES. HP SHALL NOT BE LIABLE FOR ANY DIRECT, INDIRECT, SPECIAL, INCIDENTAL, OR CONSEQUENTIAL DAMAGES, WHETHER BASED ON CONTRACT, TORT, OR ANY OTHER LEGAL THEORY.

Assistance

Product maintenance agreements and other customer assistance agreements are available for Hewlett-Packard products.

For any assistance, contact your nearest Hewlett-Packard Sales and Service Office shown in Table 8-1.

DECLARATION OF CONFORMITY

according to ISO/IEC Guide 22 and EN 45014

Manufacturer's Name: Hewlett-Packard Co.

Manufacturer's Address: Microwave Instruments Division
1212 Valley House Drive
Rohnert Park, CA 94928
USA

declares that the products

Product Name: Synthesized Generators

Model Number: HP 83711B, HP 83712B, HP 83731B,
HP 83732B

Product Options: This declaration covers all options of the
above product.

conforms to the following Product specifications:

Safety: IEC 1010-1:1990 + Am 1:1992/EN 61010-1:1993
CAN/CSA-C22.2 No. 1010.1-1992

EMC: CISPR 11:1990/EN 55011:1991 Group 1, Class A
IEC 801-2:1984/EN 50082-1:1992 4 kV CD, 8 kV AD
IEC 801-3:1984/EN 50082-1:1992 3 V/m, 27-500 MHz
IEC 801-4:1988/EN 50082-1:1992 0.5 kV Sig. Lines, 1 kV Power Lines

IEC 555-2:1982 + A1:1985 / EN 60555-2:1987
IEC 555-3:1982 + A1:1990 / EN 60555-3:1987 + A1:1991

Supplementary Information:

These products herewith comply with the requirements of the Low Voltage Directive 73/23/EEC and the EMC Directive 89/336/EEC and carry the CE-marking accordingly.

Santa Rosa, California, USA 20 Dec. 1996

John Hiatt/Quality Engineering Manager

European Contact: Your local Hewlett-Packard Sales and Service Office or Hewlett-Packard GmbH, Department ZQ/Standards Europe, Herrenberger Strasse 130, D-71034 Böblingen, Germany (FAX +49-7031-14-3143), 49-7031-14-3143)

Notice for Germany: Noise Declaration
LpA < 70 dB
am Arbeitsplatz (operator position)
normaler Betrieb (normal position)
nach DIN 45635 T. 19 (per ISO 7779)

Index

0

0.01 to 1 GHz calibrations, 7-20
0.5 V/GHz output, 6-8

1

1 Hz frequency resolution - option 1E8, 1-37

3

3.5 mm RF output connector - option 1E9,
1-37

A

add high stability timebase - option 1E5,
1-37

add output step attenuator - option 1E1,
1-37

adjustments, 6-1

AM calibration
0.01 - 1 GHz, 7-27

AM depth, 3-68

AM gain calibration
1 - 20 GHz, 7-16

AM linearity calibration
1 - 20 GHz, 7-14

AM rate, 3-72

attenuator calibration
0.01 - 1 GHz, 7-25
1 - 20 GHz, 7-11

C

calibration cycle, 3-1

cover removal, 7-2

D

declaration of conformity, 9-7

DIP switch, A3S1, settings, 7-3

DIP switch settings, 6-3

display E, 3-3

E

earth ground

for safety, 9-4

electrical options, 1-37

equipment, 3-1

equipment required, 2-1

ERR LED, 3-3

error indicator, 3-58, 3-76

external ALC, 3-8

external leveling, 3-8

F

flatness, 3-17

FM, 3-59

ϕ M, 3-64

flatness and low level accuracy, 3-18

FM deviation, 3-55

FM rate and flatness, 3-59

FM sensitivity, 6-9

FM source verification, 3-74

frequency calibration 1

0.01 - 1 GHz, 7-23

1 - 20 GHz, 7-9

frequency calibration 2

0.01 - 1 GHz, 7-24

1 - 20 GHz, 7-10

frequency range and resolution, 3-6

H

hardware

system requirements for, 7-4

harmonics, 3-29

high stability timebase, 6-6

I

if the procedure fails

fm deviation, 3-58

internal FM source verification, 3-76

if the procedure fails frequency range and
resolution, 3-7

if the procedure fails maximum leveled
power, 3-14

if the procedure fails vernier level accuracy
and flatness, 3-17

internal AM and FM/ ϕ M sources - option
1E2, 1-37

internal AM/FM source calibration, 7-33

internal FM source verification, 3-74

internal linear AM source calibration, 7-34

internal log AM rate, 3-72

internal timebase aging rate, 3-4

in this guide, iv

L

- legal and regulatory information, 9-1
- leveling power meter, 3-8
- linear AM calibration
 - 0.01 - 1 GHz, 7-29
- linear AM depth, 3-70
- linear AM gain calibration
 - 1 - 20 GHz, 7-18
- linear AM offset, 6-15
- log AM depth, 3-68
- low band (0.01 to 1 GHz) calibrations, 7-20
- low level accuracy and flatness, 3-18
- low stability timebase, 6-7

M

- maintenance and service, 8-1
- manual
 - print date, i
- maximum FM deviation, 3-55
- maximum leveled power, 3-10
- minimum lin AM depth, 3-70
- minimum log AM depth, 3-68

N

- non-harmonic spurious signals >30 kHz, 3-44

O

- operating system
 - system requirements for, 7-4
- operation verification, 5-1
- option 1E1 - add output step attenuator, 1-37
- option 1E2 - internal AM and FM/ ϕ M sources, 1-37
- option 1E5 - add high stability timebase, 1-37
- option 1E8 - 1 Hz frequency resolution, 1-37
- option 1E9 - 3.5 mm RF output connector, 1-37
- option 800 - phase modulation, 1-37
- options
 - electrical, 1-37

P

- performance test record, 4-1
- performance test records, 3-1
- performance tests, 3-1
- phase cross-over, 6-13
- phase modulation - option 800, 1-37

- ϕ M flatness, 3-64
- ϕ M sensitivity, 6-11
- power meter leveling, 3-8
- pulse calibration
 - 0.01 - 1 GHz, 7-31
- pulse fall time, 3-49
- pulse on/off ratio, 3-47
- pulse rise time, 3-49
- pulse width, 3-52

R

- R162, 6-7
- rate
 - FM, 3-59, 3-64
- running the software, 7-5

S

- sales and service office table, 8-3
- self test, 3-3
 - running, 5-1
- service software, 7-1
- single-sideband phase noise, 3-32
- software, 7-4
 - running the, 7-5
- specifications, 1-1
- supplemental characteristics, 1-2, 1-7, 1-12, 1-21
- system requirements
 - automated adjustments, 7-4
- system setup
 - automated adjustments, 7-4

T

- test equipment
 - required, 2-1, 3-1
- test setups, 3-1

U

- USER_FILE, 7-5

V

- verification procedure, 5-1
- vernier calibration
 - 0.01 - 1 GHz, 7-21
 - 1 - 20 GHz, 7-7
- vernier level accuracy and flatness, 3-15

Y

- YIG calibration, 6-4